



Nouvelles références disponibles

par applications

03/2018

www.ate.de





description

Références OE
par référence
ATE.

i
Références remplacées /
divers

AUDI

A4 (B6/B7) (01-08)	1,6	ArD	12.2000		24.3384-1736.5	240823	ETRIER A GRIFFE	8E0 615 424 G , 8E0 615 424 B	24.3384-1736.7
	1,8 T	ArD	07.2001		24.3384-1736.5	240823	ETRIER A GRIFFE	8E0 615 424 G , 8E0 615 424 B	24.3384-1736.7
		ArD	07.2002		24.3384-1736.5	240823	ETRIER A GRIFFE	8E0 615 424 G , 8E0 615 424 B	24.3384-1736.7
		ArD	11.2002		24.3384-1736.5	240823	ETRIER A GRIFFE	8E0 615 424 G , 8E0 615 424 B	24.3384-1736.7
		ArD	12.2000		24.3384-1736.5	240823	ETRIER A GRIFFE	8E0 615 424 G , 8E0 615 424 B	24.3384-1736.7
	1,8 T quattro	ArD	07.2001		24.3384-1736.5	240823	ETRIER A GRIFFE	8E0 615 424 G , 8E0 615 424 B	24.3384-1736.7
		ArD	07.2002		24.3384-1736.5	240823	ETRIER A GRIFFE	8E0 615 424 G , 8E0 615 424 B	24.3384-1736.7
		ArD	11.2002		24.3384-1736.5	240823	ETRIER A GRIFFE	8E0 615 424 G , 8E0 615 424 B	24.3384-1736.7
		ArD	12.2000		24.3384-1736.5	240823	ETRIER A GRIFFE	8E0 615 424 G , 8E0 615 424 B	24.3384-1736.7
	1,9 TDI	ArD	12.2000		24.3384-1736.5	240823	ETRIER A GRIFFE	8E0 615 424 G , 8E0 615 424 B	24.3384-1736.7
		ArD	04.2001		24.3384-1736.5	240823	ETRIER A GRIFFE	8E0 615 424 G , 8E0 615 424 B	24.3384-1736.7
		ArD	06.2004		24.3384-1736.5	240823	ETRIER A GRIFFE	8E0 615 424 G , 8E0 615 424 B	24.3384-1736.7
	1,9 TDI quattro	ArD	12.2000		24.3384-1736.5	240823	ETRIER A GRIFFE	8E0 615 424 G , 8E0 615 424 B	24.3384-1736.7
	2	ArD	12.2000		24.3384-1736.5	240823	ETRIER A GRIFFE	8E0 615 424 G , 8E0 615 424 B	24.3384-1736.7



description

Références OE
par référence
ATE.

i
Références remplacées /
divers

AUDI

A4 (B6/B7) (01-08)	2,0 FSI	ArD	07.2002		24.3384-1736.5	240823	ETRIER A GRIFFE	8E0 615 424 G , 8E0 615 424 B	24.3384-1736.7
	2,0 TDI	ArD	06.2006		24.3384-1736.5	240823	ETRIER A GRIFFE	8E0 615 424 G , 8E0 615 424 B	24.3384-1736.7
		ArD	11.2004		24.3384-1736.5	240823	ETRIER A GRIFFE	8E0 615 424 G , 8E0 615 424 B	24.3384-1736.7
	2,0 TDI quattro	ArD	01.2006		24.3384-1736.5	240823	ETRIER A GRIFFE	8E0 615 424 G , 8E0 615 424 B	24.3384-1736.7
		ArD	06.2006		24.3384-1736.5	240823	ETRIER A GRIFFE	8E0 615 424 G , 8E0 615 424 B	24.3384-1736.7
	2,0 TFSI	ArD	06.2005		24.3384-1736.5	240823	ETRIER A GRIFFE	8E0 615 424 G , 8E0 615 424 B	24.3384-1736.7
		ArD	11.2004		24.3384-1736.5	240823	ETRIER A GRIFFE	8E0 615 424 G , 8E0 615 424 B	24.3384-1736.7
	2,0 TFSI quattro	ArD	06.2005		24.3384-1736.5	240823	ETRIER A GRIFFE	8E0 615 424 G , 8E0 615 424 B	24.3384-1736.7
		ArD	11.2004		24.3384-1736.5	240823	ETRIER A GRIFFE	8E0 615 424 G , 8E0 615 424 B	24.3384-1736.7
	2,4	ArD	09.2001		24.3384-1736.5	240823	ETRIER A GRIFFE	8E0 615 424 G , 8E0 615 424 B	24.3384-1736.7
	2,5 TDI	ArD	12.2000		24.3384-1736.5	240823	ETRIER A GRIFFE	8E0 615 424 G , 8E0 615 424 B	24.3384-1736.7
	2,5 TDI quattro	ArD	12.2000		24.3384-1736.5	240823	ETRIER A GRIFFE	8E0 615 424 G , 8E0 615 424 B	24.3384-1736.7
	2,7 TDI	ArD	01.2006		24.3384-1736.5	240823	ETRIER A GRIFFE	8E0 615 424 G , 8E0 615 424 B	24.3384-1736.7
		ArD	11.2005		24.3384-1736.5	240823	ETRIER A GRIFFE	8E0 615 424 G , 8E0 615 424 B	24.3384-1736.7



description

Références OE
par référence
ATE.



Références remplacées /
divers

AUDI

A4 (B6/B7) (01-08)	3	ArD	12.2000		24.3384-1736.5	240823	ETRIER A GRIFFE	8E0 615 424 G , 8E0 615 424 B	24.3384-1736.7
	3,0 quattro	ArD	12.2000		24.3384-1736.5	240823	ETRIER A GRIFFE	8E0 615 424 G , 8E0 615 424 B	24.3384-1736.7
	3,0 TDI quattro	ArD	01.2006		24.3384-1736.5	240823	ETRIER A GRIFFE	8E0 615 424 G , 8E0 615 424 B	24.3384-1736.7
		ArD	11.2004		24.3384-1736.5	240823	ETRIER A GRIFFE	8E0 615 424 G , 8E0 615 424 B	24.3384-1736.7
	3,2 FSI	ArD	01.2005		24.3384-1736.5	240823	ETRIER A GRIFFE	8E0 615 424 G , 8E0 615 424 B	24.3384-1736.7
	3,2 FSI quattro	ArD	01.2005		24.3384-1736.5	240823	ETRIER A GRIFFE	8E0 615 424 G , 8E0 615 424 B	24.3384-1736.7
A4 Décapotable (02-08)	1,8 T	ArD	04.2002	11.2008	24.3384-1736.5	240823	ETRIER A GRIFFE	8E0 615 424 G , 8E0 615 424 B	24.3384-1736.7
	1,8 T quattro	ArD	05.2003	11.2008	24.3384-1736.5	240823	ETRIER A GRIFFE	8E0 615 424 G , 8E0 615 424 B	24.3384-1736.7
	2	ArD	05.2004	11.2008	24.3384-1736.5	240823	ETRIER A GRIFFE	8E0 615 424 G , 8E0 615 424 B	24.3384-1736.7
	2,0 TDI	ArD	10.2005	11.2008	24.3384-1736.5	240823	ETRIER A GRIFFE	8E0 615 424 G , 8E0 615 424 B	24.3384-1736.7
	2,0 TFSI	ArD	01.2006	11.2008	24.3384-1736.5	240823	ETRIER A GRIFFE	8E0 615 424 G , 8E0 615 424 B	24.3384-1736.7
	2,0 TFSI quattro	ArD	11.2005	11.2008	24.3384-1736.5	240823	ETRIER A GRIFFE	8E0 615 424 G , 8E0 615 424 B	24.3384-1736.7
	2,4	ArD	04.2002	12.2005	24.3384-1736.5	240823	ETRIER A GRIFFE	8E0 615 424 G , 8E0 615 424 B	24.3384-1736.7
	2,5 TDI	ArD	08.2002	12.2005	24.3384-1736.5	240823	ETRIER A GRIFFE	8E0 615 424 G , 8E0 615 424 B	24.3384-1736.7



description

Références OE
par référence
ATE.



Références remplacées /
divers

AUDI

A4 Décapotable (02-08)	3	ArD	04.2002	12.2005	24.3384-1736.5	240823	ETRIER A GRIFFE	8E0 615 424 G , 8E0 615 424 B	24.3384-1736.7
	3,0 quattro	ArD	05.2003	12.2005	24.3384-1736.5	240823	ETRIER A GRIFFE	8E0 615 424 G , 8E0 615 424 B	24.3384-1736.7
A6 (4G2/C7) Limousine (11-)	1,8 TFSI	AvD	09.2014		24.3606-1714.5	240893	ETRIER A GRIFFE	4G0 615 124 D , 4G0 615 124 A	
		AvG	09.2014		24.3606-1713.5	240892	ETRIER A GRIFFE	4G0 615 123 D , 4G0 615 123 A	
	2,0 TDI	AvD	04.2011		24.3606-1714.5	240893	ETRIER A GRIFFE	4G0 615 124 D , 4G0 615 124 A	
		AvD	09.2014		24.3606-1714.5	240893	ETRIER A GRIFFE	4G0 615 124 D , 4G0 615 124 A	
		AvD	01.2012		24.3606-1714.5	240893	ETRIER A GRIFFE	4G0 615 124 D , 4G0 615 124 A	
		AvG	01.2012		24.3606-1713.5	240892	ETRIER A GRIFFE	4G0 615 123 D , 4G0 615 123 A	
		AvG	04.2011		24.3606-1713.5	240892	ETRIER A GRIFFE	4G0 615 123 D , 4G0 615 123 A	
		AvG	09.2014		24.3606-1713.5	240892	ETRIER A GRIFFE	4G0 615 123 D , 4G0 615 123 A	
	2,0 TDI quattro	AvG	04.2015		24.3606-1713.5	240892	ETRIER A GRIFFE	4G0 615 123 D , 4G0 615 123 A	
		AvD	04.2015		24.3606-1714.5	240893	ETRIER A GRIFFE	4G0 615 124 D , 4G0 615 124 A	
	2,0 TDI ultra	AvD	11.2013		24.3606-1714.5	240893	ETRIER A GRIFFE	4G0 615 124 D , 4G0 615 124 A	
		AvG	11.2013		24.3606-1713.5	240892	ETRIER A GRIFFE	4G0 615 123 D , 4G0 615 123 A	



description

Références OE
par référence
ATE.

i
Références remplacées /
divers

AUDI

A6 (4G2/C7) Limousine (11-)	2,0 TFSI	AvG	09.2014		24.3606-1713.5	240892	ETRIER A GRIFFE	4G0 615 123 D , 4G0 615 123 A	
		AvD	04.2011		24.3606-1714.5	240893	ETRIER A GRIFFE	4G0 615 124 D , 4G0 615 124 A	
		AvG	04.2011		24.3606-1713.5	240892	ETRIER A GRIFFE	4G0 615 123 D , 4G0 615 123 A	
		AvG	05.2013		24.3606-1713.5	240892	ETRIER A GRIFFE	4G0 615 123 D , 4G0 615 123 A	
		AvD	09.2014		24.3606-1714.5	240893	ETRIER A GRIFFE	4G0 615 124 D , 4G0 615 124 A	
		AvD	05.2013		24.3606-1714.5	240893	ETRIER A GRIFFE	4G0 615 124 D , 4G0 615 124 A	
	2,0 TFSI hybrid	AvD	11.2011		24.3606-1714.5	240893	ETRIER A GRIFFE	4G0 615 124 D , 4G0 615 124 A	
		AvG	11.2011		24.3606-1713.5	240892	ETRIER A GRIFFE	4G0 615 123 D , 4G0 615 123 A	
	2,0 TFSI quattro	AvD	05.2013		24.3606-1714.5	240893	ETRIER A GRIFFE	4G0 615 124 D , 4G0 615 124 A	
		AvD	05.2014		24.3606-1714.5	240893	ETRIER A GRIFFE	4G0 615 124 D , 4G0 615 124 A	
		AvD	05.2012		24.3606-1714.5	240893	ETRIER A GRIFFE	4G0 615 124 D , 4G0 615 124 A	
		AvG	05.2012		24.3606-1713.5	240892	ETRIER A GRIFFE	4G0 615 123 D , 4G0 615 123 A	
		AvG	05.2013		24.3606-1713.5	240892	ETRIER A GRIFFE	4G0 615 123 D , 4G0 615 123 A	
		AvG	05.2014		24.3606-1713.5	240892	ETRIER A GRIFFE	4G0 615 123 D , 4G0 615 123 A	



description

Références OE
par référence
ATE.



Références remplacées /
divers

AUDI

A6 (4G2/C7) Limousine (11-)	2,8 FSI	AvG	04.2011		24.3606-1713.5	240892	ETRIER A GRIFFE	4G0 615 123 D , 4G0 615 123 A	
		AvD	04.2011		24.3606-1714.5	240893	ETRIER A GRIFFE	4G0 615 124 D , 4G0 615 124 A	
	2,8 FSI quattro	AvG	04.2011		24.3606-1713.5	240892	ETRIER A GRIFFE	4G0 615 123 D , 4G0 615 123 A	
		AvD	04.2011		24.3606-1714.5	240893	ETRIER A GRIFFE	4G0 615 124 D , 4G0 615 124 A	
		AvD	09.2014		24.3606-1714.5	240893	ETRIER A GRIFFE	4G0 615 124 D , 4G0 615 124 A	
		AvG	09.2014		24.3606-1713.5	240892	ETRIER A GRIFFE	4G0 615 123 D , 4G0 615 123 A	
	3,0 TDI	AvG	09.2014		24.3606-1713.5	240892	ETRIER A GRIFFE	4G0 615 123 D , 4G0 615 123 A	
		AvG	04.2011		24.3606-1713.5	240892	ETRIER A GRIFFE	4G0 615 123 D , 4G0 615 123 A	
		AvD	04.2011		24.3606-1714.5	240893	ETRIER A GRIFFE	4G0 615 124 D , 4G0 615 124 A	
		AvD	09.2014		24.3606-1714.5	240893	ETRIER A GRIFFE	4G0 615 124 D , 4G0 615 124 A	
	3,0 TDI quattro	AvD	12.2011		24.3606-1714.5	240893	ETRIER A GRIFFE	4G0 615 124 D , 4G0 615 124 A	
		AvD	04.2011		24.3606-1714.5	240893	ETRIER A GRIFFE	4G0 615 124 D , 4G0 615 124 A	
		AvD	05.2013		24.3606-1714.5	240893	ETRIER A GRIFFE	4G0 615 124 D , 4G0 615 124 A	
		AvD	09.2014		24.3606-1714.5	240893	ETRIER A GRIFFE	4G0 615 124 D , 4G0 615 124 A	



description

Références OE
par référence
ATE.

i
Références remplacées /
divers

AUDI

A6 (4G2/C7) Limousine (11-)	3,0 TDI quattro	AvG	04.2011		24.3606-1713.5	240892	ETRIER A GRIFFE	4G0 615 123 D , 4G0 615 123 A	
		AvG	05.2013		24.3606-1713.5	240892	ETRIER A GRIFFE	4G0 615 123 D , 4G0 615 123 A	
		AvG	09.2014		24.3606-1713.5	240892	ETRIER A GRIFFE	4G0 615 123 D , 4G0 615 123 A	
		AvG	12.2011		24.3606-1713.5	240892	ETRIER A GRIFFE	4G0 615 123 D , 4G0 615 123 A	
	3,0 TFSI quattro	AvG	09.2014		24.3606-1713.5	240892	ETRIER A GRIFFE	4G0 615 123 D , 4G0 615 123 A	
		AvD	09.2014		24.3606-1714.5	240893	ETRIER A GRIFFE	4G0 615 124 D , 4G0 615 124 A	
		AvG	04.2011		24.3606-1713.5	240892	ETRIER A GRIFFE	4G0 615 123 D , 4G0 615 123 A	
		AvD	04.2011		24.3606-1714.5	240893	ETRIER A GRIFFE	4G0 615 124 D , 4G0 615 124 A	
	S6	AvD	10.2014		24.3606-1714.5	240893	ETRIER A GRIFFE	4G0 615 124 D , 4G0 615 124 A	
		AvG	10.2014		24.3606-1713.5	240892	ETRIER A GRIFFE	4G0 615 123 D , 4G0 615 123 A	
		AvG	04.2012		24.3606-1713.5	240892	ETRIER A GRIFFE	4G0 615 123 D , 4G0 615 123 A	
		AvD	04.2012		24.3606-1714.5	240893	ETRIER A GRIFFE	4G0 615 124 D , 4G0 615 124 A	
A6 (4G5/C7) Avant (11-)	1,8 TFSI	AvD	09.2014		24.3606-1714.5	240893	ETRIER A GRIFFE	4G0 615 124 D , 4G0 615 124 A	
		AvG	09.2014		24.3606-1713.5	240892	ETRIER A GRIFFE	4G0 615 123 D , 4G0 615 123 A	



description

Références OE
par référence
ATE.



Références remplacées /
divers

AUDI

A6 (4G5/C7) Avant (11-)	2,0 TDI	AvD	01.2012		24.3606-1714.5	240893	ETRIER A GRIFFE	4G0 615 124 D , 4G0 615 124 A	
		AvD	09.2011		24.3606-1714.5	240893	ETRIER A GRIFFE	4G0 615 124 D , 4G0 615 124 A	
		AvG	09.2014		24.3606-1713.5	240892	ETRIER A GRIFFE	4G0 615 123 D , 4G0 615 123 A	
		AvG	01.2012		24.3606-1713.5	240892	ETRIER A GRIFFE	4G0 615 123 D , 4G0 615 123 A	
		AvD	09.2014		24.3606-1714.5	240893	ETRIER A GRIFFE	4G0 615 124 D , 4G0 615 124 A	
		AvG	09.2011		24.3606-1713.5	240892	ETRIER A GRIFFE	4G0 615 123 D , 4G0 615 123 A	
	2,0 TDI quattro	AvG	04.2015		24.3606-1713.5	240892	ETRIER A GRIFFE	4G0 615 123 D , 4G0 615 123 A	
		AvD	04.2015		24.3606-1714.5	240893	ETRIER A GRIFFE	4G0 615 124 D , 4G0 615 124 A	
	2,0 TDI ultra	AvD	11.2013		24.3606-1714.5	240893	ETRIER A GRIFFE	4G0 615 124 D , 4G0 615 124 A	
		AvG	11.2013		24.3606-1713.5	240892	ETRIER A GRIFFE	4G0 615 123 D , 4G0 615 123 A	
	2,0 TFSI	AvD	06.2011		24.3606-1714.5	240893	ETRIER A GRIFFE	4G0 615 124 D , 4G0 615 124 A	
		AvD	09.2014		24.3606-1714.5	240893	ETRIER A GRIFFE	4G0 615 124 D , 4G0 615 124 A	
		AvG	09.2014		24.3606-1713.5	240892	ETRIER A GRIFFE	4G0 615 123 D , 4G0 615 123 A	
		AvG	06.2011		24.3606-1713.5	240892	ETRIER A GRIFFE	4G0 615 123 D , 4G0 615 123 A	



description

Références OE
par référence
ATE.

i
Références remplacées /
divers

AUDI

A6 (4G5/C7) Avant (11-)	2,0 TFSI quattro	AvD	05.2015		24.3606-1714.5	240893	ETRIER A GRIFFE	4G0 615 124 D , 4G0 615 124 A	
		AvG	05.2015		24.3606-1713.5	240892	ETRIER A GRIFFE	4G0 615 123 D , 4G0 615 123 A	
	2,8 FSI	AvD	09.2011		24.3606-1714.5	240893	ETRIER A GRIFFE	4G0 615 124 D , 4G0 615 124 A	
		AvG	09.2011		24.3606-1713.5	240892	ETRIER A GRIFFE	4G0 615 123 D , 4G0 615 123 A	
	2,8 FSI quattro	AvD	09.2014		24.3606-1714.5	240893	ETRIER A GRIFFE	4G0 615 124 D , 4G0 615 124 A	
		AvG	09.2011		24.3606-1713.5	240892	ETRIER A GRIFFE	4G0 615 123 D , 4G0 615 123 A	
		AvG	09.2014		24.3606-1713.5	240892	ETRIER A GRIFFE	4G0 615 123 D , 4G0 615 123 A	
		AvD	09.2011		24.3606-1714.5	240893	ETRIER A GRIFFE	4G0 615 124 D , 4G0 615 124 A	
	3,0 TDI	AvD	09.2011		24.3606-1714.5	240893	ETRIER A GRIFFE	4G0 615 124 D , 4G0 615 124 A	
		AvD	09.2014		24.3606-1714.5	240893	ETRIER A GRIFFE	4G0 615 124 D , 4G0 615 124 A	
		AvG	09.2011		24.3606-1713.5	240892	ETRIER A GRIFFE	4G0 615 123 D , 4G0 615 123 A	
		AvG	09.2014		24.3606-1713.5	240892	ETRIER A GRIFFE	4G0 615 123 D , 4G0 615 123 A	
	3,0 TDI quattro	AvD	09.2011		24.3606-1714.5	240893	ETRIER A GRIFFE	4G0 615 124 D , 4G0 615 124 A	
		AvD	09.2014		24.3606-1714.5	240893	ETRIER A GRIFFE	4G0 615 124 D , 4G0 615 124 A	



description

Références OE
par référence
ATE.

i
Références remplacées /
divers

AUDI

A6 (4G5/C7) Avant (11-)	3,0 TDI quattro	AvD	12.2011		24.3606-1714.5	240893	ETRIER A GRIFFE	4G0 615 124 D , 4G0 615 124 A	
		AvG	09.2011		24.3606-1713.5	240892	ETRIER A GRIFFE	4G0 615 123 D , 4G0 615 123 A	
		AvG	09.2014		24.3606-1713.5	240892	ETRIER A GRIFFE	4G0 615 123 D , 4G0 615 123 A	
		AvG	12.2011		24.3606-1713.5	240892	ETRIER A GRIFFE	4G0 615 123 D , 4G0 615 123 A	
	3,0 TFSI quattro	AvG	09.2014		24.3606-1713.5	240892	ETRIER A GRIFFE	4G0 615 123 D , 4G0 615 123 A	
		AvG	09.2011		24.3606-1713.5	240892	ETRIER A GRIFFE	4G0 615 123 D , 4G0 615 123 A	
		AvD	09.2014		24.3606-1714.5	240893	ETRIER A GRIFFE	4G0 615 124 D , 4G0 615 124 A	
		AvD	09.2011		24.3606-1714.5	240893	ETRIER A GRIFFE	4G0 615 124 D , 4G0 615 124 A	
	S6	AvG	09.2014		24.3606-1713.5	240892	ETRIER A GRIFFE	4G0 615 123 D , 4G0 615 123 A	
		AvD	04.2012		24.3606-1714.5	240893	ETRIER A GRIFFE	4G0 615 124 D , 4G0 615 124 A	
		AvD	09.2014		24.3606-1714.5	240893	ETRIER A GRIFFE	4G0 615 124 D , 4G0 615 124 A	
		AvG	04.2012		24.3606-1713.5	240892	ETRIER A GRIFFE	4G0 615 123 D , 4G0 615 123 A	
A6 Allroad (12-)	3,0 TDI quattro	AvG	09.2014		24.3606-1713.5	240892	ETRIER A GRIFFE	4G0 615 123 D , 4G0 615 123 A	
		AvG	11.2015		24.3606-1713.5	240892	ETRIER A GRIFFE	4G0 615 123 D , 4G0 615 123 A	



description

Références OE
par référence
ATE.



Références remplacées /
divers

AUDI

A6 Allroad (12-)	3,0 TDI quattro	AvD	01.2012		24.3606-1714.5	240893	ETRIER A GRIFFE	4G0 615 124 D , 4G0 615 124 A	
		AvD	09.2014		24.3606-1714.5	240893	ETRIER A GRIFFE	4G0 615 124 D , 4G0 615 124 A	
		AvD	11.2015		24.3606-1714.5	240893	ETRIER A GRIFFE	4G0 615 124 D , 4G0 615 124 A	
		AvG	01.2012		24.3606-1713.5	240892	ETRIER A GRIFFE	4G0 615 123 D , 4G0 615 123 A	
	3,0 TFSI quattro	AvG	01.2012		24.3606-1713.5	240892	ETRIER A GRIFFE	4G0 615 123 D , 4G0 615 123 A	
		AvG	09.2014		24.3606-1713.5	240892	ETRIER A GRIFFE	4G0 615 123 D , 4G0 615 123 A	
		AvD	01.2012		24.3606-1714.5	240893	ETRIER A GRIFFE	4G0 615 124 D , 4G0 615 124 A	
		AvD	09.2014		24.3606-1714.5	240893	ETRIER A GRIFFE	4G0 615 124 D , 4G0 615 124 A	
A7 Sportback (10-)	1,8 TFSI	AvD	04.2015		24.3606-1714.5	240893	ETRIER A GRIFFE	4G0 615 124 D , 4G0 615 124 A	
		AvG	04.2015		24.3606-1713.5	240892	ETRIER A GRIFFE	4G0 615 123 D , 4G0 615 123 A	
	2,0 TFSI	AvD	09.2014		24.3606-1714.5	240893	ETRIER A GRIFFE	4G0 615 124 D , 4G0 615 124 A	
		AvG	09.2014		24.3606-1713.5	240892	ETRIER A GRIFFE	4G0 615 123 D , 4G0 615 123 A	
	2,0 TFSI quattro	AvD	05.2015		24.3606-1714.5	240893	ETRIER A GRIFFE	4G0 615 124 D , 4G0 615 124 A	
		AvG	05.2015		24.3606-1713.5	240892	ETRIER A GRIFFE	4G0 615 123 D , 4G0 615 123 A	



description

Références OE
par référence
ATE.



Références remplacées /
divers

AUDI

A7 Sportback (10-)	2,8 FSI	AvG	05.2011		24.3606-1713.5	240892	ETRIER A GRIFFE	4G0 615 123 D , 4G0 615 123 A	
		AvD	05.2011		24.3606-1714.5	240893	ETRIER A GRIFFE	4G0 615 124 D , 4G0 615 124 A	
	2,8 FSI quattro	AvD	07.2010		24.3606-1714.5	240893	ETRIER A GRIFFE	4G0 615 124 D , 4G0 615 124 A	
		AvD	09.2014		24.3606-1714.5	240893	ETRIER A GRIFFE	4G0 615 124 D , 4G0 615 124 A	
		AvG	07.2010		24.3606-1713.5	240892	ETRIER A GRIFFE	4G0 615 123 D , 4G0 615 123 A	
		AvG	09.2014		24.3606-1713.5	240892	ETRIER A GRIFFE	4G0 615 123 D , 4G0 615 123 A	
	3,0 TDI	AvD	11.2010		24.3606-1714.5	240893	ETRIER A GRIFFE	4G0 615 124 D , 4G0 615 124 A	
		AvD	11.2015		24.3606-1714.5	240893	ETRIER A GRIFFE	4G0 615 124 D , 4G0 615 124 A	
		AvG	11.2010		24.3606-1713.5	240892	ETRIER A GRIFFE	4G0 615 123 D , 4G0 615 123 A	
		AvG	11.2015		24.3606-1713.5	240892	ETRIER A GRIFFE	4G0 615 123 D , 4G0 615 123 A	
	3,0 TDI quattro	AvD	05.2013		24.3606-1714.5	240893	ETRIER A GRIFFE	4G0 615 124 D , 4G0 615 124 A	
		AvD	11.2015		24.3606-1714.5	240893	ETRIER A GRIFFE	4G0 615 124 D , 4G0 615 124 A	
		AvD	11.2011		24.3606-1714.5	240893	ETRIER A GRIFFE	4G0 615 124 D , 4G0 615 124 A	
		AvD	08.2014		24.3606-1714.5	240893	ETRIER A GRIFFE	4G0 615 124 D , 4G0 615 124 A	



description

Références OE
par référence
ATE.



Références remplacées /
divers

AUDI

A7 Sportback (10-)	3,0 TDI quattro	AvD	05.2014		24.3606-1714.5	240893	ETRIER A GRIFFE	4G0 615 124 D , 4G0 615 124 A	
		AvD	07.2010		24.3606-1714.5	240893	ETRIER A GRIFFE	4G0 615 124 D , 4G0 615 124 A	
		AvG	11.2015		24.3606-1713.5	240892	ETRIER A GRIFFE	4G0 615 123 D , 4G0 615 123 A	
		AvG	05.2013		24.3606-1713.5	240892	ETRIER A GRIFFE	4G0 615 123 D , 4G0 615 123 A	
		AvG	05.2014		24.3606-1713.5	240892	ETRIER A GRIFFE	4G0 615 123 D , 4G0 615 123 A	
		AvG	11.2011		24.3606-1713.5	240892	ETRIER A GRIFFE	4G0 615 123 D , 4G0 615 123 A	
		AvG	07.2010		24.3606-1713.5	240892	ETRIER A GRIFFE	4G0 615 123 D , 4G0 615 123 A	
		AvG	08.2014		24.3606-1713.5	240892	ETRIER A GRIFFE	4G0 615 123 D , 4G0 615 123 A	
	3,0 TDI ultra	AvG	05.2014		24.3606-1713.5	240892	ETRIER A GRIFFE	4G0 615 123 D , 4G0 615 123 A	
		AvD	05.2014		24.3606-1714.5	240893	ETRIER A GRIFFE	4G0 615 124 D , 4G0 615 124 A	
	3,0 TFSI quattro	AvG	07.2010		24.3606-1713.5	240892	ETRIER A GRIFFE	4G0 615 123 D , 4G0 615 123 A	
		AvD	05.2014		24.3606-1714.5	240893	ETRIER A GRIFFE	4G0 615 124 D , 4G0 615 124 A	
		AvD	07.2010		24.3606-1714.5	240893	ETRIER A GRIFFE	4G0 615 124 D , 4G0 615 124 A	
		AvG	05.2014		24.3606-1713.5	240892	ETRIER A GRIFFE	4G0 615 123 D , 4G0 615 123 A	



description

Références OE
par référence
ATE.

i
Références remplacées /
divers

AUDI

A7 Sportback (10-)	S7	AvD	10.2011		24.3606-1714.5	240893	ETRIER A GRIFFE	4G0 615 124 D , 4G0 615 124 A	
		AvG	10.2011		24.3606-1713.5	240892	ETRIER A GRIFFE	4G0 615 123 D , 4G0 615 123 A	
		AvG	05.2014		24.3606-1713.5	240892	ETRIER A GRIFFE	4G0 615 123 D , 4G0 615 123 A	
		AvD	05.2014		24.3606-1714.5	240893	ETRIER A GRIFFE	4G0 615 124 D , 4G0 615 124 A	

CHEVROLET

SPARK (10-)	1		04.2012		03.0520-9820.3	690108	ATE TOPKIT		
	1,0 16V		04.2012		03.0520-9820.3	690108	ATE TOPKIT		
	1,2 16V		04.2012		03.0520-9820.3	690108	ATE TOPKIT		
	1,2 LPG		04.2012		03.0520-9820.3	690108	ATE TOPKIT		

CITROEN

C4 II Limousine (B7) (10-)	1,2 THP 110		02.2015		13.0460-2603.2	602603	PLAQUETTES DE FREIN	4254 A9	cf. Photo
	1,4 VTi 95		11.2009		13.0460-2603.2	602603	PLAQUETTES DE FREIN	4254 A9	cf. Photo
	1,6 HDi 90		11.2009		13.0460-2603.2	602603	PLAQUETTES DE FREIN	4254 A9	cf. Photo



description

Références OE
par référence
ATE.



Références remplacées /
divers

FORD

B-MAX (12-)	1,0 EcoBoost		02.2016		24.3727-0679.2	580679	BRAKE CABLE	AP31-2853-AB , 1751871	
			10.2012	05.2013	24.3727-0679.2	580679	BRAKE CABLE	AP31-2853-AB , 1751871	
			06.2013		24.3727-0679.2	580679	BRAKE CABLE	AP31-2853-AB , 1751871	
	1,4 Duratec		06.2013		24.3727-0679.2	580679	BRAKE CABLE	AP31-2853-AB , 1751871	
			10.2012	05.2013	24.3727-0679.2	580679	BRAKE CABLE	AP31-2853-AB , 1751871	
	1,4 LPG		08.2013		24.3727-0679.2	580679	BRAKE CABLE	AP31-2853-AB , 1751871	
	1,5 TDCi		04.2015		24.3727-0679.2	580679	BRAKE CABLE	AP31-2853-AB , 1751871	
			06.2013		24.3727-0679.2	580679	BRAKE CABLE	AP31-2853-AB , 1751871	
			10.2012	05.2013	24.3727-0679.2	580679	BRAKE CABLE	AP31-2853-AB , 1751871	
	1,6 TDCi		10.2012	05.2013	24.3727-0679.2	580679	BRAKE CABLE	AP31-2853-AB , 1751871	
			06.2013		24.3727-0679.2	580679	BRAKE CABLE	AP31-2853-AB , 1751871	
	1,6 Ti-VCT		06.2013		24.3727-0679.2	580679	BRAKE CABLE	AP31-2853-AB , 1751871	
			10.2012	05.2013	24.3727-0679.2	580679	BRAKE CABLE	AP31-2853-AB , 1751871	
FIESTA VI (08-)	1		06.2013		24.3727-0679.2	580679	BRAKE CABLE	AP31-2853-AB , 1751871	
			10.2012	05.2013	24.3727-0679.2	580679	BRAKE CABLE	AP31-2853-AB , 1751871	
	1,0 EcoBoost		06.2013		24.3727-0679.2	580679	BRAKE CABLE	AP31-2853-AB , 1751871	
			10.2012	05.2013	24.3727-0679.2	580679	BRAKE CABLE	AP31-2853-AB , 1751871	
	1,0 Sport EcoBoost		05.2014		24.3727-0679.2	580679	BRAKE CABLE	AP31-2853-AB , 1751871	
	1,5 TDCi		05.2015		24.3727-0679.2	580679	BRAKE CABLE	AP31-2853-AB , 1751871	
			06.2013		24.3727-0679.2	580679	BRAKE CABLE	AP31-2853-AB , 1751871	
			10.2012	05.2013	24.3727-0679.2	580679	BRAKE CABLE	AP31-2853-AB , 1751871	



description

Références OE
par référence
ATE.



Références remplacées /
divers

FORD

FIESTA VI (08-)	1,6 Ti-VCT		06.2013		24.3727-0679.2	580679	BRAKE CABLE	AP31-2853-AB , 1751871	
			10.2012	05.2013	24.3727-0679.2	580679	BRAKE CABLE	AP31-2853-AB , 1751871	
TRANSIT COURIER / TOURNEO COURIER (14-)	1,0 EcoBoost		02.2014		24.3727-0679.2	580679	BRAKE CABLE	AP31-2853-AB , 1751871	
	1,5 TDCi		02.2014		24.3727-0679.2	580679	BRAKE CABLE	AP31-2853-AB , 1751871	
			05.2015		24.3727-0679.2	580679	BRAKE CABLE	AP31-2853-AB , 1751871	
	1,6 TDCi		02.2014		24.3727-0679.2	580679	BRAKE CABLE	AP31-2853-AB , 1751871	



description

Références OE
par référence
ATE.

i
Références remplacées /
divers

HYUNDAI

ACCENT IV (10-)	1,4 16V		11.2010		13.0460-5650.2	605650	PLAQUETTES DE FREIN	58302-D4A65 , 58302-D4A55 , 58302-D7A70 , 58302-D3A70 , 58302-B2A10 , 58302-A4B60 , 58302-A4B10 , 58302-A6A20 , 58302-1WA35 , 58302-B4A30 , 58302-A6A31 , 58302-C8A30 , 58302-A6A30 , 58302-3XA30 , 58302-1RA30 , 58302-2VA50 , 58302-3ZA70	cf. Photo
	1,4 CRDi		11.2010		13.0460-5650.2	605650	PLAQUETTES DE FREIN	58302-D4A65 , 58302-D4A55 , 58302-D7A70 , 58302-D3A70 , 58302-B2A10 , 58302-A4B60 , 58302-A4B10 , 58302-A6A20 , 58302-1WA35 , 58302-B4A30 , 58302-A6A31 , 58302-C8A30 , 58302-A6A30 , 58302-3XA30 , 58302-1RA30 , 58302-2VA50 , 58302-3ZA70	cf. Photo
	1,6 16V		11.2010		13.0460-5650.2	605650	PLAQUETTES DE FREIN	58302-D4A65 , 58302-D4A55 , 58302-D7A70 , 58302-D3A70 , 58302-B2A10 , 58302-A4B60 , 58302-A4B10 , 58302-A6A20 , 58302-1WA35 , 58302-B4A30 , 58302-A6A31 , 58302-C8A30 , 58302-A6A30 , 58302-3XA30 , 58302-1RA30 , 58302-2VA50 , 58302-3ZA70	cf. Photo
	1,6 CCVT-I		11.2010		13.0460-5650.2	605650	PLAQUETTES DE FREIN	58302-D4A65 , 58302-D4A55 , 58302-D7A70 , 58302-D3A70 , 58302-B2A10 , 58302-A4B60 , 58302-A4B10 , 58302-A6A20 , 58302-1WA35 , 58302-B4A30 , 58302-A6A31 , 58302-C8A30 , 58302-A6A30 , 58302-3XA30 , 58302-1RA30 , 58302-2VA50 , 58302-3ZA70	cf. Photo



description

Références OE
par référence
ATE.

i
Références remplacées /
divers

HYUNDAI

ACCENT IV (10-)	1,6 CRDi		10.2011		13.0460-5650.2	605650	PLAQUETTES DE FREIN	58302-D4A65 , 58302-D4A55 , 58302-D7A70 , 58302-D3A70 , 58302-B2A10 , 58302-A4B60 , 58302-A4B10 , 58302-A6A20 , 58302-1WA35 , 58302-B4A30 , 58302-A6A31 , 58302-C8A30 , 58302-A6A30 , 58302-3XA30 , 58302-1RA30 , 58302-2VA50 , 58302-3ZA70	cf. Photo
			04.2011		13.0460-5650.2	605650	PLAQUETTES DE FREIN	58302-D4A65 , 58302-D4A55 , 58302-D7A70 , 58302-D3A70 , 58302-B2A10 , 58302-A4B60 , 58302-A4B10 , 58302-A6A20 , 58302-1WA35 , 58302-B4A30 , 58302-A6A31 , 58302-C8A30 , 58302-A6A30 , 58302-3XA30 , 58302-1RA30 , 58302-2VA50 , 58302-3ZA70	cf. Photo
ELANTRA (MD/UD) (11-15)	1,6 16V		06.2011	08.2015	13.0460-5650.2	605650	PLAQUETTES DE FREIN	58302-D4A65 , 58302-D4A55 , 58302-D7A70 , 58302-D3A70 , 58302-B2A10 , 58302-A4B60 , 58302-A4B10 , 58302-A6A20 , 58302-1WA35 , 58302-B4A30 , 58302-A6A31 , 58302-C8A30 , 58302-A6A30 , 58302-3XA30 , 58302-1RA30 , 58302-2VA50 , 58302-3ZA70	cf. Photo
	1,6 CRDi		02.2011	12.2015	13.0460-5650.2	605650	PLAQUETTES DE FREIN	58302-D4A65 , 58302-D4A55 , 58302-D7A70 , 58302-D3A70 , 58302-B2A10 , 58302-A4B60 , 58302-A4B10 , 58302-A6A20 , 58302-1WA35 , 58302-B4A30 , 58302-A6A31 , 58302-C8A30 , 58302-A6A30 , 58302-3XA30 , 58302-1RA30 , 58302-2VA50 , 58302-3ZA70	cf. Photo



description

Références OE
par référence
ATE.



Références remplacées /
divers

HYUNDAI

Modèle	Motorisation	Année	Année	Code	Code	Description	Références OE	Notes
ELANTRA (MD/UD) (11-15)	1,8 16V	02.2011	12.2015	13.0460-5650.2	605650	PLAQUETTES DE FREIN	58302-D4A65, 58302-D4A55, 58302-D7A70, 58302-D3A70, 58302-B2A10, 58302-A4B60, 58302-A4B10, 58302-A6A20, 58302-1WA35, 58302-B4A30, 58302-A6A31, 58302-C8A30, 58302-A6A30, 58302-3XA30, 58302-1RA30, 58302-2VA50, 58302-3ZA70	cf. Photo
	1,8 16V Flex	02.2011	12.2015	13.0460-5650.2	605650	PLAQUETTES DE FREIN	58302-D4A65, 58302-D4A55, 58302-D7A70, 58302-D3A70, 58302-B2A10, 58302-A4B60, 58302-A4B10, 58302-A6A20, 58302-1WA35, 58302-B4A30, 58302-A6A31, 58302-C8A30, 58302-A6A30, 58302-3XA30, 58302-1RA30, 58302-2VA50, 58302-3ZA70	cf. Photo
i10 (08-13)	1,0 12V	01.2011	11.2013	24.3728-3101.2	593101	CABLE D'EMBAYAGE	41510-0X100	
	1,2 12V	11.2008	11.2013	24.3728-3101.2	593101	CABLE D'EMBAYAGE	41510-0X100	
	1,2 16V	04.2011	11.2013	24.3728-3101.2	593101	CABLE D'EMBAYAGE	41510-0X100	
i10 (13-)	1,0 12V	12.2013		13.0460-5650.2	605650	PLAQUETTES DE FREIN	58302-D4A65, 58302-D4A55, 58302-D7A70, 58302-D3A70, 58302-B2A10, 58302-A4B60, 58302-A4B10, 58302-A6A20, 58302-1WA35, 58302-B4A30, 58302-A6A31, 58302-C8A30, 58302-A6A30, 58302-3XA30, 58302-1RA30, 58302-2VA50, 58302-3ZA70	cf. Photo
		12.2013		13.0460-5653.2	605653	PLAQUETTES DE FREIN	58101-B9A70, 58101-B9A30	cf. Photo



description

Références OE
par référence
ATE.

i
Références remplacées /
divers

HYUNDAI

Modèle	Motorisation	Date	Code	Code	Description	Références OE	Notes
i10 (13-)	1,0 12V LPG	02.2014	13.0460-5650.2	605650	PLAQUETTES DE FREIN	58302-D4A65 , 58302-D4A55 , 58302-D7A70 , 58302-D3A70 , 58302-B2A10 , 58302-A4B60 , 58302-A4B10 , 58302-A6A20 , 58302-1WA35 , 58302-B4A30 , 58302-A6A31 , 58302-C8A30 , 58302-A6A30 , 58302-3XA30 , 58302-1RA30 , 58302-2VA50 , 58302-3ZA70	cf. Photo
		02.2014	13.0460-5653.2	605653	PLAQUETTES DE FREIN	58101-B9A70 , 58101-B9A30	cf. Photo
	1,2 16V	12.2013	13.0460-5653.2	605653	PLAQUETTES DE FREIN	58101-B9A70 , 58101-B9A30	cf. Photo
		12.2013	13.0460-5650.2	605650	PLAQUETTES DE FREIN	58302-D4A65 , 58302-D4A55 , 58302-D7A70 , 58302-D3A70 , 58302-B2A10 , 58302-A4B60 , 58302-A4B10 , 58302-A6A20 , 58302-1WA35 , 58302-B4A30 , 58302-A6A31 , 58302-C8A30 , 58302-A6A30 , 58302-3XA30 , 58302-1RA30 , 58302-2VA50 , 58302-3ZA70	cf. Photo
i20 / i20 COUPE (GB) (14-)	1,0 T-GDI	01.2016	13.0460-5650.2	605650	PLAQUETTES DE FREIN	58302-D4A65 , 58302-D4A55 , 58302-D7A70 , 58302-D3A70 , 58302-B2A10 , 58302-A4B60 , 58302-A4B10 , 58302-A6A20 , 58302-1WA35 , 58302-B4A30 , 58302-A6A31 , 58302-C8A30 , 58302-A6A30 , 58302-3XA30 , 58302-1RA30 , 58302-2VA50 , 58302-3ZA70	cf. Photo
		01.2016	03.0137-0517.2	650517	JEU DE MACHOIRE	58305-3XA00 , 58305-C7A00	



description

Références OE
par référence
ATE.

i
Références remplacées /
divers

HYUNDAI

i20 / i20 COUPE (GB) (14-)	1,1 blue CRDi		12.2014		13.0460-5650.2	605650	PLAQUETTES DE FREIN	58302-D4A65 , 58302-D4A55 , 58302-D7A70 , 58302-D3A70 , 58302-B2A10 , 58302-A4B60 , 58302-A4B10 , 58302-A6A20 , 58302-1WA35 , 58302-B4A30 , 58302-A6A31 , 58302-C8A30 , 58302-A6A30 , 58302-3XA30 , 58302-1RA30 , 58302-2VA50 , 58302-3ZA70	cf. Photo
			12.2014		03.0137-0517.2	650517	JEU DE MACHOIRE	58305-3XA00 , 58305-C7A00	
	1,1 CRDi		12.2014		13.0460-5650.2	605650	PLAQUETTES DE FREIN	58302-D4A65 , 58302-D4A55 , 58302-D7A70 , 58302-D3A70 , 58302-B2A10 , 58302-A4B60 , 58302-A4B10 , 58302-A6A20 , 58302-1WA35 , 58302-B4A30 , 58302-A6A31 , 58302-C8A30 , 58302-A6A30 , 58302-3XA30 , 58302-1RA30 , 58302-2VA50 , 58302-3ZA70	cf. Photo
			12.2014		03.0137-0517.2	650517	JEU DE MACHOIRE	58305-3XA00 , 58305-C7A00	
	1,2		12.2014		13.0460-5650.2	605650	PLAQUETTES DE FREIN	58302-D4A65 , 58302-D4A55 , 58302-D7A70 , 58302-D3A70 , 58302-B2A10 , 58302-A4B60 , 58302-A4B10 , 58302-A6A20 , 58302-1WA35 , 58302-B4A30 , 58302-A6A31 , 58302-C8A30 , 58302-A6A30 , 58302-3XA30 , 58302-1RA30 , 58302-2VA50 , 58302-3ZA70	cf. Photo
			12.2014		03.0137-0517.2	650517	JEU DE MACHOIRE	58305-3XA00 , 58305-C7A00	



description

Références OE
par référence
ATE.



Références remplacées /
divers

HYUNDAI

i20 / i20 COUPE (GB) (14-)	1,2 LPGI		11.2014		13.0460-5650.2	605650	PLAQUETTES DE FREIN	58302-D4A65 , 58302-D4A55 , 58302-D7A70 , 58302-D3A70 , 58302-B2A10 , 58302-A4B60 , 58302-A4B10 , 58302-A6A20 , 58302-1WA35 , 58302-B4A30 , 58302-A6A31 , 58302-C8A30 , 58302-A6A30 , 58302-3XA30 , 58302-1RA30 , 58302-2VA50 , 58302-3ZA70	cf. Photo
			11.2014		03.0137-0517.2	650517	JEU DE MACHOIRE	58305-3XA00 , 58305-C7A00	
	1,4		12.2014		13.0460-5650.2	605650	PLAQUETTES DE FREIN	58302-D4A65 , 58302-D4A55 , 58302-D7A70 , 58302-D3A70 , 58302-B2A10 , 58302-A4B60 , 58302-A4B10 , 58302-A6A20 , 58302-1WA35 , 58302-B4A30 , 58302-A6A31 , 58302-C8A30 , 58302-A6A30 , 58302-3XA30 , 58302-1RA30 , 58302-2VA50 , 58302-3ZA70	cf. Photo
			12.2014		03.0137-0517.2	650517	JEU DE MACHOIRE	58305-3XA00 , 58305-C7A00	
	1,4 CRDi		12.2014		13.0460-5650.2	605650	PLAQUETTES DE FREIN	58302-D4A65 , 58302-D4A55 , 58302-D7A70 , 58302-D3A70 , 58302-B2A10 , 58302-A4B60 , 58302-A4B10 , 58302-A6A20 , 58302-1WA35 , 58302-B4A30 , 58302-A6A31 , 58302-C8A30 , 58302-A6A30 , 58302-3XA30 , 58302-1RA30 , 58302-2VA50 , 58302-3ZA70	cf. Photo
			12.2014		03.0137-0517.2	650517	JEU DE MACHOIRE	58305-3XA00 , 58305-C7A00	



description

Références OE
par référence
ATE.

i
Références remplacées /
divers

HYUNDAI

i20 ACTIVE (GB) (15-)	1,0 T-GDI		09.2015		13.0460-5650.2	605650	PLAQUETTES DE FREIN	58302-D4A65 , 58302-D4A55 , 58302-D7A70 , 58302-D3A70 , 58302-B2A10 , 58302-A4B60 , 58302-A4B10 , 58302-A6A20 , 58302-1WA35 , 58302-B4A30 , 58302-A6A31 , 58302-C8A30 , 58302-A6A30 , 58302-3XA30 , 58302-1RA30 , 58302-2VA50 , 58302-3ZA70	cf. Photo
			09.2015		03.0137-0517.2	650517	JEU DE MACHOIRE	58305-3XA00 , 58305-C7A00	
	1,4		09.2015		13.0460-5650.2	605650	PLAQUETTES DE FREIN	58302-D4A65 , 58302-D4A55 , 58302-D7A70 , 58302-D3A70 , 58302-B2A10 , 58302-A4B60 , 58302-A4B10 , 58302-A6A20 , 58302-1WA35 , 58302-B4A30 , 58302-A6A31 , 58302-C8A30 , 58302-A6A30 , 58302-3XA30 , 58302-1RA30 , 58302-2VA50 , 58302-3ZA70	cf. Photo
	1,4 CRDI				13.0460-5650.2	605650	PLAQUETTES DE FREIN	58302-D4A65 , 58302-D4A55 , 58302-D7A70 , 58302-D3A70 , 58302-B2A10 , 58302-A4B60 , 58302-A4B10 , 58302-A6A20 , 58302-1WA35 , 58302-B4A30 , 58302-A6A31 , 58302-C8A30 , 58302-A6A30 , 58302-3XA30 , 58302-1RA30 , 58302-2VA50 , 58302-3ZA70	cf. Photo
i30 (GD) (11-17)	1,4 16V		12.2014		13.0460-5650.2	605650	PLAQUETTES DE FREIN	58302-D4A65 , 58302-D4A55 , 58302-D7A70 , 58302-D3A70 , 58302-B2A10 , 58302-A4B60 , 58302-A4B10 , 58302-A6A20 , 58302-1WA35 , 58302-B4A30 , 58302-A6A31 , 58302-C8A30 , 58302-A6A30 , 58302-3XA30 , 58302-1RA30 , 58302-2VA50 , 58302-3ZA70	cf. Photo



description

Références OE
par référence
ATE.

i
Références remplacées /
divers

HYUNDAI

i30 (GD) (11-17)	1,4 16V		11.2011		13.0460-5650.2	605650	PLAQUETTES DE FREIN	58302-D4A65 , 58302-D4A55 , 58302-D7A70 , 58302-D3A70 , 58302-B2A10 , 58302-A4B60 , 58302-A4B10 , 58302-A6A20 , 58302-1WA35 , 58302-B4A30 , 58302-A6A31 , 58302-C8A30 , 58302-A6A30 , 58302-3XA30 , 58302-1RA30 , 58302-2VA50 , 58302-3ZA70	cf. Photo
	1,4 CRDi		11.2011		13.0460-5650.2	605650	PLAQUETTES DE FREIN	58302-D4A65 , 58302-D4A55 , 58302-D7A70 , 58302-D3A70 , 58302-B2A10 , 58302-A4B60 , 58302-A4B10 , 58302-A6A20 , 58302-1WA35 , 58302-B4A30 , 58302-A6A31 , 58302-C8A30 , 58302-A6A30 , 58302-3XA30 , 58302-1RA30 , 58302-2VA50 , 58302-3ZA70	cf. Photo
	1,6		12.2014		13.0460-5650.2	605650	PLAQUETTES DE FREIN	58302-D4A65 , 58302-D4A55 , 58302-D7A70 , 58302-D3A70 , 58302-B2A10 , 58302-A4B60 , 58302-A4B10 , 58302-A6A20 , 58302-1WA35 , 58302-B4A30 , 58302-A6A31 , 58302-C8A30 , 58302-A6A30 , 58302-3XA30 , 58302-1RA30 , 58302-2VA50 , 58302-3ZA70	cf. Photo
	1,6 16V		01.2012		13.0460-5650.2	605650	PLAQUETTES DE FREIN	58302-D4A65 , 58302-D4A55 , 58302-D7A70 , 58302-D3A70 , 58302-B2A10 , 58302-A4B60 , 58302-A4B10 , 58302-A6A20 , 58302-1WA35 , 58302-B4A30 , 58302-A6A31 , 58302-C8A30 , 58302-A6A30 , 58302-3XA30 , 58302-1RA30 , 58302-2VA50 , 58302-3ZA70	cf. Photo



description

Références OE
par référence
ATE.



Références remplacées /
divers

HYUNDAI

i30 (GD) (11-17)	1,6 CRDi		06.2012		13.0460-5650.2	605650	PLAQUETTES DE FREIN	58302-D4A65 , 58302-D4A55 , 58302-D7A70 , 58302-D3A70 , 58302-B2A10 , 58302-A4B60 , 58302-A4B10 , 58302-A6A20 , 58302-1WA35 , 58302-B4A30 , 58302-A6A31 , 58302-C8A30 , 58302-A6A30 , 58302-3XA30 , 58302-1RA30 , 58302-2VA50 , 58302-3ZA70	cf. Photo
			11.2011		13.0460-5650.2	605650	PLAQUETTES DE FREIN	58302-D4A65 , 58302-D4A55 , 58302-D7A70 , 58302-D3A70 , 58302-B2A10 , 58302-A4B60 , 58302-A4B10 , 58302-A6A20 , 58302-1WA35 , 58302-B4A30 , 58302-A6A31 , 58302-C8A30 , 58302-A6A30 , 58302-3XA30 , 58302-1RA30 , 58302-2VA50 , 58302-3ZA70	cf. Photo
	1,6 GDI		11.2011		13.0460-5650.2	605650	PLAQUETTES DE FREIN	58302-D4A65 , 58302-D4A55 , 58302-D7A70 , 58302-D3A70 , 58302-B2A10 , 58302-A4B60 , 58302-A4B10 , 58302-A6A20 , 58302-1WA35 , 58302-B4A30 , 58302-A6A31 , 58302-C8A30 , 58302-A6A30 , 58302-3XA30 , 58302-1RA30 , 58302-2VA50 , 58302-3ZA70	cf. Photo
	1,6 T-GDI		01.2015		13.0460-5650.2	605650	PLAQUETTES DE FREIN	58302-D4A65 , 58302-D4A55 , 58302-D7A70 , 58302-D3A70 , 58302-B2A10 , 58302-A4B60 , 58302-A4B10 , 58302-A6A20 , 58302-1WA35 , 58302-B4A30 , 58302-A6A31 , 58302-C8A30 , 58302-A6A30 , 58302-3XA30 , 58302-1RA30 , 58302-2VA50 , 58302-3ZA70	cf. Photo



description

Références OE
par référence
ATE.

i
Références remplacées /
divers

HYUNDAI

Modèle	Motorisation	Date	Code	Code	Description	Références OE par référence ATE	Références remplacées / divers
i30 COUPE (13-)	1,4 CRDi	05.2013	13.0460-5650.2	605650	PLAQUETTES DE FREIN	58302-D4A65 , 58302-D4A55 , 58302-D7A70 , 58302-D3A70 , 58302-B2A10 , 58302-A4B60 , 58302-A4B10 , 58302-A6A20 , 58302-1WA35 , 58302-B4A30 , 58302-A6A31 , 58302-C8A30 , 58302-A6A30 , 58302-3XA30 , 58302-1RA30 , 58302-2VA50 , 58302-3ZA70	cf. Photo
	1,6 CRDi	05.2013	13.0460-5650.2	605650	PLAQUETTES DE FREIN	58302-D4A65 , 58302-D4A55 , 58302-D7A70 , 58302-D3A70 , 58302-B2A10 , 58302-A4B60 , 58302-A4B10 , 58302-A6A20 , 58302-1WA35 , 58302-B4A30 , 58302-A6A31 , 58302-C8A30 , 58302-A6A30 , 58302-3XA30 , 58302-1RA30 , 58302-2VA50 , 58302-3ZA70	cf. Photo
	1,6 MPi	11.2016	13.0460-5650.2	605650	PLAQUETTES DE FREIN	58302-D4A65 , 58302-D4A55 , 58302-D7A70 , 58302-D3A70 , 58302-B2A10 , 58302-A4B60 , 58302-A4B10 , 58302-A6A20 , 58302-1WA35 , 58302-B4A30 , 58302-A6A31 , 58302-C8A30 , 58302-A6A30 , 58302-3XA30 , 58302-1RA30 , 58302-2VA50 , 58302-3ZA70	cf. Photo
i30 CW Kombi (12-)	1,4	06.2012	13.0460-5650.2	605650	PLAQUETTES DE FREIN	58302-D4A65 , 58302-D4A55 , 58302-D7A70 , 58302-D3A70 , 58302-B2A10 , 58302-A4B60 , 58302-A4B10 , 58302-A6A20 , 58302-1WA35 , 58302-B4A30 , 58302-A6A31 , 58302-C8A30 , 58302-A6A30 , 58302-3XA30 , 58302-1RA30 , 58302-2VA50 , 58302-3ZA70	cf. Photo



description

Références OE
par référence
ATE.

i
Références remplacées /
divers

HYUNDAI

i30 CW Kombi (12-)	1,4 16V		06.2012		13.0460-5650.2	605650	PLAQUETTES DE FREIN	58302-D4A65 , 58302-D4A55 , 58302-D7A70 , 58302-D3A70 , 58302-B2A10 , 58302-A4B60 , 58302-A4B10 , 58302-A6A20 , 58302-1WA35 , 58302-B4A30 , 58302-A6A31 , 58302-C8A30 , 58302-A6A30 , 58302-3XA30 , 58302-1RA30 , 58302-2VA50 , 58302-3ZA70	cf. Photo
	1,4 CRDi		06.2012		13.0460-5650.2	605650	PLAQUETTES DE FREIN	58302-D4A65 , 58302-D4A55 , 58302-D7A70 , 58302-D3A70 , 58302-B2A10 , 58302-A4B60 , 58302-A4B10 , 58302-A6A20 , 58302-1WA35 , 58302-B4A30 , 58302-A6A31 , 58302-C8A30 , 58302-A6A30 , 58302-3XA30 , 58302-1RA30 , 58302-2VA50 , 58302-3ZA70	cf. Photo
	1,6 CRDi		06.2012		13.0460-5650.2	605650	PLAQUETTES DE FREIN	58302-D4A65 , 58302-D4A55 , 58302-D7A70 , 58302-D3A70 , 58302-B2A10 , 58302-A4B60 , 58302-A4B10 , 58302-A6A20 , 58302-1WA35 , 58302-B4A30 , 58302-A6A31 , 58302-C8A30 , 58302-A6A30 , 58302-3XA30 , 58302-1RA30 , 58302-2VA50 , 58302-3ZA70	cf. Photo
	1,6 GDI		06.2012		13.0460-5650.2	605650	PLAQUETTES DE FREIN	58302-D4A65 , 58302-D4A55 , 58302-D7A70 , 58302-D3A70 , 58302-B2A10 , 58302-A4B60 , 58302-A4B10 , 58302-A6A20 , 58302-1WA35 , 58302-B4A30 , 58302-A6A31 , 58302-C8A30 , 58302-A6A30 , 58302-3XA30 , 58302-1RA30 , 58302-2VA50 , 58302-3ZA70	cf. Photo



description

Références OE
par référence
ATE.

i
Références remplacées /
divers

HYUNDAI

i40 (12-)	1,6 16V		03.2012		13.0460-5650.2	605650	PLAQUETTES DE FREIN	58302-D4A65 , 58302-D4A55 , 58302-D7A70 , 58302-D3A70 , 58302-B2A10 , 58302-A4B60 , 58302-A4B10 , 58302-A6A20 , 58302-1WA35 , 58302-B4A30 , 58302-A6A31 , 58302-C8A30 , 58302-A6A30 , 58302-3XA30 , 58302-1RA30 , 58302-2VA50 , 58302-3ZA70	cf. Photo
	1,7 CRDi		01.2015		13.0460-5650.2	605650	PLAQUETTES DE FREIN	58302-D4A65 , 58302-D4A55 , 58302-D7A70 , 58302-D3A70 , 58302-B2A10 , 58302-A4B60 , 58302-A4B10 , 58302-A6A20 , 58302-1WA35 , 58302-B4A30 , 58302-A6A31 , 58302-C8A30 , 58302-A6A30 , 58302-3XA30 , 58302-1RA30 , 58302-2VA50 , 58302-3ZA70	cf. Photo
			03.2012		13.0460-5650.2	605650	PLAQUETTES DE FREIN	58302-D4A65 , 58302-D4A55 , 58302-D7A70 , 58302-D3A70 , 58302-B2A10 , 58302-A4B60 , 58302-A4B10 , 58302-A6A20 , 58302-1WA35 , 58302-B4A30 , 58302-A6A31 , 58302-C8A30 , 58302-A6A30 , 58302-3XA30 , 58302-1RA30 , 58302-2VA50 , 58302-3ZA70	cf. Photo
	2,0 16V		03.2012		13.0460-5650.2	605650	PLAQUETTES DE FREIN	58302-D4A65 , 58302-D4A55 , 58302-D7A70 , 58302-D3A70 , 58302-B2A10 , 58302-A4B60 , 58302-A4B10 , 58302-A6A20 , 58302-1WA35 , 58302-B4A30 , 58302-A6A31 , 58302-C8A30 , 58302-A6A30 , 58302-3XA30 , 58302-1RA30 , 58302-2VA50 , 58302-3ZA70	cf. Photo



description

Références OE
par référence
ATE.

i
Références remplacées /
divers

HYUNDAI

i40 (12-)	2,0 CVT		10.2012		13.0460-5650.2	605650	PLAQUETTES DE FREIN	58302-D4A65 , 58302-D4A55 , 58302-D7A70 , 58302-D3A70 , 58302-B2A10 , 58302-A4B60 , 58302-A4B10 , 58302-A6A20 , 58302-1WA35 , 58302-B4A30 , 58302-A6A31 , 58302-C8A30 , 58302-A6A30 , 58302-3XA30 , 58302-1RA30 , 58302-2VA50 , 58302-3ZA70	cf. Photo
i40 CW Kombi (11-)	1,6 16V		06.2011		13.0460-5650.2	605650	PLAQUETTES DE FREIN	58302-D4A65 , 58302-D4A55 , 58302-D7A70 , 58302-D3A70 , 58302-B2A10 , 58302-A4B60 , 58302-A4B10 , 58302-A6A20 , 58302-1WA35 , 58302-B4A30 , 58302-A6A31 , 58302-C8A30 , 58302-A6A30 , 58302-3XA30 , 58302-1RA30 , 58302-2VA50 , 58302-3ZA70	cf. Photo
	1,7 CRDi		01.2015		13.0460-5650.2	605650	PLAQUETTES DE FREIN	58302-D4A65 , 58302-D4A55 , 58302-D7A70 , 58302-D3A70 , 58302-B2A10 , 58302-A4B60 , 58302-A4B10 , 58302-A6A20 , 58302-1WA35 , 58302-B4A30 , 58302-A6A31 , 58302-C8A30 , 58302-A6A30 , 58302-3XA30 , 58302-1RA30 , 58302-2VA50 , 58302-3ZA70	cf. Photo
			06.2011		13.0460-5650.2	605650	PLAQUETTES DE FREIN	58302-D4A65 , 58302-D4A55 , 58302-D7A70 , 58302-D3A70 , 58302-B2A10 , 58302-A4B60 , 58302-A4B10 , 58302-A6A20 , 58302-1WA35 , 58302-B4A30 , 58302-A6A31 , 58302-C8A30 , 58302-A6A30 , 58302-3XA30 , 58302-1RA30 , 58302-2VA50 , 58302-3ZA70	cf. Photo



description

Références OE
par référence
ATE.

i
Références remplacées /
divers

HYUNDAI

i40 CW Kombi (11-)	2,0 16V		06.2011		13.0460-5650.2	605650	PLAQUETTES DE FREIN	58302-D4A65 , 58302-D4A55 , 58302-D7A70 , 58302-D3A70 , 58302-B2A10 , 58302-A4B60 , 58302-A4B10 , 58302-A6A20 , 58302-1WA35 , 58302-B4A30 , 58302-A6A31 , 58302-C8A30 , 58302-A6A30 , 58302-3XA30 , 58302-1RA30 , 58302-2VA50 , 58302-3ZA70	cf. Photo
	2,0 CVT		10.2012		13.0460-5650.2	605650	PLAQUETTES DE FREIN	58302-D4A65 , 58302-D4A55 , 58302-D7A70 , 58302-D3A70 , 58302-B2A10 , 58302-A4B60 , 58302-A4B10 , 58302-A6A20 , 58302-1WA35 , 58302-B4A30 , 58302-A6A31 , 58302-C8A30 , 58302-A6A30 , 58302-3XA30 , 58302-1RA30 , 58302-2VA50 , 58302-3ZA70	cf. Photo
	2,0 GDI		03.2012		13.0460-5650.2	605650	PLAQUETTES DE FREIN	58302-D4A65 , 58302-D4A55 , 58302-D7A70 , 58302-D3A70 , 58302-B2A10 , 58302-A4B60 , 58302-A4B10 , 58302-A6A20 , 58302-1WA35 , 58302-B4A30 , 58302-A6A31 , 58302-C8A30 , 58302-A6A30 , 58302-3XA30 , 58302-1RA30 , 58302-2VA50 , 58302-3ZA70	cf. Photo
TUCSON (15-)	1,6 GDI		06.2015		13.0460-5650.2	605650	PLAQUETTES DE FREIN	58302-D4A65 , 58302-D4A55 , 58302-D7A70 , 58302-D3A70 , 58302-B2A10 , 58302-A4B60 , 58302-A4B10 , 58302-A6A20 , 58302-1WA35 , 58302-B4A30 , 58302-A6A31 , 58302-C8A30 , 58302-A6A30 , 58302-3XA30 , 58302-1RA30 , 58302-2VA50 , 58302-3ZA70	cf. Photo



description

Références OE
par référence
ATE.

i
Références remplacées /
divers

HYUNDAI

TUCSON (15-)	1,6 T-GDI	06.2015	13.0460-5650.2	605650	PLAQUETTES DE FREIN	58302-D4A65 , 58302-D4A55 , 58302-D7A70 , 58302-D3A70 , 58302-B2A10 , 58302-A4B60 , 58302-A4B10 , 58302-A6A20 , 58302-1WA35 , 58302-B4A30 , 58302-A6A31 , 58302-C8A30 , 58302-A6A30 , 58302-3XA30 , 58302-1RA30 , 58302-2VA50 , 58302-3ZA70	cf. Photo
	1,6 T-GDI 4WD	06.2015	13.0460-5650.2	605650	PLAQUETTES DE FREIN	58302-D4A65 , 58302-D4A55 , 58302-D7A70 , 58302-D3A70 , 58302-B2A10 , 58302-A4B60 , 58302-A4B10 , 58302-A6A20 , 58302-1WA35 , 58302-B4A30 , 58302-A6A31 , 58302-C8A30 , 58302-A6A30 , 58302-3XA30 , 58302-1RA30 , 58302-2VA50 , 58302-3ZA70	cf. Photo
	1,7 CRDi	06.2015	13.0460-5650.2	605650	PLAQUETTES DE FREIN	58302-D4A65 , 58302-D4A55 , 58302-D7A70 , 58302-D3A70 , 58302-B2A10 , 58302-A4B60 , 58302-A4B10 , 58302-A6A20 , 58302-1WA35 , 58302-B4A30 , 58302-A6A31 , 58302-C8A30 , 58302-A6A30 , 58302-3XA30 , 58302-1RA30 , 58302-2VA50 , 58302-3ZA70	cf. Photo
	2	06.2015	13.0460-5650.2	605650	PLAQUETTES DE FREIN	58302-D4A65 , 58302-D4A55 , 58302-D7A70 , 58302-D3A70 , 58302-B2A10 , 58302-A4B60 , 58302-A4B10 , 58302-A6A20 , 58302-1WA35 , 58302-B4A30 , 58302-A6A31 , 58302-C8A30 , 58302-A6A30 , 58302-3XA30 , 58302-1RA30 , 58302-2VA50 , 58302-3ZA70	cf. Photo



description

Références OE
par référence
ATE.



Références remplacées /
divers

HYUNDAI

TUCSON (15-)	2,0 CRDI		06.2015		13.0460-5650.2	605650	PLAQUETTES DE FREIN	58302-D4A65 , 58302-D4A55 , 58302-D7A70 , 58302-D3A70 , 58302-B2A10 , 58302-A4B60 , 58302-A4B10 , 58302-A6A20 , 58302-1WA35 , 58302-B4A30 , 58302-A6A31 , 58302-C8A30 , 58302-A6A30 , 58302-3XA30 , 58302-1RA30 , 58302-2VA50 , 58302-3ZA70	cf. Photo
	2,0 CRDI 4WD		06.2015		13.0460-5650.2	605650	PLAQUETTES DE FREIN	58302-D4A65 , 58302-D4A55 , 58302-D7A70 , 58302-D3A70 , 58302-B2A10 , 58302-A4B60 , 58302-A4B10 , 58302-A6A20 , 58302-1WA35 , 58302-B4A30 , 58302-A6A31 , 58302-C8A30 , 58302-A6A30 , 58302-3XA30 , 58302-1RA30 , 58302-2VA50 , 58302-3ZA70	cf. Photo
VELOSTER (11-)	1,6 16V		10.2011		13.0460-5650.2	605650	PLAQUETTES DE FREIN	58302-D4A65 , 58302-D4A55 , 58302-D7A70 , 58302-D3A70 , 58302-B2A10 , 58302-A4B60 , 58302-A4B10 , 58302-A6A20 , 58302-1WA35 , 58302-B4A30 , 58302-A6A31 , 58302-C8A30 , 58302-A6A30 , 58302-3XA30 , 58302-1RA30 , 58302-2VA50 , 58302-3ZA70	cf. Photo
	1,6 GDI		03.2011		13.0460-5650.2	605650	PLAQUETTES DE FREIN	58302-D4A65 , 58302-D4A55 , 58302-D7A70 , 58302-D3A70 , 58302-B2A10 , 58302-A4B60 , 58302-A4B10 , 58302-A6A20 , 58302-1WA35 , 58302-B4A30 , 58302-A6A31 , 58302-C8A30 , 58302-A6A30 , 58302-3XA30 , 58302-1RA30 , 58302-2VA50 , 58302-3ZA70	cf. Photo



description

Références OE
par référence
ATE.



Références remplacées /
divers

HYUNDAI

VELOSTER (11-)	1,6 MPI		04.2011		13.0460-5650.2	605650	PLAQUETTES DE FREIN	58302-D4A65 , 58302-D4A55 , 58302-D7A70 , 58302-D3A70 , 58302-B2A10 , 58302-A4B60 , 58302-A4B10 , 58302-A6A20 , 58302-1WA35 , 58302-B4A30 , 58302-A6A31 , 58302-C8A30 , 58302-A6A30 , 58302-3XA30 , 58302-1RA30 , 58302-2VA50 , 58302-3ZA70	cf. Photo
	1,6 T-GDI		10.2012		13.0460-5650.2	605650	PLAQUETTES DE FREIN	58302-D4A65 , 58302-D4A55 , 58302-D7A70 , 58302-D3A70 , 58302-B2A10 , 58302-A4B60 , 58302-A4B10 , 58302-A6A20 , 58302-1WA35 , 58302-B4A30 , 58302-A6A31 , 58302-C8A30 , 58302-A6A30 , 58302-3XA30 , 58302-1RA30 , 58302-2VA50 , 58302-3ZA70	cf. Photo



description

Références OE
par référence
ATE.



Références remplacées /
divers

KIA

CARENS IV (13-)	1,6 GDi	03.2013	13.0460-5650.2	605650	PLAQUETTES DE FREIN	58302-D4A65 , 58302-D4A55 , 58302-D7A70 , 58302-D3A70 , 58302-B2A10 , 58302-A4B60 , 58302-A4B10 , 58302-A6A20 , 58302-1WA35 , 58302-B4A30 , 58302-A6A31 , 58302-C8A30 , 58302-A6A30 , 58302-3XA30 , 58302-1RA30 , 58302-2VA50 , 58302-3ZA70	cf. Photo
	1,7 CRDi	07.2015	13.0460-5650.2	605650	PLAQUETTES DE FREIN	58302-D4A65 , 58302-D4A55 , 58302-D7A70 , 58302-D3A70 , 58302-B2A10 , 58302-A4B60 , 58302-A4B10 , 58302-A6A20 , 58302-1WA35 , 58302-B4A30 , 58302-A6A31 , 58302-C8A30 , 58302-A6A30 , 58302-3XA30 , 58302-1RA30 , 58302-2VA50 , 58302-3ZA70	cf. Photo
		03.2013	13.0460-5650.2	605650	PLAQUETTES DE FREIN	58302-D4A65 , 58302-D4A55 , 58302-D7A70 , 58302-D3A70 , 58302-B2A10 , 58302-A4B60 , 58302-A4B10 , 58302-A6A20 , 58302-1WA35 , 58302-B4A30 , 58302-A6A31 , 58302-C8A30 , 58302-A6A30 , 58302-3XA30 , 58302-1RA30 , 58302-2VA50 , 58302-3ZA70	cf. Photo
	2,0 GDi	03.2013	13.0460-5650.2	605650	PLAQUETTES DE FREIN	58302-D4A65 , 58302-D4A55 , 58302-D7A70 , 58302-D3A70 , 58302-B2A10 , 58302-A4B60 , 58302-A4B10 , 58302-A6A20 , 58302-1WA35 , 58302-B4A30 , 58302-A6A31 , 58302-C8A30 , 58302-A6A30 , 58302-3XA30 , 58302-1RA30 , 58302-2VA50 , 58302-3ZA70	cf. Photo



description

Références OE
par référence
ATE.

i
Références remplacées /
divers

KIA

CEE'D (12-)	1,0 T-GDI	07.2015	13.0460-5650.2	605650	PLAQUETTES DE FREIN	58302-D4A65 , 58302-D4A55 , 58302-D7A70 , 58302-D3A70 , 58302-B2A10 , 58302-A4B60 , 58302-A4B10 , 58302-A6A20 , 58302-1WA35 , 58302-B4A30 , 58302-A6A31 , 58302-C8A30 , 58302-A6A30 , 58302-3XA30 , 58302-1RA30 , 58302-2VA50 , 58302-3ZA70	cf. Photo
	1,4 CRDI 90	05.2012	13.0460-5650.2	605650	PLAQUETTES DE FREIN	58302-D4A65 , 58302-D4A55 , 58302-D7A70 , 58302-D3A70 , 58302-B2A10 , 58302-A4B60 , 58302-A4B10 , 58302-A6A20 , 58302-1WA35 , 58302-B4A30 , 58302-A6A31 , 58302-C8A30 , 58302-A6A30 , 58302-3XA30 , 58302-1RA30 , 58302-2VA50 , 58302-3ZA70	cf. Photo
	1,4 CVVT	05.2012	13.0460-5650.2	605650	PLAQUETTES DE FREIN	58302-D4A65 , 58302-D4A55 , 58302-D7A70 , 58302-D3A70 , 58302-B2A10 , 58302-A4B60 , 58302-A4B10 , 58302-A6A20 , 58302-1WA35 , 58302-B4A30 , 58302-A6A31 , 58302-C8A30 , 58302-A6A30 , 58302-3XA30 , 58302-1RA30 , 58302-2VA50 , 58302-3ZA70	cf. Photo
	1,4 MPI	04.2015	13.0460-5650.2	605650	PLAQUETTES DE FREIN	58302-D4A65 , 58302-D4A55 , 58302-D7A70 , 58302-D3A70 , 58302-B2A10 , 58302-A4B60 , 58302-A4B10 , 58302-A6A20 , 58302-1WA35 , 58302-B4A30 , 58302-A6A31 , 58302-C8A30 , 58302-A6A30 , 58302-3XA30 , 58302-1RA30 , 58302-2VA50 , 58302-3ZA70	cf. Photo



description

Références OE
par référence
ATE.

i
Références remplacées /
divers

KIA

CEE'D (12-)	1,6 CRDi 110	05.2012	13.0460-5650.2	605650	PLAQUETTES DE FREIN	58302-D4A65 , 58302-D4A55 , 58302-D7A70 , 58302-D3A70 , 58302-B2A10 , 58302-A4B60 , 58302-A4B10 , 58302-A6A20 , 58302-1WA35 , 58302-B4A30 , 58302-A6A31 , 58302-C8A30 , 58302-A6A30 , 58302-3XA30 , 58302-1RA30 , 58302-2VA50 , 58302-3ZA70	cf. Photo
	1,6 CRDi 115	05.2012	13.0460-5650.2	605650	PLAQUETTES DE FREIN	58302-D4A65 , 58302-D4A55 , 58302-D7A70 , 58302-D3A70 , 58302-B2A10 , 58302-A4B60 , 58302-A4B10 , 58302-A6A20 , 58302-1WA35 , 58302-B4A30 , 58302-A6A31 , 58302-C8A30 , 58302-A6A30 , 58302-3XA30 , 58302-1RA30 , 58302-2VA50 , 58302-3ZA70	cf. Photo
	1,6 CRDi 128	05.2012	13.0460-5650.2	605650	PLAQUETTES DE FREIN	58302-D4A65 , 58302-D4A55 , 58302-D7A70 , 58302-D3A70 , 58302-B2A10 , 58302-A4B60 , 58302-A4B10 , 58302-A6A20 , 58302-1WA35 , 58302-B4A30 , 58302-A6A31 , 58302-C8A30 , 58302-A6A30 , 58302-3XA30 , 58302-1RA30 , 58302-2VA50 , 58302-3ZA70	cf. Photo
	1,6 CRDi 136	07.2015	13.0460-5650.2	605650	PLAQUETTES DE FREIN	58302-D4A65 , 58302-D4A55 , 58302-D7A70 , 58302-D3A70 , 58302-B2A10 , 58302-A4B60 , 58302-A4B10 , 58302-A6A20 , 58302-1WA35 , 58302-B4A30 , 58302-A6A31 , 58302-C8A30 , 58302-A6A30 , 58302-3XA30 , 58302-1RA30 , 58302-2VA50 , 58302-3ZA70	cf. Photo



description

Références OE
par référence
ATE.

i
Références remplacées /
divers

KIA

CEE'D (12-)	1,6 CRDi 90	05.2012	13.0460-5650.2	605650	PLAQUETTES DE FREIN	58302-D4A65 , 58302-D4A55 , 58302-D7A70 , 58302-D3A70 , 58302-B2A10 , 58302-A4B60 , 58302-A4B10 , 58302-A6A20 , 58302-1WA35 , 58302-B4A30 , 58302-A6A31 , 58302-C8A30 , 58302-A6A30 , 58302-3XA30 , 58302-1RA30 , 58302-2VA50 , 58302-3ZA70	cf. Photo
	1,6 CVT	01.2013	13.0460-5650.2	605650	PLAQUETTES DE FREIN	58302-D4A65 , 58302-D4A55 , 58302-D7A70 , 58302-D3A70 , 58302-B2A10 , 58302-A4B60 , 58302-A4B10 , 58302-A6A20 , 58302-1WA35 , 58302-B4A30 , 58302-A6A31 , 58302-C8A30 , 58302-A6A30 , 58302-3XA30 , 58302-1RA30 , 58302-2VA50 , 58302-3ZA70	cf. Photo
		05.2012	13.0460-5650.2	605650	PLAQUETTES DE FREIN	58302-D4A65 , 58302-D4A55 , 58302-D7A70 , 58302-D3A70 , 58302-B2A10 , 58302-A4B60 , 58302-A4B10 , 58302-A6A20 , 58302-1WA35 , 58302-B4A30 , 58302-A6A31 , 58302-C8A30 , 58302-A6A30 , 58302-3XA30 , 58302-1RA30 , 58302-2VA50 , 58302-3ZA70	cf. Photo
	1,6 GDI	05.2012	13.0460-5650.2	605650	PLAQUETTES DE FREIN	58302-D4A65 , 58302-D4A55 , 58302-D7A70 , 58302-D3A70 , 58302-B2A10 , 58302-A4B60 , 58302-A4B10 , 58302-A6A20 , 58302-1WA35 , 58302-B4A30 , 58302-A6A31 , 58302-C8A30 , 58302-A6A30 , 58302-3XA30 , 58302-1RA30 , 58302-2VA50 , 58302-3ZA70	cf. Photo



description

Références OE
par référence
ATE.

i
Références remplacées /
divers

KIA

Modèle	Version	Date	Date	Code	Code	Description	Références OE	Notes
CEE'D (12-)	1,6 GT	07.2013		13.0460-5650.2	605650	PLAQUETTES DE FREIN	58302-D4A65 , 58302-D4A55 , 58302-D7A70 , 58302-D3A70 , 58302-B2A10 , 58302-A4B60 , 58302-A4B10 , 58302-A6A20 , 58302-1WA35 , 58302-B4A30 , 58302-A6A31 , 58302-C8A30 , 58302-A6A30 , 58302-3XA30 , 58302-1RA30 , 58302-2VA50 , 58302-3ZA70	cf. Photo
CERATO KOUP (09-)	1,6 CVVT	09.2013		13.0460-5659.2	605659	PLAQUETTES DE FREIN	58101-A7A20 , 58101-2TA61	cf. Photo
OPTIMA (TF) (10-15)	1,7 CRDi	03.2012	12.2015	13.0460-5659.2	605659	PLAQUETTES DE FREIN	58101-A7A20 , 58101-2TA61	cf. Photo
		03.2012	12.2015	13.0460-5650.2	605650	PLAQUETTES DE FREIN	58302-D4A65 , 58302-D4A55 , 58302-D7A70 , 58302-D3A70 , 58302-B2A10 , 58302-A4B60 , 58302-A4B10 , 58302-A6A20 , 58302-1WA35 , 58302-B4A30 , 58302-A6A31 , 58302-C8A30 , 58302-A6A30 , 58302-3XA30 , 58302-1RA30 , 58302-2VA50 , 58302-3ZA70	cf. Photo
	2,0 16V	03.2012	12.2015	13.0460-5659.2	605659	PLAQUETTES DE FREIN	58101-A7A20 , 58101-2TA61	cf. Photo
		03.2012	12.2015	13.0460-5650.2	605650	PLAQUETTES DE FREIN	58302-D4A65 , 58302-D4A55 , 58302-D7A70 , 58302-D3A70 , 58302-B2A10 , 58302-A4B60 , 58302-A4B10 , 58302-A6A20 , 58302-1WA35 , 58302-B4A30 , 58302-A6A31 , 58302-C8A30 , 58302-A6A30 , 58302-3XA30 , 58302-1RA30 , 58302-2VA50 , 58302-3ZA70	cf. Photo



description

Références OE
par référence
ATE.

i
Références remplacées /
divers

KIA

Modèle	Version	03.2012	12.2015	13.0460-5650.2	605650	description	Références OE par référence ATE.	Références remplacées / divers
OPTIMA (TF) (10-15)	2,0 CVVT					PLAQUETTES DE FREIN	58302-D4A65 , 58302-D4A55 , 58302-D7A70 , 58302-D3A70 , 58302-B2A10 , 58302-A4B60 , 58302-A4B10 , 58302-A6A20 , 58302-1WA35 , 58302-B4A30 , 58302-A6A31 , 58302-C8A30 , 58302-A6A30 , 58302-3XA30 , 58302-1RA30 , 58302-2VA50 , 58302-3ZA70	cf. Photo
		03.2012	12.2015	13.0460-5659.2	605659	PLAQUETTES DE FREIN	58101-A7A20 , 58101-2TA61	cf. Photo
	2,0 CVVT Hybrid	03.2012	12.2015	13.0460-5650.2	605650	PLAQUETTES DE FREIN	58302-D4A65 , 58302-D4A55 , 58302-D7A70 , 58302-D3A70 , 58302-B2A10 , 58302-A4B60 , 58302-A4B10 , 58302-A6A20 , 58302-1WA35 , 58302-B4A30 , 58302-A6A31 , 58302-C8A30 , 58302-A6A30 , 58302-3XA30 , 58302-1RA30 , 58302-2VA50 , 58302-3ZA70	cf. Photo
	2,4 16V	03.2012	12.2015	13.0460-5650.2	605650	PLAQUETTES DE FREIN	58302-D4A65 , 58302-D4A55 , 58302-D7A70 , 58302-D3A70 , 58302-B2A10 , 58302-A4B60 , 58302-A4B10 , 58302-A6A20 , 58302-1WA35 , 58302-B4A30 , 58302-A6A31 , 58302-C8A30 , 58302-A6A30 , 58302-3XA30 , 58302-1RA30 , 58302-2VA50 , 58302-3ZA70	cf. Photo
		03.2012	12.2015	13.0460-5659.2	605659	PLAQUETTES DE FREIN	58101-A7A20 , 58101-2TA61	cf. Photo
		06.2010	12.2015	13.0460-5659.2	605659	PLAQUETTES DE FREIN	58101-A7A20 , 58101-2TA61	cf. Photo



description

Références OE
par référence
ATE.



Références remplacées /
divers

KIA

Modèle	Motorisation	Année	Année	Code	Code	Description	Références OE par référence ATE	Références remplacées / divers
OPTIMA (TF) (10-15)	2,4 16V	06.2010	12.2015	13.0460-5650.2	605650	PLAQUETTES DE FREIN	58302-D4A65, 58302-D4A55, 58302-D7A70, 58302-D3A70, 58302-B2A10, 58302-A4B60, 58302-A4B10, 58302-A6A20, 58302-1WA35, 58302-B4A30, 58302-A6A31, 58302-C8A30, 58302-A6A30, 58302-3XA30, 58302-1RA30, 58302-2VA50, 58302-3ZA70	cf. Photo
OPTIMA / OPTIMA SW (JF) (15-)	1,7 CRDi	11.2015		13.0460-5650.2	605650	PLAQUETTES DE FREIN	58302-D4A65, 58302-D4A55, 58302-D7A70, 58302-D3A70, 58302-B2A10, 58302-A4B60, 58302-A4B10, 58302-A6A20, 58302-1WA35, 58302-B4A30, 58302-A6A31, 58302-C8A30, 58302-A6A30, 58302-3XA30, 58302-1RA30, 58302-2VA50, 58302-3ZA70	cf. Photo
	2,0 CVVL	09.2015		13.0460-5650.2	605650	PLAQUETTES DE FREIN	58302-D4A65, 58302-D4A55, 58302-D7A70, 58302-D3A70, 58302-B2A10, 58302-A4B60, 58302-A4B10, 58302-A6A20, 58302-1WA35, 58302-B4A30, 58302-A6A31, 58302-C8A30, 58302-A6A30, 58302-3XA30, 58302-1RA30, 58302-2VA50, 58302-3ZA70	cf. Photo
	2,0 GDi Hybrid	09.2015		13.0460-5650.2	605650	PLAQUETTES DE FREIN	58302-D4A65, 58302-D4A55, 58302-D7A70, 58302-D3A70, 58302-B2A10, 58302-A4B60, 58302-A4B10, 58302-A6A20, 58302-1WA35, 58302-B4A30, 58302-A6A31, 58302-C8A30, 58302-A6A30, 58302-3XA30, 58302-1RA30, 58302-2VA50, 58302-3ZA70	cf. Photo



description

Références OE
par référence
ATE.

i
Références remplacées /
divers

KIA

OPTIMA / OPTIMA SW (JF) (15-)	2,0 T-GDi		09.2015		13.0460-5650.2	605650	PLAQUETTES DE FREIN	58302-D4A65 , 58302-D4A55 , 58302-D7A70 , 58302-D3A70 , 58302-B2A10 , 58302-A4B60 , 58302-A4B10 , 58302-A6A20 , 58302-1WA35 , 58302-B4A30 , 58302-A6A31 , 58302-C8A30 , 58302-A6A30 , 58302-3XA30 , 58302-1RA30 , 58302-2VA50 , 58302-3ZA70	cf. Photo
	2,4 GDi		09.2015		13.0460-5650.2	605650	PLAQUETTES DE FREIN	58302-D4A65 , 58302-D4A55 , 58302-D7A70 , 58302-D3A70 , 58302-B2A10 , 58302-A4B60 , 58302-A4B10 , 58302-A6A20 , 58302-1WA35 , 58302-B4A30 , 58302-A6A31 , 58302-C8A30 , 58302-A6A30 , 58302-3XA30 , 58302-1RA30 , 58302-2VA50 , 58302-3ZA70	cf. Photo
PRO CEE'D (13-)	1,0 T-GDI		07.2015		13.0460-5650.2	605650	PLAQUETTES DE FREIN	58302-D4A65 , 58302-D4A55 , 58302-D7A70 , 58302-D3A70 , 58302-B2A10 , 58302-A4B60 , 58302-A4B10 , 58302-A6A20 , 58302-1WA35 , 58302-B4A30 , 58302-A6A31 , 58302-C8A30 , 58302-A6A30 , 58302-3XA30 , 58302-1RA30 , 58302-2VA50 , 58302-3ZA70	cf. Photo
	1,4 CRDi		03.2013		13.0460-5650.2	605650	PLAQUETTES DE FREIN	58302-D4A65 , 58302-D4A55 , 58302-D7A70 , 58302-D3A70 , 58302-B2A10 , 58302-A4B60 , 58302-A4B10 , 58302-A6A20 , 58302-1WA35 , 58302-B4A30 , 58302-A6A31 , 58302-C8A30 , 58302-A6A30 , 58302-3XA30 , 58302-1RA30 , 58302-2VA50 , 58302-3ZA70	cf. Photo



description

Références OE
par référence
ATE.

i
Références remplacées /
divers

KIA

PRO CEE'D (13-)	1,4 CVVT		03.2013		13.0460-5650.2	605650	PLAQUETTES DE FREIN	58302-D4A65 , 58302-D4A55 , 58302-D7A70 , 58302-D3A70 , 58302-B2A10 , 58302-A4B60 , 58302-A4B10 , 58302-A6A20 , 58302-1WA35 , 58302-B4A30 , 58302-A6A31 , 58302-C8A30 , 58302-A6A30 , 58302-3XA30 , 58302-1RA30 , 58302-2VA50 , 58302-3ZA70	cf. Photo
	1,4 MPI		04.2015		13.0460-5650.2	605650	PLAQUETTES DE FREIN	58302-D4A65 , 58302-D4A55 , 58302-D7A70 , 58302-D3A70 , 58302-B2A10 , 58302-A4B60 , 58302-A4B10 , 58302-A6A20 , 58302-1WA35 , 58302-B4A30 , 58302-A6A31 , 58302-C8A30 , 58302-A6A30 , 58302-3XA30 , 58302-1RA30 , 58302-2VA50 , 58302-3ZA70	cf. Photo
			07.2013		13.0460-5650.2	605650	PLAQUETTES DE FREIN	58302-D4A65 , 58302-D4A55 , 58302-D7A70 , 58302-D3A70 , 58302-B2A10 , 58302-A4B60 , 58302-A4B10 , 58302-A6A20 , 58302-1WA35 , 58302-B4A30 , 58302-A6A31 , 58302-C8A30 , 58302-A6A30 , 58302-3XA30 , 58302-1RA30 , 58302-2VA50 , 58302-3ZA70	cf. Photo
	1,6 CRDi		03.2013		13.0460-5650.2	605650	PLAQUETTES DE FREIN	58302-D4A65 , 58302-D4A55 , 58302-D7A70 , 58302-D3A70 , 58302-B2A10 , 58302-A4B60 , 58302-A4B10 , 58302-A6A20 , 58302-1WA35 , 58302-B4A30 , 58302-A6A31 , 58302-C8A30 , 58302-A6A30 , 58302-3XA30 , 58302-1RA30 , 58302-2VA50 , 58302-3ZA70	cf. Photo



description

Références OE
par référence
ATE.

i
Références remplacées /
divers

KIA

PRO CEE'D (13-)	1,6 CRDi 136		07.2015		13.0460-5650.2	605650	PLAQUETTES DE FREIN	58302-D4A65 , 58302-D4A55 , 58302-D7A70 , 58302-D3A70 , 58302-B2A10 , 58302-A4B60 , 58302-A4B10 , 58302-A6A20 , 58302-1WA35 , 58302-B4A30 , 58302-A6A31 , 58302-C8A30 , 58302-A6A30 , 58302-3XA30 , 58302-1RA30 , 58302-2VA50 , 58302-3ZA70	cf. Photo
	1,6 CVT		03.2013		13.0460-5650.2	605650	PLAQUETTES DE FREIN	58302-D4A65 , 58302-D4A55 , 58302-D7A70 , 58302-D3A70 , 58302-B2A10 , 58302-A4B60 , 58302-A4B10 , 58302-A6A20 , 58302-1WA35 , 58302-B4A30 , 58302-A6A31 , 58302-C8A30 , 58302-A6A30 , 58302-3XA30 , 58302-1RA30 , 58302-2VA50 , 58302-3ZA70	cf. Photo
	1,6 GDI		03.2013		13.0460-5650.2	605650	PLAQUETTES DE FREIN	58302-D4A65 , 58302-D4A55 , 58302-D7A70 , 58302-D3A70 , 58302-B2A10 , 58302-A4B60 , 58302-A4B10 , 58302-A6A20 , 58302-1WA35 , 58302-B4A30 , 58302-A6A31 , 58302-C8A30 , 58302-A6A30 , 58302-3XA30 , 58302-1RA30 , 58302-2VA50 , 58302-3ZA70	cf. Photo
RIO III (UB) (11-17)	1,1 CRDi		09.2011		13.0460-5650.2	605650	PLAQUETTES DE FREIN	58302-D4A65 , 58302-D4A55 , 58302-D7A70 , 58302-D3A70 , 58302-B2A10 , 58302-A4B60 , 58302-A4B10 , 58302-A6A20 , 58302-1WA35 , 58302-B4A30 , 58302-A6A31 , 58302-C8A30 , 58302-A6A30 , 58302-3XA30 , 58302-1RA30 , 58302-2VA50 , 58302-3ZA70	cf. Photo
			09.2011		03.0137-0517.2	650517	JEU DE MACHOIRE	58305-3XA00 , 58305-C7A00	



description

Références OE
par référence
ATE.

i
Références remplacées /
divers

KIA

RIO III (UB) (11-17)	1,2 CVVT		09.2011		13.0460-5650.2	605650	PLAQUETTES DE FREIN	58302-D4A65 , 58302-D4A55 , 58302-D7A70 , 58302-D3A70 , 58302-B2A10 , 58302-A4B60 , 58302-A4B10 , 58302-A6A20 , 58302-1WA35 , 58302-B4A30 , 58302-A6A31 , 58302-C8A30 , 58302-A6A30 , 58302-3XA30 , 58302-1RA30 , 58302-2VA50 , 58302-3ZA70	cf. Photo
			11.2014		13.0460-5650.2	605650	PLAQUETTES DE FREIN	58302-D4A65 , 58302-D4A55 , 58302-D7A70 , 58302-D3A70 , 58302-B2A10 , 58302-A4B60 , 58302-A4B10 , 58302-A6A20 , 58302-1WA35 , 58302-B4A30 , 58302-A6A31 , 58302-C8A30 , 58302-A6A30 , 58302-3XA30 , 58302-1RA30 , 58302-2VA50 , 58302-3ZA70	cf. Photo
			09.2011		03.0137-0517.2	650517	JEU DE MACHOIRE	58305-3XA00 , 58305-C7A00	
			11.2014		03.0137-0517.2	650517	JEU DE MACHOIRE	58305-3XA00 , 58305-C7A00	
	1,25 CVVT		09.2011		13.0460-5650.2	605650	PLAQUETTES DE FREIN	58302-D4A65 , 58302-D4A55 , 58302-D7A70 , 58302-D3A70 , 58302-B2A10 , 58302-A4B60 , 58302-A4B10 , 58302-A6A20 , 58302-1WA35 , 58302-B4A30 , 58302-A6A31 , 58302-C8A30 , 58302-A6A30 , 58302-3XA30 , 58302-1RA30 , 58302-2VA50 , 58302-3ZA70	cf. Photo
			09.2011		03.0137-0517.2	650517	JEU DE MACHOIRE	58305-3XA00 , 58305-C7A00	



description

Références OE
par référence
ATE.

i
Références remplacées /
divers

KIA

RIO III (UB) (11-17)	1,4 CRDi	09.2011	13.0460-5650.2	605650	PLAQUETTES DE FREIN	58302-D4A65 , 58302-D4A55 , 58302-D7A70 , 58302-D3A70 , 58302-B2A10 , 58302-A4B60 , 58302-A4B10 , 58302-A6A20 , 58302-1WA35 , 58302-B4A30 , 58302-A6A31 , 58302-C8A30 , 58302-A6A30 , 58302-3XA30 , 58302-1RA30 , 58302-2VA50 , 58302-3ZA70	cf. Photo
		09.2011	03.0137-0517.2	650517	JEU DE MACHOIRE	58305-3XA00 , 58305-C7A00	
	1,4 CVVT	09.2011	13.0460-5650.2	605650	PLAQUETTES DE FREIN	58302-D4A65 , 58302-D4A55 , 58302-D7A70 , 58302-D3A70 , 58302-B2A10 , 58302-A4B60 , 58302-A4B10 , 58302-A6A20 , 58302-1WA35 , 58302-B4A30 , 58302-A6A31 , 58302-C8A30 , 58302-A6A30 , 58302-3XA30 , 58302-1RA30 , 58302-2VA50 , 58302-3ZA70	cf. Photo
		09.2011	03.0137-0517.2	650517	JEU DE MACHOIRE	58305-3XA00 , 58305-C7A00	
	1,6 CVVT	06.2012	13.0460-5650.2	605650	PLAQUETTES DE FREIN	58302-D4A65 , 58302-D4A55 , 58302-D7A70 , 58302-D3A70 , 58302-B2A10 , 58302-A4B60 , 58302-A4B10 , 58302-A6A20 , 58302-1WA35 , 58302-B4A30 , 58302-A6A31 , 58302-C8A30 , 58302-A6A30 , 58302-3XA30 , 58302-1RA30 , 58302-2VA50 , 58302-3ZA70	cf. Photo



description

Références OE
par référence
ATE.

i
Références remplacées /
divers

KIA

SOUL (14-)	1,6 CRDI		02.2014		13.0460-5650.2	605650	PLAQUETTES DE FREIN	58302-D4A65 , 58302-D4A55 , 58302-D7A70 , 58302-D3A70 , 58302-B2A10 , 58302-A4B60 , 58302-A4B10 , 58302-A6A20 , 58302-1WA35 , 58302-B4A30 , 58302-A6A31 , 58302-C8A30 , 58302-A6A30 , 58302-3XA30 , 58302-1RA30 , 58302-2VA50 , 58302-3ZA70	cf. Photo
	1,6 CRDI 136		04.2015		13.0460-5650.2	605650	PLAQUETTES DE FREIN	58302-D4A65 , 58302-D4A55 , 58302-D7A70 , 58302-D3A70 , 58302-B2A10 , 58302-A4B60 , 58302-A4B10 , 58302-A6A20 , 58302-1WA35 , 58302-B4A30 , 58302-A6A31 , 58302-C8A30 , 58302-A6A30 , 58302-3XA30 , 58302-1RA30 , 58302-2VA50 , 58302-3ZA70	cf. Photo
	1,6 CVVT		02.2014		13.0460-5650.2	605650	PLAQUETTES DE FREIN	58302-D4A65 , 58302-D4A55 , 58302-D7A70 , 58302-D3A70 , 58302-B2A10 , 58302-A4B60 , 58302-A4B10 , 58302-A6A20 , 58302-1WA35 , 58302-B4A30 , 58302-A6A31 , 58302-C8A30 , 58302-A6A30 , 58302-3XA30 , 58302-1RA30 , 58302-2VA50 , 58302-3ZA70	cf. Photo
	1,6 GDI		02.2014		13.0460-5650.2	605650	PLAQUETTES DE FREIN	58302-D4A65 , 58302-D4A55 , 58302-D7A70 , 58302-D3A70 , 58302-B2A10 , 58302-A4B60 , 58302-A4B10 , 58302-A6A20 , 58302-1WA35 , 58302-B4A30 , 58302-A6A31 , 58302-C8A30 , 58302-A6A30 , 58302-3XA30 , 58302-1RA30 , 58302-2VA50 , 58302-3ZA70	cf. Photo



description

Références OE
par référence
ATE.

i
Références remplacées /
divers

KIA

SOUL (14-)	2,0 CVVT		04.2014		13.0460-5650.2	605650	PLAQUETTES DE FREIN	58302-D4A65 , 58302-D4A55 , 58302-D7A70 , 58302-D3A70 , 58302-B2A10 , 58302-A4B60 , 58302-A4B10 , 58302-A6A20 , 58302-1WA35 , 58302-B4A30 , 58302-A6A31 , 58302-C8A30 , 58302-A6A30 , 58302-3XA30 , 58302-1RA30 , 58302-2VA50 , 58302-3ZA70	cf. Photo
SPORTAGE (15-)	1,6 GDI		09.2015		13.0460-5650.2	605650	PLAQUETTES DE FREIN	58302-D4A65 , 58302-D4A55 , 58302-D7A70 , 58302-D3A70 , 58302-B2A10 , 58302-A4B60 , 58302-A4B10 , 58302-A6A20 , 58302-1WA35 , 58302-B4A30 , 58302-A6A31 , 58302-C8A30 , 58302-A6A30 , 58302-3XA30 , 58302-1RA30 , 58302-2VA50 , 58302-3ZA70	cf. Photo
	1,6 GDI AWD		09.2015		13.0460-5650.2	605650	PLAQUETTES DE FREIN	58302-D4A65 , 58302-D4A55 , 58302-D7A70 , 58302-D3A70 , 58302-B2A10 , 58302-A4B60 , 58302-A4B10 , 58302-A6A20 , 58302-1WA35 , 58302-B4A30 , 58302-A6A31 , 58302-C8A30 , 58302-A6A30 , 58302-3XA30 , 58302-1RA30 , 58302-2VA50 , 58302-3ZA70	cf. Photo
	1,7 CRDi		09.2015		13.0460-5650.2	605650	PLAQUETTES DE FREIN	58302-D4A65 , 58302-D4A55 , 58302-D7A70 , 58302-D3A70 , 58302-B2A10 , 58302-A4B60 , 58302-A4B10 , 58302-A6A20 , 58302-1WA35 , 58302-B4A30 , 58302-A6A31 , 58302-C8A30 , 58302-A6A30 , 58302-3XA30 , 58302-1RA30 , 58302-2VA50 , 58302-3ZA70	cf. Photo



description

Références OE
par référence
ATE.

i
Références remplacées /
divers

KIA

SPORTAGE (15-)	1,7 CRDi		11.2016		13.0460-5650.2	605650	PLAQUETTES DE FREIN	58302-D4A65 , 58302-D4A55 , 58302-D7A70 , 58302-D3A70 , 58302-B2A10 , 58302-A4B60 , 58302-A4B10 , 58302-A6A20 , 58302-1WA35 , 58302-B4A30 , 58302-A6A31 , 58302-C8A30 , 58302-A6A30 , 58302-3XA30 , 58302-1RA30 , 58302-2VA50 , 58302-3ZA70	cf. Photo
	2,0 CRDi		09.2015		13.0460-5650.2	605650	PLAQUETTES DE FREIN	58302-D4A65 , 58302-D4A55 , 58302-D7A70 , 58302-D3A70 , 58302-B2A10 , 58302-A4B60 , 58302-A4B10 , 58302-A6A20 , 58302-1WA35 , 58302-B4A30 , 58302-A6A31 , 58302-C8A30 , 58302-A6A30 , 58302-3XA30 , 58302-1RA30 , 58302-2VA50 , 58302-3ZA70	cf. Photo
	2,0 CRDi AWD		09.2015		13.0460-5650.2	605650	PLAQUETTES DE FREIN	58302-D4A65 , 58302-D4A55 , 58302-D7A70 , 58302-D3A70 , 58302-B2A10 , 58302-A4B60 , 58302-A4B10 , 58302-A6A20 , 58302-1WA35 , 58302-B4A30 , 58302-A6A31 , 58302-C8A30 , 58302-A6A30 , 58302-3XA30 , 58302-1RA30 , 58302-2VA50 , 58302-3ZA70	cf. Photo



description

Références OE
par référence
ATE.



Références remplacées /
divers

MAZDA

2 (DJ) (14-)	1,5 D 105		11.2014		13.0460-5674.2	605674	PLAQUETTES DE FREIN	DBY1-33-28ZA , DBY1-33-28Z , DAY5-33-28ZA	cf. Photo
	1,5 G 115		11.2014		13.0460-5674.2	605674	PLAQUETTES DE FREIN	DBY1-33-28ZA , DBY1-33-28Z , DAY5-33-28ZA	cf. Photo
	1,5 G 75		11.2014		13.0460-5674.2	605674	PLAQUETTES DE FREIN	DBY1-33-28ZA , DBY1-33-28Z , DAY5-33-28ZA	cf. Photo
	1,5 G 90		11.2014		13.0460-5674.2	605674	PLAQUETTES DE FREIN	DBY1-33-28ZA , DBY1-33-28Z , DAY5-33-28ZA	cf. Photo



description

Références OE
par référence
ATE.

i
Références remplacées /
divers

MERCEDES BENZ

A-Klasse (W169) (04-12)	A 150 / A 160	ArD	08.2004	05.2012	24.3301-1704.5	240861	ETRIER A GRIFFE	A 169 420 16 83 , A 169 420 08 83 , 169 420 16 83 , 169 420 08 83	24.3301-1704.7
	A 160 CDI	ArD	08.2004	05.2012	24.3301-1704.5	240861	ETRIER A GRIFFE	A 169 420 16 83 , A 169 420 08 83 , 169 420 16 83 , 169 420 08 83	24.3301-1704.7
	A 170	ArD	08.2004	05.2012	24.3301-1704.5	240861	ETRIER A GRIFFE	A 169 420 16 83 , A 169 420 08 83 , 169 420 16 83 , 169 420 08 83	24.3301-1704.7
	A 180	ArD	04.2009	05.2012	24.3301-1704.5	240861	ETRIER A GRIFFE	A 169 420 16 83 , A 169 420 08 83 , 169 420 16 83 , 169 420 08 83	24.3301-1704.7
	A 180 CDI	ArD	08.2004	05.2012	24.3301-1704.5	240861	ETRIER A GRIFFE	A 169 420 16 83 , A 169 420 08 83 , 169 420 16 83 , 169 420 08 83	24.3301-1704.7
	A 200	ArD	08.2004	05.2012	24.3301-1704.5	240861	ETRIER A GRIFFE	A 169 420 16 83 , A 169 420 08 83 , 169 420 16 83 , 169 420 08 83	24.3301-1704.7
	A 200 CDI	ArD	08.2004	05.2012	24.3301-1704.5	240861	ETRIER A GRIFFE	A 169 420 16 83 , A 169 420 08 83 , 169 420 16 83 , 169 420 08 83	24.3301-1704.7
	A 200 Turbo	ArD	03.2005	05.2012	24.3301-1704.5	240861	ETRIER A GRIFFE	A 169 420 16 83 , A 169 420 08 83 , 169 420 16 83 , 169 420 08 83	24.3301-1704.7
B-Klasse (W245) (05-11)	B 150 / B 160	ArD	03.2005	04.2011	24.3301-1704.5	240861	ETRIER A GRIFFE	A 169 420 16 83 , A 169 420 08 83 , 169 420 16 83 , 169 420 08 83	24.3301-1704.7
	B 160 BlueEfficiency	ArD	04.2009	04.2011	24.3301-1704.5	240861	ETRIER A GRIFFE	A 169 420 16 83 , A 169 420 08 83 , 169 420 16 83 , 169 420 08 83	24.3301-1704.7
	B 170 / B 180	ArD	03.2005	04.2011	24.3301-1704.5	240861	ETRIER A GRIFFE	A 169 420 16 83 , A 169 420 08 83 , 169 420 16 83 , 169 420 08 83	24.3301-1704.7



description

Références OE
par référence
ATE.

i
Références remplacées /
divers

MERCEDES BENZ

B-Klasse (W245) (05-11)	B 170 NGT	ArD	04.2008	04.2009	24.3301-1704.5	240861	ETRIER A GRIFFE	A 169 420 16 83 , A 169 420 08 83 , 169 420 16 83 , 169 420 08 83	24.3301-1704.7
	B 180 BlueEfficiency	ArD	04.2009	04.2011	24.3301-1704.5	240861	ETRIER A GRIFFE	A 169 420 16 83 , A 169 420 08 83 , 169 420 16 83 , 169 420 08 83	24.3301-1704.7
	B 180 CDI	ArD	03.2005	04.2011	24.3301-1704.5	240861	ETRIER A GRIFFE	A 169 420 16 83 , A 169 420 08 83 , 169 420 16 83 , 169 420 08 83	24.3301-1704.7
	B 180 NGT	ArD	04.2009	04.2011	24.3301-1704.5	240861	ETRIER A GRIFFE	A 169 420 16 83 , A 169 420 08 83 , 169 420 16 83 , 169 420 08 83	24.3301-1704.7
	B 200	ArD	03.2005	04.2011	24.3301-1704.5	240861	ETRIER A GRIFFE	A 169 420 16 83 , A 169 420 08 83 , 169 420 16 83 , 169 420 08 83	24.3301-1704.7
	B 200 CDI	ArD	03.2005	04.2011	24.3301-1704.5	240861	ETRIER A GRIFFE	A 169 420 16 83 , A 169 420 08 83 , 169 420 16 83 , 169 420 08 83	24.3301-1704.7
	B 200 Turbo	ArD	03.2005	04.2011	24.3301-1704.5	240861	ETRIER A GRIFFE	A 169 420 16 83 , A 169 420 08 83 , 169 420 16 83 , 169 420 08 83	24.3301-1704.7
C-Klasse (A205) Cabrio (16-)	C 180		06.2016		24.0112-0300.1	412300	DISQUE DE FREIN	A 000 423 05 12 , 000 423 05 12	
			06.2016		24.0124-0300.1	424300	DISQUE DE FREIN	A 000 421 24 12 , 000 421 24 12	
	C 200		06.2016		24.0112-0300.1	412300	DISQUE DE FREIN	A 000 423 05 12 , 000 423 05 12	
	C 200 4-matic		06.2016		24.0112-0300.1	412300	DISQUE DE FREIN	A 000 423 05 12 , 000 423 05 12	
	C 220 d		06.2016		24.0112-0300.1	412300	DISQUE DE FREIN	A 000 423 05 12 , 000 423 05 12	



description

Références OE
par référence
ATE.

i
Références remplacées /
divers

MERCEDES BENZ

C-Klasse (A205) Cabrio (16-)	C 220 d 4-matic		06.2016		24.0112-0300.1	412300	DISQUE DE FREIN	A 000 423 05 12 , 000 423 05 12	
	C 250		06.2016		24.0112-0300.1	412300	DISQUE DE FREIN	A 000 423 05 12 , 000 423 05 12	
	C 250 d		06.2016		24.0112-0300.1	412300	DISQUE DE FREIN	A 000 423 05 12 , 000 423 05 12	
C-Klasse (C205) Coupe (15-)	C 180		10.2015		24.0124-0300.1	424300	DISQUE DE FREIN	A 000 421 24 12 , 000 421 24 12	
			10.2015		24.0112-0300.1	412300	DISQUE DE FREIN	A 000 423 05 12 , 000 423 05 12	
	C 200		10.2015		24.0112-0300.1	412300	DISQUE DE FREIN	A 000 423 05 12 , 000 423 05 12	
	C 200 4-matic		04.2016		24.0112-0300.1	412300	DISQUE DE FREIN	A 000 423 05 12 , 000 423 05 12	
	C 220 d		10.2015		24.0112-0300.1	412300	DISQUE DE FREIN	A 000 423 05 12 , 000 423 05 12	
	C 220 d 4-matic		04.2016		24.0112-0300.1	412300	DISQUE DE FREIN	A 000 423 05 12 , 000 423 05 12	
	C 250		10.2015		24.0112-0300.1	412300	DISQUE DE FREIN	A 000 423 05 12 , 000 423 05 12	
	C 250 d		10.2015		24.0112-0300.1	412300	DISQUE DE FREIN	A 000 423 05 12 , 000 423 05 12	
	C 250 d 4-matic		04.2016		24.0112-0300.1	412300	DISQUE DE FREIN	A 000 423 05 12 , 000 423 05 12	
C-Klasse (S205) Kombi (14-)	C 160		04.2015		24.0124-0300.1	424300	DISQUE DE FREIN	A 000 421 24 12 , 000 421 24 12	
			04.2015		24.0112-0300.1	412300	DISQUE DE FREIN	A 000 423 05 12 , 000 423 05 12	



description

Références OE
par référence
ATE.

i
Références remplacées /
divers

MERCEDES BENZ

C-Klasse (S205) Kombi (14-)	C 180		09.2014		24.0112-0300.1	412300	DISQUE DE FREIN	A 000 423 05 12 , 000 423 05 12	
			09.2014		24.0124-0300.1	424300	DISQUE DE FREIN	A 000 421 24 12 , 000 421 24 12	
	C 180 BlueTec		09.2014		24.0124-0300.1	424300	DISQUE DE FREIN	A 000 421 24 12 , 000 421 24 12	
			09.2014		24.0112-0300.1	412300	DISQUE DE FREIN	A 000 423 05 12 , 000 423 05 12	
	C 200		09.2014		24.0112-0300.1	412300	DISQUE DE FREIN	A 000 423 05 12 , 000 423 05 12	
	C 200 4-matic		04.2015		24.0112-0300.1	412300	DISQUE DE FREIN	A 000 423 05 12 , 000 423 05 12	
	C 200 BlueTec		09.2014		24.0112-0300.1	412300	DISQUE DE FREIN	A 000 423 05 12 , 000 423 05 12	
			09.2014		24.0124-0300.1	424300	DISQUE DE FREIN	A 000 421 24 12 , 000 421 24 12	
	C 200 d		10.2015		24.0112-0300.1	412300	DISQUE DE FREIN	A 000 423 05 12 , 000 423 05 12	
	C 220 BlueTec		09.2014		24.0112-0300.1	412300	DISQUE DE FREIN	A 000 423 05 12 , 000 423 05 12	
	C 220 d 4-matic		04.2015		24.0112-0300.1	412300	DISQUE DE FREIN	A 000 423 05 12 , 000 423 05 12	
	C 250 BlueTec		09.2014		24.0112-0300.1	412300	DISQUE DE FREIN	A 000 423 05 12 , 000 423 05 12	
	C 250 BlueTec 4-matic		10.2014		24.0112-0300.1	412300	DISQUE DE FREIN	A 000 423 05 12 , 000 423 05 12	
	C 250 CGI		09.2014		24.0112-0300.1	412300	DISQUE DE FREIN	A 000 423 05 12 , 000 423 05 12	



description

Références OE
par référence
ATE.

i
Références remplacées /
divers

MERCEDES BENZ

C-Klasse (W205) Limousine (14-)	C 160		04.2015		24.0112-0300.1	412300	DISQUE DE FREIN	A 000 423 05 12 , 000 423 05 12	
			04.2015		24.0124-0300.1	424300	DISQUE DE FREIN	A 000 421 24 12 , 000 421 24 12	
	C 180		02.2014		24.0112-0300.1	412300	DISQUE DE FREIN	A 000 423 05 12 , 000 423 05 12	
			02.2014		24.0124-0300.1	424300	DISQUE DE FREIN	A 000 421 24 12 , 000 421 24 12	
	C 180 BlueTec		05.2014		24.0112-0300.1	412300	DISQUE DE FREIN	A 000 423 05 12 , 000 423 05 12	
			05.2014		24.0124-0300.1	424300	DISQUE DE FREIN	A 000 421 24 12 , 000 421 24 12	
	C 200		02.2014		24.0112-0300.1	412300	DISQUE DE FREIN	A 000 423 05 12 , 000 423 05 12	
	C 200 4-matic		04.2015		24.0112-0300.1	412300	DISQUE DE FREIN	A 000 423 05 12 , 000 423 05 12	
	C 200 BlueTec		05.2014		24.0124-0300.1	424300	DISQUE DE FREIN	A 000 421 24 12 , 000 421 24 12	
			05.2014		24.0112-0300.1	412300	DISQUE DE FREIN	A 000 423 05 12 , 000 423 05 12	
	C 200 d		10.2015		24.0112-0300.1	412300	DISQUE DE FREIN	A 000 423 05 12 , 000 423 05 12	
	C 220 BlueTec		02.2014		24.0112-0300.1	412300	DISQUE DE FREIN	A 000 423 05 12 , 000 423 05 12	
			03.2014		24.0112-0300.1	412300	DISQUE DE FREIN	A 000 423 05 12 , 000 423 05 12	
	C 220 BlueTec 4-matic		04.2015		24.0112-0300.1	412300	DISQUE DE FREIN	A 000 423 05 12 , 000 423 05 12	



description

Références OE
par référence
ATE.

i
Références remplacées /
divers

MERCEDES BENZ

C-Klasse (W205) Limousine (14-)	C 250 BlueTec		02.2014		24.0112-0300.1	412300	DISQUE DE FREIN	A 000 423 05 12 , 000 423 05 12	
	C 250 BlueTec 4-matic		02.2014		24.0112-0300.1	412300	DISQUE DE FREIN	A 000 423 05 12 , 000 423 05 12	
	C 250 CGI		03.2014		24.0112-0300.1	412300	DISQUE DE FREIN	A 000 423 05 12 , 000 423 05 12	
Transporter (BM 906) SPRINTER (06-)	411 CDI	ArG	06.2009		24.0711-6396.3	360459	CAPTEUR DE ROUE	2E0 927 748 AA , 2E0 927 748 P , A 906 905 10 01 , A 906 540 43 17 , 906 905 10 01 , 906 540 43 17	
		ArD	06.2009		24.0711-6397.3	360460	CAPTEUR DE ROUE	2E0 927 748 AB , A 906 905 11 01 , A 906 540 44 17 , 906 905 11 01 , 906 540 44 17	
	413 CDI	ArD	04.2006		24.0711-6397.3	360460	CAPTEUR DE ROUE	2E0 927 748 AB , A 906 905 11 01 , A 906 540 44 17 , 906 905 11 01 , 906 540 44 17	
		ArG	04.2006		24.0711-6396.3	360459	CAPTEUR DE ROUE	2E0 927 748 AA , 2E0 927 748 P , A 906 905 10 01 , A 906 540 43 17 , 906 905 10 01 , 906 540 43 17	
	414 CDI	ArD	05.2016		24.0711-6397.3	360460	CAPTEUR DE ROUE	2E0 927 748 AB , A 906 905 11 01 , A 906 540 44 17 , 906 905 11 01 , 906 540 44 17	
		ArG	05.2016		24.0711-6396.3	360459	CAPTEUR DE ROUE	2E0 927 748 AA , 2E0 927 748 P , A 906 905 10 01 , A 906 540 43 17 , 906 905 10 01 , 906 540 43 17	
	415 CDI	ArG	04.2006		24.0711-6396.3	360459	CAPTEUR DE ROUE	2E0 927 748 AA , 2E0 927 748 P , A 906 905 10 01 , A 906 540 43 17 , 906 905 10 01 , 906 540 43 17	



description

Références OE
par référence
ATE.

i
Références remplacées /
divers

MERCEDES BENZ

Transporter (BM 906) SPRINTER (06-)	415 CDI	ArD	04.2006		24.0711-6397.3	360460	CAPTEUR DE ROUE	2E0 927 748 AB , A 906 905 11 01 , A 906 540 44 17 , 906 905 11 01 , 906 540 44 17
	416 CDI	ArG	03.2009		24.0711-6396.3	360459	CAPTEUR DE ROUE	2E0 927 748 AA , 2E0 927 748 P , A 906 905 10 01 , A 906 540 43 17 , 906 905 10 01 , 906 540 43 17
		ArD	03.2009		24.0711-6397.3	360460	CAPTEUR DE ROUE	2E0 927 748 AB , A 906 905 11 01 , A 906 540 44 17 , 906 905 11 01 , 906 540 44 17
	418 CDI	ArD	04.2006		24.0711-6397.3	360460	CAPTEUR DE ROUE	2E0 927 748 AB , A 906 905 11 01 , A 906 540 44 17 , 906 905 11 01 , 906 540 44 17
		ArG	04.2006		24.0711-6396.3	360459	CAPTEUR DE ROUE	2E0 927 748 AA , 2E0 927 748 P , A 906 905 10 01 , A 906 540 43 17 , 906 905 10 01 , 906 540 43 17
	419 CDI	ArD	03.2009		24.0711-6397.3	360460	CAPTEUR DE ROUE	2E0 927 748 AB , A 906 905 11 01 , A 906 540 44 17 , 906 905 11 01 , 906 540 44 17
		ArG	03.2009		24.0711-6396.3	360459	CAPTEUR DE ROUE	2E0 927 748 AA , 2E0 927 748 P , A 906 905 10 01 , A 906 540 43 17 , 906 905 10 01 , 906 540 43 17
	424	ArD	04.2006		24.0711-6397.3	360460	CAPTEUR DE ROUE	2E0 927 748 AB , A 906 905 11 01 , A 906 540 44 17 , 906 905 11 01 , 906 540 44 17
		ArG	04.2006		24.0711-6396.3	360459	CAPTEUR DE ROUE	2E0 927 748 AA , 2E0 927 748 P , A 906 905 10 01 , A 906 540 43 17 , 906 905 10 01 , 906 540 43 17



description

Références OE
par référence
ATE.

i
Références remplacées /
divers

MERCEDES BENZ

Transporter (BM 906) SPRINTER (06-)	509 CDI	ArG	04.2006		24.0711-6396.3	360459	CAPTEUR DE ROUE	2E0 927 748 AA , 2E0 927 748 P , A 906 905 10 01 , A 906 540 43 17 , 906 905 10 01 , 906 540 43 17	
		ArD	04.2006		24.0711-6397.3	360460	CAPTEUR DE ROUE	2E0 927 748 AB , A 906 905 11 01 , A 906 540 44 17 , 906 905 11 01 , 906 540 44 17	
	510 CDI	ArD	03.2009		24.0711-6397.3	360460	CAPTEUR DE ROUE	2E0 927 748 AB , A 906 905 11 01 , A 906 540 44 17 , 906 905 11 01 , 906 540 44 17	
		ArG	03.2009		24.0711-6396.3	360459	CAPTEUR DE ROUE	2E0 927 748 AA , 2E0 927 748 P , A 906 905 10 01 , A 906 540 43 17 , 906 905 10 01 , 906 540 43 17	
	511 CDI	ArG	04.2006		24.0711-6396.3	360459	CAPTEUR DE ROUE	2E0 927 748 AA , 2E0 927 748 P , A 906 905 10 01 , A 906 540 43 17 , 906 905 10 01 , 906 540 43 17	
		ArD	04.2006		24.0711-6397.3	360460	CAPTEUR DE ROUE	2E0 927 748 AB , A 906 905 11 01 , A 906 540 44 17 , 906 905 11 01 , 906 540 44 17	
	511 CDI 4x4	ArD	06.2006		24.0711-6397.3	360460	CAPTEUR DE ROUE	2E0 927 748 AB , A 906 905 11 01 , A 906 540 44 17 , 906 905 11 01 , 906 540 44 17	
		ArG	06.2006		24.0711-6396.3	360459	CAPTEUR DE ROUE	2E0 927 748 AA , 2E0 927 748 P , A 906 905 10 01 , A 906 540 43 17 , 906 905 10 01 , 906 540 43 17	
	513 CDI	ArD	03.2009		24.0711-6397.3	360460	CAPTEUR DE ROUE	2E0 927 748 AB , A 906 905 11 01 , A 906 540 44 17 , 906 905 11 01 , 906 540 44 17	



description

Références OE
par référence
ATE.

i
Références remplacées /
divers

MERCEDES BENZ

Transporter (BM 906) SPRINTER (06-)	513 CDI	ArG	03.2009		24.0711-6396.3	360459	CAPTEUR DE ROUE	2E0 927 748 AA , 2E0 927 748 P , A 906 905 10 01 , A 906 540 43 17 , 906 905 10 01 , 906 540 43 17	
	513 CDI 4x4	ArG	06.2006		24.0711-6396.3	360459	CAPTEUR DE ROUE	2E0 927 748 AA , 2E0 927 748 P , A 906 905 10 01 , A 906 540 43 17 , 906 905 10 01 , 906 540 43 17	
		ArD	06.2006		24.0711-6397.3	360460	CAPTEUR DE ROUE	2E0 927 748 AB , A 906 905 11 01 , A 906 540 44 17 , 906 905 11 01 , 906 540 44 17	
	514 CDI	ArG	05.2016		24.0711-6396.3	360459	CAPTEUR DE ROUE	2E0 927 748 AA , 2E0 927 748 P , A 906 905 10 01 , A 906 540 43 17 , 906 905 10 01 , 906 540 43 17	
		ArD	05.2016		24.0711-6397.3	360460	CAPTEUR DE ROUE	2E0 927 748 AB , A 906 905 11 01 , A 906 540 44 17 , 906 905 11 01 , 906 540 44 17	
	514 CDI 4x4	ArD	05.2016		24.0711-6397.3	360460	CAPTEUR DE ROUE	2E0 927 748 AB , A 906 905 11 01 , A 906 540 44 17 , 906 905 11 01 , 906 540 44 17	
		ArG	05.2016		24.0711-6396.3	360459	CAPTEUR DE ROUE	2E0 927 748 AA , 2E0 927 748 P , A 906 905 10 01 , A 906 540 43 17 , 906 905 10 01 , 906 540 43 17	
	515 CDI	ArG	04.2006		24.0711-6396.3	360459	CAPTEUR DE ROUE	2E0 927 748 AA , 2E0 927 748 P , A 906 905 10 01 , A 906 540 43 17 , 906 905 10 01 , 906 540 43 17	
		ArD	04.2006		24.0711-6397.3	360460	CAPTEUR DE ROUE	2E0 927 748 AB , A 906 905 11 01 , A 906 540 44 17 , 906 905 11 01 , 906 540 44 17	



description

Références OE
par référence
ATE.

i
Références remplacées /
divers

MERCEDES BENZ

Transporter (BM 906) SPRINTER (06-)	515 CDI 4x4	ArG	06.2006		24.0711-6396.3	360459	CAPTEUR DE ROUE	2E0 927 748 AA , 2E0 927 748 P , A 906 905 10 01 , A 906 540 43 17 , 906 905 10 01 , 906 540 43 17	
		ArD	06.2006		24.0711-6397.3	360460	CAPTEUR DE ROUE	2E0 927 748 AB , A 906 905 11 01 , A 906 540 44 17 , 906 905 11 01 , 906 540 44 17	
	516	ArG	09.2008		24.0711-6396.3	360459	CAPTEUR DE ROUE	2E0 927 748 AA , 2E0 927 748 P , A 906 905 10 01 , A 906 540 43 17 , 906 905 10 01 , 906 540 43 17	
		ArD	09.2008		24.0711-6397.3	360460	CAPTEUR DE ROUE	2E0 927 748 AB , A 906 905 11 01 , A 906 540 44 17 , 906 905 11 01 , 906 540 44 17	
	516 CDI	ArG	03.2009		24.0711-6396.3	360459	CAPTEUR DE ROUE	2E0 927 748 AA , 2E0 927 748 P , A 906 905 10 01 , A 906 540 43 17 , 906 905 10 01 , 906 540 43 17	
		ArD	03.2009		24.0711-6397.3	360460	CAPTEUR DE ROUE	2E0 927 748 AB , A 906 905 11 01 , A 906 540 44 17 , 906 905 11 01 , 906 540 44 17	
	516 CDI 4x4	ArG	06.2006		24.0711-6396.3	360459	CAPTEUR DE ROUE	2E0 927 748 AA , 2E0 927 748 P , A 906 905 10 01 , A 906 540 43 17 , 906 905 10 01 , 906 540 43 17	
		ArD	06.2006		24.0711-6397.3	360460	CAPTEUR DE ROUE	2E0 927 748 AB , A 906 905 11 01 , A 906 540 44 17 , 906 905 11 01 , 906 540 44 17	
	516 NGT	ArG	09.2008		24.0711-6396.3	360459	CAPTEUR DE ROUE	2E0 927 748 AA , 2E0 927 748 P , A 906 905 10 01 , A 906 540 43 17 , 906 905 10 01 , 906 540 43 17	



description

Références OE
par référence
ATE.



Références remplacées /
divers

MERCEDES BENZ

Transporter (BM 906) SPRINTER (06-)	516 NGT	ArD	09.2008		24.0711-6397.3	360460	CAPTEUR DE ROUE	2E0 927 748 AB , A 906 905 11 01 , A 906 540 44 17 , 906 905 11 01 , 906 540 44 17	
	518 CDI	ArG	04.2006		24.0711-6396.3	360459	CAPTEUR DE ROUE	2E0 927 748 AA , 2E0 927 748 P , A 906 905 10 01 , A 906 540 43 17 , 906 905 10 01 , 906 540 43 17	
		ArD	04.2006		24.0711-6397.3	360460	CAPTEUR DE ROUE	2E0 927 748 AB , A 906 905 11 01 , A 906 540 44 17 , 906 905 11 01 , 906 540 44 17	
	518 CDI 4x4	ArG	06.2006		24.0711-6396.3	360459	CAPTEUR DE ROUE	2E0 927 748 AA , 2E0 927 748 P , A 906 905 10 01 , A 906 540 43 17 , 906 905 10 01 , 906 540 43 17	
		ArD	06.2006		24.0711-6397.3	360460	CAPTEUR DE ROUE	2E0 927 748 AB , A 906 905 11 01 , A 906 540 44 17 , 906 905 11 01 , 906 540 44 17	
	519 CDI	ArG	03.2009		24.0711-6396.3	360459	CAPTEUR DE ROUE	2E0 927 748 AA , 2E0 927 748 P , A 906 905 10 01 , A 906 540 43 17 , 906 905 10 01 , 906 540 43 17	
		ArD	03.2009		24.0711-6397.3	360460	CAPTEUR DE ROUE	2E0 927 748 AB , A 906 905 11 01 , A 906 540 44 17 , 906 905 11 01 , 906 540 44 17	
	519 CDI 4x4	ArD	03.2009		24.0711-6397.3	360460	CAPTEUR DE ROUE	2E0 927 748 AB , A 906 905 11 01 , A 906 540 44 17 , 906 905 11 01 , 906 540 44 17	
		ArG	03.2009		24.0711-6396.3	360459	CAPTEUR DE ROUE	2E0 927 748 AA , 2E0 927 748 P , A 906 905 10 01 , A 906 540 43 17 , 906 905 10 01 , 906 540 43 17	



					<p>description</p>	<p>Références OE par référence ATE.</p>	 Références remplacées / divers
---	---	---	--	---	--------------------	---	--

MERCEDES BENZ

Transporter (BM 906) SPRINTER (06-)	524	ArD	04.2006		24.0711-6397.3	360460	CAPTEUR DE ROUE	2E0 927 748 AB , A 906 905 11 01 , A 906 540 44 17 , 906 905 11 01 , 906 540 44 17	
		ArG	04.2006		24.0711-6396.3	360459	CAPTEUR DE ROUE	2E0 927 748 AA , 2E0 927 748 P , A 906 905 10 01 , A 906 540 43 17 , 906 905 10 01 , 906 540 43 17	



description

Références OE
par référence
ATE.



Références remplacées /
divers

OPEL

ASTRA K / Vauxhall Astra Mk VII (15-)	1,0 Turbo		06.2015		24.0126-0188.1	426188	DISQUE DE FREIN	13597467	
	1,4 LPG		11.2015		24.0126-0188.1	426188	DISQUE DE FREIN	13597467	
	1,4 Turbo		11.2015		24.0126-0188.1	426188	DISQUE DE FREIN	13597467	
			06.2015		24.0126-0188.1	426188	DISQUE DE FREIN	13597467	
	1,6		11.2015		24.0126-0188.1	426188	DISQUE DE FREIN	13597467	
	1,6 CDTI		06.2015		24.0126-0188.1	426188	DISQUE DE FREIN	13597467	
			11.2015		24.0126-0188.1	426188	DISQUE DE FREIN	13597467	
	1,6 Turbo		11.2015		24.0126-0188.1	426188	DISQUE DE FREIN	13597467	
ASTRA K Sports Tourer/Vau.Astra Mk VII Sp. Tourer (15-)	1		11.2015		24.0126-0188.1	426188	DISQUE DE FREIN	13597467	
	1,4		11.2015		24.0126-0188.1	426188	DISQUE DE FREIN	13597467	
	1,4 Turbo		11.2015		24.0126-0188.1	426188	DISQUE DE FREIN	13597467	
	1,6 CDTi		11.2015		24.0126-0188.1	426188	DISQUE DE FREIN	13597467	
	1,6 Turbo		11.2015		24.0126-0188.1	426188	DISQUE DE FREIN	13597467	
KARL / Vauxhall Viva (15-)	1		01.2015		24.0120-0249.1	420249	DISQUE DE FREIN	13584676 , 5 69 130	
	1,0 LPG		02.2015		24.0120-0249.1	420249	DISQUE DE FREIN	13584676 , 5 69 130	



description

Références OE
par référence
ATE.

i
Références remplacées /
divers

PEUGEOT

308 II (T9) (13-)	1,2 THP 110		11.2013		13.0470-3869.2	LD3869	CERAMIC PLAO. FREIN	16 106 992 80	
	1,2 THP 130		11.2013		13.0470-3869.2	LD3869	CERAMIC PLAO. FREIN	16 106 992 80	
	1,2 VTi 82		09.2013		13.0470-3869.2	LD3869	CERAMIC PLAO. FREIN	16 106 992 80	
	1,6 GT 205		06.2014		13.0470-3869.2	LD3869	CERAMIC PLAO. FREIN	16 106 992 80	
	1,6 GTi 250		08.2015		13.0470-3869.2	LD3869	CERAMIC PLAO. FREIN	16 106 992 80	
	1,6 GTi 270		06.2015		13.0470-3869.2	LD3869	CERAMIC PLAO. FREIN	16 106 992 80	
	1,6 HDi 100		04.2014		13.0470-3869.2	LD3869	CERAMIC PLAO. FREIN	16 106 992 80	
	1,6 HDi 115		09.2013		13.0470-3869.2	LD3869	CERAMIC PLAO. FREIN	16 106 992 80	
	1,6 HDi 120		11.2013		13.0470-3869.2	LD3869	CERAMIC PLAO. FREIN	16 106 992 80	
	1,6 HDi 92		09.2013		13.0470-3869.2	LD3869	CERAMIC PLAO. FREIN	16 106 992 80	
	1,6 THP 125		09.2013		13.0470-3869.2	LD3869	CERAMIC PLAO. FREIN	16 106 992 80	
	1,6 THP 150		03.2014		13.0470-3869.2	LD3869	CERAMIC PLAO. FREIN	16 106 992 80	
	1,6 THP 155		09.2013		13.0470-3869.2	LD3869	CERAMIC PLAO. FREIN	16 106 992 80	
	1,6 THP 163		06.2014		13.0470-3869.2	LD3869	CERAMIC PLAO. FREIN	16 106 992 80	
	1,6 VTi		03.2014		13.0470-3869.2	LD3869	CERAMIC PLAO. FREIN	16 106 992 80	
	2,0 GT HDi 180		06.2014		13.0470-3869.2	LD3869	CERAMIC PLAO. FREIN	16 106 992 80	
	2,0 HDi 150		11.2013		13.0470-3869.2	LD3869	CERAMIC PLAO. FREIN	16 106 992 80	
308 II SW (T9) (14-)	1,2 e-THP		03.2014		13.0470-3869.2	LD3869	CERAMIC PLAO. FREIN	16 106 992 80	
			08.2014		13.0470-3869.2	LD3869	CERAMIC PLAO. FREIN	16 106 992 80	
	1,6 BlueHDi		03.2014		13.0470-3869.2	LD3869	CERAMIC PLAO. FREIN	16 106 992 80	
	1,6 e-HDi		03.2014		13.0470-3869.2	LD3869	CERAMIC PLAO. FREIN	16 106 992 80	



description

Références OE
par référence
ATE.



Références remplacées /
divers

PEUGEOT

308 II SW (T9) (14-)	1,6 GT 205		06.2014		13.0470-3869.2	LD3869	CERAMIC PLAO. FREIN	16 106 992 80	
	1,6 HDi		03.2014		13.0470-3869.2	LD3869	CERAMIC PLAO. FREIN	16 106 992 80	
	1,6 THP		03.2014		13.0470-3869.2	LD3869	CERAMIC PLAO. FREIN	16 106 992 80	
	1,6 THP 125		03.2014		13.0470-3869.2	LD3869	CERAMIC PLAO. FREIN	16 106 992 80	
	1,6 THP 150		03.2014		13.0470-3869.2	LD3869	CERAMIC PLAO. FREIN	16 106 992 80	
	1,6 THP 163		06.2014		13.0470-3869.2	LD3869	CERAMIC PLAO. FREIN	16 106 992 80	
	1,6 VTi		03.2014		13.0470-3869.2	LD3869	CERAMIC PLAO. FREIN	16 106 992 80	
	2,0 BlueHDi		03.2014		13.0470-3869.2	LD3869	CERAMIC PLAO. FREIN	16 106 992 80	
	2,0 BlueHDi 180		06.2014		13.0470-3869.2	LD3869	CERAMIC PLAO. FREIN	16 106 992 80	
	2,0 GT HDi 180		06.2014		13.0470-3869.2	LD3869	CERAMIC PLAO. FREIN	16 106 992 80	

SEAT

EXEO / ST (09-13)	1,6	ArD	04.2009	06.2013	24.3384-1736.5	240823	ETRIER A GRIFFE	8E0 615 424 G , 8E0 615 424 B	24.3384-1736.7
	1,8 T	ArD	04.2009	06.2013	24.3384-1736.5	240823	ETRIER A GRIFFE	8E0 615 424 G , 8E0 615 424 B	24.3384-1736.7
	1,8 TSI	ArD	05.2010	06.2013	24.3384-1736.5	240823	ETRIER A GRIFFE	8E0 615 424 G , 8E0 615 424 B	24.3384-1736.7
		ArD	09.2010	06.2013	24.3384-1736.5	240823	ETRIER A GRIFFE	8E0 615 424 G , 8E0 615 424 B	24.3384-1736.7
	2,0 TDI	ArD	04.2009	06.2013	24.3384-1736.5	240823	ETRIER A GRIFFE	8E0 615 424 G , 8E0 615 424 B	24.3384-1736.7
	2,0 TFSI	ArD	04.2009	06.2013	24.3384-1736.5	240823	ETRIER A GRIFFE	8E0 615 424 G , 8E0 615 424 B	24.3384-1736.7



description

Références OE
par référence
ATE.

i
Références remplacées /
divers

SUZUKI

SX4 (13-)	1,6 16V		08.2013		13.0460-5656.2	605656	PLAQUETTES DE FREIN	55810-61M00	cf. Photo
	1,6 16V 4x4		08.2013		13.0460-5656.2	605656	PLAQUETTES DE FREIN	55810-61M00	cf. Photo
	1,6 DDiS		08.2013		13.0460-5656.2	605656	PLAQUETTES DE FREIN	55810-61M00	cf. Photo
	1,6 DDiS 4x4		08.2013		13.0460-5656.2	605656	PLAQUETTES DE FREIN	55810-61M00	cf. Photo
VITARA (LY) (15-)	1,6 16V		02.2015		13.0460-5656.2	605656	PLAQUETTES DE FREIN	55810-61M00	cf. Photo
	1,6 16V 4x4		02.2015		13.0460-5656.2	605656	PLAQUETTES DE FREIN	55810-61M00	cf. Photo
			05.2015		13.0460-5656.2	605656	PLAQUETTES DE FREIN	55810-61M00	cf. Photo
	1,6 DDiS		02.2015		13.0460-5656.2	605656	PLAQUETTES DE FREIN	55810-61M00	cf. Photo
	1,6 DDiS 4x4		02.2015		13.0460-5656.2	605656	PLAQUETTES DE FREIN	55810-61M00	cf. Photo

TOYOTA

LAND CRUISER 150 (10-)	2,7 4WD		01.2010		24.0132-0187.1	432187	DISQUE DE FREIN	43512-60191	
	2,8 D-4D		06.2015		24.0132-0187.1	432187	DISQUE DE FREIN	43512-60191	
	3,0 D-4D		01.2010		24.0132-0187.1	432187	DISQUE DE FREIN	43512-60191	
			03.2010		24.0132-0187.1	432187	DISQUE DE FREIN	43512-60191	
	3,0 TDi		01.2010		24.0132-0187.1	432187	DISQUE DE FREIN	43512-60191	
	4,0 V6 Dual VVTi		01.2010		24.0132-0187.1	432187	DISQUE DE FREIN	43512-60191	
	4,0 V6 VVTi		01.2010		24.0132-0187.1	432187	DISQUE DE FREIN	43512-60191	
PRIUS PLUS (12-)	1,8 Hybrid (ZVW40)		03.2012		03.0137-3050.2	653050	JEU DE MACHOIRE	46590-47020 , 46550-47020 , 46540-47020	



description

Références OE
par référence
ATE.

i
Références remplacées /
divers

VOLKSWAGEN

CRAFTER (06-16)	2,0 TDI	ArD	11.2015		24.0711-6397.3	360460	CAPTEUR DE ROUE	2E0 927 748 AB , A 906 905 11 01 , A 906 540 44 17 , 906 905 11 01 , 906 540 44 17	
		ArG	11.2015		24.0711-6396.3	360459	CAPTEUR DE ROUE	2E0 927 748 AA , 2E0 927 748 P , A 906 905 10 01 , A 906 540 43 17 , 906 905 10 01 , 906 540 43 17	
		ArG	11.2015		24.0711-6396.3	360459	CAPTEUR DE ROUE	2E0 927 748 AA , 2E0 927 748 P , A 906 905 10 01 , A 906 540 43 17 , 906 905 10 01 , 906 540 43 17	
	2,0 TDI 4motion	ArG	11.2011		24.0711-6396.3	360459	CAPTEUR DE ROUE	2E0 927 748 AA , 2E0 927 748 P , A 906 905 10 01 , A 906 540 43 17 , 906 905 10 01 , 906 540 43 17	
	2,0 TDI BlueMotion	ArG	07.2011		24.0711-6396.3	360459	CAPTEUR DE ROUE	2E0 927 748 AA , 2E0 927 748 P , A 906 905 10 01 , A 906 540 43 17 , 906 905 10 01 , 906 540 43 17	
		ArG	07.2011		24.0711-6396.3	360459	CAPTEUR DE ROUE	2E0 927 748 AA , 2E0 927 748 P , A 906 905 10 01 , A 906 540 43 17 , 906 905 10 01 , 906 540 43 17	
		ArD	07.2011		24.0711-6397.3	360460	CAPTEUR DE ROUE	2E0 927 748 AB , A 906 905 11 01 , A 906 540 44 17 , 906 905 11 01 , 906 540 44 17	
	2,5 TDI	ArD	04.2006		24.0711-6397.3	360460	CAPTEUR DE ROUE	2E0 927 748 AB , A 906 905 11 01 , A 906 540 44 17 , 906 905 11 01 , 906 540 44 17	
		ArG	04.2006		24.0711-6396.3	360459	CAPTEUR DE ROUE	2E0 927 748 AA , 2E0 927 748 P , A 906 905 10 01 , A 906 540 43 17 , 906 905 10 01 , 906 540 43 17	



				<p>description</p>	<p>Références OE par référence ATE.</p>	 <p>Références remplacées / divers</p>
---	---	--	---	--------------------	---	---

VOLKSWAGEN

CRAFTER (06-16)	2,5 TDI	ArG	04.2006		24.0711-6396.3	360459	CAPTEUR DE ROUE	2E0 927 748 AA , 2E0 927 748 P , A 906 905 10 01 , A 906 540 43 17 , 906 905 10 01 , 906 540 43 17	
-----------------	---------	-----	---------	--	----------------	--------	-----------------	--	--



description

Références OE
par référence
ATE.



Références remplacées /
divers

VOLVO

C30 Coupe (06-12)	1,6 D2		10.2010	12.2012	03.2123-3624.3	010956	TANDEM MASTER CYLINDE	36001230	
	2,0 D3		10.2010	12.2012	03.2123-3624.3	010956	TANDEM MASTER CYLINDE	36001230	
	2,0 D4		10.2010	12.2012	03.2123-3624.3	010956	TANDEM MASTER CYLINDE	36001230	
C70 II Cabrio (06-13)	2,0 D3		10.2010	07.2013	03.2123-3624.3	010956	TANDEM MASTER CYLINDE	36001230	
	2,0 D4		10.2010	07.2013	03.2123-3624.3	010956	TANDEM MASTER CYLINDE	36001230	
S40 II (04-12)	1,6 D2		10.2010	05.2012	03.2123-3624.3	010956	TANDEM MASTER CYLINDE	36001230	
	2,0 D3		10.2010	05.2012	03.2123-3624.3	010956	TANDEM MASTER CYLINDE	36001230	
	2,0 D4		10.2010	05.2012	03.2123-3624.3	010956	TANDEM MASTER CYLINDE	36001230	
V50 (04-12)	1,6 D2		01.2010	05.2012	03.2123-3624.3	010956	TANDEM MASTER CYLINDE	36001230	
	2,0 D3		10.2010	05.2012	03.2123-3624.3	010956	TANDEM MASTER CYLINDE	36001230	
	2,0 D4		10.2010	05.2012	03.2123-3624.3	010956	TANDEM MASTER CYLINDE	36001230	
XC90 (14-)	2,0 D5 AWD		09.2014		24.0130-0242.1	430242	DISQUE DE FREIN	31400569	
	2,0 T5 AWD		06.2015		24.0130-0242.1	430242	DISQUE DE FREIN	31400569	
	2,0 T6 AWD		09.2014		24.0130-0242.1	430242	DISQUE DE FREIN	31400569	
	2,0 T8 Hybrid		09.2014		24.0130-0242.1	430242	DISQUE DE FREIN	31400569	
	D4		09.2014		24.0130-0242.1	430242	DISQUE DE FREIN	31400569	
	D4 AWD		09.2014		24.0130-0242.1	430242	DISQUE DE FREIN	31400569	
	D5 AWD		09.2014		24.0130-0242.1	430242	DISQUE DE FREIN	31400569	

13.0460-5650.2 605650

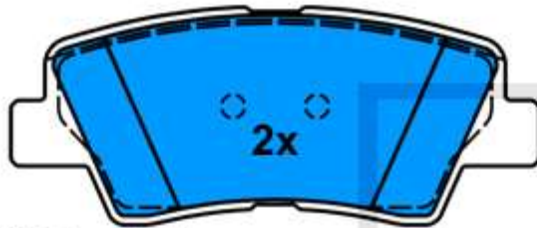

25337 15,5

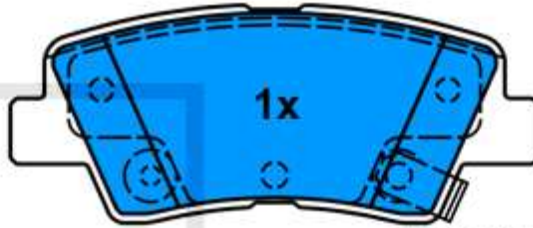

25338 15,5

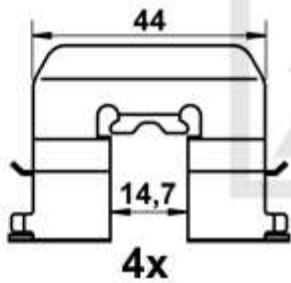

4x

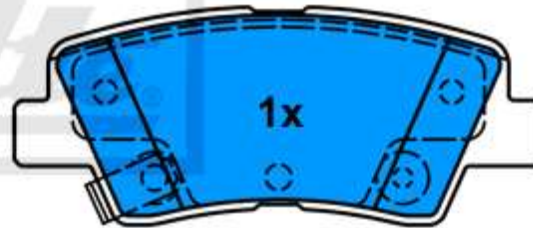

25339 15,5

99,8 x 41,1

Applications:

HYUNDAI ACCENT IV (10-)
KIA CARENS IV (13-)
KIA CEE'D (12-)
HYUNDAI ELANTRA (MD/UD) (11-15)
HYUNDAI i10 (13-)
HYUNDAI i20 / i20 COUPE (GB) (14-)
HYUNDAI i20 ACTIVE (GB) (15-)
HYUNDAI i30 (GD) (11-17)
HYUNDAI i30 COUPE (13-)
HYUNDAI i30 CW Kombi (12-)
HYUNDAI i40 (12-)
HYUNDAI i40 CW Kombi (11-)
KIA OPTIMA (TF) (10-15)
KIA OPTIMA / OPTIMA SW (JF) (15-)
KIA PRO CEE'D (13-)
KIA RIO III (UB) (11-17)
KIA SOUL (14-)
KIA SPORTAGE (15-)
HYUNDAI TUCSON (15-)
HYUNDAI VELOSTER (11-)

13.0460-5656.2 605656

Applications:

SUZUKI SX4 (13-)
SUZUKI VITARA (LY) (15-)

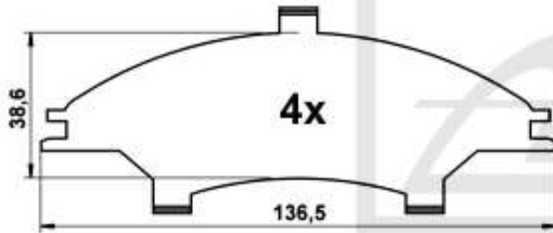
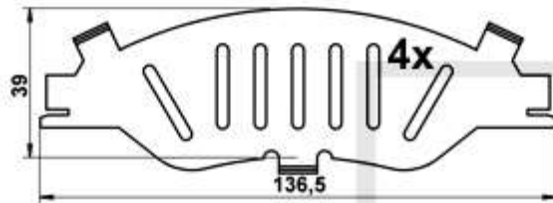

25979 16,0

142,0 x 55,1



13.0460-5659.2 605659

Applications:

KIA CERATO KOUP (09-)
KIA OPTIMA (TF) (10-15)

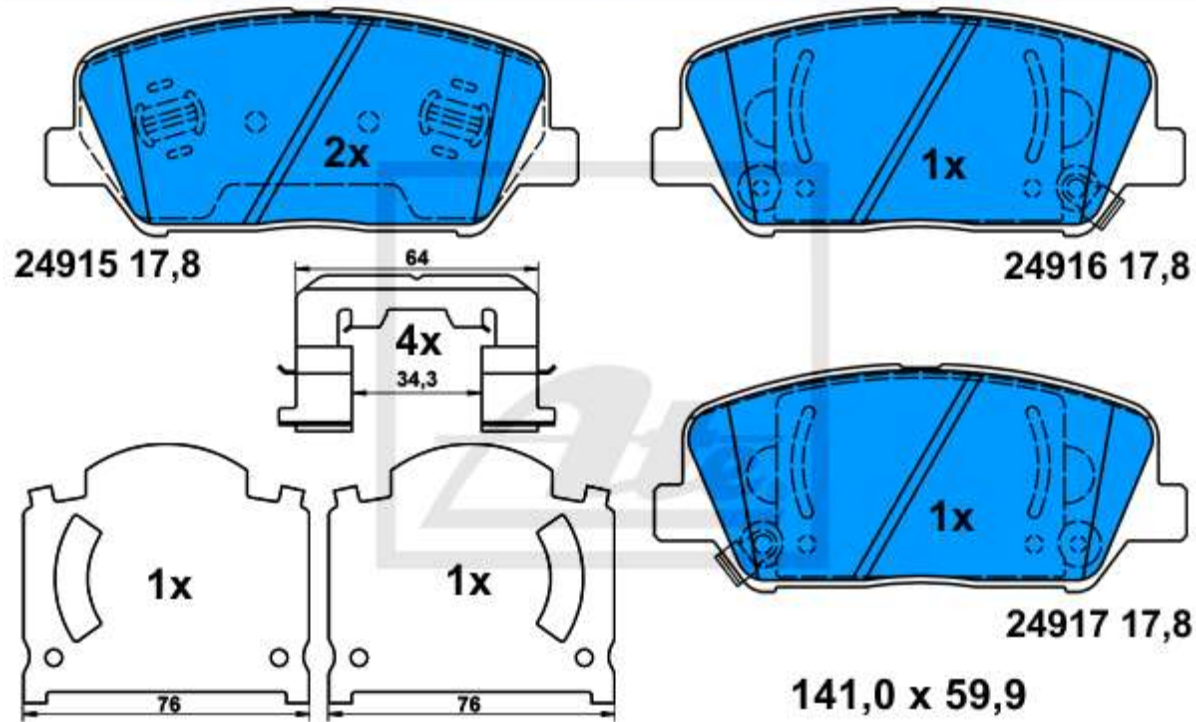

13.0460-5653.2 605653

Applications:
HYUNDAI i10 (13-)

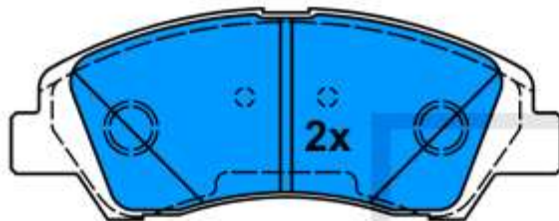

25976 16,6

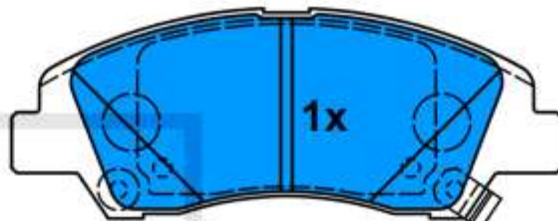

25977 16,6

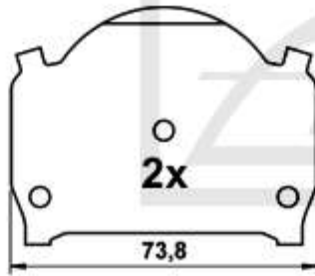
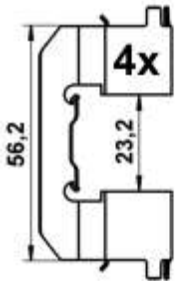

132,5 x 50,1

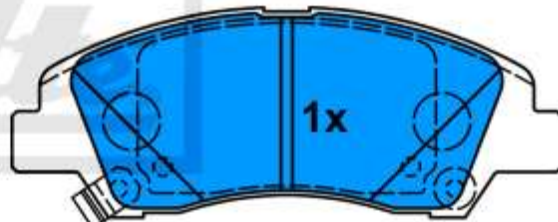

25978 16,6

13.0460-5674.2 605674

Applications:
MAZDA 2 (DJ) (14-)

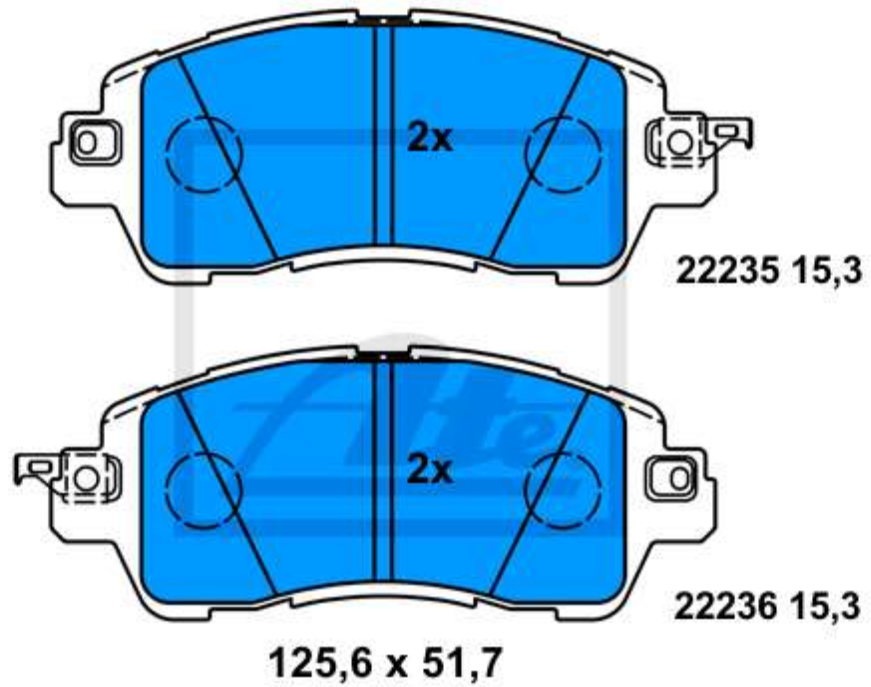

13.0460-2603.2 602603

Applications:

CITROEN C4 II Limousine (B7) (10-)

