



# Nouvelles références disponibles

par applications

09/2017

[www.ate.de](http://www.ate.de)





description

Références OE  
par référence  
ATE.

**i**  
Références remplacées /  
divers

## AUDI

A3 (8P) Cabrio (08-13)	1,2 TSI	ArD	03.2010	08.2013	24.3387-1718.5	240873	ETRIER A GRIFFE	1K0 615 424 N , 8J0 615 424 , 8J0 615 424 C , 1K0 615 424 L , 1K0 615 424 E	24.3387-1718.7
	1,4 TFSI	ArD	01.2011	08.2013	24.3387-1718.5	240873	ETRIER A GRIFFE	1K0 615 424 N , 8J0 615 424 , 8J0 615 424 C , 1K0 615 424 L , 1K0 615 424 E	24.3387-1718.7
	1,6	ArD	09.2008	08.2013	24.3387-1718.5	240873	ETRIER A GRIFFE	1K0 615 424 N , 8J0 615 424 , 8J0 615 424 C , 1K0 615 424 L , 1K0 615 424 E	24.3387-1718.7
	1,6 TDI	ArD	05.2009	08.2013	24.3387-1718.5	240873	ETRIER A GRIFFE	1K0 615 424 N , 8J0 615 424 , 8J0 615 424 C , 1K0 615 424 L , 1K0 615 424 E	24.3387-1718.7
	1,8 TFSI	ArD	04.2008	08.2013	24.3387-1718.5	240873	ETRIER A GRIFFE	1K0 615 424 N , 8J0 615 424 , 8J0 615 424 C , 1K0 615 424 L , 1K0 615 424 E	24.3387-1718.7
	1,9 TDI	ArD	04.2008	08.2013	24.3387-1718.5	240873	ETRIER A GRIFFE	1K0 615 424 N , 8J0 615 424 , 8J0 615 424 C , 1K0 615 424 L , 1K0 615 424 E	24.3387-1718.7
	2,0 TDI	ArD	04.2008	08.2013	24.3387-1718.5	240873	ETRIER A GRIFFE	1K0 615 424 N , 8J0 615 424 , 8J0 615 424 C , 1K0 615 424 L , 1K0 615 424 E	24.3387-1718.7
	2,0 TFSI	ArD	04.2008	08.2013	24.3387-1718.5	240873	ETRIER A GRIFFE	1K0 615 424 N , 8J0 615 424 , 8J0 615 424 C , 1K0 615 424 L , 1K0 615 424 E	24.3387-1718.7
A3 / A3 (8P) Sportback (03-13)	1,2 TSI	ArD	04.2010	08.2013	24.3387-1718.5	240873	ETRIER A GRIFFE	1K0 615 424 N , 8J0 615 424 , 8J0 615 424 C , 1K0 615 424 L , 1K0 615 424 E	24.3387-1718.7
	1,4 TFSI	ArD	07.2007	08.2013	24.3387-1718.5	240873	ETRIER A GRIFFE	1K0 615 424 N , 8J0 615 424 , 8J0 615 424 C , 1K0 615 424 L , 1K0 615 424 E	24.3387-1718.7
	1,6	ArD	05.2003	08.2013	24.3387-1718.5	240873	ETRIER A GRIFFE	1K0 615 424 N , 8J0 615 424 , 8J0 615 424 C , 1K0 615 424 L , 1K0 615 424 E	24.3387-1718.7



description

Références OE  
par référence  
ATE.

**i**  
Références remplacées /  
divers

## AUDI

A3 / A3 (8P) Sportback (03-13)	1,6 FSI	ArD	08.2003	08.2013	24.3387-1718.5	240873	ETRIER A GRIFFE	1K0 615 424 N , 8J0 615 424 , 8J0 615 424 C , 1K0 615 424 L , 1K0 615 424 E	24.3387-1718.7
	1,6 TDI	ArD	05.2009	08.2013	24.3387-1718.5	240873	ETRIER A GRIFFE	1K0 615 424 N , 8J0 615 424 , 8J0 615 424 C , 1K0 615 424 L , 1K0 615 424 E	24.3387-1718.7
	1,8 TFSI	ArD	01.2007	08.2013	24.3387-1718.5	240873	ETRIER A GRIFFE	1K0 615 424 N , 8J0 615 424 , 8J0 615 424 C , 1K0 615 424 L , 1K0 615 424 E	24.3387-1718.7
	1,9 TDI	ArD	06.2003	08.2013	24.3387-1718.5	240873	ETRIER A GRIFFE	1K0 615 424 N , 8J0 615 424 , 8J0 615 424 C , 1K0 615 424 L , 1K0 615 424 E	24.3387-1718.7
	2,0 FSI	ArD	05.2003	08.2013	24.3387-1718.5	240873	ETRIER A GRIFFE	1K0 615 424 N , 8J0 615 424 , 8J0 615 424 C , 1K0 615 424 L , 1K0 615 424 E	24.3387-1718.7
	2,0 TDI	ArD	03.2006	08.2013	24.3387-1718.5	240873	ETRIER A GRIFFE	1K0 615 424 N , 8J0 615 424 , 8J0 615 424 C , 1K0 615 424 L , 1K0 615 424 E	24.3387-1718.7
		ArD	05.2003	08.2013	24.3387-1718.5	240873	ETRIER A GRIFFE	1K0 615 424 N , 8J0 615 424 , 8J0 615 424 C , 1K0 615 424 L , 1K0 615 424 E	24.3387-1718.7
		ArD	06.2006	06.2008	24.3387-1718.5	240873	ETRIER A GRIFFE	1K0 615 424 N , 8J0 615 424 , 8J0 615 424 C , 1K0 615 424 L , 1K0 615 424 E	24.3387-1718.7
	2,0 TFSI	ArD	06.2004	08.2013	24.3387-1718.5	240873	ETRIER A GRIFFE	1K0 615 424 N , 8J0 615 424 , 8J0 615 424 C , 1K0 615 424 L , 1K0 615 424 E	24.3387-1718.7
A4 (B6/B7) (01-08)	1,6		12.2000	11.2008	11.0230-0569.1	260126	CALIPER MOUNT. BRACKET	4B0 615 125 C	
			12.2000	11.2008	11.0230-0560.1	260125	CALIPER MOUNT. BRACKET	4B0 615 125 B	
	1,8 T		12.2000	11.2008	11.0230-0569.1	260126	CALIPER MOUNT. BRACKET	4B0 615 125 C	
			11.2002	11.2008	11.0230-0569.1	260126	CALIPER MOUNT. BRACKET	4B0 615 125 C	



					<b>description</b>	<b>Références OE par référence ATE.</b>		<b>Références remplacées / divers</b>
--	--	--	--	--	--------------------	---	--	---------------------------------------

## AUDI

A4 (B6/B7) (01-08)	1,8 T							
			07.2001	11.2008	11.0230-0569.1	260126	CALIPER MOUNT. BRACKET	4B0 615 125 C
			07.2002	11.2008	11.0230-0569.1	260126	CALIPER MOUNT. BRACKET	4B0 615 125 C
			07.2002	11.2008	11.0230-0560.1	260125	CALIPER MOUNT. BRACKET	4B0 615 125 B
			11.2002	11.2008	11.0230-0560.1	260125	CALIPER MOUNT. BRACKET	4B0 615 125 B
			12.2000	11.2008	11.0230-0560.1	260125	CALIPER MOUNT. BRACKET	4B0 615 125 B
			07.2001	11.2008	11.0230-0560.1	260125	CALIPER MOUNT. BRACKET	4B0 615 125 B
	1,8 T quattro		07.2001	11.2008	11.0230-0560.1	260125	CALIPER MOUNT. BRACKET	4B0 615 125 B
			07.2002	11.2008	11.0230-0560.1	260125	CALIPER MOUNT. BRACKET	4B0 615 125 B
			12.2000	11.2008	11.0230-0569.1	260126	CALIPER MOUNT. BRACKET	4B0 615 125 C
			11.2002	11.2008	11.0230-0569.1	260126	CALIPER MOUNT. BRACKET	4B0 615 125 C
			07.2002	11.2008	11.0230-0569.1	260126	CALIPER MOUNT. BRACKET	4B0 615 125 C
			07.2001	11.2008	11.0230-0569.1	260126	CALIPER MOUNT. BRACKET	4B0 615 125 C
			11.2002	11.2008	11.0230-0560.1	260125	CALIPER MOUNT. BRACKET	4B0 615 125 B
			12.2000	11.2008	11.0230-0560.1	260125	CALIPER MOUNT. BRACKET	4B0 615 125 B
	1,9 TDI		04.2001	11.2008	11.0230-0569.1	260126	CALIPER MOUNT. BRACKET	4B0 615 125 C
			06.2004	11.2008	11.0230-0569.1	260126	CALIPER MOUNT. BRACKET	4B0 615 125 C
			12.2000	11.2008	11.0230-0569.1	260126	CALIPER MOUNT. BRACKET	4B0 615 125 C
			04.2001	11.2008	11.0230-0560.1	260125	CALIPER MOUNT. BRACKET	4B0 615 125 B
			12.2000	11.2008	11.0230-0560.1	260125	CALIPER MOUNT. BRACKET	4B0 615 125 B
			06.2004	11.2008	11.0230-0560.1	260125	CALIPER MOUNT. BRACKET	4B0 615 125 B
	1,9 TDI quattro		12.2000	11.2008	11.0230-0560.1	260125	CALIPER MOUNT. BRACKET	4B0 615 125 B



description

Références OE  
par référence  
ATE.

**i**  
Références remplacées /  
divers

## AUDI

A4 (B6/B7) (01-08)	1,9 TDI quattro		12.2000	11.2008	11.0230-0569.1	260126	CALIPER MOUNT. BRACKET	4B0 615 125 C	
	2		12.2000	11.2008	11.0230-0569.1	260126	CALIPER MOUNT. BRACKET	4B0 615 125 C	
			12.2000	11.2008	11.0230-0560.1	260125	CALIPER MOUNT. BRACKET	4B0 615 125 B	
	2,0 FSI		07.2002	11.2008	11.0230-0569.1	260126	CALIPER MOUNT. BRACKET	4B0 615 125 C	
			07.2002	11.2008	11.0230-0560.1	260125	CALIPER MOUNT. BRACKET	4B0 615 125 B	
	2,0 TDI		06.2006	11.2008	11.0230-0569.1	260126	CALIPER MOUNT. BRACKET	4B0 615 125 C	
			06.2006	11.2008	11.0230-0560.1	260125	CALIPER MOUNT. BRACKET	4B0 615 125 B	
			11.2004	11.2008	11.0230-0560.1	260125	CALIPER MOUNT. BRACKET	4B0 615 125 B	
			11.2004	11.2008	11.0230-0569.1	260126	CALIPER MOUNT. BRACKET	4B0 615 125 C	
	2,0 TDI quattro		01.2006	11.2008	11.0230-0560.1	260125	CALIPER MOUNT. BRACKET	4B0 615 125 B	
			06.2006	11.2008	11.0230-0560.1	260125	CALIPER MOUNT. BRACKET	4B0 615 125 B	
			01.2006	11.2008	11.0230-0569.1	260126	CALIPER MOUNT. BRACKET	4B0 615 125 C	
			06.2006	11.2008	11.0230-0569.1	260126	CALIPER MOUNT. BRACKET	4B0 615 125 C	
	2,0 TFSI		06.2005	11.2008	11.0230-0560.1	260125	CALIPER MOUNT. BRACKET	4B0 615 125 B	
			11.2004	11.2008	11.0230-0560.1	260125	CALIPER MOUNT. BRACKET	4B0 615 125 B	
			11.2004	11.2008	11.0230-0569.1	260126	CALIPER MOUNT. BRACKET	4B0 615 125 C	
			06.2005	11.2008	11.0230-0569.1	260126	CALIPER MOUNT. BRACKET	4B0 615 125 C	
	2,0 TFSI quattro		11.2004	11.2008	11.0230-0560.1	260125	CALIPER MOUNT. BRACKET	4B0 615 125 B	
			06.2005	11.2008	11.0230-0560.1	260125	CALIPER MOUNT. BRACKET	4B0 615 125 B	
			11.2004	11.2008	11.0230-0569.1	260126	CALIPER MOUNT. BRACKET	4B0 615 125 C	
			06.2005	11.2008	11.0230-0569.1	260126	CALIPER MOUNT. BRACKET	4B0 615 125 C	



description

Références OE  
par référence  
ATE.

**i**  
Références remplacées /  
divers

## AUDI

A4 (B6/B7) (01-08)	2,4		09.2001	11.2008	11.0230-0569.1	260126	CALIPER MOUNT. BRACKET	4B0 615 125 C	
			09.2001	11.2008	11.0230-0560.1	260125	CALIPER MOUNT. BRACKET	4B0 615 125 B	
	2,5 TDI		12.2000	11.2008	11.0230-0560.1	260125	CALIPER MOUNT. BRACKET	4B0 615 125 B	
			12.2000	11.2008	11.0230-0569.1	260126	CALIPER MOUNT. BRACKET	4B0 615 125 C	
	2,5 TDI quattro		12.2000	11.2008	11.0230-0569.1	260126	CALIPER MOUNT. BRACKET	4B0 615 125 C	
			12.2000	11.2008	11.0230-0560.1	260125	CALIPER MOUNT. BRACKET	4B0 615 125 B	
	2,7 TDI		11.2005	11.2008	11.0230-0569.1	260126	CALIPER MOUNT. BRACKET	4B0 615 125 C	
			01.2006	11.2008	11.0230-0569.1	260126	CALIPER MOUNT. BRACKET	4B0 615 125 C	
			11.2005	11.2008	11.0230-0560.1	260125	CALIPER MOUNT. BRACKET	4B0 615 125 B	
			01.2006	11.2008	11.0230-0560.1	260125	CALIPER MOUNT. BRACKET	4B0 615 125 B	
	3		12.2000	11.2008	11.0230-0560.1	260125	CALIPER MOUNT. BRACKET	4B0 615 125 B	
			12.2000	11.2008	11.0230-0569.1	260126	CALIPER MOUNT. BRACKET	4B0 615 125 C	
	3,0 quattro		12.2000	11.2008	11.0230-0569.1	260126	CALIPER MOUNT. BRACKET	4B0 615 125 C	
			12.2000	11.2008	11.0230-0560.1	260125	CALIPER MOUNT. BRACKET	4B0 615 125 B	
	3,0 TDI quattro		11.2004	11.2008	11.0230-0569.1	260126	CALIPER MOUNT. BRACKET	4B0 615 125 C	
			01.2006	11.2008	11.0230-0569.1	260126	CALIPER MOUNT. BRACKET	4B0 615 125 C	
			01.2006	11.2008	11.0230-0560.1	260125	CALIPER MOUNT. BRACKET	4B0 615 125 B	
			11.2004	11.2008	11.0230-0560.1	260125	CALIPER MOUNT. BRACKET	4B0 615 125 B	
	3,2 FSI		01.2005	11.2008	11.0230-0569.1	260126	CALIPER MOUNT. BRACKET	4B0 615 125 C	
			01.2005	11.2008	11.0230-0560.1	260125	CALIPER MOUNT. BRACKET	4B0 615 125 B	
	3,2 FSI quattro		01.2005	11.2008	11.0230-0560.1	260125	CALIPER MOUNT. BRACKET	4B0 615 125 B	



description

Références OE  
par référence  
ATE.

**i**  
Références remplacées /  
divers

## AUDI

Audi Model	Engine	Start	End	ATE Part No.	ATE Part No.	Description	OE Reference	Notes
A4 (B6/B7) (01-08)	3,2 FSI quattro	01.2005	11.2008	11.0230-0569.1	260126	CALIPER MOUNT. BRACKET	4B0 615 125 C	
A4 Décapotable (02-08)	1,8 T	04.2002	11.2008	11.0230-0560.1	260125	CALIPER MOUNT. BRACKET	4B0 615 125 B	
		04.2002	11.2008	11.0230-0569.1	260126	CALIPER MOUNT. BRACKET	4B0 615 125 C	
	1,8 T quattro	05.2003	11.2008	11.0230-0560.1	260125	CALIPER MOUNT. BRACKET	4B0 615 125 B	
		05.2003	11.2008	11.0230-0569.1	260126	CALIPER MOUNT. BRACKET	4B0 615 125 C	
	2	05.2004	11.2008	11.0230-0560.1	260125	CALIPER MOUNT. BRACKET	4B0 615 125 B	
		05.2004	11.2008	11.0230-0569.1	260126	CALIPER MOUNT. BRACKET	4B0 615 125 C	
	2,0 TDI	10.2005	11.2008	11.0230-0560.1	260125	CALIPER MOUNT. BRACKET	4B0 615 125 B	
		10.2005	11.2008	11.0230-0569.1	260126	CALIPER MOUNT. BRACKET	4B0 615 125 C	
	2,0 TFSI	01.2006	11.2008	11.0230-0560.1	260125	CALIPER MOUNT. BRACKET	4B0 615 125 B	
		01.2006	11.2008	11.0230-0569.1	260126	CALIPER MOUNT. BRACKET	4B0 615 125 C	
	2,0 TFSI quattro	11.2005	11.2008	11.0230-0569.1	260126	CALIPER MOUNT. BRACKET	4B0 615 125 C	
		11.2005	11.2008	11.0230-0560.1	260125	CALIPER MOUNT. BRACKET	4B0 615 125 B	
	2,4	04.2002	11.2008	11.0230-0560.1	260125	CALIPER MOUNT. BRACKET	4B0 615 125 B	
		04.2002	11.2008	11.0230-0569.1	260126	CALIPER MOUNT. BRACKET	4B0 615 125 C	
	2,5 TDI	08.2002	11.2008	11.0230-0560.1	260125	CALIPER MOUNT. BRACKET	4B0 615 125 B	
		08.2002	11.2008	11.0230-0569.1	260126	CALIPER MOUNT. BRACKET	4B0 615 125 C	
	2,7 TDI	06.2006	11.2008	11.0230-0569.1	260126	CALIPER MOUNT. BRACKET	4B0 615 125 C	
		06.2006	11.2008	11.0230-0560.1	260125	CALIPER MOUNT. BRACKET	4B0 615 125 B	
	3	04.2002	11.2008	11.0230-0560.1	260125	CALIPER MOUNT. BRACKET	4B0 615 125 B	
		04.2002	11.2008	11.0230-0569.1	260126	CALIPER MOUNT. BRACKET	4B0 615 125 C	



description

Références OE  
par référence  
ATE.

**i**  
Références remplacées /  
divers

## AUDI

A4 Décapotable (02-08)	3,0 quattro		05.2003	11.2008	11.0230-0560.1	260125	CALIPER MOUNT. BRACKET	4B0 615 125 B	
			05.2003	11.2008	11.0230-0569.1	260126	CALIPER MOUNT. BRACKET	4B0 615 125 C	
	3,0 TDI quattro		10.2005	11.2008	11.0230-0569.1	260126	CALIPER MOUNT. BRACKET	4B0 615 125 C	
			01.2006	11.2008	11.0230-0569.1	260126	CALIPER MOUNT. BRACKET	4B0 615 125 C	
			01.2006	11.2008	11.0230-0560.1	260125	CALIPER MOUNT. BRACKET	4B0 615 125 B	
			10.2005	11.2008	11.0230-0560.1	260125	CALIPER MOUNT. BRACKET	4B0 615 125 B	
	3,2 FSI		10.2005	11.2008	11.0230-0569.1	260126	CALIPER MOUNT. BRACKET	4B0 615 125 C	
			10.2005	11.2008	11.0230-0560.1	260125	CALIPER MOUNT. BRACKET	4B0 615 125 B	
	3,2 FSI quattro		10.2005	11.2008	11.0230-0560.1	260125	CALIPER MOUNT. BRACKET	4B0 615 125 B	
			10.2005	11.2008	11.0230-0569.1	260126	CALIPER MOUNT. BRACKET	4B0 615 125 C	
A6 (4F2/C6) Limousine (04-11)	2,0 TDI		07.2004	03.2011	11.0230-0569.1	260126	CALIPER MOUNT. BRACKET	4B0 615 125 C	
			06.2005	03.2011	11.0230-0569.1	260126	CALIPER MOUNT. BRACKET	4B0 615 125 C	
			10.2008	03.2011	11.0230-0569.1	260126	CALIPER MOUNT. BRACKET	4B0 615 125 C	
	2,0 TFSI		06.2005	03.2011	11.0230-0569.1	260126	CALIPER MOUNT. BRACKET	4B0 615 125 C	
	2,4		04.2004	03.2011	11.0230-0569.1	260126	CALIPER MOUNT. BRACKET	4B0 615 125 C	
	2,4 quattro		01.2005	03.2011	11.0230-0569.1	260126	CALIPER MOUNT. BRACKET	4B0 615 125 C	
	2,7 TDI		10.2008	03.2011	11.0230-0569.1	260126	CALIPER MOUNT. BRACKET	4B0 615 125 C	
			11.2004	03.2011	11.0230-0569.1	260126	CALIPER MOUNT. BRACKET	4B0 615 125 C	
	2,7 TDI quattro		11.2004	03.2011	11.0230-0569.1	260126	CALIPER MOUNT. BRACKET	4B0 615 125 C	
			06.2005	03.2011	11.0230-0569.1	260126	CALIPER MOUNT. BRACKET	4B0 615 125 C	
			10.2008	03.2011	11.0230-0569.1	260126	CALIPER MOUNT. BRACKET	4B0 615 125 C	





description

Références OE  
par référence  
ATE.

**i**  
Références remplacées /  
divers

## AUDI

A6 (4F2/C6) Limousine (04-11)	2,8 FSI		11.2006	03.2011	11.0230-0569.1	260126	CALIPER MOUNT. BRACKET	4B0 615 125 C	
			10.2008	03.2011	11.0230-0569.1	260126	CALIPER MOUNT. BRACKET	4B0 615 125 C	
	2,8 FSI quattro		10.2008	03.2011	11.0230-0569.1	260126	CALIPER MOUNT. BRACKET	4B0 615 125 C	
			04.2007	03.2011	11.0230-0569.1	260126	CALIPER MOUNT. BRACKET	4B0 615 125 C	
	3		04.2004	03.2011	11.0230-0569.1	260126	CALIPER MOUNT. BRACKET	4B0 615 125 C	
	3,0 quattro		04.2004	03.2011	11.0230-0569.1	260126	CALIPER MOUNT. BRACKET	4B0 615 125 C	
	3,0 TDI quattro		06.2006	03.2011	11.0230-0569.1	260126	CALIPER MOUNT. BRACKET	4B0 615 125 C	
			10.2008	03.2011	11.0230-0569.1	260126	CALIPER MOUNT. BRACKET	4B0 615 125 C	
			04.2004	03.2011	11.0230-0569.1	260126	CALIPER MOUNT. BRACKET	4B0 615 125 C	
	3,0 TFSI quattro		10.2008	03.2011	11.0230-0569.1	260126	CALIPER MOUNT. BRACKET	4B0 615 125 C	
	3,2 FSI		04.2004	03.2011	11.0230-0569.1	260126	CALIPER MOUNT. BRACKET	4B0 615 125 C	
	3,2 FSI quattro		04.2004	03.2011	11.0230-0569.1	260126	CALIPER MOUNT. BRACKET	4B0 615 125 C	
	4,2 FSI quattro		06.2006	03.2011	11.0230-0569.1	260126	CALIPER MOUNT. BRACKET	4B0 615 125 C	
	4,2 quattro		04.2004	03.2011	11.0230-0569.1	260126	CALIPER MOUNT. BRACKET	4B0 615 125 C	
A6 (4F5/C6) Avant (05-11)	2,0 TDI		03.2005	08.2011	11.0230-0569.1	260126	CALIPER MOUNT. BRACKET	4B0 615 125 C	
			10.2008	08.2011	11.0230-0569.1	260126	CALIPER MOUNT. BRACKET	4B0 615 125 C	
			06.2005	08.2011	11.0230-0569.1	260126	CALIPER MOUNT. BRACKET	4B0 615 125 C	
	2,0 TFSI		06.2005	08.2011	11.0230-0569.1	260126	CALIPER MOUNT. BRACKET	4B0 615 125 C	
	2,4		03.2005	08.2011	11.0230-0569.1	260126	CALIPER MOUNT. BRACKET	4B0 615 125 C	
	2,4 quattro		03.2005	08.2011	11.0230-0569.1	260126	CALIPER MOUNT. BRACKET	4B0 615 125 C	
	2,7 TDI		03.2005	08.2011	11.0230-0569.1	260126	CALIPER MOUNT. BRACKET	4B0 615 125 C	



description

Références OE  
par référence  
ATE.

**i**  
Références remplacées /  
divers

## AUDI

A6 (4F5/C6) Avant (05-11)	2,7 TDI		10.2008	08.2011	11.0230-0569.1	260126	CALIPER MOUNT. BRACKET	4B0 615 125 C	
	2,7 TDI quattro		10.2008	08.2011	11.0230-0569.1	260126	CALIPER MOUNT. BRACKET	4B0 615 125 C	
			06.2005	08.2011	11.0230-0569.1	260126	CALIPER MOUNT. BRACKET	4B0 615 125 C	
			03.2005	08.2011	11.0230-0569.1	260126	CALIPER MOUNT. BRACKET	4B0 615 125 C	
	2,8 FSI		11.2006	08.2011	11.0230-0569.1	260126	CALIPER MOUNT. BRACKET	4B0 615 125 C	
			10.2008	08.2011	11.0230-0569.1	260126	CALIPER MOUNT. BRACKET	4B0 615 125 C	
	2,8 FSI quattro		04.2007	08.2011	11.0230-0569.1	260126	CALIPER MOUNT. BRACKET	4B0 615 125 C	
			10.2008	08.2011	11.0230-0569.1	260126	CALIPER MOUNT. BRACKET	4B0 615 125 C	
	3		03.2005	08.2011	11.0230-0569.1	260126	CALIPER MOUNT. BRACKET	4B0 615 125 C	
	3,0 quattro		03.2005	08.2011	11.0230-0569.1	260126	CALIPER MOUNT. BRACKET	4B0 615 125 C	
	3,0 TDI quattro		03.2005	08.2011	11.0230-0569.1	260126	CALIPER MOUNT. BRACKET	4B0 615 125 C	
			06.2006	08.2011	11.0230-0569.1	260126	CALIPER MOUNT. BRACKET	4B0 615 125 C	
			10.2008	08.2011	11.0230-0569.1	260126	CALIPER MOUNT. BRACKET	4B0 615 125 C	
	3,0 TFSI quattro		10.2008	08.2011	11.0230-0569.1	260126	CALIPER MOUNT. BRACKET	4B0 615 125 C	
	3,2 FSI		03.2005	08.2011	11.0230-0569.1	260126	CALIPER MOUNT. BRACKET	4B0 615 125 C	
	3,2 FSI quattro		03.2005	08.2011	11.0230-0569.1	260126	CALIPER MOUNT. BRACKET	4B0 615 125 C	
	4,2 FSI quattro		06.2006	08.2011	11.0230-0569.1	260126	CALIPER MOUNT. BRACKET	4B0 615 125 C	
	4,2 quattro		03.2005	08.2011	11.0230-0569.1	260126	CALIPER MOUNT. BRACKET	4B0 615 125 C	
A6 / A6 Avant (4B/C5) (97-05)	1,8			01.2005	11.0230-0569.1	260126	CALIPER MOUNT. BRACKET	4B0 615 125 C	
				01.2005	11.0230-0560.1	260125	CALIPER MOUNT. BRACKET	4B0 615 125 B	
	1,8 T			01.2005	11.0230-0569.1	260126	CALIPER MOUNT. BRACKET	4B0 615 125 C	



description

Références OE  
par référence  
ATE.

**i**  
Références remplacées /  
divers

## AUDI

A6 / A6 Avant (4B/C5) (97-05)	1,8 T			01.2005	11.0230-0560.1	260125	CALIPER MOUNT. BRACKET	4B0 615 125 B	
	1,8 T quattro			01.2005	11.0230-0569.1	260126	CALIPER MOUNT. BRACKET	4B0 615 125 C	
				01.2005	11.0230-0560.1	260125	CALIPER MOUNT. BRACKET	4B0 615 125 B	
	1,9 TDI			01.2005	11.0230-0569.1	260126	CALIPER MOUNT. BRACKET	4B0 615 125 C	
				01.2005	11.0230-0560.1	260125	CALIPER MOUNT. BRACKET	4B0 615 125 B	
	2			01.2005	11.0230-0560.1	260125	CALIPER MOUNT. BRACKET	4B0 615 125 B	
				01.2005	11.0230-0569.1	260126	CALIPER MOUNT. BRACKET	4B0 615 125 C	
	2,4			01.2005	11.0230-0569.1	260126	CALIPER MOUNT. BRACKET	4B0 615 125 C	
				01.2005	11.0230-0560.1	260125	CALIPER MOUNT. BRACKET	4B0 615 125 B	
	2,4 quattro			01.2005	11.0230-0560.1	260125	CALIPER MOUNT. BRACKET	4B0 615 125 B	
				01.2005	11.0230-0569.1	260126	CALIPER MOUNT. BRACKET	4B0 615 125 C	
	2,5 TDI			01.2005	11.0230-0569.1	260126	CALIPER MOUNT. BRACKET	4B0 615 125 C	
				01.2005	11.0230-0560.1	260125	CALIPER MOUNT. BRACKET	4B0 615 125 B	
	2,5 TDI quattro			01.2005	11.0230-0560.1	260125	CALIPER MOUNT. BRACKET	4B0 615 125 B	
				01.2005	11.0230-0569.1	260126	CALIPER MOUNT. BRACKET	4B0 615 125 C	
	2,8			01.2005	11.0230-0560.1	260125	CALIPER MOUNT. BRACKET	4B0 615 125 B	
				01.2005	11.0230-0569.1	260126	CALIPER MOUNT. BRACKET	4B0 615 125 C	
	2,8 quattro			01.2005	11.0230-0560.1	260125	CALIPER MOUNT. BRACKET	4B0 615 125 B	
				01.2005	11.0230-0569.1	260126	CALIPER MOUNT. BRACKET	4B0 615 125 C	
	3		06.2001	01.2005	11.0230-0630.1	260127	CALIPER MOUNT. BRACKET	4B0 615 125 D	
	3,0 Lim, quattro		06.2001	01.2005	11.0230-0630.1	260127	CALIPER MOUNT. BRACKET	4B0 615 125 D	



					description	Références OE par référence ATE.		Références remplacées / divers
--	--	--	--	--	-------------	----------------------------------	--	--------------------------------

## AUDI

A6 / A6 Avant (4B/C5) (97-05)	3,0 quattro		06.2001	01.2005	11.0230-0630.1	260127	CALIPER MOUNT. BRACKET	4B0 615 125 D	
A6 Allroad (00-05)	2,5 TDI		05.2000	07.2005	11.0230-0630.1	260127	CALIPER MOUNT. BRACKET	4B0 615 125 D	
	2,7 T		05.2000	07.2005	11.0230-0630.1	260127	CALIPER MOUNT. BRACKET	4B0 615 125 D	
	4,2		07.2002	07.2005	11.0230-0630.1	260127	CALIPER MOUNT. BRACKET	4B0 615 125 D	
TT Coupe (06-14)	1,8 TFSI	ArD	06.2008	06.2014	24.3387-1718.5	240873	ETRIER A GRIFFE	1K0 615 424 N , 8J0 615 424 , 8J0 615 424 C , 1K0 615 424 L , 1K0 615 424 E	24.3387-1718.7
	2,0 TFSI	ArD	05.2010	06.2014	24.3387-1718.5	240873	ETRIER A GRIFFE	1K0 615 424 N , 8J0 615 424 , 8J0 615 424 C , 1K0 615 424 L , 1K0 615 424 E	24.3387-1718.7
		ArD	07.2006	06.2014	24.3387-1718.5	240873	ETRIER A GRIFFE	1K0 615 424 N , 8J0 615 424 , 8J0 615 424 C , 1K0 615 424 L , 1K0 615 424 E	24.3387-1718.7
TT Roadster (07-14)	1,8 TFSI	ArD	06.2008	06.2014	24.3387-1718.5	240873	ETRIER A GRIFFE	1K0 615 424 N , 8J0 615 424 , 8J0 615 424 C , 1K0 615 424 L , 1K0 615 424 E	24.3387-1718.7
	2,0 TFSI	ArD	02.2007	06.2014	24.3387-1718.5	240873	ETRIER A GRIFFE	1K0 615 424 N , 8J0 615 424 , 8J0 615 424 C , 1K0 615 424 L , 1K0 615 424 E	24.3387-1718.7
		ArD	05.2010	06.2014	24.3387-1718.5	240873	ETRIER A GRIFFE	1K0 615 424 N , 8J0 615 424 , 8J0 615 424 C , 1K0 615 424 L , 1K0 615 424 E	24.3387-1718.7



					description	Références OE par référence ATE.		Références remplacées / divers
--	--	--	--	--	-------------	----------------------------------	--	--------------------------------

## BMW

Série 7/E65-66 (02-08)	730 d		09.2002	08.2008	13.0460-7306.2	607306	PLAQUETTES DE FREIN	34 11 6 794 915	cf. Photo
	730 d,Ld		03.2005	08.2008	13.0460-7306.2	607306	PLAQUETTES DE FREIN	34 11 6 794 915	cf. Photo
	730 i,Li		03.2003	08.2008	13.0460-7306.2	607306	PLAQUETTES DE FREIN	34 11 6 794 915	cf. Photo
			07.2005	08.2008	13.0460-7306.2	607306	PLAQUETTES DE FREIN	34 11 6 794 915	cf. Photo
	735 i,Li		11.2001	08.2008	13.0460-7306.2	607306	PLAQUETTES DE FREIN	34 11 6 794 915	cf. Photo
	740 d		09.2002	08.2008	13.0460-7306.2	607306	PLAQUETTES DE FREIN	34 11 6 794 915	cf. Photo
	740 i,Li		03.2005	08.2008	13.0460-7306.2	607306	PLAQUETTES DE FREIN	34 11 6 794 915	cf. Photo
	745 i,Li		11.2001	08.2008	13.0460-7306.2	607306	PLAQUETTES DE FREIN	34 11 6 794 915	cf. Photo
	750 i,Li		03.2005	08.2008	13.0460-7306.2	607306	PLAQUETTES DE FREIN	34 11 6 794 915	cf. Photo
	760 i,Li		03.2003	08.2008	13.0460-7306.2	607306	PLAQUETTES DE FREIN	34 11 6 794 915	cf. Photo

## CITROEN

C-Zero (10-)	C-Zero		10.2010		03.0137-0525.2	650525	JEU DE MACHOIRE	16 062 267 80 , 4600A335	
			10.2014		03.0137-0525.2	650525	JEU DE MACHOIRE	16 062 267 80 , 4600A335	



					description	Références OE par référence ATE.		Références remplacées / divers
--	--	--	--	--	-------------	----------------------------------	--	--------------------------------

## Classic PKW

AUDI 100 (76-79)	2,0 D	ArD	10.1978	07.1979	24.5102-0330.3	331458	FLEXIBLE FREIN	443 611 707 , 431 611 707 A , 433 611 707	83.6134-0332.3
	2,2	ArD	03.1977	07.1979	24.5102-0330.3	331458	FLEXIBLE FREIN	443 611 707 , 431 611 707 A , 433 611 707	83.6134-0332.3
AUDI 100 (80-81)	1,9	ArD	08.1980	07.1981	24.5102-0330.3	331458	FLEXIBLE FREIN	443 611 707 , 431 611 707 A , 433 611 707	83.6134-0332.3
	2,0 D	ArD	08.1979	07.1981	24.5102-0330.3	331458	FLEXIBLE FREIN	443 611 707 , 431 611 707 A , 433 611 707	83.6134-0332.3
	2,2	ArD	08.1979	07.1981	24.5102-0330.3	331458	FLEXIBLE FREIN	443 611 707 , 431 611 707 A , 433 611 707	83.6134-0332.3
AUDI 100 (82)	1,9	ArD	08.1981	07.1982	24.5102-0330.3	331458	FLEXIBLE FREIN	443 611 707 , 431 611 707 A , 433 611 707	83.6134-0332.3
	2,0 D	ArD	08.1981	07.1982	24.5102-0330.3	331458	FLEXIBLE FREIN	443 611 707 , 431 611 707 A , 433 611 707	83.6134-0332.3
	2,0 TD	ArD	11.1981	07.1982	24.5102-0330.3	331458	FLEXIBLE FREIN	443 611 707 , 431 611 707 A , 433 611 707	83.6134-0332.3
	2,2	ArD	08.1981	07.1982	24.5102-0330.3	331458	FLEXIBLE FREIN	443 611 707 , 431 611 707 A , 433 611 707	83.6134-0332.3
AUDI 100 (83-90)	1,8	ArD	08.1982	12.1985	24.5102-0330.3	331458	FLEXIBLE FREIN	443 611 707 , 431 611 707 A , 433 611 707	83.6134-0332.3
	1,9	ArD	08.1982	07.1984	24.5102-0330.3	331458	FLEXIBLE FREIN	443 611 707 , 431 611 707 A , 433 611 707	83.6134-0332.3
	2	ArD	08.1982	12.1985	24.5102-0330.3	331458	FLEXIBLE FREIN	443 611 707 , 431 611 707 A , 433 611 707	83.6134-0332.3
	2,0 D	ArD	08.1982	12.1985	24.5102-0330.3	331458	FLEXIBLE FREIN	443 611 707 , 431 611 707 A , 433 611 707	83.6134-0332.3
	2,0 TD	ArD	08.1982	12.1985	24.5102-0330.3	331458	FLEXIBLE FREIN	443 611 707 , 431 611 707 A , 433 611 707	83.6134-0332.3



description

Références OE  
par référence  
ATE.

**i**  
Références remplacées /  
divers

## Classic PKW

AUDI 100 (83-90)	2,2	ArD	08.1982	12.1985	24.5102-0330.3	331458	FLEXIBLE FREIN	443 611 707 , 431 611 707 A , 433 611 707	83.6134-0332.3
	2,2 CS	ArD			24.5102-0330.3	331458	FLEXIBLE FREIN	443 611 707 , 431 611 707 A , 433 611 707	83.6134-0332.3
	2,3	ArD	10.1983	12.1985	24.5102-0330.3	331458	FLEXIBLE FREIN	443 611 707 , 431 611 707 A , 433 611 707	83.6134-0332.3
	2,3 CS	ArD			24.5102-0330.3	331458	FLEXIBLE FREIN	443 611 707 , 431 611 707 A , 433 611 707	83.6134-0332.3
AUDI 100 Quattro (85-90)	2,2	ArD	08.1985		24.5102-0330.3	331458	FLEXIBLE FREIN	443 611 707 , 431 611 707 A , 433 611 707	83.6134-0332.3
	2,2 Turbo	ArD	03.1986		24.5102-0330.3	331458	FLEXIBLE FREIN	443 611 707 , 431 611 707 A , 433 611 707	83.6134-0332.3
	2,3	ArD	08.1986		24.5102-0330.3	331458	FLEXIBLE FREIN	443 611 707 , 431 611 707 A , 433 611 707	83.6134-0332.3
AUDI 200 (80-83)	2,2	ArD	10.1979	08.1983	24.5102-0330.3	331458	FLEXIBLE FREIN	443 611 707 , 431 611 707 A , 433 611 707	83.6134-0332.3
AUDI 200 (84-91)	2,1	ArD	08.1983		24.5102-0330.3	331458	FLEXIBLE FREIN	443 611 707 , 431 611 707 A , 433 611 707	83.6134-0332.3
	2,2	ArD	08.1984		24.5102-0330.3	331458	FLEXIBLE FREIN	443 611 707 , 431 611 707 A , 433 611 707	83.6134-0332.3
AUDI QUATTRO (80-91)		ArD	08.1984		24.5102-0330.3	331458	FLEXIBLE FREIN	443 611 707 , 431 611 707 A , 433 611 707	83.6134-0332.3
		ArD	07.1980		24.5102-0330.3	331458	FLEXIBLE FREIN	443 611 707 , 431 611 707 A , 433 611 707	83.6134-0332.3
FORD FIESTA III (89-96)	1	AvG	03.1989	10.1995	24.3481-8511.5	240760	ETRIER A GRIFFE	R89FX-2B302-AB , 89FX-2B302-AB , 89FB-2L232-AB , R89FX-2B302-AC , 1478476 , 1138594 , 1121375 , 6176623	11.3481-8511.2



description

Références OE  
par référence  
ATE.

Références remplacées /  
divers

## Classic PKW

FORD FIESTA III (89-96)	1,1	AvG	05.1989	10.1995	24.3481-8511.5	240760	ETRIER A GRIFFE	R89FX-2B302-AB , 89FX-2B302-AB , 89FB-2L232-AB , R89FX-2B302-AC , 1478476 , 1138594 , 1121375 , 6176623	11.3481-8511.2
			02.1994	11.1996	24.2120-1758.3	011008	TANDEM MASTER CYLINDE	94FB-2140-AB , 7117258	24.2120-1606.3
	1,3	AvG	03.1989	10.1995	24.3481-8511.5	240760	ETRIER A GRIFFE	R89FX-2B302-AB , 89FX-2B302-AB , 89FB-2L232-AB , R89FX-2B302-AC , 1478476 , 1138594 , 1121375 , 6176623	11.3481-8511.2
			02.1994	11.1996	24.2120-1758.3	011008	TANDEM MASTER CYLINDE	94FB-2140-AB , 7117258	24.2120-1606.3
	1,3 Kastenw,	AvG	09.1991	10.1995	24.3481-8511.5	240760	ETRIER A GRIFFE	R89FX-2B302-AB , 89FX-2B302-AB , 89FB-2L232-AB , R89FX-2B302-AC , 1478476 , 1138594 , 1121375 , 6176623	11.3481-8511.2
			02.1994	11.1996	24.2120-1758.3	011008	TANDEM MASTER CYLINDE	94FB-2140-AB , 7117258	24.2120-1606.3
	1,4	AvG	03.1989	10.1995	24.3481-8511.5	240760	ETRIER A GRIFFE	R89FX-2B302-AB , 89FX-2B302-AB , 89FB-2L232-AB , R89FX-2B302-AC , 1478476 , 1138594 , 1121375 , 6176623	11.3481-8511.2
			02.1994	11.1996	24.2120-1758.3	011008	TANDEM MASTER CYLINDE	94FB-2140-AB , 7117258	24.2120-1606.3
	1,6	AvG	01.1989	10.1995	24.3481-8511.5	240760	ETRIER A GRIFFE	R89FX-2B302-AB , 89FX-2B302-AB , 89FB-2L232-AB , R89FX-2B302-AC , 1478476 , 1138594 , 1121375 , 6176623	11.3481-8511.2
	1,6 Turbo	AvG	03.1990	10.1992	24.3481-8511.5	240760	ETRIER A GRIFFE	R89FX-2B302-AB , 89FX-2B302-AB , 89FB-2L232-AB , R89FX-2B302-AC , 1478476 , 1138594 , 1121375 , 6176623	11.3481-8511.2
	1,6 XR2i	AvG	03.1989	10.1995	24.3481-8511.5	240760	ETRIER A GRIFFE	R89FX-2B302-AB , 89FX-2B302-AB , 89FB-2L232-AB , R89FX-2B302-AC , 1478476 , 1138594 , 1121375 , 6176623	11.3481-8511.2











					description	Références OE par référence ATE.		Références remplacées / divers
--	--	--	--	--	-------------	----------------------------------	--	--------------------------------

## Classic PKW

FORD FIESTA III (89-96)	1,6i 16V	AvG	01.1994	10.1995	24.3481-8511.5	240760	ETRIER A GRIFFE	R89FX-2B302-AB , 89FX-2B302-AB , 89FB-2L232-AB , R89FX-2B302-AC , 1478476 , 1138594 , 1121375 , 6176623	11.3481-8511.2
	1,8 16V	AvG	02.1992	10.1995	24.3481-8511.5	240760	ETRIER A GRIFFE	R89FX-2B302-AB , 89FX-2B302-AB , 89FB-2L232-AB , R89FX-2B302-AC , 1478476 , 1138594 , 1121375 , 6176623	11.3481-8511.2
	1,8 D	AvG	05.1989	10.1995	24.3481-8511.5	240760	ETRIER A GRIFFE	R89FX-2B302-AB , 89FX-2B302-AB , 89FB-2L232-AB , R89FX-2B302-AC , 1478476 , 1138594 , 1121375 , 6176623	11.3481-8511.2
			02.1994	11.1996	24.2120-1758.3	011008	TANDEM MASTER CYLINDE	94FB-2140-AB , 7117258	24.2120-1606.3
	1,8 D Kastenw,	AvG	09.1991	10.1995	24.3481-8511.5	240760	ETRIER A GRIFFE	R89FX-2B302-AB , 89FX-2B302-AB , 89FB-2L232-AB , R89FX-2B302-AC , 1478476 , 1138594 , 1121375 , 6176623	11.3481-8511.2
			02.1994	11.1996	24.2120-1758.3	011008	TANDEM MASTER CYLINDE	94FB-2140-AB , 7117258	24.2120-1606.3
	1,8 XR2i	AvG	02.1992	10.1995	24.3481-8511.5	240760	ETRIER A GRIFFE	R89FX-2B302-AB , 89FX-2B302-AB , 89FB-2L232-AB , R89FX-2B302-AC , 1478476 , 1138594 , 1121375 , 6176623	11.3481-8511.2



					<b>description</b>	<b>Références OE par référence ATE.</b>	 <b>Références remplacées / divers</b>
---	---	---	--	---	--------------------	---	--

## HONDA

Modèle	Moteur	ArD	Date	Code	Code	Description	Références OE	Références divers
JAZZ (08-15)	1,2 i-VTEC	ArD	01.2009	24.5270-0236.3	331466	FLEXIBLE FREIN	01466-TF0-951	
	1,3 Hybrid	ArD	04.2011	24.5270-0236.3	331466	FLEXIBLE FREIN	01466-TF0-951	
	1,4 Flexfuel	ArD	11.2008	24.5270-0236.3	331466	FLEXIBLE FREIN	01466-TF0-951	
	1,4 i 16V	ArD	11.2008	24.5270-0236.3	331466	FLEXIBLE FREIN	01466-TF0-951	
		ArD	01.2009	24.5270-0236.3	331466	FLEXIBLE FREIN	01466-TF0-951	
	1,5 Flexfuel	ArD	01.2009	24.5270-0236.3	331466	FLEXIBLE FREIN	01466-TF0-951	
	1,5 i 16V	ArD	01.2009	24.5270-0236.3	331466	FLEXIBLE FREIN	01466-TF0-951	



					description	Références OE par référence ATE.		Références remplacées / divers
--	--	--	--	--	-------------	----------------------------------	--	--------------------------------

## HYUNDAI

GRAND SANTA FE (13-)	2,2 CRDi 4WD		06.2013		03.0137-3048.2	653048	JEU DE MACHOIRE	58305-2WA00	
			10.2015		03.0137-3048.2	653048	JEU DE MACHOIRE	58305-2WA00	
	3,4 4WD		01.2014		03.0137-3048.2	653048	JEU DE MACHOIRE	58305-2WA00	
			02.2014		03.0137-3048.2	653048	JEU DE MACHOIRE	58305-2WA00	
GRANDEUR (HG) (11-)	2,4 16V		01.2011	09.2012	03.0137-3049.2	653049	JEU DE MACHOIRE	58305-2TA00 , 58305-3QA00	
	3		07.2011	09.2012	03.0137-3049.2	653049	JEU DE MACHOIRE	58305-2TA00 , 58305-3QA00	
SANTA FE III (DM) (12-)	2,0 CRDi		09.2012		03.0137-3048.2	653048	JEU DE MACHOIRE	58305-2WA00	
	2,0 CRDi 4WD		09.2012		03.0137-3048.2	653048	JEU DE MACHOIRE	58305-2WA00	
	2,2 CRDi		09.2012		03.0137-3048.2	653048	JEU DE MACHOIRE	58305-2WA00	
			10.2015		03.0137-3048.2	653048	JEU DE MACHOIRE	58305-2WA00	
	2,2 CRDi 4WD		10.2015		03.0137-3048.2	653048	JEU DE MACHOIRE	58305-2WA00	
			09.2012		03.0137-3048.2	653048	JEU DE MACHOIRE	58305-2WA00	
	2,4 16V		09.2012		03.0137-3048.2	653048	JEU DE MACHOIRE	58305-2WA00	
	2,4 16V 4WD		09.2012		03.0137-3048.2	653048	JEU DE MACHOIRE	58305-2WA00	
	2,4 CCVT		09.2012		03.0137-3048.2	653048	JEU DE MACHOIRE	58305-2WA00	
	2,4 CCVT 4WD		09.2012		03.0137-3048.2	653048	JEU DE MACHOIRE	58305-2WA00	
	2,4 GDI		05.2015		03.0137-3048.2	653048	JEU DE MACHOIRE	58305-2WA00	
	2,4 GDI 4WD		05.2010		03.0137-3048.2	653048	JEU DE MACHOIRE	58305-2WA00	



					description	Références OE par référence ATE.		Références remplacées / divers
--	--	--	--	--	-------------	----------------------------------	--	--------------------------------

## KIA

OPTIMA (TF) (12-15)	1,7 CRDi		03.2012		03.0137-3049.2	653049	JEU DE MACHOIRE	58305-2TA00 , 58305-3QA00	
	2,0 16V		03.2012		03.0137-3049.2	653049	JEU DE MACHOIRE	58305-2TA00 , 58305-3QA00	
	2,0 CVL		03.2012		03.0137-3049.2	653049	JEU DE MACHOIRE	58305-2TA00 , 58305-3QA00	
	2,0 CVT Hybrid		03.2012		03.0137-3049.2	653049	JEU DE MACHOIRE	58305-2TA00 , 58305-3QA00	
	2,4 16V		03.2012		03.0137-3049.2	653049	JEU DE MACHOIRE	58305-2TA00 , 58305-3QA00	
			06.2010		03.0137-3049.2	653049	JEU DE MACHOIRE	58305-2TA00 , 58305-3QA00	
SORENTO (XM) (09-14)	2,0 CRDi		07.2012	09.2014	03.0137-3048.2	653048	JEU DE MACHOIRE	58305-2WA00	
	2,0 CRDi 4WD		07.2012	09.2014	03.0137-3048.2	653048	JEU DE MACHOIRE	58305-2WA00	
	2,2 CRDi		07.2012	09.2014	03.0137-3048.2	653048	JEU DE MACHOIRE	58305-2WA00	
	2,2 CRDi 4WD		07.2012	09.2014	03.0137-3048.2	653048	JEU DE MACHOIRE	58305-2WA00	
	2,4 16V		07.2012	09.2014	03.0137-3048.2	653048	JEU DE MACHOIRE	58305-2WA00	
	2,4 16V 4WD		07.2012	09.2014	03.0137-3048.2	653048	JEU DE MACHOIRE	58305-2WA00	



					description	Références OE par référence ATE.		Références remplacées / divers
--	--	--	--	--	-------------	----------------------------------	--	--------------------------------

## MERCEDES BENZ

C-Klasse (A205) Cabrio (16-)	C 180		06.2016		13.0470-7304.2	LD7304	CERAMIC PLAQ. FREIN	A 008 420 14 20 , 008 420 14 20 , A 000 420 82 00 , 000 420 82 00 , A 008 420 13 20 , 008 420 13 20	
	C 200		06.2016		13.0470-7304.2	LD7304	CERAMIC PLAQ. FREIN	A 008 420 14 20 , 008 420 14 20 , A 000 420 82 00 , 000 420 82 00 , A 008 420 13 20 , 008 420 13 20	
	C 200 4-matic		06.2016		13.0470-7304.2	LD7304	CERAMIC PLAQ. FREIN	A 008 420 14 20 , 008 420 14 20 , A 000 420 82 00 , 000 420 82 00 , A 008 420 13 20 , 008 420 13 20	
	C 220 d		06.2016		13.0470-7304.2	LD7304	CERAMIC PLAQ. FREIN	A 008 420 14 20 , 008 420 14 20 , A 000 420 82 00 , 000 420 82 00 , A 008 420 13 20 , 008 420 13 20	
	C 220 d 4-matic		06.2016		13.0470-7304.2	LD7304	CERAMIC PLAQ. FREIN	A 008 420 14 20 , 008 420 14 20 , A 000 420 82 00 , 000 420 82 00 , A 008 420 13 20 , 008 420 13 20	
	C 250		06.2016		13.0470-7304.2	LD7304	CERAMIC PLAQ. FREIN	A 008 420 14 20 , 008 420 14 20 , A 000 420 82 00 , 000 420 82 00 , A 008 420 13 20 , 008 420 13 20	
	C 250 d		06.2016		13.0470-7304.2	LD7304	CERAMIC PLAQ. FREIN	A 008 420 14 20 , 008 420 14 20 , A 000 420 82 00 , 000 420 82 00 , A 008 420 13 20 , 008 420 13 20	
	C 300		06.2016		13.0470-7304.2	LD7304	CERAMIC PLAQ. FREIN	A 008 420 14 20 , 008 420 14 20 , A 000 420 82 00 , 000 420 82 00 , A 008 420 13 20 , 008 420 13 20	
	C 400 4-matic		06.2016		13.0470-7304.2	LD7304	CERAMIC PLAQ. FREIN	A 008 420 14 20 , 008 420 14 20 , A 000 420 82 00 , 000 420 82 00 , A 008 420 13 20 , 008 420 13 20	



description

Références OE  
par référence  
ATE.

**i**  
Références remplacées /  
divers

## MERCEDES BENZ

C-Klasse (C205) Coupe (15-)	C 180		10.2015		13.0470-7304.2	LD7304	CERAMIC PLAO. FREIN	A 008 420 14 20 , 008 420 14 20 , A 000 420 82 00 , 000 420 82 00 , A 008 420 13 20 , 008 420 13 20	
	C 200		10.2015		13.0470-7304.2	LD7304	CERAMIC PLAO. FREIN	A 008 420 14 20 , 008 420 14 20 , A 000 420 82 00 , 000 420 82 00 , A 008 420 13 20 , 008 420 13 20	
	C 200 4-matic		04.2016		13.0470-7304.2	LD7304	CERAMIC PLAO. FREIN	A 008 420 14 20 , 008 420 14 20 , A 000 420 82 00 , 000 420 82 00 , A 008 420 13 20 , 008 420 13 20	
	C 220 d		10.2015		13.0470-7304.2	LD7304	CERAMIC PLAO. FREIN	A 008 420 14 20 , 008 420 14 20 , A 000 420 82 00 , 000 420 82 00 , A 008 420 13 20 , 008 420 13 20	
	C 220 d 4-matic		04.2016		13.0470-7304.2	LD7304	CERAMIC PLAO. FREIN	A 008 420 14 20 , 008 420 14 20 , A 000 420 82 00 , 000 420 82 00 , A 008 420 13 20 , 008 420 13 20	
	C 250		10.2015		13.0470-7304.2	LD7304	CERAMIC PLAO. FREIN	A 008 420 14 20 , 008 420 14 20 , A 000 420 82 00 , 000 420 82 00 , A 008 420 13 20 , 008 420 13 20	
	C 250 d		10.2015		13.0470-7304.2	LD7304	CERAMIC PLAO. FREIN	A 008 420 14 20 , 008 420 14 20 , A 000 420 82 00 , 000 420 82 00 , A 008 420 13 20 , 008 420 13 20	
	C 250 d 4-matic		04.2016		13.0470-7304.2	LD7304	CERAMIC PLAO. FREIN	A 008 420 14 20 , 008 420 14 20 , A 000 420 82 00 , 000 420 82 00 , A 008 420 13 20 , 008 420 13 20	
	C 300		10.2015		13.0470-7304.2	LD7304	CERAMIC PLAO. FREIN	A 008 420 14 20 , 008 420 14 20 , A 000 420 82 00 , 000 420 82 00 , A 008 420 13 20 , 008 420 13 20	



description

Références OE  
par référence  
ATE.

**i**  
Références remplacées /  
divers

## MERCEDES BENZ

C-Klasse (C205) Coupe (15-)	C 400 4-matic		04.2016		13.0470-7304.2	LD7304	CERAMIC PLAO. FREIN	A 008 420 14 20 , 008 420 14 20 , A 000 420 82 00 , 000 420 82 00 , A 008 420 13 20 , 008 420 13 20	
C-Klasse (S205) Kombi (14-)	C 160		04.2015		13.0470-7304.2	LD7304	CERAMIC PLAO. FREIN	A 008 420 14 20 , 008 420 14 20 , A 000 420 82 00 , 000 420 82 00 , A 008 420 13 20 , 008 420 13 20	
	C 180		09.2014		13.0470-7304.2	LD7304	CERAMIC PLAO. FREIN	A 008 420 14 20 , 008 420 14 20 , A 000 420 82 00 , 000 420 82 00 , A 008 420 13 20 , 008 420 13 20	
	C 180 BlueTec		09.2014		13.0470-7304.2	LD7304	CERAMIC PLAO. FREIN	A 008 420 14 20 , 008 420 14 20 , A 000 420 82 00 , 000 420 82 00 , A 008 420 13 20 , 008 420 13 20	
	C 200		09.2014		13.0470-7304.2	LD7304	CERAMIC PLAO. FREIN	A 008 420 14 20 , 008 420 14 20 , A 000 420 82 00 , 000 420 82 00 , A 008 420 13 20 , 008 420 13 20	
	C 200 4-matic		04.2015		13.0470-7304.2	LD7304	CERAMIC PLAO. FREIN	A 008 420 14 20 , 008 420 14 20 , A 000 420 82 00 , 000 420 82 00 , A 008 420 13 20 , 008 420 13 20	
	C 200 BlueTec		09.2014		13.0470-7304.2	LD7304	CERAMIC PLAO. FREIN	A 008 420 14 20 , 008 420 14 20 , A 000 420 82 00 , 000 420 82 00 , A 008 420 13 20 , 008 420 13 20	
	C 200 d		10.2015		13.0470-7304.2	LD7304	CERAMIC PLAO. FREIN	A 008 420 14 20 , 008 420 14 20 , A 000 420 82 00 , 000 420 82 00 , A 008 420 13 20 , 008 420 13 20	
	C 220 BlueTec		09.2014		13.0470-7304.2	LD7304	CERAMIC PLAO. FREIN	A 008 420 14 20 , 008 420 14 20 , A 000 420 82 00 , 000 420 82 00 , A 008 420 13 20 , 008 420 13 20	



description

Références OE  
par référence  
ATE.

**i**  
Références remplacées /  
divers

## MERCEDES BENZ

C-Klasse (S205) Kombi (14-)	C 220 d 4-matic		04.2015		13.0470-7304.2	LD7304	CERAMIC PLAO. FREIN	A 008 420 14 20 , 008 420 14 20 , A 000 420 82 00 , 000 420 82 00 , A 008 420 13 20 , 008 420 13 20	
	C 250 BlueTec		09.2014		13.0470-7304.2	LD7304	CERAMIC PLAO. FREIN	A 008 420 14 20 , 008 420 14 20 , A 000 420 82 00 , 000 420 82 00 , A 008 420 13 20 , 008 420 13 20	
	C 250 BlueTec 4-matic		10.2014		13.0470-7304.2	LD7304	CERAMIC PLAO. FREIN	A 008 420 14 20 , 008 420 14 20 , A 000 420 82 00 , 000 420 82 00 , A 008 420 13 20 , 008 420 13 20	
	C 250 CGI		09.2014		13.0470-7304.2	LD7304	CERAMIC PLAO. FREIN	A 008 420 14 20 , 008 420 14 20 , A 000 420 82 00 , 000 420 82 00 , A 008 420 13 20 , 008 420 13 20	
	C 300		09.2015		13.0470-7304.2	LD7304	CERAMIC PLAO. FREIN	A 008 420 14 20 , 008 420 14 20 , A 000 420 82 00 , 000 420 82 00 , A 008 420 13 20 , 008 420 13 20	
	C 300 BlueTec Hybrid		10.2014		13.0470-7304.2	LD7304	CERAMIC PLAO. FREIN	A 008 420 14 20 , 008 420 14 20 , A 000 420 82 00 , 000 420 82 00 , A 008 420 13 20 , 008 420 13 20	
	C 350 e Hybrid		02.2015		13.0470-7304.2	LD7304	CERAMIC PLAO. FREIN	A 008 420 14 20 , 008 420 14 20 , A 000 420 82 00 , 000 420 82 00 , A 008 420 13 20 , 008 420 13 20	
	C 400 4-matic		10.2014		13.0470-7304.2	LD7304	CERAMIC PLAO. FREIN	A 008 420 14 20 , 008 420 14 20 , A 000 420 82 00 , 000 420 82 00 , A 008 420 13 20 , 008 420 13 20	
	C 450 AMG 4-matic		04.2015		13.0470-7304.2	LD7304	CERAMIC PLAO. FREIN	A 008 420 14 20 , 008 420 14 20 , A 000 420 82 00 , 000 420 82 00 , A 008 420 13 20 , 008 420 13 20	





description

Références OE  
par référence  
ATE.

**i**  
Références remplacées /  
divers

## MERCEDES BENZ

C-Klasse (W205) Limousine (14-)	C 160		04.2015		13.0470-7304.2	LD7304	CERAMIC PLAQ. FREIN	A 008 420 14 20 , 008 420 14 20 , A 000 420 82 00 , 000 420 82 00 , A 008 420 13 20 , 008 420 13 20	
	C 180		02.2014		13.0470-7304.2	LD7304	CERAMIC PLAQ. FREIN	A 008 420 14 20 , 008 420 14 20 , A 000 420 82 00 , 000 420 82 00 , A 008 420 13 20 , 008 420 13 20	
	C 180 BlueTec		05.2014		13.0470-7304.2	LD7304	CERAMIC PLAQ. FREIN	A 008 420 14 20 , 008 420 14 20 , A 000 420 82 00 , 000 420 82 00 , A 008 420 13 20 , 008 420 13 20	
	C 200		02.2014		13.0470-7304.2	LD7304	CERAMIC PLAQ. FREIN	A 008 420 14 20 , 008 420 14 20 , A 000 420 82 00 , 000 420 82 00 , A 008 420 13 20 , 008 420 13 20	
	C 200 4-matic		04.2015		13.0470-7304.2	LD7304	CERAMIC PLAQ. FREIN	A 008 420 14 20 , 008 420 14 20 , A 000 420 82 00 , 000 420 82 00 , A 008 420 13 20 , 008 420 13 20	
	C 200 BlueTec		05.2014		13.0470-7304.2	LD7304	CERAMIC PLAQ. FREIN	A 008 420 14 20 , 008 420 14 20 , A 000 420 82 00 , 000 420 82 00 , A 008 420 13 20 , 008 420 13 20	
	C 200 d		10.2015		13.0470-7304.2	LD7304	CERAMIC PLAQ. FREIN	A 008 420 14 20 , 008 420 14 20 , A 000 420 82 00 , 000 420 82 00 , A 008 420 13 20 , 008 420 13 20	
	C 220 BlueTec		02.2014		13.0470-7304.2	LD7304	CERAMIC PLAQ. FREIN	A 008 420 14 20 , 008 420 14 20 , A 000 420 82 00 , 000 420 82 00 , A 008 420 13 20 , 008 420 13 20	
			03.2014		13.0470-7304.2	LD7304	CERAMIC PLAQ. FREIN	A 008 420 14 20 , 008 420 14 20 , A 000 420 82 00 , 000 420 82 00 , A 008 420 13 20 , 008 420 13 20	



description

Références OE  
par référence  
ATE.

Références remplacées /  
divers

## MERCEDES BENZ

C-Klasse (W205) Limousine (14-)	C 220 BlueTec 4-matic		04.2015		13.0470-7304.2	LD7304	CERAMIC PLAQ. FREIN	A 008 420 14 20 , 008 420 14 20 , A 000 420 82 00 , 000 420 82 00 , A 008 420 13 20 , 008 420 13 20	
	C 250 BlueTec		02.2014		13.0470-7304.2	LD7304	CERAMIC PLAQ. FREIN	A 008 420 14 20 , 008 420 14 20 , A 000 420 82 00 , 000 420 82 00 , A 008 420 13 20 , 008 420 13 20	
	C 250 BlueTec 4-matic		02.2014		13.0470-7304.2	LD7304	CERAMIC PLAQ. FREIN	A 008 420 14 20 , 008 420 14 20 , A 000 420 82 00 , 000 420 82 00 , A 008 420 13 20 , 008 420 13 20	
	C 250 CGI		03.2014		13.0470-7304.2	LD7304	CERAMIC PLAQ. FREIN	A 008 420 14 20 , 008 420 14 20 , A 000 420 82 00 , 000 420 82 00 , A 008 420 13 20 , 008 420 13 20	
	C 300		09.2015		13.0470-7304.2	LD7304	CERAMIC PLAQ. FREIN	A 008 420 14 20 , 008 420 14 20 , A 000 420 82 00 , 000 420 82 00 , A 008 420 13 20 , 008 420 13 20	
	C 300 BlueTec Hybrid		05.2014		13.0470-7304.2	LD7304	CERAMIC PLAQ. FREIN	A 008 420 14 20 , 008 420 14 20 , A 000 420 82 00 , 000 420 82 00 , A 008 420 13 20 , 008 420 13 20	
	C 350 e Hybrid		02.2015		13.0470-7304.2	LD7304	CERAMIC PLAQ. FREIN	A 008 420 14 20 , 008 420 14 20 , A 000 420 82 00 , 000 420 82 00 , A 008 420 13 20 , 008 420 13 20	
	C 400 4-matic		10.2014		13.0470-7304.2	LD7304	CERAMIC PLAQ. FREIN	A 008 420 14 20 , 008 420 14 20 , A 000 420 82 00 , 000 420 82 00 , A 008 420 13 20 , 008 420 13 20	
	C 450 AMG 4-matic		04.2015		13.0470-7304.2	LD7304	CERAMIC PLAQ. FREIN	A 008 420 14 20 , 008 420 14 20 , A 000 420 82 00 , 000 420 82 00 , A 008 420 13 20 , 008 420 13 20	



					description	Références OE par référence ATE.		Références remplacées / divers
--	--	--	--	--	-------------	----------------------------------	--	--------------------------------

## MERCEDES BENZ

## MITSUBISHI

i-MiEV (09-14)	i-MiEV		07.2009		03.0137-0525.2	650525	JEU DE MACHOIRE	16 062 267 80 , 4600A335	
			02.2011	04.2014	03.0137-0525.2	650525	JEU DE MACHOIRE	16 062 267 80 , 4600A335	

## PEUGEOT

iON (10-)	Electric		10.2014		03.0137-0525.2	650525	JEU DE MACHOIRE	16 062 267 80 , 4600A335	
			11.2010		03.0137-0525.2	650525	JEU DE MACHOIRE	16 062 267 80 , 4600A335	



description

Références OE  
par référence  
ATE.

**i**  
Références remplacées /  
divers

## PORSCHE

718 BOXSTER (982) (16-)	2	04.2016	03.0137-3054.2	653054	JEU DE MACHOIRE	298 698 533 , 970 352 993 00 , 970 352 993 01 , 970 352 993 02
	S 2,5	04.2016	03.0137-3054.2	653054	JEU DE MACHOIRE	298 698 533 , 970 352 993 00 , 970 352 993 01 , 970 352 993 02
911 CABRIO (991) (12-)	3,0 Carrera	11.2015	03.0137-3054.2	653054	JEU DE MACHOIRE	298 698 533 , 970 352 993 00 , 970 352 993 01 , 970 352 993 02
	3,0 Carrera 4	11.2015	03.0137-3054.2	653054	JEU DE MACHOIRE	298 698 533 , 970 352 993 00 , 970 352 993 01 , 970 352 993 02
	3,0 Carrera 4S	11.2015	03.0137-3054.2	653054	JEU DE MACHOIRE	298 698 533 , 970 352 993 00 , 970 352 993 01 , 970 352 993 02
	3,0 Carrera S	11.2015	03.0137-3054.2	653054	JEU DE MACHOIRE	298 698 533 , 970 352 993 00 , 970 352 993 01 , 970 352 993 02
	3,4 Carrera	03.2012	03.0137-3054.2	653054	JEU DE MACHOIRE	298 698 533 , 970 352 993 00 , 970 352 993 01 , 970 352 993 02
	3,4 Carrera 4S	11.2012	03.0137-3054.2	653054	JEU DE MACHOIRE	298 698 533 , 970 352 993 00 , 970 352 993 01 , 970 352 993 02
	3,8 Carrera 4S	11.2012	03.0137-3054.2	653054	JEU DE MACHOIRE	298 698 533 , 970 352 993 00 , 970 352 993 01 , 970 352 993 02
	3,8 Carrera S	03.2012	03.0137-3054.2	653054	JEU DE MACHOIRE	298 698 533 , 970 352 993 00 , 970 352 993 01 , 970 352 993 02
		07.2012	03.0137-3054.2	653054	JEU DE MACHOIRE	298 698 533 , 970 352 993 00 , 970 352 993 01 , 970 352 993 02



description

Références OE  
par référence  
ATE.

**i**  
Références remplacées /  
divers

## PORSCHE

911 CABRIO (991) (12-)	3,8 Turbo		12.2013		03.0137-3054.2	653054	JEU DE MACHOIRE	298 698 533 , 970 352 993 00 , 970 352 993 01 , 970 352 993 02	
	3,8 Turbo S		12.2013		03.0137-3054.2	653054	JEU DE MACHOIRE	298 698 533 , 970 352 993 00 , 970 352 993 01 , 970 352 993 02	
911 COUPE (991) (11-)	3,0 Carrera		11.2015		03.0137-3054.2	653054	JEU DE MACHOIRE	298 698 533 , 970 352 993 00 , 970 352 993 01 , 970 352 993 02	
	3,0 Carrera 4		11.2015		03.0137-3054.2	653054	JEU DE MACHOIRE	298 698 533 , 970 352 993 00 , 970 352 993 01 , 970 352 993 02	
	3,0 Carrera 4S		11.2015		03.0137-3054.2	653054	JEU DE MACHOIRE	298 698 533 , 970 352 993 00 , 970 352 993 01 , 970 352 993 02	
	3,0 Carrera S		11.2015		03.0137-3054.2	653054	JEU DE MACHOIRE	298 698 533 , 970 352 993 00 , 970 352 993 01 , 970 352 993 02	
	3,4 Carrera		12.2011		03.0137-3054.2	653054	JEU DE MACHOIRE	298 698 533 , 970 352 993 00 , 970 352 993 01 , 970 352 993 02	
	3,4 Carrera 4S		11.2012		03.0137-3054.2	653054	JEU DE MACHOIRE	298 698 533 , 970 352 993 00 , 970 352 993 01 , 970 352 993 02	
	3,8 Carrera 4S		11.2012		03.0137-3054.2	653054	JEU DE MACHOIRE	298 698 533 , 970 352 993 00 , 970 352 993 01 , 970 352 993 02	
	3,8 Carrera S		07.2012		03.0137-3054.2	653054	JEU DE MACHOIRE	298 698 533 , 970 352 993 00 , 970 352 993 01 , 970 352 993 02	
			12.2011		03.0137-3054.2	653054	JEU DE MACHOIRE	298 698 533 , 970 352 993 00 , 970 352 993 01 , 970 352 993 02	



description

Références OE  
par référence  
ATE.



Références remplacées /  
divers

## PORSCHE

911 COUPE (991) (11-)	3,8 GT3		08.2013		03.0137-3054.2	653054	JEU DE MACHOIRE	298 698 533 , 970 352 993 00 , 970 352 993 01 , 970 352 993 02	
	3,8 Turbo		09.2013		03.0137-3054.2	653054	JEU DE MACHOIRE	298 698 533 , 970 352 993 00 , 970 352 993 01 , 970 352 993 02	
	3,8 Turbo S		09.2013		03.0137-3054.2	653054	JEU DE MACHOIRE	298 698 533 , 970 352 993 00 , 970 352 993 01 , 970 352 993 02	
	4,0 GT3 RS		04.2015		03.0137-3054.2	653054	JEU DE MACHOIRE	298 698 533 , 970 352 993 00 , 970 352 993 01 , 970 352 993 02	
911 TARGA (991) (14-)	3,0 Carrera 4		11.2015		03.0137-3054.2	653054	JEU DE MACHOIRE	298 698 533 , 970 352 993 00 , 970 352 993 01 , 970 352 993 02	
	3,0 Carrera 4S		11.2015		03.0137-3054.2	653054	JEU DE MACHOIRE	298 698 533 , 970 352 993 00 , 970 352 993 01 , 970 352 993 02	
	3,4 Carrera 4		05.2014		03.0137-3054.2	653054	JEU DE MACHOIRE	298 698 533 , 970 352 993 00 , 970 352 993 01 , 970 352 993 02	
	3,8 Carrera 4S		05.2014		03.0137-3054.2	653054	JEU DE MACHOIRE	298 698 533 , 970 352 993 00 , 970 352 993 01 , 970 352 993 02	
918 SPYDER (13-15)	4,6		09.2013		03.0137-3054.2	653054	JEU DE MACHOIRE	298 698 533 , 970 352 993 00 , 970 352 993 01 , 970 352 993 02	
BOXSTER (981) (12-)	2,7		04.2012		03.0137-3054.2	653054	JEU DE MACHOIRE	298 698 533 , 970 352 993 00 , 970 352 993 01 , 970 352 993 02	
	3,4 GTS		02.2014		03.0137-3054.2	653054	JEU DE MACHOIRE	298 698 533 , 970 352 993 00 , 970 352 993 01 , 970 352 993 02	



description

Références OE  
par référence  
ATE.



Références remplacées /  
divers

## PORSCHE

BOGNER (981) (12-)	3,4 S		04.2012		03.0137-3054.2	653054	JEU DE MACHOIRE	298 698 533 , 970 352 993 00 , 970 352 993 01 , 970 352 993 02	
BOXSTER Spyder (981) (15-)	3,8		07.2015		03.0137-3054.2	653054	JEU DE MACHOIRE	298 698 533 , 970 352 993 00 , 970 352 993 01 , 970 352 993 02	
CAYMAN (981C) (13-)	2,7		03.2013		03.0137-3054.2	653054	JEU DE MACHOIRE	298 698 533 , 970 352 993 00 , 970 352 993 01 , 970 352 993 02	
	3,4 GTS		02.2014		03.0137-3054.2	653054	JEU DE MACHOIRE	298 698 533 , 970 352 993 00 , 970 352 993 01 , 970 352 993 02	
	3,4 S		03.2013		03.0137-3054.2	653054	JEU DE MACHOIRE	298 698 533 , 970 352 993 00 , 970 352 993 01 , 970 352 993 02	
	3,8 GT4		01.2015		03.0137-3054.2	653054	JEU DE MACHOIRE	298 698 533 , 970 352 993 00 , 970 352 993 01 , 970 352 993 02	
PANAMERA (10-16)	3,0 4S		07.2013		03.0137-3054.2	653054	JEU DE MACHOIRE	298 698 533 , 970 352 993 00 , 970 352 993 01 , 970 352 993 02	
	3,0 D		01.2014		03.0137-3054.2	653054	JEU DE MACHOIRE	298 698 533 , 970 352 993 00 , 970 352 993 01 , 970 352 993 02	
			08.2011		03.0137-3054.2	653054	JEU DE MACHOIRE	298 698 533 , 970 352 993 00 , 970 352 993 01 , 970 352 993 02	
	3,0 S		07.2013		03.0137-3054.2	653054	JEU DE MACHOIRE	298 698 533 , 970 352 993 00 , 970 352 993 01 , 970 352 993 02	
	3,0 S Hybrid		03.2011		03.0137-3054.2	653054	JEU DE MACHOIRE	298 698 533 , 970 352 993 00 , 970 352 993 01 , 970 352 993 02	



description

Références OE  
par référence  
ATE.



Références remplacées /  
divers

## PORSCHE

PANAMERA (10-16)	3,6		05.2010		03.0137-3054.2	653054	JEU DE MACHOIRE	298 698 533 , 970 352 993 00 , 970 352 993 01 , 970 352 993 02	
	3,6 4		05.2010		03.0137-3054.2	653054	JEU DE MACHOIRE	298 698 533 , 970 352 993 00 , 970 352 993 01 , 970 352 993 02	
	4,8 4S		09.2009		03.0137-3054.2	653054	JEU DE MACHOIRE	298 698 533 , 970 352 993 00 , 970 352 993 01 , 970 352 993 02	
	4,8 GTS		01.2012		03.0137-3054.2	653054	JEU DE MACHOIRE	298 698 533 , 970 352 993 00 , 970 352 993 01 , 970 352 993 02	
	4,8 S		09.2009		03.0137-3054.2	653054	JEU DE MACHOIRE	298 698 533 , 970 352 993 00 , 970 352 993 01 , 970 352 993 02	
	4,8 Turbo		09.2009		03.0137-3054.2	653054	JEU DE MACHOIRE	298 698 533 , 970 352 993 00 , 970 352 993 01 , 970 352 993 02	
	4,8 Turbo S		01.2014		03.0137-3054.2	653054	JEU DE MACHOIRE	298 698 533 , 970 352 993 00 , 970 352 993 01 , 970 352 993 02	
			05.2011		03.0137-3054.2	653054	JEU DE MACHOIRE	298 698 533 , 970 352 993 00 , 970 352 993 01 , 970 352 993 02	





description

Références OE  
par référence  
ATE.

**i**  
Références remplacées /  
divers

## SEAT

EXEO / ST (09-13)	1,6		04.2009	06.2013	11.0230-0569.1	260126	CALIPER MOUNT. BRACKET	4B0 615 125 C	
			04.2009	06.2013	11.0230-0560.1	260125	CALIPER MOUNT. BRACKET	4B0 615 125 B	
	1,8 T		04.2009	06.2013	11.0230-0569.1	260126	CALIPER MOUNT. BRACKET	4B0 615 125 C	
			04.2009	06.2013	11.0230-0560.1	260125	CALIPER MOUNT. BRACKET	4B0 615 125 B	
	1,8 TSI		09.2010	06.2013	11.0230-0560.1	260125	CALIPER MOUNT. BRACKET	4B0 615 125 B	
			05.2010	06.2013	11.0230-0560.1	260125	CALIPER MOUNT. BRACKET	4B0 615 125 B	
			05.2010	06.2013	11.0230-0569.1	260126	CALIPER MOUNT. BRACKET	4B0 615 125 C	
			09.2010	06.2013	11.0230-0569.1	260126	CALIPER MOUNT. BRACKET	4B0 615 125 C	
	2,0 TDI		04.2009	06.2013	11.0230-0560.1	260125	CALIPER MOUNT. BRACKET	4B0 615 125 B	
			04.2009	06.2013	11.0230-0569.1	260126	CALIPER MOUNT. BRACKET	4B0 615 125 C	
	2,0 TFSI		04.2009	06.2013	11.0230-0569.1	260126	CALIPER MOUNT. BRACKET	4B0 615 125 C	
			04.2009	06.2013	11.0230-0560.1	260125	CALIPER MOUNT. BRACKET	4B0 615 125 B	
LEON II (1P1) (05-12)	1,2 TSI	ArD	02.2010	10.2012	24.3387-1718.5	240873	ETRIER A GRIFFE	1K0 615 424 N , 8J0 615 424 , 8J0 615 424 C , 1K0 615 424 L , 1K0 615 424 E	24.3387-1718.7
	1,4 i 16V	ArD	06.2006	10.2012	24.3387-1718.5	240873	ETRIER A GRIFFE	1K0 615 424 N , 8J0 615 424 , 8J0 615 424 C , 1K0 615 424 L , 1K0 615 424 E	24.3387-1718.7
	1,4 TSI	ArD	11.2007	10.2012	24.3387-1718.5	240873	ETRIER A GRIFFE	1K0 615 424 N , 8J0 615 424 , 8J0 615 424 C , 1K0 615 424 L , 1K0 615 424 E	24.3387-1718.7
	1,6 i	ArD	08.2005	10.2012	24.3387-1718.5	240873	ETRIER A GRIFFE	1K0 615 424 N , 8J0 615 424 , 8J0 615 424 C , 1K0 615 424 L , 1K0 615 424 E	24.3387-1718.7



description

Références OE  
par référence  
ATE.

**i**  
Références remplacées /  
divers

## SEAT

LEON II (1P1) (05-12)	1,6 LPG / Multifuel	ArD	12.2009	10.2012	24.3387-1718.5	240873	ETRIER A GRIFFE	1K0 615 424 N , 8J0 615 424 , 8J0 615 424 C , 1K0 615 424 L , 1K0 615 424 E	24.3387-1718.7
	1,6 TDI	ArD	11.2010	10.2012	24.3387-1718.5	240873	ETRIER A GRIFFE	1K0 615 424 N , 8J0 615 424 , 8J0 615 424 C , 1K0 615 424 L , 1K0 615 424 E	24.3387-1718.7
	1,6 TDI Ecomotive	ArD	02.2010	10.2012	24.3387-1718.5	240873	ETRIER A GRIFFE	1K0 615 424 N , 8J0 615 424 , 8J0 615 424 C , 1K0 615 424 L , 1K0 615 424 E	24.3387-1718.7
	1,8 TSI	ArD	06.2007	10.2012	24.3387-1718.5	240873	ETRIER A GRIFFE	1K0 615 424 N , 8J0 615 424 , 8J0 615 424 C , 1K0 615 424 L , 1K0 615 424 E	24.3387-1718.7
	1,9 TDI	ArD	08.2005	10.2012	24.3387-1718.5	240873	ETRIER A GRIFFE	1K0 615 424 N , 8J0 615 424 , 8J0 615 424 C , 1K0 615 424 L , 1K0 615 424 E	24.3387-1718.7
	2,0 Cupra R	ArD	11.2006	10.2012	24.3387-1718.5	240873	ETRIER A GRIFFE	1K0 615 424 N , 8J0 615 424 , 8J0 615 424 C , 1K0 615 424 L , 1K0 615 424 E	24.3387-1718.7
	2,0 FSI	ArD	08.2005	10.2012	24.3387-1718.5	240873	ETRIER A GRIFFE	1K0 615 424 N , 8J0 615 424 , 8J0 615 424 C , 1K0 615 424 L , 1K0 615 424 E	24.3387-1718.7
	2,0 TDI	ArD	02.2006	10.2012	24.3387-1718.5	240873	ETRIER A GRIFFE	1K0 615 424 N , 8J0 615 424 , 8J0 615 424 C , 1K0 615 424 L , 1K0 615 424 E	24.3387-1718.7
		ArD	08.2005	10.2012	24.3387-1718.5	240873	ETRIER A GRIFFE	1K0 615 424 N , 8J0 615 424 , 8J0 615 424 C , 1K0 615 424 L , 1K0 615 424 E	24.3387-1718.7
	2,0 TFSI	ArD	11.2006	10.2012	24.3387-1718.5	240873	ETRIER A GRIFFE	1K0 615 424 N , 8J0 615 424 , 8J0 615 424 C , 1K0 615 424 L , 1K0 615 424 E	24.3387-1718.7
		ArD	08.2005	10.2012	24.3387-1718.5	240873	ETRIER A GRIFFE	1K0 615 424 N , 8J0 615 424 , 8J0 615 424 C , 1K0 615 424 L , 1K0 615 424 E	24.3387-1718.7



description





Références OE  
par référence  
ATE.

**i**  
Références remplacées /  
divers

## SEAT

Modèle	Motorisation	ArD	09.2005	10.2012	24.3387-1718.5	240873	description	Références OE par référence ATE.	Références remplacées / divers
LEON II (1P1) (05-12)	2,0 TFSI	ArD	09.2005	10.2012	24.3387-1718.5	240873	ETRIER A GRIFFE	1K0 615 424 N , 8J0 615 424 , 8J0 615 424 C , 1K0 615 424 L , 1K0 615 424 E	24.3387-1718.7
TOLEDO III (5P2) (05-09)	1,4 16V	ArD	05.2006	03.2009	24.3387-1718.5	240873	ETRIER A GRIFFE	1K0 615 424 N , 8J0 615 424 , 8J0 615 424 C , 1K0 615 424 L , 1K0 615 424 E	24.3387-1718.7
	1,4 TSI	ArD	11.2007	03.2009	24.3387-1718.5	240873	ETRIER A GRIFFE	1K0 615 424 N , 8J0 615 424 , 8J0 615 424 C , 1K0 615 424 L , 1K0 615 424 E	24.3387-1718.7
	1,6 i 16V	ArD	10.2004	03.2009	24.3387-1718.5	240873	ETRIER A GRIFFE	1K0 615 424 N , 8J0 615 424 , 8J0 615 424 C , 1K0 615 424 L , 1K0 615 424 E	24.3387-1718.7
	1,8 TFSI	ArD	01.2007	03.2009	24.3387-1718.5	240873	ETRIER A GRIFFE	1K0 615 424 N , 8J0 615 424 , 8J0 615 424 C , 1K0 615 424 L , 1K0 615 424 E	24.3387-1718.7
	1,9 TDI	ArD	10.2004	03.2009	24.3387-1718.5	240873	ETRIER A GRIFFE	1K0 615 424 N , 8J0 615 424 , 8J0 615 424 C , 1K0 615 424 L , 1K0 615 424 E	24.3387-1718.7
	2,0 FSI	ArD	10.2004	03.2009	24.3387-1718.5	240873	ETRIER A GRIFFE	1K0 615 424 N , 8J0 615 424 , 8J0 615 424 C , 1K0 615 424 L , 1K0 615 424 E	24.3387-1718.7
	2,0 TDI	ArD	01.2006	03.2009	24.3387-1718.5	240873	ETRIER A GRIFFE	1K0 615 424 N , 8J0 615 424 , 8J0 615 424 C , 1K0 615 424 L , 1K0 615 424 E	24.3387-1718.7
		ArD	10.2004	03.2009	24.3387-1718.5	240873	ETRIER A GRIFFE	1K0 615 424 N , 8J0 615 424 , 8J0 615 424 C , 1K0 615 424 L , 1K0 615 424 E	24.3387-1718.7
	2,0 TFSI	ArD	11.2005	03.2009	24.3387-1718.5	240873	ETRIER A GRIFFE	1K0 615 424 N , 8J0 615 424 , 8J0 615 424 C , 1K0 615 424 L , 1K0 615 424 E	24.3387-1718.7



					<p>description</p>	<p>Références OE par référence ATE.</p>	 Références remplacées / divers
---	---	---	--	---	--------------------	---	--

## SUBARU

FORESTER (13-)	2,0 D 4WD		03.2013		24.0118-0160.1	418160	DISQUE DE FREIN	26700SG000	
	2,0 XT 4WD		03.2013		24.0118-0160.1	418160	DISQUE DE FREIN	26700SG000	



description

Références OE  
par référence  
ATE.

**i**  
Références remplacées /  
divers

## VOLKSWAGEN

AMAROK (10-)	2,0 BiTDI	ArD	11.2011		24.0711-6252.3	360448	CAPTEUR DE ROUE	2H0 927 808 A	
		ArD	09.2010		24.0711-6252.3	360448	CAPTEUR DE ROUE	2H0 927 808 A	
		ArG	09.2010		24.0711-6251.3	360447	CAPTEUR DE ROUE	2H0 927 807 A	
		ArG	11.2011		24.0711-6251.3	360447	CAPTEUR DE ROUE	2H0 927 807 A	
	2,0 BiTDI 4motion	ArG	09.2010		24.0711-6251.3	360447	CAPTEUR DE ROUE	2H0 927 807 A	
		ArD	09.2010		24.0711-6252.3	360448	CAPTEUR DE ROUE	2H0 927 808 A	
	2,0 TDI	ArG	07.2012		24.0711-6251.3	360447	CAPTEUR DE ROUE	2H0 927 807 A	
		ArD	07.2012		24.0711-6252.3	360448	CAPTEUR DE ROUE	2H0 927 808 A	
		ArD	09.2010		24.0711-6252.3	360448	CAPTEUR DE ROUE	2H0 927 808 A	
		ArG	09.2010		24.0711-6251.3	360447	CAPTEUR DE ROUE	2H0 927 807 A	
	2,0 TDI 4motion	ArG	06.2012		24.0711-6251.3	360447	CAPTEUR DE ROUE	2H0 927 807 A	
		ArG	09.2010		24.0711-6251.3	360447	CAPTEUR DE ROUE	2H0 927 807 A	
		ArG	11.2011		24.0711-6251.3	360447	CAPTEUR DE ROUE	2H0 927 807 A	
		ArD	09.2010		24.0711-6252.3	360448	CAPTEUR DE ROUE	2H0 927 808 A	
		ArD	11.2011		24.0711-6252.3	360448	CAPTEUR DE ROUE	2H0 927 808 A	
		ArD	06.2012		24.0711-6252.3	360448	CAPTEUR DE ROUE	2H0 927 808 A	
	2,0 TSI	ArG	12.2010		24.0711-6251.3	360447	CAPTEUR DE ROUE	2H0 927 807 A	
		ArD	12.2010		24.0711-6252.3	360448	CAPTEUR DE ROUE	2H0 927 808 A	
	3,0 TDI 4motion	ArG	09.2016		24.0711-6251.3	360447	CAPTEUR DE ROUE	2H0 927 807 A	
		ArG	06.2016		24.0711-6251.3	360447	CAPTEUR DE ROUE	2H0 927 807 A	
		ArD	06.2016		24.0711-6252.3	360448	CAPTEUR DE ROUE	2H0 927 808 A	



description

Références OE  
par référence  
ATE.

**i**  
Références remplacées /  
divers

## VOLKSWAGEN

AMAROK (10-)	3,0 TDI 4motion	ArD	09.2016		24.0711-6252.3	360448	CAPTEUR DE ROUE	2H0 927 808 A	
EOS (06-)	1,4 TSI	ArD	10.2007		24.3387-1718.5	240873	ETRIER A GRIFFE	1K0 615 424 N , 8J0 615 424 , 8J0 615 424 C , 1K0 615 424 L , 1K0 615 424 E	24.3387-1718.7
		ArD	05.2008		24.3387-1718.5	240873	ETRIER A GRIFFE	1K0 615 424 N , 8J0 615 424 , 8J0 615 424 C , 1K0 615 424 L , 1K0 615 424 E	24.3387-1718.7
	1,6 FSI	ArD	05.2006		24.3387-1718.5	240873	ETRIER A GRIFFE	1K0 615 424 N , 8J0 615 424 , 8J0 615 424 C , 1K0 615 424 L , 1K0 615 424 E	24.3387-1718.7
	2,0 FSI	ArD	05.2006		24.3387-1718.5	240873	ETRIER A GRIFFE	1K0 615 424 N , 8J0 615 424 , 8J0 615 424 C , 1K0 615 424 L , 1K0 615 424 E	24.3387-1718.7
	2,0 TDI	ArD	05.2006		24.3387-1718.5	240873	ETRIER A GRIFFE	1K0 615 424 N , 8J0 615 424 , 8J0 615 424 C , 1K0 615 424 L , 1K0 615 424 E	24.3387-1718.7
		ArD	11.2010		24.3387-1718.5	240873	ETRIER A GRIFFE	1K0 615 424 N , 8J0 615 424 , 8J0 615 424 C , 1K0 615 424 L , 1K0 615 424 E	24.3387-1718.7
	2,0 TDI 16V	ArD	05.2008		24.3387-1718.5	240873	ETRIER A GRIFFE	1K0 615 424 N , 8J0 615 424 , 8J0 615 424 C , 1K0 615 424 L , 1K0 615 424 E	24.3387-1718.7
	2,0 TFSI	ArD	05.2006		24.3387-1718.5	240873	ETRIER A GRIFFE	1K0 615 424 N , 8J0 615 424 , 8J0 615 424 C , 1K0 615 424 L , 1K0 615 424 E	24.3387-1718.7
	2,0 TSI	ArD	11.2009		24.3387-1718.5	240873	ETRIER A GRIFFE	1K0 615 424 N , 8J0 615 424 , 8J0 615 424 C , 1K0 615 424 L , 1K0 615 424 E	24.3387-1718.7
	3,2 V6	ArD	05.2006		24.3387-1718.5	240873	ETRIER A GRIFFE	1K0 615 424 N , 8J0 615 424 , 8J0 615 424 C , 1K0 615 424 L , 1K0 615 424 E	24.3387-1718.7



description

Références OE  
par référence  
ATE.

**i**  
Références remplacées /  
divers

## VOLKSWAGEN

EOS (06-)	3,6 V6	ArD	05.2009		24.3387-1718.5	240873	ETRIER A GRIFFE	1K0 615 424 N , 8J0 615 424 , 8J0 615 424 C , 1K0 615 424 L , 1K0 615 424 E	24.3387-1718.7
GOLF Plus (05-14)	1,2 TSI	ArD	08.2009	01.2014	24.3387-1718.5	240873	ETRIER A GRIFFE	1K0 615 424 N , 8J0 615 424 , 8J0 615 424 C , 1K0 615 424 L , 1K0 615 424 E	24.3387-1718.7
	1,4 16V	ArD		01.2014	24.3387-1718.5	240873	ETRIER A GRIFFE	1K0 615 424 N , 8J0 615 424 , 8J0 615 424 C , 1K0 615 424 L , 1K0 615 424 E	24.3387-1718.7
	1,4 FSI	ArD		01.2014	24.3387-1718.5	240873	ETRIER A GRIFFE	1K0 615 424 N , 8J0 615 424 , 8J0 615 424 C , 1K0 615 424 L , 1K0 615 424 E	24.3387-1718.7
	1,4 TSI	ArD	06.2008	01.2014	24.3387-1718.5	240873	ETRIER A GRIFFE	1K0 615 424 N , 8J0 615 424 , 8J0 615 424 C , 1K0 615 424 L , 1K0 615 424 E	24.3387-1718.7
		ArD		01.2014	24.3387-1718.5	240873	ETRIER A GRIFFE	1K0 615 424 N , 8J0 615 424 , 8J0 615 424 C , 1K0 615 424 L , 1K0 615 424 E	24.3387-1718.7
	1,6	ArD		01.2014	24.3387-1718.5	240873	ETRIER A GRIFFE	1K0 615 424 N , 8J0 615 424 , 8J0 615 424 C , 1K0 615 424 L , 1K0 615 424 E	24.3387-1718.7
	1,6 BiFuel	ArD	05.2009	01.2014	24.3387-1718.5	240873	ETRIER A GRIFFE	1K0 615 424 N , 8J0 615 424 , 8J0 615 424 C , 1K0 615 424 L , 1K0 615 424 E	24.3387-1718.7
	1,6 FSI	ArD		01.2014	24.3387-1718.5	240873	ETRIER A GRIFFE	1K0 615 424 N , 8J0 615 424 , 8J0 615 424 C , 1K0 615 424 L , 1K0 615 424 E	24.3387-1718.7
	1,6 TDI	ArD	02.2009	01.2014	24.3387-1718.5	240873	ETRIER A GRIFFE	1K0 615 424 N , 8J0 615 424 , 8J0 615 424 C , 1K0 615 424 L , 1K0 615 424 E	24.3387-1718.7
	1,9 TDI	ArD		01.2014	24.3387-1718.5	240873	ETRIER A GRIFFE	1K0 615 424 N , 8J0 615 424 , 8J0 615 424 C , 1K0 615 424 L , 1K0 615 424 E	24.3387-1718.7



description

Références OE  
par référence  
ATE.

**i**  
Références remplacées /  
divers

## VOLKSWAGEN

GOLF Plus (05-14)	2,0 FSI	ArD		01.2014	24.3387-1718.5	240873	ETRIER A GRIFFE	1K0 615 424 N , 8J0 615 424 , 8J0 615 424 C , 1K0 615 424 L , 1K0 615 424 E	24.3387-1718.7
	2,0 TDI	ArD	01.2009	01.2014	24.3387-1718.5	240873	ETRIER A GRIFFE	1K0 615 424 N , 8J0 615 424 , 8J0 615 424 C , 1K0 615 424 L , 1K0 615 424 E	24.3387-1718.7
		ArD		01.2014	24.3387-1718.5	240873	ETRIER A GRIFFE	1K0 615 424 N , 8J0 615 424 , 8J0 615 424 C , 1K0 615 424 L , 1K0 615 424 E	24.3387-1718.7
GOLF V (03-08)	1,4 16V	ArD	10.2003	09.2008	24.3387-1718.5	240873	ETRIER A GRIFFE	1K0 615 424 N , 8J0 615 424 , 8J0 615 424 C , 1K0 615 424 L , 1K0 615 424 E	24.3387-1718.7
	1,4 FSI	ArD	10.2003	09.2008	24.3387-1718.5	240873	ETRIER A GRIFFE	1K0 615 424 N , 8J0 615 424 , 8J0 615 424 C , 1K0 615 424 L , 1K0 615 424 E	24.3387-1718.7
	1,4 TSI	ArD	05.2006	09.2008	24.3387-1718.5	240873	ETRIER A GRIFFE	1K0 615 424 N , 8J0 615 424 , 8J0 615 424 C , 1K0 615 424 L , 1K0 615 424 E	24.3387-1718.7
		ArD	05.2007	09.2008	24.3387-1718.5	240873	ETRIER A GRIFFE	1K0 615 424 N , 8J0 615 424 , 8J0 615 424 C , 1K0 615 424 L , 1K0 615 424 E	24.3387-1718.7
		ArD	11.2005	09.2008	24.3387-1718.5	240873	ETRIER A GRIFFE	1K0 615 424 N , 8J0 615 424 , 8J0 615 424 C , 1K0 615 424 L , 1K0 615 424 E	24.3387-1718.7
	1,6 16V	ArD	01.2004	09.2008	24.3387-1718.5	240873	ETRIER A GRIFFE	1K0 615 424 N , 8J0 615 424 , 8J0 615 424 C , 1K0 615 424 L , 1K0 615 424 E	24.3387-1718.7
	1,6 FSI	ArD	10.2003	09.2008	24.3387-1718.5	240873	ETRIER A GRIFFE	1K0 615 424 N , 8J0 615 424 , 8J0 615 424 C , 1K0 615 424 L , 1K0 615 424 E	24.3387-1718.7
	1,9 TDI	ArD	05.2004	09.2008	24.3387-1718.5	240873	ETRIER A GRIFFE	1K0 615 424 N , 8J0 615 424 , 8J0 615 424 C , 1K0 615 424 L , 1K0 615 424 E	24.3387-1718.7





description

Références OE  
par référence  
ATE.

**i**  
Références remplacées /  
divers

## VOLKSWAGEN

GOLF V (03-08)	1,9 TDI	ArD	10.2003	09.2008	24.3387-1718.5	240873	ETRIER A GRIFFE	1K0 615 424 N , 8J0 615 424 , 8J0 615 424 C , 1K0 615 424 L , 1K0 615 424 E	24.3387-1718.7
	2,0 FSI	ArD	10.2003	09.2008	24.3387-1718.5	240873	ETRIER A GRIFFE	1K0 615 424 N , 8J0 615 424 , 8J0 615 424 C , 1K0 615 424 L , 1K0 615 424 E	24.3387-1718.7
	2,0 GTI	ArD	09.2004	09.2008	24.3387-1718.5	240873	ETRIER A GRIFFE	1K0 615 424 N , 8J0 615 424 , 8J0 615 424 C , 1K0 615 424 L , 1K0 615 424 E	24.3387-1718.7
		ArD	09.2006	09.2008	24.3387-1718.5	240873	ETRIER A GRIFFE	1K0 615 424 N , 8J0 615 424 , 8J0 615 424 C , 1K0 615 424 L , 1K0 615 424 E	24.3387-1718.7
	2,0 SDI	ArD	01.2004	09.2008	24.3387-1718.5	240873	ETRIER A GRIFFE	1K0 615 424 N , 8J0 615 424 , 8J0 615 424 C , 1K0 615 424 L , 1K0 615 424 E	24.3387-1718.7
	2,0 TDI	ArD	10.2003	09.2008	24.3387-1718.5	240873	ETRIER A GRIFFE	1K0 615 424 N , 8J0 615 424 , 8J0 615 424 C , 1K0 615 424 L , 1K0 615 424 E	24.3387-1718.7
		ArD	11.2005	09.2008	24.3387-1718.5	240873	ETRIER A GRIFFE	1K0 615 424 N , 8J0 615 424 , 8J0 615 424 C , 1K0 615 424 L , 1K0 615 424 E	24.3387-1718.7
GOLF VI (08-)	1,2 TSI	ArD	05.2009	10.2009	24.3387-1718.5	240873	ETRIER A GRIFFE	1K0 615 424 N , 8J0 615 424 , 8J0 615 424 C , 1K0 615 424 L , 1K0 615 424 E	24.3387-1718.7
	1,4	ArD	10.2008	10.2009	24.3387-1718.5	240873	ETRIER A GRIFFE	1K0 615 424 N , 8J0 615 424 , 8J0 615 424 C , 1K0 615 424 L , 1K0 615 424 E	24.3387-1718.7
	1,4 TSI	ArD	10.2008	10.2009	24.3387-1718.5	240873	ETRIER A GRIFFE	1K0 615 424 N , 8J0 615 424 , 8J0 615 424 C , 1K0 615 424 L , 1K0 615 424 E	24.3387-1718.7
	1,6	ArD	10.2008	10.2009	24.3387-1718.5	240873	ETRIER A GRIFFE	1K0 615 424 N , 8J0 615 424 , 8J0 615 424 C , 1K0 615 424 L , 1K0 615 424 E	24.3387-1718.7



description

Références OE  
par référence  
ATE.

**i**  
Références remplacées /  
divers

## VOLKSWAGEN

GOLF VI (08-)	1,6 BiFuel	ArD	03.2009	10.2009	24.3387-1718.5	240873	ETRIER A GRIFFE	1K0 615 424 N , 8J0 615 424 , 8J0 615 424 C , 1K0 615 424 L , 1K0 615 424 E	24.3387-1718.7
	1,6 TDI	ArD	02.2009	10.2009	24.3387-1718.5	240873	ETRIER A GRIFFE	1K0 615 424 N , 8J0 615 424 , 8J0 615 424 C , 1K0 615 424 L , 1K0 615 424 E	24.3387-1718.7
	1,8 TSI	ArD	06.2009	10.2009	24.3387-1718.5	240873	ETRIER A GRIFFE	1K0 615 424 N , 8J0 615 424 , 8J0 615 424 C , 1K0 615 424 L , 1K0 615 424 E	24.3387-1718.7
	2,0 GTi	ArD	04.2009	10.2009	24.3387-1718.5	240873	ETRIER A GRIFFE	1K0 615 424 N , 8J0 615 424 , 8J0 615 424 C , 1K0 615 424 L , 1K0 615 424 E	24.3387-1718.7
	2,0 TDI	ArD	04.2009	10.2009	24.3387-1718.5	240873	ETRIER A GRIFFE	1K0 615 424 N , 8J0 615 424 , 8J0 615 424 C , 1K0 615 424 L , 1K0 615 424 E	24.3387-1718.7
		ArD	10.2008	10.2009	24.3387-1718.5	240873	ETRIER A GRIFFE	1K0 615 424 N , 8J0 615 424 , 8J0 615 424 C , 1K0 615 424 L , 1K0 615 424 E	24.3387-1718.7



description

Références OE  
par référence  
ATE.

**i**  
Références remplacées /  
divers

## VOLVO

S90 II (16-)	2,0 D4	AR	03.2016		24.0711-5443.3	360451	CAPTEUR DE ROUE	31362355	
		AV	03.2016		24.0711-5473.3	360452	CAPTEUR DE ROUE	31362356	
	2,0 D5 AWD	AV	03.2016		24.0711-5473.3	360452	CAPTEUR DE ROUE	31362356	
		AR	03.2016		24.0711-5443.3	360451	CAPTEUR DE ROUE	31362355	
	2,0 T5	AV	03.2016		24.0711-5473.3	360452	CAPTEUR DE ROUE	31362356	
		AR	03.2016		24.0711-5443.3	360451	CAPTEUR DE ROUE	31362355	
	2,0 T6 AWD	AR	03.2016		24.0711-5443.3	360451	CAPTEUR DE ROUE	31362355	
		AV	03.2016		24.0711-5473.3	360452	CAPTEUR DE ROUE	31362356	
V90 II (16-)	2,0 D3	AR	03.2016		24.0711-5443.3	360451	CAPTEUR DE ROUE	31362355	
		AV	03.2016		24.0711-5473.3	360452	CAPTEUR DE ROUE	31362356	
	2,0 D3 AWD	AR	03.2016		24.0711-5443.3	360451	CAPTEUR DE ROUE	31362355	
		AV	03.2016		24.0711-5473.3	360452	CAPTEUR DE ROUE	31362356	
	2,0 D4	AR	03.2016		24.0711-5443.3	360451	CAPTEUR DE ROUE	31362355	
		AV	03.2016		24.0711-5473.3	360452	CAPTEUR DE ROUE	31362356	
	2,0 D4 AWD	AV	03.2016		24.0711-5473.3	360452	CAPTEUR DE ROUE	31362356	
		AR	03.2016		24.0711-5443.3	360451	CAPTEUR DE ROUE	31362355	
	2,0 D5 AWD	AR	03.2016		24.0711-5443.3	360451	CAPTEUR DE ROUE	31362355	
		AV	03.2016		24.0711-5473.3	360452	CAPTEUR DE ROUE	31362356	
	2,0 T5	AR	03.2016		24.0711-5443.3	360451	CAPTEUR DE ROUE	31362355	
		AV	03.2016		24.0711-5473.3	360452	CAPTEUR DE ROUE	31362356	
	2,0 T5 AWD	AV	03.2016		24.0711-5473.3	360452	CAPTEUR DE ROUE	31362356	



description





Références OE  
par référence  
ATE.

**i**  
Références remplacées /  
divers

## VOLVO

V90 II (16-)	2,0 T5 AWD	AR	03.2016		24.0711-5443.3	360451	CAPTEUR DE ROUE	31362355	
	2,0 T6 AWD	AV	03.2016		24.0711-5473.3	360452	CAPTEUR DE ROUE	31362356	
		AR	03.2016		24.0711-5443.3	360451	CAPTEUR DE ROUE	31362355	
XC90 (02-14)	2,4 D3	ArD	04.2010	12.2014	24.3441-9966.5	240674	ETRIER A GRIFFE	8602855 , 8602726	11.9441-9966.2
	2,4 D5	ArD	05.2006	12.2014	24.3441-9966.5	240674	ETRIER A GRIFFE	8602855 , 8602726	11.9441-9966.2
		ArD	04.2009	12.2014	24.3441-9966.5	240674	ETRIER A GRIFFE	8602855 , 8602726	11.9441-9966.2
	2,4 D5 AWD	ArD	10.2002	12.2014	24.3441-9966.5	240674	ETRIER A GRIFFE	8602855 , 8602726	11.9441-9966.2
		ArD	01.2011	12.2014	24.3441-9966.5	240674	ETRIER A GRIFFE	8602855 , 8602726	11.9441-9966.2
	2,5 T	ArD	10.2002	12.2014	24.3441-9966.5	240674	ETRIER A GRIFFE	8602855 , 8602726	11.9441-9966.2
	2,5 T AWD	ArD	10.2012	12.2014	24.3441-9966.5	240674	ETRIER A GRIFFE	8602855 , 8602726	11.9441-9966.2
	3,0 T6	ArD	10.2002	12.2014	24.3441-9966.5	240674	ETRIER A GRIFFE	8602855 , 8602726	11.9441-9966.2
	3,2	ArD	04.2010	12.2014	24.3441-9966.5	240674	ETRIER A GRIFFE	8602855 , 8602726	11.9441-9966.2
		ArD	05.2006	12.2014	24.3441-9966.5	240674	ETRIER A GRIFFE	8602855 , 8602726	11.9441-9966.2
	4,0 V8	ArD	01.2005	12.2014	24.3441-9966.5	240674	ETRIER A GRIFFE	8602855 , 8602726	11.9441-9966.2
XC90 (14-)	2,0 D5 AWD	AR	09.2014		24.0711-5443.3	360451	CAPTEUR DE ROUE	31362355	
		AV	09.2014		24.0711-5473.3	360452	CAPTEUR DE ROUE	31362356	
	2,0 T5 AWD	AV	06.2015		24.0711-5473.3	360452	CAPTEUR DE ROUE	31362356	
		AR	06.2015		24.0711-5443.3	360451	CAPTEUR DE ROUE	31362355	
	2,0 T6 AWD	AR	09.2014		24.0711-5443.3	360451	CAPTEUR DE ROUE	31362355	
		AV	09.2014		24.0711-5473.3	360452	CAPTEUR DE ROUE	31362356	
	2,0 T8 Hybrid	AV	09.2014		24.0711-5473.3	360452	CAPTEUR DE ROUE	31362356	



					<p>description</p>	<p>Références OE par référence ATE.</p>	 <p>Références remplacées / divers</p>
---	---	---	--	---	--------------------	---	---

## VOLVO

XC90 (14-)	2,0 T8 Hybrid	AR	09.2014		24.0711-5443.3	360451	CAPTEUR DE ROUE	31362355	
	D5 AWD	AR	09.2014		24.0711-5443.3	360451	CAPTEUR DE ROUE	31362355	
		AV	09.2014		24.0711-5473.3	360452	CAPTEUR DE ROUE	31362356	

**13.0460-7306.2 607306**

**Applications:**

BMW Série 7/E65-66 (02-08)

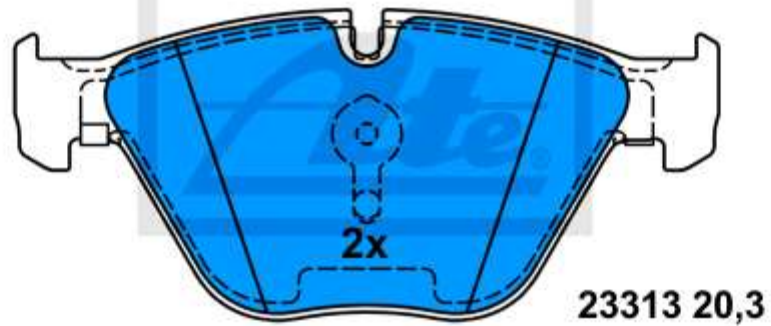
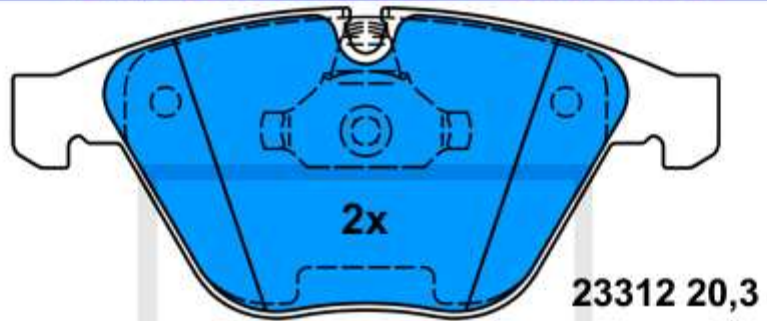

155,1 x 68,3