



Nouvelles références disponibles

par applications

05/2017

www.ate.de





description

Références OE
par référence
ATE.

i
Références remplacées /
divers

AUDI

A3 (8V) Cabrio (13-)	1,4 TFSI		05.2014		24.4123-1719.3	011017	TANDEM MASTER CYLINDE	8V1 611 021 A	
			10.2013		24.4123-1719.3	011017	TANDEM MASTER CYLINDE	8V1 611 021 A	
			02.2016		24.4123-1719.3	011017	TANDEM MASTER CYLINDE	8V1 611 021 A	
	1,6 TDI		10.2013		24.4123-1719.3	011017	TANDEM MASTER CYLINDE	8V1 611 021 A	
	1,8 TFSI		10.2013		24.4123-1719.3	011017	TANDEM MASTER CYLINDE	8V1 611 021 A	
	1,8 TFSI quattro		03.2014		24.4123-1719.3	011017	TANDEM MASTER CYLINDE	8V1 611 021 A	
	2,0 TDI		10.2013		24.4123-1719.3	011017	TANDEM MASTER CYLINDE	8V1 611 021 A	
			05.2014		24.4123-1719.3	011017	TANDEM MASTER CYLINDE	8V1 611 021 A	
	2,0 TDI quattro		05.2014		24.4123-1719.3	011017	TANDEM MASTER CYLINDE	8V1 611 021 A	
			03.2014		24.4123-1719.3	011017	TANDEM MASTER CYLINDE	8V1 611 021 A	
	2,0 TFSI		05.2016		24.4123-1719.3	011017	TANDEM MASTER CYLINDE	8V1 611 021 A	
	2,0 TFSI quattro		05.2014		24.4123-1719.3	011017	TANDEM MASTER CYLINDE	8V1 611 021 A	
			05.2016		24.4123-1719.3	011017	TANDEM MASTER CYLINDE	8V1 611 021 A	
A3 / A3 (8V) Sportback (12-)	1,0 TFSI		07.2016		24.4123-1719.3	011017	TANDEM MASTER CYLINDE	8V1 611 021 A	
	1,2 TFSI		05.2014		24.4123-1719.3	011017	TANDEM MASTER CYLINDE	8V1 611 021 A	
			02.2013		24.4123-1719.3	011017	TANDEM MASTER CYLINDE	8V1 611 021 A	
	1,4 TFSI		08.2012		24.4123-1719.3	011017	TANDEM MASTER CYLINDE	8V1 611 021 A	
			10.2012		24.4123-1719.3	011017	TANDEM MASTER CYLINDE	8V1 611 021 A	
			09.2013		24.4123-1719.3	011017	TANDEM MASTER CYLINDE	8V1 611 021 A	
			05.2014		24.4123-1719.3	011017	TANDEM MASTER CYLINDE	8V1 611 021 A	
	1,4 TFSI e-tron		02.2014		24.4123-1719.3	011017	TANDEM MASTER CYLINDE	8V1 611 021 A	



description

Références OE
par référence
ATE.

i
Références remplacées /
divers

AUDI

A3 / A3 (8V) Sportback (12-)	1,4 TFSI g-tron		02.2014		24.4123-1719.3	011017	TANDEM MASTER CYLINDE	8V1 611 021 A	
	1,6 TDI		08.2013		24.4123-1719.3	011017	TANDEM MASTER CYLINDE	8V1 611 021 A	
			09.2012		24.4123-1719.3	011017	TANDEM MASTER CYLINDE	8V1 611 021 A	
	1,6 TDI quattro		05.2015		24.4123-1719.3	011017	TANDEM MASTER CYLINDE	8V1 611 021 A	
	1,8 TFSI		08.2012		24.4123-1719.3	011017	TANDEM MASTER CYLINDE	8V1 611 021 A	
	1,8 TFSI quattro		08.2012		24.4123-1719.3	011017	TANDEM MASTER CYLINDE	8V1 611 021 A	
	2,0 TDI		01.2013		24.4123-1719.3	011017	TANDEM MASTER CYLINDE	8V1 611 021 A	
			08.2012		24.4123-1719.3	011017	TANDEM MASTER CYLINDE	8V1 611 021 A	
			12.2012		24.4123-1719.3	011017	TANDEM MASTER CYLINDE	8V1 611 021 A	
			05.2013		24.4123-1719.3	011017	TANDEM MASTER CYLINDE	8V1 611 021 A	
	2,0 TDI quattro		12.2012		24.4123-1719.3	011017	TANDEM MASTER CYLINDE	8V1 611 021 A	
			10.2012		24.4123-1719.3	011017	TANDEM MASTER CYLINDE	8V1 611 021 A	
	2,0 TFSI		05.2016		24.4123-1719.3	011017	TANDEM MASTER CYLINDE	8V1 611 021 A	
	2,0 TFSI quattro		05.2016		24.4123-1719.3	011017	TANDEM MASTER CYLINDE	8V1 611 021 A	
Q2 (16-)	1,0 TFSI		09.2016		24.4123-1719.3	011017	TANDEM MASTER CYLINDE	8V1 611 021 A	
	1,4 TFSI		09.2016		24.4123-1719.3	011017	TANDEM MASTER CYLINDE	8V1 611 021 A	
	1,4 TFSI quattro		09.2016		24.4123-1719.3	011017	TANDEM MASTER CYLINDE	8V1 611 021 A	
	1,6 TDI		09.2016		24.4123-1719.3	011017	TANDEM MASTER CYLINDE	8V1 611 021 A	
	2,0 TDI		09.2016		24.4123-1719.3	011017	TANDEM MASTER CYLINDE	8V1 611 021 A	
	2,0 TDI quattro		09.2016		24.4123-1719.3	011017	TANDEM MASTER CYLINDE	8V1 611 021 A	
	2,0 TFSI quattro		09.2016		24.4123-1719.3	011017	TANDEM MASTER CYLINDE	8V1 611 021 A	



description

Références OE
par référence
ATE.

i
Références remplacées /
divers

AUDI

TT (14-)	1,8 TFSI		07.2015		24.4123-1719.3	011017	TANDEM MASTER CYLINDE	8V1 611 021 A	
	2,0 TDI		07.2014		24.4123-1719.3	011017	TANDEM MASTER CYLINDE	8V1 611 021 A	
	2,0 TDI quattro		07.2014		24.4123-1719.3	011017	TANDEM MASTER CYLINDE	8V1 611 021 A	
	2,0 TFSI		07.2014		24.4123-1719.3	011017	TANDEM MASTER CYLINDE	8V1 611 021 A	
	2,0 TFSI quattro		07.2014		24.4123-1719.3	011017	TANDEM MASTER CYLINDE	8V1 611 021 A	
			07.2015		24.4123-1719.3	011017	TANDEM MASTER CYLINDE	8V1 611 021 A	
TT Coupe (06-14)	2,0 quattro	ArG	05.2008	06.2014	24.3417-1711.5	240766	ETRIER A GRIFFE	8J0 615 423 A , 8J0 615 423 D , 1K0 615 423 K , 1K0 615 423 B	24.3417-1711.7
		ArD	05.2008	06.2014	24.3417-1712.5	240767	ETRIER A GRIFFE	8J0 615 424 A , 8J0 615 424 D , 1K0 615 424 K , 1K0 615 424 B	24.3417-1712.7
	2,0 TDI quattro	ArD	06.2008	06.2014	24.3417-1712.5	240767	ETRIER A GRIFFE	8J0 615 424 A , 8J0 615 424 D , 1K0 615 424 K , 1K0 615 424 B	24.3417-1712.7
		ArG	06.2008	06.2014	24.3417-1711.5	240766	ETRIER A GRIFFE	8J0 615 423 A , 8J0 615 423 D , 1K0 615 423 K , 1K0 615 423 B	24.3417-1711.7
	2,0 TFSI quattro	ArG	05.2008	06.2014	24.3417-1711.5	240766	ETRIER A GRIFFE	8J0 615 423 A , 8J0 615 423 D , 1K0 615 423 K , 1K0 615 423 B	24.3417-1711.7
		ArD	05.2008	06.2014	24.3417-1712.5	240767	ETRIER A GRIFFE	8J0 615 424 A , 8J0 615 424 D , 1K0 615 424 K , 1K0 615 424 B	24.3417-1712.7
	3,2 quattro	ArG	07.2006	06.2014	24.3417-1711.5	240766	ETRIER A GRIFFE	8J0 615 423 A , 8J0 615 423 D , 1K0 615 423 K , 1K0 615 423 B	24.3417-1711.7
		ArD	07.2006	06.2014	24.3417-1712.5	240767	ETRIER A GRIFFE	8J0 615 424 A , 8J0 615 424 D , 1K0 615 424 K , 1K0 615 424 B	24.3417-1712.7



	i				description	Références OE par référence ATE.	i Références remplacées / divers
--	----------	--	--	--	--------------------	---	---

AUDI

TT Roadster (07-14)	1,8 TFSI	ArD	06.2008	06.2014	24.3417-1712.5	240767	ETRIER A GRIFFE	8J0 615 424 A , 8J0 615 424 D , 1K0 615 424 K , 1K0 615 424 B	24.3417-1712.7
		ArG	06.2008	06.2014	24.3417-1711.5	240766	ETRIER A GRIFFE	8J0 615 423 A , 8J0 615 423 D , 1K0 615 423 K , 1K0 615 423 B	24.3417-1711.7
	2,0 TFSI	ArG	02.2007	06.2014	24.3417-1711.5	240766	ETRIER A GRIFFE	8J0 615 423 A , 8J0 615 423 D , 1K0 615 423 K , 1K0 615 423 B	24.3417-1711.7
		ArD	05.2010	06.2014	24.3417-1712.5	240767	ETRIER A GRIFFE	8J0 615 424 A , 8J0 615 424 D , 1K0 615 424 K , 1K0 615 424 B	24.3417-1712.7
		ArG	05.2010	06.2014	24.3417-1711.5	240766	ETRIER A GRIFFE	8J0 615 423 A , 8J0 615 423 D , 1K0 615 423 K , 1K0 615 423 B	24.3417-1711.7
		ArD	02.2007	06.2014	24.3417-1712.5	240767	ETRIER A GRIFFE	8J0 615 424 A , 8J0 615 424 D , 1K0 615 424 K , 1K0 615 424 B	24.3417-1712.7



description

Références OE
par référence
ATE.

i
Références remplacées /
divers

BMW

1er Reihe/E81/E87 Limousine (04-11)	120 d	AvD	09.2004	02.2007	24.3541-9576.5	240682	ETRIER A GRIFFE	34 11 6 766 682	11.9541-9576.2
	120 i	AvD	09.2004	12.2005	24.3541-9576.5	240682	ETRIER A GRIFFE	34 11 6 766 682	11.9541-9576.2
2er Reihe/F45 Active Tourer (14-)	214 d		03.2015		24.0110-0401.1	410401	DISQUE DE FREIN	34 21 6 799 367	
	216 d		10.2014		24.0110-0401.1	410401	DISQUE DE FREIN	34 21 6 799 367	
	216 i		11.2015		24.0110-0401.1	410401	DISQUE DE FREIN	34 21 6 799 367	
	218 d		10.2014		24.0110-0401.1	410401	DISQUE DE FREIN	34 21 6 799 367	
			09.2014		24.0110-0401.1	410401	DISQUE DE FREIN	34 21 6 799 367	
	218 d xDrive		11.2015		24.0110-0401.1	410401	DISQUE DE FREIN	34 21 6 799 367	
	218 i		10.2014		24.0110-0401.1	410401	DISQUE DE FREIN	34 21 6 799 367	
	220 d		10.2014		24.0110-0401.1	410401	DISQUE DE FREIN	34 21 6 799 367	
			11.2014		24.0110-0401.1	410401	DISQUE DE FREIN	34 21 6 799 367	
	220 d xDrive		11.2014		24.0110-0401.1	410401	DISQUE DE FREIN	34 21 6 799 367	
			10.2014		24.0110-0401.1	410401	DISQUE DE FREIN	34 21 6 799 367	
	220 i		10.2014		24.0110-0401.1	410401	DISQUE DE FREIN	34 21 6 799 367	
			11.2014		24.0110-0401.1	410401	DISQUE DE FREIN	34 21 6 799 367	
2er Reihe/F46 Gran Tourer (15-)	214 d		03.2015		24.0110-0401.1	410401	DISQUE DE FREIN	34 21 6 799 367	
	216 d		03.2015		24.0110-0401.1	410401	DISQUE DE FREIN	34 21 6 799 367	
	216 i		07.2015		24.0110-0401.1	410401	DISQUE DE FREIN	34 21 6 799 367	
	218 d		03.2015		24.0110-0401.1	410401	DISQUE DE FREIN	34 21 6 799 367	
	218 d xDrive		03.2015		24.0110-0401.1	410401	DISQUE DE FREIN	34 21 6 799 367	
	218 i		03.2015		24.0110-0401.1	410401	DISQUE DE FREIN	34 21 6 799 367	



description

Références OE
par référence
ATE.

i
Références remplacées /
divers

BMW

2er Reihe/F46 Gran Tourer (15-)	220 d		07.2015		24.0110-0401.1	410401	DISQUE DE FREIN	34 21 6 799 367	
	220 d xDrive		03.2015		24.0110-0401.1	410401	DISQUE DE FREIN	34 21 6 799 367	
	220 i		03.2015		24.0110-0401.1	410401	DISQUE DE FREIN	34 21 6 799 367	
3er Reihe/E90 Limousine (05-12)	316 i	AvD	01.2005	08.2007	24.3541-9576.5	240682	ETRIER A GRIFFE	34 11 6 766 682	11.9541-9576.2
	318 d	AvD	09.2005	08.2007	24.3541-9576.5	240682	ETRIER A GRIFFE	34 11 6 766 682	11.9541-9576.2
	318 i	AvD	09.2005	08.2007	24.3541-9576.5	240682	ETRIER A GRIFFE	34 11 6 766 682	11.9541-9576.2
	320 i	AvD	12.2004	08.2007	24.3541-9576.5	240682	ETRIER A GRIFFE	34 11 6 766 682	11.9541-9576.2
Série 5/E39 (96-03)	520 d	ArG	04.2000	07.2003	24.5201-0100.3	331512	FLEXIBLE FREIN	34 32 1 162 616	83.6235-0100.3
		ArG	04.2000	07.2003	24.5201-0100.3	331512	FLEXIBLE FREIN	34 32 1 162 616	83.6235-0100.3
	520 d Touring	ArG	04.2000	07.2003	24.5201-0100.3	331512	FLEXIBLE FREIN	34 32 1 162 616	83.6235-0100.3
		ArG	04.2000	07.2003	24.5201-0100.3	331512	FLEXIBLE FREIN	34 32 1 162 616	83.6235-0100.3
	520 i	ArG	03.1996	07.2003	24.5201-0100.3	331512	FLEXIBLE FREIN	34 32 1 162 616	83.6235-0100.3
		ArG	03.1996	07.2003	24.5201-0100.3	331512	FLEXIBLE FREIN	34 32 1 162 616	83.6235-0100.3
	520 i Touring	ArG	05.1997	07.2003	24.5201-0100.3	331512	FLEXIBLE FREIN	34 32 1 162 616	83.6235-0100.3
		ArG	05.1997	07.2003	24.5201-0100.3	331512	FLEXIBLE FREIN	34 32 1 162 616	83.6235-0100.3
	523 i	ArG	12.1995	09.2000	24.5201-0100.3	331512	FLEXIBLE FREIN	34 32 1 162 616	83.6235-0100.3
		ArG	12.1995	09.2000	24.5201-0100.3	331512	FLEXIBLE FREIN	34 32 1 162 616	83.6235-0100.3
	523 i Touring	ArG	05.1997	09.2000	24.5201-0100.3	331512	FLEXIBLE FREIN	34 32 1 162 616	83.6235-0100.3
		ArG	05.1997	09.2000	24.5201-0100.3	331512	FLEXIBLE FREIN	34 32 1 162 616	83.6235-0100.3
	525 d	ArG	04.2000	07.2003	24.5201-0100.3	331512	FLEXIBLE FREIN	34 32 1 162 616	83.6235-0100.3
		ArG	04.2000	07.2003	24.5201-0100.3	331512	FLEXIBLE FREIN	34 32 1 162 616	83.6235-0100.3



description

Références OE
par référence
ATE.

i
Références remplacées /
divers

BMW

Série 5/E39 (96-03)	525 d Touring	ArG	04.2000	07.2003	24.5201-0100.3	331512	FLEXIBLE FREIN	34 32 1 162 616	83.6235-0100.3
		ArG	04.2000	07.2003	24.5201-0100.3	331512	FLEXIBLE FREIN	34 32 1 162 616	83.6235-0100.3
	525 i	ArG	10.2000	07.2003	24.5201-0100.3	331512	FLEXIBLE FREIN	34 32 1 162 616	83.6235-0100.3
		ArG	10.2000	07.2003	24.5201-0100.3	331512	FLEXIBLE FREIN	34 32 1 162 616	83.6235-0100.3
	525 i Touring	ArG	10.2000	07.2003	24.5201-0100.3	331512	FLEXIBLE FREIN	34 32 1 162 616	83.6235-0100.3
		ArG	10.2000	07.2003	24.5201-0100.3	331512	FLEXIBLE FREIN	34 32 1 162 616	83.6235-0100.3
	525 td	ArG	01.1997	09.2000	24.5201-0100.3	331512	FLEXIBLE FREIN	34 32 1 162 616	83.6235-0100.3
		ArG	01.1997	09.2000	24.5201-0100.3	331512	FLEXIBLE FREIN	34 32 1 162 616	83.6235-0100.3
	525 tds	ArG	02.1996	09.2000	24.5201-0100.3	331512	FLEXIBLE FREIN	34 32 1 162 616	83.6235-0100.3
		ArG	02.1996	09.2000	24.5201-0100.3	331512	FLEXIBLE FREIN	34 32 1 162 616	83.6235-0100.3
	525 tds Touring	ArG	06.1998	09.2000	24.5201-0100.3	331512	FLEXIBLE FREIN	34 32 1 162 616	83.6235-0100.3
		ArG	06.1998	09.2000	24.5201-0100.3	331512	FLEXIBLE FREIN	34 32 1 162 616	83.6235-0100.3
	528 i	ArG	12.1995	09.2000	24.5201-0100.3	331512	FLEXIBLE FREIN	34 32 1 162 616	83.6235-0100.3
		ArG	12.1995	09.2000	24.5201-0100.3	331512	FLEXIBLE FREIN	34 32 1 162 616	83.6235-0100.3
	528 i Touring	ArG	05.1997	09.2000	24.5201-0100.3	331512	FLEXIBLE FREIN	34 32 1 162 616	83.6235-0100.3
		ArG	05.1997	09.2000	24.5201-0100.3	331512	FLEXIBLE FREIN	34 32 1 162 616	83.6235-0100.3
	530 d	ArG	09.1998	07.2003	24.5201-0100.3	331512	FLEXIBLE FREIN	34 32 1 162 616	83.6235-0100.3
		ArG	09.1998	07.2003	24.5201-0100.3	331512	FLEXIBLE FREIN	34 32 1 162 616	83.6235-0100.3
	530 d Touring	ArG	09.1998	07.2003	24.5201-0100.3	331512	FLEXIBLE FREIN	34 32 1 162 616	83.6235-0100.3
		ArG	09.1998	07.2003	24.5201-0100.3	331512	FLEXIBLE FREIN	34 32 1 162 616	83.6235-0100.3
	530 i	ArG	10.2000	07.2003	24.5201-0100.3	331512	FLEXIBLE FREIN	34 32 1 162 616	83.6235-0100.3



description

Références OE
par référence
ATE.

i
Références remplacées /
divers

BMW

Série	Modèle	ArG	10.2000	07.2003	24.5201-0100.3	331512	FLEXIBLE FREIN	34 32 1 162 616	83.6235-0100.3
Série 5/E39 (96-03)	530 i	ArG	10.2000	07.2003	24.5201-0100.3	331512	FLEXIBLE FREIN	34 32 1 162 616	83.6235-0100.3
	530 i Touring	ArG	10.2000	07.2003	24.5201-0100.3	331512	FLEXIBLE FREIN	34 32 1 162 616	83.6235-0100.3
		ArG	10.2000	07.2003	24.5201-0100.3	331512	FLEXIBLE FREIN	34 32 1 162 616	83.6235-0100.3
	535 i	ArG	05.1996	07.2003	24.5201-0100.3	331512	FLEXIBLE FREIN	34 32 1 162 616	83.6235-0100.3
		ArG	05.1996	07.2003	24.5201-0100.3	331512	FLEXIBLE FREIN	34 32 1 162 616	83.6235-0100.3
	540 i	ArG	05.1996	07.2003	24.5201-0100.3	331512	FLEXIBLE FREIN	34 32 1 162 616	83.6235-0100.3
		ArG	05.1996	07.2003	24.5201-0100.3	331512	FLEXIBLE FREIN	34 32 1 162 616	83.6235-0100.3
	540 i Touring	ArG	05.1997	07.2003	24.5201-0100.3	331512	FLEXIBLE FREIN	34 32 1 162 616	83.6235-0100.3
		ArG	05.1997	07.2003	24.5201-0100.3	331512	FLEXIBLE FREIN	34 32 1 162 616	83.6235-0100.3
	M5	ArG	10.1998	07.2003	24.5201-0100.3	331512	FLEXIBLE FREIN	34 32 1 162 616	83.6235-0100.3
		ArG	10.1998	07.2003	24.5201-0100.3	331512	FLEXIBLE FREIN	34 32 1 162 616	83.6235-0100.3
Série 7/E38 (93-01)	725 tds	ArG	05.1996	11.2001	24.5201-0100.3	331512	FLEXIBLE FREIN	34 32 1 162 616	83.6235-0100.3
		ArG	05.1996	11.2001	24.5201-0100.3	331512	FLEXIBLE FREIN	34 32 1 162 616	83.6235-0100.3
	728 i	ArG	07.1995	11.2001	24.5201-0100.3	331512	FLEXIBLE FREIN	34 32 1 162 616	83.6235-0100.3
		ArG	07.1995	11.2001	24.5201-0100.3	331512	FLEXIBLE FREIN	34 32 1 162 616	83.6235-0100.3
	728 iL	ArG	01.1996	11.2001	24.5201-0100.3	331512	FLEXIBLE FREIN	34 32 1 162 616	83.6235-0100.3
		ArG	01.1996	11.2001	24.5201-0100.3	331512	FLEXIBLE FREIN	34 32 1 162 616	83.6235-0100.3
	730 d	ArG	09.1998	11.2001	24.5201-0100.3	331512	FLEXIBLE FREIN	34 32 1 162 616	83.6235-0100.3
		ArG	09.1998	11.2001	24.5201-0100.3	331512	FLEXIBLE FREIN	34 32 1 162 616	83.6235-0100.3
	730 i	ArG	07.1993	11.2001	24.5201-0100.3	331512	FLEXIBLE FREIN	34 32 1 162 616	83.6235-0100.3
		ArG	07.1993	11.2001	24.5201-0100.3	331512	FLEXIBLE FREIN	34 32 1 162 616	83.6235-0100.3



description

Références OE
par référence
ATE.

i
Références remplacées /
divers

BMW

Série 7/E38 (93-01)	730 iL	ArG	05.1994	11.2001	24.5201-0100.3	331512	FLEXIBLE FREIN	34 32 1 162 616	83.6235-0100.3
		ArG	05.1994	11.2001	24.5201-0100.3	331512	FLEXIBLE FREIN	34 32 1 162 616	83.6235-0100.3
	735 i	ArG	01.1996	11.2001	24.5201-0100.3	331512	FLEXIBLE FREIN	34 32 1 162 616	83.6235-0100.3
		ArG	01.1996	11.2001	24.5201-0100.3	331512	FLEXIBLE FREIN	34 32 1 162 616	83.6235-0100.3
	735 iL	ArG	01.1996	11.2001	24.5201-0100.3	331512	FLEXIBLE FREIN	34 32 1 162 616	83.6235-0100.3
		ArG	01.1996	11.2001	24.5201-0100.3	331512	FLEXIBLE FREIN	34 32 1 162 616	83.6235-0100.3
	740 d	ArG	05.1999	11.2001	24.5201-0100.3	331512	FLEXIBLE FREIN	34 32 1 162 616	83.6235-0100.3
		ArG	05.1999	11.2001	24.5201-0100.3	331512	FLEXIBLE FREIN	34 32 1 162 616	83.6235-0100.3
	740 i	ArG	07.1993	11.2001	24.5201-0100.3	331512	FLEXIBLE FREIN	34 32 1 162 616	83.6235-0100.3
		ArG	07.1993	11.2001	24.5201-0100.3	331512	FLEXIBLE FREIN	34 32 1 162 616	83.6235-0100.3
	740 iL	ArG	05.1994	11.2001	24.5201-0100.3	331512	FLEXIBLE FREIN	34 32 1 162 616	83.6235-0100.3
		ArG	05.1994	11.2001	24.5201-0100.3	331512	FLEXIBLE FREIN	34 32 1 162 616	83.6235-0100.3
	750 i	ArG	11.1993	11.2001	24.5201-0100.3	331512	FLEXIBLE FREIN	34 32 1 162 616	83.6235-0100.3
		ArG	11.1993	11.2001	24.5201-0100.3	331512	FLEXIBLE FREIN	34 32 1 162 616	83.6235-0100.3
	750 iL	ArG	01.1994	11.2001	24.5201-0100.3	331512	FLEXIBLE FREIN	34 32 1 162 616	83.6235-0100.3
		ArG	01.1994	11.2001	24.5201-0100.3	331512	FLEXIBLE FREIN	34 32 1 162 616	83.6235-0100.3
Série 7/E65-66 (02-08)	730 d		09.2002	08.2008	24.5169-0555.3	331509	FLEXIBLE FREIN	34 32 6 753 610	83.6150-0556.3
	730 d,Ld		03.2005	08.2008	24.5169-0555.3	331509	FLEXIBLE FREIN	34 32 6 753 610	83.6150-0556.3
	730 i,Li		07.2005	08.2008	24.5169-0555.3	331509	FLEXIBLE FREIN	34 32 6 753 610	83.6150-0556.3
			03.2003	08.2008	24.5169-0555.3	331509	FLEXIBLE FREIN	34 32 6 753 610	83.6150-0556.3
	735 i,Li		11.2001	08.2008	24.5169-0555.3	331509	FLEXIBLE FREIN	34 32 6 753 610	83.6150-0556.3



description

Références OE
par référence
ATE.

i
Références remplacées /
divers

BMW

Série	Modèle	ArG	09.2002	08.2008	24.5169-0555.3	331509	FLEXIBLE FREIN	34 32 6 753 610	83.6150-0556.3
Série 7/E65-66 (02-08)	740 d		09.2002	08.2008	24.5169-0555.3	331509	FLEXIBLE FREIN	34 32 6 753 610	83.6150-0556.3
	740 i,Li		03.2005	08.2008	24.5169-0555.3	331509	FLEXIBLE FREIN	34 32 6 753 610	83.6150-0556.3
	745 d		03.2005	08.2008	24.5169-0555.3	331509	FLEXIBLE FREIN	34 32 6 753 610	83.6150-0556.3
	745 i,Li		11.2001	08.2008	24.5169-0555.3	331509	FLEXIBLE FREIN	34 32 6 753 610	83.6150-0556.3
	750 i,Li		03.2005	08.2008	24.5169-0555.3	331509	FLEXIBLE FREIN	34 32 6 753 610	83.6150-0556.3
	760 i,Li		03.2003	08.2008	24.5169-0555.3	331509	FLEXIBLE FREIN	34 32 6 753 610	83.6150-0556.3
Série 8/E31 (90-99)	840 Ci	ArG	01.1996	08.1999	24.5201-0100.3	331512	FLEXIBLE FREIN	34 32 1 162 616	83.6235-0100.3
		ArG	01.1996	08.1999	24.5201-0100.3	331512	FLEXIBLE FREIN	34 32 1 162 616	83.6235-0100.3
	840 i	ArG	02.1993	02.1996	24.5201-0100.3	331512	FLEXIBLE FREIN	34 32 1 162 616	83.6235-0100.3
		ArG	02.1993	02.1996	24.5201-0100.3	331512	FLEXIBLE FREIN	34 32 1 162 616	83.6235-0100.3
	850 Ci	ArG	09.1994	12.1999	24.5201-0100.3	331512	FLEXIBLE FREIN	34 32 1 162 616	83.6235-0100.3
		ArG	09.1994	12.1999	24.5201-0100.3	331512	FLEXIBLE FREIN	34 32 1 162 616	83.6235-0100.3
	850 CSI	ArG	09.1992	10.1996	24.5201-0100.3	331512	FLEXIBLE FREIN	34 32 1 162 616	83.6235-0100.3
	850 i/Ci	ArG	04.1990	10.1994	24.5201-0100.3	331512	FLEXIBLE FREIN	34 32 1 162 616	83.6235-0100.3
		ArG	04.1990	10.1994	24.5201-0100.3	331512	FLEXIBLE FREIN	34 32 1 162 616	83.6235-0100.3
X1/F48 (15-)	sDrive 16d		09.2015		24.0110-0401.1	410401	DISQUE DE FREIN	34 21 6 799 367	
	sDrive 18d		09.2015		24.0110-0401.1	410401	DISQUE DE FREIN	34 21 6 799 367	
	sDrive 18i		09.2015		24.0110-0401.1	410401	DISQUE DE FREIN	34 21 6 799 367	
	xDrive 18d		09.2015		24.0110-0401.1	410401	DISQUE DE FREIN	34 21 6 799 367	



description

Références OE
par référence
ATE.

i
Références remplacées /
divers

CHEVROLET

Model	Engine	Start	End	Part No.	ATE Ref.	Description	OE Ref.
AVEO (T300) (11-)	1,2 16V	03.2011		03.0137-0514.2	650514	JEU DE MACHOIRE	95017074
	1,2 LPG	11.2012		03.0137-0514.2	650514	JEU DE MACHOIRE	95017074
	1,3 D	07.2011		03.0137-0514.2	650514	JEU DE MACHOIRE	95017074
	1,4 16V	03.2011		03.0137-0514.2	650514	JEU DE MACHOIRE	95017074
		12.2012		03.0137-0514.2	650514	JEU DE MACHOIRE	95017074
	1,6 16V	12.2012		03.0137-0514.2	650514	JEU DE MACHOIRE	95017074
		03.2011		03.0137-0514.2	650514	JEU DE MACHOIRE	95017074
		06.2011		03.0137-0514.2	650514	JEU DE MACHOIRE	95017074
COBALT (11-)	1,5	01.2014		03.0137-0514.2	650514	JEU DE MACHOIRE	95017074
EPICA (05-10)	2,0 D	01.2007	12.2010	03.0137-3036.2	653036	JEU DE MACHOIRE	96496764
	2,0 i 16V	01.2005	12.2006	03.0137-3036.2	653036	JEU DE MACHOIRE	96496764
		08.2006	12.2010	03.0137-3036.2	653036	JEU DE MACHOIRE	96496764
	2,0 i V6	06.2006	12.2010	03.0137-3036.2	653036	JEU DE MACHOIRE	96496764
	2,5 i V6	06.2006	12.2010	03.0137-3036.2	653036	JEU DE MACHOIRE	96496764
EVANDA (05-06)	2,0 i 16V	03.2005	12.2006	03.0137-3036.2	653036	JEU DE MACHOIRE	96496764
LACETTI (05-10)	1,4 i 16V	03.2005	12.2010	03.0137-3036.2	653036	JEU DE MACHOIRE	96496764
	1,6 i 16V	03.2005	12.2010	03.0137-3036.2	653036	JEU DE MACHOIRE	96496764
	1,8 i 16V	05.2003	12.2010	03.0137-3036.2	653036	JEU DE MACHOIRE	96496764
		08.2005	12.2010	03.0137-3036.2	653036	JEU DE MACHOIRE	96496764
	2,0 TDCi	01.2007	12.2010	03.0137-3036.2	653036	JEU DE MACHOIRE	96496764
NUBIRA (05-10)	1,4 i 16V	01.2005	12.2010	03.0137-3036.2	653036	JEU DE MACHOIRE	96496764



				description	Références OE par référence ATE.	 Références remplacées / divers
---	---	--	---	-------------	--	---

CHEVROLET

Model	Engine	Start	End	Code	Part No	Description	OE Ref	Other Ref
NUBIRA (05-10)	1,4 i 16V	01.2006	12.2010	03.0137-3036.2	653036	JEU DE MACHOIRE	96496764	
	1,5 i 16V	01.2005	12.2010	03.0137-3036.2	653036	JEU DE MACHOIRE	96496764	
	1,6 i 16V	01.2010	12.2010	03.0137-3036.2	653036	JEU DE MACHOIRE	96496764	
		03.2005	12.2010	03.0137-3036.2	653036	JEU DE MACHOIRE	96496764	
	1,8 i 16V	03.2005	12.2010	03.0137-3036.2	653036	JEU DE MACHOIRE	96496764	
		08.2005	12.2010	03.0137-3036.2	653036	JEU DE MACHOIRE	96496764	
	2,0 i 16V	01.2005	12.2010	03.0137-3036.2	653036	JEU DE MACHOIRE	96496764	
	2,0 TCDi	01.2005	12.2010	03.0137-3036.2	653036	JEU DE MACHOIRE	96496764	



description

Références OE
par référence
ATE.

i
Références remplacées /
divers

CHRYSLER

Modèle	Motorisation	AR	08.2000	09.2004	24.0126-0179.1	426179	Description	Références OE par référence ATE.	Références remplacées / divers
300 M (LR) (98-04)	2,7 V6		08.2000	09.2004	24.0126-0179.1	426179	DISQUE DE FREIN	0 4779 133AC , 0 4779 133AB , 4779 133AC , 4779 133AB , 0 4779 133AA , 4779 133AA	
			11.1998	08.2000	24.0126-0179.1	426179	DISQUE DE FREIN	0 4779 133AC , 0 4779 133AB , 4779 133AC , 4779 133AB , 0 4779 133AA , 4779 133AA	
	3,5 V6		07.1998	08.2000	24.0126-0179.1	426179	DISQUE DE FREIN	0 4779 133AC , 0 4779 133AB , 4779 133AC , 4779 133AB , 0 4779 133AA , 4779 133AA	
			08.2000	09.2004	24.0126-0179.1	426179	DISQUE DE FREIN	0 4779 133AC , 0 4779 133AB , 4779 133AC , 4779 133AB , 0 4779 133AA , 4779 133AA	
CONCORDE (C_41) (97-03)	2,7 V6		10.1997	09.2003	24.0126-0179.1	426179	DISQUE DE FREIN	0 4779 133AC , 0 4779 133AB , 4779 133AC , 4779 133AB , 0 4779 133AA , 4779 133AA	
	3,5 V6		10.1997	09.2003	24.0126-0179.1	426179	DISQUE DE FREIN	0 4779 133AC , 0 4779 133AB , 4779 133AC , 4779 133AB , 0 4779 133AA , 4779 133AA	
	3,5 V6 Supercharged		10.1997	09.2003	24.0126-0179.1	426179	DISQUE DE FREIN	0 4779 133AC , 0 4779 133AB , 4779 133AC , 4779 133AB , 0 4779 133AA , 4779 133AA	
VOYAGER (RG) (00-08)	2,4 16V	AR	02.2000	12.2008	24.3421-1711.5	240757	ETRIER A GRIFFE	0 5019 808AA , 5019 808AA	
	2,5 CRD	AR	02.2000	12.2008	24.3421-1711.5	240757	ETRIER A GRIFFE	0 5019 808AA , 5019 808AA	
		AR	08.2005	12.2008	24.3421-1711.5	240757	ETRIER A GRIFFE	0 5019 808AA , 5019 808AA	
	2,8 CRD	AR	06.2004	12.2008	24.3421-1711.5	240757	ETRIER A GRIFFE	0 5019 808AA , 5019 808AA	
	3,3 V6	AR	02.2000	12.2008	24.3421-1711.5	240757	ETRIER A GRIFFE	0 5019 808AA , 5019 808AA	



				description	Références OE par référence ATE.	 Références remplacées / divers
---	---	--	---	--------------------	---	--

CHRYSLER

Modèle	Motorisation	Code	09.2003	12.2008	24.3421-1711.5	240757	Description	Références OE par référence ATE	Références remplacées / divers
VOYAGER (RG) (00-08)	3,3 V6	AR	09.2003	12.2008	24.3421-1711.5	240757	ETRIER A GRIFFE	0 5019 808AA , 5019 808AA	
	3,3 V6 AWD	AR	02.2000	12.2008	24.3421-1711.5	240757	ETRIER A GRIFFE	0 5019 808AA , 5019 808AA	
	3,3 V6 Flex-Fuel	AR	02.2000	12.2008	24.3421-1711.5	240757	ETRIER A GRIFFE	0 5019 808AA , 5019 808AA	
	3,8 V6	AR	02.2000	12.2008	24.3421-1711.5	240757	ETRIER A GRIFFE	0 5019 808AA , 5019 808AA	
	3,8 V6 AWD	AR	02.2000	12.2008	24.3421-1711.5	240757	ETRIER A GRIFFE	0 5019 808AA , 5019 808AA	



description

Références OE
par référence
ATE.

i
Références remplacées /
divers

Classic PKW

Modèle	Version	AvD	01.1976	07.1978	24.5170-0296.3	331451	description	Références OE par référence ATE.	Références remplacées / divers
AUDI 50 (74-78)	0,8		01.1976	07.1978	24.5170-0296.3	331451	FLEXIBLE FREIN	861 611 707 C , 861 611 707 B , 861 611 707 A	83.7734-0290.3
	1,1		08.1974	07.1978	24.5170-0296.3	331451	FLEXIBLE FREIN	861 611 707 C , 861 611 707 B , 861 611 707 A	83.7734-0290.3
	1,3		08.1977	07.1978	24.5170-0296.3	331451	FLEXIBLE FREIN	861 611 707 C , 861 611 707 B , 861 611 707 A	83.7734-0290.3
JAGUAR XJ (X300) (94-97)	12 6,0	AvD	11.1994	07.1997	11.9601-9782.2	220992	ETRIER A GRIFFE	JLM 21469 , JLM 11716	
	6 3,2	AvD	11.1994	07.1997	11.9601-9782.2	220992	ETRIER A GRIFFE	JLM 21469 , JLM 11716	
	6 Sovereign 4,0	AvD	11.1994	07.1997	11.9601-9782.2	220992	ETRIER A GRIFFE	JLM 21469 , JLM 11716	
	R Super Charged 4,0	AvD	11.1994	07.1997	11.9601-9782.2	220992	ETRIER A GRIFFE	JLM 21469 , JLM 11716	
VOLKSWAGEN DERBY/POLO à coffre (77-88)	0,9		01.1977	09.1981	24.5170-0296.3	331451	FLEXIBLE FREIN	861 611 707 C , 861 611 707 B , 861 611 707 A	83.7734-0290.3
	1		01.1977	12.1988	24.5170-0296.3	331451	FLEXIBLE FREIN	861 611 707 C , 861 611 707 B , 861 611 707 A	83.7734-0290.3
	1,1		01.1977	12.1988	24.5170-0296.3	331451	FLEXIBLE FREIN	861 611 707 C , 861 611 707 B , 861 611 707 A	83.7734-0290.3
	1,3		01.1977	12.1988	24.5170-0296.3	331451	FLEXIBLE FREIN	861 611 707 C , 861 611 707 B , 861 611 707 A	83.7734-0290.3
	1,3 D		08.1986	12.1988	24.5170-0296.3	331451	FLEXIBLE FREIN	861 611 707 C , 861 611 707 B , 861 611 707 A	83.7734-0290.3
VOLKSWAGEN POLO I (75-81)	0,9		04.1975	09.1981	24.5170-0296.3	331451	FLEXIBLE FREIN	861 611 707 C , 861 611 707 B , 861 611 707 A	83.7734-0290.3
	1,1		04.1975	09.1981	24.5170-0296.3	331451	FLEXIBLE FREIN	861 611 707 C , 861 611 707 B , 861 611 707 A	83.7734-0290.3
	1,3		12.1976	09.1981	24.5170-0296.3	331451	FLEXIBLE FREIN	861 611 707 C , 861 611 707 B , 861 611 707 A	83.7734-0290.3
VOLKSWAGEN POLO II (81-94)	1		10.1981	09.1994	24.5170-0296.3	331451	FLEXIBLE FREIN	861 611 707 C , 861 611 707 B , 861 611 707 A	83.7734-0290.3



					description	Références OE par référence ATE.	 Références remplacées / divers
---	---	---	--	---	-------------	----------------------------------	---

Classic PKW

Modèle	Version	Année de début	Année de fin	Code OE	Code ATE	Description	Références OE par référence ATE.	Références remplacées / divers
VOLKSWAGEN POLO II (81-94)	1,1	10.1981	07.1983	24.5170-0296.3	331451	FLEXIBLE FREIN	861 611 707 C , 861 611 707 B , 861 611 707 A	83.7734-0290.3
	1,3	10.1981	09.1994	24.5170-0296.3	331451	FLEXIBLE FREIN	861 611 707 C , 861 611 707 B , 861 611 707 A	83.7734-0290.3
	1,3 D	08.1986	09.1990	24.5170-0296.3	331451	FLEXIBLE FREIN	861 611 707 C , 861 611 707 B , 861 611 707 A	83.7734-0290.3
	1,3 G40	01.1987	09.1994	24.5170-0296.3	331451	FLEXIBLE FREIN	861 611 707 C , 861 611 707 B , 861 611 707 A	83.7734-0290.3
	1,4 D	08.1990	09.1994	24.5170-0296.3	331451	FLEXIBLE FREIN	861 611 707 C , 861 611 707 B , 861 611 707 A	83.7734-0290.3



description

Références OE
par référence
ATE.

i
Références remplacées /
divers

DAEWOO

EVANDA (02-05)	2,0 i 16V		08.2002	02.2005	03.0137-3036.2	653036	JEU DE MACHOIRE	96496764	
GENTRA (13-)	1,5		06.2013		03.0137-3036.2	653036	JEU DE MACHOIRE	96496764	
LACETTI (04-05)	1,4 i 16V		06.2002	12.2004	03.0137-3036.2	653036	JEU DE MACHOIRE	96496764	
			02.2004	02.2005	03.0137-3036.2	653036	JEU DE MACHOIRE	96496764	
	1,6 i 16V		02.2004	02.2005	03.0137-3036.2	653036	JEU DE MACHOIRE	96496764	
	1,8 i 16V		02.2004	02.2005	03.0137-3036.2	653036	JEU DE MACHOIRE	96496764	
LACETTI (99-03)	1,6		06.2002	07.2003	03.0137-3036.2	653036	JEU DE MACHOIRE	96496764	
NUBIRA (99-05)	1,4 i 16V		10.2003	12.2004	03.0137-3036.2	653036	JEU DE MACHOIRE	96496764	
	1,6 i 16V		06.1999	02.2005	03.0137-3036.2	653036	JEU DE MACHOIRE	96496764	
			07.2000	02.2005	03.0137-3036.2	653036	JEU DE MACHOIRE	96496764	
			08.2003	02.2005	03.0137-3036.2	653036	JEU DE MACHOIRE	96496764	
	1,8 i 16V		08.2003	02.2005	03.0137-3036.2	653036	JEU DE MACHOIRE	96496764	
	2,0 CDX		08.2002	07.2003	03.0137-3036.2	653036	JEU DE MACHOIRE	96496764	
TOSCA (06-)	2,0 XT		02.2006	12.2010	03.0137-3036.2	653036	JEU DE MACHOIRE	96496764	
	2,5 EX		02.2006	12.2010	03.0137-3036.2	653036	JEU DE MACHOIRE	96496764	



description

Références OE
par référence
ATE.

i
Références remplacées /
divers

FIAT

500 (07-)	1,3 D Multijet		07.2007		28.0460-2344.2	BA2344	PLAQUETTES DE FREIN	ME9S5J-2K021-AB, ME9S5J-2K021-AA, 1778384, 1736937, 1559697, 9S51-2K021-AA, 77365817, 77364636	
500 C Cabrio (09-)	1,2		09.2009		28.0460-2344.2	BA2344	PLAQUETTES DE FREIN	ME9S5J-2K021-AB, ME9S5J-2K021-AA, 1778384, 1736937, 1559697, 9S51-2K021-AA, 77365817, 77364636	
	1,3 D Multijet		09.2009		28.0460-2344.2	BA2344	PLAQUETTES DE FREIN	ME9S5J-2K021-AB, ME9S5J-2K021-AA, 1778384, 1736937, 1559697, 9S51-2K021-AA, 77365817, 77364636	
500 L Kombi (12-)	0,9		08.2012		03.0137-0526.2	650526	JEU DE MACHOIRE	77367099	
	0,9 CNG		03.2013		03.0137-0526.2	650526	JEU DE MACHOIRE	77367099	
	1,3 D Multijet		08.2012		03.0137-0526.2	650526	JEU DE MACHOIRE	77367099	
	1,4		08.2012		03.0137-0526.2	650526	JEU DE MACHOIRE	77367099	
	1,6 D Multijet		08.2012		03.0137-0526.2	650526	JEU DE MACHOIRE	77367099	
TIPO (15-)	1,3 D Multijet		10.2015		03.0137-0526.2	650526	JEU DE MACHOIRE	77367099	
	1,4		03.2016		03.0137-0526.2	650526	JEU DE MACHOIRE	77367099	
			10.2015		03.0137-0526.2	650526	JEU DE MACHOIRE	77367099	
	1,4 LPG		05.2016		03.0137-0526.2	650526	JEU DE MACHOIRE	77367099	
	1,6		10.2015		03.0137-0526.2	650526	JEU DE MACHOIRE	77367099	
	1,6 D Multijet		10.2015		03.0137-0526.2	650526	JEU DE MACHOIRE	77367099	



description

Références OE
par référence
ATE.

i
Références remplacées /
divers

FORD

Model	Engine	AvG	Start	End	Part No.	ATE No.	Description	OE Refs	Notes
ECOSPORT II (14-)	1,0 EcoBoost		02.2014		03.0137-0527.2	650527	JEU DE MACHOIRE	CN15-2200-AA , 1782874	
			03.2016		03.0137-0527.2	650527	JEU DE MACHOIRE	CN15-2200-AA , 1782874	
	1,5 TDCi		02.2014		03.0137-0527.2	650527	JEU DE MACHOIRE	CN15-2200-AA , 1782874	
			05.2015		03.0137-0527.2	650527	JEU DE MACHOIRE	CN15-2200-AA , 1782874	
	1,5 Ti		02.2014		03.0137-0527.2	650527	JEU DE MACHOIRE	CN15-2200-AA , 1782874	
FIESTA IV (96-02)	1,0 i	AvG	02.2000	03.2002	24.3541-8531.5	240679	ETRIER A GRIFFE	DDY2-33-71X , RMYS6J-2B302-CA , YS6J-2B302-CA , 1478500 , 1101443 , YS61-2L232-BA , 1126292	11.3541-8531.2
	1,25 i 16V	AvG	02.2000	03.2002	24.3541-8531.5	240679	ETRIER A GRIFFE	DDY2-33-71X , RMYS6J-2B302-CA , YS6J-2B302-CA , 1478500 , 1101443 , YS61-2L232-BA , 1126292	11.3541-8531.2
	1,3 i	AvG	02.2000	03.2002	24.3541-8531.5	240679	ETRIER A GRIFFE	DDY2-33-71X , RMYS6J-2B302-CA , YS6J-2B302-CA , 1478500 , 1101443 , YS61-2L232-BA , 1126292	11.3541-8531.2
	1,4 i 16V	AvG	02.2000	03.2002	24.3541-8531.5	240679	ETRIER A GRIFFE	DDY2-33-71X , RMYS6J-2B302-CA , YS6J-2B302-CA , 1478500 , 1101443 , YS61-2L232-BA , 1126292	11.3541-8531.2
	1,6	AvG	02.2000	03.2002	24.3541-8531.5	240679	ETRIER A GRIFFE	DDY2-33-71X , RMYS6J-2B302-CA , YS6J-2B302-CA , 1478500 , 1101443 , YS61-2L232-BA , 1126292	11.3541-8531.2
	1,6 i 16V	AvG	02.2000	03.2002	24.3541-8531.5	240679	ETRIER A GRIFFE	DDY2-33-71X , RMYS6J-2B302-CA , YS6J-2B302-CA , 1478500 , 1101443 , YS61-2L232-BA , 1126292	11.3541-8531.2
	1,8 D	AvG	02.2000	03.2002	24.3541-8531.5	240679	ETRIER A GRIFFE	DDY2-33-71X , RMYS6J-2B302-CA , YS6J-2B302-CA , 1478500 , 1101443 , YS61-2L232-BA , 1126292	11.3541-8531.2



description

Références OE
par référence
ATE.

i
Références remplacées /
divers

FORD

FIESTA IV (96-02)	1,8 DI	AvG	03.2000	03.2002	24.3541-8531.5	240679	ETRIER A GRIFFE	DDY2-33-71X , RMYS6J-2B302-CA , YS6J-2B302-CA , 1478500 , 1101443 , YS61-2L232-BA , 1126292	11.3541-8531.2
FIESTA V (02-08)	1,25 i 16V	AvG	03.2003	08.2008	24.3541-8531.5	240679	ETRIER A GRIFFE	DDY2-33-71X , RMYS6J-2B302-CA , YS6J-2B302-CA , 1478500 , 1101443 , YS61-2L232-BA , 1126292	11.3541-8531.2
		AvG	05.2002	08.2008	24.3541-8531.5	240679	ETRIER A GRIFFE	DDY2-33-71X , RMYS6J-2B302-CA , YS6J-2B302-CA , 1478500 , 1101443 , YS61-2L232-BA , 1126292	11.3541-8531.2
	1,3 i	AvG	04.2002	08.2008	24.3541-8531.5	240679	ETRIER A GRIFFE	DDY2-33-71X , RMYS6J-2B302-CA , YS6J-2B302-CA , 1478500 , 1101443 , YS61-2L232-BA , 1126292	11.3541-8531.2
	1,4 i 16V	AvG	04.2002	08.2008	24.3541-8531.5	240679	ETRIER A GRIFFE	DDY2-33-71X , RMYS6J-2B302-CA , YS6J-2B302-CA , 1478500 , 1101443 , YS61-2L232-BA , 1126292	11.3541-8531.2
	1,4 TDCi	AvG	04.2002	08.2008	24.3541-8531.5	240679	ETRIER A GRIFFE	DDY2-33-71X , RMYS6J-2B302-CA , YS6J-2B302-CA , 1478500 , 1101443 , YS61-2L232-BA , 1126292	11.3541-8531.2
	1,6 i 16V	AvG	04.2002	08.2008	24.3541-8531.5	240679	ETRIER A GRIFFE	DDY2-33-71X , RMYS6J-2B302-CA , YS6J-2B302-CA , 1478500 , 1101443 , YS61-2L232-BA , 1126292	11.3541-8531.2
	1,6 TDCi	AvG	10.2004	08.2008	24.3541-8531.5	240679	ETRIER A GRIFFE	DDY2-33-71X , RMYS6J-2B302-CA , YS6J-2B302-CA , 1478500 , 1101443 , YS61-2L232-BA , 1126292	11.3541-8531.2
FUSION (02-12)	1,25 i 16V	AvG	08.2004	09.2012	24.3541-8531.5	240679	ETRIER A GRIFFE	DDY2-33-71X , RMYS6J-2B302-CA , YS6J-2B302-CA , 1478500 , 1101443 , YS61-2L232-BA , 1126292	11.3541-8531.2



description

Références OE
par référence
ATE.

i
Références remplacées /
divers

FORD

FUSION (02-12)	1,4 i 16V	AvG	07.2002	09.2012	24.3541-8531.5	240679	ETRIER A GRIFFE	DDY2-33-71X , RMYS6J-2B302-CA , YS6J-2B302-CA , 1478500 , 1101443 , YS61-2L232-BA , 1126292	11.3541-8531.2
	1,4 TDCi	AvG	07.2002	09.2012	24.3541-8531.5	240679	ETRIER A GRIFFE	DDY2-33-71X , RMYS6J-2B302-CA , YS6J-2B302-CA , 1478500 , 1101443 , YS61-2L232-BA , 1126292	11.3541-8531.2
	1,6 i 16V	AvG	07.2002	09.2012	24.3541-8531.5	240679	ETRIER A GRIFFE	DDY2-33-71X , RMYS6J-2B302-CA , YS6J-2B302-CA , 1478500 , 1101443 , YS61-2L232-BA , 1126292	11.3541-8531.2
	1,6 TDCi	AvG	10.2004	09.2012	24.3541-8531.5	240679	ETRIER A GRIFFE	DDY2-33-71X , RMYS6J-2B302-CA , YS6J-2B302-CA , 1478500 , 1101443 , YS61-2L232-BA , 1126292	11.3541-8531.2
KA I (96-08)	1,6	AvG	09.2000	12.2008	24.3541-8531.5	240679	ETRIER A GRIFFE	DDY2-33-71X , RMYS6J-2B302-CA , YS6J-2B302-CA , 1478500 , 1101443 , YS61-2L232-BA , 1126292	11.3541-8531.2
	1,6 i	AvG	08.2003	12.2008	24.3541-8531.5	240679	ETRIER A GRIFFE	DDY2-33-71X , RMYS6J-2B302-CA , YS6J-2B302-CA , 1478500 , 1101443 , YS61-2L232-BA , 1126292	11.3541-8531.2
KA II (08-)	1,3 TDCi		10.2008		28.0460-2344.2	BA2344	PLAQUETTES DE FREIN	ME9S5J-2K021-AB , ME9S5J-2K021-AA , 1778384 , 1736937 , 1559697 , 9S51-2K021-AA , 77365817 , 77364636	
PUMA (97-01)	1,4 i 16V	AvG	02.2000	10.2000	24.3541-8531.5	240679	ETRIER A GRIFFE	DDY2-33-71X , RMYS6J-2B302-CA , YS6J-2B302-CA , 1478500 , 1101443 , YS61-2L232-BA , 1126292	11.3541-8531.2
	1,6 i 16V	AvG	08.2000	12.2001	24.3541-8531.5	240679	ETRIER A GRIFFE	DDY2-33-71X , RMYS6J-2B302-CA , YS6J-2B302-CA , 1478500 , 1101443 , YS61-2L232-BA , 1126292	11.3541-8531.2



description

Références OE
par référence
ATE.

i
Références remplacées /
divers

FORD

PUMA (97-01)	1,7 i 16V	AvG	02.2000	12.2001	24.3541-8531.5	240679	ETRIER A GRIFFE	DDY2-33-71X , RMYS6J-2B302-CA , YS61-2B302-CA , 1478500 , 1101443 , YS61-2L232-BA , 1126292	11.3541-8531.2
	ST 160	AvG	02.2000	12.2001	24.3541-8531.5	240679	ETRIER A GRIFFE	DDY2-33-71X , RMYS6J-2B302-CA , YS61-2B302-CA , 1478500 , 1101443 , YS61-2L232-BA , 1126292	11.3541-8531.2
RANGER (11-)	2,2 TDCI		11.2011	03.2012	24.0132-0176.1	432176	DISQUE DE FREIN	1727183 , AB31-1125-AB , 1742318	
	2,2 TDCI 4x4		11.2011	03.2012	24.0132-0176.1	432176	DISQUE DE FREIN	1727183 , AB31-1125-AB , 1742318	
	3,2 TDCI 4x4		11.2011	03.2012	24.0132-0176.1	432176	DISQUE DE FREIN	1727183 , AB31-1125-AB , 1742318	
STREET KA (03-06)	1,6 i	AvG	02.2003	02.2006	24.3541-8531.5	240679	ETRIER A GRIFFE	DDY2-33-71X , RMYS6J-2B302-CA , YS61-2B302-CA , 1478500 , 1101443 , YS61-2L232-BA , 1126292	11.3541-8531.2

HONDA

CIVIC IX (5-tuerig) (12-)	1,4 i-VTEC		02.2012		24.0125-0201.1	425201	DISQUE DE FREIN	45251-TV0-E00	
	1,6 i-DTEC		02.2013		24.0125-0201.1	425201	DISQUE DE FREIN	45251-TV0-E00	
	1,6 i-VTEC		02.2012		24.0125-0201.1	425201	DISQUE DE FREIN	45251-TV0-E00	
	1,8 i-VTEC		02.2012		24.0125-0201.1	425201	DISQUE DE FREIN	45251-TV0-E00	
	2,0 i-VTEC		06.2012		24.0125-0201.1	425201	DISQUE DE FREIN	45251-TV0-E00	
	2,2 i-DTEC		02.2012		24.0125-0201.1	425201	DISQUE DE FREIN	45251-TV0-E00	



description

Références OE
par référence
ATE.

i
Références remplacées /
divers

HYUNDAI

GRANDEUR (HG) (11-)	2,4 16V		01.2011		24.0110-0400.1	410400	DISQUE DE FREIN	58411-3V500	
			07.2011		24.0110-0400.1	410400	DISQUE DE FREIN	58411-3V500	
	3		07.2011		24.0110-0400.1	410400	DISQUE DE FREIN	58411-3V500	
i10 (08-13)	1,0 12V		01.2011	11.2013	03.0137-0524.2	650524	JEU DE MACHOIRE	58305-0XA10 , 58350-0PA00	
	1,1 12V		11.2008	11.2013	03.0137-0524.2	650524	JEU DE MACHOIRE	58305-0XA10 , 58350-0PA00	
			04.2011	11.2013	03.0137-0524.2	650524	JEU DE MACHOIRE	58305-0XA10 , 58350-0PA00	
	1,1 LPG		04.2011	11.2013	03.0137-0524.2	650524	JEU DE MACHOIRE	58305-0XA10 , 58350-0PA00	
i20 (08-14)	1,1 CRDi		03.2012	12.2014	03.0137-0524.2	650524	JEU DE MACHOIRE	58305-0XA10 , 58350-0PA00	
	1,2 16V		03.2012	12.2014	03.0137-0524.2	650524	JEU DE MACHOIRE	58305-0XA10 , 58350-0PA00	
			09.2008	12.2014	03.0137-0524.2	650524	JEU DE MACHOIRE	58305-0XA10 , 58350-0PA00	
i30 (PDE) (17-)	1,0 T-GDi		01.2017		24.0110-0400.1	410400	DISQUE DE FREIN	58411-3V500	
IONIQ (16-)	1,6 Hybrid		03.2016		24.0110-0400.1	410400	DISQUE DE FREIN	58411-3V500	
	Electric		03.2016		24.0110-0400.1	410400	DISQUE DE FREIN	58411-3V500	
SONATA (LF) (14-)	2,0 Gdi Hybrid		09.2014		24.0110-0400.1	410400	DISQUE DE FREIN	58411-3V500	
	2,0 Hybrid		09.2014		24.0110-0400.1	410400	DISQUE DE FREIN	58411-3V500	

JAGUAR

XJ (NAW,NBW) (97-03)	XJ8 3,2	AvD	07.1997	05.2003	11.9601-9782.2	220992	ETRIER A GRIFFE	JLM 21469 , JLM 11716	
	XJ8 4,0	AvD	07.1997	05.2003	11.9601-9782.2	220992	ETRIER A GRIFFE	JLM 21469 , JLM 11716	
		AvD	10.1997	05.2003	11.9601-9782.2	220992	ETRIER A GRIFFE	JLM 21469 , JLM 11716	



					description	Références OE par référence ATE.	 Références remplacées / divers
--	--	--	--	--	--------------------	---	---

JEEP

Model	Engine	Start	End	Part No.	ATE Ref.	Description	OE Refs	Notes
CHEROKEE (KK) (08-12)	2,8 CRDi 4WD	01.2010	12.2012	24.0128-0259.1	428259	DISQUE DE FREIN	0 4779 599AB , 4779 599AB	
	3,7 V6	01.2010	12.2012	24.0128-0259.1	428259	DISQUE DE FREIN	0 4779 599AB , 4779 599AB	
	3,7 V6 4WD	01.2010	12.2012	24.0128-0259.1	428259	DISQUE DE FREIN	0 4779 599AB , 4779 599AB	



description

Références OE
par référence
ATE.

i
Références remplacées /
divers

KIA

Modèle	Version	Date	Code	ATE	Description	Références OE	Notes
CEE'D (12-)	1,0 T-GDI	07.2015	13.0460-2794.2	602794	PLAQUETTES DE FREIN	58302-A2A30	cf. Photo
	1,4 CRDi 90	05.2012	13.0460-2794.2	602794	PLAQUETTES DE FREIN	58302-A2A30	cf. Photo
	1,4 CVVT	05.2012	13.0460-2794.2	602794	PLAQUETTES DE FREIN	58302-A2A30	cf. Photo
	1,4 MPI	04.2015	13.0460-2794.2	602794	PLAQUETTES DE FREIN	58302-A2A30	cf. Photo
	1,6 CRDi 110	05.2012	13.0460-2794.2	602794	PLAQUETTES DE FREIN	58302-A2A30	cf. Photo
	1,6 CRDi 115	05.2012	13.0460-2794.2	602794	PLAQUETTES DE FREIN	58302-A2A30	cf. Photo
	1,6 CRDi 128	05.2012	13.0460-2794.2	602794	PLAQUETTES DE FREIN	58302-A2A30	cf. Photo
	1,6 CRDi 136	07.2015	13.0460-2794.2	602794	PLAQUETTES DE FREIN	58302-A2A30	cf. Photo
	1,6 CRDi 90	05.2012	13.0460-2794.2	602794	PLAQUETTES DE FREIN	58302-A2A30	cf. Photo
	1,6 CVVT	05.2012	13.0460-2794.2	602794	PLAQUETTES DE FREIN	58302-A2A30	cf. Photo
		01.2013	13.0460-2794.2	602794	PLAQUETTES DE FREIN	58302-A2A30	cf. Photo
	1,6 GDI	05.2012	13.0460-2794.2	602794	PLAQUETTES DE FREIN	58302-A2A30	cf. Photo
	1,6 GT	07.2013	13.0460-2794.2	602794	PLAQUETTES DE FREIN	58302-A2A30	cf. Photo
OPTIMA (TF) (12-15)	1,7 CRDi	03.2012	24.0110-0400.1	410400	DISQUE DE FREIN	58411-3V500	
	2,0 16V	03.2012	24.0110-0400.1	410400	DISQUE DE FREIN	58411-3V500	
	2,0 CVVL	03.2012	24.0110-0400.1	410400	DISQUE DE FREIN	58411-3V500	
	2,4 16V	03.2012	24.0110-0400.1	410400	DISQUE DE FREIN	58411-3V500	
		06.2010	24.0110-0400.1	410400	DISQUE DE FREIN	58411-3V500	
OPTIMA / OPTIMA SW (JF) (15-)	1,7 CRDi	11.2015	24.0110-0400.1	410400	DISQUE DE FREIN	58411-3V500	
	2,0 CVVL	09.2015	24.0110-0400.1	410400	DISQUE DE FREIN	58411-3V500	
	2,0 GDi Hybrid	09.2015	24.0110-0400.1	410400	DISQUE DE FREIN	58411-3V500	



description

Références OE
par référence
ATE.

i
Références remplacées /
divers

KIA

OPTIMA / OPTIMA SW (JF) (15-)	2,4 GDi		09.2015		24.0110-0400.1	410400	DISQUE DE FREIN	58411-3V500	
PRO CEE'D (13-)	1,0 T-GDI		07.2015		13.0460-2794.2	602794	PLAQUETTES DE FREIN	58302-A2A30	cf. Photo
	1,4 CRDi		03.2013		13.0460-2794.2	602794	PLAQUETTES DE FREIN	58302-A2A30	cf. Photo
	1,4 CVT		03.2013		13.0460-2794.2	602794	PLAQUETTES DE FREIN	58302-A2A30	cf. Photo
	1,4 MPI		04.2015		13.0460-2794.2	602794	PLAQUETTES DE FREIN	58302-A2A30	cf. Photo
			07.2013		13.0460-2794.2	602794	PLAQUETTES DE FREIN	58302-A2A30	cf. Photo
	1,6 CRDi		03.2013		13.0460-2794.2	602794	PLAQUETTES DE FREIN	58302-A2A30	cf. Photo
	1,6 CRDi 136		07.2015		13.0460-2794.2	602794	PLAQUETTES DE FREIN	58302-A2A30	cf. Photo
	1,6 CVT		07.2013		13.0460-2794.2	602794	PLAQUETTES DE FREIN	58302-A2A30	cf. Photo
	1,6 GDI		03.2013		13.0460-2794.2	602794	PLAQUETTES DE FREIN	58302-A2A30	cf. Photo
SOUL (14-)	Electric		06.2014		24.0110-0400.1	410400	DISQUE DE FREIN	58411-3V500	

LEXUS

RX 270/350/450 (GYL_) (09-15)	350		01.2009		24.0118-0157.1	418157	DISQUE DE FREIN	42431-48080	
	350 AWD		01.2009		24.0118-0157.1	418157	DISQUE DE FREIN	42431-48080	
	450h		01.2009		24.0118-0157.1	418157	DISQUE DE FREIN	42431-48080	
	450h AWD		01.2009		24.0118-0157.1	418157	DISQUE DE FREIN	42431-48080	



description

Références OE
par référence
ATE.

i
Références remplacées /
divers

MAZDA

121 (96-03)	1,25 i 16V	AvG	02.2000	03.2003	24.3541-8531.5	240679	ETRIER A GRIFFE	DDY2-33-71X , RMYS6J-2B302-CA , YS6J-2B302-CA , 1478500 , 1101443 , YS61-2L232-BA , 1126292	11.3541-8531.2
	1,3 i	AvG	02.2000	03.2003	24.3541-8531.5	240679	ETRIER A GRIFFE	DDY2-33-71X , RMYS6J-2B302-CA , YS6J-2B302-CA , 1478500 , 1101443 , YS61-2L232-BA , 1126292	11.3541-8531.2
	1,8 D	AvG	02.2000	03.2003	24.3541-8531.5	240679	ETRIER A GRIFFE	DDY2-33-71X , RMYS6J-2B302-CA , YS6J-2B302-CA , 1478500 , 1101443 , YS61-2L232-BA , 1126292	11.3541-8531.2
2 (DY) (03-07)	1,2 16V	AvG	02.2003	09.2007	24.3541-8531.5	240679	ETRIER A GRIFFE	DDY2-33-71X , RMYS6J-2B302-CA , YS6J-2B302-CA , 1478500 , 1101443 , YS61-2L232-BA , 1126292	11.3541-8531.2
	1,25 16V	AvG	04.2003	09.2007	24.3541-8531.5	240679	ETRIER A GRIFFE	DDY2-33-71X , RMYS6J-2B302-CA , YS6J-2B302-CA , 1478500 , 1101443 , YS61-2L232-BA , 1126292	11.3541-8531.2
	1,3 16V	AvG	04.2003	09.2007	24.3541-8531.5	240679	ETRIER A GRIFFE	DDY2-33-71X , RMYS6J-2B302-CA , YS6J-2B302-CA , 1478500 , 1101443 , YS61-2L232-BA , 1126292	11.3541-8531.2
	1,4 16V	AvG	02.2003	09.2007	24.3541-8531.5	240679	ETRIER A GRIFFE	DDY2-33-71X , RMYS6J-2B302-CA , YS6J-2B302-CA , 1478500 , 1101443 , YS61-2L232-BA , 1126292	11.3541-8531.2
	1,4 CD	AvG	04.2003	09.2007	24.3541-8531.5	240679	ETRIER A GRIFFE	DDY2-33-71X , RMYS6J-2B302-CA , YS6J-2B302-CA , 1478500 , 1101443 , YS61-2L232-BA , 1126292	11.3541-8531.2
	1,5 16V	AvG	04.2003	09.2007	24.3541-8531.5	240679	ETRIER A GRIFFE	DDY2-33-71X , RMYS6J-2B302-CA , YS6J-2B302-CA , 1478500 , 1101443 , YS61-2L232-BA , 1126292	11.3541-8531.2



					<p>description</p>	<p>Références OE par référence ATE.</p>	 <p>Références remplacées / divers</p>
---	---	---	--	---	--------------------	---	---

MAZDA

2 (DY) (03-07)	1,6 16V	AvG	02.2003	09.2007	24.3541-8531.5	240679	ETRIER A GRIFFE	DDY2-33-71X , RMYS6J-2B302-CA , YS6J-2B302-CA , 1478500 , 1101443 , YS61-2L232-BA , 1126292	11.3541-8531.2
----------------	---------	-----	---------	---------	----------------	--------	-----------------	---	----------------



description

Références OE
par référence
ATE.

i
Références remplacées /
divers

MERCEDES BENZ

C-Klasse (A205) Cabrio (16-)	C 180	06.2016	13.0460-7304.2	607304	PLAQUETTES DE FREIN	A 008 420 14 20 , 008 420 14 20 , A 000 420 82 00 , 000 420 82 00 , A 008 420 13 20 , 008 420 13 20	cf. Photo
	C 200	06.2016	13.0460-7304.2	607304	PLAQUETTES DE FREIN	A 008 420 14 20 , 008 420 14 20 , A 000 420 82 00 , 000 420 82 00 , A 008 420 13 20 , 008 420 13 20	cf. Photo
	C 200 4-matic	06.2016	13.0460-7304.2	607304	PLAQUETTES DE FREIN	A 008 420 14 20 , 008 420 14 20 , A 000 420 82 00 , 000 420 82 00 , A 008 420 13 20 , 008 420 13 20	cf. Photo
	C 220 d	06.2016	13.0460-7304.2	607304	PLAQUETTES DE FREIN	A 008 420 14 20 , 008 420 14 20 , A 000 420 82 00 , 000 420 82 00 , A 008 420 13 20 , 008 420 13 20	cf. Photo
	C 220 d 4-matic	06.2016	13.0460-7304.2	607304	PLAQUETTES DE FREIN	A 008 420 14 20 , 008 420 14 20 , A 000 420 82 00 , 000 420 82 00 , A 008 420 13 20 , 008 420 13 20	cf. Photo
	C 250	06.2016	13.0460-7304.2	607304	PLAQUETTES DE FREIN	A 008 420 14 20 , 008 420 14 20 , A 000 420 82 00 , 000 420 82 00 , A 008 420 13 20 , 008 420 13 20	cf. Photo
		06.2016	13.0470-2610.2	LD2610	CERAMIC PLAQ. FREIN	A 008 420 38 20 , A 008 420 28 20 , 008 420 38 20 , 008 420 28 20	
	C 250 d	06.2016	13.0460-7304.2	607304	PLAQUETTES DE FREIN	A 008 420 14 20 , 008 420 14 20 , A 000 420 82 00 , 000 420 82 00 , A 008 420 13 20 , 008 420 13 20	cf. Photo
		06.2016	13.0470-2610.2	LD2610	CERAMIC PLAQ. FREIN	A 008 420 38 20 , A 008 420 28 20 , 008 420 38 20 , 008 420 28 20	



description

Références OE
par référence
ATE.

i
Références remplacées /
divers

MERCEDES BENZ

C-Klasse (A205) Cabrio (16-)	C 300	06.2016	13.0460-7304.2	607304	PLAQUETTES DE FREIN	A 008 420 14 20 , 008 420 14 20 , A 000 420 82 00 , 000 420 82 00 , A 008 420 13 20 , 008 420 13 20	cf. Photo
		06.2016	13.0470-2610.2	LD2610	CERAMIC PLAO. FREIN	A 008 420 38 20 , A 008 420 28 20 , 008 420 38 20 , 008 420 28 20	
	C 400 4-matic	06.2016	13.0460-7304.2	607304	PLAQUETTES DE FREIN	A 008 420 14 20 , 008 420 14 20 , A 000 420 82 00 , 000 420 82 00 , A 008 420 13 20 , 008 420 13 20	cf. Photo
C-Klasse (C205) Coupe (15-)	C 180	10.2015	13.0460-7304.2	607304	PLAQUETTES DE FREIN	A 008 420 14 20 , 008 420 14 20 , A 000 420 82 00 , 000 420 82 00 , A 008 420 13 20 , 008 420 13 20	cf. Photo
	C 200	10.2015	13.0460-7304.2	607304	PLAQUETTES DE FREIN	A 008 420 14 20 , 008 420 14 20 , A 000 420 82 00 , 000 420 82 00 , A 008 420 13 20 , 008 420 13 20	cf. Photo
	C 200 4-matic	04.2016	13.0460-7304.2	607304	PLAQUETTES DE FREIN	A 008 420 14 20 , 008 420 14 20 , A 000 420 82 00 , 000 420 82 00 , A 008 420 13 20 , 008 420 13 20	cf. Photo
	C 220 d	10.2015	13.0460-7304.2	607304	PLAQUETTES DE FREIN	A 008 420 14 20 , 008 420 14 20 , A 000 420 82 00 , 000 420 82 00 , A 008 420 13 20 , 008 420 13 20	cf. Photo
	C 220 d 4-matic	04.2016	13.0460-7304.2	607304	PLAQUETTES DE FREIN	A 008 420 14 20 , 008 420 14 20 , A 000 420 82 00 , 000 420 82 00 , A 008 420 13 20 , 008 420 13 20	cf. Photo
	C 250	10.2015	13.0460-7304.2	607304	PLAQUETTES DE FREIN	A 008 420 14 20 , 008 420 14 20 , A 000 420 82 00 , 000 420 82 00 , A 008 420 13 20 , 008 420 13 20	cf. Photo



description

Références OE
par référence
ATE.

i
Références remplacées /
divers

MERCEDES BENZ

C-Klasse (C205) Coupe (15-)	C 250		10.2015		13.0470-2610.2	LD2610	CERAMIC PLAQ. FREIN	A 008 420 38 20 , A 008 420 28 20 , 008 420 38 20 , 008 420 28 20	
	C 250 d		10.2015		13.0460-7304.2	607304	PLAQUETTES DE FREIN	A 008 420 14 20 , 008 420 14 20 , A 000 420 82 00 , 000 420 82 00 , A 008 420 13 20 , 008 420 13 20	cf. Photo
			10.2015		13.0470-2610.2	LD2610	CERAMIC PLAQ. FREIN	A 008 420 38 20 , A 008 420 28 20 , 008 420 38 20 , 008 420 28 20	
	C 250 d 4-matic		04.2016		13.0460-7304.2	607304	PLAQUETTES DE FREIN	A 008 420 14 20 , 008 420 14 20 , A 000 420 82 00 , 000 420 82 00 , A 008 420 13 20 , 008 420 13 20	cf. Photo
			04.2016		13.0470-2610.2	LD2610	CERAMIC PLAQ. FREIN	A 008 420 38 20 , A 008 420 28 20 , 008 420 38 20 , 008 420 28 20	
	C 300		10.2015		13.0460-7304.2	607304	PLAQUETTES DE FREIN	A 008 420 14 20 , 008 420 14 20 , A 000 420 82 00 , 000 420 82 00 , A 008 420 13 20 , 008 420 13 20	cf. Photo
			10.2015		13.0470-2610.2	LD2610	CERAMIC PLAQ. FREIN	A 008 420 38 20 , A 008 420 28 20 , 008 420 38 20 , 008 420 28 20	
	C 400 4-matic		04.2016		13.0460-7304.2	607304	PLAQUETTES DE FREIN	A 008 420 14 20 , 008 420 14 20 , A 000 420 82 00 , 000 420 82 00 , A 008 420 13 20 , 008 420 13 20	cf. Photo
C-Klasse (S204) Kombi (07-14)	C 180 CDI BE	ArD	01.2011	08.2014	11.9381-9954.2	220926	ETRIER A GRIFFE	A 204 423 02 81 , 204 423 02 81	
	C 180 CGI	ArD	04.2009	08.2014	11.9381-9954.2	220926	ETRIER A GRIFFE	A 204 423 02 81 , 204 423 02 81	
	C 180 Kompressor	ArD	09.2007	08.2014	11.9381-9954.2	220926	ETRIER A GRIFFE	A 204 423 02 81 , 204 423 02 81	



description

Références OE
par référence
ATE.

i
Références remplacées /
divers

MERCEDES BENZ

C-Klasse (S204) Kombi (07-14)	C 180 Kompressor	ArD	01.2008	08.2014	11.9381-9954.2	220926	ETRIER A GRIFFE	A 204 423 02 81 , 204 423 02 81
	C 200 CDI	ArD	08.2010	08.2014	11.9381-9954.2	220926	ETRIER A GRIFFE	A 204 423 02 81 , 204 423 02 81
		ArD	09.2007	08.2014	11.9381-9954.2	220926	ETRIER A GRIFFE	A 204 423 02 81 , 204 423 02 81
	C 200 CGI	ArD	04.2009	08.2014	11.9381-9954.2	220926	ETRIER A GRIFFE	A 204 423 02 81 , 204 423 02 81
	C 200 Kompressor	ArD	09.2007	08.2014	11.9381-9954.2	220926	ETRIER A GRIFFE	A 204 423 02 81 , 204 423 02 81
	C 220 CDI	ArD	01.2007	08.2014	11.9381-9954.2	220926	ETRIER A GRIFFE	A 204 423 02 81 , 204 423 02 81
		ArD	09.2007	08.2014	11.9381-9954.2	220926	ETRIER A GRIFFE	A 204 423 02 81 , 204 423 02 81
		ArD	12.2008	08.2014	11.9381-9954.2	220926	ETRIER A GRIFFE	A 204 423 02 81 , 204 423 02 81
	C 220 CDI 4-matic	ArD	02.2013	08.2014	11.9381-9954.2	220926	ETRIER A GRIFFE	A 204 423 02 81 , 204 423 02 81
	C 230	ArD	09.2007	08.2014	11.9381-9954.2	220926	ETRIER A GRIFFE	A 204 423 02 81 , 204 423 02 81
	C 250 CDI 4matic	ArD	04.2009	08.2014	11.9381-9954.2	220926	ETRIER A GRIFFE	A 204 423 02 81 , 204 423 02 81
	C 250 CGI	ArD	04.2009	08.2014	11.9381-9954.2	220926	ETRIER A GRIFFE	A 204 423 02 81 , 204 423 02 81
	C 280	ArD	09.2007	08.2014	11.9381-9954.2	220926	ETRIER A GRIFFE	A 204 423 02 81 , 204 423 02 81
	C 300	ArD	08.2007	08.2014	11.9381-9954.2	220926	ETRIER A GRIFFE	A 204 423 02 81 , 204 423 02 81



description

Références OE
par référence
ATE.

i
Références remplacées /
divers

MERCEDES BENZ

C-Klasse (S205) Kombi (14-)	C 160		04.2015		13.0460-7304.2	607304	PLAQUETTES DE FREIN	A 008 420 14 20 , 008 420 14 20 , A 000 420 82 00 , 000 420 82 00 , A 008 420 13 20 , 008 420 13 20	cf. Photo
	C 180		09.2014		13.0460-7304.2	607304	PLAQUETTES DE FREIN	A 008 420 14 20 , 008 420 14 20 , A 000 420 82 00 , 000 420 82 00 , A 008 420 13 20 , 008 420 13 20	cf. Photo
	C 180 BlueTec		09.2014		13.0460-7304.2	607304	PLAQUETTES DE FREIN	A 008 420 14 20 , 008 420 14 20 , A 000 420 82 00 , 000 420 82 00 , A 008 420 13 20 , 008 420 13 20	cf. Photo
	C 200		09.2014		13.0460-7304.2	607304	PLAQUETTES DE FREIN	A 008 420 14 20 , 008 420 14 20 , A 000 420 82 00 , 000 420 82 00 , A 008 420 13 20 , 008 420 13 20	cf. Photo
	C 200 4-matic		04.2015		13.0460-7304.2	607304	PLAQUETTES DE FREIN	A 008 420 14 20 , 008 420 14 20 , A 000 420 82 00 , 000 420 82 00 , A 008 420 13 20 , 008 420 13 20	cf. Photo
	C 200 BlueTec		09.2014		13.0460-7304.2	607304	PLAQUETTES DE FREIN	A 008 420 14 20 , 008 420 14 20 , A 000 420 82 00 , 000 420 82 00 , A 008 420 13 20 , 008 420 13 20	cf. Photo
	C 200 d		10.2015		13.0460-7304.2	607304	PLAQUETTES DE FREIN	A 008 420 14 20 , 008 420 14 20 , A 000 420 82 00 , 000 420 82 00 , A 008 420 13 20 , 008 420 13 20	cf. Photo
	C 220 BlueTec		09.2014		13.0460-7304.2	607304	PLAQUETTES DE FREIN	A 008 420 14 20 , 008 420 14 20 , A 000 420 82 00 , 000 420 82 00 , A 008 420 13 20 , 008 420 13 20	cf. Photo
	C 220 d 4-matic		04.2015		13.0460-7304.2	607304	PLAQUETTES DE FREIN	A 008 420 14 20 , 008 420 14 20 , A 000 420 82 00 , 000 420 82 00 , A 008 420 13 20 , 008 420 13 20	cf. Photo



description

Références OE
par référence
ATE.

i
Références remplacées /
divers

MERCEDES BENZ

C-Klasse (S205) Kombi (14-)	C 250 BlueTec		09.2014		13.0460-7304.2	607304	PLAQUETTES DE FREIN	A 008 420 14 20 , 008 420 14 20 , A 000 420 82 00 , 000 420 82 00 , A 008 420 13 20 , 008 420 13 20	cf. Photo
	C 250 BlueTec 4-matic		10.2014		13.0460-7304.2	607304	PLAQUETTES DE FREIN	A 008 420 14 20 , 008 420 14 20 , A 000 420 82 00 , 000 420 82 00 , A 008 420 13 20 , 008 420 13 20	cf. Photo
			10.2014		13.0470-2610.2	LD2610	CERAMIC PLAQ. FREIN	A 008 420 38 20 , A 008 420 28 20 , 008 420 38 20 , 008 420 28 20	
	C 250 CGI		09.2014		13.0460-7304.2	607304	PLAQUETTES DE FREIN	A 008 420 14 20 , 008 420 14 20 , A 000 420 82 00 , 000 420 82 00 , A 008 420 13 20 , 008 420 13 20	cf. Photo
	C 300		09.2015		13.0460-7304.2	607304	PLAQUETTES DE FREIN	A 008 420 14 20 , 008 420 14 20 , A 000 420 82 00 , 000 420 82 00 , A 008 420 13 20 , 008 420 13 20	cf. Photo
			09.2015		13.0470-2610.2	LD2610	CERAMIC PLAQ. FREIN	A 008 420 38 20 , A 008 420 28 20 , 008 420 38 20 , 008 420 28 20	
	C 300 BlueTec Hybrid		10.2014		13.0460-7304.2	607304	PLAQUETTES DE FREIN	A 008 420 14 20 , 008 420 14 20 , A 000 420 82 00 , 000 420 82 00 , A 008 420 13 20 , 008 420 13 20	cf. Photo
	C 350 e Hybrid		02.2015		13.0460-7304.2	607304	PLAQUETTES DE FREIN	A 008 420 14 20 , 008 420 14 20 , A 000 420 82 00 , 000 420 82 00 , A 008 420 13 20 , 008 420 13 20	cf. Photo
	C 400 4-matic		10.2014		13.0460-7304.2	607304	PLAQUETTES DE FREIN	A 008 420 14 20 , 008 420 14 20 , A 000 420 82 00 , 000 420 82 00 , A 008 420 13 20 , 008 420 13 20	cf. Photo



description

Références OE
par référence
ATE.

i
Références remplacées /
divers

MERCEDES BENZ

C-Klasse (S205) Kombi (14-)	C 450 AMG 4-matic		04.2015		13.0460-7304.2	607304	PLAQUETTES DE FREIN	A 008 420 14 20 , 008 420 14 20 , A 000 420 82 00 , 000 420 82 00 , A 008 420 13 20 , 008 420 13 20	cf. Photo
C-Klasse (W204) Limousine (07-14)	C 180 CDI	ArD	01.2011	01.2014	11.9381-9954.2	220926	ETRIER A GRIFFE	A 204 423 02 81 , 204 423 02 81	
	C 180 CGI	ArD	04.2009	01.2014	11.9381-9954.2	220926	ETRIER A GRIFFE	A 204 423 02 81 , 204 423 02 81	
	C 180 Kompressor	ArD	01.2008	01.2014	11.9381-9954.2	220926	ETRIER A GRIFFE	A 204 423 02 81 , 204 423 02 81	
		ArD	03.2007	01.2014	11.9381-9954.2	220926	ETRIER A GRIFFE	A 204 423 02 81 , 204 423 02 81	
	C 200	ArD	05.2011	01.2014	11.9381-9954.2	220926	ETRIER A GRIFFE	A 204 423 02 81 , 204 423 02 81	
	C 200 CDI	ArD	01.2011	01.2014	11.9381-9954.2	220926	ETRIER A GRIFFE	A 204 423 02 81 , 204 423 02 81	
		ArD	03.2007	01.2014	11.9381-9954.2	220926	ETRIER A GRIFFE	A 204 423 02 81 , 204 423 02 81	
	C 200 CGI	ArD	04.2009	01.2014	11.9381-9954.2	220926	ETRIER A GRIFFE	A 204 423 02 81 , 204 423 02 81	
	C 200 Kompressor	ArD	03.2007	01.2014	11.9381-9954.2	220926	ETRIER A GRIFFE	A 204 423 02 81 , 204 423 02 81	
	C 220 CDI	ArD	12.2008	01.2014	11.9381-9954.2	220926	ETRIER A GRIFFE	A 204 423 02 81 , 204 423 02 81	
		ArD	03.2007	01.2014	11.9381-9954.2	220926	ETRIER A GRIFFE	A 204 423 02 81 , 204 423 02 81	
	C 220 CDI 4-matic	ArD	02.2013	01.2014	11.9381-9954.2	220926	ETRIER A GRIFFE	A 204 423 02 81 , 204 423 02 81	
	C 230	ArD	03.2007	01.2014	11.9381-9954.2	220926	ETRIER A GRIFFE	A 204 423 02 81 , 204 423 02 81	



					description	Références OE par référence ATE.		Références remplacées / divers
--	--	--	--	--	-------------	----------------------------------	--	--------------------------------

MERCEDES BENZ

C-Klasse (W204) Limousine (07-14)	C 230 4-matic	ArD	07.2007	01.2014	11.9381-9954.2	220926	ETRIER A GRIFFE	A 204 423 02 81 , 204 423 02 81	
	C 250 CDI 4-matic	ArD	01.2011	01.2014	11.9381-9954.2	220926	ETRIER A GRIFFE	A 204 423 02 81 , 204 423 02 81	
	C 250 CGI	ArD	04.2009	01.2014	11.9381-9954.2	220926	ETRIER A GRIFFE	A 204 423 02 81 , 204 423 02 81	
	C 280	ArD	03.2007	01.2014	11.9381-9954.2	220926	ETRIER A GRIFFE	A 204 423 02 81 , 204 423 02 81	
	C 280 4-matic	ArD	07.2007	01.2014	11.9381-9954.2	220926	ETRIER A GRIFFE	A 204 423 02 81 , 204 423 02 81	
	C 300	ArD	07.2009	01.2014	11.9381-9954.2	220926	ETRIER A GRIFFE	A 204 423 02 81 , 204 423 02 81	
	C 300 4-matic	ArD	04.2009	01.2014	11.9381-9954.2	220926	ETRIER A GRIFFE	A 204 423 02 81 , 204 423 02 81	
C-Klasse (W205) Limousine (14-)	C 160		04.2015		13.0460-7304.2	607304	PLAQUETTES DE FREIN	A 008 420 14 20 , 008 420 14 20 , A 000 420 82 00 , 000 420 82 00 , A 008 420 13 20 , 008 420 13 20	cf. Photo
	C 180		02.2014		13.0460-7304.2	607304	PLAQUETTES DE FREIN	A 008 420 14 20 , 008 420 14 20 , A 000 420 82 00 , 000 420 82 00 , A 008 420 13 20 , 008 420 13 20	cf. Photo
	C 180 BlueTec		05.2014		13.0460-7304.2	607304	PLAQUETTES DE FREIN	A 008 420 14 20 , 008 420 14 20 , A 000 420 82 00 , 000 420 82 00 , A 008 420 13 20 , 008 420 13 20	cf. Photo
	C 200		02.2014		13.0460-7304.2	607304	PLAQUETTES DE FREIN	A 008 420 14 20 , 008 420 14 20 , A 000 420 82 00 , 000 420 82 00 , A 008 420 13 20 , 008 420 13 20	cf. Photo



description

Références OE
par référence
ATE.

i
Références remplacées /
divers

MERCEDES BENZ

C-Klasse (W205) Limousine (14-)	C 200 4-matic		04.2015		13.0460-7304.2	607304	PLAQUETTES DE FREIN	A 008 420 14 20 , 008 420 14 20 , A 000 420 82 00 , 000 420 82 00 , A 008 420 13 20 , 008 420 13 20	cf. Photo
	C 200 BlueTec		05.2014		13.0460-7304.2	607304	PLAQUETTES DE FREIN	A 008 420 14 20 , 008 420 14 20 , A 000 420 82 00 , 000 420 82 00 , A 008 420 13 20 , 008 420 13 20	cf. Photo
	C 200 d		10.2015		13.0460-7304.2	607304	PLAQUETTES DE FREIN	A 008 420 14 20 , 008 420 14 20 , A 000 420 82 00 , 000 420 82 00 , A 008 420 13 20 , 008 420 13 20	cf. Photo
	C 220 BlueTec		02.2014		13.0460-7304.2	607304	PLAQUETTES DE FREIN	A 008 420 14 20 , 008 420 14 20 , A 000 420 82 00 , 000 420 82 00 , A 008 420 13 20 , 008 420 13 20	cf. Photo
			03.2014		13.0460-7304.2	607304	PLAQUETTES DE FREIN	A 008 420 14 20 , 008 420 14 20 , A 000 420 82 00 , 000 420 82 00 , A 008 420 13 20 , 008 420 13 20	cf. Photo
	C 220 BlueTec 4-matic		04.2015		13.0460-7304.2	607304	PLAQUETTES DE FREIN	A 008 420 14 20 , 008 420 14 20 , A 000 420 82 00 , 000 420 82 00 , A 008 420 13 20 , 008 420 13 20	cf. Photo
	C 250 BlueTec		02.2014		13.0460-7304.2	607304	PLAQUETTES DE FREIN	A 008 420 14 20 , 008 420 14 20 , A 000 420 82 00 , 000 420 82 00 , A 008 420 13 20 , 008 420 13 20	cf. Photo
	C 250 BlueTec 4-matic		02.2014		13.0460-7304.2	607304	PLAQUETTES DE FREIN	A 008 420 14 20 , 008 420 14 20 , A 000 420 82 00 , 000 420 82 00 , A 008 420 13 20 , 008 420 13 20	cf. Photo
			05.2014		13.0470-2610.2	LD2610	CERAMIC PLAQ. FREIN	A 008 420 38 20 , A 008 420 28 20 , 008 420 38 20 , 008 420 28 20	



description

Références OE
par référence
ATE.

i
Références remplacées /
divers

MERCEDES BENZ

C-Klasse (W205) Limousine (14-)	C 250 CGI		03.2014		13.0460-7304.2	607304	PLAQUETTES DE FREIN	A 008 420 14 20 , 008 420 14 20 , A 000 420 82 00 , 000 420 82 00 , A 008 420 13 20 , 008 420 13 20	cf. Photo
	C 300		09.2015		13.0460-7304.2	607304	PLAQUETTES DE FREIN	A 008 420 14 20 , 008 420 14 20 , A 000 420 82 00 , 000 420 82 00 , A 008 420 13 20 , 008 420 13 20	cf. Photo
			09.2015		13.0470-2610.2	LD2610	CERAMIC PLAQ. FREIN	A 008 420 38 20 , A 008 420 28 20 , 008 420 38 20 , 008 420 28 20	
	C 300 BlueTec Hybrid		05.2014		13.0460-7304.2	607304	PLAQUETTES DE FREIN	A 008 420 14 20 , 008 420 14 20 , A 000 420 82 00 , 000 420 82 00 , A 008 420 13 20 , 008 420 13 20	cf. Photo
	C 350 e Hybrid		02.2015		13.0460-7304.2	607304	PLAQUETTES DE FREIN	A 008 420 14 20 , 008 420 14 20 , A 000 420 82 00 , 000 420 82 00 , A 008 420 13 20 , 008 420 13 20	cf. Photo
	C 400 4-matic		10.2014		13.0460-7304.2	607304	PLAQUETTES DE FREIN	A 008 420 14 20 , 008 420 14 20 , A 000 420 82 00 , 000 420 82 00 , A 008 420 13 20 , 008 420 13 20	cf. Photo
	C 450 AMG 4-matic		04.2015		13.0460-7304.2	607304	PLAQUETTES DE FREIN	A 008 420 14 20 , 008 420 14 20 , A 000 420 82 00 , 000 420 82 00 , A 008 420 13 20 , 008 420 13 20	cf. Photo
E-Klasse (A207) Cabrio (10-)	E 200 CGI	ArD	03.2010		11.9381-9954.2	220926	ETRIER A GRIFFE	A 204 423 02 81 , 204 423 02 81	
	E 220 BlueTec	ArD	05.2014		11.9381-9954.2	220926	ETRIER A GRIFFE	A 204 423 02 81 , 204 423 02 81	
	E 220 CDI	ArD	03.2010		11.9381-9954.2	220926	ETRIER A GRIFFE	A 204 423 02 81 , 204 423 02 81	



description

Références OE
par référence
ATE.

i
Références remplacées /
divers

MERCEDES BENZ

E-Klasse (A207) Cabrio (10-)	E 250 CDI	ArD	03.2010		11.9381-9954.2	220926	ETRIER A GRIFFE	A 204 423 02 81 , 204 423 02 81
	E 250 CGI	ArD	03.2010		11.9381-9954.2	220926	ETRIER A GRIFFE	A 204 423 02 81 , 204 423 02 81
Classe E (W212) Coupé (09-)	E 200 CGI	ArD	09.2009		11.9381-9954.2	220926	ETRIER A GRIFFE	A 204 423 02 81 , 204 423 02 81
	E 220 BlueTec	ArD	05.2014		11.9381-9954.2	220926	ETRIER A GRIFFE	A 204 423 02 81 , 204 423 02 81
	E 220 CDI	ArD	05.2009		11.9381-9954.2	220926	ETRIER A GRIFFE	A 204 423 02 81 , 204 423 02 81
		ArD	07.2014		11.9381-9954.2	220926	ETRIER A GRIFFE	A 204 423 02 81 , 204 423 02 81
	E 250 CDI	ArD	05.2009		11.9381-9954.2	220926	ETRIER A GRIFFE	A 204 423 02 81 , 204 423 02 81
	E 250 CGI	ArD	05.2009		11.9381-9954.2	220926	ETRIER A GRIFFE	A 204 423 02 81 , 204 423 02 81
E-Klasse (S213) Kombi (16-)	E 250		07.2016		13.0470-2610.2	LD2610	CERAMIC PLAQ. FREIN	A 008 420 38 20 , A 008 420 28 20 , 008 420 38 20 , 008 420 28 20
E-Klasse (W213) Limousine (16-)	E 200 4-matic		07.2016		13.0470-2610.2	LD2610	CERAMIC PLAQ. FREIN	A 008 420 38 20 , A 008 420 28 20 , 008 420 38 20 , 008 420 28 20
	E 220d 4-matic		10.2016		13.0470-2610.2	LD2610	CERAMIC PLAQ. FREIN	A 008 420 38 20 , A 008 420 28 20 , 008 420 38 20 , 008 420 28 20
	E 250		07.2016		13.0470-2610.2	LD2610	CERAMIC PLAQ. FREIN	A 008 420 38 20 , A 008 420 28 20 , 008 420 38 20 , 008 420 28 20
Transporter (BM 901/902) SPRINTER (95-06)	208 CDI		04.2000	05.2006	11.8170-0510.1	260111	CALIPER MOUNT. BRACKET	2D0 615 125 , A 000 421 45 06 , A 000 421 04 06 , 000 421 45 06 , 000 421 04 06



description

Références OE
par référence
ATE.

i
Références remplacées /
divers

MERCEDES BENZ

Transporter (BM 901/902) SPRINTER (95-06)	208 D		02.1995	05.2006	11.8170-0510.1	260111	CALIPER MOUNT. BRACKET	2D0 615 125 , A 000 421 45 06 , A 000 421 04 06 , 000 421 45 06 , 000 421 04 06	
	210 D		01.1997	05.2006	11.8170-0510.1	260111	CALIPER MOUNT. BRACKET	2D0 615 125 , A 000 421 45 06 , A 000 421 04 06 , 000 421 45 06 , 000 421 04 06	
	211 CDI		04.2000	05.2006	11.8170-0510.1	260111	CALIPER MOUNT. BRACKET	2D0 615 125 , A 000 421 45 06 , A 000 421 04 06 , 000 421 45 06 , 000 421 04 06	
	212 D		02.1995	05.2006	11.8170-0510.1	260111	CALIPER MOUNT. BRACKET	2D0 615 125 , A 000 421 45 06 , A 000 421 04 06 , 000 421 45 06 , 000 421 04 06	
	213 CDI		04.2000	05.2006	11.8170-0510.1	260111	CALIPER MOUNT. BRACKET	2D0 615 125 , A 000 421 45 06 , A 000 421 04 06 , 000 421 45 06 , 000 421 04 06	
	214		02.1995	05.2006	11.8170-0510.1	260111	CALIPER MOUNT. BRACKET	2D0 615 125 , A 000 421 45 06 , A 000 421 04 06 , 000 421 45 06 , 000 421 04 06	
			04.2000	05.2006	11.8170-0510.1	260111	CALIPER MOUNT. BRACKET	2D0 615 125 , A 000 421 45 06 , A 000 421 04 06 , 000 421 45 06 , 000 421 04 06	
	216 CDI		04.2000	05.2006	11.8170-0510.1	260111	CALIPER MOUNT. BRACKET	2D0 615 125 , A 000 421 45 06 , A 000 421 04 06 , 000 421 45 06 , 000 421 04 06	
Transporter (BM 903/904) SPRINTER (95-06)	308 CDI		04.2000	05.2006	11.8170-0510.1	260111	CALIPER MOUNT. BRACKET	2D0 615 125 , A 000 421 45 06 , A 000 421 04 06 , 000 421 45 06 , 000 421 04 06	
	308 D		02.1995	05.2006	11.8170-0510.1	260111	CALIPER MOUNT. BRACKET	2D0 615 125 , A 000 421 45 06 , A 000 421 04 06 , 000 421 45 06 , 000 421 04 06	
	310 D		02.1995	05.2006	11.8170-0510.1	260111	CALIPER MOUNT. BRACKET	2D0 615 125 , A 000 421 45 06 , A 000 421 04 06 , 000 421 45 06 , 000 421 04 06	



description

Références OE
par référence
ATE.

i
Références remplacées /
divers

MERCEDES BENZ

Transporter (BM 903/904) SPRINTER (95-06)	311 CDI		04.2000	05.2006	11.8170-0510.1	260111	CALIPER MOUNT. BRACKET	2D0 615 125 , A 000 421 45 06 , A 000 421 04 06 , 000 421 45 06 , 000 421 04 06	
	312 D		02.1995	05.2006	11.8170-0510.1	260111	CALIPER MOUNT. BRACKET	2D0 615 125 , A 000 421 45 06 , A 000 421 04 06 , 000 421 45 06 , 000 421 04 06	
	313 CDI		04.2000	05.2006	11.8170-0510.1	260111	CALIPER MOUNT. BRACKET	2D0 615 125 , A 000 421 45 06 , A 000 421 04 06 , 000 421 45 06 , 000 421 04 06	
	314		02.1995	05.2006	11.8170-0510.1	260111	CALIPER MOUNT. BRACKET	2D0 615 125 , A 000 421 45 06 , A 000 421 04 06 , 000 421 45 06 , 000 421 04 06	
			04.2000	05.2006	11.8170-0510.1	260111	CALIPER MOUNT. BRACKET	2D0 615 125 , A 000 421 45 06 , A 000 421 04 06 , 000 421 45 06 , 000 421 04 06	
	316 CDI		04.2000	05.2006	11.8170-0510.1	260111	CALIPER MOUNT. BRACKET	2D0 615 125 , A 000 421 45 06 , A 000 421 04 06 , 000 421 45 06 , 000 421 04 06	
	408 CDI		04.2000	05.2006	11.8170-0510.1	260111	CALIPER MOUNT. BRACKET	2D0 615 125 , A 000 421 45 06 , A 000 421 04 06 , 000 421 45 06 , 000 421 04 06	
	408 D		06.1995	05.2006	11.8170-0510.1	260111	CALIPER MOUNT. BRACKET	2D0 615 125 , A 000 421 45 06 , A 000 421 04 06 , 000 421 45 06 , 000 421 04 06	
	410 D		09.1996	05.2006	11.8170-0510.1	260111	CALIPER MOUNT. BRACKET	2D0 615 125 , A 000 421 45 06 , A 000 421 04 06 , 000 421 45 06 , 000 421 04 06	
	411 CDI		04.2000	05.2006	11.8170-0510.1	260111	CALIPER MOUNT. BRACKET	2D0 615 125 , A 000 421 45 06 , A 000 421 04 06 , 000 421 45 06 , 000 421 04 06	
	412 D		06.1995	05.2006	11.8170-0510.1	260111	CALIPER MOUNT. BRACKET	2D0 615 125 , A 000 421 45 06 , A 000 421 04 06 , 000 421 45 06 , 000 421 04 06	



description







Références OE
par référence
ATE.

i
Références remplacées /
divers

MERCEDES BENZ

Modèle	Code	04.2000	05.2006	11.8170-0510.1	260111	description	Références OE par référence ATE.	Références remplacées / divers
Transporter (BM 903/904) SPRINTER (95-06)	413 CDI					CALIPER MOUNT. BRACKET	2D0 615 125 , A 000 421 45 06 , A 000 421 04 06 , 000 421 45 06 , 000 421 04 06	
	414					CALIPER MOUNT. BRACKET	2D0 615 125 , A 000 421 45 06 , A 000 421 04 06 , 000 421 45 06 , 000 421 04 06	
		06.1995	05.2006	11.8170-0510.1	260111	CALIPER MOUNT. BRACKET	2D0 615 125 , A 000 421 45 06 , A 000 421 04 06 , 000 421 45 06 , 000 421 04 06	
	416 CDI					CALIPER MOUNT. BRACKET	2D0 615 125 , A 000 421 45 06 , A 000 421 04 06 , 000 421 45 06 , 000 421 04 06	
VITO (BM638) (96-03)	108 CDI					CALIPER MOUNT. BRACKET	2D0 615 125 , A 000 421 45 06 , A 000 421 04 06 , 000 421 45 06 , 000 421 04 06	
	108 D					CALIPER MOUNT. BRACKET	2D0 615 125 , A 000 421 45 06 , A 000 421 04 06 , 000 421 45 06 , 000 421 04 06	
	110 CDI					CALIPER MOUNT. BRACKET	2D0 615 125 , A 000 421 45 06 , A 000 421 04 06 , 000 421 45 06 , 000 421 04 06	
	110 D					CALIPER MOUNT. BRACKET	2D0 615 125 , A 000 421 45 06 , A 000 421 04 06 , 000 421 45 06 , 000 421 04 06	
	112 CDI					CALIPER MOUNT. BRACKET	2D0 615 125 , A 000 421 45 06 , A 000 421 04 06 , 000 421 45 06 , 000 421 04 06	
	113					CALIPER MOUNT. BRACKET	2D0 615 125 , A 000 421 45 06 , A 000 421 04 06 , 000 421 45 06 , 000 421 04 06	
	114					CALIPER MOUNT. BRACKET	2D0 615 125 , A 000 421 45 06 , A 000 421 04 06 , 000 421 45 06 , 000 421 04 06	



					description	Références OE par référence ATE.	 Références remplacées / divers
---	---	---	--	---	--------------------	---	--

MERCEDES BENZ

Classe V (BM638) (96-03)	V 200		09.1996	08.2003	11.8170-0510.1	260111	CALIPER MOUNT. BRACKET	2D0 615 125 , A 000 421 45 06 , A 000 421 04 06 , 000 421 45 06 , 000 421 04 06	
	V 200 CDI		03.1999	08.2003	11.8170-0510.1	260111	CALIPER MOUNT. BRACKET	2D0 615 125 , A 000 421 45 06 , A 000 421 04 06 , 000 421 45 06 , 000 421 04 06	
	V 220 CDI		03.1999	08.2003	11.8170-0510.1	260111	CALIPER MOUNT. BRACKET	2D0 615 125 , A 000 421 45 06 , A 000 421 04 06 , 000 421 45 06 , 000 421 04 06	
	V 230		09.1996	08.2003	11.8170-0510.1	260111	CALIPER MOUNT. BRACKET	2D0 615 125 , A 000 421 45 06 , A 000 421 04 06 , 000 421 45 06 , 000 421 04 06	
	V 230 TD		09.1996	08.2003	11.8170-0510.1	260111	CALIPER MOUNT. BRACKET	2D0 615 125 , A 000 421 45 06 , A 000 421 04 06 , 000 421 45 06 , 000 421 04 06	
	V 280		09.1997	08.2003	11.8170-0510.1	260111	CALIPER MOUNT. BRACKET	2D0 615 125 , A 000 421 45 06 , A 000 421 04 06 , 000 421 45 06 , 000 421 04 06	



description

Références OE
par référence
ATE.

i
Références remplacées /
divers

MINI

F54 Clubman (15-)	Cooper		07.2015		24.0110-0401.1	410401	DISQUE DE FREIN	34 21 6 799 367	
	Cooper D		07.2015		24.0110-0401.1	410401	DISQUE DE FREIN	34 21 6 799 367	
	Cooper S		07.2015		24.0110-0401.1	410401	DISQUE DE FREIN	34 21 6 799 367	
	Cooper SD		11.2015		24.0110-0401.1	410401	DISQUE DE FREIN	34 21 6 799 367	
	Cooper SDX All4		01.2016		24.0110-0401.1	410401	DISQUE DE FREIN	34 21 6 799 367	
	Cooper SX All4		01.2016		24.0110-0401.1	410401	DISQUE DE FREIN	34 21 6 799 367	
	One		11.2015		24.0110-0401.1	410401	DISQUE DE FREIN	34 21 6 799 367	
	One D		11.2015		24.0110-0401.1	410401	DISQUE DE FREIN	34 21 6 799 367	
F60 Countryman (17-)	Cooper		10.2016		24.0110-0401.1	410401	DISQUE DE FREIN	34 21 6 799 367	
	Cooper All4		10.2016		24.0110-0401.1	410401	DISQUE DE FREIN	34 21 6 799 367	
	Cooper D		10.2016		24.0110-0401.1	410401	DISQUE DE FREIN	34 21 6 799 367	
	Cooper D All4		10.2016		24.0110-0401.1	410401	DISQUE DE FREIN	34 21 6 799 367	
	Cooper S		10.2016		24.0110-0401.1	410401	DISQUE DE FREIN	34 21 6 799 367	
	Cooper S All4		10.2016		24.0110-0401.1	410401	DISQUE DE FREIN	34 21 6 799 367	
	Cooper SD		10.2016		24.0110-0401.1	410401	DISQUE DE FREIN	34 21 6 799 367	
	Cooper SD All4		10.2016		24.0110-0401.1	410401	DISQUE DE FREIN	34 21 6 799 367	
R50 / R53 (00-06)	Cooper		06.2000	11.2006	28.0461-0271.1	BAR102	DISQUE DE FREIN	34 21 6 774 987 , 34 21 1 503 070	
	Cooper JCW		11.2003	11.2006	28.0461-0271.1	BAR102	DISQUE DE FREIN	34 21 6 774 987 , 34 21 1 503 070	
	Cooper JCW S		11.2003	11.2006	28.0461-0271.1	BAR102	DISQUE DE FREIN	34 21 6 774 987 , 34 21 1 503 070	



description

Références OE
par référence
ATE.

i
Références remplacées /
divers

MINI

R50 / R53 (00-06)	Cooper S		07.2002	11.2006	28.0461-0271.1	BAR102	DISQUE DE FREIN	34 21 6 774 987 , 34 21 1 503 070	
	One		06.2000	11.2006	28.0461-0271.1	BAR102	DISQUE DE FREIN	34 21 6 774 987 , 34 21 1 503 070	
	One 1,4		06.2000	11.2006	28.0461-0271.1	BAR102	DISQUE DE FREIN	34 21 6 774 987 , 34 21 1 503 070	
	One D		03.2003	11.2006	28.0461-0271.1	BAR102	DISQUE DE FREIN	34 21 6 774 987 , 34 21 1 503 070	
R52 Décapotable (04-08)	Cooper		04.2004	08.2008	28.0461-0271.1	BAR102	DISQUE DE FREIN	34 21 6 774 987 , 34 21 1 503 070	
	Cooper S		04.2004	08.2008	28.0461-0271.1	BAR102	DISQUE DE FREIN	34 21 6 774 987 , 34 21 1 503 070	
	Cooper S JCW		11.2003	08.2008	28.0461-0271.1	BAR102	DISQUE DE FREIN	34 21 6 774 987 , 34 21 1 503 070	
	One		04.2004	08.2008	28.0461-0271.1	BAR102	DISQUE DE FREIN	34 21 6 774 987 , 34 21 1 503 070	
R55 Clubman (07-14)	Cooper		09.2007	06.2014	28.0461-0271.1	BAR102	DISQUE DE FREIN	34 21 6 774 987 , 34 21 1 503 070	
	Cooper D		09.2007	06.2014	28.0461-0271.1	BAR102	DISQUE DE FREIN	34 21 6 774 987 , 34 21 1 503 070	
	Cooper S		09.2007	06.2014	28.0461-0271.1	BAR102	DISQUE DE FREIN	34 21 6 774 987 , 34 21 1 503 070	
	Cooper SD		02.2011	06.2014	28.0461-0271.1	BAR102	DISQUE DE FREIN	34 21 6 774 987 , 34 21 1 503 070	
	One		03.2010	06.2014	28.0461-0271.1	BAR102	DISQUE DE FREIN	34 21 6 774 987 , 34 21 1 503 070	
	One D		03.2010	06.2014	28.0461-0271.1	BAR102	DISQUE DE FREIN	34 21 6 774 987 , 34 21 1 503 070	



description

Références OE
par référence
ATE.

i
Références remplacées /
divers

MINI

R55 Clubvan (12-)	Cooper		12.2012		28.0461-0271.1	BAR102	DISQUE DE FREIN	34 21 6 774 987 , 34 21 1 503 070	
	Cooper D		12.2012		28.0461-0271.1	BAR102	DISQUE DE FREIN	34 21 6 774 987 , 34 21 1 503 070	
	One		12.2012		28.0461-0271.1	BAR102	DISQUE DE FREIN	34 21 6 774 987 , 34 21 1 503 070	
R56 (06-14)	Cooper		03.2010	06.2014	28.0461-0271.1	BAR102	DISQUE DE FREIN	34 21 6 774 987 , 34 21 1 503 070	
			11.2006	06.2014	28.0461-0271.1	BAR102	DISQUE DE FREIN	34 21 6 774 987 , 34 21 1 503 070	
	Cooper D		04.2007	06.2014	28.0461-0271.1	BAR102	DISQUE DE FREIN	34 21 6 774 987 , 34 21 1 503 070	
	Cooper S		11.2006	06.2014	28.0461-0271.1	BAR102	DISQUE DE FREIN	34 21 6 774 987 , 34 21 1 503 070	
			01.2012	06.2014	28.0461-0271.1	BAR102	DISQUE DE FREIN	34 21 6 774 987 , 34 21 1 503 070	
			03.2010	06.2014	28.0461-0271.1	BAR102	DISQUE DE FREIN	34 21 6 774 987 , 34 21 1 503 070	
	Cooper SD		02.2011	06.2014	28.0461-0271.1	BAR102	DISQUE DE FREIN	34 21 6 774 987 , 34 21 1 503 070	
	One		03.2010	06.2014	28.0461-0271.1	BAR102	DISQUE DE FREIN	34 21 6 774 987 , 34 21 1 503 070	
			04.2007	06.2014	28.0461-0271.1	BAR102	DISQUE DE FREIN	34 21 6 774 987 , 34 21 1 503 070	
			03.2009	06.2014	28.0461-0271.1	BAR102	DISQUE DE FREIN	34 21 6 774 987 , 34 21 1 503 070	
	One D		03.2010	06.2014	28.0461-0271.1	BAR102	DISQUE DE FREIN	34 21 6 774 987 , 34 21 1 503 070	



description

Références OE
par référence
ATE.

i
Références remplacées /
divers

MINI

R57 Cabrio (09-14)	Cooper		01.2009	06.2014	28.0461-0271.1	BAR102	DISQUE DE FREIN	34 21 6 774 987 , 34 21 1 503 070	
			03.2010	06.2014	28.0461-0271.1	BAR102	DISQUE DE FREIN	34 21 6 774 987 , 34 21 1 503 070	
	Cooper D		06.2010	06.2014	28.0461-0271.1	BAR102	DISQUE DE FREIN	34 21 6 774 987 , 34 21 1 503 070	
	Cooper S		03.2010	06.2014	28.0461-0271.1	BAR102	DISQUE DE FREIN	34 21 6 774 987 , 34 21 1 503 070	
			01.2009	06.2014	28.0461-0271.1	BAR102	DISQUE DE FREIN	34 21 6 774 987 , 34 21 1 503 070	
	Cooper SD		02.2011	06.2014	28.0461-0271.1	BAR102	DISQUE DE FREIN	34 21 6 774 987 , 34 21 1 503 070	
	One		03.2010	06.2014	28.0461-0271.1	BAR102	DISQUE DE FREIN	34 21 6 774 987 , 34 21 1 503 070	
R58 Coupe (11-)	Cooper		10.2011		28.0461-0271.1	BAR102	DISQUE DE FREIN	34 21 6 774 987 , 34 21 1 503 070	
	Cooper S		10.2011		28.0461-0271.1	BAR102	DISQUE DE FREIN	34 21 6 774 987 , 34 21 1 503 070	
	Cooper SD		10.2011		28.0461-0271.1	BAR102	DISQUE DE FREIN	34 21 6 774 987 , 34 21 1 503 070	
R59 Roadster (12-)	Cooper		02.2012		28.0461-0271.1	BAR102	DISQUE DE FREIN	34 21 6 774 987 , 34 21 1 503 070	
	Cooper S		02.2012		28.0461-0271.1	BAR102	DISQUE DE FREIN	34 21 6 774 987 , 34 21 1 503 070	
	Cooper SD		02.2012		28.0461-0271.1	BAR102	DISQUE DE FREIN	34 21 6 774 987 , 34 21 1 503 070	



description

Références OE
par référence
ATE.

i
Références remplacées /
divers

MITSUBISHI

L 200 (06-15)	2,5 DI-D		10.2007		03.0137-0518.2	650518	JEU DE MACHOIRE	4600A122 , 4600A106	
			04.2010		03.0137-0518.2	650518	JEU DE MACHOIRE	4600A122 , 4600A106	
	2,5 DI-D 4x4		11.2005	12.2015	03.0137-0518.2	650518	JEU DE MACHOIRE	4600A122 , 4600A106	
			01.2006		03.0137-0518.2	650518	JEU DE MACHOIRE	4600A122 , 4600A106	
			04.2010		03.0137-0518.2	650518	JEU DE MACHOIRE	4600A122 , 4600A106	
	2,5 DI-D RWD		01.2006		03.0137-0518.2	650518	JEU DE MACHOIRE	4600A122 , 4600A106	
			04.2010		03.0137-0518.2	650518	JEU DE MACHOIRE	4600A122 , 4600A106	
			08.2007		03.0137-0518.2	650518	JEU DE MACHOIRE	4600A122 , 4600A106	
L 200 (15-)	2,4 DI-D (KJ0T)		09.2015		03.0137-0518.2	650518	JEU DE MACHOIRE	4600A122 , 4600A106	
	2,4 DI-D 4WD		09.2015		03.0137-0518.2	650518	JEU DE MACHOIRE	4600A122 , 4600A106	
	2,4 DI-D 4WD (KJ0T)		09.2015		03.0137-0518.2	650518	JEU DE MACHOIRE	4600A122 , 4600A106	
MIRAGE (13-)	1,2		10.2013		03.0137-0530.2	650530	JEU DE MACHOIRE	4600A346	
PAJERO SPORT (KH_) (09-)	3,2 DI-D		11.2009		03.0137-0518.2	650518	JEU DE MACHOIRE	4600A122 , 4600A106	
	3,5 V6		09.2008		03.0137-0518.2	650518	JEU DE MACHOIRE	4600A122 , 4600A106	
SPACE STAR (A05A) (12-)	1,0 12V		05.2012		03.0137-0530.2	650530	JEU DE MACHOIRE	4600A346	
	1,2 12V		05.2012		03.0137-0530.2	650530	JEU DE MACHOIRE	4600A346	
			10.2012		03.0137-0530.2	650530	JEU DE MACHOIRE	4600A346	



description

Références OE
par référence
ATE.

i
Références remplacées /
divers

NISSAN

NV 200 (M20) Kasten (10-)	1,5 dCi		02.2010		03.0137-0513.2	650513	JEU DE MACHOIRE	D4060-JX00A	
			04.2011		03.0137-0513.2	650513	JEU DE MACHOIRE	D4060-JX00A	
	1,6 i 16V		02.2010		03.0137-0513.2	650513	JEU DE MACHOIRE	D4060-JX00A	
NV 200 EVALIA (M20) Bus (10-)	1,5 dCi		04.2011		03.0137-0513.2	650513	JEU DE MACHOIRE	D4060-JX00A	
			07.2010		03.0137-0513.2	650513	JEU DE MACHOIRE	D4060-JX00A	
	1,6 i 16V		07.2010		03.0137-0513.2	650513	JEU DE MACHOIRE	D4060-JX00A	

OPEL

ASTRA H / GTC / Vauxhall Astra Mk V (04-10)	1,2		08.2006	11.2010	03.0137-0520.2	650520	JEU DE MACHOIRE	93189978 , 16 05 358 , 93195331 , 16 05 224	
	1,4		08.2006	11.2010	03.0137-0520.2	650520	JEU DE MACHOIRE	93189978 , 16 05 358 , 93195331 , 16 05 224	
	1,6		08.2006	11.2010	03.0137-0520.2	650520	JEU DE MACHOIRE	93189978 , 16 05 358 , 93195331 , 16 05 224	
	1,7 CDTI		08.2006	11.2010	03.0137-0520.2	650520	JEU DE MACHOIRE	93189978 , 16 05 358 , 93195331 , 16 05 224	
ASTRA H Caravan/Vau. Astra MKV Estate (04-10)	1,2		08.2006	11.2010	03.0137-0520.2	650520	JEU DE MACHOIRE	93189978 , 16 05 358 , 93195331 , 16 05 224	
	1,4		08.2006	11.2010	03.0137-0520.2	650520	JEU DE MACHOIRE	93189978 , 16 05 358 , 93195331 , 16 05 224	
	1,6		08.2006	11.2010	03.0137-0520.2	650520	JEU DE MACHOIRE	93189978 , 16 05 358 , 93195331 , 16 05 224	
	1,7 CDTI		08.2006	11.2010	03.0137-0520.2	650520	JEU DE MACHOIRE	93189978 , 16 05 358 , 93195331 , 16 05 224	
	1,7 TD		08.2006	11.2010	03.0137-0520.2	650520	JEU DE MACHOIRE	93189978 , 16 05 358 , 93195331 , 16 05 224	



	i			<i>Atc</i>	description	Références OE par référence ATE.	i Références remplacées / divers
--	----------	--	--	------------	-------------	--	---

RENAULT

TWINGO II (CN0_) (07-14)	1,2		10.2012	07.2014	03.0137-0522.2	650522	JEU DE MACHOIRE	453 423 01 00 , 44 06 018 43R	
	1,2 16V		10.2012	07.2014	03.0137-0522.2	650522	JEU DE MACHOIRE	453 423 01 00 , 44 06 018 43R	
	1,2 TCe 100		10.2012	07.2014	03.0137-0522.2	650522	JEU DE MACHOIRE	453 423 01 00 , 44 06 018 43R	
	1,2 Turbo		10.2012	07.2014	03.0137-0522.2	650522	JEU DE MACHOIRE	453 423 01 00 , 44 06 018 43R	
	1,5 dCi		10.2012	07.2014	03.0137-0522.2	650522	JEU DE MACHOIRE	453 423 01 00 , 44 06 018 43R	
	1,5 dCi 75		10.2012	07.2014	03.0137-0522.2	650522	JEU DE MACHOIRE	453 423 01 00 , 44 06 018 43R	
	1,5 dCi 90		10.2012	07.2014	03.0137-0522.2	650522	JEU DE MACHOIRE	453 423 01 00 , 44 06 018 43R	
TWINGO III (14-)	0,9 TCe 110		11.2016		03.0137-0531.2	650531	JEU DE MACHOIRE	453 423 02 00 , 44 06 090 81R	
	0,9 TCe 90		09.2014		03.0137-0531.2	650531	JEU DE MACHOIRE	453 423 02 00 , 44 06 090 81R	
	1,0 SCe 70		09.2015		03.0137-0531.2	650531	JEU DE MACHOIRE	453 423 02 00 , 44 06 090 81R	
			09.2014		03.0137-0531.2	650531	JEU DE MACHOIRE	453 423 02 00 , 44 06 090 81R	



description

Références OE
par référence
ATE.

i
Références remplacées /
divers

SEAT

Modèle	Motorisation	Date	Code	Code	Description	Références OE	Références remplacées / divers
ATECA (16-)	1,0 TSI	06.2016	24.4123-1719.3	011017	TANDEM MASTER CYLINDE	8V1 611 021 A	
	1,4 TSI	06.2016	24.4123-1719.3	011017	TANDEM MASTER CYLINDE	8V1 611 021 A	
	1,4 TSI 4Drive	06.2016	24.4123-1719.3	011017	TANDEM MASTER CYLINDE	8V1 611 021 A	
	1,6 TDI	06.2016	24.4123-1719.3	011017	TANDEM MASTER CYLINDE	8V1 611 021 A	
	2,0 TDI	06.2016	24.4123-1719.3	011017	TANDEM MASTER CYLINDE	8V1 611 021 A	
		10.2016	24.4123-1719.3	011017	TANDEM MASTER CYLINDE	8V1 611 021 A	
	2,0 TDI 4Drive	06.2016	24.4123-1719.3	011017	TANDEM MASTER CYLINDE	8V1 611 021 A	
LEON III (5F) / SC / ST (12-)	1,0 TSI	05.2015	24.4123-1719.3	011017	TANDEM MASTER CYLINDE	8V1 611 021 A	
	1,2 TSI	04.2014	24.4123-1719.3	011017	TANDEM MASTER CYLINDE	8V1 611 021 A	
		09.2012	24.4123-1719.3	011017	TANDEM MASTER CYLINDE	8V1 611 021 A	
	1,4 TGI	10.2013	24.4123-1719.3	011017	TANDEM MASTER CYLINDE	8V1 611 021 A	
	1,4 TSI	05.2014	24.4123-1719.3	011017	TANDEM MASTER CYLINDE	8V1 611 021 A	
		09.2012	24.4123-1719.3	011017	TANDEM MASTER CYLINDE	8V1 611 021 A	
	1,6 TDI	09.2012	24.4123-1719.3	011017	TANDEM MASTER CYLINDE	8V1 611 021 A	
		09.2013	24.4123-1719.3	011017	TANDEM MASTER CYLINDE	8V1 611 021 A	
		01.2017	24.4123-1719.3	011017	TANDEM MASTER CYLINDE	8V1 611 021 A	
	1,6 TDI 4Drive	11.2014	24.4123-1719.3	011017	TANDEM MASTER CYLINDE	8V1 611 021 A	
		04.2014	24.4123-1719.3	011017	TANDEM MASTER CYLINDE	8V1 611 021 A	
	1,8 TSI	09.2012	24.4123-1719.3	011017	TANDEM MASTER CYLINDE	8V1 611 021 A	
	1,8 TSI 4Drive	11.2014	24.4123-1719.3	011017	TANDEM MASTER CYLINDE	8V1 611 021 A	
	2,0 Cupra	10.2013	24.4123-1719.3	011017	TANDEM MASTER CYLINDE	8V1 611 021 A	



				description	Références OE par référence ATE.	 Références remplacées / divers
---	---	--	---	--------------------	---	---

SEAT

LEON III (5F) / SC / ST (12-)	2,0 TDI		05.2013		24.4123-1719.3	011017	TANDEM MASTER CYLINDE	8V1 611 021 A	
			09.2012		24.4123-1719.3	011017	TANDEM MASTER CYLINDE	8V1 611 021 A	
	2,0 TDI 4Drive		04.2014		24.4123-1719.3	011017	TANDEM MASTER CYLINDE	8V1 611 021 A	
			11.2014		24.4123-1719.3	011017	TANDEM MASTER CYLINDE	8V1 611 021 A	
LEON III (5F) ST X-Perience (14-)	1,6 TDI		09.2014		24.4123-1719.3	011017	TANDEM MASTER CYLINDE	8V1 611 021 A	
	1,8 TSI		09.2014		24.4123-1719.3	011017	TANDEM MASTER CYLINDE	8V1 611 021 A	
	2,0 TDI		09.2014		24.4123-1719.3	011017	TANDEM MASTER CYLINDE	8V1 611 021 A	
Mii (12-)	1		05.2012		24.4120-1703.3	011015	TANDEM MASTER CYLINDE	1S1 611 019	
	1,0 EcoFuel		11.2012		24.4120-1703.3	011015	TANDEM MASTER CYLINDE	1S1 611 019	



description

Références OE
par référence
ATE.

i
Références remplacées /
divers

SKODA

Modèle	Version	Date	Code	ATE	Description	Références OE	Références remplacées / divers
CITIGO (12-)	1	05.2012	24.4120-1703.3	011015	TANDEM MASTER CYLINDE	1S1 611 019	
	1,0 CNG	11.2012	24.4120-1703.3	011015	TANDEM MASTER CYLINDE	1S1 611 019	
KODIAQ (17-)	1,4 TSI	03.2017	24.4123-1719.3	011017	TANDEM MASTER CYLINDE	8V1 611 021 A	
	1,4 TSI 4x4	03.2017	24.4123-1719.3	011017	TANDEM MASTER CYLINDE	8V1 611 021 A	
	2,0 TDI	03.2017	24.4123-1719.3	011017	TANDEM MASTER CYLINDE	8V1 611 021 A	
	2,0 TDI 4x4	03.2017	24.4123-1719.3	011017	TANDEM MASTER CYLINDE	8V1 611 021 A	
	2,0 TSI 4x4	03.2017	24.4123-1719.3	011017	TANDEM MASTER CYLINDE	8V1 611 021 A	
OCTAVIA III (5E) (12-)	1,0 TSI	05.2016	24.4123-1719.3	011017	TANDEM MASTER CYLINDE	8V1 611 021 A	
	1,2 TSI	05.2015	24.4123-1719.3	011017	TANDEM MASTER CYLINDE	8V1 611 021 A	
		02.2013	24.4123-1719.3	011017	TANDEM MASTER CYLINDE	8V1 611 021 A	
	1,4 TSI	05.2015	24.4123-1719.3	011017	TANDEM MASTER CYLINDE	8V1 611 021 A	
		11.2012	24.4123-1719.3	011017	TANDEM MASTER CYLINDE	8V1 611 021 A	
	1,4 TSI G-TEC	11.2013	24.4123-1719.3	011017	TANDEM MASTER CYLINDE	8V1 611 021 A	
	1,6	01.2014	24.4123-1719.3	011017	TANDEM MASTER CYLINDE	8V1 611 021 A	
	1,6 TDI	02.2013	24.4123-1719.3	011017	TANDEM MASTER CYLINDE	8V1 611 021 A	
	1,6 TDI 4x4	05.2015	24.4123-1719.3	011017	TANDEM MASTER CYLINDE	8V1 611 021 A	
		11.2012	24.4123-1719.3	011017	TANDEM MASTER CYLINDE	8V1 611 021 A	
	1,8 TSI	11.2012	24.4123-1719.3	011017	TANDEM MASTER CYLINDE	8V1 611 021 A	
	1,8 TSI 4x4	11.2012	24.4123-1719.3	011017	TANDEM MASTER CYLINDE	8V1 611 021 A	
	2,0 TDI	02.2013	24.4123-1719.3	011017	TANDEM MASTER CYLINDE	8V1 611 021 A	
		05.2013	24.4123-1719.3	011017	TANDEM MASTER CYLINDE	8V1 611 021 A	



description

Références OE
par référence
ATE.

i
Références remplacées /
divers

SKODA

OCTAVIA III (5E) (12-)	2,0 TDI		11.2012		24.4123-1719.3	011017	TANDEM MASTER CYLINDE	8V1 611 021 A	
	2,0 TDI 4x4		11.2012		24.4123-1719.3	011017	TANDEM MASTER CYLINDE	8V1 611 021 A	
			09.2014		24.4123-1719.3	011017	TANDEM MASTER CYLINDE	8V1 611 021 A	
	2,0 TSI RS		05.2013		24.4123-1719.3	011017	TANDEM MASTER CYLINDE	8V1 611 021 A	
			05.2015		24.4123-1719.3	011017	TANDEM MASTER CYLINDE	8V1 611 021 A	
SUPERB II (08-15)	1,8 TSI 4x4	ArG	10.2008	02.2015	24.3417-1711.5	240766	ETRIER A GRIFFE	8J0 615 423 A , 8J0 615 423 D , 1K0 615 423 K , 1K0 615 423 B	24.3417-1711.7
		ArD	10.2008	02.2015	24.3417-1712.5	240767	ETRIER A GRIFFE	8J0 615 424 A , 8J0 615 424 D , 1K0 615 424 K , 1K0 615 424 B	24.3417-1712.7
	2,0 TDI 4x4	ArG	10.2008	02.2015	24.3417-1711.5	240766	ETRIER A GRIFFE	8J0 615 423 A , 8J0 615 423 D , 1K0 615 423 K , 1K0 615 423 B	24.3417-1711.7
		ArD	10.2008	02.2015	24.3417-1712.5	240767	ETRIER A GRIFFE	8J0 615 424 A , 8J0 615 424 D , 1K0 615 424 K , 1K0 615 424 B	24.3417-1712.7
	3,6 FSI V6 4x4	ArG	11.2008	02.2015	24.3417-1711.5	240766	ETRIER A GRIFFE	8J0 615 423 A , 8J0 615 423 D , 1K0 615 423 K , 1K0 615 423 B	24.3417-1711.7
		ArD	11.2008	02.2015	24.3417-1712.5	240767	ETRIER A GRIFFE	8J0 615 424 A , 8J0 615 424 D , 1K0 615 424 K , 1K0 615 424 B	24.3417-1712.7
SUPERB II Combi (09-15)	1,8 TSI 4x4	ArD	11.2009	02.2015	24.3417-1712.5	240767	ETRIER A GRIFFE	8J0 615 424 A , 8J0 615 424 D , 1K0 615 424 K , 1K0 615 424 B	24.3417-1712.7
		ArG	11.2009	02.2015	24.3417-1711.5	240766	ETRIER A GRIFFE	8J0 615 423 A , 8J0 615 423 D , 1K0 615 423 K , 1K0 615 423 B	24.3417-1711.7



description

Références OE
par référence
ATE.

i
Références remplacées /
divers

SKODA

Modèle	Version	Ar	11.2009	02.2015	24.3417-1711.5	240766	description	Références OE par référence ATE.	Références remplacées / divers
SUPERB II Combi (09-15)	2,0 TDI 4x4	ArG	11.2009	02.2015	24.3417-1711.5	240766	ETRIER A GRIFFE	8J0 615 423 A , 8J0 615 423 D , 1K0 615 423 K , 1K0 615 423 B	24.3417-1711.7
		ArD	11.2009	02.2015	24.3417-1712.5	240767	ETRIER A GRIFFE	8J0 615 424 A , 8J0 615 424 D , 1K0 615 424 K , 1K0 615 424 B	24.3417-1712.7
	3,6 V6 4x4	ArG	11.2009	02.2015	24.3417-1711.5	240766	ETRIER A GRIFFE	8J0 615 423 A , 8J0 615 423 D , 1K0 615 423 K , 1K0 615 423 B	24.3417-1711.7
		ArD	11.2009	02.2015	24.3417-1712.5	240767	ETRIER A GRIFFE	8J0 615 424 A , 8J0 615 424 D , 1K0 615 424 K , 1K0 615 424 B	24.3417-1712.7
SUPERB III (15-)	1,4 TSI		03.2015		24.4123-1719.3	011017	TANDEM MASTER CYLINDE	8V1 611 021 A	
	1,4 TSI 4x4		03.2015		24.4123-1719.3	011017	TANDEM MASTER CYLINDE	8V1 611 021 A	
	1,6 TDI		03.2015		24.4123-1719.3	011017	TANDEM MASTER CYLINDE	8V1 611 021 A	
	1,8 TSI		03.2015		24.4123-1719.3	011017	TANDEM MASTER CYLINDE	8V1 611 021 A	
	2,0 TDI		03.2015		24.4123-1719.3	011017	TANDEM MASTER CYLINDE	8V1 611 021 A	
	2,0 TDI 4x4		03.2015		24.4123-1719.3	011017	TANDEM MASTER CYLINDE	8V1 611 021 A	
	2,0 TSI		03.2015		24.4123-1719.3	011017	TANDEM MASTER CYLINDE	8V1 611 021 A	
	2,0 TSI 4x4		03.2015		24.4123-1719.3	011017	TANDEM MASTER CYLINDE	8V1 611 021 A	
SUPERB III Combi (15-)	1,4 TSI		03.2015		24.4123-1719.3	011017	TANDEM MASTER CYLINDE	8V1 611 021 A	
	1,4 TSI 4x4		03.2015		24.4123-1719.3	011017	TANDEM MASTER CYLINDE	8V1 611 021 A	
	1,6 TDI		03.2015		24.4123-1719.3	011017	TANDEM MASTER CYLINDE	8V1 611 021 A	
	1,8 TSI		03.2015		24.4123-1719.3	011017	TANDEM MASTER CYLINDE	8V1 611 021 A	
	2,0 TDI		03.2015		24.4123-1719.3	011017	TANDEM MASTER CYLINDE	8V1 611 021 A	



description

Références OE
par référence
ATE.

i
Références remplacées /
divers

SKODA

SUPERB III Combi (15-)	2,0 TDI 4x4		03.2015		24.4123-1719.3	011017	TANDEM MASTER CYLINDE	8V1 611 021 A	
	2,0 TSI		03.2015		24.4123-1719.3	011017	TANDEM MASTER CYLINDE	8V1 611 021 A	
	2,0 TSI 4x4		03.2015		24.4123-1719.3	011017	TANDEM MASTER CYLINDE	8V1 611 021 A	

SMART

FORFOUR (BM453) (14-)	0,9		11.2014		03.0137-0531.2	650531	JEU DE MACHOIRE	453 423 02 00 , 44 06 090 81R	
	0,9 Brabus		07.2016		03.0137-0531.2	650531	JEU DE MACHOIRE	453 423 02 00 , 44 06 090 81R	
	1		01.2015		03.0137-0531.2	650531	JEU DE MACHOIRE	453 423 02 00 , 44 06 090 81R	
			11.2014		03.0137-0531.2	650531	JEU DE MACHOIRE	453 423 02 00 , 44 06 090 81R	
FORTWO (BM453) (14-)	0,9		11.2014		03.0137-0522.2	650522	JEU DE MACHOIRE	453 423 01 00 , 44 06 018 43R	
	0,9 Brabus		07.2016		03.0137-0522.2	650522	JEU DE MACHOIRE	453 423 01 00 , 44 06 018 43R	
	1		01.2015		03.0137-0522.2	650522	JEU DE MACHOIRE	453 423 01 00 , 44 06 018 43R	
			11.2014		03.0137-0522.2	650522	JEU DE MACHOIRE	453 423 01 00 , 44 06 018 43R	
FORTWO CABRIO (BM453) (15-)	0,9		09.2015		03.0137-0522.2	650522	JEU DE MACHOIRE	453 423 01 00 , 44 06 018 43R	
	0,9 Brabus		07.2016		03.0137-0522.2	650522	JEU DE MACHOIRE	453 423 01 00 , 44 06 018 43R	
	1		09.2015		03.0137-0522.2	650522	JEU DE MACHOIRE	453 423 01 00 , 44 06 018 43R	



description

Références OE
par référence
ATE.

i
Références remplacées /
divers

SUBARU

Modèle	Motorisation	Année de début	Année de fin	Code OE	Code ATE	Description	Référence ATE	
LEGACY (03-09)	2,0 i 16V	09.2003	10.2005	03.0137-3043.2	653043	JEU DE MACHOIRE	26694AG000	
	2,0 R	09.2007	04.2009	03.0137-3043.2	653043	JEU DE MACHOIRE	26694AG000	
	2,0 R AWD	06.2005	04.2009	03.0137-3043.2	653043	JEU DE MACHOIRE	26694AG000	
	2,0 TD	02.2008	04.2009	03.0137-3043.2	653043	JEU DE MACHOIRE	26694AG000	
	2,0 Turbo HP AWD	06.2005	04.2009	03.0137-3043.2	653043	JEU DE MACHOIRE	26694AG000	
	2,5 i 16V	09.2003	04.2009	03.0137-3043.2	653043	JEU DE MACHOIRE	26694AG000	
			09.2007	04.2009	03.0137-3043.2	653043	JEU DE MACHOIRE	26694AG000
	3,0 V6	09.2003	06.2009	03.0137-3043.2	653043	JEU DE MACHOIRE	26694AG000	
OUTBACK (03-09)	2,0 16V 4x4	09.2003	10.2005	03.0137-3043.2	653043	JEU DE MACHOIRE	26694AG000	
	2,0 TD 4x4	09.2008	04.2009	03.0137-3043.2	653043	JEU DE MACHOIRE	26694AG000	
	2,5 16V 4x4	09.2008	06.2009	03.0137-3043.2	653043	JEU DE MACHOIRE	26694AG000	
			11.2003	04.2009	03.0137-3043.2	653043	JEU DE MACHOIRE	26694AG000
		3,0 V6 4x4	11.2003	06.2009	03.0137-3043.2	653043	JEU DE MACHOIRE	26694AG000

SUZUKI

Modèle	Motorisation	Année de début	Année de fin	Code OE	Code ATE	Description	Référence ATE
SWIFT III (05-10)	1,3 16V	02.2005	09.2010	03.0137-0529.2	650529	JEU DE MACHOIRE	53200-63J02
	1,3 DDiS	08.2005	09.2007	03.0137-0529.2	650529	JEU DE MACHOIRE	53200-63J02
		08.2005	09.2010	03.0137-0529.2	650529	JEU DE MACHOIRE	53200-63J02
	1,5 VVTi	02.2005	09.2010	03.0137-0529.2	650529	JEU DE MACHOIRE	53200-63J02



		 		description	Références OE par référence ATE.	 Références remplacées / divers
---	---	--	---	--------------------	---	---

TOYOTA

Modèle	Moteur		Date		Code	Code	Description	Références OE	
PRIUS PLUS (12-)	1,8 Hybrid (ZVW40)		03.2012		24.0112-0203.1	412203	DISQUE DE FREIN	42431-47050	
VERSO S (10-)	1,33		11.2010		03.0137-0528.2	650528	JEU DE MACHOIRE	04495-52130	
	1,4 D4-D		11.2010		03.0137-0528.2	650528	JEU DE MACHOIRE	04495-52130	
YARIS (11-)	1,3 VVTi		01.2011		03.0137-0528.2	650528	JEU DE MACHOIRE	04495-52130	
			09.2011		03.0137-0528.2	650528	JEU DE MACHOIRE	04495-52130	
	1,3 VVTi 4WD		09.2011		03.0137-0528.2	650528	JEU DE MACHOIRE	04495-52130	



description

Références OE
par référence
ATE.

i
Références remplacées /
divers

VOLKSWAGEN

EOS (06-)	1,4 TSI	ArG	10.2007		24.3417-1711.5	240766	ETRIER A GRIFFE	8J0 615 423 A , 8J0 615 423 D , 1K0 615 423 K , 1K0 615 423 B	24.3417-1711.7
		ArD	10.2007		24.3417-1712.5	240767	ETRIER A GRIFFE	8J0 615 424 A , 8J0 615 424 D , 1K0 615 424 K , 1K0 615 424 B	24.3417-1712.7
		ArD	05.2008		24.3417-1712.5	240767	ETRIER A GRIFFE	8J0 615 424 A , 8J0 615 424 D , 1K0 615 424 K , 1K0 615 424 B	24.3417-1712.7
		ArG	05.2008		24.3417-1711.5	240766	ETRIER A GRIFFE	8J0 615 423 A , 8J0 615 423 D , 1K0 615 423 K , 1K0 615 423 B	24.3417-1711.7
	1,6 FSI	ArD	05.2006		24.3417-1712.5	240767	ETRIER A GRIFFE	8J0 615 424 A , 8J0 615 424 D , 1K0 615 424 K , 1K0 615 424 B	24.3417-1712.7
		ArG	05.2006		24.3417-1711.5	240766	ETRIER A GRIFFE	8J0 615 423 A , 8J0 615 423 D , 1K0 615 423 K , 1K0 615 423 B	24.3417-1711.7
	2,0 FSI	ArD	05.2006		24.3417-1712.5	240767	ETRIER A GRIFFE	8J0 615 424 A , 8J0 615 424 D , 1K0 615 424 K , 1K0 615 424 B	24.3417-1712.7
		ArG	05.2006		24.3417-1711.5	240766	ETRIER A GRIFFE	8J0 615 423 A , 8J0 615 423 D , 1K0 615 423 K , 1K0 615 423 B	24.3417-1711.7
	2,0 TDI	ArG	05.2006		24.3417-1711.5	240766	ETRIER A GRIFFE	8J0 615 423 A , 8J0 615 423 D , 1K0 615 423 K , 1K0 615 423 B	24.3417-1711.7
		ArD	05.2006		24.3417-1712.5	240767	ETRIER A GRIFFE	8J0 615 424 A , 8J0 615 424 D , 1K0 615 424 K , 1K0 615 424 B	24.3417-1712.7
		ArD	11.2010		24.3417-1712.5	240767	ETRIER A GRIFFE	8J0 615 424 A , 8J0 615 424 D , 1K0 615 424 K , 1K0 615 424 B	24.3417-1712.7



description

Références OE
par référence
ATE.

i
Références remplacées /
divers

VOLKSWAGEN

EOS (06-)	2,0 TDI	ArG	11.2010		24.3417-1711.5	240766	ETRIER A GRIFFE	8J0 615 423 A , 8J0 615 423 D , 1K0 615 423 K , 1K0 615 423 B	24.3417-1711.7
	2,0 TDI 16V	ArG	05.2008		24.3417-1711.5	240766	ETRIER A GRIFFE	8J0 615 423 A , 8J0 615 423 D , 1K0 615 423 K , 1K0 615 423 B	24.3417-1711.7
		ArD	05.2008		24.3417-1712.5	240767	ETRIER A GRIFFE	8J0 615 424 A , 8J0 615 424 D , 1K0 615 424 K , 1K0 615 424 B	24.3417-1712.7
	2,0 TFSI	ArG	05.2006		24.3417-1711.5	240766	ETRIER A GRIFFE	8J0 615 423 A , 8J0 615 423 D , 1K0 615 423 K , 1K0 615 423 B	24.3417-1711.7
		ArD	05.2006		24.3417-1712.5	240767	ETRIER A GRIFFE	8J0 615 424 A , 8J0 615 424 D , 1K0 615 424 K , 1K0 615 424 B	24.3417-1712.7
	2,0 TSI	ArG	11.2009		24.3417-1711.5	240766	ETRIER A GRIFFE	8J0 615 423 A , 8J0 615 423 D , 1K0 615 423 K , 1K0 615 423 B	24.3417-1711.7
		ArD	11.2009		24.3417-1712.5	240767	ETRIER A GRIFFE	8J0 615 424 A , 8J0 615 424 D , 1K0 615 424 K , 1K0 615 424 B	24.3417-1712.7
	3,2 V6	ArG	05.2006		24.3417-1711.5	240766	ETRIER A GRIFFE	8J0 615 423 A , 8J0 615 423 D , 1K0 615 423 K , 1K0 615 423 B	24.3417-1711.7
		ArD	05.2006		24.3417-1712.5	240767	ETRIER A GRIFFE	8J0 615 424 A , 8J0 615 424 D , 1K0 615 424 K , 1K0 615 424 B	24.3417-1712.7
	3,6 V6	ArG	05.2009		24.3417-1711.5	240766	ETRIER A GRIFFE	8J0 615 423 A , 8J0 615 423 D , 1K0 615 423 K , 1K0 615 423 B	24.3417-1711.7
		ArD	05.2009		24.3417-1712.5	240767	ETRIER A GRIFFE	8J0 615 424 A , 8J0 615 424 D , 1K0 615 424 K , 1K0 615 424 B	24.3417-1712.7



description

Références OE
par référence
ATE.

i
Références remplacées /
divers

VOLKSWAGEN

GOLF VII (12-)	1,0 TSI		11.2016		24.4123-1719.3	011017	TANDEM MASTER CYLINDE	8V1 611 021 A	
			05.2015		24.4123-1719.3	011017	TANDEM MASTER CYLINDE	8V1 611 021 A	
	1,2 TSI		11.2012		24.4123-1719.3	011017	TANDEM MASTER CYLINDE	8V1 611 021 A	
			04.2014		24.4123-1719.3	011017	TANDEM MASTER CYLINDE	8V1 611 021 A	
	1,4 TGI		08.2013		24.4123-1719.3	011017	TANDEM MASTER CYLINDE	8V1 611 021 A	
	1,4 TSI		05.2014		24.4123-1719.3	011017	TANDEM MASTER CYLINDE	8V1 611 021 A	
			11.2012		24.4123-1719.3	011017	TANDEM MASTER CYLINDE	8V1 611 021 A	
	1,4 TSI Multifuel		04.2013		24.4123-1719.3	011017	TANDEM MASTER CYLINDE	8V1 611 021 A	
			12.2013		24.4123-1719.3	011017	TANDEM MASTER CYLINDE	8V1 611 021 A	
	1,6		05.2014		24.4123-1719.3	011017	TANDEM MASTER CYLINDE	8V1 611 021 A	
	1,6 TDI		11.2016		24.4123-1719.3	011017	TANDEM MASTER CYLINDE	8V1 611 021 A	
			11.2012		24.4123-1719.3	011017	TANDEM MASTER CYLINDE	8V1 611 021 A	
			06.2013		24.4123-1719.3	011017	TANDEM MASTER CYLINDE	8V1 611 021 A	
			04.2013		24.4123-1719.3	011017	TANDEM MASTER CYLINDE	8V1 611 021 A	
	1,6 TDI 4motion		01.2013		24.4123-1719.3	011017	TANDEM MASTER CYLINDE	8V1 611 021 A	
			11.2012		24.4123-1719.3	011017	TANDEM MASTER CYLINDE	8V1 611 021 A	
	2,0 GTD		03.2013		24.4123-1719.3	011017	TANDEM MASTER CYLINDE	8V1 611 021 A	
	2,0 GTI		03.2013		24.4123-1719.3	011017	TANDEM MASTER CYLINDE	8V1 611 021 A	
			02.2016		24.4123-1719.3	011017	TANDEM MASTER CYLINDE	8V1 611 021 A	
	2,0 GTI Clubsport S		05.2016		24.4123-1719.3	011017	TANDEM MASTER CYLINDE	8V1 611 021 A	
	2,0 GTI Performance		03.2013		24.4123-1719.3	011017	TANDEM MASTER CYLINDE	8V1 611 021 A	



description

Références OE
par référence
ATE.

i
Références remplacées /
divers

VOLKSWAGEN

GOLF VII (12-)	2,0 R 4motion		09.2013		24.4123-1719.3	011017	TANDEM MASTER CYLINDE	8V1 611 021 A	
	2,0 TDI		11.2012		24.4123-1719.3	011017	TANDEM MASTER CYLINDE	8V1 611 021 A	
			08.2012		24.4123-1719.3	011017	TANDEM MASTER CYLINDE	8V1 611 021 A	
	2,0 TDI 4motion		11.2012		24.4123-1719.3	011017	TANDEM MASTER CYLINDE	8V1 611 021 A	
GOLF VII ALLTRACK (14-)	1,6 TDI 4motion		12.2014		24.4123-1719.3	011017	TANDEM MASTER CYLINDE	8V1 611 021 A	
	1,8 TSI 4motion		12.2014		24.4123-1719.3	011017	TANDEM MASTER CYLINDE	8V1 611 021 A	
	2,0 TDI 4motion		12.2014		24.4123-1719.3	011017	TANDEM MASTER CYLINDE	8V1 611 021 A	
GOLF VII Sportsvan (14-)	1,0 TSI		05.2015		24.4123-1719.3	011017	TANDEM MASTER CYLINDE	8V1 611 021 A	
	1,2 TSI		03.2014		24.4123-1719.3	011017	TANDEM MASTER CYLINDE	8V1 611 021 A	
	1,4 TSI		05.2014		24.4123-1719.3	011017	TANDEM MASTER CYLINDE	8V1 611 021 A	
			03.2014		24.4123-1719.3	011017	TANDEM MASTER CYLINDE	8V1 611 021 A	
	1,4 TSI MultiFuel		04.2014		24.4123-1719.3	011017	TANDEM MASTER CYLINDE	8V1 611 021 A	
	1,6		05.2014		24.4123-1719.3	011017	TANDEM MASTER CYLINDE	8V1 611 021 A	
	1,6 TDI		02.2014		24.4123-1719.3	011017	TANDEM MASTER CYLINDE	8V1 611 021 A	
			05.2014		24.4123-1719.3	011017	TANDEM MASTER CYLINDE	8V1 611 021 A	
			11.2016		24.4123-1719.3	011017	TANDEM MASTER CYLINDE	8V1 611 021 A	
	2,0 TDI		05.2014		24.4123-1719.3	011017	TANDEM MASTER CYLINDE	8V1 611 021 A	
GOLF VII Variant (13-)	1,0 TSI		05.2015		24.4123-1719.3	011017	TANDEM MASTER CYLINDE	8V1 611 021 A	
			11.2016		24.4123-1719.3	011017	TANDEM MASTER CYLINDE	8V1 611 021 A	
	1,2 TSI		07.2013		24.4123-1719.3	011017	TANDEM MASTER CYLINDE	8V1 611 021 A	
			04.2014		24.4123-1719.3	011017	TANDEM MASTER CYLINDE	8V1 611 021 A	



description

Références OE
par référence
ATE.

i
Références remplacées /
divers

VOLKSWAGEN

Modèle	Version	Date	Date	Code	Code	Description	Références OE
GOLF VII Variant (13-)	1,4 TSI	07.2013		24.4123-1719.3	011017	TANDEM MASTER CYLINDE	8V1 611 021 A
		05.2014		24.4123-1719.3	011017	TANDEM MASTER CYLINDE	8V1 611 021 A
	1,4 TSI CNG	09.2013		24.4123-1719.3	011017	TANDEM MASTER CYLINDE	8V1 611 021 A
	1,4 TSI MultiFuel	04.2013		24.4123-1719.3	011017	TANDEM MASTER CYLINDE	8V1 611 021 A
		05.2014		24.4123-1719.3	011017	TANDEM MASTER CYLINDE	8V1 611 021 A
	1,6	05.2014		24.4123-1719.3	011017	TANDEM MASTER CYLINDE	8V1 611 021 A
	1,6 TDI	11.2016		24.4123-1719.3	011017	TANDEM MASTER CYLINDE	8V1 611 021 A
		07.2013		24.4123-1719.3	011017	TANDEM MASTER CYLINDE	8V1 611 021 A
	1,6 TDI 4motion	07.2013		24.4123-1719.3	011017	TANDEM MASTER CYLINDE	8V1 611 021 A
	2,0 GTD	01.2015		24.4123-1719.3	011017	TANDEM MASTER CYLINDE	8V1 611 021 A
PASSAT / PASSAT VARIANT (14-)	2,0 R 4motion	03.2015		24.4123-1719.3	011017	TANDEM MASTER CYLINDE	8V1 611 021 A
	2,0 TDI	07.2013		24.4123-1719.3	011017	TANDEM MASTER CYLINDE	8V1 611 021 A
	2,0 TDI 4motion	07.2013		24.4123-1719.3	011017	TANDEM MASTER CYLINDE	8V1 611 021 A
	1,4 TDI	11.2014		24.4123-1719.3	011017	TANDEM MASTER CYLINDE	8V1 611 021 A
LT/LT 4x4 (96-06)	LT 28	05.1996	07.2006	11.8170-0510.1	260111	CALIPER MOUNT. BRACKET	2D0 615 125 , A 000 421 45 06 , A 000 421 04 06 , 000 421 45 06 , 000 421 04 06
	LT 35	05.1996	07.2006	11.8170-0510.1	260111	CALIPER MOUNT. BRACKET	2D0 615 125 , A 000 421 45 06 , A 000 421 04 06 , 000 421 45 06 , 000 421 04 06
PASSAT / PASSAT VARIANT (14-)	1,4 TSI	11.2014		24.4123-1719.3	011017	TANDEM MASTER CYLINDE	8V1 611 021 A
	1,4 TSI 4motion	02.2015		24.4123-1719.3	011017	TANDEM MASTER CYLINDE	8V1 611 021 A
	1,6 TDI	11.2014		24.4123-1719.3	011017	TANDEM MASTER CYLINDE	8V1 611 021 A



description

Références OE
par référence
ATE.

i
Références remplacées /
divers

VOLKSWAGEN

PASSAT / PASSAT VARIANT (14-)	1,8 TSI		11.2014		24.4123-1719.3	011017	TANDEM MASTER CYLINDE	8V1 611 021 A	
	2,0 TDI		11.2014		24.4123-1719.3	011017	TANDEM MASTER CYLINDE	8V1 611 021 A	
			07.2015		24.4123-1719.3	011017	TANDEM MASTER CYLINDE	8V1 611 021 A	
	2,0 TDI 4motion		02.2015		24.4123-1719.3	011017	TANDEM MASTER CYLINDE	8V1 611 021 A	
			11.2014		24.4123-1719.3	011017	TANDEM MASTER CYLINDE	8V1 611 021 A	
	2,0 TSI		05.2015		24.4123-1719.3	011017	TANDEM MASTER CYLINDE	8V1 611 021 A	
			11.2014		24.4123-1719.3	011017	TANDEM MASTER CYLINDE	8V1 611 021 A	
	2,0 TSI 4motion		05.2015		24.4123-1719.3	011017	TANDEM MASTER CYLINDE	8V1 611 021 A	
PASSAT ALLTRACK (15-)	1,4 TSI 4motion		05.2015		24.4123-1719.3	011017	TANDEM MASTER CYLINDE	8V1 611 021 A	
	2,0 TDI 4motion		05.2015		24.4123-1719.3	011017	TANDEM MASTER CYLINDE	8V1 611 021 A	
			07.2015		24.4123-1719.3	011017	TANDEM MASTER CYLINDE	8V1 611 021 A	
	2,0 TSI 4motion		07.2015		24.4123-1719.3	011017	TANDEM MASTER CYLINDE	8V1 611 021 A	
TIGUAN (16-)	1,4 TSI		01.2016		24.4123-1719.3	011017	TANDEM MASTER CYLINDE	8V1 611 021 A	
			05.2016		24.4123-1719.3	011017	TANDEM MASTER CYLINDE	8V1 611 021 A	
	1,4 TSI 4motion		05.2016		24.4123-1719.3	011017	TANDEM MASTER CYLINDE	8V1 611 021 A	
	1,6 TDI		05.2016		24.4123-1719.3	011017	TANDEM MASTER CYLINDE	8V1 611 021 A	
	2,0 TDI		08.2016		24.4123-1719.3	011017	TANDEM MASTER CYLINDE	8V1 611 021 A	
			02.2016		24.4123-1719.3	011017	TANDEM MASTER CYLINDE	8V1 611 021 A	
			05.2016		24.4123-1719.3	011017	TANDEM MASTER CYLINDE	8V1 611 021 A	
	2,0 TDI 4motion		08.2016		24.4123-1719.3	011017	TANDEM MASTER CYLINDE	8V1 611 021 A	
			06.2016		24.4123-1719.3	011017	TANDEM MASTER CYLINDE	8V1 611 021 A	



					description	Références OE par référence ATE.		Références remplacées / divers
--	--	--	--	--	-------------	----------------------------------	--	--------------------------------

VOLKSWAGEN

TIGUAN (16-)	2,0 TDI 4motion		02.2016		24.4123-1719.3	011017	TANDEM MASTER CYLINDE	8V1 611 021 A	
			04.2016		24.4123-1719.3	011017	TANDEM MASTER CYLINDE	8V1 611 021 A	
			05.2016		24.4123-1719.3	011017	TANDEM MASTER CYLINDE	8V1 611 021 A	
	2,0 TSI 4motion		02.2016		24.4123-1719.3	011017	TANDEM MASTER CYLINDE	8V1 611 021 A	
			06.2016		24.4123-1719.3	011017	TANDEM MASTER CYLINDE	8V1 611 021 A	
TOURAN II (15-)	1,2 TSI		09.2015		24.4123-1719.3	011017	TANDEM MASTER CYLINDE	8V1 611 021 A	
	1,4 TSI		09.2015		24.4123-1719.3	011017	TANDEM MASTER CYLINDE	8V1 611 021 A	
	1,6 TDI		05.2016		24.4123-1719.3	011017	TANDEM MASTER CYLINDE	8V1 611 021 A	
			09.2015		24.4123-1719.3	011017	TANDEM MASTER CYLINDE	8V1 611 021 A	
	1,8 TSI		11.2015		24.4123-1719.3	011017	TANDEM MASTER CYLINDE	8V1 611 021 A	
	2,0 TDI		11.2015		24.4123-1719.3	011017	TANDEM MASTER CYLINDE	8V1 611 021 A	
			09.2015		24.4123-1719.3	011017	TANDEM MASTER CYLINDE	8V1 611 021 A	
UP / LOAD UP (11-)	1		05.2016		24.4120-1703.3	011015	TANDEM MASTER CYLINDE	1S1 611 019	
			12.2011		24.4120-1703.3	011015	TANDEM MASTER CYLINDE	1S1 611 019	
	1,0 EcoFuel		11.2012		24.4120-1703.3	011015	TANDEM MASTER CYLINDE	1S1 611 019	

13.0460-7304.2 607304

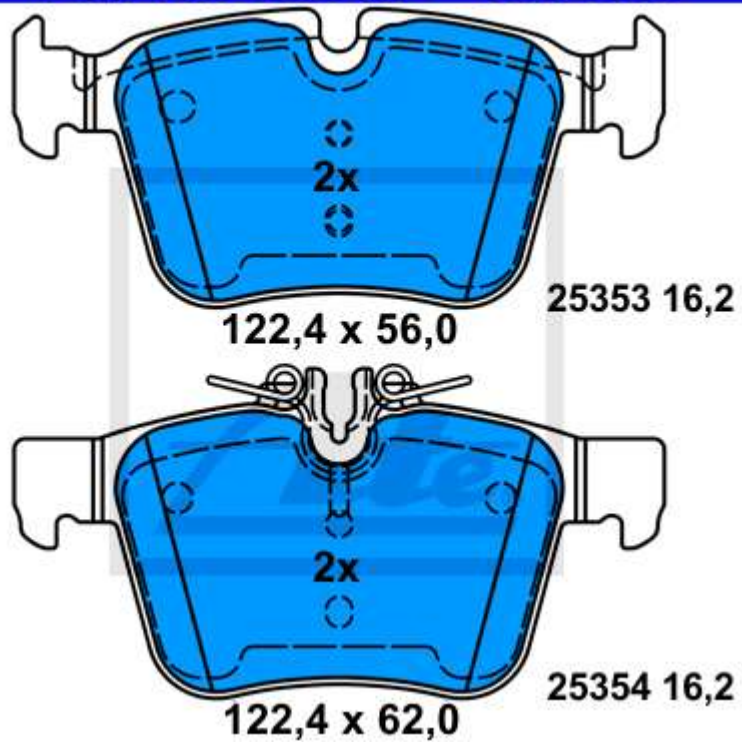

Applications:

- MERCEDES BENZ C-Klasse (A205) Cabrio (16-)
- MERCEDES BENZ C-Klasse (C205) Coupe (15-)
- MERCEDES BENZ C-Klasse (S205) Kombi (14-)
- MERCEDES BENZ C-Klasse (W205) Limousine (14-)

13.0460-2794.2 602794

Applications:
KIA CEE'D (12-)
KIA PRO CEE'D (13-)

