

New partnumbers on stock
according to applications



02/2008



www.ate.de

New partnumbers on stock - according to applications

02/2008



					Description	OE numbers per ATE pn.		e.g. replaced pn. / miscellaneous
--	--	--	--	--	-------------	------------------------	--	-----------------------------------

AUDI

80 (84-87)	1,3	RR	06.1984	03.1987	83.7804-0150.3	330853	BRAKE HOSE	811 611 775 A	83.6204-0150.3
	1,6	RR	06.1984	03.1987	83.7804-0150.3	330853	BRAKE HOSE	811 611 775 A	83.6204-0150.3
	1,6 D	RR	06.1984	03.1987	83.7804-0150.3	330853	BRAKE HOSE	811 611 775 A	83.6204-0150.3
	1,6 TD	RR	06.1984	03.1987	83.7804-0150.3	330853	BRAKE HOSE	811 611 775 A	83.6204-0150.3
	1,8	RR	06.1984	03.1987	83.7804-0150.3	330853	BRAKE HOSE	811 611 775 A	83.6204-0150.3
	2	RR	02.1986	03.1987	83.7804-0150.3	330853	BRAKE HOSE	811 611 775 A	83.6204-0150.3
80 (87-91)	1,6	RR	09.1986	07.1991	83.7804-0150.3	330853	BRAKE HOSE	811 611 775 A	83.6204-0150.3
	1,6 D	RR	02.1987	07.1989	83.7804-0150.3	330853	BRAKE HOSE	811 611 775 A	83.6204-0150.3
	1,6 TD	RR	04.1988	07.1991	83.7804-0150.3	330853	BRAKE HOSE	811 611 775 A	83.6204-0150.3
	1,8	RR	09.1986	07.1991	83.7804-0150.3	330853	BRAKE HOSE	811 611 775 A	83.6204-0150.3
	1,9 D	RR	08.1989	07.1991	83.7804-0150.3	330853	BRAKE HOSE	811 611 775 A	83.6204-0150.3
	1,9 E	RR	09.1986	07.1988	83.7804-0150.3	330853	BRAKE HOSE	811 611 775 A	83.6204-0150.3
	2	RR	08.1988	07.1991	83.7804-0150.3	330853	BRAKE HOSE	811 611 775 A	83.6204-0150.3
90 (85-87)	1,6 TD	RR	10.1984	03.1987	83.7804-0150.3	330853	BRAKE HOSE	811 611 775 A	83.6204-0150.3
	2	RR	10.1984	03.1987	83.7804-0150.3	330853	BRAKE HOSE	811 611 775 A	83.6204-0150.3
	2,2	RR	01.1985	03.1987	83.7804-0150.3	330853	BRAKE HOSE	811 611 775 A	83.6204-0150.3
		RR	10.1984	03.1987	83.7804-0150.3	330853	BRAKE HOSE	811 611 775 A	83.6204-0150.3
90 (87-91)	1,6 TD	RR	04.1988	07.1991	83.7804-0150.3	330853	BRAKE HOSE	811 611 775 A	83.6204-0150.3
	1,8	RR	08.1989	07.1991	83.7804-0150.3	330853	BRAKE HOSE	811 611 775 A	83.6204-0150.3

New partnumbers on stock - according to applications

02/2008



					Description	OE numbers per ATE pn.		e.g. replaced pn. / miscellaneous
--	--	--	--	--	-------------	------------------------	--	-----------------------------------







AUDI

90 (87-91)	2	RR	04.1987	07.1991	83.7804-0150.3	330853	BRAKE HOSE	811 611 775 A	83.6204-0150.3
	2,2	RR	04.1987	07.1991	83.7804-0150.3	330853	BRAKE HOSE	811 611 775 A	83.6204-0150.3
	2,3	RR	04.1987	07.1991	83.7804-0150.3	330853	BRAKE HOSE	811 611 775 A	83.6204-0150.3
A2 (00-05)	1,2 TDI	RL		07.2005	24.3727-0185.2	580185	HANDBRAKE CABLE	8Z0 609 721 G , 8Z0 609 721 C	
	1,4	RL		07.2005	24.3727-0185.2	580185	HANDBRAKE CABLE	8Z0 609 721 G , 8Z0 609 721 C	
	1,4 TDI	RL		07.2005	24.3727-0185.2	580185	HANDBRAKE CABLE	8Z0 609 721 G , 8Z0 609 721 C	
A3 / A3 Sportback (03-)	1,4 TFSI		07.2007		03.7863-9502.4	300204	BOOSTER UNIT T52	1K1 614 106 N , 1K1 614 106 H , 1K1 614 106 D	
			07.2007		83.7849-0504.3	330874	BRAKE HOSE	1K0 611 701 N , 1K0 611 701 J	
	1,6		05.2003		03.7863-9502.4	300204	BOOSTER UNIT T52	1K1 614 106 N , 1K1 614 106 H , 1K1 614 106 D	
					83.7849-0504.3	330874	BRAKE HOSE	1K0 611 701 N , 1K0 611 701 J	
	1,6 FSI		08.2003		03.7863-9502.4	300204	BOOSTER UNIT T52	1K1 614 106 N , 1K1 614 106 H , 1K1 614 106 D	
					83.7849-0504.3	330874	BRAKE HOSE	1K0 611 701 N , 1K0 611 701 J	
	1,8 TFSI		01.2007		03.7863-9502.4	300204	BOOSTER UNIT T52	1K1 614 106 N , 1K1 614 106 H , 1K1 614 106 D	
					83.7849-0504.3	330874	BRAKE HOSE	1K0 611 701 N , 1K0 611 701 J	

New partnumbers on stock - according to applications

02/2008



					Description	OE numbers per ATE pn.	 e.g. replaced pn. / miscellaneous
---	---	---	---	---	-------------	------------------------	--







AUDI

A3 / A3 Sportback (03-)	1,9 TDI		06.2003		03.7863-9502.4	300204	BOOSTER UNIT T52	1K1 614 106 N , 1K1 614 106 H , 1K1 614 106 D	
					83.7849-0504.3	330874	BRAKE HOSE	1K0 611 701 N , 1K0 611 701 J	
	2,0 FSI		05.2003		03.7863-9502.4	300204	BOOSTER UNIT T52	1K1 614 106 N , 1K1 614 106 H , 1K1 614 106 D	
					83.7849-0504.3	330874	BRAKE HOSE	1K0 611 701 N , 1K0 611 701 J	
	2,0 TDI		03.2006		03.7863-9502.4	300204	BOOSTER UNIT T52	1K1 614 106 N , 1K1 614 106 H , 1K1 614 106 D	
			05.2003		03.7863-9502.4	300204	BOOSTER UNIT T52	1K1 614 106 N , 1K1 614 106 H , 1K1 614 106 D	
					83.7849-0504.3	330874	BRAKE HOSE	1K0 611 701 N , 1K0 611 701 J	
	2,0 TDI Quattro		08.2004		03.7863-9502.4	300204	BOOSTER UNIT T52	1K1 614 106 N , 1K1 614 106 H , 1K1 614 106 D	
			03.2006		03.7863-9502.4	300204	BOOSTER UNIT T52	1K1 614 106 N , 1K1 614 106 H , 1K1 614 106 D	
			05.2003		03.7863-9502.4	300204	BOOSTER UNIT T52	1K1 614 106 N , 1K1 614 106 H , 1K1 614 106 D	
					83.7849-0504.3	330874	BRAKE HOSE	1K0 611 701 N , 1K0 611 701 J	
	2,0 TFSI		06.2004		03.7863-9502.4	300204	BOOSTER UNIT T52	1K1 614 106 N , 1K1 614 106 H , 1K1 614 106 D	
					83.7849-0504.3	330874	BRAKE HOSE	1K0 611 701 N , 1K0 611 701 J	

New partnumbers on stock - according to applications

02/2008



					Description	OE numbers per ATE pn.	 e.g. replaced pn. / miscellaneous
---	---	---	---	---	-------------	------------------------	--

AUDI

A3 / A3 Sportback (03-)	2,0 TFSI Quattro		06.2004		03.7863-9502.4	300204	BOOSTER UNIT T52	1K1 614 106 N , 1K1 614 106 H , 1K1 614 106 D	
					83.7849-0504.3	330874	BRAKE HOSE	1K0 611 701 N , 1K0 611 701 J	
	3,2 Quattro				83.7849-0504.3	330874	BRAKE HOSE	1K0 611 701 N , 1K0 611 701 J	
	S3				83.7849-0504.3	330874	BRAKE HOSE	1K0 611 701 N , 1K0 611 701 J	
A4 (B6/B7) (01-)	S4 4,2		03.2003		24.0122-0220.1	422220	BRAKE DISC	8E0 615 601 K , 8E0 615 601 R	
A4 CONVERTIBLE (02-)	S4 4,2 Quattro		02.2004		24.0122-0220.1	422220	BRAKE DISC	8E0 615 601 K , 8E0 615 601 R	
A6 (C6) Avant (05-)	2,0 TDI		03.2005		24.0122-0223.1	422223	BRAKE DISC	4F0 615 601 F	
			06.2005		24.0122-0223.1	422223	BRAKE DISC	4F0 615 601 F	
	2,0 TFSI		06.2005		24.0122-0223.1	422223	BRAKE DISC	4F0 615 601 F	
	2,4		03.2005		24.0122-0223.1	422223	BRAKE DISC	4F0 615 601 F	
	2,4 Quattro		03.2005		24.0122-0223.1	422223	BRAKE DISC	4F0 615 601 F	
	2,7 TDI		03.2005		24.0122-0223.1	422223	BRAKE DISC	4F0 615 601 F	
	2,7 TDI Quattro		06.2005		24.0122-0223.1	422223	BRAKE DISC	4F0 615 601 F	
			03.2005		24.0122-0223.1	422223	BRAKE DISC	4F0 615 601 F	
	2,8 FSI		11.2006		24.0122-0223.1	422223	BRAKE DISC	4F0 615 601 F	
	2,8 FSI Quattro		04.2007		24.0122-0223.1	422223	BRAKE DISC	4F0 615 601 F	
	3		03.2005		24.0122-0223.1	422223	BRAKE DISC	4F0 615 601 F	

New partnumbers on stock - according to applications

02/2008



					Description	OE numbers per ATE pn.		e.g. replaced pn. / miscellaneous
--	--	--	--	--	-------------	------------------------	--	-----------------------------------







AUDI

A6 (C6) Avant (05-)	3,0 Quattro		03.2005		24.0122-0223.1	422223	BRAKE DISC	4F0 615 601 F	
	3,0 TDI Quattro		03.2005		24.0122-0223.1	422223	BRAKE DISC	4F0 615 601 F	
			06.2006		24.0122-0223.1	422223	BRAKE DISC	4F0 615 601 F	
	3,2		03.2005		24.0122-0223.1	422223	BRAKE DISC	4F0 615 601 F	
	3,2 Quattro		03.2005		24.0122-0223.1	422223	BRAKE DISC	4F0 615 601 F	
	4,2 FSI Quattro		06.2006		24.0122-0223.1	422223	BRAKE DISC	4F0 615 601 F	
	4,2 Quattro		03.2005		24.0122-0223.1	422223	BRAKE DISC	4F0 615 601 F	
	S6		03.2006		24.0122-0223.1	422223	BRAKE DISC	4F0 615 601 F	
A6 (C6) Saloon (04-)	2,0 TDI		07.2004		24.0122-0223.1	422223	BRAKE DISC	4F0 615 601 F	
			06.2005		24.0122-0223.1	422223	BRAKE DISC	4F0 615 601 F	
	2,0 TFSI		06.2005		24.0122-0223.1	422223	BRAKE DISC	4F0 615 601 F	
	2,4		04.2004		24.0122-0223.1	422223	BRAKE DISC	4F0 615 601 F	
	2,4 Quattro		01.2005		24.0122-0223.1	422223	BRAKE DISC	4F0 615 601 F	
	2,7 TDI		11.2004		24.0122-0223.1	422223	BRAKE DISC	4F0 615 601 F	
	2,7 TDI Quattro		11.2004		24.0122-0223.1	422223	BRAKE DISC	4F0 615 601 F	
			06.2005		24.0122-0223.1	422223	BRAKE DISC	4F0 615 601 F	
	2,8 FSI		11.2006		24.0122-0223.1	422223	BRAKE DISC	4F0 615 601 F	
	2,8 FSI Quattro		04.2007		24.0122-0223.1	422223	BRAKE DISC	4F0 615 601 F	
	3		04.2004		24.0122-0223.1	422223	BRAKE DISC	4F0 615 601 F	

New partnumbers on stock - according to applications

02/2008



					Description	OE numbers per ATE pn.	 e.g. replaced pn. / miscellaneous
---	---	---	---	---	-------------	------------------------	--







AUDI

A6 (C6) Saloon (04-)	3,0 Quattro		04.2004		24.0122-0223.1	422223	BRAKE DISC	4F0 615 601 F	
	3,0 TDI Quattro		04.2004		24.0122-0223.1	422223	BRAKE DISC	4F0 615 601 F	
			06.2006		24.0122-0223.1	422223	BRAKE DISC	4F0 615 601 F	
	3,2 FSI		04.2004		24.0122-0223.1	422223	BRAKE DISC	4F0 615 601 F	
	3,2 FSI Quattro		04.2004		24.0122-0223.1	422223	BRAKE DISC	4F0 615 601 F	
	4,2 FSI Quattro		06.2006		24.0122-0223.1	422223	BRAKE DISC	4F0 615 601 F	
	4,2 Quattro		04.2004		24.0122-0223.1	422223	BRAKE DISC	4F0 615 601 F	
CONVERTIBLE (91-00)	1,8	RR	04.1997	08.2000	83.7804-0150.3	330853	BRAKE HOSE	811 611 775 A	83.6204-0150.3
	1,9 TDI	RR	07.1995	08.2000	83.7804-0150.3	330853	BRAKE HOSE	811 611 775 A	83.6204-0150.3
	2	RR	01.1993	07.1998	83.7804-0150.3	330853	BRAKE HOSE	811 611 775 A	83.6204-0150.3
		RR	05.1995	07.1996	83.7804-0150.3	330853	BRAKE HOSE	811 611 775 A	83.6204-0150.3
	2,3	RR	07.1991	06.1994	83.7804-0150.3	330853	BRAKE HOSE	811 611 775 A	83.6204-0150.3
	2,6	RR	01.1994	08.2000	83.7804-0150.3	330853	BRAKE HOSE	811 611 775 A	83.6204-0150.3
	2,8	RR	11.1992	08.2000	83.7804-0150.3	330853	BRAKE HOSE	811 611 775 A	83.6204-0150.3
COUPE (89-96)	1,8	RR	11.1988	07.1991	83.7804-0150.3	330853	BRAKE HOSE	811 611 775 A	83.6204-0150.3
	2	RR	11.1988	12.1996	83.7804-0150.3	330853	BRAKE HOSE	811 611 775 A	83.6204-0150.3
	2,2	RR	11.1988	07.1991	83.7804-0150.3	330853	BRAKE HOSE	811 611 775 A	83.6204-0150.3
	2,3	RR	11.1988	07.1994	83.7804-0150.3	330853	BRAKE HOSE	811 611 775 A	83.6204-0150.3
	2,6	RR	08.1992	12.1996	83.7804-0150.3	330853	BRAKE HOSE	811 611 775 A	83.6204-0150.3

New partnumbers on stock - according to applications

02/2008



					Description	OE numbers per ATE pn.	 e.g. replaced pn. / miscellaneous
---	---	---	---	---	--------------------	-------------------------------	--

AUDI

COUPE (89-96)	2,8	RR	09.1991	12.1996	83.7804-0150.3	330853	BRAKE HOSE	811 611 775 A	83.6204-0150.3
TT Coupe (98-06)	3,2 Quattro	FL	04.2003	06.2006	24.0132-0166.2	432166	BRAKE DISC LEFT	8N0 615 301 B , 1J0 615 301 AA	
		FR	04.2003	06.2006	24.0132-0165.2	432165	BRAKE DISC RIGHT	8N0 615 302 B , 1J0 615 302 A	
TT Roadster (99-06)		FL	04.2003	06.2006	24.0132-0166.2	432166	BRAKE DISC LEFT	8N0 615 301 B , 1J0 615 301 AA	
		FR	04.2003	06.2006	24.0132-0165.2	432165	BRAKE DISC RIGHT	8N0 615 302 B , 1J0 615 302 A	

New partnumbers on stock - according to applications

02/2008



					Description	OE numbers per ATE pn.	 e.g. replaced pn. / miscellaneous
--	--	--	--	--	-------------	------------------------	---------------------------------------

BMW

1er Reihe/E81/E87 Limousine (04-)	123 d		10.2007		13.0460-7223.2	607223	BRAKE PADS	34 11 6 771 972	see drawing
	130 i		09.2005		13.0460-7223.2	607223	BRAKE PADS	34 11 6 771 972	see drawing
1er Reihe/E82 Coupe (07-)	123 d		10.2007		13.0460-7223.2	607223	BRAKE PADS	34 11 6 771 972	see drawing
3 series/E36 (91-00)	M3 3,2	FL	09.1995	02.1998	24.0128-0204.2	428204	BRAKE DISC LEFT	34 11 2 227 737	
		FR	09.1995	02.1998	24.0128-0205.2	428205	BRAKE DISC RIGHT	34 11 2 227 738	
	M3 Cabrio 3,2	FL	09.1995	04.1999	24.0128-0204.2	428204	BRAKE DISC LEFT	34 11 2 227 737	
		FR	09.1995	04.1999	24.0128-0205.2	428205	BRAKE DISC RIGHT	34 11 2 227 738	
	M3 Coupe 3,2	FL	09.1995	04.1999	24.0128-0204.2	428204	BRAKE DISC LEFT	34 11 2 227 737	
		FR	09.1995	04.1999	24.0128-0205.2	428205	BRAKE DISC RIGHT	34 11 2 227 738	
3 series/E46 (98-06)	M3 Cabrio	FL	05.2001	12.2006	24.0128-0206.2	428206	BRAKE DISC LEFT	34 11 2 282 301 , 34 11 2 282 801	
		FR	05.2001	12.2006	24.0128-0207.2	428207	BRAKE DISC RIGHT	34 11 2 282 302 , 34 11 2 282 802	
	M3 Coupe	FL	06.2000	08.2006	24.0128-0206.2	428206	BRAKE DISC LEFT	34 11 2 282 301 , 34 11 2 282 801	
		FR	06.2000	08.2006	24.0128-0207.2	428207	BRAKE DISC RIGHT	34 11 2 282 302 , 34 11 2 282 802	
	M3 CSL Coupe	FL	05.2003	08.2006	24.0128-0208.2	428208	BRAKE DISC LEFT	34 11 2 282 445	
		FR	05.2003	08.2006	24.0128-0209.2	428209	BRAKE DISC RIGHT	34 11 2 282 446	
5 series/E39 (96-03)	M5	FL	10.1998	07.2003	24.0132-0161.2	432161	BRAKE DISC LEFT	34 11 2 282 803 , 34 11 2 228 845	
		FR	10.1998	07.2003	24.0132-0162.2	432162	BRAKE DISC RIGHT	34 11 2 282 804 , 34 11 2 228 846	

New partnumbers on stock - according to applications

02/2008



					Description	OE numbers per ATE pn.		e.g. replaced pn. / miscellaneous
--	--	--	--	--	-------------	------------------------	--	-----------------------------------

BMW

Z3 (95-02)	M Coupe	FL	02.1998	12.2002	24.0128-0204.2	428204	BRAKE DISC LEFT	34 11 2 227 737	
		FR	02.1998	12.2002	24.0128-0205.2	428205	BRAKE DISC RIGHT	34 11 2 227 738	
	M Roadster	FL	03.1997	12.2002	24.0128-0204.2	428204	BRAKE DISC LEFT	34 11 2 227 737	
		FR	03.1997	12.2002	24.0128-0205.2	428205	BRAKE DISC RIGHT	34 11 2 227 738	
Z4 Coupe (06-)	M 3,2	FL	03.2006		24.0128-0208.2	428208	BRAKE DISC LEFT	34 11 2 282 445	
		FR	03.2006		24.0128-0209.2	428209	BRAKE DISC RIGHT	34 11 2 282 446	
Z4 Roadster (03-)		FL	01.2006		24.0128-0208.2	428208	BRAKE DISC LEFT	34 11 2 282 445	
		FR	01.2006		24.0128-0209.2	428209	BRAKE DISC RIGHT	34 11 2 282 446	







CITROEN

EVASION (94-02)	1,9 TD		02.1995	07.2002	24.3728-0342.2	590342	CLUTCH CABLE	1476638080 , 1480346080 , 2150 J0 , 2150 T1	24.3728-0326.2
	2,0 Turbo		06.1994	07.2002	24.3728-0342.2	590342	CLUTCH CABLE	1476638080 , 1480346080 , 2150 J0 , 2150 T1	24.3728-0326.2
JUMPY I Van (95-06)	1,9 TD		10.1995	12.2006	24.3728-0342.2	590342	CLUTCH CABLE	1476638080 , 1480346080 , 2150 J0 , 2150 T1	24.3728-0326.2
JUMPY I Estate (95-06)			04.1996	12.2006	24.3728-0342.2	590342	CLUTCH CABLE	1476638080 , 1480346080 , 2150 J0 , 2150 T1	24.3728-0326.2
			10.1995	12.2006	24.3728-0342.2	590342	CLUTCH CABLE	1476638080 , 1480346080 , 2150 J0 , 2150 T1	24.3728-0326.2
JUMPY I Pickup/Chassis (99-06)			10.1999	12.2006	24.3728-0342.2	590342	CLUTCH CABLE	1476638080 , 1480346080 , 2150 J0 , 2150 T1	24.3728-0326.2

New partnumbers on stock - according to applications

02/2008



					Description	OE numbers per ATE pn.	 e.g. replaced pn. / miscellaneous
---	---	---	---	---	-------------	------------------------	--

DAIHATSU

CHARADE (93-01)	1,3 16V (G200)		01.1993	04.2001	13.0460-5898.2	605898	BRAKE PADS	04491-87724-000 , 04491-87725-000 , 04491-87727-000 , 04491-87728-000 , 04491-87731-000	see drawing
			05.1996	11.1999	13.0460-5898.2	605898	BRAKE PADS	04491-87724-000 , 04491-87725-000 , 04491-87727-000 , 04491-87728-000 , 04491-87731-000	see drawing
	1,3 16V (G204)		09.1996	04.2001	13.0460-5898.2	605898	BRAKE PADS	04491-87724-000 , 04491-87725-000 , 04491-87727-000 , 04491-87728-000 , 04491-87731-000	see drawing
	1,5 16V (G203)		10.1994	11.1999	13.0460-5898.2	605898	BRAKE PADS	04491-87724-000 , 04491-87725-000 , 04491-87727-000 , 04491-87728-000 , 04491-87731-000	see drawing
			08.1994	11.1999	13.0460-5898.2	605898	BRAKE PADS	04491-87724-000 , 04491-87725-000 , 04491-87727-000 , 04491-87728-000 , 04491-87731-000	see drawing
	1,6 GTi (G201)		03.1993	03.1996	13.0460-5898.2	605898	BRAKE PADS	04491-87724-000 , 04491-87725-000 , 04491-87727-000 , 04491-87728-000 , 04491-87731-000	see drawing
GRAN MOVE (96-02)	1,5 i 16V (G303)		08.1996	07.1998	13.0460-5898.2	605898	BRAKE PADS	04491-87724-000 , 04491-87725-000 , 04491-87727-000 , 04491-87728-000 , 04491-87731-000	see drawing
	1,6 i 16V (G301)		07.1998	07.2002	13.0460-5898.2	605898	BRAKE PADS	04491-87724-000 , 04491-87725-000 , 04491-87727-000 , 04491-87728-000 , 04491-87731-000	see drawing

New partnumbers on stock - according to applications

02/2008



	i				Description	OE numbers per ATE pn.	i e.g. replaced pn. / miscellaneous
--	----------	--	--	--	--------------------	-------------------------------	---





FIAT

DOBLO (01-)	1,3 JTD		10.2005		03.0137-9296.2	669296	BRAKE SHOE ACC.		
	1,4 i		10.2005		03.0137-9296.2	669296	BRAKE SHOE ACC.		
	1,6 i 16V		10.2005		03.0137-9296.2	669296	BRAKE SHOE ACC.		
	1,9 JTD		10.2005		03.0137-9296.2	669296	BRAKE SHOE ACC.		
PUNTO (03-06)	1,2 i		07.2003	11.2005	24.2120-1743.3	010777	TANDEM MASTER CYL.	9949546	
	1,2 i 16V		07.2003	11.2005	24.2120-1743.3	010777	TANDEM MASTER CYL.	9949546	
SCUDO (95-06)	1,9 TD		11.1995	01.2007	24.3728-0342.2	590342	CLUTCH CABLE	1476638080 , 1480346080 , 2150 J0 , 2150 T1	24.3728-0326.2
	2,0 JTD		12.1999	01.2007	24.3728-0342.2	590342	CLUTCH CABLE	1476638080 , 1480346080 , 2150 J0 , 2150 T1	24.3728-0326.2
ULYSSE (94-02)	1,9 TD		01.1995	07.2002	24.3728-0342.2	590342	CLUTCH CABLE	1476638080 , 1480346080 , 2150 J0 , 2150 T1	24.3728-0326.2
	2,0 i,e, Turbo		06.1994	07.2002	24.3728-0342.2	590342	CLUTCH CABLE	1476638080 , 1480346080 , 2150 J0 , 2150 T1	24.3728-0326.2
	2,0 JTD		10.1999	07.2002	24.3728-0342.2	590342	CLUTCH CABLE	1476638080 , 1480346080 , 2150 J0 , 2150 T1	24.3728-0326.2

New partnumbers on stock - according to applications

02/2008



				Description	OE numbers per ATE pn.	 e.g. replaced pn. / miscellaneous
---	---	--	---	--------------------	-------------------------------	--







FORD

C-MAX (07-)	1,6 i 16V		03.2007		03.7863-0332.4	300203	BOOSTER UNIT T52	1234277 , 1324226 , 1344668 , 1435812 , 1456987 , 1469137 , 3M51 2005-AA , 3M51 2005-AB , 3M51 2005-AC , 3M51 2005-AD , 6M51 2005-CA , 6M51 2005-CB	
	1,6 TDCi		03.2007		03.7863-0332.4	300203	BOOSTER UNIT T52	1234277 , 1324226 , 1344668 , 1435812 , 1456987 , 1469137 , 3M51 2005-AA , 3M51 2005-AB , 3M51 2005-AC , 3M51 2005-AD , 6M51 2005-CA , 6M51 2005-CB	
	1,8 i 16V		03.2007		03.7863-0332.4	300203	BOOSTER UNIT T52	1234277 , 1324226 , 1344668 , 1435812 , 1456987 , 1469137 , 3M51 2005-AA , 3M51 2005-AB , 3M51 2005-AC , 3M51 2005-AD , 6M51 2005-CA , 6M51 2005-CB	
	2,0 i 16V		03.2007		03.7863-0332.4	300203	BOOSTER UNIT T52	1234277 , 1324226 , 1344668 , 1435812 , 1456987 , 1469137 , 3M51 2005-AA , 3M51 2005-AB , 3M51 2005-AC , 3M51 2005-AD , 6M51 2005-CA , 6M51 2005-CB	
	2,0 TDCi		03.2007		03.7863-0332.4	300203	BOOSTER UNIT T52	1234277 , 1324226 , 1344668 , 1435812 , 1456987 , 1469137 , 3M51 2005-AA , 3M51 2005-AB , 3M51 2005-AC , 3M51 2005-AD , 6M51 2005-CA , 6M51 2005-CB	

New partnumbers on stock - according to applications

02/2008



					Description	OE numbers per ATE pn.	 e.g. replaced pn. / miscellaneous
---	---	---	---	---	-------------	------------------------	--

FORD

FIESTA V (02-)	1,25 i 16V		05.2002		03.7750-8732.4	300199	BOOSTER UNIT T52	1146122 , 1232020 , 1475864 , 2S61 2005-AA , 2S61 2005-AB , 2S61 2005-AC	
			03.2003		03.7750-8732.4	300199	BOOSTER UNIT T52	1146122 , 1232020 , 1475864 , 2S61 2005-AA , 2S61 2005-AB , 2S61 2005-AC	
			03.2003		03.7853-2102.4	300201	BOOSTER UNIT T52	1146124 , 1232022 , 1463551 , 2S61 2005-BA , 2S61 2005-BB , 2S61 2005-BC	
			05.2002		03.7853-2102.4	300201	BOOSTER UNIT T52	1146124 , 1232022 , 1463551 , 2S61 2005-BA , 2S61 2005-BB , 2S61 2005-BC	
	1,3 i		04.2002		03.7750-8732.4	300199	BOOSTER UNIT T52	1146122 , 1232020 , 1475864 , 2S61 2005-AA , 2S61 2005-AB , 2S61 2005-AC	
			04.2002		03.7853-2102.4	300201	BOOSTER UNIT T52	1146124 , 1232022 , 1463551 , 2S61 2005-BA , 2S61 2005-BB , 2S61 2005-BC	
	1,4 i 16V		04.2002		03.7750-8732.4	300199	BOOSTER UNIT T52	1146122 , 1232020 , 1475864 , 2S61 2005-AA , 2S61 2005-AB , 2S61 2005-AC	
			04.2002		03.7853-2102.4	300201	BOOSTER UNIT T52	1146124 , 1232022 , 1463551 , 2S61 2005-BA , 2S61 2005-BB , 2S61 2005-BC	
	1,4 TDCi		04.2002		03.7750-8732.4	300199	BOOSTER UNIT T52	1146122 , 1232020 , 1475864 , 2S61 2005-AA , 2S61 2005-AB , 2S61 2005-AC	
			04.2002		03.7853-2102.4	300201	BOOSTER UNIT T52	1146124 , 1232022 , 1463551 , 2S61 2005-BA , 2S61 2005-BB , 2S61 2005-BC	

New partnumbers on stock - according to applications

02/2008



					Description	OE numbers per ATE pn.		e.g. replaced pn. / miscellaneous
--	--	--	--	--	-------------	------------------------	--	-----------------------------------







FORD

FIESTA V (02-)	1,6 i 16V		04.2002		03.7853-2102.4	300201	BOOSTER UNIT T52	1146124 , 1232022 , 1463551 , 2S61 2005-BA , 2S61 2005-BB , 2S61 2005-BC	
			04.2002		03.7750-8732.4	300199	BOOSTER UNIT T52	1146122 , 1232020 , 1475864 , 2S61 2005-AA , 2S61 2005-AB , 2S61 2005-AC	
	1,6 TDCi		10.2004		03.7853-2102.4	300201	BOOSTER UNIT T52	1146124 , 1232022 , 1463551 , 2S61 2005-BA , 2S61 2005-BB , 2S61 2005-BC	
			10.2004		03.7750-8732.4	300199	BOOSTER UNIT T52	1146122 , 1232020 , 1475864 , 2S61 2005-AA , 2S61 2005-AB , 2S61 2005-AC	
FOCUS C-MAX (03-07)	1,6 i 16V		08.2003	03.2007	03.7863-0332.4	300203	BOOSTER UNIT T52	1234277 , 1324226 , 1344668 , 1435812 , 1456987 , 1469137 , 3M51 2005-AA , 3M51 2005-AB , 3M51 2005-AC , 3M51 2005-AD , 6M51 2005-CA , 6M51 2005-CB	
	1,6 TDCi		08.2003	03.2007	03.7863-0332.4	300203	BOOSTER UNIT T52	1234277 , 1324226 , 1344668 , 1435812 , 1456987 , 1469137 , 3M51 2005-AA , 3M51 2005-AB , 3M51 2005-AC , 3M51 2005-AD , 6M51 2005-CA , 6M51 2005-CB	
			01.2005	03.2007	03.7863-0332.4	300203	BOOSTER UNIT T52	1234277 , 1324226 , 1344668 , 1435812 , 1456987 , 1469137 , 3M51 2005-AA , 3M51 2005-AB , 3M51 2005-AC , 3M51 2005-AD , 6M51 2005-CA , 6M51 2005-CB	

New partnumbers on stock - according to applications

02/2008



		 		Description	OE numbers per ATE pn.	 e.g. replaced pn. / miscellaneous
---	---	---	---	--------------------	-------------------------------	--

FORD

FOCUS C-MAX (03-07)	1,6 Ti VCT		08.2004	03.2007	03.7863-0332.4	300203	BOOSTER UNIT T52	1234277 , 1324226 , 1344668 , 1435812 , 1456987 , 1469137 , 3M51 2005-AA , 3M51 2005-AB , 3M51 2005-AC , 3M51 2005-AD , 6M51 2005-CA , 6M51 2005-CB	
	1,8 i 16V		04.2004	03.2007	03.7863-0332.4	300203	BOOSTER UNIT T52	1234277 , 1324226 , 1344668 , 1435812 , 1456987 , 1469137 , 3M51 2005-AA , 3M51 2005-AB , 3M51 2005-AC , 3M51 2005-AD , 6M51 2005-CA , 6M51 2005-CB	
			08.2003	03.2007	03.7863-0332.4	300203	BOOSTER UNIT T52	1234277 , 1324226 , 1344668 , 1435812 , 1456987 , 1469137 , 3M51 2005-AA , 3M51 2005-AB , 3M51 2005-AC , 3M51 2005-AD , 6M51 2005-CA , 6M51 2005-CB	
	1,8 TDCi		01.2005	03.2007	03.7863-0332.4	300203	BOOSTER UNIT T52	1234277 , 1324226 , 1344668 , 1435812 , 1456987 , 1469137 , 3M51 2005-AA , 3M51 2005-AB , 3M51 2005-AC , 3M51 2005-AD , 6M51 2005-CA , 6M51 2005-CB	
	2,0 i 16V		04.2004	03.2007	03.7863-0332.4	300203	BOOSTER UNIT T52	1234277 , 1324226 , 1344668 , 1435812 , 1456987 , 1469137 , 3M51 2005-AA , 3M51 2005-AB , 3M51 2005-AC , 3M51 2005-AD , 6M51 2005-CA , 6M51 2005-CB	

New partnumbers on stock - according to applications

02/2008



				Description	OE numbers per ATE pn.	 e.g. replaced pn. / miscellaneous
--	--	--	--	--------------------	-------------------------------	---------------------------------------







FORD

FOCUS C-MAX (03-07)	2,0 TDCi		08.2003	03.2007	03.7863-0332.4	300203	BOOSTER UNIT T52	1234277 , 1324226 , 1344668 , 1435812 , 1456987 , 1469137 , 3M51 2005-AA , 3M51 2005-AB , 3M51 2005-AC , 3M51 2005- AD , 6M51 2005-CA , 6M51 2005-CB	
FOCUS II (05-)	1,4 i 16V		10.2004		03.7863-0332.4	300203	BOOSTER UNIT T52	1234277 , 1324226 , 1344668 , 1435812 , 1456987 , 1469137 , 3M51 2005-AA , 3M51 2005-AB , 3M51 2005-AC , 3M51 2005- AD , 6M51 2005-CA , 6M51 2005-CB	
	1,6 i 16V		10.2004		03.7863-0332.4	300203	BOOSTER UNIT T52	1234277 , 1324226 , 1344668 , 1435812 , 1456987 , 1469137 , 3M51 2005-AA , 3M51 2005-AB , 3M51 2005-AC , 3M51 2005- AD , 6M51 2005-CA , 6M51 2005-CB	
	1,6 TDCi		10.2004		03.7863-0332.4	300203	BOOSTER UNIT T52	1234277 , 1324226 , 1344668 , 1435812 , 1456987 , 1469137 , 3M51 2005-AA , 3M51 2005-AB , 3M51 2005-AC , 3M51 2005- AD , 6M51 2005-CA , 6M51 2005-CB	
			01.2005		03.7863-0332.4	300203	BOOSTER UNIT T52	1234277 , 1324226 , 1344668 , 1435812 , 1456987 , 1469137 , 3M51 2005-AA , 3M51 2005-AB , 3M51 2005-AC , 3M51 2005- AD , 6M51 2005-CA , 6M51 2005-CB	

New partnumbers on stock - according to applications

02/2008



		 		Description	OE numbers per ATE pn.	 e.g. replaced pn. / miscellaneous
---	---	---	---	--------------------	-------------------------------	--







FORD

FOCUS II (05-)	1,6 Ti VCT		10.2004		03.7863-0332.4	300203	BOOSTER UNIT T52	1234277 , 1324226 , 1344668 , 1435812 , 1456987 , 1469137 , 3M51 2005-AA , 3M51 2005-AB , 3M51 2005-AC , 3M51 2005-AD , 6M51 2005-CA , 6M51 2005-CB	
	1,8 i 16V		01.2006		03.7863-0332.4	300203	BOOSTER UNIT T52	1234277 , 1324226 , 1344668 , 1435812 , 1456987 , 1469137 , 3M51 2005-AA , 3M51 2005-AB , 3M51 2005-AC , 3M51 2005-AD , 6M51 2005-CA , 6M51 2005-CB	
	1,8 TDCi		01.2005		03.7863-0332.4	300203	BOOSTER UNIT T52	1234277 , 1324226 , 1344668 , 1435812 , 1456987 , 1469137 , 3M51 2005-AA , 3M51 2005-AB , 3M51 2005-AC , 3M51 2005-AD , 6M51 2005-CA , 6M51 2005-CB	
	2,0 i 16V		10.2004		03.7863-0332.4	300203	BOOSTER UNIT T52	1234277 , 1324226 , 1344668 , 1435812 , 1456987 , 1469137 , 3M51 2005-AA , 3M51 2005-AB , 3M51 2005-AC , 3M51 2005-AD , 6M51 2005-CA , 6M51 2005-CB	
	2,0 TDCi		10.2004		03.7863-0332.4	300203	BOOSTER UNIT T52	1234277 , 1324226 , 1344668 , 1435812 , 1456987 , 1469137 , 3M51 2005-AA , 3M51 2005-AB , 3M51 2005-AC , 3M51 2005-AD , 6M51 2005-CA , 6M51 2005-CB	

New partnumbers on stock - according to applications

02/2008



					Description	OE numbers per ATE pn.	 e.g. replaced pn. / miscellaneous
---	---	---	---	---	-------------	------------------------	--

FORD

FUSION (02-)	1,25 i 16V		08.2004		03.7750-8732.4	300199	BOOSTER UNIT T52	1146122 , 1232020 , 1475864 , 2S61 2005-AA , 2S61 2005-AB , 2S61 2005-AC	
			08.2004		03.7853-2102.4	300201	BOOSTER UNIT T52	1146124 , 1232022 , 1463551 , 2S61 2005-BA , 2S61 2005-BB , 2S61 2005-BC	
	1,4 i 16V		07.2002		03.7750-8732.4	300199	BOOSTER UNIT T52	1146122 , 1232020 , 1475864 , 2S61 2005-AA , 2S61 2005-AB , 2S61 2005-AC	
			07.2002		03.7853-2102.4	300201	BOOSTER UNIT T52	1146124 , 1232022 , 1463551 , 2S61 2005-BA , 2S61 2005-BB , 2S61 2005-BC	
	1,4 TDCi		07.2002		03.7750-8732.4	300199	BOOSTER UNIT T52	1146122 , 1232020 , 1475864 , 2S61 2005-AA , 2S61 2005-AB , 2S61 2005-AC	
			07.2002		03.7853-2102.4	300201	BOOSTER UNIT T52	1146124 , 1232022 , 1463551 , 2S61 2005-BA , 2S61 2005-BB , 2S61 2005-BC	
	1,6 i 16V		07.2002		03.7853-2102.4	300201	BOOSTER UNIT T52	1146124 , 1232022 , 1463551 , 2S61 2005-BA , 2S61 2005-BB , 2S61 2005-BC	
			07.2002		03.7750-8732.4	300199	BOOSTER UNIT T52	1146122 , 1232020 , 1475864 , 2S61 2005-AA , 2S61 2005-AB , 2S61 2005-AC	
	1,6 TDCi		10.2004		03.7853-2102.4	300201	BOOSTER UNIT T52	1146124 , 1232022 , 1463551 , 2S61 2005-BA , 2S61 2005-BB , 2S61 2005-BC	
			10.2004		03.7750-8732.4	300199	BOOSTER UNIT T52	1146122 , 1232020 , 1475864 , 2S61 2005-AA , 2S61 2005-AB , 2S61 2005-AC	

New partnumbers on stock - according to applications

02/2008



				Description	OE numbers per ATE pn.	 e.g. replaced pn. / miscellaneous
--	--	--	--	--------------------	-------------------------------	---------------------------------------







HYUNDAI

Model	Engine	Start	End	ATE Part No.	ATE Part No.	Description	OE numbers	Notes
ACCENT (00-05)	1,3 i 12V	01.2000	07.2002	13.0460-5872.2	605872	BRAKE PADS	58101-25A10 , 58101-29A40 , 58101-26A10 , 58101-1CA10 , 58101-28A10	see drawing
		01.2000	09.2005	13.0460-5872.2	605872	BRAKE PADS	58101-25A10 , 58101-29A40 , 58101-26A10 , 58101-1CA10 , 58101-28A10	see drawing
		08.2002	09.2005	13.0460-5872.2	605872	BRAKE PADS	58101-25A10 , 58101-29A40 , 58101-26A10 , 58101-1CA10 , 58101-28A10	see drawing
	1,5 CRDi	04.2002	09.2005	13.0460-5872.2	605872	BRAKE PADS	58101-25A10 , 58101-29A40 , 58101-26A10 , 58101-1CA10 , 58101-28A10	see drawing
	1,5 i 12V	01.2000	10.2002	13.0460-5872.2	605872	BRAKE PADS	58101-25A10 , 58101-29A40 , 58101-26A10 , 58101-1CA10 , 58101-28A10	see drawing
	1,5 i 16V	09.2000	09.2005	13.0460-5872.2	605872	BRAKE PADS	58101-25A10 , 58101-29A40 , 58101-26A10 , 58101-1CA10 , 58101-28A10	see drawing
	1,6 i 16V	10.2002	09.2005	13.0460-5872.2	605872	BRAKE PADS	58101-25A10 , 58101-29A40 , 58101-26A10 , 58101-1CA10 , 58101-28A10	see drawing
COUPE (02-)		03.2002		13.0460-5874.2	605874	BRAKE PADS	58302-2FA10 , 58302-29A00 , 58302-29A10 , 58302-2DA10	see drawing
	2,0 CCVT	02.2003		13.0460-5874.2	605874	BRAKE PADS	58302-2FA10 , 58302-29A00 , 58302-29A10 , 58302-2DA10	see drawing
	2,0 i 16V	03.2002	06.2003	13.0460-5874.2	605874	BRAKE PADS	58302-2FA10 , 58302-29A00 , 58302-29A10 , 58302-2DA10	see drawing
	2,7 i V6	03.2002		13.0460-5874.2	605874	BRAKE PADS	58302-2FA10 , 58302-29A00 , 58302-29A10 , 58302-2DA10	see drawing

New partnumbers on stock - according to applications

02/2008



					Description	OE numbers per ATE pn.	 e.g. replaced pn. / miscellaneous
---	---	---	---	---	-------------	------------------------	--

HYUNDAI

COUPE (96-02)	1,6 i 16V		05.1996	02.2002	13.0460-5874.2	605874	BRAKE PADS	58302-2FA10 , 58302-29A00 , 58302-29A10 , 58302-2DA10	see drawing
	2,0 i 16V		05.1996	02.2002	13.0460-5874.2	605874	BRAKE PADS	58302-2FA10 , 58302-29A00 , 58302-29A10 , 58302-2DA10	see drawing
ELANTRA (00-03)	1,6 i 16V		06.2000	07.2003	13.0460-5874.2	605874	BRAKE PADS	58302-2FA10 , 58302-29A00 , 58302-29A10 , 58302-2DA10	see drawing
	1,8 i 16V		06.2000	07.2003	13.0460-5874.2	605874	BRAKE PADS	58302-2FA10 , 58302-29A00 , 58302-29A10 , 58302-2DA10	see drawing
	2,0 CRDi		04.2001	07.2003	13.0460-5874.2	605874	BRAKE PADS	58302-2FA10 , 58302-29A00 , 58302-29A10 , 58302-2DA10	see drawing
	2,0 i 16V		06.2000	07.2003	13.0460-5874.2	605874	BRAKE PADS	58302-2FA10 , 58302-29A00 , 58302-29A10 , 58302-2DA10	see drawing
ELANTRA (03-06)	1,6 i 16V		08.2003	05.2006	13.0460-5874.2	605874	BRAKE PADS	58302-2FA10 , 58302-29A00 , 58302-29A10 , 58302-2DA10	see drawing
	1,8 i 16V		08.2003	05.2006	13.0460-5874.2	605874	BRAKE PADS	58302-2FA10 , 58302-29A00 , 58302-29A10 , 58302-2DA10	see drawing
	2,0 CRDi		08.2003	05.2006	13.0460-5874.2	605874	BRAKE PADS	58302-2FA10 , 58302-29A00 , 58302-29A10 , 58302-2DA10	see drawing
	2,0 i 16V		08.2003	05.2006	13.0460-5874.2	605874	BRAKE PADS	58302-2FA10 , 58302-29A00 , 58302-29A10 , 58302-2DA10	see drawing
GETZ (02-)	1,1 i 12V		09.2002	08.2005	13.0460-5872.2	605872	BRAKE PADS	58101-25A10 , 58101-29A40 , 58101-26A10 , 58101-1CA10 , 58101-28A10	see drawing
			09.2005		13.0460-5872.2	605872	BRAKE PADS	58101-25A10 , 58101-29A40 , 58101-26A10 , 58101-1CA10 , 58101-28A10	see drawing

New partnumbers on stock - according to applications

02/2008



					Description	OE numbers per ATE pn.		e.g. replaced pn. / miscellaneous
--	--	--	--	--	-------------	------------------------	--	-----------------------------------







HYUNDAI

Model	Engine	Start	End	ATE Part No.	ATE Part No.	Description	OE numbers	Notes
GETZ (02-)	1,3 i 12V	09.2003	04.2005	13.0460-5872.2	605872	BRAKE PADS	58101-25A10 , 58101-29A40 , 58101-26A10 , 58101-1CA10 , 58101-28A10	see drawing
		09.2002	04.2005	13.0460-5872.2	605872	BRAKE PADS	58101-25A10 , 58101-29A40 , 58101-26A10 , 58101-1CA10 , 58101-28A10	see drawing
	1,4 i 16V	08.2005		13.0460-5872.2	605872	BRAKE PADS	58101-25A10 , 58101-29A40 , 58101-26A10 , 58101-1CA10 , 58101-28A10	see drawing
	1,5 CRDi	03.2003	04.2005	13.0460-5872.2	605872	BRAKE PADS	58101-25A10 , 58101-29A40 , 58101-26A10 , 58101-1CA10 , 58101-28A10	see drawing
		08.2005		13.0460-5872.2	605872	BRAKE PADS	58101-25A10 , 58101-29A40 , 58101-26A10 , 58101-1CA10 , 58101-28A10	see drawing
	1,5 CRDi GLS	07.2004	08.2005	13.0460-5872.2	605872	BRAKE PADS	58101-25A10 , 58101-29A40 , 58101-26A10 , 58101-1CA10 , 58101-28A10	see drawing
		08.2005		13.0460-5872.2	605872	BRAKE PADS	58101-25A10 , 58101-29A40 , 58101-26A10 , 58101-1CA10 , 58101-28A10	see drawing
	1,5 i GL	08.2002	07.2005	13.0460-5872.2	605872	BRAKE PADS	58101-25A10 , 58101-29A40 , 58101-26A10 , 58101-1CA10 , 58101-28A10	see drawing
	1,6 i 16V	09.2002	07.2005	13.0460-5872.2	605872	BRAKE PADS	58101-25A10 , 58101-29A40 , 58101-26A10 , 58101-1CA10 , 58101-28A10	see drawing
LANTRA (00-03)		06.2000	07.2003	13.0460-5874.2	605874	BRAKE PADS	58302-2FA10 , 58302-29A00 , 58302-29A10 , 58302-2DA10	see drawing
	1,8 i 16V	06.2000	07.2003	13.0460-5874.2	605874	BRAKE PADS	58302-2FA10 , 58302-29A00 , 58302-29A10 , 58302-2DA10	see drawing

New partnumbers on stock - according to applications

02/2008



					Description	OE numbers per ATE pn.	 e.g. replaced pn. / miscellaneous
---	---	---	---	---	-------------	------------------------	--







HYUNDAI

LANTRA (00-03)	2,0 CRDi		04.2001	07.2003	13.0460-5874.2	605874	BRAKE PADS	58302-2FA10 , 58302-29A00 , 58302-29A10 , 58302-2DA10	see drawing
	2,0 i 16V		06.2000	07.2003	13.0460-5874.2	605874	BRAKE PADS	58302-2FA10 , 58302-29A00 , 58302-29A10 , 58302-2DA10	see drawing
LANTRA/ELANTRA (95-00)	1,5 12V		08.1995	05.2000	13.0460-5872.2	605872	BRAKE PADS	58101-25A10 , 58101-29A40 , 58101-26A10 , 58101-1CA10 , 58101-28A10	see drawing
			08.1995	05.2000	13.0460-5874.2	605874	BRAKE PADS	58302-2FA10 , 58302-29A00 , 58302-29A10 , 58302-2DA10	see drawing
	1,6 16V		08.1995	05.2000	13.0460-5874.2	605874	BRAKE PADS	58302-2FA10 , 58302-29A00 , 58302-29A10 , 58302-2DA10	see drawing
	1,8 16V		08.1995	05.2000	13.0460-5874.2	605874	BRAKE PADS	58302-2FA10 , 58302-29A00 , 58302-29A10 , 58302-2DA10	see drawing
	2,0 16V		08.1995	05.2000	13.0460-5874.2	605874	BRAKE PADS	58302-2FA10 , 58302-29A00 , 58302-29A10 , 58302-2DA10	see drawing
SANTA FE (01-06)	2,0 CRDi		08.2001	07.2003	13.0460-5872.2	605872	BRAKE PADS	58101-25A10 , 58101-29A40 , 58101-26A10 , 58101-1CA10 , 58101-28A10	see drawing
			11.2003	02.2006	13.0460-5872.2	605872	BRAKE PADS	58101-25A10 , 58101-29A40 , 58101-26A10 , 58101-1CA10 , 58101-28A10	see drawing
			08.2003	02.2006	13.0460-5872.2	605872	BRAKE PADS	58101-25A10 , 58101-29A40 , 58101-26A10 , 58101-1CA10 , 58101-28A10	see drawing
	2,0 i 16V		02.2001	02.2006	13.0460-5872.2	605872	BRAKE PADS	58101-25A10 , 58101-29A40 , 58101-26A10 , 58101-1CA10 , 58101-28A10	see drawing

New partnumbers on stock - according to applications

02/2008



					Description	OE numbers per ATE pn.	 e.g. replaced pn. / miscellaneous
---	---	---	---	---	-------------	------------------------	--

HYUNDAI

SANTA FE (01-06)	2,4 i 16V		02.2001	02.2006	13.0460-5872.2	605872	BRAKE PADS	58101-25A10 , 58101-29A40 , 58101-26A10 , 58101-1CA10 , 58101-28A10	see drawing
------------------	-----------	--	---------	---------	----------------	--------	------------	---	-------------

KIA

CERATO (04-)	1,5 CRDi		07.2005		13.0460-5874.2	605874	BRAKE PADS	58302-2FA10 , 58302-29A00 , 58302-29A10 , 58302-2DA10	see drawing
	1,6 i 16V		04.2004		13.0460-5874.2	605874	BRAKE PADS	58302-2FA10 , 58302-29A00 , 58302-29A10 , 58302-2DA10	see drawing
	2,0 CRDi		04.2004		13.0460-5874.2	605874	BRAKE PADS	58302-2FA10 , 58302-29A00 , 58302-29A10 , 58302-2DA10	see drawing
	2,0 i 16V		04.2004		13.0460-5874.2	605874	BRAKE PADS	58302-2FA10 , 58302-29A00 , 58302-29A10 , 58302-2DA10	see drawing

LANCIA

ZETA (94-02)	2,0 i,e, Turbo		06.1994	09.2002	24.3728-0342.2	590342	CLUTCH CABLE	1476638080 , 1480346080 , 2150 J0 , 2150 T1	24.3728-0326.2
	2,0 JTD		09.1999	09.2002	24.3728-0342.2	590342	CLUTCH CABLE	1476638080 , 1480346080 , 2150 J0 , 2150 T1	24.3728-0326.2

LEXUS

LX 470 (02-05)	4,7 i V8 4WD (UZJ100)		08.2002	07.2005	24.0118-0143.1	418143	BRAKE DISC	42431-60221 , 42431-60280 , 42431-60220 , 42431-60281	
RX 300 (00-06)	3,0 i V6 4WD (MCU15)		10.2000	04.2003	24.0128-0186.1	428186	BRAKE DISC	43512-48020 , 43512-48050	

New partnumbers on stock - according to applications

02/2008



					Description	OE numbers per ATE pn.		e.g. replaced pn. / miscellaneous
--	--	--	--	--	-------------	------------------------	--	-----------------------------------

MERCEDES BENZ

(R107) 280 SL-560 SL (71-89)	280 SL		09.1974	07.1985	83.7704-0421.3	330827	BRAKE HOSE	0438874 , 001 428 94 35 , 123 428 03 35 , 123 428 05 35 , 000 428 28 35 , 000 428 80 35	83.6104-0421.3
	280 SLC		09.1974	03.1980	83.7704-0421.3	330827	BRAKE HOSE	0438874 , 001 428 94 35 , 123 428 03 35 , 123 428 05 35 , 000 428 28 35 , 000 428 80 35	83.6104-0421.3
	350 SL		02.1971	02.1980	83.7704-0421.3	330827	BRAKE HOSE	0438874 , 001 428 94 35 , 123 428 03 35 , 123 428 05 35 , 000 428 28 35 , 000 428 80 35	83.6104-0421.3
	350 SLC		09.1971	02.1980	83.7704-0421.3	330827	BRAKE HOSE	0438874 , 001 428 94 35 , 123 428 03 35 , 123 428 05 35 , 000 428 28 35 , 000 428 80 35	83.6104-0421.3
	380 SL		03.1980	08.1985	83.7704-0421.3	330827	BRAKE HOSE	0438874 , 001 428 94 35 , 123 428 03 35 , 123 428 05 35 , 000 428 28 35 , 000 428 80 35	83.6104-0421.3
	380 SLC		03.1980	08.1981	83.7704-0421.3	330827	BRAKE HOSE	0438874 , 001 428 94 35 , 123 428 03 35 , 123 428 05 35 , 000 428 28 35 , 000 428 80 35	83.6104-0421.3
	450 SL		03.1973	09.1980	83.7704-0421.3	330827	BRAKE HOSE	0438874 , 001 428 94 35 , 123 428 03 35 , 123 428 05 35 , 000 428 28 35 , 000 428 80 35	83.6104-0421.3
	450 SLC		03.1973	09.1980	83.7704-0421.3	330827	BRAKE HOSE	0438874 , 001 428 94 35 , 123 428 03 35 , 123 428 05 35 , 000 428 28 35 , 000 428 80 35	83.6104-0421.3

New partnumbers on stock - according to applications

02/2008



	i				Description	OE numbers per ATE pn.	i e.g. replaced pn. / miscellaneous
--	----------	--	--	--	--------------------	-------------------------------	---







MERCEDES BENZ

(R107) 280 SL-560 SL (71-89)	450 SLC 5,0		04.1978	02.1980	83.7704-0421.3	330827	BRAKE HOSE	0438874 , 001 428 94 35 , 123 428 03 35 , 123 428 05 35 , 000 428 28 35 , 000 428 80 35	83.6104-0421.3
	500 SL		05.1980	08.1985	83.7704-0421.3	330827	BRAKE HOSE	0438874 , 001 428 94 35 , 123 428 03 35 , 123 428 05 35 , 000 428 28 35 , 000 428 80 35	83.6104-0421.3
	500 SLC		05.1978	07.1981	83.7704-0421.3	330827	BRAKE HOSE	0438874 , 001 428 94 35 , 123 428 03 35 , 123 428 05 35 , 000 428 28 35 , 000 428 80 35	83.6104-0421.3
(W116) 280 S-450 SEL 6,9 (72-80)	280 S		09.1972	07.1980	83.7704-0421.3	330827	BRAKE HOSE	0438874 , 001 428 94 35 , 123 428 03 35 , 123 428 05 35 , 000 428 28 35 , 000 428 80 35	83.6104-0421.3
	280 SE		08.1972	07.1980	83.7704-0421.3	330827	BRAKE HOSE	0438874 , 001 428 94 35 , 123 428 03 35 , 123 428 05 35 , 000 428 28 35 , 000 428 80 35	83.6104-0421.3
	280 SEL		01.1974	04.1980	83.7704-0421.3	330827	BRAKE HOSE	0438874 , 001 428 94 35 , 123 428 03 35 , 123 428 05 35 , 000 428 28 35 , 000 428 80 35	83.6104-0421.3
	350 SE		09.1972	03.1980	83.7704-0421.3	330827	BRAKE HOSE	0438874 , 001 428 94 35 , 123 428 03 35 , 123 428 05 35 , 000 428 28 35 , 000 428 80 35	83.6104-0421.3
	350 SEL		11.1973	01.1980	83.7704-0421.3	330827	BRAKE HOSE	0438874 , 001 428 94 35 , 123 428 03 35 , 123 428 05 35 , 000 428 28 35 , 000 428 80 35	83.6104-0421.3

New partnumbers on stock - according to applications

02/2008



					Description	OE numbers per ATE pn.	 e.g. replaced pn. / miscellaneous
---	---	---	---	---	-------------	------------------------	--







MERCEDES BENZ

(W116) 280 S-450 SEL 6,9 (72-80)	450 SE		11.1972	04.1980	83.7704-0421.3	330827	BRAKE HOSE	0438874 , 001 428 94 35 , 123 428 03 35 , 123 428 05 35 , 000 428 28 35 , 000 428 80 35	83.6104-0421.3
	450 SEL		03.1973	09.1980	83.7704-0421.3	330827	BRAKE HOSE	0438874 , 001 428 94 35 , 123 428 03 35 , 123 428 05 35 , 000 428 28 35 , 000 428 80 35	83.6104-0421.3
	450 SEL 6,9		05.1975	09.1980	83.7704-0421.3	330827	BRAKE HOSE	0438874 , 001 428 94 35 , 123 428 03 35 , 123 428 05 35 , 000 428 28 35 , 000 428 80 35	83.6104-0421.3
E-Class (S211) Estate (03-)	E 240 4-Matic		07.2003		24.0130-0179.1	430179	BRAKE DISC	211 421 12 12	
	E 280 4-Matic		05.2005		24.0130-0179.1	430179	BRAKE DISC	211 421 12 12	
	E 280 CDI 4-Matic		05.2005		24.0130-0179.1	430179	BRAKE DISC	211 421 12 12	
	E 320 4-Matic		07.2003		24.0130-0179.1	430179	BRAKE DISC	211 421 12 12	
	E 320 CDI 4-Matic		05.2005		24.0130-0179.1	430179	BRAKE DISC	211 421 12 12	
E-Class (W211) Saloon (02-)	E 240 4-Matic		03.2003		24.0130-0179.1	430179	BRAKE DISC	211 421 12 12	
	E 280 4-Matic		05.2005		24.0130-0179.1	430179	BRAKE DISC	211 421 12 12	
	E 280 CDI 4-Matic		05.2005		24.0130-0179.1	430179	BRAKE DISC	211 421 12 12	
	E 320 4-Matic		03.2003		24.0130-0179.1	430179	BRAKE DISC	211 421 12 12	
	E 320 CDI 4-Matic		05.2005		24.0130-0179.1	430179	BRAKE DISC	211 421 12 12	
SL-Class (R230) (01-)	SL 500		09.2001		24.0122-0229.1	422229	BRAKE DISC	230 423 04 12	

New partnumbers on stock - according to applications

02/2008



					Description	OE numbers per ATE pn.	 e.g. replaced pn. / miscellaneous
---	---	---	---	---	-------------	------------------------	--







MERCEDES BENZ

Transporter (BM 601) 207 D-210 D	207 D		05.1977		83.7704-0421.3	330827	BRAKE HOSE	0438874 , 001 428 94 35 , 123 428 03 35 , 123 428 05 35 , 000 428 28 35 , 000 428 80 35	83.6104-0421.3
	208		05.1977		83.7704-0421.3	330827	BRAKE HOSE	0438874 , 001 428 94 35 , 123 428 03 35 , 123 428 05 35 , 000 428 28 35 , 000 428 80 35	83.6104-0421.3
	208 D		09.1988		83.7704-0421.3	330827	BRAKE HOSE	0438874 , 001 428 94 35 , 123 428 03 35 , 123 428 05 35 , 000 428 28 35 , 000 428 80 35	83.6104-0421.3
	209 D		05.1977		83.7704-0421.3	330827	BRAKE HOSE	0438874 , 001 428 94 35 , 123 428 03 35 , 123 428 05 35 , 000 428 28 35 , 000 428 80 35	83.6104-0421.3
	210		05.1977		83.7704-0421.3	330827	BRAKE HOSE	0438874 , 001 428 94 35 , 123 428 03 35 , 123 428 05 35 , 000 428 28 35 , 000 428 80 35	83.6104-0421.3
	210 D		09.1988		83.7704-0421.3	330827	BRAKE HOSE	0438874 , 001 428 94 35 , 123 428 03 35 , 123 428 05 35 , 000 428 28 35 , 000 428 80 35	83.6104-0421.3
Transporter (BM 602) 307 D-310 D	307 D		05.1977		83.7704-0421.3	330827	BRAKE HOSE	0438874 , 001 428 94 35 , 123 428 03 35 , 123 428 05 35 , 000 428 28 35 , 000 428 80 35	83.6104-0421.3
	308		05.1977		83.7704-0421.3	330827	BRAKE HOSE	0438874 , 001 428 94 35 , 123 428 03 35 , 123 428 05 35 , 000 428 28 35 , 000 428 80 35	83.6104-0421.3

New partnumbers on stock - according to applications

02/2008



					Description	OE numbers per ATE pn.	 e.g. replaced pn. / miscellaneous
---	---	---	---	---	-------------	------------------------	--



MERCEDES BENZ

Transporter (BM 602) 307 D-310 D	308 D		09.1988		83.7704-0421.3	330827	BRAKE HOSE	0438874 , 001 428 94 35 , 123 428 03 35 , 123 428 05 35 , 000 428 28 35 , 000 428 80 35	83.6104-0421.3
	309 D		05.1977		83.7704-0421.3	330827	BRAKE HOSE	0438874 , 001 428 94 35 , 123 428 03 35 , 123 428 05 35 , 000 428 28 35 , 000 428 80 35	83.6104-0421.3
	310		05.1977		83.7704-0421.3	330827	BRAKE HOSE	0438874 , 001 428 94 35 , 123 428 03 35 , 123 428 05 35 , 000 428 28 35 , 000 428 80 35	83.6104-0421.3
	310 D		09.1988		83.7704-0421.3	330827	BRAKE HOSE	0438874 , 001 428 94 35 , 123 428 03 35 , 123 428 05 35 , 000 428 28 35 , 000 428 80 35	83.6104-0421.3
Transporter (BM 611) 407 D-410 D	407 D		06.1981		83.7704-0421.3	330827	BRAKE HOSE	0438874 , 001 428 94 35 , 123 428 03 35 , 123 428 05 35 , 000 428 28 35 , 000 428 80 35	83.6104-0421.3
	408 D		10.1988		83.7704-0421.3	330827	BRAKE HOSE	0438874 , 001 428 94 35 , 123 428 03 35 , 123 428 05 35 , 000 428 28 35 , 000 428 80 35	83.6104-0421.3
	409 D		06.1981		83.7704-0421.3	330827	BRAKE HOSE	0438874 , 001 428 94 35 , 123 428 03 35 , 123 428 05 35 , 000 428 28 35 , 000 428 80 35	83.6104-0421.3
	410		06.1981		83.7704-0421.3	330827	BRAKE HOSE	0438874 , 001 428 94 35 , 123 428 03 35 , 123 428 05 35 , 000 428 28 35 , 000 428 80 35	83.6104-0421.3

New partnumbers on stock - according to applications

02/2008



	i			Description	OE numbers per ATE pn.	i e.g. replaced pn. / miscellaneous
---	----------	--	---	--------------------	-------------------------------	---

MERCEDES BENZ

Transporter (BM 611) 407 D-410 D	410 D		11.1988		83.7704-0421.3	330827	BRAKE HOSE	0438874 , 001 428 94 35 , 123 428 03 35 , 123 428 05 35 , 000 428 28 35 , 000 428 80 35	83.6104-0421.3
----------------------------------	-------	--	---------	--	----------------	--------	------------	--	----------------

New partnumbers on stock - according to applications

02/2008



					Description	OE numbers per ATE pn.		e.g. replaced pn. / miscellaneous
--	--	--	--	--	-------------	------------------------	--	-----------------------------------



NISSAN

MICRA (K11E) (92-02)	1,0 i 16V		08.2000	12.2002	24.0118-0139.1	418139	BRAKE DISC	40206-1F500 , 40206-72B00	
	1,3 i 16V		08.2000	12.2002	24.0118-0139.1	418139	BRAKE DISC	40206-1F500 , 40206-72B00	
	1,5 D		08.2000	12.2002	24.0118-0139.1	418139	BRAKE DISC	40206-1F500 , 40206-72B00	
MICRA (K12E) (03-)	1,0 i 16V		01.2003		03.2123-2861.3	010774	TANDEM MASTER CYL.	46010-AX701 , 77 01 208 838	
	1,2 i 16V		01.2003		03.2123-2861.3	010774	TANDEM MASTER CYL.	46010-AX701 , 77 01 208 838	
	1,4 i 16V		01.2003		03.2123-2861.3	010774	TANDEM MASTER CYL.	46010-AX701 , 77 01 208 838	
	1,5 dCi		09.2003		03.2123-2861.3	010774	TANDEM MASTER CYL.	46010-AX701 , 77 01 208 838	
			01.2003		03.2123-2861.3	010774	TANDEM MASTER CYL.	46010-AX701 , 77 01 208 838	
	1,6 i 16V		05.2005		03.2123-2861.3	010774	TANDEM MASTER CYL.	46010-AX701 , 77 01 208 838	
MICRA C+C (CK12E) (05-)	1,4 i 16V		08.2005		03.2123-2861.3	010774	TANDEM MASTER CYL.	46010-AX701 , 77 01 208 838	
	1,6 i 16V		08.2005		03.2123-2861.3	010774	TANDEM MASTER CYL.	46010-AX701 , 77 01 208 838	
NOTE (E11E) (06-)	1,4		03.2006		03.2123-2861.3	010774	TANDEM MASTER CYL.	46010-AX701 , 77 01 208 838	
	1,5 dCi		03.2006		03.2123-2861.3	010774	TANDEM MASTER CYL.	46010-AX701 , 77 01 208 838	
	1,6		03.2006		03.2123-2861.3	010774	TANDEM MASTER CYL.	46010-AX701 , 77 01 208 838	
PRIMERA (W11) Estate (98-02)	1,6 i 16V	RR	04.2001	02.2002	24.3727-1721.2	581721	HANDBRAKE CABLE	36530-9F500	
		RL	04.2001	02.2002	24.3727-1720.2	581720	HANDBRAKE CABLE	36531-9F500	
	1,8 i 16V	RR	04.2001	02.2002	24.3727-1721.2	581721	HANDBRAKE CABLE	36530-9F500	
		RL	04.2001	02.2002	24.3727-1720.2	581720	HANDBRAKE CABLE	36531-9F500	
	2,0 i 16V	RR	04.2001	02.2002	24.3727-1721.2	581721	HANDBRAKE CABLE	36530-9F500	

New partnumbers on stock - according to applications

02/2008



	i			Description	OE numbers per ATE pn.	i e.g. replaced pn. / miscellaneous
---	----------	--	---	--------------------	-------------------------------	---

NISSAN

PRIMERA (W11) Estate (98-02)	2,0 i 16V	RL	04.2001	02.2002	24.3727-1720.2	581720	HANDBRAKE CABLE	36531-9F500	
	2,0 TD	RL	04.2001	02.2002	24.3727-1720.2	581720	HANDBRAKE CABLE	36531-9F500	
		RR	04.2001	02.2002	24.3727-1721.2	581721	HANDBRAKE CABLE	36530-9F500	

New partnumbers on stock - according to applications

02/2008



				Description	OE numbers per ATE pn.	 e.g. replaced pn. / miscellaneous
--	--	--	--	-------------	------------------------	---------------------------------------

PEUGEOT

206 Saloon (98-)	1,1	FA			24.0711-6205.3	360229	WHEEL SPEED SENSOR	4545 99 , 4545 F4	24.0711-6117.3
	1,4				03.7750-6132.4	300198	BOOSTER UNIT T52	4535 T0	
		FA			24.0711-6205.3	360229	WHEEL SPEED SENSOR	4545 99 , 4545 F4	24.0711-6117.3
	1,4 16V		10.2003		03.7750-6132.4	300198	BOOSTER UNIT T52	4535 T0	
		FA	10.2003		24.0711-6205.3	360229	WHEEL SPEED SENSOR	4545 99 , 4545 F4	24.0711-6117.3
	1,4 HDi				03.7750-6132.4	300198	BOOSTER UNIT T52	4535 T0	
		FA			24.0711-6205.3	360229	WHEEL SPEED SENSOR	4545 99 , 4545 F4	24.0711-6117.3
	1,6 16V	FA			24.0711-6205.3	360229	WHEEL SPEED SENSOR	4545 99 , 4545 F4	24.0711-6117.3
	1,6 HDi 110	FA	05.2004		24.0711-6205.3	360229	WHEEL SPEED SENSOR	4545 99 , 4545 F4	24.0711-6117.3
	2,0 HDi	FA			24.0711-6205.3	360229	WHEEL SPEED SENSOR	4545 99 , 4545 F4	24.0711-6117.3
	2,0 RC	FA	07.2003		24.0711-6205.3	360229	WHEEL SPEED SENSOR	4545 99 , 4545 F4	24.0711-6117.3
	2,0 S16	FA			24.0711-6205.3	360229	WHEEL SPEED SENSOR	4545 99 , 4545 F4	24.0711-6117.3
206 SW (02-)	1,4				03.7750-6132.4	300198	BOOSTER UNIT T52	4535 T0	
	1,4 16V		10.2003		03.7750-6132.4	300198	BOOSTER UNIT T52	4535 T0	
	1,4 HDi				03.7750-6132.4	300198	BOOSTER UNIT T52	4535 T0	
806 (94-02)	1,9 TD		07.1995	06.2002	24.3728-0342.2	590342	CLUTCH CABLE	1476638080 , 1480346080 , 2150 J0 , 2150 T1	24.3728-0326.2
	2,0 Turbo		08.1994	06.2002	24.3728-0342.2	590342	CLUTCH CABLE	1476638080 , 1480346080 , 2150 J0 , 2150 T1	24.3728-0326.2
EXPERT Van (95-)	1,9 TD		04.1996		24.3728-0342.2	590342	CLUTCH CABLE	1476638080 , 1480346080 , 2150 J0 , 2150 T1	24.3728-0326.2

New partnumbers on stock - according to applications

02/2008



					Description	OE numbers per ATE pn.		e.g. replaced pn. / miscellaneous
--	--	--	--	--	-------------	------------------------	--	-----------------------------------

PEUGEOT

EXPERT Van (95-)	1,9 TD		10.1995		24.3728-0342.2	590342	CLUTCH CABLE	1476638080 , 1480346080 , 2150 J0 , 2150 T1	24.3728-0326.2
EXPERT Estate (95-)			04.1996		24.3728-0342.2	590342	CLUTCH CABLE	1476638080 , 1480346080 , 2150 J0 , 2150 T1	24.3728-0326.2
			10.1995		24.3728-0342.2	590342	CLUTCH CABLE	1476638080 , 1480346080 , 2150 J0 , 2150 T1	24.3728-0326.2
EXPERT Pickup/Chassis (95-)			10.1995		24.3728-0342.2	590342	CLUTCH CABLE	1476638080 , 1480346080 , 2150 J0 , 2150 T1	24.3728-0326.2







PORSCHE

911 (993) (93-97)	3,6 TURBO 4	FL	03.1995	09.1997	24.0132-0163.2	432163	BRAKE DISC LEFT	993 351 045 10	
		FR	03.1995	09.1997	24.0132-0164.2	432164	BRAKE DISC RIGHT	993 351 046 10	
	3,6 TURBO GT2	FL	03.1995	09.1997	24.0132-0163.2	432163	BRAKE DISC LEFT	993 351 045 10	
		FR	03.1995	09.1997	24.0132-0164.2	432164	BRAKE DISC RIGHT	993 351 046 10	
	3,6 TURBO GT2 4	FL	08.1995	09.1997	24.0132-0163.2	432163	BRAKE DISC LEFT	993 351 045 10	
		FR	08.1995	09.1997	24.0132-0164.2	432164	BRAKE DISC RIGHT	993 351 046 10	

New partnumbers on stock - according to applications

02/2008



					Description	OE numbers per ATE pn.	 e.g. replaced pn. / miscellaneous
---	---	---	---	---	-------------	------------------------	--







RENAULT

CLIO III (BR_/CR_) (05-)	1,2 16V		06.2005		03.2123-2861.3	010774	TANDEM MASTER CYL.	46010-AX701 , 77 01 208 838	
	1,4 16V		06.2005		03.2123-2861.3	010774	TANDEM MASTER CYL.	46010-AX701 , 77 01 208 838	
	1,5 dCi		06.2005		03.2123-2861.3	010774	TANDEM MASTER CYL.	46010-AX701 , 77 01 208 838	
	1,6 16V		06.2005		03.2123-2861.3	010774	TANDEM MASTER CYL.	46010-AX701 , 77 01 208 838	
	2,0 16V Sport		02.2006		13.0460-4805.2	604805	BRAKE PADS	77 01 208 218	see drawing
			02.2006		03.2123-2861.3	010774	TANDEM MASTER CYL.	46010-AX701 , 77 01 208 838	
GRAND SCENIC (04-)	2,0 16V Turbo		04.2004		13.0460-4805.2	604805	BRAKE PADS	77 01 208 218	see drawing
MASTER II Bus (JD/ND_) (98-06)	1,9 dCi 80	FA	11.2001	10.2002	24.0711-6004.3	360231	WHEEL SPEED SENSOR	77 00 302 428	
	1,9 dTi	FA	09.2000	10.2002	24.0711-6004.3	360231	WHEEL SPEED SENSOR	77 00 302 428	
	2,2 dCi 90	FA	09.2000	10.2002	24.0711-6004.3	360231	WHEEL SPEED SENSOR	77 00 302 428	
	2,5 D	FA	07.1998	01.2001	24.0711-6004.3	360231	WHEEL SPEED SENSOR	77 00 302 428	
	2,5 dCi 120	FA	10.2001	10.2002	24.0711-6004.3	360231	WHEEL SPEED SENSOR	77 00 302 428	
	2,8 dTi	FA	07.1998	10.2001	24.0711-6004.3	360231	WHEEL SPEED SENSOR	77 00 302 428	
MASTER II Kasten (FD_) (98-06)	1,9 dCi 80	FA	11.2001	10.2002	24.0711-6004.3	360231	WHEEL SPEED SENSOR	77 00 302 428	
	1,9 dTi	FA	09.2000	10.2002	24.0711-6004.3	360231	WHEEL SPEED SENSOR	77 00 302 428	
	2,2 dCi 90	FA	09.2000	10.2002	24.0711-6004.3	360231	WHEEL SPEED SENSOR	77 00 302 428	
	2,5 D	FA	07.1998	01.2001	24.0711-6004.3	360231	WHEEL SPEED SENSOR	77 00 302 428	
	2,5 dCi 120	FA	10.2001	10.2002	24.0711-6004.3	360231	WHEEL SPEED SENSOR	77 00 302 428	
	2,8 dTi	FA	07.1998	10.2001	24.0711-6004.3	360231	WHEEL SPEED SENSOR	77 00 302 428	

New partnumbers on stock - according to applications

02/2008



					Description	OE numbers per ATE pn.	 e.g. replaced pn. / miscellaneous
---	---	---	---	---	-------------	------------------------	--







RENAULT

MASTER II Pritsche/Fahrgestell (ED/HD/UD_) (98-06)	2,2 dCi 90	FA	09.2000	10.2002	24.0711-6004.3	360231	WHEEL SPEED SENSOR	77 00 302 428	
	2,5 D	FA	07.1998	01.2001	24.0711-6004.3	360231	WHEEL SPEED SENSOR	77 00 302 428	
	2,5 dCi 120	FA	10.2001	10.2002	24.0711-6004.3	360231	WHEEL SPEED SENSOR	77 00 302 428	
	2,8 dTi	FA	07.1998	10.2001	24.0711-6004.3	360231	WHEEL SPEED SENSOR	77 00 302 428	
MEGANE II COUPE/CONVERTIBLE (EM_) (03-)	2,0 16V Turbo		05.2004		13.0460-4805.2	604805	BRAKE PADS	77 01 208 218	see drawing
MEGANE II Saloon 3/5-door(BM_/CM_) (02-)			05.2004		13.0460-4805.2	604805	BRAKE PADS	77 01 208 218	see drawing
	2,0 Sport		05.2004		13.0460-4805.2	604805	BRAKE PADS	77 01 208 218	see drawing
SCENIC II (JM_) (03-)	2,0 16V Turbo		05.2004		13.0460-4805.2	604805	BRAKE PADS	77 01 208 218	see drawing

New partnumbers on stock - according to applications

02/2008



					Description	OE numbers per ATE pn.	 e.g. replaced pn. / miscellaneous
---	---	---	---	---	-------------	------------------------	--







SAAB

9000 (85-93)	2,0 16V	RR	09.1986	08.1989	24.3727-1107.2	581107	HANDBRAKE CABLE	8967499 , 8970741	
		RR	09.1989	08.1993	24.3727-1107.2	581107	HANDBRAKE CABLE	8967499 , 8970741	
	2,0 16V Turbo	RR	09.1986	08.1989	24.3727-1107.2	581107	HANDBRAKE CABLE	8967499 , 8970741	
		RR	09.1989	08.1993	24.3727-1107.2	581107	HANDBRAKE CABLE	8967499 , 8970741	
	2,3 16V	RR	09.1989	08.1993	24.3727-1107.2	581107	HANDBRAKE CABLE	8967499 , 8970741	
	2,3 16V Turbo	RR	09.1989	08.1993	24.3727-1107.2	581107	HANDBRAKE CABLE	8967499 , 8970741	
9000 (94-98)	2,0 16V	RR	09.1996	05.1998	24.3727-1107.2	581107	HANDBRAKE CABLE	8967499 , 8970741	
		RR	09.1993	08.1996	24.3727-1107.2	581107	HANDBRAKE CABLE	8967499 , 8970741	
	2,0 16V Turbo	RR	09.1996	05.1998	24.3727-1107.2	581107	HANDBRAKE CABLE	8967499 , 8970741	
		RR	09.1993	08.1996	24.3727-1107.2	581107	HANDBRAKE CABLE	8967499 , 8970741	
	2,3 16V	RR	09.1996	05.1998	24.3727-1107.2	581107	HANDBRAKE CABLE	8967499 , 8970741	
		RR	09.1993	08.1996	24.3727-1107.2	581107	HANDBRAKE CABLE	8967499 , 8970741	
	2,3 16V Turbo	RR	09.1996	05.1998	24.3727-1107.2	581107	HANDBRAKE CABLE	8967499 , 8970741	
		RR	09.1993	08.1996	24.3727-1107.2	581107	HANDBRAKE CABLE	8967499 , 8970741	
	3,0 V6	RR	09.1996	05.1998	24.3727-1107.2	581107	HANDBRAKE CABLE	8967499 , 8970741	
		RR	09.1994	08.1996	24.3727-1107.2	581107	HANDBRAKE CABLE	8967499 , 8970741	

New partnumbers on stock - according to applications

02/2008



					Description	OE numbers per ATE pn.	 e.g. replaced pn. / miscellaneous
---	---	---	---	---	-------------	------------------------	--







SEAT

ALTEA (5P1) (04-)	1,4 TSI		11.2007		03.7863-9502.4	300204	BOOSTER UNIT T52	1K1 614 106 N , 1K1 614 106 H , 1K1 614 106 D	
	1,6 i 16V		03.2004		03.7863-9502.4	300204	BOOSTER UNIT T52	1K1 614 106 N , 1K1 614 106 H , 1K1 614 106 D	
	1,8 TFSI		01.2007		03.7863-9502.4	300204	BOOSTER UNIT T52	1K1 614 106 N , 1K1 614 106 H , 1K1 614 106 D	
	1,9 TDI		03.2004		03.7863-9502.4	300204	BOOSTER UNIT T52	1K1 614 106 N , 1K1 614 106 H , 1K1 614 106 D	
	2,0 FSI		03.2004		03.7863-9502.4	300204	BOOSTER UNIT T52	1K1 614 106 N , 1K1 614 106 H , 1K1 614 106 D	
	2,0 i 16V		03.2004		03.7863-9502.4	300204	BOOSTER UNIT T52	1K1 614 106 N , 1K1 614 106 H , 1K1 614 106 D	
	2,0 TDI		03.2004		03.7863-9502.4	300204	BOOSTER UNIT T52	1K1 614 106 N , 1K1 614 106 H , 1K1 614 106 D	
			03.2006		03.7863-9502.4	300204	BOOSTER UNIT T52	1K1 614 106 N , 1K1 614 106 H , 1K1 614 106 D	
	2,0 TFSI		03.2006		03.7863-9502.4	300204	BOOSTER UNIT T52	1K1 614 106 N , 1K1 614 106 H , 1K1 614 106 D	
ALTEA XL (5P5) (06-)	1,4 TSI		11.2007		03.7863-9502.4	300204	BOOSTER UNIT T52	1K1 614 106 N , 1K1 614 106 H , 1K1 614 106 D	
	1,6 i 16V		10.2006		03.7863-9502.4	300204	BOOSTER UNIT T52	1K1 614 106 N , 1K1 614 106 H , 1K1 614 106 D	
	1,8 TFSI		10.2006		03.7863-9502.4	300204	BOOSTER UNIT T52	1K1 614 106 N , 1K1 614 106 H , 1K1 614 106 D	
	1,9 TDI		10.2006		03.7863-9502.4	300204	BOOSTER UNIT T52	1K1 614 106 N , 1K1 614 106 H , 1K1 614 106 D	

New partnumbers on stock - according to applications

02/2008



					Description	OE numbers per ATE pn.	 e.g. replaced pn. / miscellaneous
---	---	---	---	---	--------------------	-------------------------------	--

SEAT

ALTEA XL (5P5) (06-)	2,0 FSI		10.2006		03.7863-9502.4	300204	BOOSTER UNIT T52	1K1 614 106 N , 1K1 614 106 H , 1K1 614 106 D	
	2,0 TDI		10.2006		03.7863-9502.4	300204	BOOSTER UNIT T52	1K1 614 106 N , 1K1 614 106 H , 1K1 614 106 D	
	2,0 TDI 4x4		06.2007		03.7863-9502.4	300204	BOOSTER UNIT T52	1K1 614 106 N , 1K1 614 106 H , 1K1 614 106 D	
	2,0 TFSI 4x4		06.2007		03.7863-9502.4	300204	BOOSTER UNIT T52	1K1 614 106 N , 1K1 614 106 H , 1K1 614 106 D	
LEON II (1P1) (05-)	1,4 i 16V		08.2005		03.7863-9502.4	300204	BOOSTER UNIT T52	1K1 614 106 N , 1K1 614 106 H , 1K1 614 106 D	
	1,4 TSI		11.2007		03.7863-9502.4	300204	BOOSTER UNIT T52	1K1 614 106 N , 1K1 614 106 H , 1K1 614 106 D	
	1,6 i		08.2005		03.7863-9502.4	300204	BOOSTER UNIT T52	1K1 614 106 N , 1K1 614 106 H , 1K1 614 106 D	
	1,6 i 16V		08.2005		03.7863-9502.4	300204	BOOSTER UNIT T52	1K1 614 106 N , 1K1 614 106 H , 1K1 614 106 D	
	1,8 T 20V		08.2005		03.7863-9502.4	300204	BOOSTER UNIT T52	1K1 614 106 N , 1K1 614 106 H , 1K1 614 106 D	
	1,8 TFSI		06.2007		03.7863-9502.4	300204	BOOSTER UNIT T52	1K1 614 106 N , 1K1 614 106 H , 1K1 614 106 D	
	1,9 TDI		08.2005		03.7863-9502.4	300204	BOOSTER UNIT T52	1K1 614 106 N , 1K1 614 106 H , 1K1 614 106 D	
	2,0 FSI		08.2005		03.7863-9502.4	300204	BOOSTER UNIT T52	1K1 614 106 N , 1K1 614 106 H , 1K1 614 106 D	
	2,0 i 16V		08.2005		03.7863-9502.4	300204	BOOSTER UNIT T52	1K1 614 106 N , 1K1 614 106 H , 1K1 614 106 D	

New partnumbers on stock - according to applications

02/2008



					Description	OE numbers per ATE pn.		e.g. replaced pn. / miscellaneous
--	--	--	--	--	-------------	------------------------	--	-----------------------------------





SEAT

LEON II (1P1) (05-)	2,0 TDI		02.2006		03.7863-9502.4	300204	BOOSTER UNIT T52	1K1 614 106 N , 1K1 614 106 H , 1K1 614 106 D	
			08.2005		03.7863-9502.4	300204	BOOSTER UNIT T52	1K1 614 106 N , 1K1 614 106 H , 1K1 614 106 D	
	2,0 TFSI		08.2005		03.7863-9502.4	300204	BOOSTER UNIT T52	1K1 614 106 N , 1K1 614 106 H , 1K1 614 106 D	
TOLEDO III (5P2) (05-)	1,6 i 16V		10.2004		03.7863-9502.4	300204	BOOSTER UNIT T52	1K1 614 106 N , 1K1 614 106 H , 1K1 614 106 D	
	1,8 TFSI		01.2007		03.7863-9502.4	300204	BOOSTER UNIT T52	1K1 614 106 N , 1K1 614 106 H , 1K1 614 106 D	
	1,9 TDI		10.2004		03.7863-9502.4	300204	BOOSTER UNIT T52	1K1 614 106 N , 1K1 614 106 H , 1K1 614 106 D	
	2,0 FSI		10.2004		03.7863-9502.4	300204	BOOSTER UNIT T52	1K1 614 106 N , 1K1 614 106 H , 1K1 614 106 D	
	2,0 i 16V		10.2004		03.7863-9502.4	300204	BOOSTER UNIT T52	1K1 614 106 N , 1K1 614 106 H , 1K1 614 106 D	
	2,0 TDI		10.2004		03.7863-9502.4	300204	BOOSTER UNIT T52	1K1 614 106 N , 1K1 614 106 H , 1K1 614 106 D	

New partnumbers on stock - according to applications

02/2008



	i				Description	OE numbers per ATE pn.	i e.g. replaced pn. / miscellaneous
---	----------	---	---	---	--------------------	-------------------------------	---







SKODA

OCTAVIA II (1Z) (04-)	1,4 i 16V		06.2004		03.7863-9502.4	300204	BOOSTER UNIT T52	1K1 614 106 N , 1K1 614 106 H , 1K1 614 106 D	
	1,6 FSI		06.2004		03.7863-9502.4	300204	BOOSTER UNIT T52	1K1 614 106 N , 1K1 614 106 H , 1K1 614 106 D	
	1,6 i 16V		06.2004		03.7863-9502.4	300204	BOOSTER UNIT T52	1K1 614 106 N , 1K1 614 106 H , 1K1 614 106 D	
	1,9 TDI		06.2004		03.7863-9502.4	300204	BOOSTER UNIT T52	1K1 614 106 N , 1K1 614 106 H , 1K1 614 106 D	
	2,0 FSI		11.2004		03.7863-9502.4	300204	BOOSTER UNIT T52	1K1 614 106 N , 1K1 614 106 H , 1K1 614 106 D	
	2,0 TDI		06.2004		03.7863-9502.4	300204	BOOSTER UNIT T52	1K1 614 106 N , 1K1 614 106 H , 1K1 614 106 D	

New partnumbers on stock - according to applications

02/2008



					Description	OE numbers per ATE pn.	 e.g. replaced pn. / miscellaneous
---	---	---	---	---	-------------	------------------------	--







SUBARU

FORESTER (97-02)	2		07.1998	09.2002	13.0460-5851.2	605851	BRAKE PADS	26296AC041 , 26296AE210 , 26298AE081	see drawing
			08.1997	09.2002	13.0460-5851.2	605851	BRAKE PADS	26296AC041 , 26296AE210 , 26298AE081	see drawing
	2,0 S Turbo		07.1998	04.2001	13.0460-5851.2	605851	BRAKE PADS	26296AC041 , 26296AE210 , 26298AE081	see drawing
IMPREZA Kombi (00-05)	2,0 GX (GG)		12.2000	09.2005	13.0460-5851.2	605851	BRAKE PADS	26296AC041 , 26296AE210 , 26298AE081	see drawing
IMPREZA Estate (93-00)	2,0 Turbo 4WD (GF8)		08.1996	12.2000	13.0460-5851.2	605851	BRAKE PADS	26296AC041 , 26296AE210 , 26298AE081	see drawing
IMPREZA Limousine (00-05)	2,0 GX (GD)		12.2000		13.0460-5851.2	605851	BRAKE PADS	26296AC041 , 26296AE210 , 26298AE081	see drawing
	2,5 RSi (GD)		03.2001		13.0460-5851.2	605851	BRAKE PADS	26296AC041 , 26296AE210 , 26298AE081	see drawing
IMPREZA Saloon (93-00)	2,0 Turbo 4WD (GC8)		08.1996	12.2000	13.0460-5851.2	605851	BRAKE PADS	26296AC041 , 26296AE210 , 26298AE081	see drawing
LEGACY (99-03)	2,5 i 16V (BE/BH9A)		10.1998	08.2003	13.0460-5851.2	605851	BRAKE PADS	26296AC041 , 26296AE210 , 26298AE081	see drawing
LEGACY Estate (94-98)	2,5 4WD (BG9)		06.1996	11.1998	13.0460-5851.2	605851	BRAKE PADS	26296AC041 , 26296AE210 , 26298AE081	see drawing
LEGACY Saloon (94-99)	2,5 4WD (BD9)		06.1996	03.1999	13.0460-5851.2	605851	BRAKE PADS	26296AC041 , 26296AE210 , 26298AE081	see drawing
OUTBACK (00-03)	2,5		10.2000	10.2003	13.0460-5851.2	605851	BRAKE PADS	26296AC041 , 26296AE210 , 26298AE081	see drawing
	3,0 H6		10.2000	10.2003	13.0460-5851.2	605851	BRAKE PADS	26296AC041 , 26296AE210 , 26298AE081	see drawing

New partnumbers on stock - according to applications

02/2008



					Description	OE numbers per ATE pn.	 e.g. replaced pn. / miscellaneous
---	---	---	---	---	-------------	------------------------	--







SUZUKI

IGNIS I (00-03)	1,3 i 16V		10.2000	08.2003	13.0460-5887.2	605887	BRAKE PADS	55810-80G00 , 55810-80G02 , 55810-80G12 , 55810-60J10 , 55810-80G04 , 55810-80G13 , 55810-60J00	see drawing
	1,3 i 16V 4x4		10.2000	08.2003	13.0460-5887.2	605887	BRAKE PADS	55810-80G00 , 55810-80G02 , 55810-80G12 , 55810-60J10 , 55810-80G04 , 55810-80G13 , 55810-60J00	see drawing
	1,3 Sport		10.2000	08.2003	13.0460-5887.2	605887	BRAKE PADS	55810-80G00 , 55810-80G02 , 55810-80G12 , 55810-60J10 , 55810-80G04 , 55810-80G13 , 55810-60J00	see drawing
IGNIS II (03-)	1,5 Sport		12.2003		13.0460-5887.2	605887	BRAKE PADS	55810-80G00 , 55810-80G02 , 55810-80G12 , 55810-60J10 , 55810-80G04 , 55810-80G13 , 55810-60J00	see drawing
LIANA (01-)	1,3 i 16V		03.2002		13.0460-5888.2	605888	BRAKE PADS	55810-54G00 , 55810-54G50 , 55810-54G61 , 55810-54G60	see drawing
	1,4 DDIS		03.2005		13.0460-5888.2	605888	BRAKE PADS	55810-54G00 , 55810-54G50 , 55810-54G61 , 55810-54G60	see drawing
	1,6 i 16V		03.2002		13.0460-5888.2	605888	BRAKE PADS	55810-54G00 , 55810-54G50 , 55810-54G61 , 55810-54G60	see drawing
			04.2002		13.0460-5888.2	605888	BRAKE PADS	55810-54G00 , 55810-54G50 , 55810-54G61 , 55810-54G60	see drawing
	1,6 i 16V 4WD		03.2002		13.0460-5888.2	605888	BRAKE PADS	55810-54G00 , 55810-54G50 , 55810-54G61 , 55810-54G60	see drawing
			04.2002		13.0460-5888.2	605888	BRAKE PADS	55810-54G00 , 55810-54G50 , 55810-54G61 , 55810-54G60	see drawing

New partnumbers on stock - according to applications

02/2008



					Description	OE numbers per ATE pn.	 e.g. replaced pn. / miscellaneous
---	---	---	---	---	-------------	------------------------	---







TOYOTA

AVENSIS (03-)	1,6 i 16V		04.2003		03.0137-9294.2	669294	BRAKE SHOE ACC.		
	1,8 i 16V		04.2003		03.0137-9294.2	669294	BRAKE SHOE ACC.		
	2,0 D-4D		03.2006		03.0137-9294.2	669294	BRAKE SHOE ACC.		
			04.2003		03.0137-9294.2	669294	BRAKE SHOE ACC.		
	2,0 i 16V		04.2003		03.0137-9294.2	669294	BRAKE SHOE ACC.		
	2,2 D-4D		10.2005		03.0137-9294.2	669294	BRAKE SHOE ACC.		
	2,2 D-CAT		07.2005		03.0137-9294.2	669294	BRAKE SHOE ACC.		
	2,4 i 16V		10.2003		03.0137-9294.2	669294	BRAKE SHOE ACC.		
			09.2003		03.0137-9294.2	669294	BRAKE SHOE ACC.		
AVENSIS (97-03)	1,6 VVTi (ZZT220)	RL	07.2001	02.2003	24.3727-1916.2	581916	HANDBRAKE CABLE	46430-20640	
		RR	07.2001	02.2003	24.3727-1915.2	581915	HANDBRAKE CABLE	46420-20520	
	1,8 VVTi (ZZT221)	RL	07.2001	02.2003	24.3727-1916.2	581916	HANDBRAKE CABLE	46430-20640	
		RR	07.2001	02.2003	24.3727-1915.2	581915	HANDBRAKE CABLE	46420-20520	
	2,0 D4-D (CDT221)	RR	07.2001	02.2003	24.3727-1915.2	581915	HANDBRAKE CABLE	46420-20520	
		RL	07.2001	02.2003	24.3727-1916.2	581916	HANDBRAKE CABLE	46430-20640	
	2,0 i 16V (ST220)	RR	07.2001	02.2003	24.3727-1915.2	581915	HANDBRAKE CABLE	46420-20520	
		RL	07.2001	02.2003	24.3727-1916.2	581916	HANDBRAKE CABLE	46430-20640	
	2,0 TD (CT220)	RL	07.2001	02.2003	24.3727-1916.2	581916	HANDBRAKE CABLE	46430-20640	
		RR	07.2001	02.2003	24.3727-1915.2	581915	HANDBRAKE CABLE	46420-20520	
	2,0 VVTi (AZT220)	RL	07.2001	02.2003	24.3727-1916.2	581916	HANDBRAKE CABLE	46430-20640	

New partnumbers on stock - according to applications

02/2008



					Description	OE numbers per ATE pn.	 e.g. replaced pn. / miscellaneous
---	---	---	---	---	-------------	------------------------	--







TOYOTA

Model	Engine	RR	07.2001	02.2003	24.3727-1915.2	581915	Description	46420-20520	
AVENSIS (97-03)	2,0 VVTi (AZT220)	RR	07.2001	02.2003	24.3727-1915.2	581915	HANDBRAKE CABLE	46420-20520	
CELICA (99-)	1,8 VVTi (ZZT230)		11.1999		24.0109-0711.1	409711	BRAKE DISC	42431-47030 , 42431-20420 , 42431-20390	
			11.1999		03.0137-9294.2	669294	BRAKE SHOE ACC.		
	1,8 VVTi TS (ZZT231)		11.1999		24.0109-0711.1	409711	BRAKE DISC	42431-47030 , 42431-20420 , 42431-20390	
			11.1999		03.0137-9294.2	669294	BRAKE SHOE ACC.		
COROLLA (02-04)	1,4 VVTi (ZZE120)		01.2002	05.2004	03.0137-9294.2	669294	BRAKE SHOE ACC.		
	1,6 VVTi (ZZE121)		01.2002	05.2004	03.0137-9294.2	669294	BRAKE SHOE ACC.		
	2,0 D-4D (CDE120)		01.2002	05.2004	03.0137-9294.2	669294	BRAKE SHOE ACC.		
COROLLA VERSO (02-04)	1,4 VVTi (ZZE120)		01.2002	05.2004	03.0137-9294.2	669294	BRAKE SHOE ACC.		
	1,6 VVTi (ZZE121)		01.2002	05.2004	03.0137-9294.2	669294	BRAKE SHOE ACC.		
	1,8 VVTi (ZZE122)		01.2002	05.2004	03.0137-9294.2	669294	BRAKE SHOE ACC.		
	2,0 D-4D (CDE120)		01.2002	05.2004	03.0137-9294.2	669294	BRAKE SHOE ACC.		
LAND CRUISER 100 (98-)	4,2 TDi (HDJ100)		01.1998		24.0118-0143.1	418143	BRAKE DISC	42431-60221 , 42431-60280 , 42431-60220 , 42431-60281	
	4,7 V8 (UZJ100)		01.1998		24.0118-0143.1	418143	BRAKE DISC	42431-60221 , 42431-60280 , 42431-60220 , 42431-60281	
PRIUS (00-03)	1,5 i 16V (NHW11)		05.2000	07.2003	03.0137-9294.2	669294	BRAKE SHOE ACC.		
PRIUS (03-)	1,5 VVTi (NHW20)		08.2003		24.0109-0711.1	409711	BRAKE DISC	42431-47030 , 42431-20420 , 42431-20390	
			08.2003		03.0137-9294.2	669294	BRAKE SHOE ACC.		
YARIS (99-)	1,0 i 16V		04.2003		03.0137-9294.2	669294	BRAKE SHOE ACC.		

New partnumbers on stock - according to applications

02/2008



					Description	OE numbers per ATE pn.	 e.g. replaced pn. / miscellaneous
---	---	---	---	---	-------------	------------------------	--







TOYOTA

Model	Engine	Start	End	ATE Part Number	ATE Part Number	Description	OE numbers per ATE pn.	Notes
YARIS (99-)	1,0 i 16V	08.1999	03.2003	03.0137-9294.2	669294	BRAKE SHOE ACC.		
	1,3 i 16V	09.1999	10.2004	03.0137-9294.2	669294	BRAKE SHOE ACC.		
		04.2002		03.0137-9294.2	669294	BRAKE SHOE ACC.		
	1,4 D-4D	12.2001	03.2003	03.0137-9294.2	669294	BRAKE SHOE ACC.		
	1,5 VVTi Sport	04.2001		03.0137-9294.2	669294	BRAKE SHOE ACC.		
		01.2003		03.0137-9294.2	669294	BRAKE SHOE ACC.		
	1,5 VVTi Turbo Sport	04.2003	10.2004	03.0137-9294.2	669294	BRAKE SHOE ACC.		
YARIS VERSO (99-)	1,3 i 16V	11.1999		03.0137-9294.2	669294	BRAKE SHOE ACC.		
		08.2000		03.0137-9294.2	669294	BRAKE SHOE ACC.		
	1,4 D-4D	12.2001		03.0137-9294.2	669294	BRAKE SHOE ACC.		
	1,5 VVTi	05.2003		03.0137-9294.2	669294	BRAKE SHOE ACC.		
	1,5 VVTi Sport	03.2000		03.0137-9294.2	669294	BRAKE SHOE ACC.		

New partnumbers on stock - according to applications

02/2008



					Description	OE numbers per ATE pn.	 e.g. replaced pn. / miscellaneous
---	---	---	---	---	-------------	------------------------	--

VOLKSWAGEN

EOS (06-)	1,6 FSI		05.2006		03.7863-9502.4	300204	BOOSTER UNIT T52	1K1 614 106 N , 1K1 614 106 H , 1K1 614 106 D	
	2,0 FSI		05.2006		03.7863-9502.4	300204	BOOSTER UNIT T52	1K1 614 106 N , 1K1 614 106 H , 1K1 614 106 D	
	2,0 TDI		05.2006		03.7863-9502.4	300204	BOOSTER UNIT T52	1K1 614 106 N , 1K1 614 106 H , 1K1 614 106 D	
	2,0 TFSI		05.2006		03.7863-9502.4	300204	BOOSTER UNIT T52	1K1 614 106 N , 1K1 614 106 H , 1K1 614 106 D	
	3,2 FSI		05.2006		03.7863-9502.4	300204	BOOSTER UNIT T52	1K1 614 106 N , 1K1 614 106 H , 1K1 614 106 D	
GOLF IV (98-03)	3,2 R32 4motion	FL	06.2002	10.2003	24.0132-0166.2	432166	BRAKE DISC LEFT	8N0 615 301 B , 1J0 615 301 AA	
		FR	06.2002	10.2003	24.0132-0165.2	432165	BRAKE DISC RIGHT	8N0 615 302 B , 1J0 615 302 A	
GOLF V (03-)	1,4 16V		10.2003		03.7863-9502.4	300204	BOOSTER UNIT T52	1K1 614 106 N , 1K1 614 106 H , 1K1 614 106 D	
	1,4 FSI		10.2003		03.7863-9502.4	300204	BOOSTER UNIT T52	1K1 614 106 N , 1K1 614 106 H , 1K1 614 106 D	
	1,4 TSI		11.2005		03.7863-9502.4	300204	BOOSTER UNIT T52	1K1 614 106 N , 1K1 614 106 H , 1K1 614 106 D	
			05.2006		03.7863-9502.4	300204	BOOSTER UNIT T52	1K1 614 106 N , 1K1 614 106 H , 1K1 614 106 D	
			05.2007		03.7863-9502.4	300204	BOOSTER UNIT T52	1K1 614 106 N , 1K1 614 106 H , 1K1 614 106 D	
	1,6 16V		01.2004		03.7863-9502.4	300204	BOOSTER UNIT T52	1K1 614 106 N , 1K1 614 106 H , 1K1 614 106 D	

New partnumbers on stock - according to applications

02/2008



					Description	OE numbers per ATE pn.		e.g. replaced pn. / miscellaneous
--	--	--	--	--	-------------	------------------------	--	-----------------------------------





VOLKSWAGEN

GOLF V (03-)	1,6 FSI		10.2003		03.7863-9502.4	300204	BOOSTER UNIT T52	1K1 614 106 N , 1K1 614 106 H , 1K1 614 106 D	
	1,9 TDI		05.2004		03.7863-9502.4	300204	BOOSTER UNIT T52	1K1 614 106 N , 1K1 614 106 H , 1K1 614 106 D	
			10.2003		03.7863-9502.4	300204	BOOSTER UNIT T52	1K1 614 106 N , 1K1 614 106 H , 1K1 614 106 D	
	2,0 FSI		10.2003		03.7863-9502.4	300204	BOOSTER UNIT T52	1K1 614 106 N , 1K1 614 106 H , 1K1 614 106 D	
	2,0 SDI		01.2004		03.7863-9502.4	300204	BOOSTER UNIT T52	1K1 614 106 N , 1K1 614 106 H , 1K1 614 106 D	
	2,0 TDI		10.2003		03.7863-9502.4	300204	BOOSTER UNIT T52	1K1 614 106 N , 1K1 614 106 H , 1K1 614 106 D	
			11.2005		03.7863-9502.4	300204	BOOSTER UNIT T52	1K1 614 106 N , 1K1 614 106 H , 1K1 614 106 D	
GOLF V Plus (05-)	1,4 16V		01.2005		03.7863-9502.4	300204	BOOSTER UNIT T52	1K1 614 106 N , 1K1 614 106 H , 1K1 614 106 D	
	1,4 TSI		05.2006		03.7863-9502.4	300204	BOOSTER UNIT T52	1K1 614 106 N , 1K1 614 106 H , 1K1 614 106 D	
			06.2007		03.7863-9502.4	300204	BOOSTER UNIT T52	1K1 614 106 N , 1K1 614 106 H , 1K1 614 106 D	
	1,6		05.2005		03.7863-9502.4	300204	BOOSTER UNIT T52	1K1 614 106 N , 1K1 614 106 H , 1K1 614 106 D	
	1,6 FSI		01.2005		03.7863-9502.4	300204	BOOSTER UNIT T52	1K1 614 106 N , 1K1 614 106 H , 1K1 614 106 D	
	1,9 TDI		01.2005		03.7863-9502.4	300204	BOOSTER UNIT T52	1K1 614 106 N , 1K1 614 106 H , 1K1 614 106 D	

New partnumbers on stock - according to applications

02/2008



				Description	OE numbers per ATE pn.	 e.g. replaced pn. / miscellaneous
---	---	--	---	--------------------	-------------------------------	--

VOLKSWAGEN

GOLF V Plus (05-)	1,9 TDI		05.2005		03.7863-9502.4	300204	BOOSTER UNIT T52	1K1 614 106 N , 1K1 614 106 H , 1K1 614 106 D	
	2,0 FSI		05.2005		03.7863-9502.4	300204	BOOSTER UNIT T52	1K1 614 106 N , 1K1 614 106 H , 1K1 614 106 D	
	2,0 TDI		05.2005		03.7863-9502.4	300204	BOOSTER UNIT T52	1K1 614 106 N , 1K1 614 106 H , 1K1 614 106 D	
			01.2005		03.7863-9502.4	300204	BOOSTER UNIT T52	1K1 614 106 N , 1K1 614 106 H , 1K1 614 106 D	

New partnumbers on stock - according to applications

02/2008



					Description	OE numbers per ATE pn.		e.g. replaced pn. / miscellaneous
--	--	--	--	--	-------------	------------------------	--	-----------------------------------







VOLVO

740 Estate (85-92)	2		09.1991	07.1992	03.2023-0874.3	010771	TANDEM MASTER CYL.	3530352 , 6819771	03.2023-0872.3
	2,3		07.1989	07.1992	03.2023-0874.3	010771	TANDEM MASTER CYL.	3530352 , 6819771	03.2023-0872.3
			09.1991	07.1992	03.2023-0874.3	010771	TANDEM MASTER CYL.	3530352 , 6819771	03.2023-0872.3
	2,4 TD		09.1991	07.1992	03.2023-0874.3	010771	TANDEM MASTER CYL.	3530352 , 6819771	03.2023-0872.3
740 Saloon (83-92)	2		09.1991	07.1992	03.2023-0874.3	010771	TANDEM MASTER CYL.	3530352 , 6819771	03.2023-0872.3
	2,3		09.1991	07.1992	03.2023-0874.3	010771	TANDEM MASTER CYL.	3530352 , 6819771	03.2023-0872.3
	2,4 D		09.1991	07.1992	03.2023-0874.3	010771	TANDEM MASTER CYL.	3530352 , 6819771	03.2023-0872.3
940 I Estate (90-95)	2		01.1992	07.1994	03.2023-0874.3	010771	TANDEM MASTER CYL.	3530352 , 6819771	03.2023-0872.3
	2,0 T		01.1992	07.1995	03.2023-0874.3	010771	TANDEM MASTER CYL.	3530352 , 6819771	03.2023-0872.3
	2,3		01.1992	07.1994	03.2023-0874.3	010771	TANDEM MASTER CYL.	3530352 , 6819771	03.2023-0872.3
			08.1992	07.1994	03.2023-0874.3	010771	TANDEM MASTER CYL.	3530352 , 6819771	03.2023-0872.3
	2,3 T		01.1992	07.1994	03.2023-0874.3	010771	TANDEM MASTER CYL.	3530352 , 6819771	03.2023-0872.3
			01.1992	07.1993	03.2023-0874.3	010771	TANDEM MASTER CYL.	3530352 , 6819771	03.2023-0872.3
	2,4 D		01.1992	07.1995	03.2023-0874.3	010771	TANDEM MASTER CYL.	3530352 , 6819771	03.2023-0872.3
	2,4 TD		01.1992	07.1994	03.2023-0874.3	010771	TANDEM MASTER CYL.	3530352 , 6819771	03.2023-0872.3
	2,4 TD Intercooler		01.1992	07.1994	03.2023-0874.3	010771	TANDEM MASTER CYL.	3530352 , 6819771	03.2023-0872.3
940 I Saloon (90-95)	2		01.1992	07.1994	03.2023-0874.3	010771	TANDEM MASTER CYL.	3530352 , 6819771	03.2023-0872.3
	2,0 T		01.1992	07.1995	03.2023-0874.3	010771	TANDEM MASTER CYL.	3530352 , 6819771	03.2023-0872.3
	2,3		08.1992	07.1994	03.2023-0874.3	010771	TANDEM MASTER CYL.	3530352 , 6819771	03.2023-0872.3

New partnumbers on stock - according to applications

02/2008



					Description	OE numbers per ATE pn.	 e.g. replaced pn. / miscellaneous
---	---	---	---	---	-------------	------------------------	--

VOLVO

Model	Engine	Start	End	ATE Part No.	ATE Part No.	Description	OE numbers	Notes
940 I Saloon (90-95)	2,3	01.1992	12.1994	03.2023-0874.3	010771	TANDEM MASTER CYL.	3530352 , 6819771	03.2023-0872.3
	2,3 T	01.1992	07.1993	03.2023-0874.3	010771	TANDEM MASTER CYL.	3530352 , 6819771	03.2023-0872.3
		01.1992	07.1994	03.2023-0874.3	010771	TANDEM MASTER CYL.	3530352 , 6819771	03.2023-0872.3
	2,4 D	01.1992	12.1994	03.2023-0874.3	010771	TANDEM MASTER CYL.	3530352 , 6819771	03.2023-0872.3
	2,4 TD	01.1992	12.1994	03.2023-0874.3	010771	TANDEM MASTER CYL.	3530352 , 6819771	03.2023-0872.3
	2,4 TD Intercooler	01.1992	12.1994	03.2023-0874.3	010771	TANDEM MASTER CYL.	3530352 , 6819771	03.2023-0872.3
940 II Estate (95-98)	2,0 T	04.1996	10.1998	03.2023-0874.3	010771	TANDEM MASTER CYL.	3530352 , 6819771	03.2023-0872.3
	2,3	08.1994	07.1995	03.2023-0874.3	010771	TANDEM MASTER CYL.	3530352 , 6819771	03.2023-0872.3
		08.1994	10.1998	03.2023-0874.3	010771	TANDEM MASTER CYL.	3530352 , 6819771	03.2023-0872.3
	2,3 T	08.1995	10.1998	03.2023-0874.3	010771	TANDEM MASTER CYL.	3530352 , 6819771	03.2023-0872.3
		08.1994	10.1998	03.2023-0874.3	010771	TANDEM MASTER CYL.	3530352 , 6819771	03.2023-0872.3
	2,3 ti	01.1995	10.1998	03.2023-0874.3	010771	TANDEM MASTER CYL.	3530352 , 6819771	03.2023-0872.3
	2,4 TD Intercooler	08.1994	10.1998	03.2023-0874.3	010771	TANDEM MASTER CYL.	3530352 , 6819771	03.2023-0872.3
940 II Saloon (95-98)	2,0 T	04.1996	10.1998	03.2023-0874.3	010771	TANDEM MASTER CYL.	3530352 , 6819771	03.2023-0872.3
	2,3	08.1994	07.1995	03.2023-0874.3	010771	TANDEM MASTER CYL.	3530352 , 6819771	03.2023-0872.3
		08.1994	10.1998	03.2023-0874.3	010771	TANDEM MASTER CYL.	3530352 , 6819771	03.2023-0872.3
	2,3 T	08.1994	10.1998	03.2023-0874.3	010771	TANDEM MASTER CYL.	3530352 , 6819771	03.2023-0872.3
	2,3 ti	01.1995	10.1998	03.2023-0874.3	010771	TANDEM MASTER CYL.	3530352 , 6819771	03.2023-0872.3
	2,4 TD Intercooler	08.1994	10.1998	03.2023-0874.3	010771	TANDEM MASTER CYL.	3530352 , 6819771	03.2023-0872.3

New partnumbers on stock - according to applications

02/2008



					Description	OE numbers per ATE pn.		e.g. replaced pn. / miscellaneous
--	--	--	--	--	-------------	------------------------	--	-----------------------------------







VOLVO

Model	Engine	FL	Start	End	ATE PN	ATE PN	Description	OE numbers	Notes
960 I Estate (90-94)	2		01.1992	08.1993	03.2023-0874.3	010771	TANDEM MASTER CYL.	3530352 , 6819771	03.2023-0872.3
			01.1992	09.1993	03.2023-0874.3	010771	TANDEM MASTER CYL.	3530352 , 6819771	03.2023-0872.3
	2,4 TD Intercooler		01.1992	07.1994	03.2023-0874.3	010771	TANDEM MASTER CYL.	3530352 , 6819771	03.2023-0872.3
	2,9		01.1992	07.1994	03.2023-0874.3	010771	TANDEM MASTER CYL.	3530352 , 6819771	03.2023-0872.3
960 I Saloon (90-94)	2		01.1992	08.1993	03.2023-0874.3	010771	TANDEM MASTER CYL.	3530352 , 6819771	03.2023-0872.3
			01.1992	09.1993	03.2023-0874.3	010771	TANDEM MASTER CYL.	3530352 , 6819771	03.2023-0872.3
	2,4 TD Intercooler		01.1992	07.1994	03.2023-0874.3	010771	TANDEM MASTER CYL.	3530352 , 6819771	03.2023-0872.3
	2,9		01.1992	07.1994	03.2023-0874.3	010771	TANDEM MASTER CYL.	3530352 , 6819771	03.2023-0872.3
960 II Estate (94-96)	2,5		08.1994	12.1996	03.2023-0874.3	010771	TANDEM MASTER CYL.	3530352 , 6819771	03.2023-0872.3
	2,9		08.1994	12.1996	03.2023-0874.3	010771	TANDEM MASTER CYL.	3530352 , 6819771	03.2023-0872.3
960 II Saloon (94-96)	2,5		08.1994	12.1996	03.2023-0874.3	010771	TANDEM MASTER CYL.	3530352 , 6819771	03.2023-0872.3
	2,9		08.1994	12.1996	03.2023-0874.3	010771	TANDEM MASTER CYL.	3530352 , 6819771	03.2023-0872.3
S60 (00-)	2,0 T	FL	09.2001		24.0711-6214.3	360230	WHEEL SPEED SENSOR	9496961 , 30773738	24.0711-6046.3
	2,3 T5	FL	11.2000		24.0711-6214.3	360230	WHEEL SPEED SENSOR	9496961 , 30773738	24.0711-6046.3
	2,4	FL	11.2000		24.0711-6214.3	360230	WHEEL SPEED SENSOR	9496961 , 30773738	24.0711-6046.3
	2,4 Bifuel	FL	06.2002		24.0711-6214.3	360230	WHEEL SPEED SENSOR	9496961 , 30773738	24.0711-6046.3
	2,4 D	FL	09.2005		24.0711-6214.3	360230	WHEEL SPEED SENSOR	9496961 , 30773738	24.0711-6046.3
		FL	12.2001		24.0711-6214.3	360230	WHEEL SPEED SENSOR	9496961 , 30773738	24.0711-6046.3
	2,4 D5	FL	07.2001		24.0711-6214.3	360230	WHEEL SPEED SENSOR	9496961 , 30773738	24.0711-6046.3

New partnumbers on stock - according to applications

02/2008



					Description	OE numbers per ATE pn.	 e.g. replaced pn. / miscellaneous
---	---	---	---	---	-------------	------------------------	--







VOLVO

S60 (00-)	2,4 D5	FL	09.2005		24.0711-6214.3	360230	WHEEL SPEED SENSOR	9496961 , 30773738	24.0711-6046.3
	2,4 T	FL	11.2000		24.0711-6214.3	360230	WHEEL SPEED SENSOR	9496961 , 30773738	24.0711-6046.3
	2,4 T AWD	FL	11.2001		24.0711-6214.3	360230	WHEEL SPEED SENSOR	9496961 , 30773738	24.0711-6046.3
	2,4 T5	FL	04.2004		24.0711-6214.3	360230	WHEEL SPEED SENSOR	9496961 , 30773738	24.0711-6046.3
	2,5 T	FL	02.2004		24.0711-6214.3	360230	WHEEL SPEED SENSOR	9496961 , 30773738	24.0711-6046.3
	2,5 T AWD	FL	04.2004		24.0711-6214.3	360230	WHEEL SPEED SENSOR	9496961 , 30773738	24.0711-6046.3
	R 2,5 T AWD	FL	03.2003		24.0711-6214.3	360230	WHEEL SPEED SENSOR	9496961 , 30773738	24.0711-6046.3
S80 I (98-06)	2	FL		02.2006	24.0711-6214.3	360230	WHEEL SPEED SENSOR	9496961 , 30773738	24.0711-6046.3
	2,0 T	FL		02.2006	24.0711-6214.3	360230	WHEEL SPEED SENSOR	9496961 , 30773738	24.0711-6046.3
		FL	12.1999	02.2006	24.0711-6214.3	360230	WHEEL SPEED SENSOR	9496961 , 30773738	24.0711-6046.3
	2,4	FL		02.2006	24.0711-6214.3	360230	WHEEL SPEED SENSOR	9496961 , 30773738	24.0711-6046.3
	2,4 Bifuel	FL	09.2001	02.2006	24.0711-6214.3	360230	WHEEL SPEED SENSOR	9496961 , 30773738	24.0711-6046.3
	2,4 D	FL	10.2001	02.2006	24.0711-6214.3	360230	WHEEL SPEED SENSOR	9496961 , 30773738	24.0711-6046.3
	2,4 D5	FL	08.2001	02.2006	24.0711-6214.3	360230	WHEEL SPEED SENSOR	9496961 , 30773738	24.0711-6046.3
	2,4 T	FL	06.2000	02.2006	24.0711-6214.3	360230	WHEEL SPEED SENSOR	9496961 , 30773738	24.0711-6046.3
	2,5 T	FL	07.2003	02.2006	24.0711-6214.3	360230	WHEEL SPEED SENSOR	9496961 , 30773738	24.0711-6046.3
	2,5 TDI	FL		02.2006	24.0711-6214.3	360230	WHEEL SPEED SENSOR	9496961 , 30773738	24.0711-6046.3
	2,8 T6	FL		02.2006	24.0711-6214.3	360230	WHEEL SPEED SENSOR	9496961 , 30773738	24.0711-6046.3
	2,9	FL		02.2006	24.0711-6214.3	360230	WHEEL SPEED SENSOR	9496961 , 30773738	24.0711-6046.3

New partnumbers on stock - according to applications

02/2008



					Description	OE numbers per ATE pn.	 e.g. replaced pn. / miscellaneous
---	---	---	---	---	-------------	------------------------	--





VOLVO

Model	Engine	FL	06.2001	02.2006	24.0711-6214.3	360230	WHEEL SPEED SENSOR	9496961 , 30773738	24.0711-6046.3
S80 I (98-06)	3	FL	06.2001	02.2006	24.0711-6214.3	360230	WHEEL SPEED SENSOR	9496961 , 30773738	24.0711-6046.3
	3,0 T6	FL	06.2001	02.2006	24.0711-6214.3	360230	WHEEL SPEED SENSOR	9496961 , 30773738	24.0711-6046.3
S90 (97-98)	2,9		01.1997	05.1998	03.2023-0874.3	010771	TANDEM MASTER CYL.	3530352 , 6819771	03.2023-0872.3
V70 II (00-07)	2,0 T	FL	07.2001		24.0711-6214.3	360230	WHEEL SPEED SENSOR	9496961 , 30773738	24.0711-6046.3
	2,3 T5	FL	03.2000		24.0711-6214.3	360230	WHEEL SPEED SENSOR	9496961 , 30773738	24.0711-6046.3
	2,4	FL	03.2000		24.0711-6214.3	360230	WHEEL SPEED SENSOR	9496961 , 30773738	24.0711-6046.3
	2,4 Bifuel	FL	09.2001		24.0711-6214.3	360230	WHEEL SPEED SENSOR	9496961 , 30773738	24.0711-6046.3
	2,4 D	FL	05.2005		24.0711-6214.3	360230	WHEEL SPEED SENSOR	9496961 , 30773738	24.0711-6046.3
		FL	12.2001		24.0711-6214.3	360230	WHEEL SPEED SENSOR	9496961 , 30773738	24.0711-6046.3
	2,4 D5	FL	08.2001		24.0711-6214.3	360230	WHEEL SPEED SENSOR	9496961 , 30773738	24.0711-6046.3
		FL	12.2005		24.0711-6214.3	360230	WHEEL SPEED SENSOR	9496961 , 30773738	24.0711-6046.3
	2,4 D5 AWD	FL	03.2003		24.0711-6214.3	360230	WHEEL SPEED SENSOR	9496961 , 30773738	24.0711-6046.3
		FL	12.2005		24.0711-6214.3	360230	WHEEL SPEED SENSOR	9496961 , 30773738	24.0711-6046.3
	2,4 T	FL	03.2000		24.0711-6214.3	360230	WHEEL SPEED SENSOR	9496961 , 30773738	24.0711-6046.3
	2,4 T AWD	FL	09.2001		24.0711-6214.3	360230	WHEEL SPEED SENSOR	9496961 , 30773738	24.0711-6046.3
	2,4 T5	FL	04.2004		24.0711-6214.3	360230	WHEEL SPEED SENSOR	9496961 , 30773738	24.0711-6046.3
	2,5 T	FL	04.2004		24.0711-6214.3	360230	WHEEL SPEED SENSOR	9496961 , 30773738	24.0711-6046.3
	2,5 T AWD	FL	09.2002		24.0711-6214.3	360230	WHEEL SPEED SENSOR	9496961 , 30773738	24.0711-6046.3
	2,5 TDI	FL	03.2000		24.0711-6214.3	360230	WHEEL SPEED SENSOR	9496961 , 30773738	24.0711-6046.3

New partnumbers on stock - according to applications

02/2008



	i				Description	OE numbers per ATE pn.	i e.g. replaced pn. / miscellaneous
---	----------	---	---	---	--------------------	-------------------------------	---

VOLVO

Model	Engine	Drive	Start	End	ATE Part No.	ATE Part No.	Description	OE numbers	ATE Part No.
V70 II (00-07)	R 2,5 T AWD	FL	03.2003		24.0711-6214.3	360230	WHEEL SPEED SENSOR	9496961 , 30773738	24.0711-6046.3
V90 (97-98)	2,9		01.1997	12.1998	03.2023-0874.3	010771	TANDEM MASTER CYL.	3530352 , 6819771	03.2023-0872.3
XC70 I CROSS COUNTRY (00-07)	2,4 D5 AWD	FL	12.2005		24.0711-6214.3	360230	WHEEL SPEED SENSOR	9496961 , 30773738	24.0711-6046.3
	2,4 T AWD	FL	09.2000		24.0711-6214.3	360230	WHEEL SPEED SENSOR	9496961 , 30773738	24.0711-6046.3
	2,5 D5 AWD	FL	09.2002		24.0711-6214.3	360230	WHEEL SPEED SENSOR	9496961 , 30773738	24.0711-6046.3
	2,5 T AWD	FL	09.2002		24.0711-6214.3	360230	WHEEL SPEED SENSOR	9496961 , 30773738	24.0711-6046.3
	3,2 AWD	FL	02.2007		24.0711-6214.3	360230	WHEEL SPEED SENSOR	9496961 , 30773738	24.0711-6046.3



13.0460-5874.2 605874

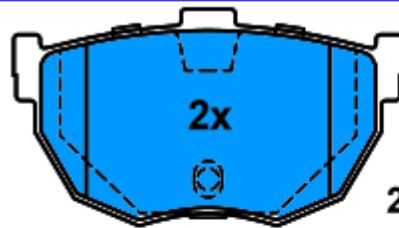
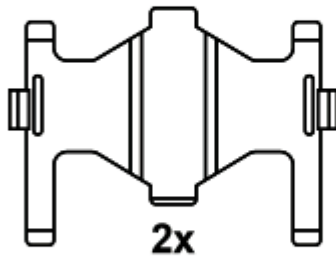

21553 14,7

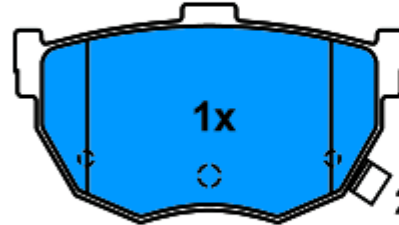

21554 14,7

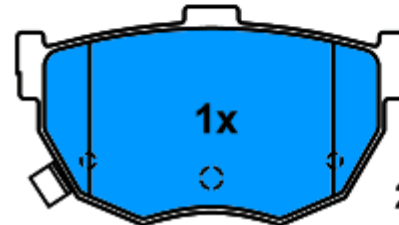

21555 14,7

85,2 x 46,3

Applications:

- KIA CERATO (04-)
- HYUNDAI COUPE (02-)
- HYUNDAI COUPE (96-02)
- HYUNDAI ELANTRA (00-03)
- HYUNDAI ELANTRA (03-06)
- HYUNDAI LANTRA (00-03)
- HYUNDAI LANTRA/ELANTRA (95-00)



13.0460-5888.2 605888

Applications:
SUZUKI LIANA (01-)

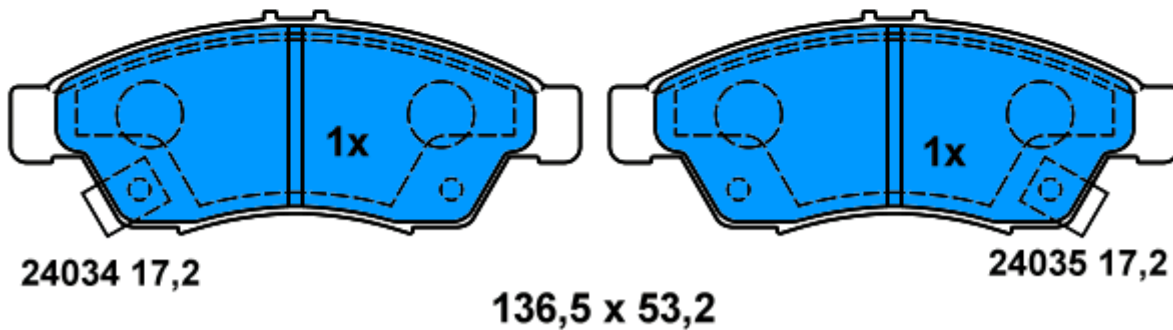
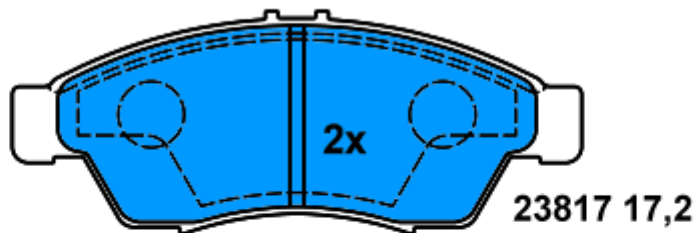



13.0460-5887.2 605887

Applications:

SUZUKI IGNIS I (00-03)
SUZUKI IGNIS II (03-)

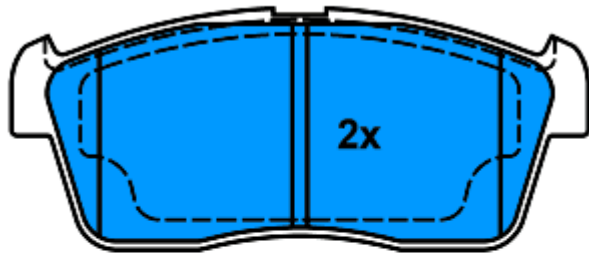

23507 15,6

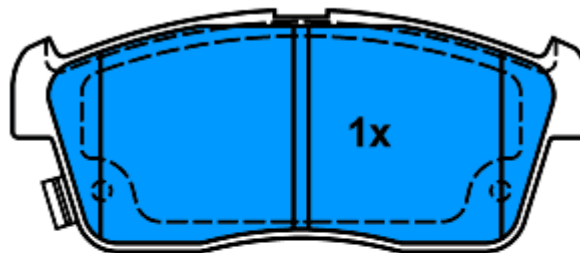

23508 15,6

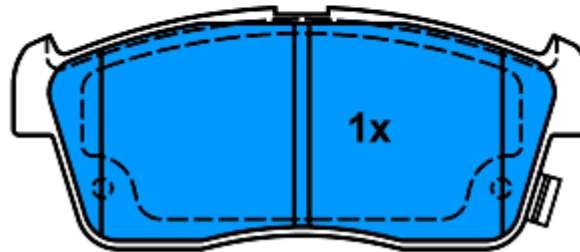

23509 15,6

108,3 x 45,5

Ate

13.0460-5872.2 605872

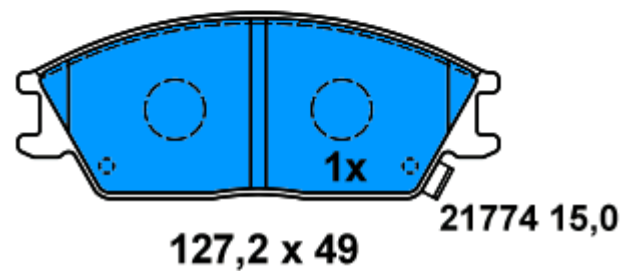
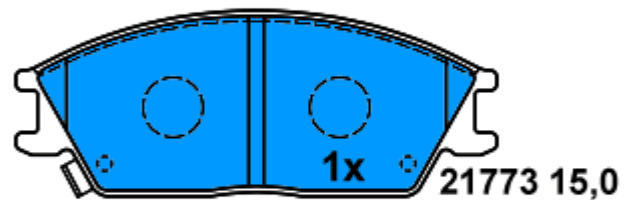
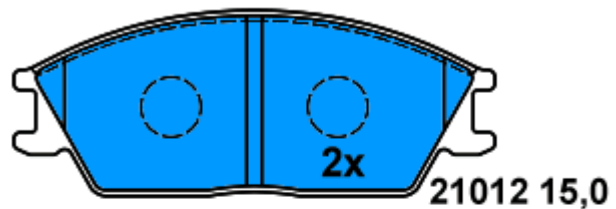
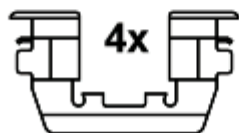
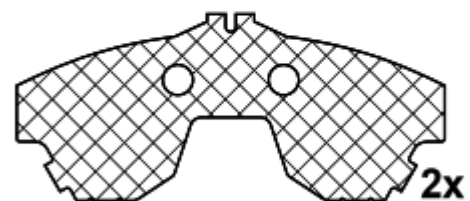
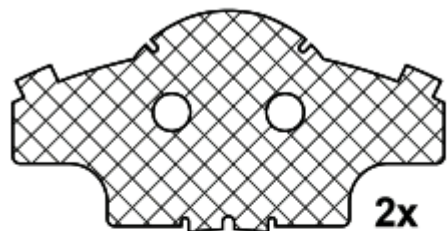

Applications:

- HYUNDAI ACCENT (00-05)
- HYUNDAI GETZ (02-)
- HYUNDAI LANTRA/ELANTRA (95-00)
- HYUNDAI SANTA FE (01-06)

Ate

13.0460-5851.2 605851

Applications:

- SUBARU FORESTER (97-02)
- SUBARU IMPREZA Kombi (00-05)
- SUBARU IMPREZA Kombi (93-00)
- SUBARU IMPREZA Limousine (00-05)
- SUBARU IMPREZA Limousine (93-00)
- SUBARU LEGACY (99-03)
- SUBARU LEGACY Kombi (94-98)
- SUBARU LEGACY Limousine (94-99)
- SUBARU OUTBACK (00-03)

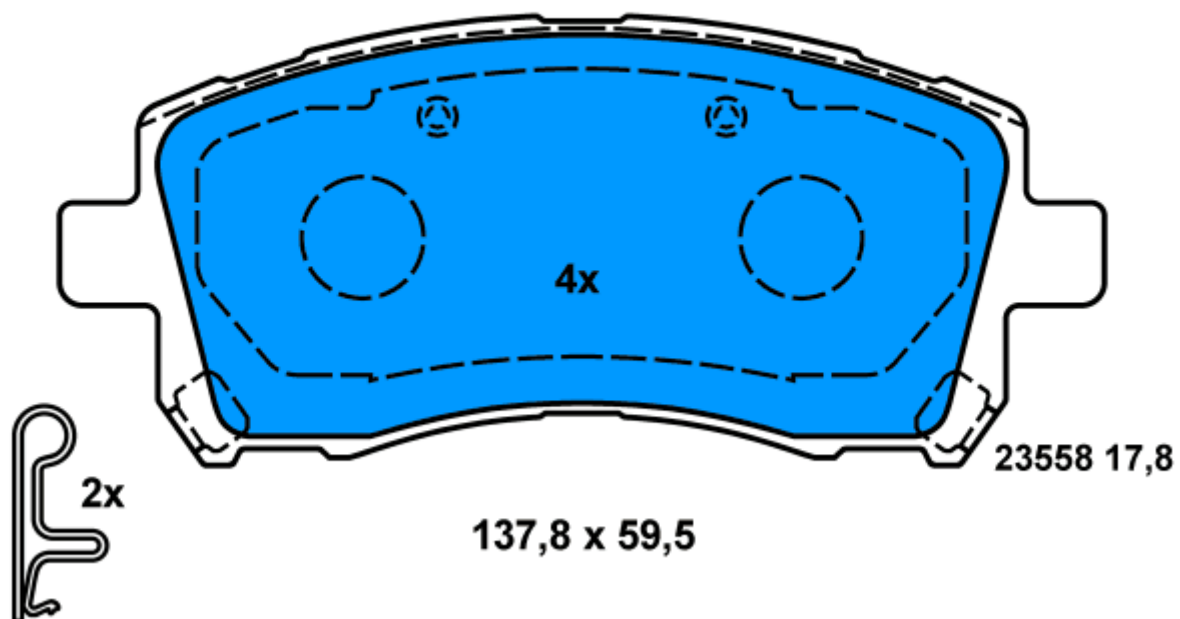



13.0460-5898.2 605898

Applications:

DAIHATSU CHARADE (93-01)
DAIHATSU GRAN MOVE (96-02)

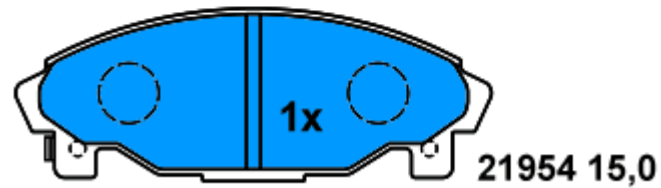
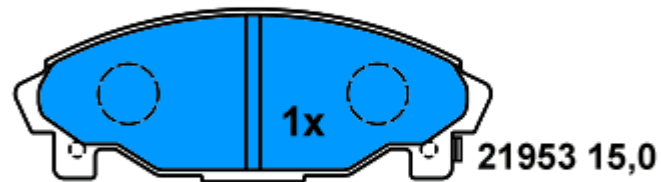
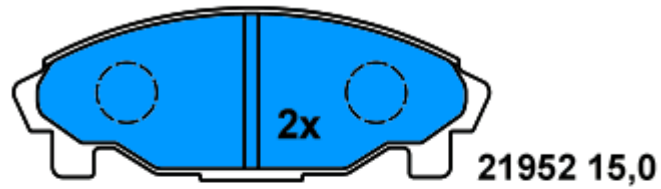
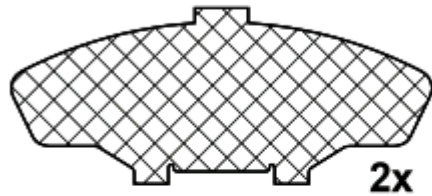

125,8 x 44,5



13.0460-7223.2 607223

Applications:

BMW 1er Reihe/E81/E87 Limousine (04-)
BMW 1er Reihe/E82 Coupe (07-)

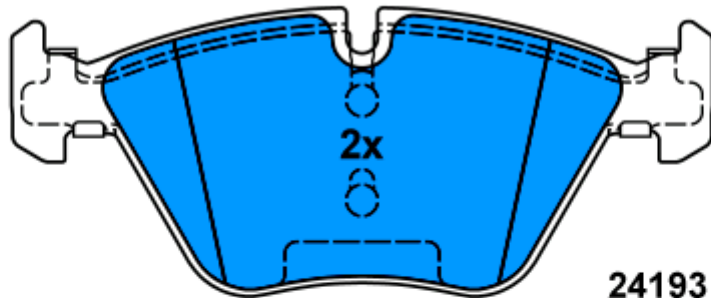

24193 20,3

154,6 x 63,5

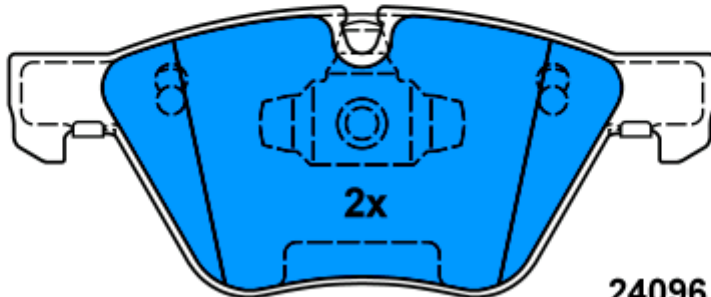

24096 20,3

155,1 x 63,5



13.0460-4805.2 604805

Applications:

- RENAULT CLIO III (BR_/CR_) (05-)
- RENAULT GRAND SCENIC (04-)
- RENAULT MEGANE II Coupe/Cabrio (EM_) (03-)
- RENAULT MEGANE II Limousine 3/5-t?rig (BM/CM_) (02-)
- RENAULT SCENIC II (JM_) (03-)

