

New partnumbers on stock
according to ATE pn.



04/2011



www.ate.de



| | | | | | | | |
|--|--|--|--|--|------------------------|--|-----------------------------------|
| | | | | | OE numbers per ATE pn. | | e.g. replaced pn. / miscellaneous |
|--|--|--|--|--|------------------------|--|-----------------------------------|



BAH - Drum brake shoes rear

| | | | | | | | | | |
|----------------|---------------|---------|------------------------|-----------|--|---------|--|---------------|--|
| 03.0137-0498.2 | 650498 | RENAULT | TWINGO II (CN0_) (07-) | 1,5 dCi | | 03.2007 | | 77 01 209 586 | |
| | | RENAULT | TWINGO II (CN0_) (07-) | 1,2 Turbo | | 03.2007 | | 77 01 209 586 | |
| | | RENAULT | TWINGO II (CN0_) (07-) | 1,2 16V | | 03.2007 | | 77 01 209 586 | |
| | | RENAULT | TWINGO II (CN0_) (07-) | 1,2 | | 03.2007 | | 77 01 209 586 | |
| | | RENAULT | TWINGO II (CN0_) (07-) | 1,5 dCi | | 04.2008 | | 77 01 209 586 | |



FSB - Parking brake shoe

| | | | | | | | | | |
|----------------|---------------|---------------|-------------------------------------|---------|--|---------|--|-------------------------------|--|
| 03.0137-4008.2 | 654008 | VOLKSWAGEN | CRAFTER (06-) | 2,5 TDI | | 04.2006 | | 906 420 04 20 , 2E0 698 525 A | |
| | | MERCEDES BENZ | Transporter (BM 906) SPRINTER (06-) | 511 CDI | | 04.2006 | | 906 420 04 20 , 2E0 698 525 A | |
| | | MERCEDES BENZ | Transporter (BM 906) SPRINTER (06-) | 515 CDI | | 04.2006 | | 906 420 04 20 , 2E0 698 525 A | |
| | | MERCEDES BENZ | Transporter (BM 906) SPRINTER (06-) | 509 CDI | | 04.2006 | | 906 420 04 20 , 2E0 698 525 A | |
| | | MERCEDES BENZ | Transporter (BM 906) SPRINTER (06-) | 518 CDI | | 04.2006 | | 906 420 04 20 , 2E0 698 525 A | |
| | | MERCEDES BENZ | Transporter (BM 906) SPRINTER (06-) | 524 | | 04.2006 | | 906 420 04 20 , 2E0 698 525 A | |



| | | | | | | | |
|--|--|--|--|--|-------------------------------|--|--|
| | | | | | OE numbers per ATE pn. | | e.g. replaced pn. / miscellaneous |
|--|--|--|--|--|-------------------------------|--|--|



HBS - Handbrake cable

| | | | | | | | | | |
|----------------|---------------|------------|------------|------------------|----|---------|--|----------|--|
| 24.3727-2113.2 | 582113 | MITSUBISHI | COLT (04-) | 1,1 i 12V (Z32A) | RR | 10.2004 | | MR955256 | |
| | | MITSUBISHI | COLT (04-) | 1,5 DI-D (Z39A) | RR | 08.2004 | | MR955256 | |
| | | MITSUBISHI | COLT (04-) | 1,5 DI-D (Z38A) | RR | 08.2004 | | MR955256 | |
| | | MITSUBISHI | COLT (04-) | 1,3 i 16V (Z34A) | RR | 06.2004 | | MR955256 | |



HBZ - Master cylinder

| | | | | | | | | | |
|----------------|---------------|------------|-------------------|-----------------|--|---------|--|---|--|
| 03.4153-0186.3 | 010816 | SEAT | ALHAMBRA II (10-) | 2,0 TSI | | 09.2010 | | 3C1 614 019 A , 3C1 614 019 E , 3C1 614 019 C | |
| | | SEAT | ALHAMBRA II (10-) | 1,4 TSI | | 09.2010 | | 3C1 614 019 A , 3C1 614 019 E , 3C1 614 019 C | |
| | | SEAT | ALHAMBRA II (10-) | 2,0 TDI | | 09.2010 | | 3C1 614 019 A , 3C1 614 019 E , 3C1 614 019 C | |
| | | VOLKSWAGEN | PASSAT (10-) | 2,0 TDI 4motion | | 08.2010 | | 3C1 614 019 A , 3C1 614 019 E , 3C1 614 019 C | |
| | | VOLKSWAGEN | PASSAT (10-) | 2,0 TDI | | 08.2010 | | 3C1 614 019 A , 3C1 614 019 E , 3C1 614 019 C | |
| | | VOLKSWAGEN | PASSAT (10-) | 1,4 TSI | | 08.2010 | | 3C1 614 019 A , 3C1 614 019 E , 3C1 614 019 C | |
| | | VOLKSWAGEN | PASSAT (10-) | 1,4 TSI EcoFuel | | 08.2010 | | 3C1 614 019 A , 3C1 614 019 E , 3C1 614 019 C | |
| | | VOLKSWAGEN | PASSAT (10-) | 1,8 TSI | | 08.2010 | | 3C1 614 019 A , 3C1 614 019 E , 3C1 614 019 C | |



| | | | | | | | |
|--|--|--|--|--|-------------------------------|--|--|
| | | | | | OE numbers per ATE pn. | | e.g. replaced pn. / miscellaneous |
|--|--|--|--|--|-------------------------------|--|--|



HBZ - Master cylinder

| | | | | | | | | | |
|----------------|---------------|------------|--------------------------|--------------------|--|---------|---------|---|--|
| 03.4153-0186.3 | 010816 | VOLKSWAGEN | PASSAT (10-) | 2,0 TSI | | 11.2010 | | 3C1 614 019 A, 3C1 614 019 E, 3C1 614 019 C | |
| | | VOLKSWAGEN | PASSAT (10-) | 1,6 TDI | | 08.2010 | | 3C1 614 019 A, 3C1 614 019 E, 3C1 614 019 C | |
| | | VOLKSWAGEN | PASSAT CC (08-) | 2,0 TDI 4motion | | 11.2009 | | 3C1 614 019 A, 3C1 614 019 E, 3C1 614 019 C | |
| | | VOLKSWAGEN | PASSAT CC (08-) | 2,0 TSI | | 04.2008 | | 3C1 614 019 A, 3C1 614 019 E, 3C1 614 019 C | |
| | | VOLKSWAGEN | PASSAT CC (08-) | 3,6 V6 4motion | | 04.2008 | | 3C1 614 019 A, 3C1 614 019 E, 3C1 614 019 C | |
| | | VOLKSWAGEN | PASSAT CC (08-) | 2,0 TDI 4motion | | 08.2009 | | 3C1 614 019 A, 3C1 614 019 E, 3C1 614 019 C | |
| | | VOLKSWAGEN | PASSAT CC (08-) | 2,0 TDI | | 06.2008 | | 3C1 614 019 A, 3C1 614 019 E, 3C1 614 019 C | |
| | | VOLKSWAGEN | PASSAT CC (08-) | 1,8 TSI | | 04.2008 | | 3C1 614 019 A, 3C1 614 019 E, 3C1 614 019 C | |
| | | VOLKSWAGEN | PASSAT CC (08-) | 2,0 TDI | | 04.2008 | | 3C1 614 019 A, 3C1 614 019 E, 3C1 614 019 C | |
| | | VOLKSWAGEN | PASSAT Limousine (05-10) | 2,0 FSI 4motion | | 03.2005 | 07.2010 | 3C1 614 019 A, 3C1 614 019 E, 3C1 614 019 C | |
| | | VOLKSWAGEN | PASSAT Limousine (05-10) | 3,2 V6 FSI 4motion | | 09.2005 | 07.2010 | 3C1 614 019 A, 3C1 614 019 E, 3C1 614 019 C | |
| | | VOLKSWAGEN | PASSAT Limousine (05-10) | 3,2 V6 FSI | | 11.2005 | 07.2010 | 3C1 614 019 A, 3C1 614 019 E, 3C1 614 019 C | |



| | | | | | | | |
|--|--|--|--|--|-------------------------------|--|--|
| | | | | | OE numbers per ATE pn. | | e.g. replaced pn. / miscellaneous |
|--|--|--|--|--|-------------------------------|--|--|



HBZ - Master cylinder

| | | | | | | | | | |
|----------------|---------------|------------|--------------------------|-----------------|--|---------|---------|---|--|
| 03.4153-0186.3 | 010816 | VOLKSWAGEN | PASSAT Limousine (05-10) | 2,0 TFSI | | 03.2005 | 07.2010 | 3C1 614 019 A , 3C1 614 019 E , 3C1 614 019 C | |
| | | VOLKSWAGEN | PASSAT Limousine (05-10) | 2,0 TDI 4motion | | 05.2009 | 07.2010 | 3C1 614 019 A , 3C1 614 019 E , 3C1 614 019 C | |
| | | VOLKSWAGEN | PASSAT Limousine (05-10) | | | 03.2005 | 07.2010 | 3C1 614 019 A , 3C1 614 019 E , 3C1 614 019 C | |
| | | VOLKSWAGEN | PASSAT Limousine (05-10) | 1,4 TSI | | 10.2007 | 07.2010 | 3C1 614 019 A , 3C1 614 019 E , 3C1 614 019 C | |
| | | VOLKSWAGEN | PASSAT Limousine (05-10) | 2,0 FSI | | 03.2005 | 07.2010 | 3C1 614 019 A , 3C1 614 019 E , 3C1 614 019 C | |
| | | VOLKSWAGEN | PASSAT Limousine (05-10) | 1,9 TDI | | 03.2005 | 07.2010 | 3C1 614 019 A , 3C1 614 019 E , 3C1 614 019 C | |
| | | VOLKSWAGEN | PASSAT Limousine (05-10) | 1,8 TSI | | 11.2009 | 07.2010 | 3C1 614 019 A , 3C1 614 019 E , 3C1 614 019 C | |
| | | VOLKSWAGEN | PASSAT Limousine (05-10) | 1,6 | | 03.2005 | 07.2010 | 3C1 614 019 A , 3C1 614 019 E , 3C1 614 019 C | |
| | | VOLKSWAGEN | PASSAT Limousine (05-10) | 1,6 FSI | | 03.2005 | 07.2010 | 3C1 614 019 A , 3C1 614 019 E , 3C1 614 019 C | |
| | | VOLKSWAGEN | PASSAT Limousine (05-10) | 1,6 TDI | | 08.2009 | 07.2010 | 3C1 614 019 A , 3C1 614 019 E , 3C1 614 019 C | |
| | | VOLKSWAGEN | PASSAT Limousine (05-10) | 1,8 TSI | | 10.2007 | 07.2010 | 3C1 614 019 A , 3C1 614 019 E , 3C1 614 019 C | |
| | | VOLKSWAGEN | PASSAT Limousine (05-10) | 2,0 TDI | | 08.2005 | 07.2010 | 3C1 614 019 A , 3C1 614 019 E , 3C1 614 019 C | |



| | | | | | | | |
|--|--|--|--|--|-------------------------------|--|--|
| | | | | | OE numbers per ATE pn. | | e.g. replaced pn. / miscellaneous |
|--|--|--|--|--|-------------------------------|--|--|



HBZ - Master cylinder

| | | | | | | | | | |
|----------------|---------------|------------|--------------------------|--------------------|--|---------|---------|---|--|
| 03.4153-0186.3 | 010816 | VOLKSWAGEN | PASSAT Limousine (05-10) | 2,0 TDI | | 03.2005 | 07.2010 | 3C1 614 019 A, 3C1 614 019 E, 3C1 614 019 C | |
| | | VOLKSWAGEN | PASSAT Variant (05-10) | 2,0 TDI 4motion | | 05.2009 | 07.2010 | 3C1 614 019 A, 3C1 614 019 E, 3C1 614 019 C | |
| | | VOLKSWAGEN | PASSAT Variant (05-10) | 3,2 V6 FSI 4motion | | 11.2005 | 07.2010 | 3C1 614 019 A, 3C1 614 019 E, 3C1 614 019 C | |
| | | VOLKSWAGEN | PASSAT Variant (05-10) | 3,2 V6 FSI | | 11.2005 | 07.2010 | 3C1 614 019 A, 3C1 614 019 E, 3C1 614 019 C | |
| | | VOLKSWAGEN | PASSAT Variant (05-10) | 2,0 TDI 4motion | | 09.2005 | 07.2010 | 3C1 614 019 A, 3C1 614 019 E, 3C1 614 019 C | |
| | | VOLKSWAGEN | PASSAT Variant (05-10) | 2,0 TDI | | 11.2005 | 07.2010 | 3C1 614 019 A, 3C1 614 019 E, 3C1 614 019 C | |
| | | VOLKSWAGEN | PASSAT Variant (05-10) | 1,6 TDI | | 08.2009 | 07.2010 | 3C1 614 019 A, 3C1 614 019 E, 3C1 614 019 C | |
| | | VOLKSWAGEN | PASSAT Variant (05-10) | 2,0 FSI 4motion | | 09.2005 | 07.2010 | 3C1 614 019 A, 3C1 614 019 E, 3C1 614 019 C | |
| | | VOLKSWAGEN | PASSAT Variant (05-10) | 2,0 FSI | | 07.2005 | 07.2010 | 3C1 614 019 A, 3C1 614 019 E, 3C1 614 019 C | |
| | | VOLKSWAGEN | PASSAT Variant (05-10) | 1,9 TDI | | 07.2005 | 07.2010 | 3C1 614 019 A, 3C1 614 019 E, 3C1 614 019 C | |
| | | VOLKSWAGEN | PASSAT Variant (05-10) | 1,8 TSI | | 11.2009 | 07.2010 | 3C1 614 019 A, 3C1 614 019 E, 3C1 614 019 C | |
| | | VOLKSWAGEN | PASSAT Variant (05-10) | | | 10.2007 | 07.2010 | 3C1 614 019 A, 3C1 614 019 E, 3C1 614 019 C | |



| | | | | | | | |
|--|--|--|--|--|-------------------------------|--|--|
| | | | | | OE numbers per ATE pn. | | e.g. replaced pn. / miscellaneous |
|--|--|--|--|--|-------------------------------|--|--|



HBZ - Master cylinder

| | | | | | | | | | |
|----------------|---------------|------------|------------------------|--------------------|--|---------|---------|---|--|
| 03.4153-0186.3 | 010816 | VOLKSWAGEN | PASSAT Variant (05-10) | 2,0 TDI | | 07.2005 | 07.2010 | 3C1 614 019 A, 3C1 614 019 E, 3C1 614 019 C | |
| | | VOLKSWAGEN | PASSAT Variant (05-10) | 2,0 TFSI | | 07.2005 | 07.2010 | 3C1 614 019 A, 3C1 614 019 E, 3C1 614 019 C | |
| | | VOLKSWAGEN | PASSAT Variant (05-10) | 1,4 TSI | | 10.2007 | 07.2010 | 3C1 614 019 A, 3C1 614 019 E, 3C1 614 019 C | |
| | | VOLKSWAGEN | PASSAT Variant (05-10) | 1,6 | | 07.2005 | 07.2010 | 3C1 614 019 A, 3C1 614 019 E, 3C1 614 019 C | |
| | | VOLKSWAGEN | PASSAT Variant (05-10) | 1,6 FSI | | 07.2005 | 07.2010 | 3C1 614 019 A, 3C1 614 019 E, 3C1 614 019 C | |
| | | VOLKSWAGEN | SHARAN II (10-) | 1,4 TSI BlueMotion | | 07.2010 | | 3C1 614 019 A, 3C1 614 019 E, 3C1 614 019 C | |
| | | VOLKSWAGEN | SHARAN II (10-) | 2,0 TDI BlueMotion | | 07.2010 | | 3C1 614 019 A, 3C1 614 019 E, 3C1 614 019 C | |
| | | VOLKSWAGEN | TIGUAN (07-) | 2,0 TDi | | 04.2010 | | 3C1 614 019 A, 3C1 614 019 E, 3C1 614 019 C | |
| | | VOLKSWAGEN | TIGUAN (07-) | 2,0 TSI 4motion | | 11.2007 | | 3C1 614 019 A, 3C1 614 019 E, 3C1 614 019 C | |
| | | VOLKSWAGEN | TIGUAN (07-) | | | 02.2008 | | 3C1 614 019 A, 3C1 614 019 E, 3C1 614 019 C | |
| | | VOLKSWAGEN | TIGUAN (07-) | 2,0 TDI 4motion | | 11.2007 | | 3C1 614 019 A, 3C1 614 019 E, 3C1 614 019 C | |
| | | VOLKSWAGEN | TIGUAN (07-) | 1,4 TSI | | 11.2007 | | 3C1 614 019 A, 3C1 614 019 E, 3C1 614 019 C | |



| | | | | | | | |
|--|--|--|--|--|-------------------------------|--|--|
| | | | | | OE numbers per ATE pn. | | e.g. replaced pn. / miscellaneous |
|--|--|--|--|--|-------------------------------|--|--|



HBZ - Master cylinder

| | | | | | | | | | |
|----------------|---------------|------------|-------------------------|-------------------|--|---------|---------|---|--|
| 03.4153-0186.3 | 010816 | VOLKSWAGEN | TIGUAN (07-) | 2,0 TDI 4motion | | 01.2008 | | 3C1 614 019 A , 3C1 614 019 E , 3C1 614 019 C | |
| | | VOLKSWAGEN | TIGUAN (07-) | 1,4 TSI | | 08.2010 | | 3C1 614 019 A , 3C1 614 019 E , 3C1 614 019 C | |
| 03.2123-2221.3 | 010861 | TOYOTA | AVENSIS (97-03) | 2,0 VVTi (AZT220) | | 10.2000 | 02.2003 | 47201-05050 , 47201-05051 , 47201-05080 | |
| | | TOYOTA | AVENSIS (97-03) | 2,0 TD (CT220) | | 09.1997 | 02.2003 | 47201-05050 , 47201-05051 , 47201-05080 | |
| | | TOYOTA | AVENSIS (97-03) | 2,0 i 16V (ST220) | | 09.1997 | 09.2000 | 47201-05050 , 47201-05051 , 47201-05080 | |
| | | TOYOTA | AVENSIS (97-03) | 2,0 D4-D (CDT221) | | 10.1999 | 02.2003 | 47201-05050 , 47201-05051 , 47201-05080 | |
| | | TOYOTA | AVENSIS (97-03) | 1,8 VVTi (ZZT221) | | 10.2000 | 02.2003 | 47201-05050 , 47201-05051 , 47201-05080 | |
| | | TOYOTA | AVENSIS (97-03) | 1,8 i 16V (AT221) | | 09.1997 | 09.2000 | 47201-05050 , 47201-05051 , 47201-05080 | |
| | | TOYOTA | AVENSIS (97-03) | 1,6 VVTi (ZZT220) | | 10.2000 | 02.2003 | 47201-05050 , 47201-05051 , 47201-05080 | |
| | | TOYOTA | AVENSIS (97-03) | 1,6 i 16V (AT220) | | 09.1997 | 09.2000 | 47201-05050 , 47201-05051 , 47201-05080 | |
| 03.2023-2249.3 | 010869 | BMW | Z4 Roadster/E85 (03-08) | 3,0 i | | 12.2002 | 12.2008 | 34 31 6 763 670 | |
| | | BMW | Z4 Roadster/E85 (03-08) | 2,0 i | | 04.2005 | 12.2008 | 34 31 6 763 670 | |
| | | BMW | Z4 Roadster/E85 (03-08) | 2,5 i | | 12.2002 | 12.2008 | 34 31 6 763 670 | |
| | | BMW | Z4 Roadster/E85 (03-08) | 2,2 i | | 10.2003 | 12.2008 | 34 31 6 763 670 | |



| | | | | | | | |
|--|--|--|--|--|-------------------------------|--|--|
| | | | | | OE numbers per ATE pn. | | e.g. replaced pn. / miscellaneous |
|--|--|--|--|--|-------------------------------|--|--|



HBZ - Master cylinder



KGZ - Clutch cylinder

| | | | | | | | | |
|----------------|---------------|------|-------------------------|------------------|--|---------|---|--|
| 24.2415-1711.3 | 030130 | AUDI | A3 / A3 Sportback (03-) | 1,6 | | 05.2003 | 1K0 721 388 G , 1K0 721 388 L , 1K0 721 388 F , 1K0 721 388 M , 1K0 721 388 S , 1K0 721 388 B | |
| | | AUDI | A3 / A3 Sportback (03-) | 2,0 TDI | | 05.2003 | 1K0 721 388 G , 1K0 721 388 L , 1K0 721 388 F , 1K0 721 388 M , 1K0 721 388 S , 1K0 721 388 B | |
| | | AUDI | A3 / A3 Sportback (03-) | S3 quattro | | 11.2006 | 1K0 721 388 G , 1K0 721 388 L , 1K0 721 388 F , 1K0 721 388 M , 1K0 721 388 S , 1K0 721 388 B | |
| | | AUDI | A3 / A3 Sportback (03-) | 3,2 quattro | | 07.2003 | 1K0 721 388 G , 1K0 721 388 L , 1K0 721 388 F , 1K0 721 388 M , 1K0 721 388 S , 1K0 721 388 B | |
| | | AUDI | A3 / A3 Sportback (03-) | 2,0 TFSI quattro | | 06.2004 | 1K0 721 388 G , 1K0 721 388 L , 1K0 721 388 F , 1K0 721 388 M , 1K0 721 388 S , 1K0 721 388 B | |
| | | AUDI | A3 / A3 Sportback (03-) | 2,0 TFSI | | 06.2004 | 1K0 721 388 G , 1K0 721 388 L , 1K0 721 388 F , 1K0 721 388 M , 1K0 721 388 S , 1K0 721 388 B | |



| | | | | | | |
|--|--|--|--|--|-------------------------------|--|
| | | | | | OE numbers per ATE pn. | e.g. replaced pn. / miscellaneous |
|--|--|--|--|--|-------------------------------|--|



KGZ - Clutch cylinder

| | | | | | | |
|----------------|---------------|------|-------------------------|------------------|---------|---|
| 24.2415-1711.3 | 030130 | AUDI | A3 / A3 Sportback (03-) | 2,0 TDI quattro | 08.2004 | 1K0 721 388 G , 1K0 721 388 L , 1K0 721 388 F , 1K0 721 388 M , 1K0 721 388 S , 1K0 721 388 B |
| | | AUDI | A3 / A3 Sportback (03-) | | 05.2003 | 1K0 721 388 G , 1K0 721 388 L , 1K0 721 388 F , 1K0 721 388 M , 1K0 721 388 S , 1K0 721 388 B |
| | | AUDI | A3 / A3 Sportback (03-) | 1,2 TSI | 04.2010 | 1K0 721 388 G , 1K0 721 388 L , 1K0 721 388 F , 1K0 721 388 M , 1K0 721 388 S , 1K0 721 388 B |
| | | AUDI | A3 / A3 Sportback (03-) | 1,4 TFSI | 07.2007 | 1K0 721 388 G , 1K0 721 388 L , 1K0 721 388 F , 1K0 721 388 M , 1K0 721 388 S , 1K0 721 388 B |
| | | AUDI | A3 / A3 Sportback (03-) | 1,6 FSI | 08.2003 | 1K0 721 388 G , 1K0 721 388 L , 1K0 721 388 F , 1K0 721 388 M , 1K0 721 388 S , 1K0 721 388 B |
| | | AUDI | A3 / A3 Sportback (03-) | 1,6 TDI | 05.2009 | 1K0 721 388 G , 1K0 721 388 L , 1K0 721 388 F , 1K0 721 388 M , 1K0 721 388 S , 1K0 721 388 B |
| | | AUDI | A3 / A3 Sportback (03-) | 1,8 TFSI | 01.2007 | 1K0 721 388 G , 1K0 721 388 L , 1K0 721 388 F , 1K0 721 388 M , 1K0 721 388 S , 1K0 721 388 B |
| | | AUDI | A3 / A3 Sportback (03-) | 1,8 TFSI quattro | 05.2008 | 1K0 721 388 G , 1K0 721 388 L , 1K0 721 388 F , 1K0 721 388 M , 1K0 721 388 S , 1K0 721 388 B |



| | | | | | | |
|--|--|--|--|--|-------------------------------|--|
| | | | | | OE numbers per ATE pn. | e.g. replaced pn. / miscellaneous |
|--|--|--|--|--|-------------------------------|--|



KGZ - Clutch cylinder

| | | | | | | | | | |
|----------------|--------|------|-------------------------|-----------------|--|---------|---------|---|--|
| 24.2415-1711.3 | 030130 | AUDI | A3 / A3 Sportback (03-) | 1,9 TDI | | 06.2003 | | 1K0 721 388 G , 1K0 721 388 L , 1K0 721 388 F , 1K0 721 388 M , 1K0 721 388 S , 1K0 721 388 B | |
| | | AUDI | A3 / A3 Sportback (03-) | S3 quattro | | 07.2008 | | 1K0 721 388 G , 1K0 721 388 L , 1K0 721 388 F , 1K0 721 388 M , 1K0 721 388 S , 1K0 721 388 B | |
| | | AUDI | A3 / A3 Sportback (03-) | 2,0 TDI | | 03.2006 | | 1K0 721 388 G , 1K0 721 388 L , 1K0 721 388 F , 1K0 721 388 M , 1K0 721 388 S , 1K0 721 388 B | |
| | | AUDI | A3 / A3 Sportback (03-) | | | 06.2006 | 06.2008 | 1K0 721 388 G , 1K0 721 388 L , 1K0 721 388 F , 1K0 721 388 M , 1K0 721 388 S , 1K0 721 388 B | |
| | | AUDI | A3 / A3 Sportback (03-) | 2,0 TDI quattro | | 03.2006 | | 1K0 721 388 G , 1K0 721 388 L , 1K0 721 388 F , 1K0 721 388 M , 1K0 721 388 S , 1K0 721 388 B | |
| | | AUDI | A3 / A3 Sportback (03-) | 2,0 FSI | | 05.2003 | | 1K0 721 388 G , 1K0 721 388 L , 1K0 721 388 F , 1K0 721 388 M , 1K0 721 388 S , 1K0 721 388 B | |
| | | AUDI | A3 Convertible (08-) | 2,0 TFSI | | 04.2008 | | 1K0 721 388 G , 1K0 721 388 L , 1K0 721 388 F , 1K0 721 388 M , 1K0 721 388 S , 1K0 721 388 B | |
| | | AUDI | A3 Convertible (08-) | 1,6 | | 09.2008 | | 1K0 721 388 G , 1K0 721 388 L , 1K0 721 388 F , 1K0 721 388 M , 1K0 721 388 S , 1K0 721 388 B | |



| | | | | | | | |
|--|--|--|--|--|-------------------------------|--|--|
| | | | | | OE numbers per ATE pn. | | e.g. replaced pn. / miscellaneous |
|--|--|--|--|--|-------------------------------|--|--|



KGZ - Clutch cylinder

| | | | | | | | | |
|----------------|---------------|------|----------------------|----------|--|---------|---|--|
| 24.2415-1711.3 | 030130 | AUDI | A3 Convertible (08-) | 1,6 TDI | | 05.2009 | 1K0 721 388 G , 1K0 721 388 L , 1K0 721 388 F , 1K0 721 388 M , 1K0 721 388 S , 1K0 721 388 B | |
| | | AUDI | A3 Convertible (08-) | 1,8 TFSI | | 04.2008 | 1K0 721 388 G , 1K0 721 388 L , 1K0 721 388 F , 1K0 721 388 M , 1K0 721 388 S , 1K0 721 388 B | |
| | | AUDI | A3 Convertible (08-) | 2,0 TDI | | 04.2008 | 1K0 721 388 G , 1K0 721 388 L , 1K0 721 388 F , 1K0 721 388 M , 1K0 721 388 S , 1K0 721 388 B | |
| | | AUDI | A3 Convertible (08-) | 1,2 TSI | | 03.2010 | 1K0 721 388 G , 1K0 721 388 L , 1K0 721 388 F , 1K0 721 388 M , 1K0 721 388 S , 1K0 721 388 B | |
| | | AUDI | A3 Convertible (08-) | 1,9 TDI | | 04.2008 | 1K0 721 388 G , 1K0 721 388 L , 1K0 721 388 F , 1K0 721 388 M , 1K0 721 388 S , 1K0 721 388 B | |
| | | SEAT | ALTEA (5P1) (04-) | 1,4 TSI | | 11.2007 | 1K0 721 388 G , 1K0 721 388 L , 1K0 721 388 F , 1K0 721 388 M , 1K0 721 388 S , 1K0 721 388 B | |
| | | SEAT | ALTEA (5P1) (04-) | 2,0 TFSI | | 03.2006 | 1K0 721 388 G , 1K0 721 388 L , 1K0 721 388 F , 1K0 721 388 M , 1K0 721 388 S , 1K0 721 388 B | |
| | | SEAT | ALTEA (5P1) (04-) | 2,0 TDI | | 03.2006 | 1K0 721 388 G , 1K0 721 388 L , 1K0 721 388 F , 1K0 721 388 M , 1K0 721 388 S , 1K0 721 388 B | |



| | | | | | | |
|--|--|--|--|--|-------------------------------|--|
| | | | | | OE numbers per ATE pn. | e.g. replaced pn. / miscellaneous |
|--|--|--|--|--|-------------------------------|--|



KGZ - Clutch cylinder

| | | | | | | | | |
|----------------|---------------|------|-------------------|-----------|--|---------|---|--|
| 24.2415-1711.3 | 030130 | SEAT | ALTEA (5P1) (04-) | 2,0 i 16V | | 03.2004 | 1K0 721 388 G , 1K0 721 388 L , 1K0 721 388 F , 1K0 721 388 M , 1K0 721 388 S , 1K0 721 388 B | |
| | | SEAT | ALTEA (5P1) (04-) | 1,9 TDI | | 03.2004 | 1K0 721 388 G , 1K0 721 388 L , 1K0 721 388 F , 1K0 721 388 M , 1K0 721 388 S , 1K0 721 388 B | |
| | | SEAT | ALTEA (5P1) (04-) | 1,8 TFSI | | 01.2007 | 1K0 721 388 G , 1K0 721 388 L , 1K0 721 388 F , 1K0 721 388 M , 1K0 721 388 S , 1K0 721 388 B | |
| | | SEAT | ALTEA (5P1) (04-) | 1,6 TDI | | 10.2009 | 1K0 721 388 G , 1K0 721 388 L , 1K0 721 388 F , 1K0 721 388 M , 1K0 721 388 S , 1K0 721 388 B | |
| | | SEAT | ALTEA (5P1) (04-) | 1,6 i 16V | | 03.2004 | 1K0 721 388 G , 1K0 721 388 L , 1K0 721 388 F , 1K0 721 388 M , 1K0 721 388 S , 1K0 721 388 B | |
| | | SEAT | ALTEA (5P1) (04-) | 1,4 i 16V | | 05.2006 | 1K0 721 388 G , 1K0 721 388 L , 1K0 721 388 F , 1K0 721 388 M , 1K0 721 388 S , 1K0 721 388 B | |
| | | SEAT | ALTEA (5P1) (04-) | 1,2 TSI | | 04.2010 | 1K0 721 388 G , 1K0 721 388 L , 1K0 721 388 F , 1K0 721 388 M , 1K0 721 388 S , 1K0 721 388 B | |
| | | SEAT | ALTEA (5P1) (04-) | 2,0 FSI | | 03.2004 | 1K0 721 388 G , 1K0 721 388 L , 1K0 721 388 F , 1K0 721 388 M , 1K0 721 388 S , 1K0 721 388 B | |



| | | | | | | |
|--|--|--|--|--|-------------------------------|--|
| | | | | | OE numbers per ATE pn. | e.g. replaced pn. / miscellaneous |
|--|--|--|--|--|-------------------------------|--|



KGZ - Clutch cylinder

| | | | | | | | | |
|----------------|---------------|------|----------------------|-----------|--|---------|---|--|
| 24.2415-1711.3 | 030130 | SEAT | ALTEA (5P1) (04-) | 1,6 LPG | | 09.2009 | 1K0 721 388 G , 1K0 721 388 L , 1K0 721 388 F , 1K0 721 388 M , 1K0 721 388 S , 1K0 721 388 B | |
| | | SEAT | ALTEA (5P1) (04-) | 2,0 TDI | | 03.2004 | 1K0 721 388 G , 1K0 721 388 L , 1K0 721 388 F , 1K0 721 388 M , 1K0 721 388 S , 1K0 721 388 B | |
| | | SEAT | ALTEA XL (5P5) (06-) | 1,9 TDI | | 10.2006 | 1K0 721 388 G , 1K0 721 388 L , 1K0 721 388 F , 1K0 721 388 M , 1K0 721 388 S , 1K0 721 388 B | |
| | | SEAT | ALTEA XL (5P5) (06-) | 1,4 i 16V | | 05.2008 | 1K0 721 388 G , 1K0 721 388 L , 1K0 721 388 F , 1K0 721 388 M , 1K0 721 388 S , 1K0 721 388 B | |
| | | SEAT | ALTEA XL (5P5) (06-) | 1,4 TSI | | 11.2007 | 1K0 721 388 G , 1K0 721 388 L , 1K0 721 388 F , 1K0 721 388 M , 1K0 721 388 S , 1K0 721 388 B | |
| | | SEAT | ALTEA XL (5P5) (06-) | 1,6 i 16V | | 10.2006 | 1K0 721 388 G , 1K0 721 388 L , 1K0 721 388 F , 1K0 721 388 M , 1K0 721 388 S , 1K0 721 388 B | |
| | | SEAT | ALTEA XL (5P5) (06-) | 2,0 FSI | | 10.2006 | 1K0 721 388 G , 1K0 721 388 L , 1K0 721 388 F , 1K0 721 388 M , 1K0 721 388 S , 1K0 721 388 B | |
| | | SEAT | ALTEA XL (5P5) (06-) | 1,6 LPG | | 09.2009 | 1K0 721 388 G , 1K0 721 388 L , 1K0 721 388 F , 1K0 721 388 M , 1K0 721 388 S , 1K0 721 388 B | |



| | | | | | | | |
|--|--|--|--|--|-------------------------------|--|--|
| | | | | | OE numbers per ATE pn. | | e.g. replaced pn. / miscellaneous |
|--|--|--|--|--|-------------------------------|--|--|



KGZ - Clutch cylinder

| | | | | | | | | |
|----------------|---------------|------------|----------------------|-----------------|--|---------|---|--|
| 24.2415-1711.3 | 030130 | SEAT | ALTEA XL (5P5) (06-) | 1,6 TDI | | 10.2009 | 1K0 721 388 G , 1K0 721 388 L , 1K0 721 388 F , 1K0 721 388 M , 1K0 721 388 S , 1K0 721 388 B | |
| | | SEAT | ALTEA XL (5P5) (06-) | 1,8 TFSI | | 10.2006 | 1K0 721 388 G , 1K0 721 388 L , 1K0 721 388 F , 1K0 721 388 M , 1K0 721 388 S , 1K0 721 388 B | |
| | | SEAT | ALTEA XL (5P5) (06-) | 2,0 TFSI 4x4 | | 06.2007 | 1K0 721 388 G , 1K0 721 388 L , 1K0 721 388 F , 1K0 721 388 M , 1K0 721 388 S , 1K0 721 388 B | |
| | | SEAT | ALTEA XL (5P5) (06-) | 1,2 TSI | | 04.2010 | 1K0 721 388 G , 1K0 721 388 L , 1K0 721 388 F , 1K0 721 388 M , 1K0 721 388 S , 1K0 721 388 B | |
| | | SEAT | ALTEA XL (5P5) (06-) | 2,0 TDI | | 10.2006 | 1K0 721 388 G , 1K0 721 388 L , 1K0 721 388 F , 1K0 721 388 M , 1K0 721 388 S , 1K0 721 388 B | |
| | | SEAT | ALTEA XL (5P5) (06-) | 2,0 TDI 4x4 | | 06.2007 | 1K0 721 388 G , 1K0 721 388 L , 1K0 721 388 F , 1K0 721 388 M , 1K0 721 388 S , 1K0 721 388 B | |
| | | VOLKSWAGEN | CADDY III (04-) | 2,0 TDI 4motion | | 10.2010 | 1K0 721 388 G , 1K0 721 388 L , 1K0 721 388 F , 1K0 721 388 M , 1K0 721 388 S , 1K0 721 388 B | |
| | | VOLKSWAGEN | CADDY III (04-) | 2,0 TDI | | 09.2007 | 1K0 721 388 G , 1K0 721 388 L , 1K0 721 388 F , 1K0 721 388 M , 1K0 721 388 S , 1K0 721 388 B | |



| | | | | | | |
|--|--|--|--|--|-------------------------------|--|
| | | | | | OE numbers per ATE pn. | e.g. replaced pn. / miscellaneous |
|--|--|--|--|--|-------------------------------|--|



KGZ - Clutch cylinder

| | | | | | | | | |
|----------------|--------|------------|-----------------|-----------------|--|---------|---|--|
| 24.2415-1711.3 | 030130 | VOLKSWAGEN | CADDY III (04-) | 2,0 SDI | | 02.2004 | 1K0 721 388 G , 1K0 721 388 L , 1K0 721 388 F , 1K0 721 388 M , 1K0 721 388 S , 1K0 721 388 B | |
| | | VOLKSWAGEN | CADDY III (04-) | 1,2 TSI | | 09.2010 | 1K0 721 388 G , 1K0 721 388 L , 1K0 721 388 F , 1K0 721 388 M , 1K0 721 388 S , 1K0 721 388 B | |
| | | VOLKSWAGEN | CADDY III (04-) | 2,0 Eco Fuel | | 04.2006 | 1K0 721 388 G , 1K0 721 388 L , 1K0 721 388 F , 1K0 721 388 M , 1K0 721 388 S , 1K0 721 388 B | |
| | | VOLKSWAGEN | CADDY III (04-) | 1,9 TDI 4motion | | 05.2008 | 1K0 721 388 G , 1K0 721 388 L , 1K0 721 388 F , 1K0 721 388 M , 1K0 721 388 S , 1K0 721 388 B | |
| | | VOLKSWAGEN | CADDY III (04-) | 1,9 TDI | | 09.2005 | 1K0 721 388 G , 1K0 721 388 L , 1K0 721 388 F , 1K0 721 388 M , 1K0 721 388 S , 1K0 721 388 B | |
| | | VOLKSWAGEN | CADDY III (04-) | | | 02.2004 | 1K0 721 388 G , 1K0 721 388 L , 1K0 721 388 F , 1K0 721 388 M , 1K0 721 388 S , 1K0 721 388 B | |
| | | VOLKSWAGEN | CADDY III (04-) | 1,6 TDI | | 08.2010 | 1K0 721 388 G , 1K0 721 388 L , 1K0 721 388 F , 1K0 721 388 M , 1K0 721 388 S , 1K0 721 388 B | |
| | | VOLKSWAGEN | CADDY III (04-) | 1,6 | | 04.2004 | 1K0 721 388 G , 1K0 721 388 L , 1K0 721 388 F , 1K0 721 388 M , 1K0 721 388 S , 1K0 721 388 B | |



| | | | | | | |
|--|--|--|--|--|-------------------------------|--|
| | | | | | OE numbers per ATE pn. | e.g. replaced pn. / miscellaneous |
|--|--|--|--|--|-------------------------------|--|



KGZ - Clutch cylinder

| | | | | | | | | |
|----------------|--------|------------|-----------------|----------|--|---------|---|--|
| 24.2415-1711.3 | 030130 | VOLKSWAGEN | CADDY III (04-) | 1,4 16V | | 05.2006 | 1K0 721 388 G , 1K0 721 388 L , 1K0 721 388 F , 1K0 721 388 M , 1K0 721 388 S , 1K0 721 388 B | |
| | | VOLKSWAGEN | CADDY III (04-) | 1,4 | | 02.2004 | 1K0 721 388 G , 1K0 721 388 L , 1K0 721 388 F , 1K0 721 388 M , 1K0 721 388 S , 1K0 721 388 B | |
| | | VOLKSWAGEN | EOS (06-) | 3,2 V6 | | 05.2006 | 1K0 721 388 G , 1K0 721 388 L , 1K0 721 388 F , 1K0 721 388 M , 1K0 721 388 S , 1K0 721 388 B | |
| | | VOLKSWAGEN | EOS (06-) | 3,6 V6 | | 05.2009 | 1K0 721 388 G , 1K0 721 388 L , 1K0 721 388 F , 1K0 721 388 M , 1K0 721 388 S , 1K0 721 388 B | |
| | | VOLKSWAGEN | EOS (06-) | 2,0 TSI | | 11.2009 | 1K0 721 388 G , 1K0 721 388 L , 1K0 721 388 F , 1K0 721 388 M , 1K0 721 388 S , 1K0 721 388 B | |
| | | VOLKSWAGEN | EOS (06-) | 2,0 TFSI | | 05.2006 | 1K0 721 388 G , 1K0 721 388 L , 1K0 721 388 F , 1K0 721 388 M , 1K0 721 388 S , 1K0 721 388 B | |
| | | VOLKSWAGEN | EOS (06-) | 2,0 TDI | | 05.2006 | 1K0 721 388 G , 1K0 721 388 L , 1K0 721 388 F , 1K0 721 388 M , 1K0 721 388 S , 1K0 721 388 B | |
| | | VOLKSWAGEN | EOS (06-) | 2,0 FSI | | 05.2006 | 1K0 721 388 G , 1K0 721 388 L , 1K0 721 388 F , 1K0 721 388 M , 1K0 721 388 S , 1K0 721 388 B | |



| | | | | | | |
|--|--|--|--|--|-------------------------------|--|
| | | | | | OE numbers per ATE pn. | e.g. replaced pn. / miscellaneous |
|--|--|--|--|--|-------------------------------|--|



KGZ - Clutch cylinder

| | | | | | | | | |
|----------------|--------|------------|-----------------|---------|--|---------|---|--|
| 24.2415-1711.3 | 030130 | VOLKSWAGEN | EOS (06-) | 1,6 FSI | | 05.2006 | 1K0 721 388 G , 1K0 721 388 L , 1K0 721 388 F , 1K0 721 388 M , 1K0 721 388 S , 1K0 721 388 B | |
| | | VOLKSWAGEN | EOS (06-) | 1,4 TSI | | 10.2007 | 1K0 721 388 G , 1K0 721 388 L , 1K0 721 388 F , 1K0 721 388 M , 1K0 721 388 S , 1K0 721 388 B | |
| | | VOLKSWAGEN | GOLF Plus (05-) | 1,9 TDI | | 01.2005 | 1K0 721 388 G , 1K0 721 388 L , 1K0 721 388 F , 1K0 721 388 M , 1K0 721 388 S , 1K0 721 388 B | |
| | | VOLKSWAGEN | GOLF Plus (05-) | 2,0 FSI | | 05.2005 | 1K0 721 388 G , 1K0 721 388 L , 1K0 721 388 F , 1K0 721 388 M , 1K0 721 388 S , 1K0 721 388 B | |
| | | VOLKSWAGEN | GOLF Plus (05-) | 2,0 TDI | | 01.2005 | 1K0 721 388 G , 1K0 721 388 L , 1K0 721 388 F , 1K0 721 388 M , 1K0 721 388 S , 1K0 721 388 B | |
| | | VOLKSWAGEN | GOLF Plus (05-) | | | 01.2009 | 1K0 721 388 G , 1K0 721 388 L , 1K0 721 388 F , 1K0 721 388 M , 1K0 721 388 S , 1K0 721 388 B | |
| | | VOLKSWAGEN | GOLF Plus (05-) | 1,6 TDI | | 02.2009 | 1K0 721 388 G , 1K0 721 388 L , 1K0 721 388 F , 1K0 721 388 M , 1K0 721 388 S , 1K0 721 388 B | |
| | | VOLKSWAGEN | GOLF Plus (05-) | 2,0 TDI | | 05.2005 | 1K0 721 388 G , 1K0 721 388 L , 1K0 721 388 F , 1K0 721 388 M , 1K0 721 388 S , 1K0 721 388 B | |



| | | | | | | |
|--|--|--|--|--|-------------------------------|--|
| | | | | | OE numbers per ATE pn. | e.g. replaced pn. / miscellaneous |
|--|--|--|--|--|-------------------------------|--|



KGZ - Clutch cylinder

| | | | | | | |
|----------------|--------|------------|-----------------|------------|---------|---|
| 24.2415-1711.3 | 030130 | VOLKSWAGEN | GOLF Plus (05-) | 1,4 TSI | 06.2007 | 1K0 721 388 G , 1K0 721 388 L , 1K0 721 388 F , 1K0 721 388 M , 1K0 721 388 S , 1K0 721 388 B |
| | | VOLKSWAGEN | GOLF Plus (05-) | 1,4 16V | 01.2005 | 1K0 721 388 G , 1K0 721 388 L , 1K0 721 388 F , 1K0 721 388 M , 1K0 721 388 S , 1K0 721 388 B |
| | | VOLKSWAGEN | GOLF Plus (05-) | 1,4 FSI | 07.2005 | 1K0 721 388 G , 1K0 721 388 L , 1K0 721 388 F , 1K0 721 388 M , 1K0 721 388 S , 1K0 721 388 B |
| | | VOLKSWAGEN | GOLF Plus (05-) | 1,4 TSI | 05.2006 | 1K0 721 388 G , 1K0 721 388 L , 1K0 721 388 F , 1K0 721 388 M , 1K0 721 388 S , 1K0 721 388 B |
| | | VOLKSWAGEN | GOLF Plus (05-) | | 06.2008 | 1K0 721 388 G , 1K0 721 388 L , 1K0 721 388 F , 1K0 721 388 M , 1K0 721 388 S , 1K0 721 388 B |
| | | VOLKSWAGEN | GOLF Plus (05-) | 1,6 | 05.2005 | 1K0 721 388 G , 1K0 721 388 L , 1K0 721 388 F , 1K0 721 388 M , 1K0 721 388 S , 1K0 721 388 B |
| | | VOLKSWAGEN | GOLF Plus (05-) | 1,9 TDI | 05.2005 | 1K0 721 388 G , 1K0 721 388 L , 1K0 721 388 F , 1K0 721 388 M , 1K0 721 388 S , 1K0 721 388 B |
| | | VOLKSWAGEN | GOLF Plus (05-) | 1,6 BiFuel | 05.2009 | 1K0 721 388 G , 1K0 721 388 L , 1K0 721 388 F , 1K0 721 388 M , 1K0 721 388 S , 1K0 721 388 B |



| | | | | | | |
|--|--|--|--|--|-------------------------------|--|
| | | | | | OE numbers per ATE pn. | e.g. replaced pn. / miscellaneous |
|--|--|--|--|--|-------------------------------|--|



KGZ - Clutch cylinder

| | | | | | | | | | |
|----------------|--------|------------|-----------------|-----------------|--|---------|---------|---|--|
| 24.2415-1711.3 | 030130 | VOLKSWAGEN | GOLF Plus (05-) | 1,6 FSI | | 01.2005 | | 1K0 721 388 G , 1K0 721 388 L , 1K0 721 388 F , 1K0 721 388 M , 1K0 721 388 S , 1K0 721 388 B | |
| | | VOLKSWAGEN | GOLF V (03-08) | 2,0 TDI | | 11.2005 | 09.2008 | 1K0 721 388 G , 1K0 721 388 L , 1K0 721 388 F , 1K0 721 388 M , 1K0 721 388 S , 1K0 721 388 B | |
| | | VOLKSWAGEN | GOLF V (03-08) | 3,2 R32 | | 11.2005 | 09.2008 | 1K0 721 388 G , 1K0 721 388 L , 1K0 721 388 F , 1K0 721 388 M , 1K0 721 388 S , 1K0 721 388 B | |
| | | VOLKSWAGEN | GOLF V (03-08) | 2,0 TDI | | 10.2003 | 09.2008 | 1K0 721 388 G , 1K0 721 388 L , 1K0 721 388 F , 1K0 721 388 M , 1K0 721 388 S , 1K0 721 388 B | |
| | | VOLKSWAGEN | GOLF V (03-08) | 1,4 FSI | | 10.2003 | 09.2008 | 1K0 721 388 G , 1K0 721 388 L , 1K0 721 388 F , 1K0 721 388 M , 1K0 721 388 S , 1K0 721 388 B | |
| | | VOLKSWAGEN | GOLF V (03-08) | 1,9 TDI 4motion | | 08.2004 | 09.2008 | 1K0 721 388 G , 1K0 721 388 L , 1K0 721 388 F , 1K0 721 388 M , 1K0 721 388 S , 1K0 721 388 B | |
| | | VOLKSWAGEN | GOLF V (03-08) | 1,4 TSI | | 05.2006 | 09.2008 | 1K0 721 388 G , 1K0 721 388 L , 1K0 721 388 F , 1K0 721 388 M , 1K0 721 388 S , 1K0 721 388 B | |
| | | VOLKSWAGEN | GOLF V (03-08) | 2,0 SDI | | 01.2004 | 09.2008 | 1K0 721 388 G , 1K0 721 388 L , 1K0 721 388 F , 1K0 721 388 M , 1K0 721 388 S , 1K0 721 388 B | |



| | | | | | | | |
|--|--|--|--|--|-------------------------------|--|--|
| | | | | | OE numbers per ATE pn. | | e.g. replaced pn. / miscellaneous |
|--|--|--|--|--|-------------------------------|--|--|



KGZ - Clutch cylinder

| | | | | | | | | | |
|----------------|---------------|------------|----------------|-----------------|--|---------|---------|---|--|
| 24.2415-1711.3 | 030130 | VOLKSWAGEN | GOLF V (03-08) | 2,0 GTI | | 09.2006 | 09.2008 | 1K0 721 388 G , 1K0 721 388 L , 1K0 721 388 F , 1K0 721 388 M , 1K0 721 388 S , 1K0 721 388 B | |
| | | VOLKSWAGEN | GOLF V (03-08) | | | 09.2004 | 09.2008 | 1K0 721 388 G , 1K0 721 388 L , 1K0 721 388 F , 1K0 721 388 M , 1K0 721 388 S , 1K0 721 388 B | |
| | | VOLKSWAGEN | GOLF V (03-08) | 2,0 FSI 4motion | | 08.2004 | 09.2008 | 1K0 721 388 G , 1K0 721 388 L , 1K0 721 388 F , 1K0 721 388 M , 1K0 721 388 S , 1K0 721 388 B | |
| | | VOLKSWAGEN | GOLF V (03-08) | 2,0 FSI | | 10.2003 | 09.2008 | 1K0 721 388 G , 1K0 721 388 L , 1K0 721 388 F , 1K0 721 388 M , 1K0 721 388 S , 1K0 721 388 B | |
| | | VOLKSWAGEN | GOLF V (03-08) | 1,4 TSI | | 05.2007 | 09.2008 | 1K0 721 388 G , 1K0 721 388 L , 1K0 721 388 F , 1K0 721 388 M , 1K0 721 388 S , 1K0 721 388 B | |
| | | VOLKSWAGEN | GOLF V (03-08) | | | 11.2005 | 09.2008 | 1K0 721 388 G , 1K0 721 388 L , 1K0 721 388 F , 1K0 721 388 M , 1K0 721 388 S , 1K0 721 388 B | |
| | | VOLKSWAGEN | GOLF V (03-08) | 2,0 TDI 4motion | | 08.2004 | 09.2008 | 1K0 721 388 G , 1K0 721 388 L , 1K0 721 388 F , 1K0 721 388 M , 1K0 721 388 S , 1K0 721 388 B | |
| | | VOLKSWAGEN | GOLF V (03-08) | 1,4 16V | | 10.2003 | 09.2008 | 1K0 721 388 G , 1K0 721 388 L , 1K0 721 388 F , 1K0 721 388 M , 1K0 721 388 S , 1K0 721 388 B | |



| | | | | | | | |
|--|--|--|--|--|-------------------------------|--|--|
| | | | | | OE numbers per ATE pn. | | e.g. replaced pn. / miscellaneous |
|--|--|--|--|--|-------------------------------|--|--|



KGZ - Clutch cylinder

| | | | | | | | | | |
|----------------|---------------|------------|------------------------|-----------------|--|---------|---------|---|--|
| 24.2415-1711.3 | 030130 | VOLKSWAGEN | GOLF V (03-08) | 1,9 TDI | | 10.2003 | 09.2008 | 1K0 721 388 G , 1K0 721 388 L , 1K0 721 388 F , 1K0 721 388 M , 1K0 721 388 S , 1K0 721 388 B | |
| | | VOLKSWAGEN | GOLF V (03-08) | | | 05.2004 | 09.2008 | 1K0 721 388 G , 1K0 721 388 L , 1K0 721 388 F , 1K0 721 388 M , 1K0 721 388 S , 1K0 721 388 B | |
| | | VOLKSWAGEN | GOLF V (03-08) | 1,6 FSI | | 10.2003 | 09.2008 | 1K0 721 388 G , 1K0 721 388 L , 1K0 721 388 F , 1K0 721 388 M , 1K0 721 388 S , 1K0 721 388 B | |
| | | VOLKSWAGEN | GOLF V (03-08) | 1,6 16V | | 01.2004 | 09.2008 | 1K0 721 388 G , 1K0 721 388 L , 1K0 721 388 F , 1K0 721 388 M , 1K0 721 388 S , 1K0 721 388 B | |
| | | VOLKSWAGEN | GOLF V Variant (07-09) | 1,9 TDI 4motion | | 12.2007 | 06.2009 | 1K0 721 388 G , 1K0 721 388 L , 1K0 721 388 F , 1K0 721 388 M , 1K0 721 388 S , 1K0 721 388 B | |
| | | VOLKSWAGEN | GOLF V Variant (07-09) | 2 | | 06.2007 | 06.2009 | 1K0 721 388 G , 1K0 721 388 L , 1K0 721 388 F , 1K0 721 388 M , 1K0 721 388 S , 1K0 721 388 B | |
| | | VOLKSWAGEN | GOLF V Variant (07-09) | 1,9 TDI | | 05.2007 | 06.2009 | 1K0 721 388 G , 1K0 721 388 L , 1K0 721 388 F , 1K0 721 388 M , 1K0 721 388 S , 1K0 721 388 B | |
| | | VOLKSWAGEN | GOLF V Variant (07-09) | 1,6 | | 05.2007 | 06.2009 | 1K0 721 388 G , 1K0 721 388 L , 1K0 721 388 F , 1K0 721 388 M , 1K0 721 388 S , 1K0 721 388 B | |



| | | | | | | | |
|--|--|--|--|--|-------------------------------|--|--|
| | | | | | OE numbers per ATE pn. | | e.g. replaced pn. / miscellaneous |
|--|--|--|--|--|-------------------------------|--|--|



KGZ - Clutch cylinder

| | | | | | | | | | |
|----------------|---------------|------------|------------------------|-------------|--|---------|---------|---|--|
| 24.2415-1711.3 | 030130 | VOLKSWAGEN | GOLF V Variant (07-09) | 1,4 TSI | | 07.2008 | 06.2009 | 1K0 721 388 G , 1K0 721 388 L , 1K0 721 388 F , 1K0 721 388 M , 1K0 721 388 S , 1K0 721 388 B | |
| | | VOLKSWAGEN | GOLF V Variant (07-09) | | | 05.2007 | 06.2009 | 1K0 721 388 G , 1K0 721 388 L , 1K0 721 388 F , 1K0 721 388 M , 1K0 721 388 S , 1K0 721 388 B | |
| | | VOLKSWAGEN | GOLF V Variant (07-09) | 1,4 | | 06.2007 | 06.2009 | 1K0 721 388 G , 1K0 721 388 L , 1K0 721 388 F , 1K0 721 388 M , 1K0 721 388 S , 1K0 721 388 B | |
| | | VOLKSWAGEN | GOLF V Variant (07-09) | 2,0 TDI | | 05.2007 | 06.2009 | 1K0 721 388 G , 1K0 721 388 L , 1K0 721 388 F , 1K0 721 388 M , 1K0 721 388 S , 1K0 721 388 B | |
| | | VOLKSWAGEN | GOLF V Variant (07-09) | 1,4 TSI | | 06.2007 | 06.2009 | 1K0 721 388 G , 1K0 721 388 L , 1K0 721 388 F , 1K0 721 388 M , 1K0 721 388 S , 1K0 721 388 B | |
| | | VOLKSWAGEN | GOLF VI (08-) | 1,6 Bi-Fuel | | 03.2009 | | 1K0 721 388 G , 1K0 721 388 L , 1K0 721 388 F , 1K0 721 388 M , 1K0 721 388 S , 1K0 721 388 B | |
| | | VOLKSWAGEN | GOLF VI (08-) | 2,5 FSI | | 08.2009 | | 1K0 721 388 G , 1K0 721 388 L , 1K0 721 388 F , 1K0 721 388 M , 1K0 721 388 S , 1K0 721 388 B | |
| | | VOLKSWAGEN | GOLF VI (08-) | 2,0 TSI | | 07.2009 | | 1K0 721 388 G , 1K0 721 388 L , 1K0 721 388 F , 1K0 721 388 M , 1K0 721 388 S , 1K0 721 388 B | |



| | | | | | | |
|--|--|----------|--|--|-------------------------------|---|
| | | i | | | OE numbers per ATE pn. | i e.g. replaced pn. / miscellaneous |
|--|--|----------|--|--|-------------------------------|---|



KGZ - Clutch cylinder

| | | | | | | | | |
|----------------|---------------|------------|---------------|-----------------|--|---------|---|--|
| 24.2415-1711.3 | 030130 | VOLKSWAGEN | GOLF VI (08-) | 2,0 TDI 4motion | | 10.2008 | 1K0 721 388 G , 1K0 721 388 L , 1K0 721 388 F , 1K0 721 388 M , 1K0 721 388 S , 1K0 721 388 B | |
| | | VOLKSWAGEN | GOLF VI (08-) | 2,0 TDI | | 10.2008 | 1K0 721 388 G , 1K0 721 388 L , 1K0 721 388 F , 1K0 721 388 M , 1K0 721 388 S , 1K0 721 388 B | |
| | | VOLKSWAGEN | GOLF VI (08-) | | | 04.2009 | 1K0 721 388 G , 1K0 721 388 L , 1K0 721 388 F , 1K0 721 388 M , 1K0 721 388 S , 1K0 721 388 B | |
| | | VOLKSWAGEN | GOLF VI (08-) | 2,0 R 4motion | | 11.2009 | 1K0 721 388 G , 1K0 721 388 L , 1K0 721 388 F , 1K0 721 388 M , 1K0 721 388 S , 1K0 721 388 B | |
| | | VOLKSWAGEN | GOLF VI (08-) | 1,6 TDI | | 02.2009 | 1K0 721 388 G , 1K0 721 388 L , 1K0 721 388 F , 1K0 721 388 M , 1K0 721 388 S , 1K0 721 388 B | |
| | | VOLKSWAGEN | GOLF VI (08-) | 1,6 | | 10.2008 | 1K0 721 388 G , 1K0 721 388 L , 1K0 721 388 F , 1K0 721 388 M , 1K0 721 388 S , 1K0 721 388 B | |
| | | VOLKSWAGEN | GOLF VI (08-) | 1,4 TSI | | 10.2008 | 1K0 721 388 G , 1K0 721 388 L , 1K0 721 388 F , 1K0 721 388 M , 1K0 721 388 S , 1K0 721 388 B | |
| | | VOLKSWAGEN | GOLF VI (08-) | 1,4 | | 10.2008 | 1K0 721 388 G , 1K0 721 388 L , 1K0 721 388 F , 1K0 721 388 M , 1K0 721 388 S , 1K0 721 388 B | |



| | | | | | | |
|--|--|--|--|--|-------------------------------|--|
| | | | | | OE numbers per ATE pn. | e.g. replaced pn. / miscellaneous |
|--|--|--|--|--|-------------------------------|--|



KGZ - Clutch cylinder

| | | | | | | | | | |
|----------------|--------|------------|-----------------|----------|--|---------|---------|---|--|
| 24.2415-1711.3 | 030130 | VOLKSWAGEN | GOLF VI (08-) | 1,2 TSI | | 05.2009 | | 1K0 721 388 G , 1K0 721 388 L , 1K0 721 388 F , 1K0 721 388 M , 1K0 721 388 S , 1K0 721 388 B | |
| | | VOLKSWAGEN | GOLF VI (08-) | 2,0 GTI | | 03.2009 | | 1K0 721 388 G , 1K0 721 388 L , 1K0 721 388 F , 1K0 721 388 M , 1K0 721 388 S , 1K0 721 388 B | |
| | | VOLKSWAGEN | JETTA V (05-10) | 2,0 TDI | | 08.2005 | 10.2010 | 1K0 721 388 G , 1K0 721 388 L , 1K0 721 388 F , 1K0 721 388 M , 1K0 721 388 S , 1K0 721 388 B | |
| | | VOLKSWAGEN | JETTA V (05-10) | 2,5 FSI | | 07.2008 | 10.2010 | 1K0 721 388 G , 1K0 721 388 L , 1K0 721 388 F , 1K0 721 388 M , 1K0 721 388 S , 1K0 721 388 B | |
| | | VOLKSWAGEN | JETTA V (05-10) | 1,9 TDI | | 08.2005 | 10.2010 | 1K0 721 388 G , 1K0 721 388 L , 1K0 721 388 F , 1K0 721 388 M , 1K0 721 388 S , 1K0 721 388 B | |
| | | VOLKSWAGEN | JETTA V (05-10) | 1,6 TDI | | 06.2009 | 10.2010 | 1K0 721 388 G , 1K0 721 388 L , 1K0 721 388 F , 1K0 721 388 M , 1K0 721 388 S , 1K0 721 388 B | |
| | | VOLKSWAGEN | JETTA V (05-10) | 2,0 TFSI | | 10.2005 | 10.2010 | 1K0 721 388 G , 1K0 721 388 L , 1K0 721 388 F , 1K0 721 388 M , 1K0 721 388 S , 1K0 721 388 B | |
| | | VOLKSWAGEN | JETTA V (05-10) | 2,0 FSI | | 08.2005 | 10.2010 | 1K0 721 388 G , 1K0 721 388 L , 1K0 721 388 F , 1K0 721 388 M , 1K0 721 388 S , 1K0 721 388 B | |



| | | | | | | |
|--|--|--|--|--|-------------------------------|--|
| | | | | | OE numbers per ATE pn. | e.g. replaced pn. / miscellaneous |
|--|--|--|--|--|-------------------------------|--|



KGZ - Clutch cylinder

| | | | | | | | |
|----------------|--------|------------|---------------------|-----------|---------|---------|---|
| 24.2415-1711.3 | 030130 | VOLKSWAGEN | JETTA V (05-10) | 2,0 TDI | 09.2005 | 10.2010 | 1K0 721 388 G , 1K0 721 388 L , 1K0 721 388 F , 1K0 721 388 M , 1K0 721 388 S , 1K0 721 388 B |
| | | VOLKSWAGEN | JETTA V (05-10) | 1,6 FSI | 08.2005 | 10.2010 | 1K0 721 388 G , 1K0 721 388 L , 1K0 721 388 F , 1K0 721 388 M , 1K0 721 388 S , 1K0 721 388 B |
| | | VOLKSWAGEN | JETTA V (05-10) | 1,4 TSI | 07.2008 | 10.2010 | 1K0 721 388 G , 1K0 721 388 L , 1K0 721 388 F , 1K0 721 388 M , 1K0 721 388 S , 1K0 721 388 B |
| | | VOLKSWAGEN | JETTA V (05-10) | | 06.2006 | 10.2010 | 1K0 721 388 G , 1K0 721 388 L , 1K0 721 388 F , 1K0 721 388 M , 1K0 721 388 S , 1K0 721 388 B |
| | | VOLKSWAGEN | JETTA V (05-10) | | 05.2007 | 10.2010 | 1K0 721 388 G , 1K0 721 388 L , 1K0 721 388 F , 1K0 721 388 M , 1K0 721 388 S , 1K0 721 388 B |
| | | VOLKSWAGEN | JETTA V (05-10) | 2,0 TDI | 06.2006 | 10.2010 | 1K0 721 388 G , 1K0 721 388 L , 1K0 721 388 F , 1K0 721 388 M , 1K0 721 388 S , 1K0 721 388 B |
| | | VOLKSWAGEN | JETTA V (05-10) | 1,6 i 16V | 08.2005 | 10.2010 | 1K0 721 388 G , 1K0 721 388 L , 1K0 721 388 F , 1K0 721 388 M , 1K0 721 388 S , 1K0 721 388 B |
| | | SEAT | LEON II (1P1) (05-) | 1,6 LPG | 12.2009 | | 1K0 721 388 G , 1K0 721 388 L , 1K0 721 388 F , 1K0 721 388 M , 1K0 721 388 S , 1K0 721 388 B |



| | | | | | | |
|--|--|--|--|--|-------------------------------|--|
| | | | | | OE numbers per ATE pn. | e.g. replaced pn. / miscellaneous |
|--|--|--|--|--|-------------------------------|--|



KGZ - Clutch cylinder

| | | | | | | | | |
|----------------|---------------|------|---------------------|-----------|--|---------|---|--|
| 24.2415-1711.3 | 030130 | SEAT | LEON II (1P1) (05-) | 2,0 TFSI | | 09.2005 | 1K0 721 388 G , 1K0 721 388 L , 1K0 721 388 F , 1K0 721 388 M , 1K0 721 388 S , 1K0 721 388 B | |
| | | SEAT | LEON II (1P1) (05-) | 2,0 TDI | | 08.2005 | 1K0 721 388 G , 1K0 721 388 L , 1K0 721 388 F , 1K0 721 388 M , 1K0 721 388 S , 1K0 721 388 B | |
| | | SEAT | LEON II (1P1) (05-) | | | 02.2006 | 1K0 721 388 G , 1K0 721 388 L , 1K0 721 388 F , 1K0 721 388 M , 1K0 721 388 S , 1K0 721 388 B | |
| | | SEAT | LEON II (1P1) (05-) | 2,0 i 16V | | 08.2005 | 1K0 721 388 G , 1K0 721 388 L , 1K0 721 388 F , 1K0 721 388 M , 1K0 721 388 S , 1K0 721 388 B | |
| | | SEAT | LEON II (1P1) (05-) | 2,0 FSI | | 08.2005 | 1K0 721 388 G , 1K0 721 388 L , 1K0 721 388 F , 1K0 721 388 M , 1K0 721 388 S , 1K0 721 388 B | |
| | | SEAT | LEON II (1P1) (05-) | 1,9 TDI | | 08.2005 | 1K0 721 388 G , 1K0 721 388 L , 1K0 721 388 F , 1K0 721 388 M , 1K0 721 388 S , 1K0 721 388 B | |
| | | SEAT | LEON II (1P1) (05-) | 1,8 TSI | | 06.2007 | 1K0 721 388 G , 1K0 721 388 L , 1K0 721 388 F , 1K0 721 388 M , 1K0 721 388 S , 1K0 721 388 B | |
| | | SEAT | LEON II (1P1) (05-) | 1,8 T 20V | | 08.2005 | 1K0 721 388 G , 1K0 721 388 L , 1K0 721 388 F , 1K0 721 388 M , 1K0 721 388 S , 1K0 721 388 B | |



| | | | | | | | |
|--|--|--|--|--|-------------------------------|--|--|
| | | | | | OE numbers per ATE pn. | | e.g. replaced pn. / miscellaneous |
|--|--|--|--|--|-------------------------------|--|--|



KGZ - Clutch cylinder

| | | | | | | | | |
|----------------|---------------|------|---------------------|-----------|--|---------|---|--|
| 24.2415-1711.3 | 030130 | SEAT | LEON II (1P1) (05-) | 1,6 TDI | | 11.2010 | 1K0 721 388 G , 1K0 721 388 L , 1K0 721 388 F , 1K0 721 388 M , 1K0 721 388 S , 1K0 721 388 B | |
| | | SEAT | LEON II (1P1) (05-) | 2,0 TFSI | | 11.2006 | 1K0 721 388 G , 1K0 721 388 L , 1K0 721 388 F , 1K0 721 388 M , 1K0 721 388 S , 1K0 721 388 B | |
| | | SEAT | LEON II (1P1) (05-) | 1,6 i 16V | | 08.2005 | 1K0 721 388 G , 1K0 721 388 L , 1K0 721 388 F , 1K0 721 388 M , 1K0 721 388 S , 1K0 721 388 B | |
| | | SEAT | LEON II (1P1) (05-) | 1,6 i | | 08.2005 | 1K0 721 388 G , 1K0 721 388 L , 1K0 721 388 F , 1K0 721 388 M , 1K0 721 388 S , 1K0 721 388 B | |
| | | SEAT | LEON II (1P1) (05-) | 1,4 TSI | | 11.2007 | 1K0 721 388 G , 1K0 721 388 L , 1K0 721 388 F , 1K0 721 388 M , 1K0 721 388 S , 1K0 721 388 B | |
| | | SEAT | LEON II (1P1) (05-) | 1,4 i 16V | | 08.2005 | 1K0 721 388 G , 1K0 721 388 L , 1K0 721 388 F , 1K0 721 388 M , 1K0 721 388 S , 1K0 721 388 B | |
| | | SEAT | LEON II (1P1) (05-) | | | 06.2006 | 1K0 721 388 G , 1K0 721 388 L , 1K0 721 388 F , 1K0 721 388 M , 1K0 721 388 S , 1K0 721 388 B | |
| | | SEAT | LEON II (1P1) (05-) | 1,2 TSI | | 02.2010 | 1K0 721 388 G , 1K0 721 388 L , 1K0 721 388 F , 1K0 721 388 M , 1K0 721 388 S , 1K0 721 388 B | |



| | | | | | | | |
|--|--|--|--|--|-------------------------------|--|--|
| | | | | | OE numbers per ATE pn. | | e.g. replaced pn. / miscellaneous |
|--|--|--|--|--|-------------------------------|--|--|



KGZ - Clutch cylinder

| | | | | | | | | |
|----------------|---------------|-------|-----------------------|-------------------|--|---------|---|--|
| 24.2415-1711.3 | 030130 | SEAT | LEON II (1P1) (05-) | 1,6 TDI Ecomotive | | 02.2010 | 1K0 721 388 G , 1K0 721 388 L , 1K0 721 388 F , 1K0 721 388 M , 1K0 721 388 S , 1K0 721 388 B | |
| | | SEAT | LEON II (1P1) (05-) | 2,0 TFSI | | 08.2005 | 1K0 721 388 G , 1K0 721 388 L , 1K0 721 388 F , 1K0 721 388 M , 1K0 721 388 S , 1K0 721 388 B | |
| | | SKODA | OCTAVIA II (1Z) (04-) | 1,6 | | 09.2009 | 1K0 721 388 G , 1K0 721 388 L , 1K0 721 388 F , 1K0 721 388 M , 1K0 721 388 S , 1K0 721 388 B | |
| | | SKODA | OCTAVIA II (1Z) (04-) | 2,0 TDI | | 04.2008 | 1K0 721 388 G , 1K0 721 388 L , 1K0 721 388 F , 1K0 721 388 M , 1K0 721 388 S , 1K0 721 388 B | |
| | | SKODA | OCTAVIA II (1Z) (04-) | 2,0 FSI | | 11.2004 | 1K0 721 388 G , 1K0 721 388 L , 1K0 721 388 F , 1K0 721 388 M , 1K0 721 388 S , 1K0 721 388 B | |
| | | SKODA | OCTAVIA II (1Z) (04-) | 1,9 TDI | | 06.2004 | 1K0 721 388 G , 1K0 721 388 L , 1K0 721 388 F , 1K0 721 388 M , 1K0 721 388 S , 1K0 721 388 B | |
| | | SKODA | OCTAVIA II (1Z) (04-) | 1,8 TSI 4x4 | | 11.2008 | 1K0 721 388 G , 1K0 721 388 L , 1K0 721 388 F , 1K0 721 388 M , 1K0 721 388 S , 1K0 721 388 B | |
| | | SKODA | OCTAVIA II (1Z) (04-) | 1,8 TSI | | 06.2007 | 1K0 721 388 G , 1K0 721 388 L , 1K0 721 388 F , 1K0 721 388 M , 1K0 721 388 S , 1K0 721 388 B | |



| | | | | | | | |
|--|--|--|--|--|-------------------------------|--|--|
| | | | | | OE numbers per ATE pn. | | e.g. replaced pn. / miscellaneous |
|--|--|--|--|--|-------------------------------|--|--|



KGZ - Clutch cylinder

| | | | | | | | | |
|----------------|---------------|-------|-----------------------|-------------|--|---------|---|--|
| 24.2415-1711.3 | 030130 | SKODA | OCTAVIA II (1Z) (04-) | 1,6 TDI 4x4 | | 06.2009 | 1K0 721 388 G , 1K0 721 388 L , 1K0 721 388 F , 1K0 721 388 M , 1K0 721 388 S , 1K0 721 388 B | |
| | | SKODA | OCTAVIA II (1Z) (04-) | 1,6 TDI | | 06.2009 | 1K0 721 388 G , 1K0 721 388 L , 1K0 721 388 F , 1K0 721 388 M , 1K0 721 388 S , 1K0 721 388 B | |
| | | SKODA | OCTAVIA II (1Z) (04-) | 2,0 TDI | | 06.2004 | 1K0 721 388 G , 1K0 721 388 L , 1K0 721 388 F , 1K0 721 388 M , 1K0 721 388 S , 1K0 721 388 B | |
| | | SKODA | OCTAVIA II (1Z) (04-) | 1,6 FSI | | 06.2004 | 1K0 721 388 G , 1K0 721 388 L , 1K0 721 388 F , 1K0 721 388 M , 1K0 721 388 S , 1K0 721 388 B | |
| | | SKODA | OCTAVIA II (1Z) (04-) | 1,4 TSI | | 11.2008 | 1K0 721 388 G , 1K0 721 388 L , 1K0 721 388 F , 1K0 721 388 M , 1K0 721 388 S , 1K0 721 388 B | |
| | | SKODA | OCTAVIA II (1Z) (04-) | 1,4 i 16V | | 06.2004 | 1K0 721 388 G , 1K0 721 388 L , 1K0 721 388 F , 1K0 721 388 M , 1K0 721 388 S , 1K0 721 388 B | |
| | | SKODA | OCTAVIA II (1Z) (04-) | 1,2 TSI | | 02.2010 | 1K0 721 388 G , 1K0 721 388 L , 1K0 721 388 F , 1K0 721 388 M , 1K0 721 388 S , 1K0 721 388 B | |
| | | SKODA | OCTAVIA II (1Z) (04-) | 1,6 i 16V | | 06.2004 | 1K0 721 388 G , 1K0 721 388 L , 1K0 721 388 F , 1K0 721 388 M , 1K0 721 388 S , 1K0 721 388 B | |



| | | | | | | |
|--|--|--|--|--|-------------------------------|--|
| | | | | | OE numbers per ATE pn. | e.g. replaced pn. / miscellaneous |
|--|--|--|--|--|-------------------------------|--|



KGZ - Clutch cylinder

| | | | | | | | | |
|----------------|--------|------------|-----------------|-------------|--|---------|---|--|
| 24.2415-1711.3 | 030130 | VOLKSWAGEN | SCIROCCO (08-) | 2,0 R | | 11.2009 | 1K0 721 388 G , 1K0 721 388 L , 1K0 721 388 F , 1K0 721 388 M , 1K0 721 388 S , 1K0 721 388 B | |
| | | VOLKSWAGEN | SCIROCCO (08-) | 2,0 TSI | | 08.2008 | 1K0 721 388 G , 1K0 721 388 L , 1K0 721 388 F , 1K0 721 388 M , 1K0 721 388 S , 1K0 721 388 B | |
| | | VOLKSWAGEN | SCIROCCO (08-) | 2,0 TDI | | 10.2008 | 1K0 721 388 G , 1K0 721 388 L , 1K0 721 388 F , 1K0 721 388 M , 1K0 721 388 S , 1K0 721 388 B | |
| | | VOLKSWAGEN | SCIROCCO (08-) | | | 05.2009 | 1K0 721 388 G , 1K0 721 388 L , 1K0 721 388 F , 1K0 721 388 M , 1K0 721 388 S , 1K0 721 388 B | |
| | | VOLKSWAGEN | SCIROCCO (08-) | 1,4 TSI | | 09.2008 | 1K0 721 388 G , 1K0 721 388 L , 1K0 721 388 F , 1K0 721 388 M , 1K0 721 388 S , 1K0 721 388 B | |
| | | VOLKSWAGEN | SCIROCCO (08-) | | | 08.2008 | 1K0 721 388 G , 1K0 721 388 L , 1K0 721 388 F , 1K0 721 388 M , 1K0 721 388 S , 1K0 721 388 B | |
| | | SKODA | SUPERB II (08-) | 3,6 V6 FSI | | 11.2008 | 1K0 721 388 G , 1K0 721 388 L , 1K0 721 388 F , 1K0 721 388 M , 1K0 721 388 S , 1K0 721 388 B | |
| | | SKODA | SUPERB II (08-) | 2,0 TDI 4x4 | | 10.2008 | 1K0 721 388 G , 1K0 721 388 L , 1K0 721 388 F , 1K0 721 388 M , 1K0 721 388 S , 1K0 721 388 B | |



| | | | | | | | |
|--|--|--|--|--|-------------------------------|--|--|
| | | | | | OE numbers per ATE pn. | | e.g. replaced pn. / miscellaneous |
|--|--|--|--|--|-------------------------------|--|--|



KGZ - Clutch cylinder

| | | | | | | |
|----------------|---------------|-------|---------------------|--------------|---------|---|
| 24.2415-1711.3 | 030130 | SKODA | SUPERB II (08-) | 2,0 TDI | 08.2008 | 1K0 721 388 G , 1K0 721 388 L , 1K0 721 388 F , 1K0 721 388 M , 1K0 721 388 S , 1K0 721 388 B |
| | | SKODA | SUPERB II (08-) | 1,9 TDI | 08.2008 | 1K0 721 388 G , 1K0 721 388 L , 1K0 721 388 F , 1K0 721 388 M , 1K0 721 388 S , 1K0 721 388 B |
| | | SKODA | SUPERB II (08-) | 1,8 TFSI 4x4 | 10.2008 | 1K0 721 388 G , 1K0 721 388 L , 1K0 721 388 F , 1K0 721 388 M , 1K0 721 388 S , 1K0 721 388 B |
| | | SKODA | SUPERB II (08-) | 1,8 TFSI | 08.2008 | 1K0 721 388 G , 1K0 721 388 L , 1K0 721 388 F , 1K0 721 388 M , 1K0 721 388 S , 1K0 721 388 B |
| | | SKODA | SUPERB II (08-) | 1,6 i 16V | 08.2008 | 1K0 721 388 G , 1K0 721 388 L , 1K0 721 388 F , 1K0 721 388 M , 1K0 721 388 S , 1K0 721 388 B |
| | | SKODA | SUPERB II (08-) | 1,4 TSI | 08.2008 | 1K0 721 388 G , 1K0 721 388 L , 1K0 721 388 F , 1K0 721 388 M , 1K0 721 388 S , 1K0 721 388 B |
| | | SKODA | SUPERB Estate (09-) | 1,8 TSI 4x4 | 11.2009 | 1K0 721 388 G , 1K0 721 388 L , 1K0 721 388 F , 1K0 721 388 M , 1K0 721 388 S , 1K0 721 388 B |
| | | SKODA | SUPERB Estate (09-) | 3,6 V6 4x4 | 11.2009 | 1K0 721 388 G , 1K0 721 388 L , 1K0 721 388 F , 1K0 721 388 M , 1K0 721 388 S , 1K0 721 388 B |



| | | | | | | | |
|--|--|--|--|--|-------------------------------|--|--|
| | | | | | OE numbers per ATE pn. | | e.g. replaced pn. / miscellaneous |
|--|--|--|--|--|-------------------------------|--|--|



KGZ - Clutch cylinder

| | | | | | | | | | |
|----------------|---------------|-------|--------------------------|-------------|--|---------|---------|---|--|
| 24.2415-1711.3 | 030130 | SKODA | SUPERB Estate (09-) | 2,0 TDI | | 11.2009 | | 1K0 721 388 G , 1K0 721 388 L , 1K0 721 388 F , 1K0 721 388 M , 1K0 721 388 S , 1K0 721 388 B | |
| | | SKODA | SUPERB Estate (09-) | 1,8 TSI | | 11.2009 | | 1K0 721 388 G , 1K0 721 388 L , 1K0 721 388 F , 1K0 721 388 M , 1K0 721 388 S , 1K0 721 388 B | |
| | | SKODA | SUPERB Estate (09-) | 1,4 TSI | | 11.2009 | | 1K0 721 388 G , 1K0 721 388 L , 1K0 721 388 F , 1K0 721 388 M , 1K0 721 388 S , 1K0 721 388 B | |
| | | SKODA | SUPERB Estate (09-) | 2,0 TDI 4x4 | | 11.2009 | | 1K0 721 388 G , 1K0 721 388 L , 1K0 721 388 F , 1K0 721 388 M , 1K0 721 388 S , 1K0 721 388 B | |
| | | SEAT | TOLEDO III (5P2) (05-09) | 2,0 TFSI | | 11.2005 | 03.2009 | 1K0 721 388 G , 1K0 721 388 L , 1K0 721 388 F , 1K0 721 388 M , 1K0 721 388 S , 1K0 721 388 B | |
| | | SEAT | TOLEDO III (5P2) (05-09) | 1,6 i 16V | | 10.2004 | 03.2009 | 1K0 721 388 G , 1K0 721 388 L , 1K0 721 388 F , 1K0 721 388 M , 1K0 721 388 S , 1K0 721 388 B | |
| | | SEAT | TOLEDO III (5P2) (05-09) | 1,8 TFSI | | 01.2007 | 03.2009 | 1K0 721 388 G , 1K0 721 388 L , 1K0 721 388 F , 1K0 721 388 M , 1K0 721 388 S , 1K0 721 388 B | |
| | | SEAT | TOLEDO III (5P2) (05-09) | 1,9 TDI | | 10.2004 | 03.2009 | 1K0 721 388 G , 1K0 721 388 L , 1K0 721 388 F , 1K0 721 388 M , 1K0 721 388 S , 1K0 721 388 B | |



| | | | | | | |
|--|--|--|--|--|-------------------------------|--|
| | | | | | OE numbers per ATE pn. | e.g. replaced pn. / miscellaneous |
|--|--|--|--|--|-------------------------------|--|



KGZ - Clutch cylinder

| | | | | | | | | | |
|----------------|---------------|------------|--------------------------|-----------|--|---------|---------|---|--|
| 24.2415-1711.3 | 030130 | SEAT | TOLEDO III (5P2) (05-09) | 2,0 FSI | | 10.2004 | 03.2009 | 1K0 721 388 G , 1K0 721 388 L , 1K0 721 388 F , 1K0 721 388 M , 1K0 721 388 S , 1K0 721 388 B | |
| | | SEAT | TOLEDO III (5P2) (05-09) | 2,0 i 16V | | 10.2004 | 03.2009 | 1K0 721 388 G , 1K0 721 388 L , 1K0 721 388 F , 1K0 721 388 M , 1K0 721 388 S , 1K0 721 388 B | |
| | | SEAT | TOLEDO III (5P2) (05-09) | 2,0 TDI | | 01.2006 | 03.2009 | 1K0 721 388 G , 1K0 721 388 L , 1K0 721 388 F , 1K0 721 388 M , 1K0 721 388 S , 1K0 721 388 B | |
| | | SEAT | TOLEDO III (5P2) (05-09) | | | 10.2004 | 03.2009 | 1K0 721 388 G , 1K0 721 388 L , 1K0 721 388 F , 1K0 721 388 M , 1K0 721 388 S , 1K0 721 388 B | |
| | | VOLKSWAGEN | TOURAN (03-) | 1,4 TSI | | 11.2006 | 10.2009 | 1K0 721 388 G , 1K0 721 388 L , 1K0 721 388 F , 1K0 721 388 M , 1K0 721 388 S , 1K0 721 388 B | |
| | | VOLKSWAGEN | TOURAN (03-) | | | 09.2006 | 10.2009 | 1K0 721 388 G , 1K0 721 388 L , 1K0 721 388 F , 1K0 721 388 M , 1K0 721 388 S , 1K0 721 388 B | |
| | | VOLKSWAGEN | TOURAN (03-) | 1,4 FSI | | 01.2006 | 10.2009 | 1K0 721 388 G , 1K0 721 388 L , 1K0 721 388 F , 1K0 721 388 M , 1K0 721 388 S , 1K0 721 388 B | |
| | | VOLKSWAGEN | TOURAN (03-) | 2,0 TDI | | 08.2003 | 10.2009 | 1K0 721 388 G , 1K0 721 388 L , 1K0 721 388 F , 1K0 721 388 M , 1K0 721 388 S , 1K0 721 388 B | |



| | | | | | | |
|--|--|--|--|--|-------------------------------|--|
| | | | | | OE numbers per ATE pn. | e.g. replaced pn. / miscellaneous |
|--|--|--|--|--|-------------------------------|--|



KGZ - Clutch cylinder

| | | | | | | | | | |
|----------------|--------|------------|--------------|-----------------|--|---------|---------|---|--|
| 24.2415-1711.3 | 030130 | VOLKSWAGEN | TOURAN (03-) | 2,0 TDI | | 02.2006 | 10.2009 | 1K0 721 388 G , 1K0 721 388 L , 1K0 721 388 F , 1K0 721 388 M , 1K0 721 388 S , 1K0 721 388 B | |
| | | VOLKSWAGEN | TOURAN (03-) | | | 02.2003 | 10.2009 | 1K0 721 388 G , 1K0 721 388 L , 1K0 721 388 F , 1K0 721 388 M , 1K0 721 388 S , 1K0 721 388 B | |
| | | VOLKSWAGEN | TOURAN (03-) | 1,4 TSI EcoFuel | | 05.2009 | 10.2009 | 1K0 721 388 G , 1K0 721 388 L , 1K0 721 388 F , 1K0 721 388 M , 1K0 721 388 S , 1K0 721 388 B | |
| | | VOLKSWAGEN | TOURAN (03-) | 2,0 FSI | | 10.2003 | 10.2009 | 1K0 721 388 G , 1K0 721 388 L , 1K0 721 388 F , 1K0 721 388 M , 1K0 721 388 S , 1K0 721 388 B | |
| | | VOLKSWAGEN | TOURAN (03-) | | | 10.2004 | 10.2009 | 1K0 721 388 G , 1K0 721 388 L , 1K0 721 388 F , 1K0 721 388 M , 1K0 721 388 S , 1K0 721 388 B | |
| | | VOLKSWAGEN | TOURAN (03-) | 1,6 | | 07.2003 | 10.2009 | 1K0 721 388 G , 1K0 721 388 L , 1K0 721 388 F , 1K0 721 388 M , 1K0 721 388 S , 1K0 721 388 B | |
| | | VOLKSWAGEN | TOURAN (03-) | 1,6 FSI | | 02.2003 | 10.2009 | 1K0 721 388 G , 1K0 721 388 L , 1K0 721 388 F , 1K0 721 388 M , 1K0 721 388 S , 1K0 721 388 B | |
| | | VOLKSWAGEN | TOURAN (03-) | 2,0 Eco Fuel | | 02.2006 | 10.2009 | 1K0 721 388 G , 1K0 721 388 L , 1K0 721 388 F , 1K0 721 388 M , 1K0 721 388 S , 1K0 721 388 B | |



| | | | | | | |
|--|--|--|--|--|-------------------------------|--|
| | | | | | OE numbers per ATE pn. | e.g. replaced pn. / miscellaneous |
|--|--|--|--|--|-------------------------------|--|



KGZ - Clutch cylinder

| | | | | | | | | | |
|----------------|--------|------------|----------------|---------------------|--|---------|---------|---|--|
| 24.2415-1711.3 | 030130 | VOLKSWAGEN | TOURAN (03-) | 1,9 TDI | | 02.2003 | 10.2009 | 1K0 721 388 G , 1K0 721 388 L , 1K0 721 388 F , 1K0 721 388 M , 1K0 721 388 S , 1K0 721 388 B | |
| | | VOLKSWAGEN | TOURAN (03-) | | | 08.2003 | 10.2009 | 1K0 721 388 G , 1K0 721 388 L , 1K0 721 388 F , 1K0 721 388 M , 1K0 721 388 S , 1K0 721 388 B | |
| | | VOLKSWAGEN | TOURAN (03-) | | | 11.2004 | 10.2009 | 1K0 721 388 G , 1K0 721 388 L , 1K0 721 388 F , 1K0 721 388 M , 1K0 721 388 S , 1K0 721 388 B | |
| | | AUDI | TT Coupe (06-) | 3,2 Quattro | | 07.2006 | | 1K0 721 388 G , 1K0 721 388 L , 1K0 721 388 F , 1K0 721 388 M , 1K0 721 388 S , 1K0 721 388 B | |
| | | AUDI | TT Coupe (06-) | RS 2,5 TFSI Quattro | | 05.2009 | | 1K0 721 388 G , 1K0 721 388 L , 1K0 721 388 F , 1K0 721 388 M , 1K0 721 388 S , 1K0 721 388 B | |
| | | AUDI | TT Coupe (06-) | 2,0 TFSI Quattro | | 05.2010 | | 1K0 721 388 G , 1K0 721 388 L , 1K0 721 388 F , 1K0 721 388 M , 1K0 721 388 S , 1K0 721 388 B | |
| | | AUDI | TT Coupe (06-) | | | 05.2008 | | 1K0 721 388 G , 1K0 721 388 L , 1K0 721 388 F , 1K0 721 388 M , 1K0 721 388 S , 1K0 721 388 B | |
| | | AUDI | TT Coupe (06-) | 2,0 TFSI | | 05.2010 | | 1K0 721 388 G , 1K0 721 388 L , 1K0 721 388 F , 1K0 721 388 M , 1K0 721 388 S , 1K0 721 388 B | |



| | | | | | | |
|--|--|--|--|--|-------------------------------|--|
| | | | | | OE numbers per ATE pn. | e.g. replaced pn. / miscellaneous |
|--|--|--|--|--|-------------------------------|--|



KGZ - Clutch cylinder

| | | | | | | |
|----------------|---------------|------|-------------------|---------------------|---------|---|
| 24.2415-1711.3 | 030130 | AUDI | TT Coupe (06-) | 2,0 TDI Quattro | 06.2008 | 1K0 721 388 G , 1K0 721 388 L , 1K0 721 388 F , 1K0 721 388 M , 1K0 721 388 S , 1K0 721 388 B |
| | | AUDI | TT Coupe (06-) | 2,0 Quattro | 05.2008 | 1K0 721 388 G , 1K0 721 388 L , 1K0 721 388 F , 1K0 721 388 M , 1K0 721 388 S , 1K0 721 388 B |
| | | AUDI | TT Coupe (06-) | 1,8 TFSI | 06.2008 | 1K0 721 388 G , 1K0 721 388 L , 1K0 721 388 F , 1K0 721 388 M , 1K0 721 388 S , 1K0 721 388 B |
| | | AUDI | TT Coupe (06-) | TTS 2,0 TFSI | 05.2008 | 1K0 721 388 G , 1K0 721 388 L , 1K0 721 388 F , 1K0 721 388 M , 1K0 721 388 S , 1K0 721 388 B |
| | | AUDI | TT Coupe (06-) | 2,0 TFSI | 07.2006 | 1K0 721 388 G , 1K0 721 388 L , 1K0 721 388 F , 1K0 721 388 M , 1K0 721 388 S , 1K0 721 388 B |
| | | AUDI | TT Roadster (07-) | 2,0 Quattro | 05.2008 | 1K0 721 388 G , 1K0 721 388 L , 1K0 721 388 F , 1K0 721 388 M , 1K0 721 388 S , 1K0 721 388 B |
| | | AUDI | TT Roadster (07-) | RS 2,5 TFSI Quattro | 05.2009 | 1K0 721 388 G , 1K0 721 388 L , 1K0 721 388 F , 1K0 721 388 M , 1K0 721 388 S , 1K0 721 388 B |
| | | AUDI | TT Roadster (07-) | 2,0 TFSI Quattro | 05.2010 | 1K0 721 388 G , 1K0 721 388 L , 1K0 721 388 F , 1K0 721 388 M , 1K0 721 388 S , 1K0 721 388 B |



| | | | | | | |
|--|--|--|--|--|-------------------------------|--|
| | | | | | OE numbers per ATE pn. | e.g. replaced pn. / miscellaneous |
|--|--|--|--|--|-------------------------------|--|



KGZ - Clutch cylinder

| | | | | | | |
|----------------|--------|-------|-------------------|------------------|---------|---|
| 24.2415-1711.3 | 030130 | AUDI | TT Roadster (07-) | 2,0 TFSI Quattro | 05.2008 | 1K0 721 388 G , 1K0 721 388 L , 1K0 721 388 F , 1K0 721 388 M , 1K0 721 388 S , 1K0 721 388 B |
| | | AUDI | TT Roadster (07-) | 2,0 TFSI | 05.2010 | 1K0 721 388 G , 1K0 721 388 L , 1K0 721 388 F , 1K0 721 388 M , 1K0 721 388 S , 1K0 721 388 B |
| | | AUDI | TT Roadster (07-) | 3,2 Quattro | 02.2007 | 1K0 721 388 G , 1K0 721 388 L , 1K0 721 388 F , 1K0 721 388 M , 1K0 721 388 S , 1K0 721 388 B |
| | | AUDI | TT Roadster (07-) | 2,0 TFSI | 02.2007 | 1K0 721 388 G , 1K0 721 388 L , 1K0 721 388 F , 1K0 721 388 M , 1K0 721 388 S , 1K0 721 388 B |
| | | AUDI | TT Roadster (07-) | 2,0 TDI Quattro | 06.2008 | 1K0 721 388 G , 1K0 721 388 L , 1K0 721 388 F , 1K0 721 388 M , 1K0 721 388 S , 1K0 721 388 B |
| | | AUDI | TT Roadster (07-) | TTS 2,0 TFSI | 05.2008 | 1K0 721 388 G , 1K0 721 388 L , 1K0 721 388 F , 1K0 721 388 M , 1K0 721 388 S , 1K0 721 388 B |
| | | AUDI | TT Roadster (07-) | 1,8 TFSI | 06.2008 | 1K0 721 388 G , 1K0 721 388 L , 1K0 721 388 F , 1K0 721 388 M , 1K0 721 388 S , 1K0 721 388 B |
| | | SKODA | YETI (09-) | 2,0 TDI 4x4 | 05.2009 | 1K0 721 388 G , 1K0 721 388 L , 1K0 721 388 F , 1K0 721 388 M , 1K0 721 388 S , 1K0 721 388 B |



| | | | | | | | |
|--|--|--|--|--|-------------------------------|--|--|
| | | | | | OE numbers per ATE pn. | | e.g. replaced pn. / miscellaneous |
|--|--|--|--|--|-------------------------------|--|--|



KGZ - Clutch cylinder

| | | | | | | | | |
|----------------|---------------|-------|------------|-------------|--|---------|---|--|
| 24.2415-1711.3 | 030130 | SKODA | YETI (09-) | 1,2 TSI | | 09.2009 | 1K0 721 388 G , 1K0 721 388 L , 1K0 721 388 F , 1K0 721 388 M , 1K0 721 388 S , 1K0 721 388 B | |
| | | SKODA | YETI (09-) | 1,4 TSI | | 06.2010 | 1K0 721 388 G , 1K0 721 388 L , 1K0 721 388 F , 1K0 721 388 M , 1K0 721 388 S , 1K0 721 388 B | |
| | | SKODA | YETI (09-) | 2,0 TDI | | 11.2009 | 1K0 721 388 G , 1K0 721 388 L , 1K0 721 388 F , 1K0 721 388 M , 1K0 721 388 S , 1K0 721 388 B | |
| | | SKODA | YETI (09-) | 2,0 TDI 4x4 | | 11.2009 | 1K0 721 388 G , 1K0 721 388 L , 1K0 721 388 F , 1K0 721 388 M , 1K0 721 388 S , 1K0 721 388 B | |
| | | SKODA | YETI (09-) | 1,8 TSI 4x4 | | 05.2009 | 1K0 721 388 G , 1K0 721 388 L , 1K0 721 388 F , 1K0 721 388 M , 1K0 721 388 S , 1K0 721 388 B | |



SAH - Caliper rear

| | | | | | | | | |
|----------------|---------------|---------------|-----------------------|-----------|--|---------|--|--|
| 24.0101-3802.2 | 260100 | MERCEDES BENZ | A-Class (W169) (04-) | A 200 CDI | | 08.2004 | 4439 36 , 77363365 , 169 421 01 86 , 4439 34 , 4439 44 | |
| | | MERCEDES BENZ | A-Class (W169) (04-) | A 180 | | | 4439 36 , 77363365 , 169 421 01 86 , 4439 34 , 4439 44 | |



| | | | | | | | |
|--|--|--|--|--|-------------------------------|--|--|
| | | | | | OE numbers per ATE pn. | | e.g. replaced pn. / miscellaneous |
|--|--|--|--|--|-------------------------------|--|--|



SAH - Caliper rear

| | | | | | | | |
|----------------|---------------|---------------|-----------------------|---------------|---------|---|--|
| 24.0101-3802.2 | 260100 | MERCEDES BENZ | A-Class (W169) (04-) | A 160 CDI | 08.2004 | 4439 36 , 77363365 , 169 421 01 86 , 4439 34 , 4439 44 | |
| | | MERCEDES BENZ | A-Class (W169) (04-) | A 200 CDI | | 4439 36 , 77363365 , 169 421 01 86 , 4439 34 , 4439 44 | |
| | | MERCEDES BENZ | A-Class (W169) (04-) | A 170 | 08.2004 | 4439 36 , 77363365 , 169 421 01 86 , 4439 34 , 4439 44 | |
| | | MERCEDES BENZ | A-Class (W169) (04-) | A 150 / A 160 | | 4439 36 , 77363365 , 169 421 01 86 , 4439 34 , 4439 44 | |
| | | MERCEDES BENZ | A-Class (W169) (04-) | A 180 | 04.2009 | 4439 36 , 77363365 , 169 421 01 86 , 4439 34 , 4439 44 | |
| | | MERCEDES BENZ | A-Class (W169) (04-) | A 180 CDI | | 4439 36 , 77363365 , 169 421 01 86 , 4439 34 , 4439 44 | |
| | | MERCEDES BENZ | A-Class (W169) (04-) | A 200 Turbo | | 4439 36 , 77363365 , 169 421 01 86 , 4439 34 , 4439 44 | |
| | | MERCEDES BENZ | A-Class (W169) (04-) | A 160 CDI | | 4439 36 , 77363365 , 169 421 01 86 , 4439 34 , 4439 44 | |
| | | MERCEDES BENZ | A-Class (W169) (04-) | A 150 / A 160 | 08.2004 | 4439 36 , 77363365 , 169 421 01 86 , 4439 34 , 4439 44 | |
| | | MERCEDES BENZ | A-Class (W169) (04-) | A 180 CDI | 08.2004 | 4439 36 , 77363365 , 169 421 01 86 , 4439 34 , 4439 44 | |
| | | MERCEDES BENZ | A-Class (W169) (04-) | A 200 | | 4439 36 , 77363365 , 169 421 01 86 , 4439 34 , 4439 44 | |
| | | MERCEDES BENZ | A-Class (W169) (04-) | | 08.2004 | 4439 36 , 77363365 , 169 421 01 86 , 4439 34 , 4439 44 | |



| | | | | | | |
|--|--|--|--|--|-------------------------------|--|
| | | | | | OE numbers per ATE pn. | e.g. replaced pn. / miscellaneous |
|--|--|--|--|--|-------------------------------|--|



SAH - Caliper rear

| | | | | | | | | | |
|----------------|---------------|---------------|-----------------------|---------------|--|---------|---------|---|--|
| 24.0101-3802.2 | 260100 | MERCEDES BENZ | A-Class (W169) (04-) | A 200 Turbo | | 03.2005 | | 4439 36 , 77363365 , 169 421 01 86 , 4439 34 , 4439 44 | |
| | | MERCEDES BENZ | A-Class (W169) (04-) | A 170 | | | | 4439 36 , 77363365 , 169 421 01 86 , 4439 34 , 4439 44 | |
| | | MERCEDES BENZ | B-Class (W245) (05-) | B 180 NGT | | 04.2009 | | 4439 36 , 77363365 , 169 421 01 86 , 4439 34 , 4439 44 | |
| | | MERCEDES BENZ | B-Class (W245) (05-) | B 180 CDI | | 04.2005 | | 4439 36 , 77363365 , 169 421 01 86 , 4439 34 , 4439 44 | |
| | | MERCEDES BENZ | B-Class (W245) (05-) | B 170 NGT | | 04.2008 | 04.2009 | 4439 36 , 77363365 , 169 421 01 86 , 4439 34 , 4439 44 | |
| | | MERCEDES BENZ | B-Class (W245) (05-) | B 170 / B 180 | | 04.2005 | | 4439 36 , 77363365 , 169 421 01 86 , 4439 34 , 4439 44 | |
| | | MERCEDES BENZ | B-Class (W245) (05-) | B 150 / B 160 | | 04.2005 | | 4439 36 , 77363365 , 169 421 01 86 , 4439 34 , 4439 44 | |
| | | MERCEDES BENZ | B-Class (W245) (05-) | B 200 Turbo | | 04.2005 | | 4439 36 , 77363365 , 169 421 01 86 , 4439 34 , 4439 44 | |
| | | MERCEDES BENZ | B-Class (W245) (05-) | B 200 | | 04.2005 | | 4439 36 , 77363365 , 169 421 01 86 , 4439 34 , 4439 44 | |
| | | MERCEDES BENZ | B-Class (W245) (05-) | B 200 CDI | | 04.2005 | | 4439 36 , 77363365 , 169 421 01 86 , 4439 34 , 4439 44 | |
| | | CITROEN | C6 (05-) | 3,0 V6 HDi | | 07.2009 | | 4439 36 , 77363365 , 169 421 01 86 , 4439 34 , 4439 44 | |
| | | CITROEN | C6 (05-) | 3,0 V6 | | 09.2005 | | 4439 36 , 77363365 , 169 421 01 86 , 4439 34 , 4439 44 | |



| | | | | | | | |
|--|--|--|--|--|-------------------------------|--|--|
| | | | | | OE numbers per ATE pn. | | e.g. replaced pn. / miscellaneous |
|--|--|--|--|--|-------------------------------|--|--|



SAH - Caliper rear

| | | | | | | |
|----------------|---------------|---------|------------------|--------------------|---------|---|
| 24.0101-3802.2 | 260100 | CITROEN | C6 (05-) | 2,7 V6 HDi Biturbo | 09.2005 | 4439 36 , 77363365 , 169 421 01 86 , 4439 34 , 4439 44 |
| | | CITROEN | C6 (05-) | 2,2 HDi | 06.2006 | 4439 36 , 77363365 , 169 421 01 86 , 4439 34 , 4439 44 |
| 24.0101-3803.2 | 260101 | PEUGEOT | 407 Coupe (05-) | 2,2 16V | 10.2005 | 4439 36 , 001 421 04 86 , 34 21 6 772 867 , 93179160 , 54 23 93 |
| | | PEUGEOT | 407 Coupe (05-) | 2,7 HDi | 10.2005 | 4439 36 , 001 421 04 86 , 34 21 6 772 867 , 93179160 , 54 23 93 |
| | | PEUGEOT | 407 Coupe (05-) | 3,0 HDi | 06.2009 | 4439 36 , 001 421 04 86 , 34 21 6 772 867 , 93179160 , 54 23 93 |
| | | PEUGEOT | 407 Coupe (05-) | 3,0 V6 | 10.2005 | 4439 36 , 001 421 04 86 , 34 21 6 772 867 , 93179160 , 54 23 93 |
| | | PEUGEOT | 407 Coupe (05-) | 2,0 HDi | 06.2009 | 4439 36 , 001 421 04 86 , 34 21 6 772 867 , 93179160 , 54 23 93 |
| | | PEUGEOT | 407 Coupe (05-) | | 07.2007 | 4439 36 , 001 421 04 86 , 34 21 6 772 867 , 93179160 , 54 23 93 |
| | | PEUGEOT | 407 Saloon (04-) | 2,0 HDi 140 | 08.2008 | 4439 36 , 001 421 04 86 , 34 21 6 772 867 , 93179160 , 54 23 93 |
| | | PEUGEOT | 407 Saloon (04-) | 2,0 16V | 05.2004 | 4439 36 , 001 421 04 86 , 34 21 6 772 867 , 93179160 , 54 23 93 |



| | | | | | | | |
|--|--|--|--|--|-------------------------------|--|--|
| | | | | | OE numbers per ATE pn. | | e.g. replaced pn. / miscellaneous |
|--|--|--|--|--|-------------------------------|--|--|



SAH - Caliper rear

| | | | | | | | |
|----------------|---------------|---------|------------------|-------------|---------|---|--|
| 24.0101-3803.2 | 260101 | PEUGEOT | 407 Saloon (04-) | 3,0 V6 | 05.2004 | 4439 36 , 001 421 04 86 , 34 21 6 772 867 , 93179160 , 54 23 93 | |
| | | PEUGEOT | 407 Saloon (04-) | 2,7 HDi | 10.2005 | 4439 36 , 001 421 04 86 , 34 21 6 772 867 , 93179160 , 54 23 93 | |
| | | PEUGEOT | 407 Saloon (04-) | 2,2 HDi 170 | 05.2006 | 4439 36 , 001 421 04 86 , 34 21 6 772 867 , 93179160 , 54 23 93 | |
| | | PEUGEOT | 407 Saloon (04-) | 2,2 HDi | 06.2008 | 4439 36 , 001 421 04 86 , 34 21 6 772 867 , 93179160 , 54 23 93 | |
| | | PEUGEOT | 407 Saloon (04-) | 2,2 16V | 05.2004 | 4439 36 , 001 421 04 86 , 34 21 6 772 867 , 93179160 , 54 23 93 | |
| | | PEUGEOT | 407 Saloon (04-) | 2,0 HDi 135 | 05.2004 | 4439 36 , 001 421 04 86 , 34 21 6 772 867 , 93179160 , 54 23 93 | |
| | | PEUGEOT | 407 Saloon (04-) | 2,0 16V | 09.2005 | 4439 36 , 001 421 04 86 , 34 21 6 772 867 , 93179160 , 54 23 93 | |
| | | PEUGEOT | 407 Saloon (04-) | 1,8 16V | 09.2005 | 4439 36 , 001 421 04 86 , 34 21 6 772 867 , 93179160 , 54 23 93 | |
| | | PEUGEOT | 407 Saloon (04-) | 1,6 HDi 110 | 05.2004 | 4439 36 , 001 421 04 86 , 34 21 6 772 867 , 93179160 , 54 23 93 | |



| | | | | | | | |
|--|--|--|--|--|-------------------------------|--|--|
| | | | | | OE numbers per ATE pn. | | e.g. replaced pn. / miscellaneous |
|--|--|--|--|--|-------------------------------|--|--|



SAH - Caliper rear

| | | | | | | | |
|----------------|---------------|---------|------------------|-------------|---------|---|--|
| 24.0101-3803.2 | 260101 | PEUGEOT | 407 Saloon (04-) | 2,2 16V | 09.2005 | 4439 36 , 001 421 04 86 , 34 21 6 772 867 , 93179160 , 54 23 93 | |
| | | PEUGEOT | 407 Saloon (04-) | 1,8 16V | 05.2004 | 4439 36 , 001 421 04 86 , 34 21 6 772 867 , 93179160 , 54 23 93 | |
| | | PEUGEOT | 407 SW (04-) | 2,0 HDi 135 | 05.2004 | 4439 36 , 001 421 04 86 , 34 21 6 772 867 , 93179160 , 54 23 93 | |
| | | PEUGEOT | 407 SW (04-) | 2,0 16V | 05.2004 | 4439 36 , 001 421 04 86 , 34 21 6 772 867 , 93179160 , 54 23 93 | |
| | | PEUGEOT | 407 SW (04-) | 2,7 HDi | 10.2005 | 4439 36 , 001 421 04 86 , 34 21 6 772 867 , 93179160 , 54 23 93 | |
| | | PEUGEOT | 407 SW (04-) | 2,2 HDi 170 | 05.2006 | 4439 36 , 001 421 04 86 , 34 21 6 772 867 , 93179160 , 54 23 93 | |
| | | PEUGEOT | 407 SW (04-) | 3,0 V6 | 05.2004 | 4439 36 , 001 421 04 86 , 34 21 6 772 867 , 93179160 , 54 23 93 | |
| | | PEUGEOT | 407 SW (04-) | 2,2 HDi | 06.2008 | 4439 36 , 001 421 04 86 , 34 21 6 772 867 , 93179160 , 54 23 93 | |
| | | PEUGEOT | 407 SW (04-) | 2,2 16V | 09.2005 | 4439 36 , 001 421 04 86 , 34 21 6 772 867 , 93179160 , 54 23 93 | |



| | | | | | | | |
|--|--|--|--|--|-------------------------------|--|--|
| | | | | | OE numbers per ATE pn. | | e.g. replaced pn. / miscellaneous |
|--|--|--|--|--|-------------------------------|--|--|



SAH - Caliper rear

| | | | | | | | | |
|----------------|---------------|---------|-------------------------|-------------|---------|---------|---|--|
| 24.0101-3803.2 | 260101 | PEUGEOT | 407 SW (04-) | 2,0 HDi 140 | 08.2008 | | 4439 36 , 001 421 04 86 , 34 21 6 772 867 , 93179160 , 54 23 93 | |
| | | PEUGEOT | 407 SW (04-) | 2,0 HDi | 05.2004 | 07.2008 | 4439 36 , 001 421 04 86 , 34 21 6 772 867 , 93179160 , 54 23 93 | |
| | | PEUGEOT | 407 SW (04-) | 2,0 BioFlex | 01.2008 | | 4439 36 , 001 421 04 86 , 34 21 6 772 867 , 93179160 , 54 23 93 | |
| | | PEUGEOT | 407 SW (04-) | 2,0 16V | 09.2005 | | 4439 36 , 001 421 04 86 , 34 21 6 772 867 , 93179160 , 54 23 93 | |
| | | PEUGEOT | 407 SW (04-) | 1,6 HDi 110 | 05.2004 | | 4439 36 , 001 421 04 86 , 34 21 6 772 867 , 93179160 , 54 23 93 | |
| | | PEUGEOT | 407 SW (04-) | 1,8 16V | 05.2004 | | 4439 36 , 001 421 04 86 , 34 21 6 772 867 , 93179160 , 54 23 93 | |
| | | PEUGEOT | 407 SW (04-) | | 09.2005 | | 4439 36 , 001 421 04 86 , 34 21 6 772 867 , 93179160 , 54 23 93 | |
| | | PEUGEOT | 407 SW (04-) | 2,2 16V | 05.2004 | | 4439 36 , 001 421 04 86 , 34 21 6 772 867 , 93179160 , 54 23 93 | |
| | | AUDI | A3 / A3 Sportback (03-) | 1,6 TDI | 05.2009 | | 4439 36 , 001 421 04 86 , 34 21 6 772 867 , 93179160 , 54 23 93 | |



| | | | | | | |
|--|--|--|--|--|-------------------------------|---------------------------------------|
| | | | | | OE numbers per ATE pn. | e.g. replaced pn. / miscellaneous |
|--|--|--|--|--|-------------------------------|---------------------------------------|



SAH - Caliper rear

| | | | | | | | | | |
|----------------|---------------|------|-------------------------|----------|--|---------|---------|---|--|
| 24.0101-3803.2 | 260101 | AUDI | A3 / A3 Sportback (03-) | 1,6 | | 06.2007 | | 4439 36 , 001 421 04 86 , 34 21 6 772 867 , 93179160 , 54 23 93 | |
| | | AUDI | A3 / A3 Sportback (03-) | 1,6 FSI | | 08.2003 | 05.2007 | 4439 36 , 001 421 04 86 , 34 21 6 772 867 , 93179160 , 54 23 93 | |
| | | AUDI | A3 / A3 Sportback (03-) | 1,4 TFSI | | 07.2007 | | 4439 36 , 001 421 04 86 , 34 21 6 772 867 , 93179160 , 54 23 93 | |
| | | AUDI | A3 / A3 Sportback (03-) | 1,2 TSI | | 04.2010 | | 4439 36 , 001 421 04 86 , 34 21 6 772 867 , 93179160 , 54 23 93 | |
| | | AUDI | A3 / A3 Sportback (03-) | 1,6 | | 05.2003 | 05.2007 | 4439 36 , 001 421 04 86 , 34 21 6 772 867 , 93179160 , 54 23 93 | |
| | | AUDI | A3 / A3 Sportback (03-) | 2,0 TDI | | 06.2006 | 05.2007 | 4439 36 , 001 421 04 86 , 34 21 6 772 867 , 93179160 , 54 23 93 | |
| | | AUDI | A3 / A3 Sportback (03-) | 2,0 TFSI | | 06.2004 | 05.2007 | 4439 36 , 001 421 04 86 , 34 21 6 772 867 , 93179160 , 54 23 93 | |
| | | AUDI | A3 / A3 Sportback (03-) | 1,6 FSI | | 06.2007 | | 4439 36 , 001 421 04 86 , 34 21 6 772 867 , 93179160 , 54 23 93 | |
| | | AUDI | A3 / A3 Sportback (03-) | 2,0 TDI | | 06.2007 | 06.2008 | 4439 36 , 001 421 04 86 , 34 21 6 772 867 , 93179160 , 54 23 93 | |



| | | | | | | |
|--|--|--|--|--|-------------------------------|---------------------------------------|
| | | | | | OE numbers per ATE pn. | e.g. replaced pn. / miscellaneous |
|--|--|--|--|--|-------------------------------|---------------------------------------|



SAH - Caliper rear

| | | | | | | | | |
|----------------|---------------|------|-------------------------|----------|---------|---------|---|--|
| 24.0101-3803.2 | 260101 | AUDI | A3 / A3 Sportback (03-) | 2,0 TDI | 05.2003 | 05.2007 | 4439 36 , 001 421 04 86 , 34 21 6 772 867 , 93179160 , 54 23 93 | |
| | | AUDI | A3 / A3 Sportback (03-) | | 03.2006 | 05.2007 | 4439 36 , 001 421 04 86 , 34 21 6 772 867 , 93179160 , 54 23 93 | |
| | | AUDI | A3 / A3 Sportback (03-) | | 06.2007 | | 4439 36 , 001 421 04 86 , 34 21 6 772 867 , 93179160 , 54 23 93 | |
| | | AUDI | A3 / A3 Sportback (03-) | 2,0 FSI | 05.2003 | 05.2007 | 4439 36 , 001 421 04 86 , 34 21 6 772 867 , 93179160 , 54 23 93 | |
| | | AUDI | A3 / A3 Sportback (03-) | | 06.2007 | | 4439 36 , 001 421 04 86 , 34 21 6 772 867 , 93179160 , 54 23 93 | |
| | | AUDI | A3 / A3 Sportback (03-) | 1,9 TDI | 06.2003 | 05.2007 | 4439 36 , 001 421 04 86 , 34 21 6 772 867 , 93179160 , 54 23 93 | |
| | | AUDI | A3 / A3 Sportback (03-) | | 06.2007 | | 4439 36 , 001 421 04 86 , 34 21 6 772 867 , 93179160 , 54 23 93 | |
| | | AUDI | A3 / A3 Sportback (03-) | 1,8 TFSI | 01.2007 | 05.2007 | 4439 36 , 001 421 04 86 , 34 21 6 772 867 , 93179160 , 54 23 93 | |
| | | AUDI | A3 / A3 Sportback (03-) | | 06.2007 | | 4439 36 , 001 421 04 86 , 34 21 6 772 867 , 93179160 , 54 23 93 | |



| | | | | | | | |
|--|--|--|--|--|-------------------------------|--|--|
| | | | | | OE numbers per ATE pn. | | e.g. replaced pn. / miscellaneous |
|--|--|--|--|--|-------------------------------|--|--|



SAH - Caliper rear

| | | | | | | | | |
|----------------|---------------|---------|--------------------------|----------|--|---------|---|--|
| 24.0101-3803.2 | 260101 | AUDI | A3 / A3 Sportback (03-) | 2,0 TFSI | | 06.2007 | 4439 36 , 001 421 04 86 , 34 21 6 772 867 , 93179160 , 54 23 93 | |
| | | AUDI | A3 Convertible (08-) | 1,2 TSI | | 03.2010 | 4439 36 , 001 421 04 86 , 34 21 6 772 867 , 93179160 , 54 23 93 | |
| | | AUDI | A3 Convertible (08-) | 1,6 | | 09.2008 | 4439 36 , 001 421 04 86 , 34 21 6 772 867 , 93179160 , 54 23 93 | |
| | | AUDI | A3 Convertible (08-) | 1,6 TDI | | 05.2009 | 4439 36 , 001 421 04 86 , 34 21 6 772 867 , 93179160 , 54 23 93 | |
| | | AUDI | A3 Convertible (08-) | 1,8 TFSI | | 04.2008 | 4439 36 , 001 421 04 86 , 34 21 6 772 867 , 93179160 , 54 23 93 | |
| | | AUDI | A3 Convertible (08-) | 1,9 TDI | | 04.2008 | 4439 36 , 001 421 04 86 , 34 21 6 772 867 , 93179160 , 54 23 93 | |
| | | AUDI | A3 Convertible (08-) | 2,0 TDI | | 04.2008 | 4439 36 , 001 421 04 86 , 34 21 6 772 867 , 93179160 , 54 23 93 | |
| | | AUDI | A3 Convertible (08-) | 2,0 TFSI | | 04.2008 | 4439 36 , 001 421 04 86 , 34 21 6 772 867 , 93179160 , 54 23 93 | |
| | | CITROEN | C5 III Estate (X7) (08-) | 3,0 V6 | | 02.2008 | 4439 36 , 001 421 04 86 , 34 21 6 772 867 , 93179160 , 54 23 93 | |



| | | | | | | | |
|--|--|--|--|--|-------------------------------|--|--|
| | | | | | OE numbers per ATE pn. | | e.g. replaced pn. / miscellaneous |
|--|--|--|--|--|-------------------------------|--|--|



SAH - Caliper rear

| | | | | | | | | |
|----------------|---------------|---------|--------------------------|-----------------|--|---------|---|--|
| 24.0101-3803.2 | 260101 | CITROEN | C5 III Estate (X7) (08-) | 1,6 16V | | 04.2009 | 4439 36 , 001 421 04 86 , 34 21 6 772 867 , 93179160 , 54 23 93 | |
| | | CITROEN | C5 III Estate (X7) (08-) | 1,6 HDi | | 02.2008 | 4439 36 , 001 421 04 86 , 34 21 6 772 867 , 93179160 , 54 23 93 | |
| | | CITROEN | C5 III Estate (X7) (08-) | 2,0 16V | | 02.2008 | 4439 36 , 001 421 04 86 , 34 21 6 772 867 , 93179160 , 54 23 93 | |
| | | CITROEN | C5 III Estate (X7) (08-) | 2,0 HDi | | 02.2008 | 4439 36 , 001 421 04 86 , 34 21 6 772 867 , 93179160 , 54 23 93 | |
| | | CITROEN | C5 III Estate (X7) (08-) | | | 04.2009 | 4439 36 , 001 421 04 86 , 34 21 6 772 867 , 93179160 , 54 23 93 | |
| | | CITROEN | C5 III Estate (X7) (08-) | 2,0 HDi 140 FAP | | 11.2008 | 4439 36 , 001 421 04 86 , 34 21 6 772 867 , 93179160 , 54 23 93 | |
| | | CITROEN | C5 III Estate (X7) (08-) | 2,2 HDi 170 | | 02.2008 | 4439 36 , 001 421 04 86 , 34 21 6 772 867 , 93179160 , 54 23 93 | |
| | | CITROEN | C5 III Estate (X7) (08-) | 2,7 HDi V6 | | 02.2008 | 4439 36 , 001 421 04 86 , 34 21 6 772 867 , 93179160 , 54 23 93 | |
| | | CITROEN | C5 III Estate (X7) (08-) | 3,0 HDi | | 04.2009 | 4439 36 , 001 421 04 86 , 34 21 6 772 867 , 93179160 , 54 23 93 | |



| | | | | | | | |
|--|--|--|--|--|-------------------------------|--|--|
| | | | | | OE numbers per ATE pn. | | e.g. replaced pn. / miscellaneous |
|--|--|--|--|--|-------------------------------|--|--|



SAH - Caliper rear

| | | | | | | | | |
|----------------|---------------|---------|--------------------------|-----------------|--|---------|---|--|
| 24.0101-3803.2 | 260101 | CITROEN | C5 III Estate (X7) (08-) | 1,8 16V | | 02.2008 | 4439 36 , 001 421 04 86 , 34 21 6 772 867 , 93179160 , 54 23 93 | |
| | | CITROEN | C5 III Estate (X7) (08-) | 3 | | 02.2008 | 4439 36 , 001 421 04 86 , 34 21 6 772 867 , 93179160 , 54 23 93 | |
| | | CITROEN | C5 III Estate (X7) (08-) | 2,0 16V BioFlex | | 02.2008 | 4439 36 , 001 421 04 86 , 34 21 6 772 867 , 93179160 , 54 23 93 | |
| | | CITROEN | C5 III Saloon (X7) (08-) | 3 | | 02.2008 | 4439 36 , 001 421 04 86 , 34 21 6 772 867 , 93179160 , 54 23 93 | |
| | | CITROEN | C5 III Saloon (X7) (08-) | 1,6 16V | | 04.2009 | 4439 36 , 001 421 04 86 , 34 21 6 772 867 , 93179160 , 54 23 93 | |
| | | CITROEN | C5 III Saloon (X7) (08-) | 1,6 HDi | | 02.2008 | 4439 36 , 001 421 04 86 , 34 21 6 772 867 , 93179160 , 54 23 93 | |
| | | CITROEN | C5 III Saloon (X7) (08-) | 1,8 i 16V | | 02.2008 | 4439 36 , 001 421 04 86 , 34 21 6 772 867 , 93179160 , 54 23 93 | |
| | | CITROEN | C5 III Saloon (X7) (08-) | 2,0 16V BioFlex | | 02.2008 | 4439 36 , 001 421 04 86 , 34 21 6 772 867 , 93179160 , 54 23 93 | |
| | | CITROEN | C5 III Saloon (X7) (08-) | 2,0 HDi | | 02.2008 | 4439 36 , 001 421 04 86 , 34 21 6 772 867 , 93179160 , 54 23 93 | |



| | | | | | | | |
|--|--|--|--|--|-------------------------------|--|--|
| | | | | | OE numbers per ATE pn. | | e.g. replaced pn. / miscellaneous |
|--|--|--|--|--|-------------------------------|--|--|



SAH - Caliper rear

| | | | | | | | | |
|----------------|---------------|------------|--------------------------|-----------------|--|---------|---|--|
| 24.0101-3803.2 | 260101 | CITROEN | C5 III Saloon (X7) (08-) | 2,0 HDi 140 FAP | | 11.2008 | 4439 36 , 001 421 04 86 , 34 21 6 772 867 , 93179160 , 54 23 93 | |
| | | CITROEN | C5 III Saloon (X7) (08-) | 2,0 i 16V | | 02.2008 | 4439 36 , 001 421 04 86 , 34 21 6 772 867 , 93179160 , 54 23 93 | |
| | | CITROEN | C5 III Saloon (X7) (08-) | 2,2 HDi 170 | | 02.2008 | 4439 36 , 001 421 04 86 , 34 21 6 772 867 , 93179160 , 54 23 93 | |
| | | CITROEN | C5 III Saloon (X7) (08-) | 3,0 i V6 | | 02.2008 | 4439 36 , 001 421 04 86 , 34 21 6 772 867 , 93179160 , 54 23 93 | |
| | | CITROEN | C5 III Saloon (X7) (08-) | 3,0 HDi | | 04.2009 | 4439 36 , 001 421 04 86 , 34 21 6 772 867 , 93179160 , 54 23 93 | |
| | | CITROEN | C5 III Saloon (X7) (08-) | 2,7 HDi | | 02.2008 | 4439 36 , 001 421 04 86 , 34 21 6 772 867 , 93179160 , 54 23 93 | |
| | | CITROEN | C5 III Saloon (X7) (08-) | 2,0 HDi | | 04.2009 | 4439 36 , 001 421 04 86 , 34 21 6 772 867 , 93179160 , 54 23 93 | |
| | | VOLKSWAGEN | CADDY III (04-) | 1,4 16V | | | 4439 36 , 001 421 04 86 , 34 21 6 772 867 , 93179160 , 54 23 93 | |
| | | VOLKSWAGEN | CADDY III (04-) | 2,0 Eco Fuel | | | 4439 36 , 001 421 04 86 , 34 21 6 772 867 , 93179160 , 54 23 93 | |



| | | | | | | |
|--|--|--|--|--|-------------------------------|--|
| | | | | | OE numbers per ATE pn. | e.g. replaced pn. / miscellaneous |
|--|--|--|--|--|-------------------------------|--|



SAH - Caliper rear

| | | | | | | | | | |
|----------------|---------------|------------|-----------------|-----------------|--|--|--|---|--|
| 24.0101-3803.2 | 260101 | VOLKSWAGEN | CADDY III (04-) | 2,0 SDI | | | | 4439 36 , 001 421 04 86 , 34 21 6 772 867 , 93179160 , 54 23 93 | |
| | | VOLKSWAGEN | CADDY III (04-) | 2,0 TDI | | | | 4439 36 , 001 421 04 86 , 34 21 6 772 867 , 93179160 , 54 23 93 | |
| | | VOLKSWAGEN | CADDY III (04-) | 2,0 TDI 4motion | | | | 4439 36 , 001 421 04 86 , 34 21 6 772 867 , 93179160 , 54 23 93 | |
| | | VOLKSWAGEN | CADDY III (04-) | 1,4 | | | | 4439 36 , 001 421 04 86 , 34 21 6 772 867 , 93179160 , 54 23 93 | |
| | | VOLKSWAGEN | CADDY III (04-) | 1,6 | | | | 4439 36 , 001 421 04 86 , 34 21 6 772 867 , 93179160 , 54 23 93 | |
| | | VOLKSWAGEN | CADDY III (04-) | 1,6 TDI | | | | 4439 36 , 001 421 04 86 , 34 21 6 772 867 , 93179160 , 54 23 93 | |
| | | VOLKSWAGEN | CADDY III (04-) | 1,9 TDI 4motion | | | | 4439 36 , 001 421 04 86 , 34 21 6 772 867 , 93179160 , 54 23 93 | |
| | | VOLKSWAGEN | CADDY III (04-) | 1,9 TDI | | | | 4439 36 , 001 421 04 86 , 34 21 6 772 867 , 93179160 , 54 23 93 | |
| | | VOLKSWAGEN | CADDY III (04-) | 1,2 TSI | | | | 4439 36 , 001 421 04 86 , 34 21 6 772 867 , 93179160 , 54 23 93 | |



| | | | | | | |
|--|--|--|--|--|-------------------------------|--|
| | | | | | OE numbers per ATE pn. | |
|--|--|--|--|--|-------------------------------|--|



SAH - Caliper rear

| | | | | | | | | | |
|----------------|---------------|---------|--------------------------|-----------------|--|---------|---------|---|--|
| 24.0101-3803.2 | 260101 | RENAULT | CLIO III (BR_/CR_) (05-) | 1,2 16V | | 06.2005 | | 4439 36 , 001 421 04 86 , 34 21 6 772 867 , 93179160 , 54 23 93 | |
| | | RENAULT | CLIO III (BR_/CR_) (05-) | 1,5 dCi | | 05.2005 | 10.2006 | 4439 36 , 001 421 04 86 , 34 21 6 772 867 , 93179160 , 54 23 93 | |
| | | RENAULT | CLIO III (BR_/CR_) (05-) | 1,2 | | 10.2005 | | 4439 36 , 001 421 04 86 , 34 21 6 772 867 , 93179160 , 54 23 93 | |
| | | RENAULT | CLIO III (BR_/CR_) (05-) | 1,6 16V | | 06.2005 | | 4439 36 , 001 421 04 86 , 34 21 6 772 867 , 93179160 , 54 23 93 | |
| | | RENAULT | CLIO III (BR_/CR_) (05-) | 1,2 | | 09.2006 | | 4439 36 , 001 421 04 86 , 34 21 6 772 867 , 93179160 , 54 23 93 | |
| | | RENAULT | CLIO III (BR_/CR_) (05-) | 1,5 dCi | | 06.2005 | | 4439 36 , 001 421 04 86 , 34 21 6 772 867 , 93179160 , 54 23 93 | |
| | | RENAULT | CLIO III (BR_/CR_) (05-) | 1,5 D | | 11.2007 | | 4439 36 , 001 421 04 86 , 34 21 6 772 867 , 93179160 , 54 23 93 | |
| | | RENAULT | CLIO III (BR_/CR_) (05-) | 1,4 16V | | 06.2005 | | 4439 36 , 001 421 04 86 , 34 21 6 772 867 , 93179160 , 54 23 93 | |
| | | RENAULT | CLIO III (BR_/CR_) (05-) | 1,2 16V Hi-Flex | | 07.2008 | | 4439 36 , 001 421 04 86 , 34 21 6 772 867 , 93179160 , 54 23 93 | |



| | | | | | | |
|--|--|--|--|--|-------------------------------|---------------------------------------|
| | | | | | OE numbers per ATE pn. | e.g. replaced pn. / miscellaneous |
|--|--|--|--|--|-------------------------------|---------------------------------------|



SAH - Caliper rear

| | | | | | | | | |
|----------------|---------------|------------|--------------------------------|-----------------|--|---------|---|--|
| 24.0101-3803.2 | 260101 | RENAULT | CLIO III (BR_/CR_) (05-) | 1,2 16V | | 05.2007 | 4439 36 , 001 421 04 86 , 34 21 6 772 867 , 93179160 , 54 23 93 | |
| | | RENAULT | CLIO III (BR_/CR_) (05-) | 1,6 16V GT | | 04.2009 | 4439 36 , 001 421 04 86 , 34 21 6 772 867 , 93179160 , 54 23 93 | |
| | | RENAULT | CLIO III Grandtour (KR_) (08-) | 1,2 16V | | 02.2008 | 4439 36 , 001 421 04 86 , 34 21 6 772 867 , 93179160 , 54 23 93 | |
| | | RENAULT | CLIO III Grandtour (KR_) (08-) | 1,2 16V Hi-Flex | | 07.2008 | 4439 36 , 001 421 04 86 , 34 21 6 772 867 , 93179160 , 54 23 93 | |
| | | RENAULT | CLIO III Grandtour (KR_) (08-) | 1,4 16V | | 02.2010 | 4439 36 , 001 421 04 86 , 34 21 6 772 867 , 93179160 , 54 23 93 | |
| | | RENAULT | CLIO III Grandtour (KR_) (08-) | 1,5 dCi | | 02.2008 | 4439 36 , 001 421 04 86 , 34 21 6 772 867 , 93179160 , 54 23 93 | |
| | | RENAULT | CLIO III Grandtour (KR_) (08-) | 1,6 16V | | 02.2008 | 4439 36 , 001 421 04 86 , 34 21 6 772 867 , 93179160 , 54 23 93 | |
| | | RENAULT | CLIO III Grandtour (KR_) (08-) | | | 11.2008 | 4439 36 , 001 421 04 86 , 34 21 6 772 867 , 93179160 , 54 23 93 | |
| | | VOLKSWAGEN | EOS (06-) | 3,2 V6 | | 05.2006 | 4439 36 , 001 421 04 86 , 34 21 6 772 867 , 93179160 , 54 23 93 | |



| | | | | | | |
|--|--|--|--|--|-------------------------------|--|
| | | | | | OE numbers per ATE pn. | e.g. replaced pn. / miscellaneous |
|--|--|--|--|--|-------------------------------|--|



SAH - Caliper rear

| | | | | | | |
|----------------|---------------|------------|-----------------|----------|---------|---|
| 24.0101-3803.2 | 260101 | VOLKSWAGEN | EOS (06-) | 1,6 FSI | 05.2006 | 4439 36 , 001 421 04 86 , 34 21 6 772 867 , 93179160 , 54 23 93 |
| | | VOLKSWAGEN | EOS (06-) | 3,6 V6 | 05.2009 | 4439 36 , 001 421 04 86 , 34 21 6 772 867 , 93179160 , 54 23 93 |
| | | VOLKSWAGEN | EOS (06-) | 2,0 FSI | 05.2006 | 4439 36 , 001 421 04 86 , 34 21 6 772 867 , 93179160 , 54 23 93 |
| | | VOLKSWAGEN | EOS (06-) | 2,0 TDI | 05.2006 | 4439 36 , 001 421 04 86 , 34 21 6 772 867 , 93179160 , 54 23 93 |
| | | VOLKSWAGEN | EOS (06-) | 1,4 TSI | 10.2007 | 4439 36 , 001 421 04 86 , 34 21 6 772 867 , 93179160 , 54 23 93 |
| | | VOLKSWAGEN | EOS (06-) | 2,0 TFSI | 05.2006 | 4439 36 , 001 421 04 86 , 34 21 6 772 867 , 93179160 , 54 23 93 |
| | | VOLKSWAGEN | EOS (06-) | 2,0 TSI | 11.2009 | 4439 36 , 001 421 04 86 , 34 21 6 772 867 , 93179160 , 54 23 93 |
| | | VOLKSWAGEN | GOLF Plus (05-) | 2,0 TDI | 01.2009 | 4439 36 , 001 421 04 86 , 34 21 6 772 867 , 93179160 , 54 23 93 |
| | | VOLKSWAGEN | GOLF Plus (05-) | 2,0 FSI | 05.2005 | 4439 36 , 001 421 04 86 , 34 21 6 772 867 , 93179160 , 54 23 93 |



| | | | | | | | |
|--|--|--|--|--|-------------------------------|--|--|
| | | | | | OE numbers per ATE pn. | | e.g. replaced pn. / miscellaneous |
|--|--|--|--|--|-------------------------------|--|--|



SAH - Caliper rear

| | | | | | | | |
|----------------|---------------|------------|-----------------|------------|---------|---|--|
| 24.0101-3803.2 | 260101 | VOLKSWAGEN | GOLF Plus (05-) | 1,4 TSI | 06.2007 | 4439 36 , 001 421 04 86 , 34 21 6 772 867 , 93179160 , 54 23 93 | |
| | | VOLKSWAGEN | GOLF Plus (05-) | 1,6 TDI | 02.2009 | 4439 36 , 001 421 04 86 , 34 21 6 772 867 , 93179160 , 54 23 93 | |
| | | VOLKSWAGEN | GOLF Plus (05-) | 1,9 TDI | 05.2005 | 4439 36 , 001 421 04 86 , 34 21 6 772 867 , 93179160 , 54 23 93 | |
| | | VOLKSWAGEN | GOLF Plus (05-) | | 01.2005 | 4439 36 , 001 421 04 86 , 34 21 6 772 867 , 93179160 , 54 23 93 | |
| | | VOLKSWAGEN | GOLF Plus (05-) | 1,4 TSI | 05.2006 | 4439 36 , 001 421 04 86 , 34 21 6 772 867 , 93179160 , 54 23 93 | |
| | | VOLKSWAGEN | GOLF Plus (05-) | 1,4 16V | 01.2005 | 4439 36 , 001 421 04 86 , 34 21 6 772 867 , 93179160 , 54 23 93 | |
| | | VOLKSWAGEN | GOLF Plus (05-) | 1,4 FSI | 07.2005 | 4439 36 , 001 421 04 86 , 34 21 6 772 867 , 93179160 , 54 23 93 | |
| | | VOLKSWAGEN | GOLF Plus (05-) | 1,6 FSI | 01.2005 | 4439 36 , 001 421 04 86 , 34 21 6 772 867 , 93179160 , 54 23 93 | |
| | | VOLKSWAGEN | GOLF Plus (05-) | 1,6 BiFuel | 05.2009 | 4439 36 , 001 421 04 86 , 34 21 6 772 867 , 93179160 , 54 23 93 | |



| | | | | | | | |
|--|--|--|--|--|-------------------------------|--|--|
| | | | | | OE numbers per ATE pn. | | e.g. replaced pn. / miscellaneous |
|--|--|--|--|--|-------------------------------|--|--|



SAH - Caliper rear

| | | | | | | | | | |
|----------------|---------------|------------|-----------------|---------|--|---------|---------|---|--|
| 24.0101-3803.2 | 260101 | VOLKSWAGEN | GOLF Plus (05-) | 1,6 | | 05.2005 | | 4439 36 , 001 421 04 86 , 34 21 6 772 867 , 93179160 , 54 23 93 | |
| | | VOLKSWAGEN | GOLF Plus (05-) | 1,4 TSI | | 06.2008 | | 4439 36 , 001 421 04 86 , 34 21 6 772 867 , 93179160 , 54 23 93 | |
| | | VOLKSWAGEN | GOLF Plus (05-) | 2,0 TDI | | 01.2005 | | 4439 36 , 001 421 04 86 , 34 21 6 772 867 , 93179160 , 54 23 93 | |
| | | VOLKSWAGEN | GOLF Plus (05-) | | | 05.2005 | | 4439 36 , 001 421 04 86 , 34 21 6 772 867 , 93179160 , 54 23 93 | |
| | | VOLKSWAGEN | GOLF V (03-08) | 2,0 SDI | | 01.2004 | 09.2008 | 4439 36 , 001 421 04 86 , 34 21 6 772 867 , 93179160 , 54 23 93 | |
| | | VOLKSWAGEN | GOLF V (03-08) | 2,0 TDI | | 10.2003 | 09.2008 | 4439 36 , 001 421 04 86 , 34 21 6 772 867 , 93179160 , 54 23 93 | |
| | | VOLKSWAGEN | GOLF V (03-08) | 2,0 GTI | | 09.2006 | 09.2008 | 4439 36 , 001 421 04 86 , 34 21 6 772 867 , 93179160 , 54 23 93 | |
| | | VOLKSWAGEN | GOLF V (03-08) | | | 09.2004 | 09.2008 | 4439 36 , 001 421 04 86 , 34 21 6 772 867 , 93179160 , 54 23 93 | |
| | | VOLKSWAGEN | GOLF V (03-08) | 2,0 FSI | | 10.2003 | 09.2008 | 4439 36 , 001 421 04 86 , 34 21 6 772 867 , 93179160 , 54 23 93 | |



| | | | | | | | |
|--|--|--|--|--|-------------------------------|--|--|
| | | | | | OE numbers per ATE pn. | | e.g. replaced pn. / miscellaneous |
|--|--|--|--|--|-------------------------------|--|--|



SAH - Caliper rear

| | | | | | | | | | |
|----------------|---------------|------------|----------------|---------|--|---------|---------|---|--|
| 24.0101-3803.2 | 260101 | VOLKSWAGEN | GOLF V (03-08) | 1,9 TDI | | 10.2003 | 09.2008 | 4439 36 , 001 421 04 86 , 34 21 6 772 867 , 93179160 , 54 23 93 | |
| | | VOLKSWAGEN | GOLF V (03-08) | | | 05.2004 | 09.2008 | 4439 36 , 001 421 04 86 , 34 21 6 772 867 , 93179160 , 54 23 93 | |
| | | VOLKSWAGEN | GOLF V (03-08) | 1,6 FSI | | 10.2003 | 09.2008 | 4439 36 , 001 421 04 86 , 34 21 6 772 867 , 93179160 , 54 23 93 | |
| | | VOLKSWAGEN | GOLF V (03-08) | 1,6 16V | | 01.2004 | 09.2008 | 4439 36 , 001 421 04 86 , 34 21 6 772 867 , 93179160 , 54 23 93 | |
| | | VOLKSWAGEN | GOLF V (03-08) | 1,4 TSI | | 11.2005 | 09.2008 | 4439 36 , 001 421 04 86 , 34 21 6 772 867 , 93179160 , 54 23 93 | |
| | | VOLKSWAGEN | GOLF V (03-08) | | | 05.2007 | 09.2008 | 4439 36 , 001 421 04 86 , 34 21 6 772 867 , 93179160 , 54 23 93 | |
| | | VOLKSWAGEN | GOLF V (03-08) | | | 05.2006 | 09.2008 | 4439 36 , 001 421 04 86 , 34 21 6 772 867 , 93179160 , 54 23 93 | |
| | | VOLKSWAGEN | GOLF V (03-08) | 1,4 FSI | | 10.2003 | 09.2008 | 4439 36 , 001 421 04 86 , 34 21 6 772 867 , 93179160 , 54 23 93 | |
| | | VOLKSWAGEN | GOLF V (03-08) | 1,4 16V | | 10.2003 | 09.2008 | 4439 36 , 001 421 04 86 , 34 21 6 772 867 , 93179160 , 54 23 93 | |



| | | | | | | | |
|--|--|--|--|--|-------------------------------|--|--|
| | | | | | OE numbers per ATE pn. | | e.g. replaced pn. / miscellaneous |
|--|--|--|--|--|-------------------------------|--|--|



SAH - Caliper rear

| | | | | | | | | | |
|----------------|---------------|------------|----------------|-------------|--|---------|---------|---|--|
| 24.0101-3803.2 | 260101 | VOLKSWAGEN | GOLF V (03-08) | 2,0 TDI | | 11.2005 | 09.2008 | 4439 36 , 001 421 04 86 , 34 21 6 772 867 , 93179160 , 54 23 93 | |
| | | VOLKSWAGEN | GOLF VI (08-) | | | 10.2008 | 10.2009 | 4439 36 , 001 421 04 86 , 34 21 6 772 867 , 93179160 , 54 23 93 | |
| | | VOLKSWAGEN | GOLF VI (08-) | 1,4 TSI | | 10.2008 | 10.2009 | 4439 36 , 001 421 04 86 , 34 21 6 772 867 , 93179160 , 54 23 93 | |
| | | VOLKSWAGEN | GOLF VI (08-) | 1,6 | | 10.2008 | 10.2009 | 4439 36 , 001 421 04 86 , 34 21 6 772 867 , 93179160 , 54 23 93 | |
| | | VOLKSWAGEN | GOLF VI (08-) | 1,2 TSI | | 05.2009 | 10.2009 | 4439 36 , 001 421 04 86 , 34 21 6 772 867 , 93179160 , 54 23 93 | |
| | | VOLKSWAGEN | GOLF VI (08-) | 1,6 Bi-Fuel | | 03.2009 | 10.2009 | 4439 36 , 001 421 04 86 , 34 21 6 772 867 , 93179160 , 54 23 93 | |
| | | VOLKSWAGEN | GOLF VI (08-) | 1,6 TDI | | 02.2009 | 10.2009 | 4439 36 , 001 421 04 86 , 34 21 6 772 867 , 93179160 , 54 23 93 | |
| | | VOLKSWAGEN | GOLF VI (08-) | 1,4 | | 10.2008 | 10.2009 | 4439 36 , 001 421 04 86 , 34 21 6 772 867 , 93179160 , 54 23 93 | |
| | | VOLKSWAGEN | GOLF VI (08-) | 2,0 TDI | | 04.2009 | 10.2009 | 4439 36 , 001 421 04 86 , 34 21 6 772 867 , 93179160 , 54 23 93 | |



| | | | | | | | |
|--|--|--|--|--|-------------------------------|--|--|
| | | | | | OE numbers per ATE pn. | | e.g. replaced pn. / miscellaneous |
|--|--|--|--|--|-------------------------------|--|--|



SAH - Caliper rear

| | | | | | | | | | |
|----------------|---------------|------------|---|---------|--|---------|---------|---|--|
| 24.0101-3803.2 | 260101 | VOLKSWAGEN | GOLF VI (08-) | 2,0 TSI | | 07.2009 | 10.2009 | 4439 36 , 001 421 04 86 , 34 21 6 772 867 , 93179160 , 54 23 93 | |
| | | VOLKSWAGEN | GOLF VI (08-) | 2,5 FSI | | 08.2009 | 10.2009 | 4439 36 , 001 421 04 86 , 34 21 6 772 867 , 93179160 , 54 23 93 | |
| | | VOLKSWAGEN | GOLF VI (08-) | 2,0 GTI | | 03.2009 | 10.2009 | 4439 36 , 001 421 04 86 , 34 21 6 772 867 , 93179160 , 54 23 93 | |
| | | RENAULT | MEGANE II Coupe/Convertible (EM_) (03-) | 1,5 dCi | | 01.2007 | 04.2007 | 4439 36 , 001 421 04 86 , 34 21 6 772 867 , 93179160 , 54 23 93 | |
| | | RENAULT | MEGANE II Coupe/Convertible (EM_) (03-) | | | 03.2006 | 04.2007 | 4439 36 , 001 421 04 86 , 34 21 6 772 867 , 93179160 , 54 23 93 | |
| | | RENAULT | MEGANE II Coupe/Convertible (EM_) (03-) | | | 05.2005 | 04.2007 | 4439 36 , 001 421 04 86 , 34 21 6 772 867 , 93179160 , 54 23 93 | |
| | | RENAULT | MEGANE II Coupe/Convertible (EM_) (03-) | | | 05.2007 | 06.2008 | 4439 36 , 001 421 04 86 , 34 21 6 772 867 , 93179160 , 54 23 93 | |
| | | RENAULT | MEGANE II Coupe/Convertible (EM_) (03-) | 1,9 dCi | | 09.2003 | 04.2007 | 4439 36 , 001 421 04 86 , 34 21 6 772 867 , 93179160 , 54 23 93 | |
| | | RENAULT | MEGANE II Coupe/Convertible (EM_) (03-) | 2,0 16V | | 09.2003 | 03.2007 | 4439 36 , 001 421 04 86 , 34 21 6 772 867 , 93179160 , 54 23 93 | |



| | | | | | | |
|--|--|--|--|--|-------------------------------|---------------------------------------|
| | | | | | OE numbers per ATE pn. | e.g. replaced pn. / miscellaneous |
|--|--|--|--|--|-------------------------------|---------------------------------------|



SAH - Caliper rear

| | | | | | | | | |
|----------------|---------------|---------|---|---------------|---------|---------|---|--|
| 24.0101-3803.2 | 260101 | RENAULT | MEGANE II Coupe/Convertible (EM_) (03-) | 1,6 16V | 06.2005 | 04.2007 | 4439 36 , 001 421 04 86 , 34 21 6 772 867 , 93179160 , 54 23 93 | |
| | | RENAULT | MEGANE II Coupe/Convertible (EM_) (03-) | 1,5 dCi | 05.2007 | 06.2009 | 4439 36 , 001 421 04 86 , 34 21 6 772 867 , 93179160 , 54 23 93 | |
| | | RENAULT | MEGANE II Coupe/Convertible (EM_) (03-) | 1,6 16V | 09.2003 | 04.2007 | 4439 36 , 001 421 04 86 , 34 21 6 772 867 , 93179160 , 54 23 93 | |
| | | RENAULT | MEGANE II Coupe/Convertible (EM_) (03-) | 1,9 dCi | 05.2007 | | 4439 36 , 001 421 04 86 , 34 21 6 772 867 , 93179160 , 54 23 93 | |
| | | RENAULT | MEGANE II Coupe/Convertible (EM_) (03-) | | 05.2005 | 02.2007 | 4439 36 , 001 421 04 86 , 34 21 6 772 867 , 93179160 , 54 23 93 | |
| | | RENAULT | MEGANE II Coupe/Convertible (EM_) (03-) | | 01.2006 | 04.2007 | 4439 36 , 001 421 04 86 , 34 21 6 772 867 , 93179160 , 54 23 93 | |
| | | RENAULT | MEGANE II Coupe/Convertible (EM_) (03-) | 1,5 dCi | 05.2007 | | 4439 36 , 001 421 04 86 , 34 21 6 772 867 , 93179160 , 54 23 93 | |
| | | RENAULT | MEGANE II Coupe/Convertible (EM_) (03-) | 1,6 16V | 01.2007 | 04.2007 | 4439 36 , 001 421 04 86 , 34 21 6 772 867 , 93179160 , 54 23 93 | |
| | | RENAULT | MEGANE II Coupe/Convertible (EM_) (03-) | 2,0 16V Turbo | 05.2007 | | 4439 36 , 001 421 04 86 , 34 21 6 772 867 , 93179160 , 54 23 93 | |



| | | | | | | | |
|--|--|--|--|--|-------------------------------|--|--|
| | | | | | OE numbers per ATE pn. | | e.g. replaced pn. / miscellaneous |
|--|--|--|--|--|-------------------------------|--|--|



SAH - Caliper rear

| | | | | | | | | |
|----------------|---------------|---------|---|---------------|---------|---------|---|--|
| 24.0101-3803.2 | 260101 | RENAULT | MEGANE II Coupe/Convertible (EM_) (03-) | 2,0 16V Turbo | 05.2004 | 04.2007 | 4439 36 , 001 421 04 86 , 34 21 6 772 867 , 93179160 , 54 23 93 | |
| | | RENAULT | MEGANE II Coupe/Convertible (EM_) (03-) | 2,0 dCi | 05.2007 | | 4439 36 , 001 421 04 86 , 34 21 6 772 867 , 93179160 , 54 23 93 | |
| | | RENAULT | MEGANE II Coupe/Convertible (EM_) (03-) | 1,9 dCi | 05.2005 | 04.2007 | 4439 36 , 001 421 04 86 , 34 21 6 772 867 , 93179160 , 54 23 93 | |
| | | RENAULT | MEGANE II Coupe/Convertible (EM_) (03-) | 2,0 dCi | 09.2005 | 04.2007 | 4439 36 , 001 421 04 86 , 34 21 6 772 867 , 93179160 , 54 23 93 | |
| | | RENAULT | MEGANE II Coupe/Convertible (EM_) (03-) | 1,6 16V | 05.2007 | | 4439 36 , 001 421 04 86 , 34 21 6 772 867 , 93179160 , 54 23 93 | |
| | | RENAULT | MEGANE II Grandtour (KM_) (03-) | | 09.2003 | 04.2007 | 4439 36 , 001 421 04 86 , 34 21 6 772 867 , 93179160 , 54 23 93 | |
| | | RENAULT | MEGANE II Grandtour (KM_) (03-) | 2,0 16V | 05.2007 | | 4439 36 , 001 421 04 86 , 34 21 6 772 867 , 93179160 , 54 23 93 | |
| | | RENAULT | MEGANE II Grandtour (KM_) (03-) | | 09.2003 | 04.2007 | 4439 36 , 001 421 04 86 , 34 21 6 772 867 , 93179160 , 54 23 93 | |
| | | RENAULT | MEGANE II Grandtour (KM_) (03-) | 2,0 dCi | 05.2007 | | 4439 36 , 001 421 04 86 , 34 21 6 772 867 , 93179160 , 54 23 93 | |



| | | | | | | | |
|--|--|--|--|--|-------------------------------|--|--|
| | | | | | OE numbers per ATE pn. | | e.g. replaced pn. / miscellaneous |
|--|--|--|--|--|-------------------------------|--|--|



SAH - Caliper rear

| | | | | | | | | | |
|----------------|---------------|---------|---------------------------------|---------|--|---------|---------|---|--|
| 24.0101-3803.2 | 260101 | RENAULT | MEGANE II Grandtour (KM_) (03-) | 2,0 dCi | | 09.2005 | 04.2007 | 4439 36 , 001 421 04 86 , 34 21 6 772 867 , 93179160 , 54 23 93 | |
| | | RENAULT | MEGANE II Grandtour (KM_) (03-) | 1,5 dCi | | 01.2007 | 04.2007 | 4439 36 , 001 421 04 86 , 34 21 6 772 867 , 93179160 , 54 23 93 | |
| | | RENAULT | MEGANE II Grandtour (KM_) (03-) | | | 09.2003 | 05.2006 | 4439 36 , 001 421 04 86 , 34 21 6 772 867 , 93179160 , 54 23 93 | |
| | | RENAULT | MEGANE II Grandtour (KM_) (03-) | | | 05.2007 | | 4439 36 , 001 421 04 86 , 34 21 6 772 867 , 93179160 , 54 23 93 | |
| | | RENAULT | MEGANE II Grandtour (KM_) (03-) | 1,9 dCi | | 09.2003 | 04.2007 | 4439 36 , 001 421 04 86 , 34 21 6 772 867 , 93179160 , 54 23 93 | |
| | | RENAULT | MEGANE II Grandtour (KM_) (03-) | | | 05.2005 | 04.2007 | 4439 36 , 001 421 04 86 , 34 21 6 772 867 , 93179160 , 54 23 93 | |
| | | RENAULT | MEGANE II Grandtour (KM_) (03-) | 1,4 16V | | 09.2003 | 04.2007 | 4439 36 , 001 421 04 86 , 34 21 6 772 867 , 93179160 , 54 23 93 | |
| | | RENAULT | MEGANE II Grandtour (KM_) (03-) | | | 05.2007 | | 4439 36 , 001 421 04 86 , 34 21 6 772 867 , 93179160 , 54 23 93 | |
| | | RENAULT | MEGANE II Grandtour (KM_) (03-) | 1,6 16V | | 01.2007 | 04.2007 | 4439 36 , 001 421 04 86 , 34 21 6 772 867 , 93179160 , 54 23 93 | |



| | | | | | | | |
|--|--|--|--|--|-------------------------------|--|--|
| | | | | | OE numbers per ATE pn. | | e.g. replaced pn. / miscellaneous |
|--|--|--|--|--|-------------------------------|--|--|



SAH - Caliper rear

| | | | | | | | | | |
|----------------|---------------|---------|--|--------------|--|---------|---------|---|--|
| 24.0101-3803.2 | 260101 | RENAULT | MEGANE II Grandtour (KM_) (03-) | 1,5 dCi | | 05.2007 | 06.2008 | 4439 36 , 001 421 04 86 , 34 21 6 772 867 , 93179160 , 54 23 93 | |
| | | RENAULT | MEGANE II Grandtour (KM_) (03-) | | | 05.2005 | 04.2007 | 4439 36 , 001 421 04 86 , 34 21 6 772 867 , 93179160 , 54 23 93 | |
| | | RENAULT | MEGANE II Grandtour (KM_) (03-) | 1,9 dCi | | 05.2005 | 02.2007 | 4439 36 , 001 421 04 86 , 34 21 6 772 867 , 93179160 , 54 23 93 | |
| | | RENAULT | MEGANE II Grandtour (KM_) (03-) | | | 03.2004 | 02.2007 | 4439 36 , 001 421 04 86 , 34 21 6 772 867 , 93179160 , 54 23 93 | |
| | | RENAULT | MEGANE II Grandtour (KM_) (03-) | | | 05.2007 | | 4439 36 , 001 421 04 86 , 34 21 6 772 867 , 93179160 , 54 23 93 | |
| | | RENAULT | MEGANE II Grandtour (KM_) (03-) | 1,6 16V | | 05.2007 | | 4439 36 , 001 421 04 86 , 34 21 6 772 867 , 93179160 , 54 23 93 | |
| | | RENAULT | MEGANE II Grandtour (KM_) (03-) | 1,6 FlexFuel | | 02.2008 | | 4439 36 , 001 421 04 86 , 34 21 6 772 867 , 93179160 , 54 23 93 | |
| | | RENAULT | MEGANE II Grandtour (KM_) (03-) | 1,5 dCi | | 02.2004 | 03.2006 | 4439 36 , 001 421 04 86 , 34 21 6 772 867 , 93179160 , 54 23 93 | |
| | | RENAULT | MEGANE II Saloon 3/5-door(BM_/CM_) (02-) | 2,0 16V | | | | 4439 36 , 001 421 04 86 , 34 21 6 772 867 , 93179160 , 54 23 93 | |



| | | | | | | |
|--|--|--|--|--|-------------------------------|---------------------------------------|
| | | | | | OE numbers per ATE pn. | e.g. replaced pn. / miscellaneous |
|--|--|--|--|--|-------------------------------|---------------------------------------|



SAH - Caliper rear

| | | | | | | | | | |
|----------------|---------------|---------|--|---------------|--|--|---------|---|--|
| 24.0101-3803.2 | 260101 | RENAULT | MEGANE II Saloon 3/5-door(BM_/CM_) (02-) | 1,5 dCi | | | | 4439 36 , 001 421 04 86 , 34 21 6 772 867 , 93179160 , 54 23 93 | |
| | | RENAULT | MEGANE II Saloon 3/5-door(BM_/CM_) (02-) | 1,4 16V | | | | 4439 36 , 001 421 04 86 , 34 21 6 772 867 , 93179160 , 54 23 93 | |
| | | RENAULT | MEGANE II Saloon 3/5-door(BM_/CM_) (02-) | 1,9 dCi | | | | 4439 36 , 001 421 04 86 , 34 21 6 772 867 , 93179160 , 54 23 93 | |
| | | RENAULT | MEGANE II Saloon 3/5-door(BM_/CM_) (02-) | 1,6 FlexFuel | | | | 4439 36 , 001 421 04 86 , 34 21 6 772 867 , 93179160 , 54 23 93 | |
| | | RENAULT | MEGANE II Saloon 3/5-door(BM_/CM_) (02-) | 1,6 16V | | | | 4439 36 , 001 421 04 86 , 34 21 6 772 867 , 93179160 , 54 23 93 | |
| | | RENAULT | MEGANE II Saloon 3/5-door(BM_/CM_) (02-) | 2,0 16V Sport | | | | 4439 36 , 001 421 04 86 , 34 21 6 772 867 , 93179160 , 54 23 93 | |
| | | RENAULT | MEGANE II Saloon 3/5-door(BM_/CM_) (02-) | 2,0 16V Turbo | | | | 4439 36 , 001 421 04 86 , 34 21 6 772 867 , 93179160 , 54 23 93 | |
| | | RENAULT | MEGANE II Saloon 3/5-door(BM_/CM_) (02-) | 2,0 dCi | | | | 4439 36 , 001 421 04 86 , 34 21 6 772 867 , 93179160 , 54 23 93 | |
| | | RENAULT | MEGANE II Saloon 4-door (LM_) (03-) | 1,4 16V | | | 08.2006 | 4439 36 , 001 421 04 86 , 34 21 6 772 867 , 93179160 , 54 23 93 | |



| | | | | | | | |
|--|--|--|--|--|-------------------------------|--|--|
| | | | | | OE numbers per ATE pn. | | e.g. replaced pn. / miscellaneous |
|--|--|--|--|--|-------------------------------|--|--|



SAH - Caliper rear

| | | | | | | | | | |
|----------------|---------------|---------|-------------------------------------|---------|--|---------|---------|---|--|
| 24.0101-3803.2 | 260101 | RENAULT | MEGANE II Saloon 4-door (LM_) (03-) | 1,5 dCi | | | 03.2006 | 4439 36 , 001 421 04 86 , 34 21 6 772 867 , 93179160 , 54 23 93 | |
| | | RENAULT | MEGANE II Saloon 4-door (LM_) (03-) | 1,4 16V | | | | 4439 36 , 001 421 04 86 , 34 21 6 772 867 , 93179160 , 54 23 93 | |
| | | RENAULT | MEGANE II Saloon 4-door (LM_) (03-) | 1,9 dCi | | | | 4439 36 , 001 421 04 86 , 34 21 6 772 867 , 93179160 , 54 23 93 | |
| | | RENAULT | MEGANE II Saloon 4-door (LM_) (03-) | 1,5 dCi | | 01.2007 | | 4439 36 , 001 421 04 86 , 34 21 6 772 867 , 93179160 , 54 23 93 | |
| | | RENAULT | MEGANE II Saloon 4-door (LM_) (03-) | 1,9 dCi | | | 12.2005 | 4439 36 , 001 421 04 86 , 34 21 6 772 867 , 93179160 , 54 23 93 | |
| | | RENAULT | MEGANE II Saloon 4-door (LM_) (03-) | 1,5 dCi | | | | 4439 36 , 001 421 04 86 , 34 21 6 772 867 , 93179160 , 54 23 93 | |
| | | RENAULT | MEGANE II Saloon 4-door (LM_) (03-) | 1,6 16V | | | | 4439 36 , 001 421 04 86 , 34 21 6 772 867 , 93179160 , 54 23 93 | |
| | | RENAULT | MEGANE II Saloon 4-door (LM_) (03-) | | | 01.2007 | | 4439 36 , 001 421 04 86 , 34 21 6 772 867 , 93179160 , 54 23 93 | |
| | | RENAULT | MEGANE II Saloon 4-door (LM_) (03-) | 2,0 16V | | | | 4439 36 , 001 421 04 86 , 34 21 6 772 867 , 93179160 , 54 23 93 | |



| | | | | | | | |
|--|--|--|--|--|-------------------------------|--|--|
| | | | | | OE numbers per ATE pn. | | e.g. replaced pn. / miscellaneous |
|--|--|--|--|--|-------------------------------|--|--|



SAH - Caliper rear

| | | | | | | | | |
|----------------|---------------|---------|-------------------------------------|---------|--|---------|---|--|
| 24.0101-3803.2 | 260101 | RENAULT | MEGANE II Saloon 4-door (LM_) (03-) | 2,0 dCi | | 09.2005 | 4439 36 , 001 421 04 86 , 34 21 6 772 867 , 93179160 , 54 23 93 | |
| | | RENAULT | MODUS/GRAND MODUS (JP0_) (04-) | 1,2 16V | | 05.2007 | 4439 36 , 001 421 04 86 , 34 21 6 772 867 , 93179160 , 54 23 93 | |
| | | RENAULT | MODUS/GRAND MODUS (JP0_) (04-) | 1,4 16V | | 08.2004 | 4439 36 , 001 421 04 86 , 34 21 6 772 867 , 93179160 , 54 23 93 | |
| | | RENAULT | MODUS/GRAND MODUS (JP0_) (04-) | 1,5 dCi | | 05.2007 | 4439 36 , 001 421 04 86 , 34 21 6 772 867 , 93179160 , 54 23 93 | |
| | | RENAULT | MODUS/GRAND MODUS (JP0_) (04-) | 1,2 16V | | 08.2004 | 4439 36 , 001 421 04 86 , 34 21 6 772 867 , 93179160 , 54 23 93 | |
| | | RENAULT | MODUS/GRAND MODUS (JP0_) (04-) | 1,5 dCi | | 05.2005 | 4439 36 , 001 421 04 86 , 34 21 6 772 867 , 93179160 , 54 23 93 | |
| | | RENAULT | MODUS/GRAND MODUS (JP0_) (04-) | | | 08.2004 | 4439 36 , 001 421 04 86 , 34 21 6 772 867 , 93179160 , 54 23 93 | |
| | | RENAULT | MODUS/GRAND MODUS (JP0_) (04-) | 1,6 16V | | 08.2004 | 4439 36 , 001 421 04 86 , 34 21 6 772 867 , 93179160 , 54 23 93 | |
| | | RENAULT | MODUS/GRAND MODUS (JP0_) (04-) | 1,2 16V | | 05.2005 | 4439 36 , 001 421 04 86 , 34 21 6 772 867 , 93179160 , 54 23 93 | |



| | | | | | | |
|--|--|--|--|--|-------------------------------|--|
| | | | | | OE numbers per ATE pn. | e.g. replaced pn. / miscellaneous |
|--|--|--|--|--|-------------------------------|--|



SAH - Caliper rear

| | | | | | | | | |
|----------------|---------------|---------|--------------------------------|-----------------|--|---------|---|--|
| 24.0101-3803.2 | 260101 | RENAULT | MODUS/GRAND MODUS (JP0_) (04-) | 1,2 16V Hi-Flex | | 10.2008 | 4439 36 , 001 421 04 86 , 34 21 6 772 867 , 93179160 , 54 23 93 | |
| | | MINI | R55 Clubman (07-) | One D | | 03.2010 | 4439 36 , 001 421 04 86 , 34 21 6 772 867 , 93179160 , 54 23 93 | |
| | | MINI | R55 Clubman (07-) | One | | 03.2010 | 4439 36 , 001 421 04 86 , 34 21 6 772 867 , 93179160 , 54 23 93 | |
| | | MINI | R55 Clubman (07-) | Cooper S | | 09.2007 | 4439 36 , 001 421 04 86 , 34 21 6 772 867 , 93179160 , 54 23 93 | |
| | | MINI | R55 Clubman (07-) | Cooper | | 09.2007 | 4439 36 , 001 421 04 86 , 34 21 6 772 867 , 93179160 , 54 23 93 | |
| | | MINI | R55 Clubman (07-) | Cooper D | | 09.2007 | 4439 36 , 001 421 04 86 , 34 21 6 772 867 , 93179160 , 54 23 93 | |
| | | MINI | R56 (06-) | One D | | 03.2010 | 4439 36 , 001 421 04 86 , 34 21 6 772 867 , 93179160 , 54 23 93 | |
| | | MINI | R56 (06-) | Cooper | | 03.2010 | 4439 36 , 001 421 04 86 , 34 21 6 772 867 , 93179160 , 54 23 93 | |
| | | MINI | R56 (06-) | One | | 03.2009 | 4439 36 , 001 421 04 86 , 34 21 6 772 867 , 93179160 , 54 23 93 | |



| | | | | | | | |
|--|--|--|--|--|-------------------------------|--|--|
| | | | | | OE numbers per ATE pn. | | e.g. replaced pn. / miscellaneous |
|--|--|--|--|--|-------------------------------|--|--|



SAH - Caliper rear

| | | | | | | | | |
|----------------|---------------|------|-----------------------|----------|--|---------|---|--|
| 24.0101-3803.2 | 260101 | MINI | R56 (06-) | Cooper D | | 04.2007 | 4439 36 , 001 421 04 86 , 34 21 6 772 867 , 93179160 , 54 23 93 | |
| | | MINI | R56 (06-) | One | | 04.2007 | 4439 36 , 001 421 04 86 , 34 21 6 772 867 , 93179160 , 54 23 93 | |
| | | MINI | R56 (06-) | Cooper | | 11.2006 | 4439 36 , 001 421 04 86 , 34 21 6 772 867 , 93179160 , 54 23 93 | |
| | | MINI | R56 (06-) | Cooper S | | 11.2006 | 4439 36 , 001 421 04 86 , 34 21 6 772 867 , 93179160 , 54 23 93 | |
| | | MINI | R56 (06-) | One | | 03.2010 | 4439 36 , 001 421 04 86 , 34 21 6 772 867 , 93179160 , 54 23 93 | |
| | | MINI | R56 (06-) | Cooper S | | 03.2010 | 4439 36 , 001 421 04 86 , 34 21 6 772 867 , 93179160 , 54 23 93 | |
| | | MINI | R57 Convertible (09-) | Cooper | | 03.2010 | 4439 36 , 001 421 04 86 , 34 21 6 772 867 , 93179160 , 54 23 93 | |
| | | MINI | R57 Convertible (09-) | Cooper S | | 03.2010 | 4439 36 , 001 421 04 86 , 34 21 6 772 867 , 93179160 , 54 23 93 | |
| | | MINI | R57 Convertible (09-) | One | | 03.2010 | 4439 36 , 001 421 04 86 , 34 21 6 772 867 , 93179160 , 54 23 93 | |



| | | | | | | | |
|--|--|--|--|--|-------------------------------|--|--|
| | | | | | OE numbers per ATE pn. | | e.g. replaced pn. / miscellaneous |
|--|--|--|--|--|-------------------------------|--|--|



SAH - Caliper rear

| | | | | | | | | | |
|----------------|---------------|---------|-------------------------|--------------|--|---------|---------|---|--|
| 24.0101-3803.2 | 260101 | MINI | R57 Convertible (09-) | Cooper | | 01.2009 | | 4439 36 , 001 421 04 86 , 34 21 6 772 867 , 93179160 , 54 23 93 | |
| | | MINI | R57 Convertible (09-) | Cooper D 1,6 | | 08.2010 | | 4439 36 , 001 421 04 86 , 34 21 6 772 867 , 93179160 , 54 23 93 | |
| | | MINI | R57 Convertible (09-) | Cooper S | | 01.2009 | | 4439 36 , 001 421 04 86 , 34 21 6 772 867 , 93179160 , 54 23 93 | |
| | | RENAULT | SCENIC II (JM_) (03-09) | 1,5 dCi | | 11.2003 | 03.2009 | 4439 36 , 001 421 04 86 , 34 21 6 772 867 , 93179160 , 54 23 93 | |
| | | RENAULT | SCENIC II (JM_) (03-09) | | | 06.2003 | 03.2009 | 4439 36 , 001 421 04 86 , 34 21 6 772 867 , 93179160 , 54 23 93 | |
| | | RENAULT | SCENIC II (JM_) (03-09) | | | 05.2005 | 03.2009 | 4439 36 , 001 421 04 86 , 34 21 6 772 867 , 93179160 , 54 23 93 | |
| | | RENAULT | SCENIC II (JM_) (03-09) | 1,4 16V | | 06.2003 | 03.2009 | 4439 36 , 001 421 04 86 , 34 21 6 772 867 , 93179160 , 54 23 93 | |
| | | RENAULT | SCENIC II (JM_) (03-09) | 2,0 16V | | 06.2003 | 03.2009 | 4439 36 , 001 421 04 86 , 34 21 6 772 867 , 93179160 , 54 23 93 | |
| | | RENAULT | SCENIC II (JM_) (03-09) | 1,6 | | 06.2006 | 03.2009 | 4439 36 , 001 421 04 86 , 34 21 6 772 867 , 93179160 , 54 23 93 | |



| | | | | | | | |
|--|--|--|--|--|-------------------------------|--|--|
| | | | | | OE numbers per ATE pn. | | e.g. replaced pn. / miscellaneous |
|--|--|--|--|--|-------------------------------|--|--|



SAH - Caliper rear

| | | | | | | | | | |
|----------------|---------------|------------|-------------------------|---------------|--|---------|---------|---|--|
| 24.0101-3803.2 | 260101 | RENAULT | SCENIC II (JM_) (03-09) | 1,9 dCi | | 05.2005 | 03.2009 | 4439 36 , 001 421 04 86 , 34 21 6 772 867 , 93179160 , 54 23 93 | |
| | | RENAULT | SCENIC II (JM_) (03-09) | 2,0 16V Turbo | | 05.2004 | 03.2009 | 4439 36 , 001 421 04 86 , 34 21 6 772 867 , 93179160 , 54 23 93 | |
| | | RENAULT | SCENIC II (JM_) (03-09) | 2,0 dCi 110 | | 09.2005 | 03.2009 | 4439 36 , 001 421 04 86 , 34 21 6 772 867 , 93179160 , 54 23 93 | |
| | | RENAULT | SCENIC II (JM_) (03-09) | 1,9 dCi | | 06.2003 | 03.2009 | 4439 36 , 001 421 04 86 , 34 21 6 772 867 , 93179160 , 54 23 93 | |
| | | RENAULT | SCENIC II (JM_) (03-09) | 1,9 D | | 06.2006 | 03.2009 | 4439 36 , 001 421 04 86 , 34 21 6 772 867 , 93179160 , 54 23 93 | |
| | | RENAULT | SCENIC II (JM_) (03-09) | 1,6 16V | | 06.2003 | 03.2009 | 4439 36 , 001 421 04 86 , 34 21 6 772 867 , 93179160 , 54 23 93 | |
| | | VOLKSWAGEN | SCIROCCO (08-) | 2,0 TDI | | 10.2008 | | 4439 36 , 001 421 04 86 , 34 21 6 772 867 , 93179160 , 54 23 93 | |
| | | VOLKSWAGEN | SCIROCCO (08-) | 1,4 TSI | | 09.2008 | | 4439 36 , 001 421 04 86 , 34 21 6 772 867 , 93179160 , 54 23 93 | |
| | | VOLKSWAGEN | SCIROCCO (08-) | 2,0 R | | 11.2009 | | 4439 36 , 001 421 04 86 , 34 21 6 772 867 , 93179160 , 54 23 93 | |



| | | | | | | | |
|--|--|--|--|--|-------------------------------|--|--|
| | | | | | OE numbers per ATE pn. | | e.g. replaced pn. / miscellaneous |
|--|--|--|--|--|-------------------------------|--|--|



SAH - Caliper rear

| | | | | | | | | |
|----------------|---------------|------------|-------------------|----------|--|---------|---|--|
| 24.0101-3803.2 | 260101 | VOLKSWAGEN | SCIROCCO (08-) | 2,0 TDI | | 05.2009 | 4439 36 , 001 421 04 86 , 34 21 6 772 867 , 93179160 , 54 23 93 | |
| | | VOLKSWAGEN | SCIROCCO (08-) | 1,4 TSI | | 08.2008 | 4439 36 , 001 421 04 86 , 34 21 6 772 867 , 93179160 , 54 23 93 | |
| | | VOLKSWAGEN | SCIROCCO (08-) | 2,0 TSI | | 08.2008 | 4439 36 , 001 421 04 86 , 34 21 6 772 867 , 93179160 , 54 23 93 | |
| | | AUDI | TT Coupe (06-) | 2,0 TFSI | | 07.2006 | 4439 36 , 001 421 04 86 , 34 21 6 772 867 , 93179160 , 54 23 93 | |
| | | AUDI | TT Coupe (06-) | | | 05.2010 | 4439 36 , 001 421 04 86 , 34 21 6 772 867 , 93179160 , 54 23 93 | |
| | | AUDI | TT Coupe (06-) | 1,8 TFSI | | 06.2008 | 4439 36 , 001 421 04 86 , 34 21 6 772 867 , 93179160 , 54 23 93 | |
| | | AUDI | TT Roadster (07-) | | | 06.2008 | 4439 36 , 001 421 04 86 , 34 21 6 772 867 , 93179160 , 54 23 93 | |
| | | AUDI | TT Roadster (07-) | 2,0 TFSI | | 05.2010 | 4439 36 , 001 421 04 86 , 34 21 6 772 867 , 93179160 , 54 23 93 | |
| | | AUDI | TT Roadster (07-) | | | 02.2007 | 4439 36 , 001 421 04 86 , 34 21 6 772 867 , 93179160 , 54 23 93 | |



| | | | | | | | |
|--|--|--|--|--|-------------------------------|--|--|
| | | | | | OE numbers per ATE pn. | | e.g. replaced pn. / miscellaneous |
|--|--|--|--|--|-------------------------------|--|--|



SAH - Caliper rear

| | | | | | | | |
|----------------|---------------|---------|--|---------------|---------|---|--|
| 24.0101-3803.2 | 260101 | RENAULT | TWINGO II (CN0_) (07-) | 1,6 RS | 05.2008 | 4439 36 , 001 421 04 86 , 34 21 6 772 867 , 93179160 , 54 23 93 | |
| | | RENAULT | WIND (E4M_) (10-) | 1,2 16V Turbo | 07.2010 | 4439 36 , 001 421 04 86 , 34 21 6 772 867 , 93179160 , 54 23 93 | |
| | | RENAULT | WIND (E4M_) (10-) | 1,6 16V | 07.2010 | 4439 36 , 001 421 04 86 , 34 21 6 772 867 , 93179160 , 54 23 93 | |
| | | OPEL | ZAFIRA II / Vauxhall Zafira II (05-11) | 2,2 | 07.2005 | 4439 36 , 001 421 04 86 , 34 21 6 772 867 , 93179160 , 54 23 93 | |
| | | OPEL | ZAFIRA II / Vauxhall Zafira II (05-11) | 1,6 | 07.2005 | 4439 36 , 001 421 04 86 , 34 21 6 772 867 , 93179160 , 54 23 93 | |
| | | OPEL | ZAFIRA II / Vauxhall Zafira II (05-11) | 2,0 Turbo | 07.2005 | 4439 36 , 001 421 04 86 , 34 21 6 772 867 , 93179160 , 54 23 93 | |
| | | OPEL | ZAFIRA II / Vauxhall Zafira II (05-11) | 1,9 CDTI | 07.2005 | 4439 36 , 001 421 04 86 , 34 21 6 772 867 , 93179160 , 54 23 93 | |
| | | OPEL | ZAFIRA II / Vauxhall Zafira II (05-11) | 1,8 | 07.2005 | 4439 36 , 001 421 04 86 , 34 21 6 772 867 , 93179160 , 54 23 93 | |
| | | OPEL | ZAFIRA II / Vauxhall Zafira II (05-11) | 1,7 CDTI | 12.2007 | 4439 36 , 001 421 04 86 , 34 21 6 772 867 , 93179160 , 54 23 93 | |



| | | | | | | | |
|--|--|--|--|--|-------------------------------|--|--|
| | | | | | OE numbers per ATE pn. | | e.g. replaced pn. / miscellaneous |
|--|--|--|--|--|-------------------------------|--|--|



SAH - Caliper rear

| | | | | | | | | | |
|----------------|---------------|------|--|---------------|--|---------|--|---|--|
| 24.0101-3803.2 | 260101 | OPEL | ZAFIRA II / Vauxhall Zafira II (05-11) | 1,6 CNG Turbo | | 02.2009 | | 4439 36 , 001 421 04 86 , 34 21 6 772 867 , 93179160 , 54 23 93 | |
| | | OPEL | ZAFIRA II / Vauxhall Zafira II (05-11) | 1,6 CNG | | 01.2006 | | 4439 36 , 001 421 04 86 , 34 21 6 772 867 , 93179160 , 54 23 93 | |
| | | OPEL | ZAFIRA II / Vauxhall Zafira II (05-11) | 1,6 | | 12.2007 | | 4439 36 , 001 421 04 86 , 34 21 6 772 867 , 93179160 , 54 23 93 | |



SAV - Caliper front

| | | | | | | | | | |
|----------------|---------------|------|-----------------|--------------|----|---------|---------|-------------------------|--|
| 24.3541-8105.5 | 240485 | FORD | FOCUS I (98-04) | 1,8 Turbo DI | FL | 10.1998 | 09.2004 | 1075789 , 98AB-2L232-BB | |
| | | FORD | FOCUS I (98-04) | 1,8 TDCi | FL | 03.2001 | 09.2004 | 1075789 , 98AB-2L232-BB | |
| | | FORD | FOCUS I (98-04) | 1,8 i 16V | FL | 10.1998 | 09.2004 | 1075789 , 98AB-2L232-BB | |
| | | FORD | FOCUS I (98-04) | 1,6 i 16V | FL | 10.1998 | 09.2004 | 1075789 , 98AB-2L232-BB | |
| | | FORD | FOCUS I (98-04) | 1,4 i 16V | FL | 10.1998 | 09.2004 | 1075789 , 98AB-2L232-BB | |
| | | FORD | FOCUS I (98-04) | 2,0 i 16V | FL | 10.1998 | 09.2004 | 1075789 , 98AB-2L232-BB | |
| 24.3571-8505.5 | 240489 | AUDI | 100 (91-94) | 2,0 16V | FL | 01.1992 | 07.1994 | 4A0 615 123 | |
| | | AUDI | 100 (91-94) | 2,3 | FL | 12.1990 | 07.1994 | 4A0 615 123 | |
| | | AUDI | 100 (91-94) | 2,5 TDI | FL | 06.1991 | 07.1994 | 4A0 615 123 | |



| | | | | | | | |
|--|--|--|--|--|-------------------------------|--|--|
| | | | | | OE numbers per ATE pn. | | e.g. replaced pn. / miscellaneous |
|--|--|--|--|--|-------------------------------|--|--|



SAV - Caliper front

| | | | | | | | | | |
|----------------|---------------|------|-------------------------------|-------------|----|---------|---------|-------------|--|
| 24.3571-8505.5 | 240489 | AUDI | 100 (91-94) | 2 | FL | 12.1990 | 07.1994 | 4A0 615 123 | |
| | | AUDI | 100 (91-94) | 1,6 | FL | 03.1992 | 07.1993 | 4A0 615 123 | |
| | | AUDI | 100 (91-94) | 2,4 D | FL | 05.1991 | 07.1994 | 4A0 615 123 | |
| | | AUDI | 100 Quattro (91-94) | 2 | FL | 12.1990 | 07.1994 | 4A0 615 123 | |
| | | AUDI | 100 Quattro (91-94) | 2,3 | FL | 12.1990 | 07.1994 | 4A0 615 123 | |
| | | AUDI | A6 / A6 Avant (4A/C4) (94-97) | 2 | FL | 06.1994 | 12.1997 | 4A0 615 123 | |
| | | AUDI | A6 / A6 Avant (4A/C4) (94-97) | 2,5 TDI | FL | 06.1994 | 12.1997 | 4A0 615 123 | |
| | | AUDI | A6 / A6 Avant (4A/C4) (94-97) | 2,3 Quattro | FL | 08.1994 | 12.1995 | 4A0 615 123 | |
| | | AUDI | A6 / A6 Avant (4A/C4) (94-97) | 2,3 | FL | 06.1994 | 12.1995 | 4A0 615 123 | |
| | | AUDI | A6 / A6 Avant (4A/C4) (94-97) | 2,0 16V | FL | 06.1994 | 12.1997 | 4A0 615 123 | |
| | | AUDI | A6 / A6 Avant (4A/C4) (94-97) | 1,9 TDI | FL | 06.1994 | 12.1997 | 4A0 615 123 | |
| | | AUDI | A6 / A6 Avant (4A/C4) (94-97) | 1,8 Quattro | FL | 10.1995 | 12.1997 | 4A0 615 123 | |
| | | AUDI | A6 / A6 Avant (4A/C4) (94-97) | 1,8 | FL | 10.1995 | 12.1997 | 4A0 615 123 | |
| | | AUDI | A6 / A6 Avant (4A/C4) (94-97) | 2,0 Quattro | FL | 06.1994 | 12.1997 | 4A0 615 123 | |
| 24.3571-8506.5 | 240490 | AUDI | 100 (91-94) | 2,5 TDI | FR | 06.1991 | 07.1994 | 4A0 615 124 | |
| | | AUDI | 100 (91-94) | 2,4 D | FR | 05.1991 | 07.1994 | 4A0 615 124 | |
| | | AUDI | 100 (91-94) | 1,6 | FR | 03.1992 | 07.1993 | 4A0 615 124 | |
| | | AUDI | 100 (91-94) | 2 | FR | 12.1990 | 07.1994 | 4A0 615 124 | |



| | | | | | | | |
|--|--|--|--|--|-------------------------------|--|--|
| | | | | | OE numbers per ATE pn. | | e.g. replaced pn. / miscellaneous |
|--|--|--|--|--|-------------------------------|--|--|



SAV - Caliper front

| | | | | | | | | | |
|----------------|---------------|------|---------------------------------------|-------------|----|---------|---------|--|--|
| 24.3571-8506.5 | 240490 | AUDI | 100 (91-94) | 2,0 16V | FR | 01.1992 | 07.1994 | 4A0 615 124 | |
| | | AUDI | 100 (91-94) | 2,3 | FR | 12.1990 | 07.1994 | 4A0 615 124 | |
| | | AUDI | 100 Quattro (91-94) | | FR | 12.1990 | 07.1994 | 4A0 615 124 | |
| | | AUDI | 100 Quattro (91-94) | 2 | FR | 12.1990 | 07.1994 | 4A0 615 124 | |
| | | AUDI | A6 / A6 Avant (4A/C4) (94-97) | 1,8 | FR | 10.1995 | 12.1997 | 4A0 615 124 | |
| | | AUDI | A6 / A6 Avant (4A/C4) (94-97) | 1,8 Quattro | FR | 10.1995 | 12.1997 | 4A0 615 124 | |
| | | AUDI | A6 / A6 Avant (4A/C4) (94-97) | 1,9 TDI | FR | 06.1994 | 12.1997 | 4A0 615 124 | |
| | | AUDI | A6 / A6 Avant (4A/C4) (94-97) | 2 | FR | 06.1994 | 12.1997 | 4A0 615 124 | |
| | | AUDI | A6 / A6 Avant (4A/C4) (94-97) | 2,0 16V | FR | 06.1994 | 12.1997 | 4A0 615 124 | |
| | | AUDI | A6 / A6 Avant (4A/C4) (94-97) | 2,0 Quattro | FR | 06.1994 | 12.1997 | 4A0 615 124 | |
| | | AUDI | A6 / A6 Avant (4A/C4) (94-97) | 2,3 | FR | 06.1994 | 12.1995 | 4A0 615 124 | |
| | | AUDI | A6 / A6 Avant (4A/C4) (94-97) | 2,3 Quattro | FR | 08.1994 | 12.1995 | 4A0 615 124 | |
| | | AUDI | A6 / A6 Avant (4A/C4) (94-97) | 2,5 TDI | FR | 06.1994 | 12.1997 | 4A0 615 124 | |
| 24.3571-9824.5 | 240500 | OPEL | ASTRA G / Vauxhall Astra MKIV (98-04) | 1,8 16V | FR | 04.1998 | 12.2004 | 5 42 292 , 90544027 , 5 42 453 , 5 42 459 , 9192455 , 93173732 , 93176427 , 5 42 472 | |
| | | OPEL | ASTRA G / Vauxhall Astra MKIV (98-04) | 2,0 DI | FR | 04.1998 | 12.2004 | 5 42 292 , 90544027 , 5 42 453 , 5 42 459 , 9192455 , 93173732 , 93176427 , 5 42 472 | |



| | | | | | | | |
|--|--|--|--|--|-------------------------------|--|--|
| | | | | | OE numbers per ATE pn. | | e.g. replaced pn. / miscellaneous |
|--|--|--|--|--|-------------------------------|--|--|



SAV - Caliper front

| | | | | | | | | | |
|----------------|---------------|------|---------------------------------------|--------------------|----|---------|---------|--|--|
| 24.3571-9824.5 | 240500 | OPEL | ASTRA G / Vauxhall Astra MKIV (98-04) | 2,2 DTI 16V | FR | 09.2002 | 12.2004 | 5 42 292 , 90544027 , 5 42 453 , 5 42 459 , 9192455 , 93173732 , 93176427 , 5 42 472 | |
| | | OPEL | ASTRA G / Vauxhall Astra MKIV (98-04) | 2,2 16V Cabrio | FR | 03.2001 | 12.2004 | 5 42 292 , 90544027 , 5 42 453 , 5 42 459 , 9192455 , 93173732 , 93176427 , 5 42 472 | |
| | | OPEL | ASTRA G / Vauxhall Astra MKIV (98-04) | 2,2 16V | FR | 09.2000 | 12.2004 | 5 42 292 , 90544027 , 5 42 453 , 5 42 459 , 9192455 , 93173732 , 93176427 , 5 42 472 | |
| | | OPEL | ASTRA G / Vauxhall Astra MKIV (98-04) | 2,0 Turbo | FR | 03.2000 | 12.2004 | 5 42 292 , 90544027 , 5 42 453 , 5 42 459 , 9192455 , 93173732 , 93176427 , 5 42 472 | |
| | | OPEL | ASTRA G / Vauxhall Astra MKIV (98-04) | 2,0 DTI 16V | FR | 08.1999 | 12.2004 | 5 42 292 , 90544027 , 5 42 453 , 5 42 459 , 9192455 , 93173732 , 93176427 , 5 42 472 | |
| | | OPEL | ASTRA G / Vauxhall Astra MKIV (98-04) | 2,0 16V OPC Cabrio | FR | 03.2002 | 12.2004 | 5 42 292 , 90544027 , 5 42 453 , 5 42 459 , 9192455 , 93173732 , 93176427 , 5 42 472 | |
| | | OPEL | ASTRA G / Vauxhall Astra MKIV (98-04) | 2,0 16V OPC | FR | 10.1999 | 12.2004 | 5 42 292 , 90544027 , 5 42 453 , 5 42 459 , 9192455 , 93173732 , 93176427 , 5 42 472 | |
| | | OPEL | ASTRA G / Vauxhall Astra MKIV (98-04) | 2,0 16V | FR | 04.1998 | 12.2004 | 5 42 292 , 90544027 , 5 42 453 , 5 42 459 , 9192455 , 93173732 , 93176427 , 5 42 472 | |



| | | | | | | | |
|--|--|--|--|--|-------------------------------|--|--|
| | | | | | OE numbers per ATE pn. | | e.g. replaced pn. / miscellaneous |
|--|--|--|--|--|-------------------------------|--|--|



SAV - Caliper front

| | | | | | | | | | |
|----------------|---------------|------|--|--------------------|----|---------|---------|--|--|
| 24.3571-9824.5 | 240500 | OPEL | ASTRA G / Vauxhall Astra MKIV (98-04) | 1,8 16V Coupe | FR | 03.2000 | 12.2004 | 5 42 292 , 90544027 , 5 42 453 , 5 42 459 , 9192455 , 93173732 , 93176427 , 5 42 472 | |
| | | OPEL | ASTRA G / Vauxhall Astra MKIV (98-04) | 2,2 DTI 16V Coupe | FR | 09.2002 | 12.2004 | 5 42 292 , 90544027 , 5 42 453 , 5 42 459 , 9192455 , 93173732 , 93176427 , 5 42 472 | |
| | | OPEL | ASTRA G / Vauxhall Astra MKIV (98-04) | 1,8 16V Cabrio | FR | 03.2001 | 12.2004 | 5 42 292 , 90544027 , 5 42 453 , 5 42 459 , 9192455 , 93173732 , 93176427 , 5 42 472 | |
| | | OPEL | ASTRA G / Vauxhall Astra MKIV (98-04) | 2,2 DTI 16V Cabrio | FR | 09.2002 | 12.2004 | 5 42 292 , 90544027 , 5 42 453 , 5 42 459 , 9192455 , 93173732 , 93176427 , 5 42 472 | |
| | | OPEL | ASTRA G / Vauxhall Astra MKIV (98-04) | 1,6 CNG | FR | 03.2003 | 12.2004 | 5 42 292 , 90544027 , 5 42 453 , 5 42 459 , 9192455 , 93173732 , 93176427 , 5 42 472 | |
| | | OPEL | ASTRA G / Vauxhall Astra MKIV (98-04) | 1,8 16V Caravan | FR | 04.1998 | 12.2004 | 5 42 292 , 90544027 , 5 42 453 , 5 42 459 , 9192455 , 93173732 , 93176427 , 5 42 472 | |
| | | OPEL | ASTRA G / Vauxhall Astra MKIV (98-04) | 2,2 16V Coupe | FR | 09.2000 | 12.2004 | 5 42 292 , 90544027 , 5 42 453 , 5 42 459 , 9192455 , 93173732 , 93176427 , 5 42 472 | |
| | | OPEL | ASTRA H / GTC / Vauxhall Astra MKV (04-10) | 1,7 CDTI | FR | 01.2004 | 11.2010 | 5 42 292 , 90544027 , 5 42 453 , 5 42 459 , 9192455 , 93173732 , 93176427 , 5 42 472 | |



| | | | | | | |
|--|--|--|--|--|-------------------------------|--|
| | | | | | OE numbers per ATE pn. | e.g. replaced pn. / miscellaneous |
|--|--|--|--|--|-------------------------------|--|



SAV - Caliper front

| | | | | | | | | | |
|----------------|--------|------|--|-----------|----|---------|---------|--|--|
| 24.3571-9824.5 | 240500 | OPEL | ASTRA H / GTC / Vauxhall Astra MKV (04-10) | 2,0 Turbo | FR | 01.2004 | 11.2010 | 5 42 292 , 90544027 , 5 42 453 , 5 42 459 , 9192455 , 93173732 , 93176427 , 5 42 472 | |
| | | OPEL | ASTRA H / GTC / Vauxhall Astra MKV (04-10) | 1,9 CDTI | FR | 09.2005 | 11.2010 | 5 42 292 , 90544027 , 5 42 453 , 5 42 459 , 9192455 , 93173732 , 93176427 , 5 42 472 | |
| | | OPEL | ASTRA H / GTC / Vauxhall Astra MKV (04-10) | | FR | 09.2004 | 11.2010 | 5 42 292 , 90544027 , 5 42 453 , 5 42 459 , 9192455 , 93173732 , 93176427 , 5 42 472 | |
| | | OPEL | ASTRA H / GTC / Vauxhall Astra MKV (04-10) | 1,8 | FR | 01.2006 | 11.2010 | 5 42 292 , 90544027 , 5 42 453 , 5 42 459 , 9192455 , 93173732 , 93176427 , 5 42 472 | |
| | | OPEL | ASTRA H / GTC / Vauxhall Astra MKV (04-10) | 1,7 CDTI | FR | 04.2007 | 11.2010 | 5 42 292 , 90544027 , 5 42 453 , 5 42 459 , 9192455 , 93173732 , 93176427 , 5 42 472 | |
| | | OPEL | ASTRA H / GTC / Vauxhall Astra MKV (04-10) | 1,6 | FR | 01.2007 | 11.2010 | 5 42 292 , 90544027 , 5 42 453 , 5 42 459 , 9192455 , 93173732 , 93176427 , 5 42 472 | |
| | | OPEL | ASTRA H / GTC / Vauxhall Astra MKV (04-10) | | FR | 01.2004 | 11.2010 | 5 42 292 , 90544027 , 5 42 453 , 5 42 459 , 9192455 , 93173732 , 93176427 , 5 42 472 | |
| | | OPEL | ASTRA H / GTC / Vauxhall Astra MKV (04-10) | 1,4 | FR | 01.2004 | 11.2010 | 5 42 292 , 90544027 , 5 42 453 , 5 42 459 , 9192455 , 93173732 , 93176427 , 5 42 472 | |



| | | | | | | |
|--|--|--|--|--|-------------------------------|---------------------------------------|
| | | | | | OE numbers per ATE pn. | e.g. replaced pn. / miscellaneous |
|--|--|--|--|--|-------------------------------|---------------------------------------|



SAV - Caliper front

| | | | | | | | | | |
|----------------|---------------|------|---|-----------|----|---------|---------|--|--|
| 24.3571-9824.5 | 240500 | OPEL | ASTRA H / GTC / Vauxhall Astra MKV (04-10) | 1,3 CDTI | FR | 08.2005 | 11.2010 | 5 42 292 , 90544027 , 5 42 453 , 5 42 459 , 9192455 , 93173732 , 93176427 , 5 42 472 | |
| | | OPEL | ASTRA H / GTC / Vauxhall Astra MKV (04-10) | 2,0 Turbo | FR | 09.2004 | 11.2010 | 5 42 292 , 90544027 , 5 42 453 , 5 42 459 , 9192455 , 93173732 , 93176427 , 5 42 472 | |
| | | OPEL | ASTRA H / GTC / Vauxhall Astra MKV (04-10) | 1,2 | FR | 08.2005 | 11.2010 | 5 42 292 , 90544027 , 5 42 453 , 5 42 459 , 9192455 , 93173732 , 93176427 , 5 42 472 | |
| | | OPEL | ASTRA H / GTC / Vauxhall Astra MKV (04-10) | 1,8 | FR | 01.2004 | 11.2010 | 5 42 292 , 90544027 , 5 42 453 , 5 42 459 , 9192455 , 93173732 , 93176427 , 5 42 472 | |
| | | OPEL | ASTRA H Caravan/Vau. Astra MKV Estate (04-10) | 1,9 CDTI | FR | 09.2005 | 11.2010 | 5 42 292 , 90544027 , 5 42 453 , 5 42 459 , 9192455 , 93173732 , 93176427 , 5 42 472 | |
| | | OPEL | ASTRA H Caravan/Vau. Astra MKV Estate (04-10) | 1,6 LPG | FR | 08.2009 | 11.2010 | 5 42 292 , 90544027 , 5 42 453 , 5 42 459 , 9192455 , 93173732 , 93176427 , 5 42 472 | |
| | | OPEL | ASTRA H Caravan/Vau. Astra MKV Estate (04-10) | 1,8 | FR | 08.2005 | 11.2010 | 5 42 292 , 90544027 , 5 42 453 , 5 42 459 , 9192455 , 93173732 , 93176427 , 5 42 472 | |
| | | OPEL | ASTRA H Caravan/Vau. Astra MKV Estate (04-10) | 2,0 Turbo | FR | 08.2004 | 11.2010 | 5 42 292 , 90544027 , 5 42 453 , 5 42 459 , 9192455 , 93173732 , 93176427 , 5 42 472 | |



| | | | | | | |
|--|--|--|--|--|-------------------------------|---------------------------------------|
| | | | | | OE numbers per ATE pn. | e.g. replaced pn. / miscellaneous |
|--|--|--|--|--|-------------------------------|---------------------------------------|



SAV - Caliper front

| | | | | | | | | | |
|----------------|---------------|------|---|-----------|----|---------|---------|--|--|
| 24.3571-9824.5 | 240500 | OPEL | ASTRA H Caravan/Vau. Astra MKV Estate (04-10) | 2,0 Turbo | FR | 09.2004 | 11.2010 | 5 42 292 , 90544027 , 5 42 453 , 5 42 459 , 9192455 , 93173732 , 93176427 , 5 42 472 | |
| | | OPEL | ASTRA H Caravan/Vau. Astra MKV Estate (04-10) | 1,9 CDTI | FR | 09.2004 | 11.2010 | 5 42 292 , 90544027 , 5 42 453 , 5 42 459 , 9192455 , 93173732 , 93176427 , 5 42 472 | |
| | | OPEL | ASTRA H Caravan/Vau. Astra MKV Estate (04-10) | | FR | 08.2004 | 11.2010 | 5 42 292 , 90544027 , 5 42 453 , 5 42 459 , 9192455 , 93173732 , 93176427 , 5 42 472 | |
| | | OPEL | ASTRA H Caravan/Vau. Astra MKV Estate (04-10) | 1,8 | FR | 09.2004 | 11.2010 | 5 42 292 , 90544027 , 5 42 453 , 5 42 459 , 9192455 , 93173732 , 93176427 , 5 42 472 | |
| | | OPEL | ASTRA H Caravan/Vau. Astra MKV Estate (04-10) | 1,7 CDTI | FR | 08.2004 | 11.2010 | 5 42 292 , 90544027 , 5 42 453 , 5 42 459 , 9192455 , 93173732 , 93176427 , 5 42 472 | |
| | | OPEL | ASTRA H Caravan/Vau. Astra MKV Estate (04-10) | | FR | 04.2007 | 11.2010 | 5 42 292 , 90544027 , 5 42 453 , 5 42 459 , 9192455 , 93173732 , 93176427 , 5 42 472 | |
| | | OPEL | ASTRA H Caravan/Vau. Astra MKV Estate (04-10) | 1,6 Turbo | FR | 01.2007 | 11.2010 | 5 42 292 , 90544027 , 5 42 453 , 5 42 459 , 9192455 , 93173732 , 93176427 , 5 42 472 | |
| | | OPEL | ASTRA H Caravan/Vau. Astra MKV Estate (04-10) | 1,6 | FR | 08.2004 | 11.2010 | 5 42 292 , 90544027 , 5 42 453 , 5 42 459 , 9192455 , 93173732 , 93176427 , 5 42 472 | |



| | | | | | | |
|--|--|--|--|--|-------------------------------|--|
| | | | | | OE numbers per ATE pn. | e.g. replaced pn. / miscellaneous |
|--|--|--|--|--|-------------------------------|--|



SAV - Caliper front

| | | | | | | | | | |
|----------------|--------|------|---|-----------|----|---------|---------|--|--|
| 24.3571-9824.5 | 240500 | OPEL | ASTRA H Caravan/Vau. Astra MKV Estate (04-10) | 1,3 CDTI | FR | 08.2005 | 11.2010 | 5 42 292 , 90544027 , 5 42 453 , 5 42 459 , 9192455 , 93173732 , 93176427 , 5 42 472 | |
| | | OPEL | ASTRA H Caravan/Vau. Astra MKV Estate (04-10) | 1,4 | FR | 08.2004 | 11.2010 | 5 42 292 , 90544027 , 5 42 453 , 5 42 459 , 9192455 , 93173732 , 93176427 , 5 42 472 | |
| | | OPEL | ASTRA H Caravan/Vau. Astra MKV Estate (04-10) | 1,6 | FR | 01.2007 | 11.2010 | 5 42 292 , 90544027 , 5 42 453 , 5 42 459 , 9192455 , 93173732 , 93176427 , 5 42 472 | |
| | | OPEL | ASTRA TWIN TOP (06-) | 2,0 Turbo | FR | 03.2006 | | 5 42 292 , 90544027 , 5 42 453 , 5 42 459 , 9192455 , 93173732 , 93176427 , 5 42 472 | |
| | | OPEL | ASTRA TWIN TOP (06-) | 1,9 CDTI | FR | 03.2006 | | 5 42 292 , 90544027 , 5 42 453 , 5 42 459 , 9192455 , 93173732 , 93176427 , 5 42 472 | |
| | | OPEL | ASTRA TWIN TOP (06-) | 1,6 Turbo | FR | 02.2007 | | 5 42 292 , 90544027 , 5 42 453 , 5 42 459 , 9192455 , 93173732 , 93176427 , 5 42 472 | |
| | | OPEL | ASTRA TWIN TOP (06-) | 1,6 | FR | 12.2006 | | 5 42 292 , 90544027 , 5 42 453 , 5 42 459 , 9192455 , 93173732 , 93176427 , 5 42 472 | |
| | | OPEL | ASTRA TWIN TOP (06-) | | FR | 03.2006 | | 5 42 292 , 90544027 , 5 42 453 , 5 42 459 , 9192455 , 93173732 , 93176427 , 5 42 472 | |



| | | | | | | |
|--|--|--|--|--|-------------------------------|--|
| | | | | | OE numbers per ATE pn. | e.g. replaced pn. / miscellaneous |
|--|--|--|--|--|-------------------------------|--|



SAV - Caliper front

| | | | | | | | |
|----------------|--------|------|------------------------------|--------------|----|---------|--|
| 24.3571-9824.5 | 240500 | OPEL | ASTRA TWIN TOP (06-) | 1,8 | FR | 03.2006 | 5 42 292 , 90544027 , 5 42 453 , 5 42 459 , 9192455 , 93173732 , 93176427 , 5 42 472 |
| | | OPEL | COMBO / Vauxhall Combo (01-) | 1,4 16V | FR | | 5 42 292 , 90544027 , 5 42 453 , 5 42 459 , 9192455 , 93173732 , 93176427 , 5 42 472 |
| | | OPEL | COMBO / Vauxhall Combo (01-) | 1,7 DTI 16V | FR | | 5 42 292 , 90544027 , 5 42 453 , 5 42 459 , 9192455 , 93173732 , 93176427 , 5 42 472 |
| | | OPEL | COMBO / Vauxhall Combo (01-) | 1,7 DI 16V | FR | | 5 42 292 , 90544027 , 5 42 453 , 5 42 459 , 9192455 , 93173732 , 93176427 , 5 42 472 |
| | | OPEL | COMBO / Vauxhall Combo (01-) | 1,7 CDTI 16V | FR | 06.2004 | 5 42 292 , 90544027 , 5 42 453 , 5 42 459 , 9192455 , 93173732 , 93176427 , 5 42 472 |
| | | OPEL | COMBO / Vauxhall Combo (01-) | 1,6 | FR | | 5 42 292 , 90544027 , 5 42 453 , 5 42 459 , 9192455 , 93173732 , 93176427 , 5 42 472 |
| | | OPEL | COMBO / Vauxhall Combo (01-) | 1,3 CDTI | FR | | 5 42 292 , 90544027 , 5 42 453 , 5 42 459 , 9192455 , 93173732 , 93176427 , 5 42 472 |
| | | OPEL | COMBO / Vauxhall Combo (01-) | 1,6 CNG | FR | 04.2005 | 5 42 292 , 90544027 , 5 42 453 , 5 42 459 , 9192455 , 93173732 , 93176427 , 5 42 472 |



| | | | | | | |
|--|--|--|--|--|-------------------------------|---------------------------------------|
| | | | | | OE numbers per ATE pn. | e.g. replaced pn. / miscellaneous |
|--|--|--|--|--|-------------------------------|---------------------------------------|



SAV - Caliper front

| | | | | | | | | | |
|----------------|--------|------|--|---------------|----|---------|---------|--|--|
| 24.3571-9824.5 | 240500 | OPEL | CORSA C / Vauxhall Corsa MK II (00-06) | 1,7 CDTI | FR | 06.2003 | 09.2006 | 5 42 292 , 90544027 , 5 42 453 , 5 42 459 , 9192455 , 93173732 , 93176427 , 5 42 472 | |
| | | OPEL | CORSA D / Vauxhall Corsa MK III (06-) | 1,6 Turbo GSI | FR | 06.2007 | | 5 42 292 , 90544027 , 5 42 453 , 5 42 459 , 9192455 , 93173732 , 93176427 , 5 42 472 | |
| | | OPEL | MERIVA A / Vauxhall Meriva A (02-10) | 1,6 | FR | 01.2006 | 05.2010 | 5 42 292 , 90544027 , 5 42 453 , 5 42 459 , 9192455 , 93173732 , 93176427 , 5 42 472 | |
| | | OPEL | MERIVA A / Vauxhall Meriva A (02-10) | 1,6 16V | FR | 05.2003 | 05.2010 | 5 42 292 , 90544027 , 5 42 453 , 5 42 459 , 9192455 , 93173732 , 93176427 , 5 42 472 | |
| | | OPEL | MERIVA A / Vauxhall Meriva A (02-10) | 1,3 CDTI | FR | 09.2003 | 05.2010 | 5 42 292 , 90544027 , 5 42 453 , 5 42 459 , 9192455 , 93173732 , 93176427 , 5 42 472 | |
| | | OPEL | MERIVA A / Vauxhall Meriva A (02-10) | 1,7 CDTI | FR | 09.2006 | 05.2010 | 5 42 292 , 90544027 , 5 42 453 , 5 42 459 , 9192455 , 93173732 , 93176427 , 5 42 472 | |
| | | OPEL | MERIVA A / Vauxhall Meriva A (02-10) | 1,7 DTI 16V | FR | 09.2002 | 05.2010 | 5 42 292 , 90544027 , 5 42 453 , 5 42 459 , 9192455 , 93173732 , 93176427 , 5 42 472 | |
| | | OPEL | MERIVA A / Vauxhall Meriva A (02-10) | 1,8 16V | FR | 09.2002 | 05.2010 | 5 42 292 , 90544027 , 5 42 453 , 5 42 459 , 9192455 , 93173732 , 93176427 , 5 42 472 | |



| | | | | | | | |
|--|--|--|--|--|-------------------------------|--|--|
| | | | | | OE numbers per ATE pn. | | e.g. replaced pn. / miscellaneous |
|--|--|--|--|--|-------------------------------|--|--|



SAV - Caliper front

| | | | | | | | | | |
|----------------|---------------|------|--------------------------------------|-------------|----|---------|---------|--|--|
| 24.3571-9824.5 | 240500 | OPEL | MERIVA A / Vauxhall Meriva A (02-10) | 1,7 CDTI | FR | 09.2003 | 05.2010 | 5 42 292 , 90544027 , 5 42 453 , 5 42 459 , 9192455 , 93173732 , 93176427 , 5 42 472 | |
| | | OPEL | MERIVA B (10-) | | FR | 06.2010 | | 5 42 292 , 90544027 , 5 42 453 , 5 42 459 , 9192455 , 93173732 , 93176427 , 5 42 472 | |
| | | OPEL | MERIVA B (10-) | 1,4 EcoFlex | FR | 06.2010 | | 5 42 292 , 90544027 , 5 42 453 , 5 42 459 , 9192455 , 93173732 , 93176427 , 5 42 472 | |
| | | OPEL | MERIVA B (10-) | 1,4 | FR | 06.2010 | | 5 42 292 , 90544027 , 5 42 453 , 5 42 459 , 9192455 , 93173732 , 93176427 , 5 42 472 | |
| | | OPEL | MERIVA B (10-) | 1,3 CDTI | FR | 06.2010 | | 5 42 292 , 90544027 , 5 42 453 , 5 42 459 , 9192455 , 93173732 , 93176427 , 5 42 472 | |
| | | OPEL | ZAFIRA I / Vauxhall Zafira I (99-05) | 2,2 DTI 16V | FR | 01.2002 | 06.2005 | 5 42 292 , 90544027 , 5 42 453 , 5 42 459 , 9192455 , 93173732 , 93176427 , 5 42 472 | |
| | | OPEL | ZAFIRA I / Vauxhall Zafira I (99-05) | 2,0 DI 16V | FR | 10.1999 | 06.2005 | 5 42 292 , 90544027 , 5 42 453 , 5 42 459 , 9192455 , 93173732 , 93176427 , 5 42 472 | |
| | | OPEL | ZAFIRA I / Vauxhall Zafira I (99-05) | 2,0 16V OPC | FR | 09.2001 | 06.2005 | 5 42 292 , 90544027 , 5 42 453 , 5 42 459 , 9192455 , 93173732 , 93176427 , 5 42 472 | |



| | | | | | | |
|--|--|--|--|--|-------------------------------|--|
| | | | | | OE numbers per ATE pn. | |
|--|--|--|--|--|-------------------------------|--|



SAV - Caliper front

| | | | | | | | | | |
|----------------|---------------|------|--|---------------|----|---------|---------|--|--|
| 24.3571-9824.5 | 240500 | OPEL | ZAFIRA I / Vauxhall Zafira I (99-05) | 1,8 16V | FR | 04.1999 | 06.2005 | 5 42 292 , 90544027 , 5 42 453 , 5 42 459 , 9192455 , 93173732 , 93176427 , 5 42 472 | |
| | | OPEL | ZAFIRA I / Vauxhall Zafira I (99-05) | 2,0 DTI 16V | FR | 06.2000 | 06.2005 | 5 42 292 , 90544027 , 5 42 453 , 5 42 459 , 9192455 , 93173732 , 93176427 , 5 42 472 | |
| | | OPEL | ZAFIRA I / Vauxhall Zafira I (99-05) | 1,6 16V | FR | 04.1999 | 06.2005 | 5 42 292 , 90544027 , 5 42 453 , 5 42 459 , 9192455 , 93173732 , 93176427 , 5 42 472 | |
| | | OPEL | ZAFIRA I / Vauxhall Zafira I (99-05) | 2,2 16V | FR | 09.2000 | 06.2005 | 5 42 292 , 90544027 , 5 42 453 , 5 42 459 , 9192455 , 93173732 , 93176427 , 5 42 472 | |
| | | OPEL | ZAFIRA II / Vauxhall Zafira II (05-11) | 1,6 | FR | 12.2007 | | 5 42 292 , 90544027 , 5 42 453 , 5 42 459 , 9192455 , 93173732 , 93176427 , 5 42 472 | |
| | | OPEL | ZAFIRA II / Vauxhall Zafira II (05-11) | 1,7 CDTI | FR | 12.2007 | | 5 42 292 , 90544027 , 5 42 453 , 5 42 459 , 9192455 , 93173732 , 93176427 , 5 42 472 | |
| | | OPEL | ZAFIRA II / Vauxhall Zafira II (05-11) | 1,6 CNG | FR | 01.2006 | | 5 42 292 , 90544027 , 5 42 453 , 5 42 459 , 9192455 , 93173732 , 93176427 , 5 42 472 | |
| | | OPEL | ZAFIRA II / Vauxhall Zafira II (05-11) | 1,6 CNG Turbo | FR | 02.2009 | | 5 42 292 , 90544027 , 5 42 453 , 5 42 459 , 9192455 , 93173732 , 93176427 , 5 42 472 | |



| | | | | | | | |
|--|--|--|--|--|-------------------------------|--|--|
| | | | | | OE numbers per ATE pn. | | e.g. replaced pn. / miscellaneous |
|--|--|--|--|--|-------------------------------|--|--|



SAV - Caliper front

| | | | | | | | | |
|----------------|---------------|---------|--|-------------|----|---------|--|--|
| 24.3571-9824.5 | 240500 | OPEL | ZAFIRA II / Vauxhall Zafira II (05-11) | 2,2 | FR | 07.2005 | 5 42 292 , 90544027 , 5 42 453 , 5 42 459 , 9192455 , 93173732 , 93176427 , 5 42 472 | |
| | | OPEL | ZAFIRA II / Vauxhall Zafira II (05-11) | 2,0 Turbo | FR | 07.2005 | 5 42 292 , 90544027 , 5 42 453 , 5 42 459 , 9192455 , 93173732 , 93176427 , 5 42 472 | |
| | | OPEL | ZAFIRA II / Vauxhall Zafira II (05-11) | 1,9 CDTI | FR | 07.2005 | 5 42 292 , 90544027 , 5 42 453 , 5 42 459 , 9192455 , 93173732 , 93176427 , 5 42 472 | |
| | | OPEL | ZAFIRA II / Vauxhall Zafira II (05-11) | 1,8 | FR | 07.2005 | 5 42 292 , 90544027 , 5 42 453 , 5 42 459 , 9192455 , 93173732 , 93176427 , 5 42 472 | |
| | | OPEL | ZAFIRA II / Vauxhall Zafira II (05-11) | 1,6 | FR | 07.2005 | 5 42 292 , 90544027 , 5 42 453 , 5 42 459 , 9192455 , 93173732 , 93176427 , 5 42 472 | |
| 24.0101-3802.2 | 260100 | PEUGEOT | 407 Coupe (05-) | 2,0 HDi | | 07.2007 | 4439 36 , 77363365 , 169 421 01 86 , 4439 34 , 4439 44 | |
| | | PEUGEOT | 407 Coupe (05-) | | | 06.2009 | 4439 36 , 77363365 , 169 421 01 86 , 4439 34 , 4439 44 | |
| | | PEUGEOT | 407 Saloon (04-) | 1,8 16V | | 09.2005 | 4439 36 , 77363365 , 169 421 01 86 , 4439 34 , 4439 44 | |
| | | PEUGEOT | 407 Saloon (04-) | 2,0 HDi 140 | | 08.2008 | 4439 36 , 77363365 , 169 421 01 86 , 4439 34 , 4439 44 | |



| | | | | | | | |
|--|--|--|--|--|-------------------------------|--|--|
| | | | | | OE numbers per ATE pn. | | e.g. replaced pn. / miscellaneous |
|--|--|--|--|--|-------------------------------|--|--|



SAV - Caliper front

| | | | | | | | |
|----------------|---------------|---------|------------------|-------------|---------|---|--|
| 24.0101-3802.2 | 260100 | PEUGEOT | 407 Saloon (04-) | 2,0 HDi 135 | 05.2004 | 4439 36 , 77363365 , 169 421 01 86 , 4439 34 , 4439 44 | |
| | | PEUGEOT | 407 Saloon (04-) | 1,6 HDi 110 | 05.2004 | 4439 36 , 77363365 , 169 421 01 86 , 4439 34 , 4439 44 | |
| | | PEUGEOT | 407 Saloon (04-) | 2,0 16V | 05.2004 | 4439 36 , 77363365 , 169 421 01 86 , 4439 34 , 4439 44 | |
| | | PEUGEOT | 407 Saloon (04-) | 1,8 16V | 05.2004 | 4439 36 , 77363365 , 169 421 01 86 , 4439 34 , 4439 44 | |
| | | PEUGEOT | 407 Saloon (04-) | 2,0 16V | 09.2005 | 4439 36 , 77363365 , 169 421 01 86 , 4439 34 , 4439 44 | |
| | | PEUGEOT | 407 SW (04-) | 2,0 HDi 140 | 08.2008 | 4439 36 , 77363365 , 169 421 01 86 , 4439 34 , 4439 44 | |
| | | PEUGEOT | 407 SW (04-) | 2,0 BioFlex | 01.2008 | 4439 36 , 77363365 , 169 421 01 86 , 4439 34 , 4439 44 | |
| | | PEUGEOT | 407 SW (04-) | 2,0 16V | 09.2005 | 4439 36 , 77363365 , 169 421 01 86 , 4439 34 , 4439 44 | |
| | | PEUGEOT | 407 SW (04-) | | 05.2004 | 4439 36 , 77363365 , 169 421 01 86 , 4439 34 , 4439 44 | |
| | | PEUGEOT | 407 SW (04-) | 1,8 16V | 09.2005 | 4439 36 , 77363365 , 169 421 01 86 , 4439 34 , 4439 44 | |
| | | PEUGEOT | 407 SW (04-) | | 05.2004 | 4439 36 , 77363365 , 169 421 01 86 , 4439 34 , 4439 44 | |
| | | PEUGEOT | 407 SW (04-) | 1,6 HDi 110 | 05.2004 | 4439 36 , 77363365 , 169 421 01 86 , 4439 34 , 4439 44 | |



| | | | | | | | |
|--|--|--|--|--|-------------------------------|--|--|
| | | | | | OE numbers per ATE pn. | | e.g. replaced pn. / miscellaneous |
|--|--|--|--|--|-------------------------------|--|--|



SAV - Caliper front

| | | | | | | | | |
|----------------|---------------|---------------|-----------------------|---------------|---------|---------|---|--|
| 24.0101-3802.2 | 260100 | PEUGEOT | 407 SW (04-) | 2,0 HDi | 05.2004 | 07.2008 | 4439 36 , 77363365 , 169 421 01 86 , 4439 34 , 4439 44 | |
| | | PEUGEOT | 407 SW (04-) | 2,0 HDi 135 | 05.2004 | | 4439 36 , 77363365 , 169 421 01 86 , 4439 34 , 4439 44 | |
| | | MERCEDES BENZ | A-Class (W169) (04-) | A 170 | 08.2004 | | 4439 36 , 77363365 , 169 421 01 86 , 4439 34 , 4439 44 | |
| | | MERCEDES BENZ | A-Class (W169) (04-) | A 200 Turbo | 03.2005 | | 4439 36 , 77363365 , 169 421 01 86 , 4439 34 , 4439 44 | |
| | | MERCEDES BENZ | A-Class (W169) (04-) | A 200 CDI | 08.2004 | | 4439 36 , 77363365 , 169 421 01 86 , 4439 34 , 4439 44 | |
| | | MERCEDES BENZ | A-Class (W169) (04-) | A 180 | 04.2009 | | 4439 36 , 77363365 , 169 421 01 86 , 4439 34 , 4439 44 | |
| | | MERCEDES BENZ | A-Class (W169) (04-) | A 200 | 08.2004 | | 4439 36 , 77363365 , 169 421 01 86 , 4439 34 , 4439 44 | |
| | | MERCEDES BENZ | A-Class (W169) (04-) | A 160 CDI | 08.2004 | | 4439 36 , 77363365 , 169 421 01 86 , 4439 34 , 4439 44 | |
| | | MERCEDES BENZ | A-Class (W169) (04-) | A 150 / A 160 | | | 4439 36 , 77363365 , 169 421 01 86 , 4439 34 , 4439 44 | |
| | | MERCEDES BENZ | A-Class (W169) (04-) | A 160 CDI | | | 4439 36 , 77363365 , 169 421 01 86 , 4439 34 , 4439 44 | |
| | | MERCEDES BENZ | A-Class (W169) (04-) | A 150 / A 160 | 08.2004 | | 4439 36 , 77363365 , 169 421 01 86 , 4439 34 , 4439 44 | |
| | | MERCEDES BENZ | A-Class (W169) (04-) | A 180 CDI | 08.2004 | | 4439 36 , 77363365 , 169 421 01 86 , 4439 34 , 4439 44 | |



| | | | | | | | |
|--|--|--|--|--|-------------------------------|--|--|
| | | | | | OE numbers per ATE pn. | | e.g. replaced pn. / miscellaneous |
|--|--|--|--|--|-------------------------------|--|--|



SAV - Caliper front

| | | | | | | | | | |
|----------------|---------------|---------------|----------------------|---------------|--|---------|---------|---|--|
| 24.0101-3802.2 | 260100 | MERCEDES BENZ | B-Class (W245) (05-) | B 200 CDI | | 04.2005 | | 4439 36 , 77363365 , 169 421 01 86 , 4439 34 , 4439 44 | |
| | | MERCEDES BENZ | B-Class (W245) (05-) | B 170 / B 180 | | 04.2005 | | 4439 36 , 77363365 , 169 421 01 86 , 4439 34 , 4439 44 | |
| | | MERCEDES BENZ | B-Class (W245) (05-) | B 200 | | 04.2005 | | 4439 36 , 77363365 , 169 421 01 86 , 4439 34 , 4439 44 | |
| | | MERCEDES BENZ | B-Class (W245) (05-) | B 180 NGT | | 04.2009 | | 4439 36 , 77363365 , 169 421 01 86 , 4439 34 , 4439 44 | |
| | | MERCEDES BENZ | B-Class (W245) (05-) | B 180 CDI | | 04.2005 | | 4439 36 , 77363365 , 169 421 01 86 , 4439 34 , 4439 44 | |
| | | MERCEDES BENZ | B-Class (W245) (05-) | B 200 Turbo | | 04.2005 | | 4439 36 , 77363365 , 169 421 01 86 , 4439 34 , 4439 44 | |
| | | MERCEDES BENZ | B-Class (W245) (05-) | B 150 / B 160 | | 04.2005 | | 4439 36 , 77363365 , 169 421 01 86 , 4439 34 , 4439 44 | |
| | | MERCEDES BENZ | B-Class (W245) (05-) | B 170 NGT | | 04.2008 | 04.2009 | 4439 36 , 77363365 , 169 421 01 86 , 4439 34 , 4439 44 | |
| | | SUZUKI | SPLASH (08-) | 1,0 i 12V | | 01.2008 | | 4439 36 , 77363365 , 169 421 01 86 , 4439 34 , 4439 44 | |
| | | SUZUKI | SPLASH (08-) | 1,3 CDTi | | 01.2008 | | 4439 36 , 77363365 , 169 421 01 86 , 4439 34 , 4439 44 | |
| | | SUZUKI | SPLASH (08-) | 1,2 i 16V | | 01.2008 | | 4439 36 , 77363365 , 169 421 01 86 , 4439 34 , 4439 44 | |
| | | SUZUKI | SWIFT III (05-) | 1,3 i 16V 4x4 | | 01.2006 | | 4439 36 , 77363365 , 169 421 01 86 , 4439 34 , 4439 44 | |



| | | | | | | | |
|--|--|--|--|--|-------------------------------|--|--|
| | | | | | OE numbers per ATE pn. | | e.g. replaced pn. / miscellaneous |
|--|--|--|--|--|-------------------------------|--|--|



SAV - Caliper front

| | | | | | | | | |
|----------------|---------------|---------------|------------------------------------|----------------------|---------|---------|---|--|
| 24.0101-3802.2 | 260100 | SUZUKI | SWIFT III (05-) | 1,3 DDiS | 08.2005 | 09.2007 | 4439 36 , 77363365 , 169 421 01 86 , 4439 34 , 4439 44 | |
| | | SUZUKI | SWIFT III (05-) | 1,3 i 16V | 02.2005 | | 4439 36 , 77363365 , 169 421 01 86 , 4439 34 , 4439 44 | |
| | | SUZUKI | SWIFT III (05-) | 1,6 VVTi | 05.2006 | | 4439 36 , 77363365 , 169 421 01 86 , 4439 34 , 4439 44 | |
| | | SUZUKI | SWIFT III (05-) | 1,5 VVTi | 02.2005 | | 4439 36 , 77363365 , 169 421 01 86 , 4439 34 , 4439 44 | |
| | | LANCIA | YPSILON (03-) | 1,4 i | 08.2006 | | 4439 36 , 77363365 , 169 421 01 86 , 4439 34 , 4439 44 | |
| | | LANCIA | YPSILON (03-) | 1,2 i | 08.2006 | | 4439 36 , 77363365 , 169 421 01 86 , 4439 34 , 4439 44 | |
| 24.0101-3803.2 | 260101 | MERCEDES BENZ | C-Class (CL203) Sportcoupe (01-08) | C 180 | 03.2001 | 05.2008 | 4439 36 , 001 421 04 86 , 34 21 6 772 867 , 93179160 , 54 23 93 | |
| | | MERCEDES BENZ | C-Class (CL203) Sportcoupe (01-08) | C 220 CDI | 03.2001 | 05.2008 | 4439 36 , 001 421 04 86 , 34 21 6 772 867 , 93179160 , 54 23 93 | |
| | | MERCEDES BENZ | C-Class (CL203) Sportcoupe (01-08) | C 200 Kompressor | 03.2001 | 05.2008 | 4439 36 , 001 421 04 86 , 34 21 6 772 867 , 93179160 , 54 23 93 | |
| | | MERCEDES BENZ | C-Class (CL203) Sportcoupe (01-08) | C 200 CGI Kompressor | 07.2003 | 05.2008 | 4439 36 , 001 421 04 86 , 34 21 6 772 867 , 93179160 , 54 23 93 | |
| | | MERCEDES BENZ | C-Class (CL203) Sportcoupe (01-08) | C 180 Kompressor | 05.2002 | 05.2008 | 4439 36 , 001 421 04 86 , 34 21 6 772 867 , 93179160 , 54 23 93 | |



| | | | | | | | |
|--|--|--|--|--|-------------------------------|--|--|
| | | | | | OE numbers per ATE pn. | | e.g. replaced pn. / miscellaneous |
|--|--|--|--|--|-------------------------------|--|--|



SAV - Caliper front

| | | | | | | | | |
|----------------|---------------|---------------|------------------------------------|--------------------|---------|---------|---|--|
| 24.0101-3803.2 | 260101 | MERCEDES BENZ | C-Class (CL203) Sportcoupe (01-08) | C 230 Kompressor | 03.2001 | 05.2008 | 4439 36 , 001 421 04 86 , 34 21 6 772 867 , 93179160 , 54 23 93 | |
| | | MERCEDES BENZ | C-Class (CL203) Sportcoupe (01-08) | C 160 Kompressor | 04.2005 | 05.2008 | 4439 36 , 001 421 04 86 , 34 21 6 772 867 , 93179160 , 54 23 93 | |
| | | MERCEDES BENZ | C-Class (CL203) Sportcoupe (01-08) | C 200 CDI | 07.2003 | 05.2008 | 4439 36 , 001 421 04 86 , 34 21 6 772 867 , 93179160 , 54 23 93 | |
| | | MERCEDES BENZ | C-Class (CLC204) Coupe (08-) | CLC 220 CDI | 05.2008 | | 4439 36 , 001 421 04 86 , 34 21 6 772 867 , 93179160 , 54 23 93 | |
| | | MERCEDES BENZ | C-Class (CLC204) Coupe (08-) | CLC 200 Kompressor | 05.2008 | | 4439 36 , 001 421 04 86 , 34 21 6 772 867 , 93179160 , 54 23 93 | |
| | | MERCEDES BENZ | C-Class (CLC204) Coupe (08-) | CLC 180 Kompressor | 05.2008 | | 4439 36 , 001 421 04 86 , 34 21 6 772 867 , 93179160 , 54 23 93 | |
| | | MERCEDES BENZ | C-Class (CLC204) Coupe (08-) | CLC 200 CDI | 05.2008 | | 4439 36 , 001 421 04 86 , 34 21 6 772 867 , 93179160 , 54 23 93 | |
| | | MERCEDES BENZ | C-Class (S203) Estate (01-07) | C 180 | 03.2001 | 09.2007 | 4439 36 , 001 421 04 86 , 34 21 6 772 867 , 93179160 , 54 23 93 | |
| | | MERCEDES BENZ | C-Class (S203) Estate (01-07) | C 180 Kompressor | 05.2002 | 09.2007 | 4439 36 , 001 421 04 86 , 34 21 6 772 867 , 93179160 , 54 23 93 | |



| | | | | | | |
|--|--|--|--|--|-------------------------------|---------------------------------------|
| | | | | | OE numbers per ATE pn. | e.g. replaced pn. / miscellaneous |
|--|--|--|--|--|-------------------------------|---------------------------------------|



SAV - Caliper front

| | | | | | | | | |
|----------------|---------------|---------------|-------------------------------|----------------------|---------|---------|---|--|
| 24.0101-3803.2 | 260101 | MERCEDES BENZ | C-Class (S203) Estate (01-07) | C 200 CDI | 03.2001 | 09.2007 | 4439 36 , 001 421 04 86 , 34 21 6 772 867 , 93179160 , 54 23 93 | |
| | | MERCEDES BENZ | C-Class (S203) Estate (01-07) | C 200 CGI Kompressor | 07.2003 | 09.2007 | 4439 36 , 001 421 04 86 , 34 21 6 772 867 , 93179160 , 54 23 93 | |
| | | MERCEDES BENZ | C-Class (S203) Estate (01-07) | C 200 Kompressor | 03.2001 | 09.2007 | 4439 36 , 001 421 04 86 , 34 21 6 772 867 , 93179160 , 54 23 93 | |
| | | MERCEDES BENZ | C-Class (S203) Estate (01-07) | C 220 CDI | 03.2001 | 09.2007 | 4439 36 , 001 421 04 86 , 34 21 6 772 867 , 93179160 , 54 23 93 | |
| | | MERCEDES BENZ | C-Class (S203) Estate (01-07) | C 320 CDI | 02.2005 | 09.2007 | 4439 36 , 001 421 04 86 , 34 21 6 772 867 , 93179160 , 54 23 93 | |
| | | MERCEDES BENZ | C-Class (W203) Saloon (00-07) | C 220 CDI | 04.2000 | 04.2007 | 4439 36 , 001 421 04 86 , 34 21 6 772 867 , 93179160 , 54 23 93 | |
| | | MERCEDES BENZ | C-Class (W203) Saloon (00-07) | C 200 CGI Kompressor | 07.2003 | 04.2007 | 4439 36 , 001 421 04 86 , 34 21 6 772 867 , 93179160 , 54 23 93 | |
| | | MERCEDES BENZ | C-Class (W203) Saloon (00-07) | C 180 Kompressor | 05.2002 | 04.2007 | 4439 36 , 001 421 04 86 , 34 21 6 772 867 , 93179160 , 54 23 93 | |
| | | MERCEDES BENZ | C-Class (W203) Saloon (00-07) | C 200 CDI | 04.2000 | 04.2007 | 4439 36 , 001 421 04 86 , 34 21 6 772 867 , 93179160 , 54 23 93 | |



| | | | | | | | |
|--|--|--|--|--|-------------------------------|--|--|
| | | | | | OE numbers per ATE pn. | | e.g. replaced pn. / miscellaneous |
|--|--|--|--|--|-------------------------------|--|--|



SAV - Caliper front

| | | | | | | | | |
|----------------|---------------|---------------|--------------------------------------|--------------------|---------|---------|---|--|
| 24.0101-3803.2 | 260101 | MERCEDES BENZ | C-Class (W203) Saloon (00-07) | C 200 Kompressor | 04.2000 | 04.2007 | 4439 36 , 001 421 04 86 , 34 21 6 772 867 , 93179160 , 54 23 93 | |
| | | MERCEDES BENZ | C-Class (W203) Saloon (00-07) | C 230 Kompressor | 02.2004 | 04.2007 | 4439 36 , 001 421 04 86 , 34 21 6 772 867 , 93179160 , 54 23 93 | |
| | | MERCEDES BENZ | C-Class (W203) Saloon (00-07) | C 320 CDI | 02.2005 | 04.2007 | 4439 36 , 001 421 04 86 , 34 21 6 772 867 , 93179160 , 54 23 93 | |
| | | MERCEDES BENZ | C-Class (W203) Saloon (00-07) | C 180 | 04.2000 | 04.2007 | 4439 36 , 001 421 04 86 , 34 21 6 772 867 , 93179160 , 54 23 93 | |
| | | MERCEDES BENZ | CLK-Class (A209) Convertible (03-09) | CLK 200 CGI | 05.2003 | 12.2009 | 4439 36 , 001 421 04 86 , 34 21 6 772 867 , 93179160 , 54 23 93 | |
| | | MERCEDES BENZ | CLK-Class (C209) Coupe (02-09) | CLK 220 CDI | 05.2005 | 04.2009 | 4439 36 , 001 421 04 86 , 34 21 6 772 867 , 93179160 , 54 23 93 | |
| | | MERCEDES BENZ | CLK-Class (C209) Coupe (02-09) | CLK 200 CGI | 09.2002 | 04.2009 | 4439 36 , 001 421 04 86 , 34 21 6 772 867 , 93179160 , 54 23 93 | |
| | | MERCEDES BENZ | CLK-Class (C209) Coupe (02-09) | CLK 200 Kompressor | 09.2002 | 04.2009 | 4439 36 , 001 421 04 86 , 34 21 6 772 867 , 93179160 , 54 23 93 | |
| | | MERCEDES BENZ | SLK-Class (R171) (04-) | SLK 200 Kompressor | 03.2004 | | 4439 36 , 001 421 04 86 , 34 21 6 772 867 , 93179160 , 54 23 93 | |



| | | | | | | | |
|--|--|--|--|--|-------------------------------|--|--|
| | | | | | OE numbers per ATE pn. | | e.g. replaced pn. / miscellaneous |
|--|--|--|--|--|-------------------------------|--|--|



SAV - Caliper front

| | | | | | | | | | |
|----------------|---------------|---------------|-----------------------|---------|--|---------|---------|---|--|
| 24.0101-3803.2 | 260101 | MERCEDES BENZ | VANEO (BM414) (02-05) | 1,9 | | 02.2002 | 12.2005 | 4439 36 , 001 421 04 86 , 34 21 6 772 867 , 93179160 , 54 23 93 | |
| | | MERCEDES BENZ | VANEO (BM414) (02-05) | 1,6 | | 02.2002 | 12.2005 | 4439 36 , 001 421 04 86 , 34 21 6 772 867 , 93179160 , 54 23 93 | |
| | | MERCEDES BENZ | VANEO (BM414) (02-05) | 1,4 | | 06.2002 | 12.2005 | 4439 36 , 001 421 04 86 , 34 21 6 772 867 , 93179160 , 54 23 93 | |
| | | MERCEDES BENZ | VANEO (BM414) (02-05) | 1,7 CDI | | 02.2002 | 12.2005 | 4439 36 , 001 421 04 86 , 34 21 6 772 867 , 93179160 , 54 23 93 | |



SBH - Brake pads rear

| | | | | | | | | | |
|----------------|---------------|------------|----------------|---------|--|---------|--|---|--|
| 24.0101-3803.2 | 260101 | VOLKSWAGEN | SCIROCCO (08-) | 2,0 TSI | | 08.2008 | | 4439 36 , 001 421 04 86 , 34 21 6 772 867 , 93179160 , 54 23 93 | |
| | | VOLKSWAGEN | SCIROCCO (08-) | 1,4 TSI | | 09.2008 | | 4439 36 , 001 421 04 86 , 34 21 6 772 867 , 93179160 , 54 23 93 | |
| | | VOLKSWAGEN | SCIROCCO (08-) | | | 08.2008 | | 4439 36 , 001 421 04 86 , 34 21 6 772 867 , 93179160 , 54 23 93 | |
| | | VOLKSWAGEN | SCIROCCO (08-) | 2,0 R | | 11.2009 | | 4439 36 , 001 421 04 86 , 34 21 6 772 867 , 93179160 , 54 23 93 | |



| | | | | | | | |
|--|--|--|--|--|-------------------------------|--|--|
| | | | | | OE numbers per ATE pn. | | e.g. replaced pn. / miscellaneous |
|--|--|--|--|--|-------------------------------|--|--|



SBH - Brake pads rear

| | | | | | | | |
|----------------|---------------|------------|----------------|------------|---------|---|--|
| 24.0101-3803.2 | 260101 | VOLKSWAGEN | SCIROCCO (08-) | 2,0 TDI | 05.2009 | 4439 36 , 001 421 04 86 , 34 21 6 772 867 , 93179160 , 54 23 93 | |
| | | VOLKSWAGEN | SCIROCCO (08-) | | 10.2008 | 4439 36 , 001 421 04 86 , 34 21 6 772 867 , 93179160 , 54 23 93 | |
| 24.8190-0310.2 | 620310 | BMW | X3 (10-) | xDrive 35i | 09.2010 | 34 35 6 790 304 | |
| | | BMW | X3 (10-) | xDrive 28i | 09.2010 | 34 35 6 790 304 | |
| | | BMW | X3 (10-) | xDrive 20d | 09.2010 | 34 35 6 790 304 | |



SBV - Brake pads front

| | | | | | | | |
|----------------|---------------|-------|--|----------------------|---------|---------------------|-------------|
| 13.0460-5607.2 | 605607 | LEXUS | LS 460 (06-) | 4,6 VVTi (USF40/41) | 04.2006 | 04465-0W110 | see drawing |
| | | LEXUS | LS 460 (06-) | 4,6 VVTi AWD (USF45) | 12.2008 | 04465-0W110 | see drawing |
| | | LEXUS | LS 460 (06-) | 4,6 VVTi (USF40/41) | 05.2008 | 04465-0W110 | see drawing |
| | | LEXUS | LS 600 (07-) | 5,0 VVTi Hybrid | 04.2007 | 04465-0W110 | see drawing |
| 13.0460-7262.2 | 607262 | OPEL | ASTRA J / GTC / Vauxhall Astra MK VI (09-) | 1,6 Turbo ECOTEC | 12.2009 | 13301207 , 5 42 120 | see drawing |
| | | OPEL | ASTRA J / GTC / Vauxhall Astra MK VI (09-) | 1,6 ECOTEC | 12.2009 | 13301207 , 5 42 120 | see drawing |
| | | OPEL | ASTRA J / GTC / Vauxhall Astra MK VI (09-) | 1,4 Turbo ECOTEC | 12.2009 | 13301207 , 5 42 120 | see drawing |
| | | OPEL | ASTRA J / GTC / Vauxhall Astra MK VI (09-) | 1,4 ecoFlex | 12.2009 | 13301207 , 5 42 120 | see drawing |



| | | | | | | | |
|--|--|--|--|--|-------------------------------|--|--|
| | | | | | OE numbers per ATE pn. | | e.g. replaced pn. / miscellaneous |
|--|--|--|--|--|-------------------------------|--|--|



SBV - Brake pads front

| | | | | | | | |
|----------------|---------------|-----------|---|------------------|---------|---------------------|-------------|
| 13.0460-7262.2 | 607262 | OPEL | ASTRA J / GTC / Vauxhall Astra MK VI (09-) | 1,3 CDTI ECOTEC | 12.2009 | 13301207 , 5 42 120 | see drawing |
| | | OPEL | ASTRA J / GTC / Vauxhall Astra MK VI (09-) | 1,7 CDTI ECOTEC | 12.2009 | 13301207 , 5 42 120 | see drawing |
| | | OPEL | ASTRA J / GTC / Vauxhall Astra MK VI (09-) | 2,0 CDTI ECOTEC | 12.2009 | 13301207 , 5 42 120 | see drawing |
| | | OPEL | ASTRA J Sports Tourer/Vau.Astra Sports Tourer (10 | 1,6 Turbo ECOTEC | 11.2010 | 13301207 , 5 42 120 | see drawing |
| | | OPEL | ASTRA J Sports Tourer/Vau.Astra Sports Tourer (10 | 1,6 ECOTEC | 11.2010 | 13301207 , 5 42 120 | see drawing |
| | | OPEL | ASTRA J Sports Tourer/Vau.Astra Sports Tourer (10 | 2,0 CDTI ECOTEC | 11.2010 | 13301207 , 5 42 120 | see drawing |
| | | OPEL | ASTRA J Sports Tourer/Vau.Astra Sports Tourer (10 | 1,4 ecoFlex | 11.2010 | 13301207 , 5 42 120 | see drawing |
| | | OPEL | ASTRA J Sports Tourer/Vau.Astra Sports Tourer (10 | 1,7 CDTI ECOTEC | 11.2010 | 13301207 , 5 42 120 | see drawing |
| | | OPEL | ASTRA J Sports Tourer/Vau.Astra Sports Tourer (10 | 1,3 CDTI ECOTEC | 11.2010 | 13301207 , 5 42 120 | see drawing |
| | | OPEL | ASTRA J Sports Tourer/Vau.Astra Sports Tourer (10 | 1,4 Turbo ECOTEC | 11.2010 | 13301207 , 5 42 120 | see drawing |
| | | CHEVROLET | CRUZE (09-) | 2,0 CDI | 05.2009 | 13301207 , 5 42 120 | see drawing |
| | | CHEVROLET | CRUZE (09-) | 1,8 i 16V | 05.2009 | 13301207 , 5 42 120 | see drawing |
| | | CHEVROLET | CRUZE (09-) | 1,6 i 16V | 05.2009 | 13301207 , 5 42 120 | see drawing |
| 13.0460-7263.2 | 607263 | OPEL | ASTRA J / GTC / Vauxhall Astra MK VI (09-) | 1,7 CDTI ECOTEC | 12.2009 | 13301234 , 5 42 115 | see drawing |
| | | OPEL | ASTRA J / GTC / Vauxhall Astra MK VI (09-) | 1,3 CDTI ECOTEC | 12.2009 | 13301234 , 5 42 115 | see drawing |
| | | OPEL | ASTRA J / GTC / Vauxhall Astra MK VI (09-) | 1,4 ecoFlex | 12.2009 | 13301234 , 5 42 115 | see drawing |
| | | OPEL | ASTRA J / GTC / Vauxhall Astra MK VI (09-) | 1,4 Turbo ECOTEC | 12.2009 | 13301234 , 5 42 115 | see drawing |
| | | OPEL | ASTRA J / GTC / Vauxhall Astra MK VI (09-) | 2,0 CDTI ECOTEC | 12.2009 | 13301234 , 5 42 115 | see drawing |



| | | | | | | | |
|--|--|--|--|--|-------------------------------|--|--|
| | | | | | OE numbers per ATE pn. | | e.g. replaced pn. / miscellaneous |
|--|--|--|--|--|-------------------------------|--|--|



SBV - Brake pads front

| | | | | | | | | | |
|----------------|---------------|-----------|---|------------------|----|---------|--|---------------------|-------------|
| 13.0460-7263.2 | 607263 | OPEL | ASTRA J / GTC / Vauxhall Astra MK VI (09-) | 1,6 Turbo ECOTEC | | 12.2009 | | 13301234 , 5 42 115 | see drawing |
| | | OPEL | ASTRA J / GTC / Vauxhall Astra MK VI (09-) | 1,6 ECOTEC | | 12.2009 | | 13301234 , 5 42 115 | see drawing |
| | | OPEL | ASTRA J Sports Tourer/Vau.Astra Sports Tourer (10 | 1,4 ecoFlex | | 11.2010 | | 13301234 , 5 42 115 | see drawing |
| | | OPEL | ASTRA J Sports Tourer/Vau.Astra Sports Tourer (10 | 2,0 CDTi ECOTEC | | 11.2010 | | 13301234 , 5 42 115 | see drawing |
| | | OPEL | ASTRA J Sports Tourer/Vau.Astra Sports Tourer (10 | 1,7 CDTi ECOTEC | | 11.2010 | | 13301234 , 5 42 115 | see drawing |
| | | OPEL | ASTRA J Sports Tourer/Vau.Astra Sports Tourer (10 | 1,6 Turbo ECOTEC | | 11.2010 | | 13301234 , 5 42 115 | see drawing |
| | | OPEL | ASTRA J Sports Tourer/Vau.Astra Sports Tourer (10 | 1,4 Turbo ECOTEC | | 11.2010 | | 13301234 , 5 42 115 | see drawing |
| | | OPEL | ASTRA J Sports Tourer/Vau.Astra Sports Tourer (10 | 1,3 CDTi ECOTEC | | 11.2010 | | 13301234 , 5 42 115 | see drawing |
| | | OPEL | ASTRA J Sports Tourer/Vau.Astra Sports Tourer (10 | 1,6 ECOTEC | | 11.2010 | | 13301234 , 5 42 115 | see drawing |
| | | CHEVROLET | CRUZE (09-) | 1,8 i 16V | | 05.2009 | | 13301234 , 5 42 115 | see drawing |
| | | CHEVROLET | CRUZE (09-) | 2,0 CDI | | 05.2009 | | 13301234 , 5 42 115 | see drawing |
| | | CHEVROLET | CRUZE (09-) | 1,6 i 16V | | 05.2009 | | 13301234 , 5 42 115 | see drawing |
| | | CHEVROLET | ORLANDO (11-) | 1,8 | | 02.2011 | | 13301234 , 5 42 115 | see drawing |
| | | CHEVROLET | ORLANDO (11-) | 2,0 D | | 02.2011 | | 13301234 , 5 42 115 | see drawing |
| 24.8190-0309.2 | 620309 | BMW | X3 (10-) | xDrive 20d | FL | 09.2010 | | 34 35 6 790 303 | |
| | | BMW | X3 (10-) | xDrive 28i | FL | 09.2010 | | 34 35 6 790 303 | |
| | | BMW | X3 (10-) | xDrive 35i | FL | 09.2010 | | 34 35 6 790 303 | |



| | | | | | | | |
|--|--|--|--|--|-------------------------------|--|--|
| | | | | | OE numbers per ATE pn. | | e.g. replaced pn. / miscellaneous |
|--|--|--|--|--|-------------------------------|--|--|



SCH - Brake disc rear

| | | | | | | | | | |
|----------------|---------------|---------|----------------|-----------------|--|---------|---------|-------------|--|
| 24.0110-0336.1 | 410336 | HYUNDAI | GRANDEUR (05-) | 3,3 i V6 | | 04.2005 | | 58411-3L000 | |
| | | HYUNDAI | GRANDEUR (05-) | 2,7 i V6 | | 06.2006 | | 58411-3L000 | |
| | | HYUNDAI | GRANDEUR (05-) | 2,2 CRDi | | 06.2006 | | 58411-3L000 | |
| | | KIA | OPIRUS (03-) | 2,7 i V6 | | 10.2006 | 08.2007 | 58411-3L000 | |
| | | KIA | OPIRUS (03-) | 3,8 i V6 | | 10.2006 | 08.2007 | 58411-3L000 | |
| | | KIA | OPIRUS (03-) | 3,3 i V6 | | 10.2006 | 08.2007 | 58411-3L000 | |
| | | HYUNDAI | XG (05-) | 3,3 i V6 (XG50) | | 06.2005 | | 58411-3L000 | |
| | | HYUNDAI | XG (05-) | 2,7 i V6 (XG50) | | 05.2006 | | 58411-3L000 | |



SCV - Brake disc front

| | | | | | | | | | |
|----------------|---------------|---------|--|--------------|--|---------|---------|---------------|--|
| 24.0124-0223.1 | 424223 | RENAULT | MEGANE II Coupe/Convertible (EM_) (03-) | 2,0 dCi | | 09.2005 | | 77 01 208 848 | |
| | | RENAULT | MEGANE II Grandtour (KM_) (03-) | | | 09.2005 | | 77 01 208 848 | |
| | | RENAULT | MEGANE II Saloon 3/5-door(BM_/CM_) (02-) | | | 05.2009 | | 77 01 208 848 | |
| | | RENAULT | MEGANE II Saloon 4-door (LM_) (03-) | | | 09.2005 | | 77 01 208 848 | |
| 24.0128-0224.1 | 428224 | HYUNDAI | TERRACAN (01-07) | 3,5 i V6 4WD | | 11.2003 | 12.2007 | 51712-H1030 | |
| | | HYUNDAI | TERRACAN (01-07) | 2,9 CRDi 4WD | | 11.2003 | 12.2007 | 51712-H1030 | |
| | | HYUNDAI | TERRACAN (01-07) | 2,5 TDiC 4WD | | 11.2003 | 12.2007 | 51712-H1030 | |



| | | | | | | | |
|--|--|--|--|--|-------------------------------|--|--|
| | | | | | OE numbers per ATE pn. | | e.g. replaced pn. / miscellaneous |
|--|--|--|--|--|-------------------------------|--|--|



SCV - Brake disc front

| | | | | | | | | | |
|----------------|---------------|---------|------------------|----------|--|---------|---------|-------------|--|
| 24.0128-0224.1 | 428224 | HYUNDAI | TERRACAN (01-07) | 2,5 TDIC | | 11.2003 | 12.2007 | 51712-H1030 | |
|----------------|---------------|---------|------------------|----------|--|---------|---------|-------------|--|



SEH - Wheel sensor rear

| | | | | | | | | | |
|----------------|---------------|-----|--------------------------------|-------|----|---------|---------|-----------------------------------|----------------|
| 24.0711-5280.3 | 360275 | BMW | 1 series/E81/E87 Saloon (04-) | 130 i | RA | 09.2005 | | 34 52 6 762 476 , 34 52 6 785 022 | 24.0711-5191.3 |
| | | BMW | 1 series/E81/E87 Saloon (04-) | 123 d | RA | 10.2007 | | 34 52 6 762 476 , 34 52 6 785 022 | 24.0711-5191.3 |
| | | BMW | 1 series/E82 Coupe (07-) | 135 i | RA | 10.2007 | | 34 52 6 762 476 , 34 52 6 785 022 | 24.0711-5191.3 |
| | | BMW | 1 series/E82 Coupe (07-) | 123 d | RA | 10.2007 | | 34 52 6 762 476 , 34 52 6 785 022 | 24.0711-5191.3 |
| | | BMW | 1 series/E88 Convertible (08-) | | RA | 09.2008 | | 34 52 6 762 476 , 34 52 6 785 022 | 24.0711-5191.3 |
| | | BMW | 1 series/E88 Convertible (08-) | 135 i | RA | 03.2008 | | 34 52 6 762 476 , 34 52 6 785 022 | 24.0711-5191.3 |
| | | BMW | 3 series/E90 Saloon (05-) | 330 d | RA | 09.2005 | | 34 52 6 762 476 , 34 52 6 785 022 | 24.0711-5191.3 |
| | | BMW | 3 series/E90 Saloon (05-) | 330 i | RA | 09.2007 | | 34 52 6 762 476 , 34 52 6 785 022 | 24.0711-5191.3 |
| | | BMW | 3 series/E90 Saloon (05-) | | RA | 12.2004 | 08.2007 | 34 52 6 762 476 , 34 52 6 785 022 | 24.0711-5191.3 |
| | | BMW | 3 series/E90 Saloon (05-) | M3 | RA | 12.2007 | | 34 52 6 762 476 , 34 52 6 785 022 | 24.0711-5191.3 |



| | | | | | | | |
|--|--|--|--|--|-------------------------------|--|--|
| | | | | | OE numbers per ATE pn. | | e.g. replaced pn. / miscellaneous |
|--|--|--|--|--|-------------------------------|--|--|



SEH - Wheel sensor rear

| | | | | | | | | | |
|----------------|---------------|-----|----------------------------|-------|----|---------|--|-----------------------------------|----------------|
| 24.0711-5280.3 | 360275 | BMW | 3 series/E90 Saloon (05-) | 335 i | RA | 09.2006 | | 34 52 6 762 476 , 34 52 6 785 022 | 24.0711-5191.3 |
| | | BMW | 3 series/E90 Saloon (05-) | 335 d | RA | 09.2006 | | 34 52 6 762 476 , 34 52 6 785 022 | 24.0711-5191.3 |
| | | BMW | 3 series/E90 Saloon (05-) | 325 i | RA | 12.2004 | | 34 52 6 762 476 , 34 52 6 785 022 | 24.0711-5191.3 |
| | | BMW | 3 series/E90 Saloon (05-) | 325 d | RA | 09.2006 | | 34 52 6 762 476 , 34 52 6 785 022 | 24.0711-5191.3 |
| | | BMW | 3 series/E90 Saloon (05-) | 330 d | RA | 09.2008 | | 34 52 6 762 476 , 34 52 6 785 022 | 24.0711-5191.3 |
| | | BMW | 3 series/E91 Touring (05-) | 323 i | RA | 06.2005 | | 34 52 6 762 476 , 34 52 6 785 022 | 24.0711-5191.3 |
| | | BMW | 3 series/E91 Touring (05-) | 330 i | RA | 09.2007 | | 34 52 6 762 476 , 34 52 6 785 022 | 24.0711-5191.3 |
| | | BMW | 3 series/E91 Touring (05-) | 325 d | RA | 09.2006 | | 34 52 6 762 476 , 34 52 6 785 022 | 24.0711-5191.3 |
| | | BMW | 3 series/E91 Touring (05-) | 325 i | RA | 06.2005 | | 34 52 6 762 476 , 34 52 6 785 022 | 24.0711-5191.3 |
| | | BMW | 3 series/E91 Touring (05-) | 330 d | RA | 06.2005 | | 34 52 6 762 476 , 34 52 6 785 022 | 24.0711-5191.3 |
| | | BMW | 3 series/E91 Touring (05-) | | RA | 09.2008 | | 34 52 6 762 476 , 34 52 6 785 022 | 24.0711-5191.3 |
| | | BMW | 3 series/E91 Touring (05-) | 335 i | RA | 09.2006 | | 34 52 6 762 476 , 34 52 6 785 022 | 24.0711-5191.3 |



| | | | | | | | |
|--|--|--|--|--|-------------------------------|--|--|
| | | | | | OE numbers per ATE pn. | | e.g. replaced pn. / miscellaneous |
|--|--|--|--|--|-------------------------------|--|--|



SEH - Wheel sensor rear

| | | | | | | | | | |
|----------------|---------------|-----|--------------------------------|-------|----|---------|---------|-----------------------------------|----------------|
| 24.0711-5280.3 | 360275 | BMW | 3 series/E91 Touring (05-) | 335 d | RA | 09.2006 | | 34 52 6 762 476 , 34 52 6 785 022 | 24.0711-5191.3 |
| | | BMW | 3 series/E91 Touring (05-) | 330 i | RA | 06.2005 | 08.2007 | 34 52 6 762 476 , 34 52 6 785 022 | 24.0711-5191.3 |
| | | BMW | 3 series/E92 Coupe (06-) | 335 d | RA | 09.2006 | | 34 52 6 762 476 , 34 52 6 785 022 | 24.0711-5191.3 |
| | | BMW | 3 series/E92 Coupe (06-) | 330 d | RA | 09.2006 | | 34 52 6 762 476 , 34 52 6 785 022 | 24.0711-5191.3 |
| | | BMW | 3 series/E92 Coupe (06-) | 330 i | RA | 09.2006 | | 34 52 6 762 476 , 34 52 6 785 022 | 24.0711-5191.3 |
| | | BMW | 3 series/E92 Coupe (06-) | 335 i | RA | 09.2006 | | 34 52 6 762 476 , 34 52 6 785 022 | 24.0711-5191.3 |
| | | BMW | 3 series/E92 Coupe (06-) | M3 | RA | 03.2007 | | 34 52 6 762 476 , 34 52 6 785 022 | 24.0711-5191.3 |
| | | BMW | 3 series/E92 Coupe (06-) | 330 d | RA | 09.2008 | | 34 52 6 762 476 , 34 52 6 785 022 | 24.0711-5191.3 |
| | | BMW | 3 series/E92 Coupe (06-) | 325 d | RA | 03.2007 | | 34 52 6 762 476 , 34 52 6 785 022 | 24.0711-5191.3 |
| | | BMW | 3 series/E93 Convertible (07-) | 325 i | RA | 03.2007 | | 34 52 6 762 476 , 34 52 6 785 022 | 24.0711-5191.3 |
| | | BMW | 3 series/E93 Convertible (07-) | M3 | RA | 03.2008 | | 34 52 6 762 476 , 34 52 6 785 022 | 24.0711-5191.3 |
| | | BMW | 3 series/E93 Convertible (07-) | 335 i | RA | 03.2007 | | 34 52 6 762 476 , 34 52 6 785 022 | 24.0711-5191.3 |



| | | | | | | | |
|--|--|--|--|--|-------------------------------|--|--|
| | | | | | OE numbers per ATE pn. | | e.g. replaced pn. / miscellaneous |
|--|--|--|--|--|-------------------------------|--|--|



SEH - Wheel sensor rear

| | | | | | | | | | |
|----------------|---------------|-----|--------------------------------|-------|----|---------|--|-----------------------------------|----------------|
| 24.0711-5280.3 | 360275 | BMW | 3 series/E93 Convertible (07-) | 330 d | RA | 03.2007 | | 34 52 6 762 476 , 34 52 6 785 022 | 24.0711-5191.3 |
| | | BMW | 3 series/E93 Convertible (07-) | 325 d | RA | 09.2007 | | 34 52 6 762 476 , 34 52 6 785 022 | 24.0711-5191.3 |
| | | BMW | 3 series/E93 Convertible (07-) | 320 d | RA | 03.2008 | | 34 52 6 762 476 , 34 52 6 785 022 | 24.0711-5191.3 |
| | | BMW | 3 series/E93 Convertible (07-) | 330 i | RA | 03.2007 | | 34 52 6 762 476 , 34 52 6 785 022 | 24.0711-5191.3 |



TRH - Brake drums rear

| | | | | | | | | | |
|----------------|---------------|-------------|---|---------------------|--|---------|---------|---------------|--|
| 24.0225-4019.1 | 480305 | Classic PKW | RENAULT TRAFIC I PROPULSION (PXX) (81-89) | 1,7 (P3--) | | | 04.1989 | 77 00 692 363 | |
| | | Classic PKW | RENAULT TRAFIC I PROPULSION (PXX) (81-89) | 2,0 (P3--) Kastenw, | | | 04.1989 | 77 00 692 363 | |
| | | Classic PKW | RENAULT TRAFIC I PROPULSION (PXX) (81-89) | 2,1 D (P3--) | | | 04.1989 | 77 00 692 363 | |
| | | RENAULT | TRAFIC I Van (TXX) (89-01) | 2,5 D 4x4 | | 11.1997 | 03.2001 | 77 00 692 363 | |
| | | RENAULT | TRAFIC I PROPULSION (PXX) (89-97) | 2,1 D | | 05.1989 | 06.1994 | 77 00 692 363 | |
| | | RENAULT | TRAFIC I PROPULSION (PXX) (89-97) | | | 06.1994 | 10.1997 | 77 00 692 363 | |
| | | RENAULT | TRAFIC I PROPULSION (PXX) (89-97) | 1,7 | | 05.1989 | 08.1994 | 77 00 692 363 | |
| | | RENAULT | TRAFIC I PROPULSION (PXX) (89-97) | 2 | | 05.1989 | 10.1997 | 77 00 692 363 | |



13.0460-7262.2 607262

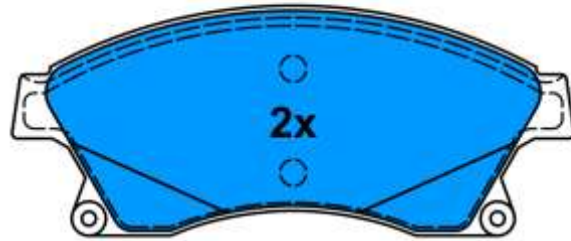

25031 19,1

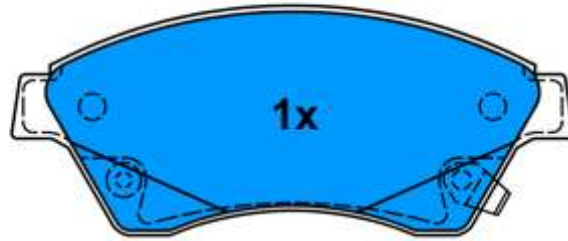

25032 19,1

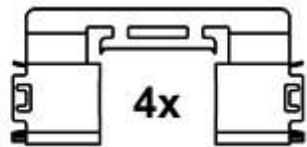

148,2 x 60,3

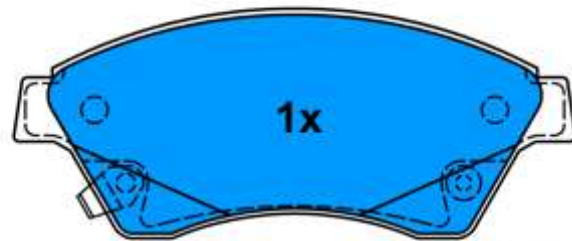

25033 19,1

Applications:

OPEL ASTRA J / GTC / Vauxhall Astra MK VI (09-)
OPEL ASTRA J Sports Tourer/Vau.Astra Sports Tourer (10-)
CHEVROLET CRUZE (09-)



13.0460-5607.2 605607

Applications:

LEXUS LS 460 (06-)
LEXUS LS 600 (07-)

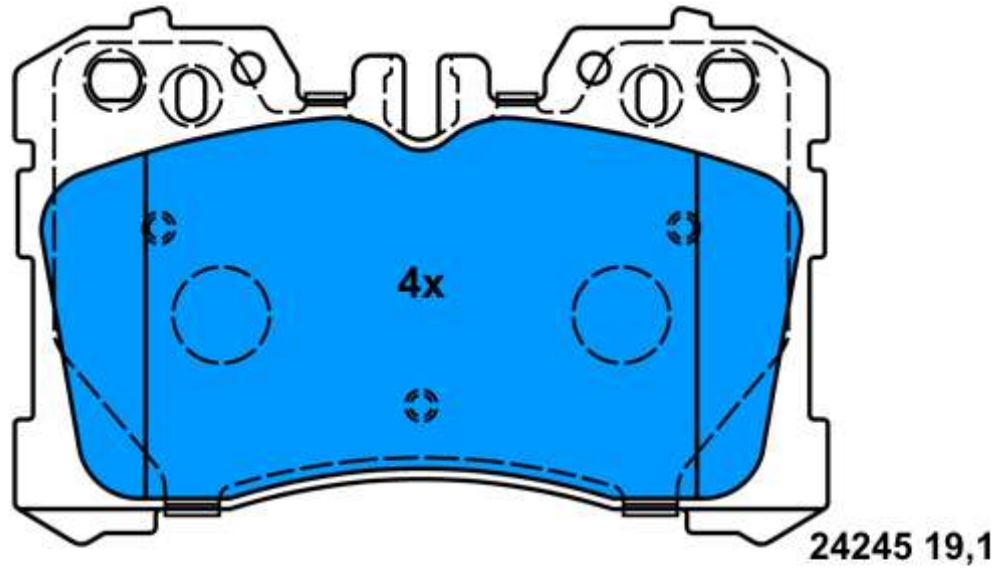

133,7 x 87,9



13.0460-7263.2 607263

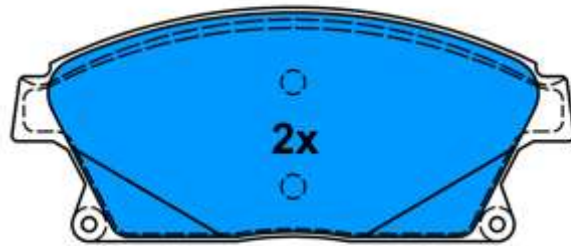

25034 19,1

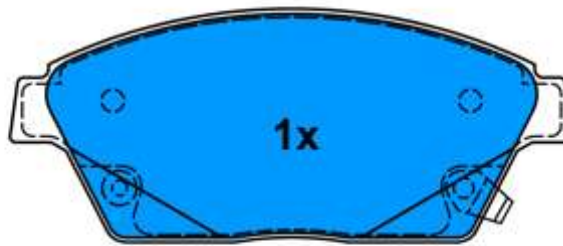

25035 19,1

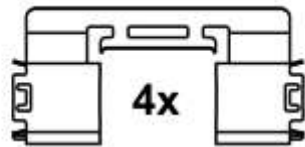

148,2 x 61,1

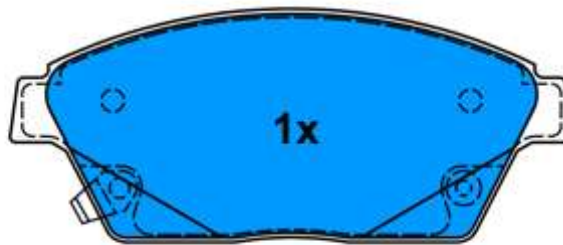

25036 19,1

Applications:

- OPEL ASTRA J / GTC / Vauxhall Astra MK VI (09-)
- OPEL ASTRA J Sports Tourer/Vau.Astra Sports Tourer (10-)
- CHEVROLET CRUZE (09-)
- CHEVROLET ORLANDO (11-)