

New partnumbers on stock
according to applications



04/2011



www.ate.de

New partnumbers on stock - according to applications

04/2011



| | | | | | | | | |
|--|--|--|--|--|-------------|------------------------|--|-----------------------------------|
| | | | | | Description | OE numbers per ATE pn. | | e.g. replaced pn. / miscellaneous |
|--|--|--|--|--|-------------|------------------------|--|-----------------------------------|

AUDI

| | | | | | | | | | |
|-------------------------|---------|----|---------|---------|----------------|--------|-----------------|---|--|
| 100 (91-94) | 1,6 | FL | 03.1992 | 07.1993 | 24.3571-8505.5 | 240489 | FIST CALIPER | 4A0 615 123 | |
| | | FR | 03.1992 | 07.1993 | 24.3571-8506.5 | 240490 | FIST CALIPER | 4A0 615 124 | |
| | 2 | FR | 12.1990 | 07.1994 | 24.3571-8506.5 | 240490 | FIST CALIPER | 4A0 615 124 | |
| | | FL | 12.1990 | 07.1994 | 24.3571-8505.5 | 240489 | FIST CALIPER | 4A0 615 123 | |
| | 2,0 16V | FL | 01.1992 | 07.1994 | 24.3571-8505.5 | 240489 | FIST CALIPER | 4A0 615 123 | |
| | | FR | 01.1992 | 07.1994 | 24.3571-8506.5 | 240490 | FIST CALIPER | 4A0 615 124 | |
| | 2,3 | FR | 12.1990 | 07.1994 | 24.3571-8506.5 | 240490 | FIST CALIPER | 4A0 615 124 | |
| | | FL | 12.1990 | 07.1994 | 24.3571-8505.5 | 240489 | FIST CALIPER | 4A0 615 123 | |
| | 2,4 D | FL | 05.1991 | 07.1994 | 24.3571-8505.5 | 240489 | FIST CALIPER | 4A0 615 123 | |
| | | FR | 05.1991 | 07.1994 | 24.3571-8506.5 | 240490 | FIST CALIPER | 4A0 615 124 | |
| | 2,5 TDI | FR | 06.1991 | 07.1994 | 24.3571-8506.5 | 240490 | FIST CALIPER | 4A0 615 124 | |
| | | FL | 06.1991 | 07.1994 | 24.3571-8505.5 | 240489 | FIST CALIPER | 4A0 615 123 | |
| 100 Quattro (91-94) | 2 | FL | 12.1990 | 07.1994 | 24.3571-8505.5 | 240489 | FIST CALIPER | 4A0 615 123 | |
| | | FR | 12.1990 | 07.1994 | 24.3571-8506.5 | 240490 | FIST CALIPER | 4A0 615 124 | |
| | 2,3 | FR | 12.1990 | 07.1994 | 24.3571-8506.5 | 240490 | FIST CALIPER | 4A0 615 124 | |
| | | FL | 12.1990 | 07.1994 | 24.3571-8505.5 | 240489 | FIST CALIPER | 4A0 615 123 | |
| A3 / A3 Sportback (03-) | 1,2 TSI | | 04.2010 | | 24.2415-1711.3 | 030130 | CLUTCH CYLINDER | 1K0 721 388 G , 1K0 721 388 L , 1K0 721 388 F , 1K0 721 388 M , 1K0 721 388 S , 1K0 721 388 B | |

New partnumbers on stock - according to applications

04/2011



| | | | | | | | | |
|--|--|--|--|--|-------------|------------------------|--|-----------------------------------|
| | | | | | Description | OE numbers per ATE pn. | | e.g. replaced pn. / miscellaneous |
|--|--|--|--|--|-------------|------------------------|--|-----------------------------------|

AUDI

| | | | | | | | | | |
|-------------------------|----------|--|---------|---------|----------------|--------|------------------|---|--|
| A3 / A3 Sportback (03-) | 1,2 TSI | | 04.2010 | | 24.0101-3803.2 | 260101 | INSTALLATION KIT | 4439 36 , 001 421 04 86 , 34 21 6 772 867 , 93179160 , 54 23 93 | |
| | 1,4 TFSI | | 07.2007 | | 24.2415-1711.3 | 030130 | CLUTCH CYLINDER | 1K0 721 388 G , 1K0 721 388 L , 1K0 721 388 F , 1K0 721 388 M , 1K0 721 388 S , 1K0 721 388 B | |
| | | | 07.2007 | | 24.0101-3803.2 | 260101 | INSTALLATION KIT | 4439 36 , 001 421 04 86 , 34 21 6 772 867 , 93179160 , 54 23 93 | |
| | 1,6 | | 05.2003 | | 24.2415-1711.3 | 030130 | CLUTCH CYLINDER | 1K0 721 388 G , 1K0 721 388 L , 1K0 721 388 F , 1K0 721 388 M , 1K0 721 388 S , 1K0 721 388 B | |
| | | | 05.2003 | 05.2007 | 24.0101-3803.2 | 260101 | INSTALLATION KIT | 4439 36 , 001 421 04 86 , 34 21 6 772 867 , 93179160 , 54 23 93 | |
| | | | 06.2007 | | 24.0101-3803.2 | 260101 | INSTALLATION KIT | 4439 36 , 001 421 04 86 , 34 21 6 772 867 , 93179160 , 54 23 93 | |
| | 1,6 FSI | | 08.2003 | | 24.2415-1711.3 | 030130 | CLUTCH CYLINDER | 1K0 721 388 G , 1K0 721 388 L , 1K0 721 388 F , 1K0 721 388 M , 1K0 721 388 S , 1K0 721 388 B | |
| | | | 08.2003 | 05.2007 | 24.0101-3803.2 | 260101 | INSTALLATION KIT | 4439 36 , 001 421 04 86 , 34 21 6 772 867 , 93179160 , 54 23 93 | |
| | | | 06.2007 | | 24.0101-3803.2 | 260101 | INSTALLATION KIT | 4439 36 , 001 421 04 86 , 34 21 6 772 867 , 93179160 , 54 23 93 | |

New partnumbers on stock - according to applications

04/2011



| | | | | | | | |
|--|--|--|--|--|--------------------|-------------------------------|---------------------------------------|
| | | | | | Description | OE numbers per ATE pn. | e.g. replaced pn. / miscellaneous |
|--|--|--|--|--|--------------------|-------------------------------|---------------------------------------|

AUDI

| | | | | | | | | | |
|-------------------------|------------------|--|---------|---------|----------------|--------|------------------|---|--|
| A3 / A3 Sportback (03-) | 1,6 TDI | | 05.2009 | | 24.2415-1711.3 | 030130 | CLUTCH CYLINDER | 1K0 721 388 G , 1K0 721 388 L , 1K0 721 388 F , 1K0 721 388 M , 1K0 721 388 S , 1K0 721 388 B | |
| | | | 05.2009 | | 24.0101-3803.2 | 260101 | INSTALLATION KIT | 4439 36 , 001 421 04 86 , 34 21 6 772 867 , 93179160 , 54 23 93 | |
| | 1,8 TFSI | | 01.2007 | | 24.2415-1711.3 | 030130 | CLUTCH CYLINDER | 1K0 721 388 G , 1K0 721 388 L , 1K0 721 388 F , 1K0 721 388 M , 1K0 721 388 S , 1K0 721 388 B | |
| | | | 01.2007 | 05.2007 | 24.0101-3803.2 | 260101 | INSTALLATION KIT | 4439 36 , 001 421 04 86 , 34 21 6 772 867 , 93179160 , 54 23 93 | |
| | | | 06.2007 | | 24.0101-3803.2 | 260101 | INSTALLATION KIT | 4439 36 , 001 421 04 86 , 34 21 6 772 867 , 93179160 , 54 23 93 | |
| | 1,8 TFSI quattro | | 05.2008 | | 24.2415-1711.3 | 030130 | CLUTCH CYLINDER | 1K0 721 388 G , 1K0 721 388 L , 1K0 721 388 F , 1K0 721 388 M , 1K0 721 388 S , 1K0 721 388 B | |
| | 1,9 TDI | | 06.2003 | | 24.2415-1711.3 | 030130 | CLUTCH CYLINDER | 1K0 721 388 G , 1K0 721 388 L , 1K0 721 388 F , 1K0 721 388 M , 1K0 721 388 S , 1K0 721 388 B | |
| | | | 06.2003 | 05.2007 | 24.0101-3803.2 | 260101 | INSTALLATION KIT | 4439 36 , 001 421 04 86 , 34 21 6 772 867 , 93179160 , 54 23 93 | |
| | | | 06.2007 | | 24.0101-3803.2 | 260101 | INSTALLATION KIT | 4439 36 , 001 421 04 86 , 34 21 6 772 867 , 93179160 , 54 23 93 | |

New partnumbers on stock - according to applications

04/2011



| | | | | | | | | |
|--|--|--|--|--|-------------|------------------------|--|-----------------------------------|
| | | | | | Description | OE numbers per ATE pn. | | e.g. replaced pn. / miscellaneous |
|--|--|--|--|--|-------------|------------------------|--|-----------------------------------|

AUDI

| | | | | | | | | | |
|-------------------------|---------|--|---------|---------|----------------|--------|------------------|---|--|
| A3 / A3 Sportback (03-) | 2,0 FSI | | 05.2003 | | 24.2415-1711.3 | 030130 | CLUTCH CYLINDER | 1K0 721 388 G , 1K0 721 388 L , 1K0 721 388 F , 1K0 721 388 M , 1K0 721 388 S , 1K0 721 388 B | |
| | | | 05.2003 | 05.2007 | 24.0101-3803.2 | 260101 | INSTALLATION KIT | 4439 36 , 001 421 04 86 , 34 21 6 772 867 , 93179160 , 54 23 93 | |
| | | | 06.2007 | | 24.0101-3803.2 | 260101 | INSTALLATION KIT | 4439 36 , 001 421 04 86 , 34 21 6 772 867 , 93179160 , 54 23 93 | |
| | 2,0 TDI | | 03.2006 | | 24.2415-1711.3 | 030130 | CLUTCH CYLINDER | 1K0 721 388 G , 1K0 721 388 L , 1K0 721 388 F , 1K0 721 388 M , 1K0 721 388 S , 1K0 721 388 B | |
| | | | 06.2006 | 06.2008 | 24.2415-1711.3 | 030130 | CLUTCH CYLINDER | 1K0 721 388 G , 1K0 721 388 L , 1K0 721 388 F , 1K0 721 388 M , 1K0 721 388 S , 1K0 721 388 B | |
| | | | 05.2003 | | 24.2415-1711.3 | 030130 | CLUTCH CYLINDER | 1K0 721 388 G , 1K0 721 388 L , 1K0 721 388 F , 1K0 721 388 M , 1K0 721 388 S , 1K0 721 388 B | |
| | | | 06.2007 | | 24.0101-3803.2 | 260101 | INSTALLATION KIT | 4439 36 , 001 421 04 86 , 34 21 6 772 867 , 93179160 , 54 23 93 | |
| | | | 06.2006 | 05.2007 | 24.0101-3803.2 | 260101 | INSTALLATION KIT | 4439 36 , 001 421 04 86 , 34 21 6 772 867 , 93179160 , 54 23 93 | |
| | | | 05.2003 | 05.2007 | 24.0101-3803.2 | 260101 | INSTALLATION KIT | 4439 36 , 001 421 04 86 , 34 21 6 772 867 , 93179160 , 54 23 93 | |

New partnumbers on stock - according to applications

04/2011



| | | | | | | | |
|--|--|--|--|--|--------------------|-------------------------------|---------------------------------------|
| | | | | | Description | OE numbers per ATE pn. | e.g. replaced pn. / miscellaneous |
|--|--|--|--|--|--------------------|-------------------------------|---------------------------------------|

AUDI

| | | | | | | | | | |
|-------------------------|------------------|--|---------|---------|----------------|--------|------------------|---|--|
| A3 / A3 Sportback (03-) | 2,0 TDI | | 06.2007 | 06.2008 | 24.0101-3803.2 | 260101 | INSTALLATION KIT | 4439 36 , 001 421 04 86 , 34 21 6 772 867 , 93179160 , 54 23 93 | |
| | | | 03.2006 | 05.2007 | 24.0101-3803.2 | 260101 | INSTALLATION KIT | 4439 36 , 001 421 04 86 , 34 21 6 772 867 , 93179160 , 54 23 93 | |
| | 2,0 TDI quattro | | 08.2004 | | 24.2415-1711.3 | 030130 | CLUTCH CYLINDER | 1K0 721 388 G , 1K0 721 388 L , 1K0 721 388 F , 1K0 721 388 M , 1K0 721 388 S , 1K0 721 388 B | |
| | | | 03.2006 | | 24.2415-1711.3 | 030130 | CLUTCH CYLINDER | 1K0 721 388 G , 1K0 721 388 L , 1K0 721 388 F , 1K0 721 388 M , 1K0 721 388 S , 1K0 721 388 B | |
| | | | 05.2003 | | 24.2415-1711.3 | 030130 | CLUTCH CYLINDER | 1K0 721 388 G , 1K0 721 388 L , 1K0 721 388 F , 1K0 721 388 M , 1K0 721 388 S , 1K0 721 388 B | |
| | 2,0 TFSI | | 06.2004 | | 24.2415-1711.3 | 030130 | CLUTCH CYLINDER | 1K0 721 388 G , 1K0 721 388 L , 1K0 721 388 F , 1K0 721 388 M , 1K0 721 388 S , 1K0 721 388 B | |
| | | | 06.2004 | 05.2007 | 24.0101-3803.2 | 260101 | INSTALLATION KIT | 4439 36 , 001 421 04 86 , 34 21 6 772 867 , 93179160 , 54 23 93 | |
| | | | 06.2007 | | 24.0101-3803.2 | 260101 | INSTALLATION KIT | 4439 36 , 001 421 04 86 , 34 21 6 772 867 , 93179160 , 54 23 93 | |
| | 2,0 TFSI quattro | | 06.2004 | | 24.2415-1711.3 | 030130 | CLUTCH CYLINDER | 1K0 721 388 G , 1K0 721 388 L , 1K0 721 388 F , 1K0 721 388 M , 1K0 721 388 S , 1K0 721 388 B | |

New partnumbers on stock - according to applications

04/2011



| | | | | | | | | |
|--|--|--|--|--|-------------|------------------------|--|-----------------------------------|
| | | | | | Description | OE numbers per ATE pn. | | e.g. replaced pn. / miscellaneous |
|--|--|--|--|--|-------------|------------------------|--|-----------------------------------|

AUDI

| | | | | | | | | | |
|-------------------------|-------------|--|---------|--|----------------|--------|------------------|---|--|
| A3 / A3 Sportback (03-) | 3,2 quattro | | 07.2003 | | 24.2415-1711.3 | 030130 | CLUTCH CYLINDER | 1K0 721 388 G , 1K0 721 388 L , 1K0 721 388 F , 1K0 721 388 M , 1K0 721 388 S , 1K0 721 388 B | |
| | S3 quattro | | 07.2008 | | 24.2415-1711.3 | 030130 | CLUTCH CYLINDER | 1K0 721 388 G , 1K0 721 388 L , 1K0 721 388 F , 1K0 721 388 M , 1K0 721 388 S , 1K0 721 388 B | |
| | | | 11.2006 | | 24.2415-1711.3 | 030130 | CLUTCH CYLINDER | 1K0 721 388 G , 1K0 721 388 L , 1K0 721 388 F , 1K0 721 388 M , 1K0 721 388 S , 1K0 721 388 B | |
| A3 Convertible (08-) | 1,2 TSI | | 03.2010 | | 24.2415-1711.3 | 030130 | CLUTCH CYLINDER | 1K0 721 388 G , 1K0 721 388 L , 1K0 721 388 F , 1K0 721 388 M , 1K0 721 388 S , 1K0 721 388 B | |
| | | | 03.2010 | | 24.0101-3803.2 | 260101 | INSTALLATION KIT | 4439 36 , 001 421 04 86 , 34 21 6 772 867 , 93179160 , 54 23 93 | |
| | 1,6 | | 09.2008 | | 24.2415-1711.3 | 030130 | CLUTCH CYLINDER | 1K0 721 388 G , 1K0 721 388 L , 1K0 721 388 F , 1K0 721 388 M , 1K0 721 388 S , 1K0 721 388 B | |
| | | | 09.2008 | | 24.0101-3803.2 | 260101 | INSTALLATION KIT | 4439 36 , 001 421 04 86 , 34 21 6 772 867 , 93179160 , 54 23 93 | |
| | 1,6 TDI | | 05.2009 | | 24.2415-1711.3 | 030130 | CLUTCH CYLINDER | 1K0 721 388 G , 1K0 721 388 L , 1K0 721 388 F , 1K0 721 388 M , 1K0 721 388 S , 1K0 721 388 B | |
| | | | 05.2009 | | 24.0101-3803.2 | 260101 | INSTALLATION KIT | 4439 36 , 001 421 04 86 , 34 21 6 772 867 , 93179160 , 54 23 93 | |

New partnumbers on stock - according to applications

04/2011



| | | | | | | | | |
|--|--|--|--|--|-------------|------------------------|--|-----------------------------------|
| | | | | | Description | OE numbers per ATE pn. | | e.g. replaced pn. / miscellaneous |
|--|--|--|--|--|-------------|------------------------|--|-----------------------------------|

AUDI

| | | | | | | | | | |
|-------------------------------|-------------|----|---------|---------|----------------|--------|------------------|---|--|
| A3 Convertible (08-) | 1,8 TFSI | | 04.2008 | | 24.2415-1711.3 | 030130 | CLUTCH CYLINDER | 1K0 721 388 G , 1K0 721 388 L , 1K0 721 388 F , 1K0 721 388 M , 1K0 721 388 S , 1K0 721 388 B | |
| | | | 04.2008 | | 24.0101-3803.2 | 260101 | INSTALLATION KIT | 4439 36 , 001 421 04 86 , 34 21 6 772 867 , 93179160 , 54 23 93 | |
| | 1,9 TDI | | 04.2008 | | 24.2415-1711.3 | 030130 | CLUTCH CYLINDER | 1K0 721 388 G , 1K0 721 388 L , 1K0 721 388 F , 1K0 721 388 M , 1K0 721 388 S , 1K0 721 388 B | |
| | | | 04.2008 | | 24.0101-3803.2 | 260101 | INSTALLATION KIT | 4439 36 , 001 421 04 86 , 34 21 6 772 867 , 93179160 , 54 23 93 | |
| | 2,0 TDI | | 04.2008 | | 24.2415-1711.3 | 030130 | CLUTCH CYLINDER | 1K0 721 388 G , 1K0 721 388 L , 1K0 721 388 F , 1K0 721 388 M , 1K0 721 388 S , 1K0 721 388 B | |
| | | | 04.2008 | | 24.0101-3803.2 | 260101 | INSTALLATION KIT | 4439 36 , 001 421 04 86 , 34 21 6 772 867 , 93179160 , 54 23 93 | |
| | 2,0 TFSI | | 04.2008 | | 24.2415-1711.3 | 030130 | CLUTCH CYLINDER | 1K0 721 388 G , 1K0 721 388 L , 1K0 721 388 F , 1K0 721 388 M , 1K0 721 388 S , 1K0 721 388 B | |
| | | | 04.2008 | | 24.0101-3803.2 | 260101 | INSTALLATION KIT | 4439 36 , 001 421 04 86 , 34 21 6 772 867 , 93179160 , 54 23 93 | |
| A6 / A6 Avant (4A/C4) (94-97) | 1,8 | FL | 10.1995 | 12.1997 | 24.3571-8505.5 | 240489 | FIST CALIPER | 4A0 615 123 | |
| | | FR | 10.1995 | 12.1997 | 24.3571-8506.5 | 240490 | FIST CALIPER | 4A0 615 124 | |
| | 1,8 Quattro | FL | 10.1995 | 12.1997 | 24.3571-8505.5 | 240489 | FIST CALIPER | 4A0 615 123 | |

New partnumbers on stock - according to applications

04/2011



| | | | | | | | | |
|--|--|--|--|--|-------------|------------------------|--|-----------------------------------|
| | | | | | Description | OE numbers per ATE pn. | | e.g. replaced pn. / miscellaneous |
|--|--|--|--|--|-------------|------------------------|--|-----------------------------------|

AUDI

| | | | | | | | | | |
|-------------------------------|-------------|----|---------|---------|----------------|--------|------------------|---|--|
| A6 / A6 Avant (4A/C4) (94-97) | 1,8 Quattro | FR | 10.1995 | 12.1997 | 24.3571-8506.5 | 240490 | FIST CALIPER | 4A0 615 124 | |
| | 1,9 TDI | FR | 06.1994 | 12.1997 | 24.3571-8506.5 | 240490 | FIST CALIPER | 4A0 615 124 | |
| | | FL | 06.1994 | 12.1997 | 24.3571-8505.5 | 240489 | FIST CALIPER | 4A0 615 123 | |
| | 2 | FL | 06.1994 | 12.1997 | 24.3571-8505.5 | 240489 | FIST CALIPER | 4A0 615 123 | |
| | | FR | 06.1994 | 12.1997 | 24.3571-8506.5 | 240490 | FIST CALIPER | 4A0 615 124 | |
| | 2,0 16V | FL | 06.1994 | 12.1997 | 24.3571-8505.5 | 240489 | FIST CALIPER | 4A0 615 123 | |
| | | FR | 06.1994 | 12.1997 | 24.3571-8506.5 | 240490 | FIST CALIPER | 4A0 615 124 | |
| | 2,0 Quattro | FR | 06.1994 | 12.1997 | 24.3571-8506.5 | 240490 | FIST CALIPER | 4A0 615 124 | |
| | | FL | 06.1994 | 12.1997 | 24.3571-8505.5 | 240489 | FIST CALIPER | 4A0 615 123 | |
| | 2,3 | FR | 06.1994 | 12.1995 | 24.3571-8506.5 | 240490 | FIST CALIPER | 4A0 615 124 | |
| | | FL | 06.1994 | 12.1995 | 24.3571-8505.5 | 240489 | FIST CALIPER | 4A0 615 123 | |
| | 2,3 Quattro | FR | 08.1994 | 12.1995 | 24.3571-8506.5 | 240490 | FIST CALIPER | 4A0 615 124 | |
| | | FL | 08.1994 | 12.1995 | 24.3571-8505.5 | 240489 | FIST CALIPER | 4A0 615 123 | |
| | 2,5 TDI | FL | 06.1994 | 12.1997 | 24.3571-8505.5 | 240489 | FIST CALIPER | 4A0 615 123 | |
| | | FR | 06.1994 | 12.1997 | 24.3571-8506.5 | 240490 | FIST CALIPER | 4A0 615 124 | |
| TT Coupe (06-) | 1,8 TFSI | | 06.2008 | | 24.2415-1711.3 | 030130 | CLUTCH CYLINDER | 1K0 721 388 G , 1K0 721 388 L , 1K0 721 388 F , 1K0 721 388 M , 1K0 721 388 S , 1K0 721 388 B | |
| | | | 06.2008 | | 24.0101-3803.2 | 260101 | INSTALLATION KIT | 4439 36 , 001 421 04 86 , 34 21 6 772 867 , 93179160 , 54 23 93 | |

New partnumbers on stock - according to applications

04/2011



| | | | | | | | |
|--|--|--|--|--|--------------------|-------------------------------|--|
| | | | | | Description | OE numbers per ATE pn. | e.g. replaced pn. / miscellaneous |
|--|--|--|--|--|--------------------|-------------------------------|--|

AUDI

| | | | | | | | | | |
|----------------|------------------|--|---------|--|----------------|--------|------------------|---|--|
| TT Coupe (06-) | 2,0 Quattro | | 05.2008 | | 24.2415-1711.3 | 030130 | CLUTCH CYLINDER | 1K0 721 388 G , 1K0 721 388 L , 1K0 721 388 F , 1K0 721 388 M , 1K0 721 388 S , 1K0 721 388 B | |
| | 2,0 TDI Quattro | | 06.2008 | | 24.2415-1711.3 | 030130 | CLUTCH CYLINDER | 1K0 721 388 G , 1K0 721 388 L , 1K0 721 388 F , 1K0 721 388 M , 1K0 721 388 S , 1K0 721 388 B | |
| | 2,0 TFSI | | 07.2006 | | 24.2415-1711.3 | 030130 | CLUTCH CYLINDER | 1K0 721 388 G , 1K0 721 388 L , 1K0 721 388 F , 1K0 721 388 M , 1K0 721 388 S , 1K0 721 388 B | |
| | | | 05.2010 | | 24.2415-1711.3 | 030130 | CLUTCH CYLINDER | 1K0 721 388 G , 1K0 721 388 L , 1K0 721 388 F , 1K0 721 388 M , 1K0 721 388 S , 1K0 721 388 B | |
| | | | 07.2006 | | 24.0101-3803.2 | 260101 | INSTALLATION KIT | 4439 36 , 001 421 04 86 , 34 21 6 772 867 , 93179160 , 54 23 93 | |
| | | | 05.2010 | | 24.0101-3803.2 | 260101 | INSTALLATION KIT | 4439 36 , 001 421 04 86 , 34 21 6 772 867 , 93179160 , 54 23 93 | |
| | 2,0 TFSI Quattro | | 05.2008 | | 24.2415-1711.3 | 030130 | CLUTCH CYLINDER | 1K0 721 388 G , 1K0 721 388 L , 1K0 721 388 F , 1K0 721 388 M , 1K0 721 388 S , 1K0 721 388 B | |
| | | | 05.2010 | | 24.2415-1711.3 | 030130 | CLUTCH CYLINDER | 1K0 721 388 G , 1K0 721 388 L , 1K0 721 388 F , 1K0 721 388 M , 1K0 721 388 S , 1K0 721 388 B | |

New partnumbers on stock - according to applications

04/2011



| | | | | | | | |
|--|--|--|--|--|--------------------|-------------------------------|--|
| | | | | | Description | OE numbers per ATE pn. | e.g. replaced pn. / miscellaneous |
|--|--|--|--|--|--------------------|-------------------------------|--|

AUDI

| | | | | | | | | | |
|-------------------|---------------------|--|---------|--|----------------|--------|------------------|---|--|
| TT Coupe (06-) | 3,2 Quattro | | 07.2006 | | 24.2415-1711.3 | 030130 | CLUTCH CYLINDER | 1K0 721 388 G , 1K0 721 388 L , 1K0 721 388 F , 1K0 721 388 M , 1K0 721 388 S , 1K0 721 388 B | |
| | RS 2,5 TFSI Quattro | | 05.2009 | | 24.2415-1711.3 | 030130 | CLUTCH CYLINDER | 1K0 721 388 G , 1K0 721 388 L , 1K0 721 388 F , 1K0 721 388 M , 1K0 721 388 S , 1K0 721 388 B | |
| | TTS 2,0 TFSI | | 05.2008 | | 24.2415-1711.3 | 030130 | CLUTCH CYLINDER | 1K0 721 388 G , 1K0 721 388 L , 1K0 721 388 F , 1K0 721 388 M , 1K0 721 388 S , 1K0 721 388 B | |
| TT Roadster (07-) | 1,8 TFSI | | 06.2008 | | 24.2415-1711.3 | 030130 | CLUTCH CYLINDER | 1K0 721 388 G , 1K0 721 388 L , 1K0 721 388 F , 1K0 721 388 M , 1K0 721 388 S , 1K0 721 388 B | |
| | | | 06.2008 | | 24.0101-3803.2 | 260101 | INSTALLATION KIT | 4439 36 , 001 421 04 86 , 34 21 6 772 867 , 93179160 , 54 23 93 | |
| | 2,0 Quattro | | 05.2008 | | 24.2415-1711.3 | 030130 | CLUTCH CYLINDER | 1K0 721 388 G , 1K0 721 388 L , 1K0 721 388 F , 1K0 721 388 M , 1K0 721 388 S , 1K0 721 388 B | |
| | 2,0 TDI Quattro | | 06.2008 | | 24.2415-1711.3 | 030130 | CLUTCH CYLINDER | 1K0 721 388 G , 1K0 721 388 L , 1K0 721 388 F , 1K0 721 388 M , 1K0 721 388 S , 1K0 721 388 B | |
| | 2,0 TFSI | | 02.2007 | | 24.2415-1711.3 | 030130 | CLUTCH CYLINDER | 1K0 721 388 G , 1K0 721 388 L , 1K0 721 388 F , 1K0 721 388 M , 1K0 721 388 S , 1K0 721 388 B | |

New partnumbers on stock - according to applications

04/2011



| | | | | | | | |
|--|--|--|--|--|--------------------|-------------------------------|--|
| | | | | | Description | OE numbers per ATE pn. | e.g. replaced pn. / miscellaneous |
|--|--|--|--|--|--------------------|-------------------------------|--|







AUDI

| | | | | | | | | | |
|-------------------|---------------------|--|---------|--|----------------|--------|------------------|---|--|
| TT Roadster (07-) | 2,0 TFSI | | 05.2010 | | 24.2415-1711.3 | 030130 | CLUTCH CYLINDER | 1K0 721 388 G , 1K0 721 388 L , 1K0 721 388 F , 1K0 721 388 M , 1K0 721 388 S , 1K0 721 388 B | |
| | | | 05.2010 | | 24.0101-3803.2 | 260101 | INSTALLATION KIT | 4439 36 , 001 421 04 86 , 34 21 6 772 867 , 93179160 , 54 23 93 | |
| | | | 02.2007 | | 24.0101-3803.2 | 260101 | INSTALLATION KIT | 4439 36 , 001 421 04 86 , 34 21 6 772 867 , 93179160 , 54 23 93 | |
| | 2,0 TFSI Quattro | | 05.2010 | | 24.2415-1711.3 | 030130 | CLUTCH CYLINDER | 1K0 721 388 G , 1K0 721 388 L , 1K0 721 388 F , 1K0 721 388 M , 1K0 721 388 S , 1K0 721 388 B | |
| | | | 05.2008 | | 24.2415-1711.3 | 030130 | CLUTCH CYLINDER | 1K0 721 388 G , 1K0 721 388 L , 1K0 721 388 F , 1K0 721 388 M , 1K0 721 388 S , 1K0 721 388 B | |
| | 3,2 Quattro | | 02.2007 | | 24.2415-1711.3 | 030130 | CLUTCH CYLINDER | 1K0 721 388 G , 1K0 721 388 L , 1K0 721 388 F , 1K0 721 388 M , 1K0 721 388 S , 1K0 721 388 B | |
| | RS 2,5 TFSI Quattro | | 05.2009 | | 24.2415-1711.3 | 030130 | CLUTCH CYLINDER | 1K0 721 388 G , 1K0 721 388 L , 1K0 721 388 F , 1K0 721 388 M , 1K0 721 388 S , 1K0 721 388 B | |
| | TTS 2,0 TFSI | | 05.2008 | | 24.2415-1711.3 | 030130 | CLUTCH CYLINDER | 1K0 721 388 G , 1K0 721 388 L , 1K0 721 388 F , 1K0 721 388 M , 1K0 721 388 S , 1K0 721 388 B | |

New partnumbers on stock - according to applications

04/2011



| | | | | | | | |
|---|---|---|---|---|--------------------|-------------------------------|---|
|  |  |  |  |  | Description | OE numbers per ATE pn. |  e.g. replaced pn. / miscellaneous |
|---|---|---|---|---|--------------------|-------------------------------|---|







BMW

| | | | | | | | | | |
|--------------------------------|-------|----|---------|---------|----------------|--------|--------------------|-----------------------------------|----------------|
| 1 series/E81/E87 Saloon (04-) | 123 d | RA | 10.2007 | | 24.0711-5280.3 | 360275 | WHEEL SPEED SENSOR | 34 52 6 762 476 , 34 52 6 785 022 | 24.0711-5191.3 |
| | 130 i | RA | 09.2005 | | 24.0711-5280.3 | 360275 | WHEEL SPEED SENSOR | 34 52 6 762 476 , 34 52 6 785 022 | 24.0711-5191.3 |
| 1 series/E82 Coupe (07-) | 123 d | RA | 10.2007 | | 24.0711-5280.3 | 360275 | WHEEL SPEED SENSOR | 34 52 6 762 476 , 34 52 6 785 022 | 24.0711-5191.3 |
| | 135 i | RA | 10.2007 | | 24.0711-5280.3 | 360275 | WHEEL SPEED SENSOR | 34 52 6 762 476 , 34 52 6 785 022 | 24.0711-5191.3 |
| 1 series/E88 Convertible (08-) | 123 d | RA | 09.2008 | | 24.0711-5280.3 | 360275 | WHEEL SPEED SENSOR | 34 52 6 762 476 , 34 52 6 785 022 | 24.0711-5191.3 |
| | 135 i | RA | 03.2008 | | 24.0711-5280.3 | 360275 | WHEEL SPEED SENSOR | 34 52 6 762 476 , 34 52 6 785 022 | 24.0711-5191.3 |
| 3 series/E90 Saloon (05-) | 325 d | RA | 09.2006 | | 24.0711-5280.3 | 360275 | WHEEL SPEED SENSOR | 34 52 6 762 476 , 34 52 6 785 022 | 24.0711-5191.3 |
| | 325 i | RA | 12.2004 | | 24.0711-5280.3 | 360275 | WHEEL SPEED SENSOR | 34 52 6 762 476 , 34 52 6 785 022 | 24.0711-5191.3 |
| | 330 d | RA | 09.2005 | | 24.0711-5280.3 | 360275 | WHEEL SPEED SENSOR | 34 52 6 762 476 , 34 52 6 785 022 | 24.0711-5191.3 |
| | | RA | 09.2008 | | 24.0711-5280.3 | 360275 | WHEEL SPEED SENSOR | 34 52 6 762 476 , 34 52 6 785 022 | 24.0711-5191.3 |
| | 330 i | RA | 09.2007 | | 24.0711-5280.3 | 360275 | WHEEL SPEED SENSOR | 34 52 6 762 476 , 34 52 6 785 022 | 24.0711-5191.3 |
| | | RA | 12.2004 | 08.2007 | 24.0711-5280.3 | 360275 | WHEEL SPEED SENSOR | 34 52 6 762 476 , 34 52 6 785 022 | 24.0711-5191.3 |
| | 335 d | RA | 09.2006 | | 24.0711-5280.3 | 360275 | WHEEL SPEED SENSOR | 34 52 6 762 476 , 34 52 6 785 022 | 24.0711-5191.3 |

New partnumbers on stock - according to applications

04/2011



| | | | | | | | |
|---|---|---|---|---|--------------------|-------------------------------|---|
|  |  |  |  |  | Description | OE numbers per ATE pn. |  e.g. replaced pn. / miscellaneous |
|---|---|---|---|---|--------------------|-------------------------------|---|







BMW

| | | | | | | | | | |
|----------------------------|-------|----|---------|---------|----------------|--------|--------------------|-----------------------------------|----------------|
| 3 series/E90 Saloon (05-) | 335 i | RA | 09.2006 | | 24.0711-5280.3 | 360275 | WHEEL SPEED SENSOR | 34 52 6 762 476 , 34 52 6 785 022 | 24.0711-5191.3 |
| | M3 | RA | 12.2007 | | 24.0711-5280.3 | 360275 | WHEEL SPEED SENSOR | 34 52 6 762 476 , 34 52 6 785 022 | 24.0711-5191.3 |
| 3 series/E91 Touring (05-) | 323 i | RA | 06.2005 | | 24.0711-5280.3 | 360275 | WHEEL SPEED SENSOR | 34 52 6 762 476 , 34 52 6 785 022 | 24.0711-5191.3 |
| | 325 d | RA | 09.2006 | | 24.0711-5280.3 | 360275 | WHEEL SPEED SENSOR | 34 52 6 762 476 , 34 52 6 785 022 | 24.0711-5191.3 |
| | 325 i | RA | 06.2005 | | 24.0711-5280.3 | 360275 | WHEEL SPEED SENSOR | 34 52 6 762 476 , 34 52 6 785 022 | 24.0711-5191.3 |
| | 330 d | RA | 06.2005 | | 24.0711-5280.3 | 360275 | WHEEL SPEED SENSOR | 34 52 6 762 476 , 34 52 6 785 022 | 24.0711-5191.3 |
| | | RA | 09.2008 | | 24.0711-5280.3 | 360275 | WHEEL SPEED SENSOR | 34 52 6 762 476 , 34 52 6 785 022 | 24.0711-5191.3 |
| | 330 i | RA | 06.2005 | 08.2007 | 24.0711-5280.3 | 360275 | WHEEL SPEED SENSOR | 34 52 6 762 476 , 34 52 6 785 022 | 24.0711-5191.3 |
| | | RA | 09.2007 | | 24.0711-5280.3 | 360275 | WHEEL SPEED SENSOR | 34 52 6 762 476 , 34 52 6 785 022 | 24.0711-5191.3 |
| | 335 d | RA | 09.2006 | | 24.0711-5280.3 | 360275 | WHEEL SPEED SENSOR | 34 52 6 762 476 , 34 52 6 785 022 | 24.0711-5191.3 |
| | 335 i | RA | 09.2006 | | 24.0711-5280.3 | 360275 | WHEEL SPEED SENSOR | 34 52 6 762 476 , 34 52 6 785 022 | 24.0711-5191.3 |
| 3 series/E92 Coupe (06-) | 325 d | RA | 03.2007 | | 24.0711-5280.3 | 360275 | WHEEL SPEED SENSOR | 34 52 6 762 476 , 34 52 6 785 022 | 24.0711-5191.3 |
| | 330 d | RA | 09.2008 | | 24.0711-5280.3 | 360275 | WHEEL SPEED SENSOR | 34 52 6 762 476 , 34 52 6 785 022 | 24.0711-5191.3 |

New partnumbers on stock - according to applications

04/2011



| | | | | | | | |
|---|---|---|---|---|--------------------|-------------------------------|---|
|  |  |  |  |  | Description | OE numbers per ATE pn. |  e.g. replaced pn. / miscellaneous |
|---|---|---|---|---|--------------------|-------------------------------|---|







BMW

| | | | | | | | | | |
|--------------------------------|------------|----|---------|--|----------------|--------|--------------------|-----------------------------------|----------------|
| 3 series/E92 Coupe (06-) | 330 d | RA | 09.2006 | | 24.0711-5280.3 | 360275 | WHEEL SPEED SENSOR | 34 52 6 762 476 , 34 52 6 785 022 | 24.0711-5191.3 |
| | 330 i | RA | 09.2006 | | 24.0711-5280.3 | 360275 | WHEEL SPEED SENSOR | 34 52 6 762 476 , 34 52 6 785 022 | 24.0711-5191.3 |
| | 335 d | RA | 09.2006 | | 24.0711-5280.3 | 360275 | WHEEL SPEED SENSOR | 34 52 6 762 476 , 34 52 6 785 022 | 24.0711-5191.3 |
| | 335 i | RA | 09.2006 | | 24.0711-5280.3 | 360275 | WHEEL SPEED SENSOR | 34 52 6 762 476 , 34 52 6 785 022 | 24.0711-5191.3 |
| | M3 | RA | 03.2007 | | 24.0711-5280.3 | 360275 | WHEEL SPEED SENSOR | 34 52 6 762 476 , 34 52 6 785 022 | 24.0711-5191.3 |
| 3 series/E93 Convertible (07-) | 320 d | RA | 03.2008 | | 24.0711-5280.3 | 360275 | WHEEL SPEED SENSOR | 34 52 6 762 476 , 34 52 6 785 022 | 24.0711-5191.3 |
| | 325 d | RA | 09.2007 | | 24.0711-5280.3 | 360275 | WHEEL SPEED SENSOR | 34 52 6 762 476 , 34 52 6 785 022 | 24.0711-5191.3 |
| | 325 i | RA | 03.2007 | | 24.0711-5280.3 | 360275 | WHEEL SPEED SENSOR | 34 52 6 762 476 , 34 52 6 785 022 | 24.0711-5191.3 |
| | 330 d | RA | 03.2007 | | 24.0711-5280.3 | 360275 | WHEEL SPEED SENSOR | 34 52 6 762 476 , 34 52 6 785 022 | 24.0711-5191.3 |
| | 330 i | RA | 03.2007 | | 24.0711-5280.3 | 360275 | WHEEL SPEED SENSOR | 34 52 6 762 476 , 34 52 6 785 022 | 24.0711-5191.3 |
| | 335 i | RA | 03.2007 | | 24.0711-5280.3 | 360275 | WHEEL SPEED SENSOR | 34 52 6 762 476 , 34 52 6 785 022 | 24.0711-5191.3 |
| | M3 | RA | 03.2008 | | 24.0711-5280.3 | 360275 | WHEEL SPEED SENSOR | 34 52 6 762 476 , 34 52 6 785 022 | 24.0711-5191.3 |
| X3 (10-) | xDrive 20d | FL | 09.2010 | | 24.8190-0309.2 | 620309 | WEAR INDICATOR | 34 35 6 790 303 | |
| | | | 09.2010 | | 24.8190-0310.2 | 620310 | WEAR INDICATOR | 34 35 6 790 304 | |

New partnumbers on stock - according to applications

04/2011



| | | | | | | | |
|---|---|---|---|---|--------------------|-------------------------------|---|
|  |  |  |  |  | Description | OE numbers per ATE pn. |  e.g. replaced pn. / miscellaneous |
|---|---|---|---|---|--------------------|-------------------------------|---|

BMW

| | | | | | | | | | |
|-------------------------|------------|----|---------|---------|----------------|--------|--------------------|-----------------|--|
| X3 (10-) | xDrive 28i | FL | 09.2010 | | 24.8190-0309.2 | 620309 | WEAR INDICATOR | 34 35 6 790 303 | |
| | | | 09.2010 | | 24.8190-0310.2 | 620310 | WEAR INDICATOR | 34 35 6 790 304 | |
| | xDrive 35i | FL | 09.2010 | | 24.8190-0309.2 | 620309 | WEAR INDICATOR | 34 35 6 790 303 | |
| | | | 09.2010 | | 24.8190-0310.2 | 620310 | WEAR INDICATOR | 34 35 6 790 304 | |
| Z4 Roadster/E85 (03-08) | 2,0 i | | 04.2005 | 12.2008 | 03.2023-2249.3 | 010869 | TANDEM MASTER CYL. | 34 31 6 763 670 | |
| | 2,2 i | | 10.2003 | 12.2008 | 03.2023-2249.3 | 010869 | TANDEM MASTER CYL. | 34 31 6 763 670 | |
| | 2,5 i | | 12.2002 | 12.2008 | 03.2023-2249.3 | 010869 | TANDEM MASTER CYL. | 34 31 6 763 670 | |
| | 3,0 i | | 12.2002 | 12.2008 | 03.2023-2249.3 | 010869 | TANDEM MASTER CYL. | 34 31 6 763 670 | |

CHEVROLET

| | | | | | | | | | |
|---------------|-----------|--|---------|--|----------------|--------|------------|---------------------|-------------|
| CRUZE (09-) | 1,6 i 16V | | 05.2009 | | 13.0460-7262.2 | 607262 | BRAKE PADS | 13301207 , 5 42 120 | see drawing |
| | | | 05.2009 | | 13.0460-7263.2 | 607263 | BRAKE PADS | 13301234 , 5 42 115 | see drawing |
| | 1,8 i 16V | | 05.2009 | | 13.0460-7262.2 | 607262 | BRAKE PADS | 13301207 , 5 42 120 | see drawing |
| | | | 05.2009 | | 13.0460-7263.2 | 607263 | BRAKE PADS | 13301234 , 5 42 115 | see drawing |
| | 2,0 CDI | | 05.2009 | | 13.0460-7262.2 | 607262 | BRAKE PADS | 13301207 , 5 42 120 | see drawing |
| | | | 05.2009 | | 13.0460-7263.2 | 607263 | BRAKE PADS | 13301234 , 5 42 115 | see drawing |
| ORLANDO (11-) | 1,8 | | 02.2011 | | 13.0460-7263.2 | 607263 | BRAKE PADS | 13301234 , 5 42 115 | see drawing |
| | 2,0 D | | 02.2011 | | 13.0460-7263.2 | 607263 | BRAKE PADS | 13301234 , 5 42 115 | see drawing |

New partnumbers on stock - according to applications

04/2011



| | | | | | | | |
|--|--|---|---|--|-------------|------------------------|-----------------------------------|
| | | | | | Description | OE numbers per ATE pn. | |
| | | ← | → | | | | e.g. replaced pn. / miscellaneous |

CITROEN

| | | | | | | | | | |
|--------------------------|-----------------|--|---------|--|----------------|--------|------------------|---|--|
| C5 III Estate (X7) (08-) | 1,6 16V | | 04.2009 | | 24.0101-3803.2 | 260101 | INSTALLATION KIT | 4439 36 , 001 421 04 86 , 34 21 6 772 867 , 93179160 , 54 23 93 | |
| | 1,6 HDi | | 02.2008 | | 24.0101-3803.2 | 260101 | INSTALLATION KIT | 4439 36 , 001 421 04 86 , 34 21 6 772 867 , 93179160 , 54 23 93 | |
| | 1,8 16V | | 02.2008 | | 24.0101-3803.2 | 260101 | INSTALLATION KIT | 4439 36 , 001 421 04 86 , 34 21 6 772 867 , 93179160 , 54 23 93 | |
| | 2,0 16V | | 02.2008 | | 24.0101-3803.2 | 260101 | INSTALLATION KIT | 4439 36 , 001 421 04 86 , 34 21 6 772 867 , 93179160 , 54 23 93 | |
| | 2,0 16V BioFlex | | 02.2008 | | 24.0101-3803.2 | 260101 | INSTALLATION KIT | 4439 36 , 001 421 04 86 , 34 21 6 772 867 , 93179160 , 54 23 93 | |
| | 2,0 HDi | | 02.2008 | | 24.0101-3803.2 | 260101 | INSTALLATION KIT | 4439 36 , 001 421 04 86 , 34 21 6 772 867 , 93179160 , 54 23 93 | |
| | | | 04.2009 | | 24.0101-3803.2 | 260101 | INSTALLATION KIT | 4439 36 , 001 421 04 86 , 34 21 6 772 867 , 93179160 , 54 23 93 | |
| | 2,0 HDi 140 FAP | | 11.2008 | | 24.0101-3803.2 | 260101 | INSTALLATION KIT | 4439 36 , 001 421 04 86 , 34 21 6 772 867 , 93179160 , 54 23 93 | |
| | 2,2 HDi 170 | | 02.2008 | | 24.0101-3803.2 | 260101 | INSTALLATION KIT | 4439 36 , 001 421 04 86 , 34 21 6 772 867 , 93179160 , 54 23 93 | |
| | 2,7 HDi V6 | | 02.2008 | | 24.0101-3803.2 | 260101 | INSTALLATION KIT | 4439 36 , 001 421 04 86 , 34 21 6 772 867 , 93179160 , 54 23 93 | |

New partnumbers on stock - according to applications

04/2011



| | | | | | | | |
|--|----------|--|--|--|--------------------|-------------------------------|---|
| | i | | | | Description | OE numbers per ATE pn. | i e.g. replaced pn. / miscellaneous |
|--|----------|--|--|--|--------------------|-------------------------------|---|





CITROEN

| | | | | | | | | | |
|--------------------------|-----------------|--|---------|--|----------------|--------|------------------|---|--|
| C5 III Estate (X7) (08-) | 3 | | 02.2008 | | 24.0101-3803.2 | 260101 | INSTALLATION KIT | 4439 36 , 001 421 04 86 , 34 21 6 772 867 , 93179160 , 54 23 93 | |
| | 3,0 HDi | | 04.2009 | | 24.0101-3803.2 | 260101 | INSTALLATION KIT | 4439 36 , 001 421 04 86 , 34 21 6 772 867 , 93179160 , 54 23 93 | |
| | 3,0 V6 | | 02.2008 | | 24.0101-3803.2 | 260101 | INSTALLATION KIT | 4439 36 , 001 421 04 86 , 34 21 6 772 867 , 93179160 , 54 23 93 | |
| C5 III Saloon (X7) (08-) | 1,6 16V | | 04.2009 | | 24.0101-3803.2 | 260101 | INSTALLATION KIT | 4439 36 , 001 421 04 86 , 34 21 6 772 867 , 93179160 , 54 23 93 | |
| | 1,6 HDi | | 02.2008 | | 24.0101-3803.2 | 260101 | INSTALLATION KIT | 4439 36 , 001 421 04 86 , 34 21 6 772 867 , 93179160 , 54 23 93 | |
| | 1,8 i 16V | | 02.2008 | | 24.0101-3803.2 | 260101 | INSTALLATION KIT | 4439 36 , 001 421 04 86 , 34 21 6 772 867 , 93179160 , 54 23 93 | |
| | 2,0 16V BioFlex | | 02.2008 | | 24.0101-3803.2 | 260101 | INSTALLATION KIT | 4439 36 , 001 421 04 86 , 34 21 6 772 867 , 93179160 , 54 23 93 | |
| | 2,0 HDi | | 02.2008 | | 24.0101-3803.2 | 260101 | INSTALLATION KIT | 4439 36 , 001 421 04 86 , 34 21 6 772 867 , 93179160 , 54 23 93 | |
| | | | 04.2009 | | 24.0101-3803.2 | 260101 | INSTALLATION KIT | 4439 36 , 001 421 04 86 , 34 21 6 772 867 , 93179160 , 54 23 93 | |
| | 2,0 HDi 140 FAP | | 11.2008 | | 24.0101-3803.2 | 260101 | INSTALLATION KIT | 4439 36 , 001 421 04 86 , 34 21 6 772 867 , 93179160 , 54 23 93 | |

New partnumbers on stock - according to applications

04/2011



| | | | | | | | |
|---|---|---|---|---|--------------------|-------------------------------|---|
|  |  |  |  |  | Description | OE numbers per ATE pn. |  e.g. replaced pn. / miscellaneous |
|---|---|---|---|---|--------------------|-------------------------------|---|

CITROEN

| | | | | | | | | | |
|--------------------------|--------------------|--|---------|--|----------------|--------|------------------|---|--|
| C5 III Saloon (X7) (08-) | 2,0 i 16V | | 02.2008 | | 24.0101-3803.2 | 260101 | INSTALLATION KIT | 4439 36 , 001 421 04 86 , 34 21 6 772 867 , 93179160 , 54 23 93 | |
| | 2,2 HDi 170 | | 02.2008 | | 24.0101-3803.2 | 260101 | INSTALLATION KIT | 4439 36 , 001 421 04 86 , 34 21 6 772 867 , 93179160 , 54 23 93 | |
| | 2,7 HDi | | 02.2008 | | 24.0101-3803.2 | 260101 | INSTALLATION KIT | 4439 36 , 001 421 04 86 , 34 21 6 772 867 , 93179160 , 54 23 93 | |
| | 3 | | 02.2008 | | 24.0101-3803.2 | 260101 | INSTALLATION KIT | 4439 36 , 001 421 04 86 , 34 21 6 772 867 , 93179160 , 54 23 93 | |
| | 3,0 HDi | | 04.2009 | | 24.0101-3803.2 | 260101 | INSTALLATION KIT | 4439 36 , 001 421 04 86 , 34 21 6 772 867 , 93179160 , 54 23 93 | |
| | 3,0 i V6 | | 02.2008 | | 24.0101-3803.2 | 260101 | INSTALLATION KIT | 4439 36 , 001 421 04 86 , 34 21 6 772 867 , 93179160 , 54 23 93 | |
| C6 (05-) | 2,2 HDi | | 06.2006 | | 24.0101-3802.2 | 260100 | INSTALLATION KIT | 4439 36 , 77363365 , 169 421 01 86 , 4439 34 , 4439 44 | |
| | 2,7 V6 HDi Biturbo | | 09.2005 | | 24.0101-3802.2 | 260100 | INSTALLATION KIT | 4439 36 , 77363365 , 169 421 01 86 , 4439 34 , 4439 44 | |
| | 3,0 V6 | | 09.2005 | | 24.0101-3802.2 | 260100 | INSTALLATION KIT | 4439 36 , 77363365 , 169 421 01 86 , 4439 34 , 4439 44 | |
| | 3,0 V6 HDi | | 07.2009 | | 24.0101-3802.2 | 260100 | INSTALLATION KIT | 4439 36 , 77363365 , 169 421 01 86 , 4439 34 , 4439 44 | |



| | | | | | | | |
|--|----------|--|--|--|--------------------|-------------------------------|---|
| | i | | | | Description | OE numbers per ATE pn. | i e.g. replaced pn. / miscellaneous |
|--|----------|--|--|--|--------------------|-------------------------------|---|

Classic PKW

| | | | | | | | | | |
|---|---------------------|--|--|---------|----------------|--------|------------|---------------|--|
| RENAULT TRAFIC I PROPULSION (PXX) (81-89) | 1,7 (P3--) | | | 04.1989 | 24.0225-4019.1 | 480305 | BRAKE DRUM | 77 00 692 363 | |
| | 2,0 (P3--) Kastenw, | | | 04.1989 | 24.0225-4019.1 | 480305 | BRAKE DRUM | 77 00 692 363 | |
| | 2,1 D (P3--) | | | 04.1989 | 24.0225-4019.1 | 480305 | BRAKE DRUM | 77 00 692 363 | |







FORD

| | | | | | | | | | |
|-----------------|--------------|----|---------|---------|----------------|--------|--------------|-------------------------|--|
| FOCUS I (98-04) | 1,4 i 16V | FL | 10.1998 | 09.2004 | 24.3541-8105.5 | 240485 | FIST CALIPER | 1075789 , 98AB-2L232-BB | |
| | 1,6 i 16V | FL | 10.1998 | 09.2004 | 24.3541-8105.5 | 240485 | FIST CALIPER | 1075789 , 98AB-2L232-BB | |
| | 1,8 i 16V | FL | 10.1998 | 09.2004 | 24.3541-8105.5 | 240485 | FIST CALIPER | 1075789 , 98AB-2L232-BB | |
| | 1,8 TDCi | FL | 03.2001 | 09.2004 | 24.3541-8105.5 | 240485 | FIST CALIPER | 1075789 , 98AB-2L232-BB | |
| | 1,8 Turbo DI | FL | 10.1998 | 09.2004 | 24.3541-8105.5 | 240485 | FIST CALIPER | 1075789 , 98AB-2L232-BB | |
| | 2,0 i 16V | FL | 10.1998 | 09.2004 | 24.3541-8105.5 | 240485 | FIST CALIPER | 1075789 , 98AB-2L232-BB | |

New partnumbers on stock - according to applications

04/2011



| | | | | | | | |
|---|---|---|---|---|--------------------|-------------------------------|---|
|  |  |  |  |  | Description | OE numbers per ATE pn. |  e.g. replaced pn. / miscellaneous |
|---|---|---|---|---|--------------------|-------------------------------|---|

HYUNDAI

| | | | | | | | | | |
|------------------|-----------------|--|---------|---------|----------------|--------|------------|-------------|--|
| GRANDEUR (05-) | 2,2 CRDi | | 06.2006 | | 24.0110-0336.1 | 410336 | BRAKE DISC | 58411-3L000 | |
| | 2,7 i V6 | | 06.2006 | | 24.0110-0336.1 | 410336 | BRAKE DISC | 58411-3L000 | |
| | 3,3 i V6 | | 04.2005 | | 24.0110-0336.1 | 410336 | BRAKE DISC | 58411-3L000 | |
| TERRACAN (01-07) | 2,5 TDiC | | 11.2003 | 12.2007 | 24.0128-0224.1 | 428224 | BRAKE DISC | 51712-H1030 | |
| | 2,5 TDiC 4WD | | 11.2003 | 12.2007 | 24.0128-0224.1 | 428224 | BRAKE DISC | 51712-H1030 | |
| | 2,9 CRDi 4WD | | 11.2003 | 12.2007 | 24.0128-0224.1 | 428224 | BRAKE DISC | 51712-H1030 | |
| | 3,5 i V6 4WD | | 11.2003 | 12.2007 | 24.0128-0224.1 | 428224 | BRAKE DISC | 51712-H1030 | |
| XG (05-) | 2,7 i V6 (XG50) | | 05.2006 | | 24.0110-0336.1 | 410336 | BRAKE DISC | 58411-3L000 | |
| | 3,3 i V6 (XG50) | | 06.2005 | | 24.0110-0336.1 | 410336 | BRAKE DISC | 58411-3L000 | |







KIA

| | | | | | | | | | |
|--------------|----------|--|---------|---------|----------------|--------|------------|-------------|--|
| OPIRUS (03-) | 2,7 i V6 | | 10.2006 | 08.2007 | 24.0110-0336.1 | 410336 | BRAKE DISC | 58411-3L000 | |
| | 3,3 i V6 | | 10.2006 | 08.2007 | 24.0110-0336.1 | 410336 | BRAKE DISC | 58411-3L000 | |
| | 3,8 i V6 | | 10.2006 | 08.2007 | 24.0110-0336.1 | 410336 | BRAKE DISC | 58411-3L000 | |

LANCIA

| | | | | | | | | | |
|---------------|-------|--|---------|--|----------------|--------|------------------|---|--|
| YPSILON (03-) | 1,2 i | | 08.2006 | | 24.0101-3802.2 | 260100 | INSTALLATION KIT | 4439 36 , 77363365 , 169 421 01 86 , 4439 34 , 4439 44 | |
| | 1,4 i | | 08.2006 | | 24.0101-3802.2 | 260100 | INSTALLATION KIT | 4439 36 , 77363365 , 169 421 01 86 , 4439 34 , 4439 44 | |



| | | | | | | | |
|---|---|---|---|---|--------------------|-------------------------------|---|
|  |  |  |  |  | Description | OE numbers per ATE pn. |  e.g. replaced pn. / miscellaneous |
|---|---|---|---|---|--------------------|-------------------------------|---|







LEXUS

| Model | Engine | Year | Part Number | Description | OE numbers | Notes |
|--------------|----------------------|---------|----------------|-------------|------------|-------------------------|
| LS 460 (06-) | 4,6 VVTi (USF40/41) | 04.2006 | 13.0460-5607.2 | BRAKE PADS | 605607 | 04465-0W110 see drawing |
| | | 05.2008 | 13.0460-5607.2 | BRAKE PADS | 605607 | 04465-0W110 see drawing |
| | 4,6 VVTi AWD (USF45) | 12.2008 | 13.0460-5607.2 | BRAKE PADS | 605607 | 04465-0W110 see drawing |
| LS 600 (07-) | 5,0 VVTi Hybrid | 04.2007 | 13.0460-5607.2 | BRAKE PADS | 605607 | 04465-0W110 see drawing |

New partnumbers on stock - according to applications

04/2011



| | | | | | | |
|---|---|---|---|--------------------|-------------------------------|---|
|  |  |   |  | Description | OE numbers per ATE pn. |  e.g. replaced pn. / miscellaneous |
|---|---|---|---|--------------------|-------------------------------|---|







MERCEDES BENZ

| A-Class (W169) (04-) | A 150 / A 160 | | | | 24.0101-3802.2 | 260100 | INSTALLATION KIT | 4439 36 , 77363365 , 169 421 01 86 , 4439 34 , 4439 44 | |
|-----------------------|---------------|--|---------|--|----------------|--------|------------------|---|--|
| | | | 08.2004 | | 24.0101-3802.2 | 260100 | INSTALLATION KIT | 4439 36 , 77363365 , 169 421 01 86 , 4439 34 , 4439 44 | |
| | | | 08.2004 | | 24.0101-3802.2 | 260100 | INSTALLATION KIT | 4439 36 , 77363365 , 169 421 01 86 , 4439 34 , 4439 44 | |
| | | | | | 24.0101-3802.2 | 260100 | INSTALLATION KIT | 4439 36 , 77363365 , 169 421 01 86 , 4439 34 , 4439 44 | |
| | A 160 CDI | | 08.2004 | | 24.0101-3802.2 | 260100 | INSTALLATION KIT | 4439 36 , 77363365 , 169 421 01 86 , 4439 34 , 4439 44 | |
| | | | 08.2004 | | 24.0101-3802.2 | 260100 | INSTALLATION KIT | 4439 36 , 77363365 , 169 421 01 86 , 4439 34 , 4439 44 | |
| | | | | | 24.0101-3802.2 | 260100 | INSTALLATION KIT | 4439 36 , 77363365 , 169 421 01 86 , 4439 34 , 4439 44 | |
| | | | | | 24.0101-3802.2 | 260100 | INSTALLATION KIT | 4439 36 , 77363365 , 169 421 01 86 , 4439 34 , 4439 44 | |
| | A 170 | | | | 24.0101-3802.2 | 260100 | INSTALLATION KIT | 4439 36 , 77363365 , 169 421 01 86 , 4439 34 , 4439 44 | |
| | | | 08.2004 | | 24.0101-3802.2 | 260100 | INSTALLATION KIT | 4439 36 , 77363365 , 169 421 01 86 , 4439 34 , 4439 44 | |
| | | | 08.2004 | | 24.0101-3802.2 | 260100 | INSTALLATION KIT | 4439 36 , 77363365 , 169 421 01 86 , 4439 34 , 4439 44 | |
| | A 180 | | | | 24.0101-3802.2 | 260100 | INSTALLATION KIT | 4439 36 , 77363365 , 169 421 01 86 , 4439 34 , 4439 44 | |
| | | | 04.2009 | | 24.0101-3802.2 | 260100 | INSTALLATION KIT | 4439 36 , 77363365 , 169 421 01 86 , 4439 34 , 4439 44 | |

New partnumbers on stock - according to applications

04/2011



| | | | | | | |
|---|---|---|---|--------------------|-------------------------------|---|
|  |  |   |  | Description | OE numbers per ATE pn. |  e.g. replaced pn. / miscellaneous |
|---|---|---|---|--------------------|-------------------------------|---|

MERCEDES BENZ

| A-Class (W169) (04-) | A 180 | | 04.2009 | | 24.0101-3802.2 | 260100 | INSTALLATION KIT | 4439 36 , 77363365 , 169 421 01 86 , 4439 34 , 4439 44 | |
|-----------------------|-------------|--|---------|--|----------------|--------|------------------|---|--|
| | A 180 CDI | | 08.2004 | | 24.0101-3802.2 | 260100 | INSTALLATION KIT | 4439 36 , 77363365 , 169 421 01 86 , 4439 34 , 4439 44 | |
| | | | 08.2004 | | 24.0101-3802.2 | 260100 | INSTALLATION KIT | 4439 36 , 77363365 , 169 421 01 86 , 4439 34 , 4439 44 | |
| | | | | | 24.0101-3802.2 | 260100 | INSTALLATION KIT | 4439 36 , 77363365 , 169 421 01 86 , 4439 34 , 4439 44 | |
| | A 200 | | 08.2004 | | 24.0101-3802.2 | 260100 | INSTALLATION KIT | 4439 36 , 77363365 , 169 421 01 86 , 4439 34 , 4439 44 | |
| | | | 08.2004 | | 24.0101-3802.2 | 260100 | INSTALLATION KIT | 4439 36 , 77363365 , 169 421 01 86 , 4439 34 , 4439 44 | |
| | | | | | 24.0101-3802.2 | 260100 | INSTALLATION KIT | 4439 36 , 77363365 , 169 421 01 86 , 4439 34 , 4439 44 | |
| | A 200 CDI | | | | 24.0101-3802.2 | 260100 | INSTALLATION KIT | 4439 36 , 77363365 , 169 421 01 86 , 4439 34 , 4439 44 | |
| | | | 08.2004 | | 24.0101-3802.2 | 260100 | INSTALLATION KIT | 4439 36 , 77363365 , 169 421 01 86 , 4439 34 , 4439 44 | |
| | | | 08.2004 | | 24.0101-3802.2 | 260100 | INSTALLATION KIT | 4439 36 , 77363365 , 169 421 01 86 , 4439 34 , 4439 44 | |
| | A 200 Turbo | | 03.2005 | | 24.0101-3802.2 | 260100 | INSTALLATION KIT | 4439 36 , 77363365 , 169 421 01 86 , 4439 34 , 4439 44 | |
| | | | 03.2005 | | 24.0101-3802.2 | 260100 | INSTALLATION KIT | 4439 36 , 77363365 , 169 421 01 86 , 4439 34 , 4439 44 | |
| | | | | | 24.0101-3802.2 | 260100 | INSTALLATION KIT | 4439 36 , 77363365 , 169 421 01 86 , 4439 34 , 4439 44 | |

New partnumbers on stock - according to applications

04/2011



| | | | | | | | |
|--|--|--|--|--|--------------------|-------------------------------|---------------------------------------|
| | | | | | Description | OE numbers per ATE pn. | e.g. replaced pn. / miscellaneous |
|--|--|--|--|--|--------------------|-------------------------------|---------------------------------------|

MERCEDES BENZ

| Model | Engine | Start | End | ATE PN | ATE PN | Description | OE numbers | Notes |
|----------------------|---------------|---------|---------|----------------|--------|------------------|---|-------|
| B-Class (W245) (05-) | B 150 / B 160 | 04.2005 | | 24.0101-3802.2 | 260100 | INSTALLATION KIT | 4439 36 , 77363365 , 169 421 01 86 , 4439 34 , 4439 44 | |
| | | 04.2005 | | 24.0101-3802.2 | 260100 | INSTALLATION KIT | 4439 36 , 77363365 , 169 421 01 86 , 4439 34 , 4439 44 | |
| | B 170 / B 180 | 04.2005 | | 24.0101-3802.2 | 260100 | INSTALLATION KIT | 4439 36 , 77363365 , 169 421 01 86 , 4439 34 , 4439 44 | |
| | | 04.2005 | | 24.0101-3802.2 | 260100 | INSTALLATION KIT | 4439 36 , 77363365 , 169 421 01 86 , 4439 34 , 4439 44 | |
| | B 170 NGT | 04.2008 | 04.2009 | 24.0101-3802.2 | 260100 | INSTALLATION KIT | 4439 36 , 77363365 , 169 421 01 86 , 4439 34 , 4439 44 | |
| | | 04.2008 | 04.2009 | 24.0101-3802.2 | 260100 | INSTALLATION KIT | 4439 36 , 77363365 , 169 421 01 86 , 4439 34 , 4439 44 | |
| | B 180 CDI | 04.2005 | | 24.0101-3802.2 | 260100 | INSTALLATION KIT | 4439 36 , 77363365 , 169 421 01 86 , 4439 34 , 4439 44 | |
| | | 04.2005 | | 24.0101-3802.2 | 260100 | INSTALLATION KIT | 4439 36 , 77363365 , 169 421 01 86 , 4439 34 , 4439 44 | |
| | B 180 NGT | 04.2009 | | 24.0101-3802.2 | 260100 | INSTALLATION KIT | 4439 36 , 77363365 , 169 421 01 86 , 4439 34 , 4439 44 | |
| | | 04.2009 | | 24.0101-3802.2 | 260100 | INSTALLATION KIT | 4439 36 , 77363365 , 169 421 01 86 , 4439 34 , 4439 44 | |
| | B 200 | 04.2005 | | 24.0101-3802.2 | 260100 | INSTALLATION KIT | 4439 36 , 77363365 , 169 421 01 86 , 4439 34 , 4439 44 | |
| | | 04.2005 | | 24.0101-3802.2 | 260100 | INSTALLATION KIT | 4439 36 , 77363365 , 169 421 01 86 , 4439 34 , 4439 44 | |
| | B 200 CDI | 04.2005 | | 24.0101-3802.2 | 260100 | INSTALLATION KIT | 4439 36 , 77363365 , 169 421 01 86 , 4439 34 , 4439 44 | |

New partnumbers on stock - according to applications

04/2011



| | | | | | | | |
|--|----------|--|--|--|--------------------|-------------------------------|---|
| | i | | | | Description | OE numbers per ATE pn. | i e.g. replaced pn. / miscellaneous |
|--|----------|--|--|--|--------------------|-------------------------------|---|

MERCEDES BENZ

| Model | Engine | Start | End | ATE Part No. | ATE Part No. | Description | OE numbers | Notes |
|------------------------------------|----------------------|---------|---------|----------------|--------------|------------------|---|-------|
| B-Class (W245) (05-) | B 200 CDI | 04.2005 | | 24.0101-3802.2 | 260100 | INSTALLATION KIT | 4439 36 , 77363365 , 169 421 01 86 , 4439 34 , 4439 44 | |
| | B 200 Turbo | 04.2005 | | 24.0101-3802.2 | 260100 | INSTALLATION KIT | 4439 36 , 77363365 , 169 421 01 86 , 4439 34 , 4439 44 | |
| | | 04.2005 | | 24.0101-3802.2 | 260100 | INSTALLATION KIT | 4439 36 , 77363365 , 169 421 01 86 , 4439 34 , 4439 44 | |
| C-Class (CL203) Sportcoupe (01-08) | C 160 Kompressor | 04.2005 | 05.2008 | 24.0101-3803.2 | 260101 | INSTALLATION KIT | 4439 36 , 001 421 04 86 , 34 21 6 772 867 , 93179160 , 54 23 93 | |
| | C 180 | 03.2001 | 05.2008 | 24.0101-3803.2 | 260101 | INSTALLATION KIT | 4439 36 , 001 421 04 86 , 34 21 6 772 867 , 93179160 , 54 23 93 | |
| | C 180 Kompressor | 05.2002 | 05.2008 | 24.0101-3803.2 | 260101 | INSTALLATION KIT | 4439 36 , 001 421 04 86 , 34 21 6 772 867 , 93179160 , 54 23 93 | |
| | C 200 CDI | 07.2003 | 05.2008 | 24.0101-3803.2 | 260101 | INSTALLATION KIT | 4439 36 , 001 421 04 86 , 34 21 6 772 867 , 93179160 , 54 23 93 | |
| | C 200 CGI Kompressor | 07.2003 | 05.2008 | 24.0101-3803.2 | 260101 | INSTALLATION KIT | 4439 36 , 001 421 04 86 , 34 21 6 772 867 , 93179160 , 54 23 93 | |
| | C 200 Kompressor | 03.2001 | 05.2008 | 24.0101-3803.2 | 260101 | INSTALLATION KIT | 4439 36 , 001 421 04 86 , 34 21 6 772 867 , 93179160 , 54 23 93 | |
| | C 220 CDI | 03.2001 | 05.2008 | 24.0101-3803.2 | 260101 | INSTALLATION KIT | 4439 36 , 001 421 04 86 , 34 21 6 772 867 , 93179160 , 54 23 93 | |
| | C 230 Kompressor | 03.2001 | 05.2008 | 24.0101-3803.2 | 260101 | INSTALLATION KIT | 4439 36 , 001 421 04 86 , 34 21 6 772 867 , 93179160 , 54 23 93 | |

New partnumbers on stock - according to applications

04/2011



| | | | | | | | |
|--|--|--|--|--|--------------------|-------------------------------|--|
| | | | | | Description | OE numbers per ATE pn. | e.g. replaced pn. / miscellaneous |
|--|--|--|--|--|--------------------|-------------------------------|--|

MERCEDES BENZ

| | | | | | | | | | |
|-------------------------------|----------------------|--|---------|---------|----------------|--------|------------------|---|--|
| C-Class (CLC204) Coupe (08-) | CLC 180 Kompressor | | 05.2008 | | 24.0101-3803.2 | 260101 | INSTALLATION KIT | 4439 36 , 001 421 04 86 , 34 21 6 772 867 , 93179160 , 54 23 93 | |
| | CLC 200 CDI | | 05.2008 | | 24.0101-3803.2 | 260101 | INSTALLATION KIT | 4439 36 , 001 421 04 86 , 34 21 6 772 867 , 93179160 , 54 23 93 | |
| | CLC 200 Kompressor | | 05.2008 | | 24.0101-3803.2 | 260101 | INSTALLATION KIT | 4439 36 , 001 421 04 86 , 34 21 6 772 867 , 93179160 , 54 23 93 | |
| | CLC 220 CDI | | 05.2008 | | 24.0101-3803.2 | 260101 | INSTALLATION KIT | 4439 36 , 001 421 04 86 , 34 21 6 772 867 , 93179160 , 54 23 93 | |
| C-Class (S203) Estate (01-07) | C 180 | | 03.2001 | 09.2007 | 24.0101-3803.2 | 260101 | INSTALLATION KIT | 4439 36 , 001 421 04 86 , 34 21 6 772 867 , 93179160 , 54 23 93 | |
| | C 180 Kompressor | | 05.2002 | 09.2007 | 24.0101-3803.2 | 260101 | INSTALLATION KIT | 4439 36 , 001 421 04 86 , 34 21 6 772 867 , 93179160 , 54 23 93 | |
| | C 200 CDI | | 03.2001 | 09.2007 | 24.0101-3803.2 | 260101 | INSTALLATION KIT | 4439 36 , 001 421 04 86 , 34 21 6 772 867 , 93179160 , 54 23 93 | |
| | C 200 CGI Kompressor | | 07.2003 | 09.2007 | 24.0101-3803.2 | 260101 | INSTALLATION KIT | 4439 36 , 001 421 04 86 , 34 21 6 772 867 , 93179160 , 54 23 93 | |
| | C 200 Kompressor | | 03.2001 | 09.2007 | 24.0101-3803.2 | 260101 | INSTALLATION KIT | 4439 36 , 001 421 04 86 , 34 21 6 772 867 , 93179160 , 54 23 93 | |
| | C 220 CDI | | 03.2001 | 09.2007 | 24.0101-3803.2 | 260101 | INSTALLATION KIT | 4439 36 , 001 421 04 86 , 34 21 6 772 867 , 93179160 , 54 23 93 | |

New partnumbers on stock - according to applications

04/2011



| | | | | | | | |
|--|----------|--|--|--|--------------------|-------------------------------|---|
| | i | | | | Description | OE numbers per ATE pn. | i e.g. replaced pn. / miscellaneous |
|--|----------|--|--|--|--------------------|-------------------------------|---|

MERCEDES BENZ

| Model | Engine | Start | End | ATE Part No. | ATE Part No. | Description | OE numbers | Notes |
|--------------------------------------|----------------------|---------|---------|----------------|--------------|------------------|---|-------|
| C-Class (S203) Estate (01-07) | C 320 CDI | 02.2005 | 09.2007 | 24.0101-3803.2 | 260101 | INSTALLATION KIT | 4439 36 , 001 421 04 86 , 34 21 6 772 867 , 93179160 , 54 23 93 | |
| C-Class (W203) Saloon (00-07) | C 180 | 04.2000 | 04.2007 | 24.0101-3803.2 | 260101 | INSTALLATION KIT | 4439 36 , 001 421 04 86 , 34 21 6 772 867 , 93179160 , 54 23 93 | |
| | C 180 Kompressor | 05.2002 | 04.2007 | 24.0101-3803.2 | 260101 | INSTALLATION KIT | 4439 36 , 001 421 04 86 , 34 21 6 772 867 , 93179160 , 54 23 93 | |
| | C 200 CDI | 04.2000 | 04.2007 | 24.0101-3803.2 | 260101 | INSTALLATION KIT | 4439 36 , 001 421 04 86 , 34 21 6 772 867 , 93179160 , 54 23 93 | |
| | C 200 CGI Kompressor | 07.2003 | 04.2007 | 24.0101-3803.2 | 260101 | INSTALLATION KIT | 4439 36 , 001 421 04 86 , 34 21 6 772 867 , 93179160 , 54 23 93 | |
| | C 200 Kompressor | 04.2000 | 04.2007 | 24.0101-3803.2 | 260101 | INSTALLATION KIT | 4439 36 , 001 421 04 86 , 34 21 6 772 867 , 93179160 , 54 23 93 | |
| | C 220 CDI | 04.2000 | 04.2007 | 24.0101-3803.2 | 260101 | INSTALLATION KIT | 4439 36 , 001 421 04 86 , 34 21 6 772 867 , 93179160 , 54 23 93 | |
| | C 230 Kompressor | 02.2004 | 04.2007 | 24.0101-3803.2 | 260101 | INSTALLATION KIT | 4439 36 , 001 421 04 86 , 34 21 6 772 867 , 93179160 , 54 23 93 | |
| | C 320 CDI | 02.2005 | 04.2007 | 24.0101-3803.2 | 260101 | INSTALLATION KIT | 4439 36 , 001 421 04 86 , 34 21 6 772 867 , 93179160 , 54 23 93 | |
| CLK-Class (A209) Convertible (03-09) | CLK 200 CGI | 05.2003 | 12.2009 | 24.0101-3803.2 | 260101 | INSTALLATION KIT | 4439 36 , 001 421 04 86 , 34 21 6 772 867 , 93179160 , 54 23 93 | |

New partnumbers on stock - according to applications

04/2011



| | | | | | | | |
|--|--|--|--|--|--------------------|-------------------------------|--|
| | | | | | Description | OE numbers per ATE pn. | e.g. replaced pn. / miscellaneous |
|--|--|--|--|--|--------------------|-------------------------------|--|



MERCEDES BENZ

| | | | | | | | | | |
|-------------------------------------|--------------------|--|---------|---------|----------------|--------|------------------------|---|--|
| CLK-Class (C209) Coupe (02-09) | CLK 200 CGI | | 09.2002 | 04.2009 | 24.0101-3803.2 | 260101 | INSTALLATION KIT | 4439 36 , 001 421 04 86 , 34 21 6 772 867 , 93179160 , 54 23 93 | |
| | CLK 200 Kompressor | | 09.2002 | 04.2009 | 24.0101-3803.2 | 260101 | INSTALLATION KIT | 4439 36 , 001 421 04 86 , 34 21 6 772 867 , 93179160 , 54 23 93 | |
| | CLK 220 CDI | | 05.2005 | 04.2009 | 24.0101-3803.2 | 260101 | INSTALLATION KIT | 4439 36 , 001 421 04 86 , 34 21 6 772 867 , 93179160 , 54 23 93 | |
| SLK-Class (R171) (04-) | SLK 200 Kompressor | | 03.2004 | | 24.0101-3803.2 | 260101 | INSTALLATION KIT | 4439 36 , 001 421 04 86 , 34 21 6 772 867 , 93179160 , 54 23 93 | |
| Transporter (BM 906) SPRINTER (06-) | 509 CDI | | 04.2006 | | 03.0137-4008.2 | 654008 | BRAKE SHOE SET W. ACC. | 906 420 04 20 , 2E0 698 525 A | |
| | 511 CDI | | 04.2006 | | 03.0137-4008.2 | 654008 | BRAKE SHOE SET W. ACC. | 906 420 04 20 , 2E0 698 525 A | |
| | 515 CDI | | 04.2006 | | 03.0137-4008.2 | 654008 | BRAKE SHOE SET W. ACC. | 906 420 04 20 , 2E0 698 525 A | |
| | 518 CDI | | 04.2006 | | 03.0137-4008.2 | 654008 | BRAKE SHOE SET W. ACC. | 906 420 04 20 , 2E0 698 525 A | |
| | 524 | | 04.2006 | | 03.0137-4008.2 | 654008 | BRAKE SHOE SET W. ACC. | 906 420 04 20 , 2E0 698 525 A | |
| VANEO (BM414) (02-05) | 1,4 | | 06.2002 | 12.2005 | 24.0101-3803.2 | 260101 | INSTALLATION KIT | 4439 36 , 001 421 04 86 , 34 21 6 772 867 , 93179160 , 54 23 93 | |
| | 1,6 | | 02.2002 | 12.2005 | 24.0101-3803.2 | 260101 | INSTALLATION KIT | 4439 36 , 001 421 04 86 , 34 21 6 772 867 , 93179160 , 54 23 93 | |

New partnumbers on stock - according to applications

04/2011



| | | | | | | |
|---|---|---|---|--------------------|-------------------------------|---|
|  |  |   |  | Description | OE numbers per ATE pn. |  e.g. replaced pn. / miscellaneous |
|---|---|---|---|--------------------|-------------------------------|---|

MERCEDES BENZ

| | | | | | | | | | |
|-----------------------|---------|--|---------|---------|----------------|--------|------------------|---|--|
| VANEO (BM414) (02-05) | 1,7 CDI | | 02.2002 | 12.2005 | 24.0101-3803.2 | 260101 | INSTALLATION KIT | 4439 36 , 001 421 04 86 , 34 21 6 772 867 , 93179160 , 54 23 93 | |
| | 1,9 | | 02.2002 | 12.2005 | 24.0101-3803.2 | 260101 | INSTALLATION KIT | 4439 36 , 001 421 04 86 , 34 21 6 772 867 , 93179160 , 54 23 93 | |

New partnumbers on stock - according to applications

04/2011



| | | | | | | | |
|--|--|--|--|--|--------------------|-------------------------------|--|
| | | | | | Description | OE numbers per ATE pn. | e.g. replaced pn. / miscellaneous |
|--|--|--|--|--|--------------------|-------------------------------|--|

MINI

| | | | | | | | | | |
|-------------------|----------|--|---------|--|----------------|--------|------------------|---|--|
| R55 Clubman (07-) | Cooper | | 09.2007 | | 24.0101-3803.2 | 260101 | INSTALLATION KIT | 4439 36 , 001 421 04 86 , 34 21 6 772 867 , 93179160 , 54 23 93 | |
| | Cooper D | | 09.2007 | | 24.0101-3803.2 | 260101 | INSTALLATION KIT | 4439 36 , 001 421 04 86 , 34 21 6 772 867 , 93179160 , 54 23 93 | |
| | Cooper S | | 09.2007 | | 24.0101-3803.2 | 260101 | INSTALLATION KIT | 4439 36 , 001 421 04 86 , 34 21 6 772 867 , 93179160 , 54 23 93 | |
| | One | | 03.2010 | | 24.0101-3803.2 | 260101 | INSTALLATION KIT | 4439 36 , 001 421 04 86 , 34 21 6 772 867 , 93179160 , 54 23 93 | |
| | One D | | 03.2010 | | 24.0101-3803.2 | 260101 | INSTALLATION KIT | 4439 36 , 001 421 04 86 , 34 21 6 772 867 , 93179160 , 54 23 93 | |
| R56 (06-) | Cooper | | 03.2010 | | 24.0101-3803.2 | 260101 | INSTALLATION KIT | 4439 36 , 001 421 04 86 , 34 21 6 772 867 , 93179160 , 54 23 93 | |
| | | | 11.2006 | | 24.0101-3803.2 | 260101 | INSTALLATION KIT | 4439 36 , 001 421 04 86 , 34 21 6 772 867 , 93179160 , 54 23 93 | |
| | Cooper D | | 04.2007 | | 24.0101-3803.2 | 260101 | INSTALLATION KIT | 4439 36 , 001 421 04 86 , 34 21 6 772 867 , 93179160 , 54 23 93 | |
| | Cooper S | | 03.2010 | | 24.0101-3803.2 | 260101 | INSTALLATION KIT | 4439 36 , 001 421 04 86 , 34 21 6 772 867 , 93179160 , 54 23 93 | |
| | | | 11.2006 | | 24.0101-3803.2 | 260101 | INSTALLATION KIT | 4439 36 , 001 421 04 86 , 34 21 6 772 867 , 93179160 , 54 23 93 | |

New partnumbers on stock - according to applications

04/2011



| | | | | | | | |
|--|--|--|--|--|--------------------|-------------------------------|--|
| | | | | | Description | OE numbers per ATE pn. | e.g. replaced pn. / miscellaneous |
|--|--|--|--|--|--------------------|-------------------------------|--|

MINI

| | | | | | | | | | |
|-----------------------|--------------|--|---------|--|----------------|--------|------------------|---|--|
| R56 (06-) | One | | 03.2009 | | 24.0101-3803.2 | 260101 | INSTALLATION KIT | 4439 36 , 001 421 04 86 , 34 21 6 772 867 , 93179160 , 54 23 93 | |
| | | | 03.2010 | | 24.0101-3803.2 | 260101 | INSTALLATION KIT | 4439 36 , 001 421 04 86 , 34 21 6 772 867 , 93179160 , 54 23 93 | |
| | | | 04.2007 | | 24.0101-3803.2 | 260101 | INSTALLATION KIT | 4439 36 , 001 421 04 86 , 34 21 6 772 867 , 93179160 , 54 23 93 | |
| | One D | | 03.2010 | | 24.0101-3803.2 | 260101 | INSTALLATION KIT | 4439 36 , 001 421 04 86 , 34 21 6 772 867 , 93179160 , 54 23 93 | |
| R57 Convertible (09-) | Cooper | | 03.2010 | | 24.0101-3803.2 | 260101 | INSTALLATION KIT | 4439 36 , 001 421 04 86 , 34 21 6 772 867 , 93179160 , 54 23 93 | |
| | | | 01.2009 | | 24.0101-3803.2 | 260101 | INSTALLATION KIT | 4439 36 , 001 421 04 86 , 34 21 6 772 867 , 93179160 , 54 23 93 | |
| | Cooper D 1,6 | | 08.2010 | | 24.0101-3803.2 | 260101 | INSTALLATION KIT | 4439 36 , 001 421 04 86 , 34 21 6 772 867 , 93179160 , 54 23 93 | |
| | Cooper S | | 03.2010 | | 24.0101-3803.2 | 260101 | INSTALLATION KIT | 4439 36 , 001 421 04 86 , 34 21 6 772 867 , 93179160 , 54 23 93 | |
| | | | 01.2009 | | 24.0101-3803.2 | 260101 | INSTALLATION KIT | 4439 36 , 001 421 04 86 , 34 21 6 772 867 , 93179160 , 54 23 93 | |
| | One | | 03.2010 | | 24.0101-3803.2 | 260101 | INSTALLATION KIT | 4439 36 , 001 421 04 86 , 34 21 6 772 867 , 93179160 , 54 23 93 | |









| | | | | | | |
|--|--|--|--|--------------------|-------------------------------|---------------------------------------|
| | | | | Description | OE numbers per ATE pn. | e.g. replaced pn. / miscellaneous |
|--|--|--|--|--------------------|-------------------------------|---------------------------------------|

MITSUBISHI

| | | | | | | | | |
|------------|------------------|----|---------|----------------|--------|-----------------|----------|--|
| COLT (04-) | 1,1 i 12V (Z32A) | RR | 10.2004 | 24.3727-2113.2 | 582113 | HANDBRAKE CABLE | MR955256 | |
| | 1,3 i 16V (Z34A) | RR | 06.2004 | 24.3727-2113.2 | 582113 | HANDBRAKE CABLE | MR955256 | |
| | 1,5 DI-D (Z38A) | RR | 08.2004 | 24.3727-2113.2 | 582113 | HANDBRAKE CABLE | MR955256 | |
| | 1,5 DI-D (Z39A) | RR | 08.2004 | 24.3727-2113.2 | 582113 | HANDBRAKE CABLE | MR955256 | |



| | | | | | | | |
|---|---|---|---|---|--------------------|-------------------------------|---|
|  |  |  |  |  | Description | OE numbers per ATE pn. |  e.g. replaced pn. / miscellaneous |
|---|---|---|---|---|--------------------|-------------------------------|---|







OPEL

| ASTRA G / Vauxhall Astra MKIV (98-04) | 1,6 CNG | FR | 03.2003 | 12.2004 | 24.3571-9824.5 | 240500 | FIST CALIPER | 5 42 292, 90544027, 5 42 453, 5 42 459, 9192455, 93173732, 93176427, 5 42 472 | |
|---------------------------------------|--------------------|----|---------|---------|----------------|--------|--------------|---|--|
| | 1,8 16V | FR | 04.1998 | 12.2004 | 24.3571-9824.5 | 240500 | FIST CALIPER | 5 42 292, 90544027, 5 42 453, 5 42 459, 9192455, 93173732, 93176427, 5 42 472 | |
| | 1,8 16V Cabrio | FR | 03.2001 | 12.2004 | 24.3571-9824.5 | 240500 | FIST CALIPER | 5 42 292, 90544027, 5 42 453, 5 42 459, 9192455, 93173732, 93176427, 5 42 472 | |
| | 1,8 16V Caravan | FR | 04.1998 | 12.2004 | 24.3571-9824.5 | 240500 | FIST CALIPER | 5 42 292, 90544027, 5 42 453, 5 42 459, 9192455, 93173732, 93176427, 5 42 472 | |
| | 1,8 16V Coupe | FR | 03.2000 | 12.2004 | 24.3571-9824.5 | 240500 | FIST CALIPER | 5 42 292, 90544027, 5 42 453, 5 42 459, 9192455, 93173732, 93176427, 5 42 472 | |
| | 2,0 16V | FR | 04.1998 | 12.2004 | 24.3571-9824.5 | 240500 | FIST CALIPER | 5 42 292, 90544027, 5 42 453, 5 42 459, 9192455, 93173732, 93176427, 5 42 472 | |
| | 2,0 16V OPC | FR | 10.1999 | 12.2004 | 24.3571-9824.5 | 240500 | FIST CALIPER | 5 42 292, 90544027, 5 42 453, 5 42 459, 9192455, 93173732, 93176427, 5 42 472 | |
| | 2,0 16V OPC Cabrio | FR | 03.2002 | 12.2004 | 24.3571-9824.5 | 240500 | FIST CALIPER | 5 42 292, 90544027, 5 42 453, 5 42 459, 9192455, 93173732, 93176427, 5 42 472 | |

New partnumbers on stock - according to applications

04/2011



| | | | | | | |
|---|---|---|---|--------------------|-------------------------------|---|
|  |  |   |  | Description | OE numbers per ATE pn. |  e.g. replaced pn. / miscellaneous |
|---|---|---|---|--------------------|-------------------------------|---|

OPEL

| Model | Engine | Country | Start Date | End Date | ATE Part No. | ATE Part No. | Description | OE numbers | Notes |
|---------------------------------------|--------------------|---------|------------|----------|----------------|--------------|--------------|---|-------|
| ASTRA G / Vauxhall Astra MKIV (98-04) | 2,0 DI | FR | 04.1998 | 12.2004 | 24.3571-9824.5 | 240500 | FIST CALIPER | 5 42 292, 90544027, 5 42 453, 5 42 459, 9192455, 93173732, 93176427, 5 42 472 | |
| | 2,0 DTI 16V | FR | 08.1999 | 12.2004 | 24.3571-9824.5 | 240500 | FIST CALIPER | 5 42 292, 90544027, 5 42 453, 5 42 459, 9192455, 93173732, 93176427, 5 42 472 | |
| | 2,0 Turbo | FR | 03.2000 | 12.2004 | 24.3571-9824.5 | 240500 | FIST CALIPER | 5 42 292, 90544027, 5 42 453, 5 42 459, 9192455, 93173732, 93176427, 5 42 472 | |
| | 2,2 16V | FR | 09.2000 | 12.2004 | 24.3571-9824.5 | 240500 | FIST CALIPER | 5 42 292, 90544027, 5 42 453, 5 42 459, 9192455, 93173732, 93176427, 5 42 472 | |
| | 2,2 16V Cabrio | FR | 03.2001 | 12.2004 | 24.3571-9824.5 | 240500 | FIST CALIPER | 5 42 292, 90544027, 5 42 453, 5 42 459, 9192455, 93173732, 93176427, 5 42 472 | |
| | 2,2 16V Coupe | FR | 09.2000 | 12.2004 | 24.3571-9824.5 | 240500 | FIST CALIPER | 5 42 292, 90544027, 5 42 453, 5 42 459, 9192455, 93173732, 93176427, 5 42 472 | |
| | 2,2 DTI 16V | FR | 09.2002 | 12.2004 | 24.3571-9824.5 | 240500 | FIST CALIPER | 5 42 292, 90544027, 5 42 453, 5 42 459, 9192455, 93173732, 93176427, 5 42 472 | |
| | 2,2 DTI 16V Cabrio | FR | 09.2002 | 12.2004 | 24.3571-9824.5 | 240500 | FIST CALIPER | 5 42 292, 90544027, 5 42 453, 5 42 459, 9192455, 93173732, 93176427, 5 42 472 | |

New partnumbers on stock - according to applications

04/2011



| | | | | | | | | |
|--|--|--|--|--|-------------|------------------------|--|-----------------------------------|
| | | | | | Description | OE numbers per ATE pn. | | e.g. replaced pn. / miscellaneous |
|--|--|--|--|--|-------------|------------------------|--|-----------------------------------|







OPEL

| | | | | | | | | | |
|--|-------------------|----|---------|---------|----------------|--------|--------------|---|--|
| ASTRA G / Vauxhall Astra MKIV (98-04) | 2,2 DTI 16V Coupe | FR | 09.2002 | 12.2004 | 24.3571-9824.5 | 240500 | FIST CALIPER | 5 42 292, 90544027, 5 42 453, 5 42 459, 9192455, 93173732, 93176427, 5 42 472 | |
| ASTRA H / GTC / Vauxhall Astra MKV (04-10) | 1,2 | FR | 08.2005 | 11.2010 | 24.3571-9824.5 | 240500 | FIST CALIPER | 5 42 292, 90544027, 5 42 453, 5 42 459, 9192455, 93173732, 93176427, 5 42 472 | |
| | 1,3 CDTI | FR | 08.2005 | 11.2010 | 24.3571-9824.5 | 240500 | FIST CALIPER | 5 42 292, 90544027, 5 42 453, 5 42 459, 9192455, 93173732, 93176427, 5 42 472 | |
| | 1,4 | FR | 01.2004 | 11.2010 | 24.3571-9824.5 | 240500 | FIST CALIPER | 5 42 292, 90544027, 5 42 453, 5 42 459, 9192455, 93173732, 93176427, 5 42 472 | |
| | 1,6 | FR | 01.2004 | 11.2010 | 24.3571-9824.5 | 240500 | FIST CALIPER | 5 42 292, 90544027, 5 42 453, 5 42 459, 9192455, 93173732, 93176427, 5 42 472 | |
| | | FR | 01.2007 | 11.2010 | 24.3571-9824.5 | 240500 | FIST CALIPER | 5 42 292, 90544027, 5 42 453, 5 42 459, 9192455, 93173732, 93176427, 5 42 472 | |
| | 1,7 CDTI | FR | 04.2007 | 11.2010 | 24.3571-9824.5 | 240500 | FIST CALIPER | 5 42 292, 90544027, 5 42 453, 5 42 459, 9192455, 93173732, 93176427, 5 42 472 | |
| | | FR | 01.2004 | 11.2010 | 24.3571-9824.5 | 240500 | FIST CALIPER | 5 42 292, 90544027, 5 42 453, 5 42 459, 9192455, 93173732, 93176427, 5 42 472 | |

New partnumbers on stock - according to applications

04/2011



| | | | | | | | |
|---|---|---|---|---|--------------------|-------------------------------|---|
|  |  |  |  |  | Description | OE numbers per ATE pn. |  e.g. replaced pn. / miscellaneous |
|---|---|---|---|---|--------------------|-------------------------------|---|







OPEL

| | | | | | | | | |
|---|-----------|----|---------|---------|----------------|--------|--------------|---|
| ASTRA H / GTC / Vauxhall Astra MKV (04-10) | 1,8 | FR | 01.2006 | 11.2010 | 24.3571-9824.5 | 240500 | FIST CALIPER | 5 42 292, 90544027, 5 42 453, 5 42 459, 9192455, 93173732, 93176427, 5 42 472 |
| | | FR | 01.2004 | 11.2010 | 24.3571-9824.5 | 240500 | FIST CALIPER | 5 42 292, 90544027, 5 42 453, 5 42 459, 9192455, 93173732, 93176427, 5 42 472 |
| | 1,9 CDTI | FR | 09.2005 | 11.2010 | 24.3571-9824.5 | 240500 | FIST CALIPER | 5 42 292, 90544027, 5 42 453, 5 42 459, 9192455, 93173732, 93176427, 5 42 472 |
| | | FR | 09.2004 | 11.2010 | 24.3571-9824.5 | 240500 | FIST CALIPER | 5 42 292, 90544027, 5 42 453, 5 42 459, 9192455, 93173732, 93176427, 5 42 472 |
| | 2,0 Turbo | FR | 09.2004 | 11.2010 | 24.3571-9824.5 | 240500 | FIST CALIPER | 5 42 292, 90544027, 5 42 453, 5 42 459, 9192455, 93173732, 93176427, 5 42 472 |
| | | FR | 01.2004 | 11.2010 | 24.3571-9824.5 | 240500 | FIST CALIPER | 5 42 292, 90544027, 5 42 453, 5 42 459, 9192455, 93173732, 93176427, 5 42 472 |
| ASTRA H Caravan/Vau. Astra MKV Estate (04-10) | 1,3 CDTI | FR | 08.2005 | 11.2010 | 24.3571-9824.5 | 240500 | FIST CALIPER | 5 42 292, 90544027, 5 42 453, 5 42 459, 9192455, 93173732, 93176427, 5 42 472 |
| | 1,4 | FR | 08.2004 | 11.2010 | 24.3571-9824.5 | 240500 | FIST CALIPER | 5 42 292, 90544027, 5 42 453, 5 42 459, 9192455, 93173732, 93176427, 5 42 472 |

New partnumbers on stock - according to applications

04/2011



| | | | | | | | |
|---|---|---|---|---|--------------------|-------------------------------|---|
|  |  |  |  |  | Description | OE numbers per ATE pn. |  e.g. replaced pn. / miscellaneous |
|---|---|---|---|---|--------------------|-------------------------------|---|

OPEL

| | | | | | | | | | |
|---|-----------|----|---------|---------|----------------|--------|--------------|--|--|
| ASTRA H Caravan/Vau. Astra MKV Estate (04-10) | 1,6 | FR | 08.2004 | 11.2010 | 24.3571-9824.5 | 240500 | FIST CALIPER | 5 42 292 , 90544027 , 5 42 453 , 5 42 459 , 9192455 , 93173732 , 93176427 , 5 42 472 | |
| | | FR | 01.2007 | 11.2010 | 24.3571-9824.5 | 240500 | FIST CALIPER | 5 42 292 , 90544027 , 5 42 453 , 5 42 459 , 9192455 , 93173732 , 93176427 , 5 42 472 | |
| | 1,6 LPG | FR | 08.2009 | 11.2010 | 24.3571-9824.5 | 240500 | FIST CALIPER | 5 42 292 , 90544027 , 5 42 453 , 5 42 459 , 9192455 , 93173732 , 93176427 , 5 42 472 | |
| | 1,6 Turbo | FR | 01.2007 | 11.2010 | 24.3571-9824.5 | 240500 | FIST CALIPER | 5 42 292 , 90544027 , 5 42 453 , 5 42 459 , 9192455 , 93173732 , 93176427 , 5 42 472 | |
| | 1,7 CDTI | FR | 04.2007 | 11.2010 | 24.3571-9824.5 | 240500 | FIST CALIPER | 5 42 292 , 90544027 , 5 42 453 , 5 42 459 , 9192455 , 93173732 , 93176427 , 5 42 472 | |
| | | FR | 08.2004 | 11.2010 | 24.3571-9824.5 | 240500 | FIST CALIPER | 5 42 292 , 90544027 , 5 42 453 , 5 42 459 , 9192455 , 93173732 , 93176427 , 5 42 472 | |
| | 1,8 | FR | 08.2005 | 11.2010 | 24.3571-9824.5 | 240500 | FIST CALIPER | 5 42 292 , 90544027 , 5 42 453 , 5 42 459 , 9192455 , 93173732 , 93176427 , 5 42 472 | |
| | | FR | 09.2004 | 11.2010 | 24.3571-9824.5 | 240500 | FIST CALIPER | 5 42 292 , 90544027 , 5 42 453 , 5 42 459 , 9192455 , 93173732 , 93176427 , 5 42 472 | |

New partnumbers on stock - according to applications

04/2011



| | | | | | | | | |
|--|--|--|--|--|-------------|------------------------|--|-----------------------------------|
| | | | | | Description | OE numbers per ATE pn. | | e.g. replaced pn. / miscellaneous |
|--|--|--|--|--|-------------|------------------------|--|-----------------------------------|







OPEL

| Model | Engine | Country | Start Date | End Date | ATE Part No. | ATE Part No. | Description | OE numbers | Notes |
|---|------------------|---------|------------|----------|----------------|--------------|--------------|---|-------------|
| ASTRA H Caravan/Vau. Astra MKV Estate (04-10) | 1,9 CDTI | FR | 08.2004 | 11.2010 | 24.3571-9824.5 | 240500 | FIST CALIPER | 5 42 292, 90544027, 5 42 453, 5 42 459, 9192455, 93173732, 93176427, 5 42 472 | |
| | | FR | 09.2004 | 11.2010 | 24.3571-9824.5 | 240500 | FIST CALIPER | 5 42 292, 90544027, 5 42 453, 5 42 459, 9192455, 93173732, 93176427, 5 42 472 | |
| | | FR | 09.2005 | 11.2010 | 24.3571-9824.5 | 240500 | FIST CALIPER | 5 42 292, 90544027, 5 42 453, 5 42 459, 9192455, 93173732, 93176427, 5 42 472 | |
| | 2,0 Turbo | FR | 09.2004 | 11.2010 | 24.3571-9824.5 | 240500 | FIST CALIPER | 5 42 292, 90544027, 5 42 453, 5 42 459, 9192455, 93173732, 93176427, 5 42 472 | |
| | | FR | 08.2004 | 11.2010 | 24.3571-9824.5 | 240500 | FIST CALIPER | 5 42 292, 90544027, 5 42 453, 5 42 459, 9192455, 93173732, 93176427, 5 42 472 | |
| ASTRA J / GTC / Vauxhall Astra MK VI (09-) | 1,3 CDTI ECOTEC | | 12.2009 | | 13.0460-7262.2 | 607262 | BRAKE PADS | 13301207, 5 42 120 | see drawing |
| | | | 12.2009 | | 13.0460-7263.2 | 607263 | BRAKE PADS | 13301234, 5 42 115 | see drawing |
| | 1,4 ecoFlex | | 12.2009 | | 13.0460-7263.2 | 607263 | BRAKE PADS | 13301234, 5 42 115 | see drawing |
| | | | 12.2009 | | 13.0460-7262.2 | 607262 | BRAKE PADS | 13301207, 5 42 120 | see drawing |
| | 1,4 Turbo ECOTEC | | 12.2009 | | 13.0460-7263.2 | 607263 | BRAKE PADS | 13301234, 5 42 115 | see drawing |
| | | | 12.2009 | | 13.0460-7262.2 | 607262 | BRAKE PADS | 13301207, 5 42 120 | see drawing |
| | 1,6 ECOTEC | | 12.2009 | | 13.0460-7262.2 | 607262 | BRAKE PADS | 13301207, 5 42 120 | see drawing |
| | | | 12.2009 | | 13.0460-7263.2 | 607263 | BRAKE PADS | 13301234, 5 42 115 | see drawing |

New partnumbers on stock - according to applications

04/2011



| | | | | | | | |
|---|---|---|---|---|--------------------|-------------------------------|---|
|  |  |  |  |  | Description | OE numbers per ATE pn. |  e.g. replaced pn. / miscellaneous |
|---|---|---|---|---|--------------------|-------------------------------|---|







OPEL

| | | | | | | | | | |
|---|------------------|--|---------|--|----------------|--------|------------|---------------------|-------------|
| ASTRA J / GTC / Vauxhall Astra MK VI (09-) | 1,6 Turbo ECOTEC | | 12.2009 | | 13.0460-7263.2 | 607263 | BRAKE PADS | 13301234 , 5 42 115 | see drawing |
| | | | 12.2009 | | 13.0460-7262.2 | 607262 | BRAKE PADS | 13301207 , 5 42 120 | see drawing |
| | 1,7 CDTi ECOTEC | | 12.2009 | | 13.0460-7263.2 | 607263 | BRAKE PADS | 13301234 , 5 42 115 | see drawing |
| | | | 12.2009 | | 13.0460-7262.2 | 607262 | BRAKE PADS | 13301207 , 5 42 120 | see drawing |
| | 2,0 CDTi ECOTEC | | 12.2009 | | 13.0460-7263.2 | 607263 | BRAKE PADS | 13301234 , 5 42 115 | see drawing |
| | | | 12.2009 | | 13.0460-7262.2 | 607262 | BRAKE PADS | 13301207 , 5 42 120 | see drawing |
| ASTRA J Sports Tourer/Vau.Astra Sports Tourer (10-) | 1,3 CDTi ECOTEC | | 11.2010 | | 13.0460-7262.2 | 607262 | BRAKE PADS | 13301207 , 5 42 120 | see drawing |
| | | | 11.2010 | | 13.0460-7263.2 | 607263 | BRAKE PADS | 13301234 , 5 42 115 | see drawing |
| | 1,4 ecoFlex | | 11.2010 | | 13.0460-7262.2 | 607262 | BRAKE PADS | 13301207 , 5 42 120 | see drawing |
| | | | 11.2010 | | 13.0460-7263.2 | 607263 | BRAKE PADS | 13301234 , 5 42 115 | see drawing |
| | 1,4 Turbo ECOTEC | | 11.2010 | | 13.0460-7262.2 | 607262 | BRAKE PADS | 13301207 , 5 42 120 | see drawing |
| | | | 11.2010 | | 13.0460-7263.2 | 607263 | BRAKE PADS | 13301234 , 5 42 115 | see drawing |
| | 1,6 ECOTEC | | 11.2010 | | 13.0460-7262.2 | 607262 | BRAKE PADS | 13301207 , 5 42 120 | see drawing |
| | | | 11.2010 | | 13.0460-7263.2 | 607263 | BRAKE PADS | 13301234 , 5 42 115 | see drawing |
| | 1,6 Turbo ECOTEC | | 11.2010 | | 13.0460-7262.2 | 607262 | BRAKE PADS | 13301207 , 5 42 120 | see drawing |
| | | | 11.2010 | | 13.0460-7263.2 | 607263 | BRAKE PADS | 13301234 , 5 42 115 | see drawing |
| | 1,7 CDTi ECOTEC | | 11.2010 | | 13.0460-7263.2 | 607263 | BRAKE PADS | 13301234 , 5 42 115 | see drawing |
| | | | 11.2010 | | 13.0460-7262.2 | 607262 | BRAKE PADS | 13301207 , 5 42 120 | see drawing |
| | 2,0 CDTi ECOTEC | | 11.2010 | | 13.0460-7262.2 | 607262 | BRAKE PADS | 13301207 , 5 42 120 | see drawing |

New partnumbers on stock - according to applications

04/2011



| | | | | | | | |
|---|---|---|---|---|--------------------|-------------------------------|---|
|  |  |  |  |  | Description | OE numbers per ATE pn. |  e.g. replaced pn. / miscellaneous |
|---|---|---|---|---|--------------------|-------------------------------|---|

OPEL

| | | | | | | | | | |
|---|-----------------|----|---------|--|----------------|--------|--------------|--|-------------|
| ASTRA J Sports Tourer/Vau.Astra Sports Tourer (10-) | 2,0 CDTi ECOTEC | | 11.2010 | | 13.0460-7263.2 | 607263 | BRAKE PADS | 13301234 , 5 42 115 | see drawing |
| ASTRA TWIN TOP (06-) | 1,6 | FR | 12.2006 | | 24.3571-9824.5 | 240500 | FIST CALIPER | 5 42 292 , 90544027 , 5 42 453 , 5 42 459 , 9192455 , 93173732 , 93176427 , 5 42 472 | |
| | | FR | 03.2006 | | 24.3571-9824.5 | 240500 | FIST CALIPER | 5 42 292 , 90544027 , 5 42 453 , 5 42 459 , 9192455 , 93173732 , 93176427 , 5 42 472 | |
| | 1,6 Turbo | FR | 02.2007 | | 24.3571-9824.5 | 240500 | FIST CALIPER | 5 42 292 , 90544027 , 5 42 453 , 5 42 459 , 9192455 , 93173732 , 93176427 , 5 42 472 | |
| | 1,8 | FR | 03.2006 | | 24.3571-9824.5 | 240500 | FIST CALIPER | 5 42 292 , 90544027 , 5 42 453 , 5 42 459 , 9192455 , 93173732 , 93176427 , 5 42 472 | |
| | 1,9 CDTI | FR | 03.2006 | | 24.3571-9824.5 | 240500 | FIST CALIPER | 5 42 292 , 90544027 , 5 42 453 , 5 42 459 , 9192455 , 93173732 , 93176427 , 5 42 472 | |
| | 2,0 Turbo | FR | 03.2006 | | 24.3571-9824.5 | 240500 | FIST CALIPER | 5 42 292 , 90544027 , 5 42 453 , 5 42 459 , 9192455 , 93173732 , 93176427 , 5 42 472 | |
| COMBO / Vauxhall Combo (01-) | 1,3 CDTI | FR | | | 24.3571-9824.5 | 240500 | FIST CALIPER | 5 42 292 , 90544027 , 5 42 453 , 5 42 459 , 9192455 , 93173732 , 93176427 , 5 42 472 | |

New partnumbers on stock - according to applications

04/2011



| | | | | | | | |
|--|--|--|--|--|-------------|------------------------|---------------------------------------|
| | | | | | Description | OE numbers per ATE pn. | e.g. replaced pn. / miscellaneous |
|--|--|--|--|--|-------------|------------------------|---------------------------------------|

OPEL

| | | | | | | | | | |
|--|---------------|----|---------|---------|----------------|--------|--------------|--|--|
| COMBO / Vauxhall Combo (01-) | 1,4 16V | FR | | | 24.3571-9824.5 | 240500 | FIST CALIPER | 5 42 292 , 90544027 , 5 42 453 , 5 42 459 , 9192455 , 93173732 , 93176427 , 5 42 472 | |
| | 1,6 | FR | | | 24.3571-9824.5 | 240500 | FIST CALIPER | 5 42 292 , 90544027 , 5 42 453 , 5 42 459 , 9192455 , 93173732 , 93176427 , 5 42 472 | |
| | 1,6 CNG | FR | 04.2005 | | 24.3571-9824.5 | 240500 | FIST CALIPER | 5 42 292 , 90544027 , 5 42 453 , 5 42 459 , 9192455 , 93173732 , 93176427 , 5 42 472 | |
| | 1,7 CDTI 16V | FR | 06.2004 | | 24.3571-9824.5 | 240500 | FIST CALIPER | 5 42 292 , 90544027 , 5 42 453 , 5 42 459 , 9192455 , 93173732 , 93176427 , 5 42 472 | |
| | 1,7 DI 16V | FR | | | 24.3571-9824.5 | 240500 | FIST CALIPER | 5 42 292 , 90544027 , 5 42 453 , 5 42 459 , 9192455 , 93173732 , 93176427 , 5 42 472 | |
| | 1,7 DTI 16V | FR | | | 24.3571-9824.5 | 240500 | FIST CALIPER | 5 42 292 , 90544027 , 5 42 453 , 5 42 459 , 9192455 , 93173732 , 93176427 , 5 42 472 | |
| CORSA C / Vauxhall Corsa MK II (00-06) | 1,7 CDTI | FR | 06.2003 | 09.2006 | 24.3571-9824.5 | 240500 | FIST CALIPER | 5 42 292 , 90544027 , 5 42 453 , 5 42 459 , 9192455 , 93173732 , 93176427 , 5 42 472 | |
| CORSA D / Vauxhall Corsa MK III (06-) | 1,6 Turbo GSI | FR | 06.2007 | | 24.3571-9824.5 | 240500 | FIST CALIPER | 5 42 292 , 90544027 , 5 42 453 , 5 42 459 , 9192455 , 93173732 , 93176427 , 5 42 472 | |

New partnumbers on stock - according to applications

04/2011









| | | | | | | | | |
|--|--|--|--|--|-------------|------------------------|--|-----------------------------------|
| | | | | | Description | OE numbers per ATE pn. | | e.g. replaced pn. / miscellaneous |
|--|--|--|--|--|-------------|------------------------|--|-----------------------------------|

OPEL

| | | | | | | | | | |
|--------------------------------------|-------------|----|---------|---------|----------------|--------|--------------|---|--|
| MERIVA A / Vauxhall Meriva A (02-10) | 1,3 CDTI | FR | 09.2003 | 05.2010 | 24.3571-9824.5 | 240500 | FIST CALIPER | 5 42 292, 90544027, 5 42 453, 5 42 459, 9192455, 93173732, 93176427, 5 42 472 | |
| | 1,6 | FR | 01.2006 | 05.2010 | 24.3571-9824.5 | 240500 | FIST CALIPER | 5 42 292, 90544027, 5 42 453, 5 42 459, 9192455, 93173732, 93176427, 5 42 472 | |
| | 1,6 16V | FR | 05.2003 | 05.2010 | 24.3571-9824.5 | 240500 | FIST CALIPER | 5 42 292, 90544027, 5 42 453, 5 42 459, 9192455, 93173732, 93176427, 5 42 472 | |
| | 1,7 CDTI | FR | 09.2006 | 05.2010 | 24.3571-9824.5 | 240500 | FIST CALIPER | 5 42 292, 90544027, 5 42 453, 5 42 459, 9192455, 93173732, 93176427, 5 42 472 | |
| | | FR | 09.2003 | 05.2010 | 24.3571-9824.5 | 240500 | FIST CALIPER | 5 42 292, 90544027, 5 42 453, 5 42 459, 9192455, 93173732, 93176427, 5 42 472 | |
| | 1,7 DTI 16V | FR | 09.2002 | 05.2010 | 24.3571-9824.5 | 240500 | FIST CALIPER | 5 42 292, 90544027, 5 42 453, 5 42 459, 9192455, 93173732, 93176427, 5 42 472 | |
| | 1,8 16V | FR | 09.2002 | 05.2010 | 24.3571-9824.5 | 240500 | FIST CALIPER | 5 42 292, 90544027, 5 42 453, 5 42 459, 9192455, 93173732, 93176427, 5 42 472 | |
| MERIVA B (10-) | 1,3 CDTI | FR | 06.2010 | | 24.3571-9824.5 | 240500 | FIST CALIPER | 5 42 292, 90544027, 5 42 453, 5 42 459, 9192455, 93173732, 93176427, 5 42 472 | |



| | | | | | | |
|---|---|---|---|--------------------|-------------------------------|---|
|  |  |   |  | Description | OE numbers per ATE pn. |  e.g. replaced pn. / miscellaneous |
|---|---|---|---|--------------------|-------------------------------|---|

OPEL

| | | | | | | | | | |
|--------------------------------------|-------------|----|---------|---------|----------------|--------|--------------|---|--|
| MERIVA B (10-) | 1,4 | FR | 06.2010 | | 24.3571-9824.5 | 240500 | FIST CALIPER | 5 42 292, 90544027, 5 42 453, 5 42 459, 9192455, 93173732, 93176427, 5 42 472 | |
| | 1,4 EcoFlex | FR | 06.2010 | | 24.3571-9824.5 | 240500 | FIST CALIPER | 5 42 292, 90544027, 5 42 453, 5 42 459, 9192455, 93173732, 93176427, 5 42 472 | |
| | 1,7 CDTI | FR | 06.2010 | | 24.3571-9824.5 | 240500 | FIST CALIPER | 5 42 292, 90544027, 5 42 453, 5 42 459, 9192455, 93173732, 93176427, 5 42 472 | |
| ZAFIRA I / Vauxhall Zafira I (99-05) | 1,6 16V | FR | 04.1999 | 06.2005 | 24.3571-9824.5 | 240500 | FIST CALIPER | 5 42 292, 90544027, 5 42 453, 5 42 459, 9192455, 93173732, 93176427, 5 42 472 | |
| | 1,8 16V | FR | 04.1999 | 06.2005 | 24.3571-9824.5 | 240500 | FIST CALIPER | 5 42 292, 90544027, 5 42 453, 5 42 459, 9192455, 93173732, 93176427, 5 42 472 | |
| | 2,0 16V OPC | FR | 09.2001 | 06.2005 | 24.3571-9824.5 | 240500 | FIST CALIPER | 5 42 292, 90544027, 5 42 453, 5 42 459, 9192455, 93173732, 93176427, 5 42 472 | |
| | 2,0 DI 16V | FR | 10.1999 | 06.2005 | 24.3571-9824.5 | 240500 | FIST CALIPER | 5 42 292, 90544027, 5 42 453, 5 42 459, 9192455, 93173732, 93176427, 5 42 472 | |
| | 2,0 DTI 16V | FR | 06.2000 | 06.2005 | 24.3571-9824.5 | 240500 | FIST CALIPER | 5 42 292, 90544027, 5 42 453, 5 42 459, 9192455, 93173732, 93176427, 5 42 472 | |

New partnumbers on stock - according to applications

04/2011



| | | | | | | | |
|--|--|---|---|--|-------------|------------------------|-----------------------------------|
| | | | | | Description | OE numbers per ATE pn. | |
| | | ← | → | | | | e.g. replaced pn. / miscellaneous |

OPEL

| | | | | | | | | |
|--|---------------|----|---------|---------|----------------|--------|------------------|---|
| ZAFIRA I / Vauxhall Zafira I (99-05) | 2,2 16V | FR | 09.2000 | 06.2005 | 24.3571-9824.5 | 240500 | FIST CALIPER | 5 42 292, 90544027, 5 42 453, 5 42 459, 9192455, 93173732, 93176427, 5 42 472 |
| | 2,2 DTI 16V | FR | 01.2002 | 06.2005 | 24.3571-9824.5 | 240500 | FIST CALIPER | 5 42 292, 90544027, 5 42 453, 5 42 459, 9192455, 93173732, 93176427, 5 42 472 |
| ZAFIRA II / Vauxhall Zafira II (05-11) | 1,6 | FR | 07.2005 | | 24.3571-9824.5 | 240500 | FIST CALIPER | 5 42 292, 90544027, 5 42 453, 5 42 459, 9192455, 93173732, 93176427, 5 42 472 |
| | | FR | 12.2007 | | 24.3571-9824.5 | 240500 | FIST CALIPER | 5 42 292, 90544027, 5 42 453, 5 42 459, 9192455, 93173732, 93176427, 5 42 472 |
| | | | 12.2007 | | 24.0101-3803.2 | 260101 | INSTALLATION KIT | 4439 36, 001 421 04 86, 34 21 6 772 867, 93179160, 54 23 93 |
| | | | 07.2005 | | 24.0101-3803.2 | 260101 | INSTALLATION KIT | 4439 36, 001 421 04 86, 34 21 6 772 867, 93179160, 54 23 93 |
| | 1,6 CNG | FR | 01.2006 | | 24.3571-9824.5 | 240500 | FIST CALIPER | 5 42 292, 90544027, 5 42 453, 5 42 459, 9192455, 93173732, 93176427, 5 42 472 |
| | | | 01.2006 | | 24.0101-3803.2 | 260101 | INSTALLATION KIT | 4439 36, 001 421 04 86, 34 21 6 772 867, 93179160, 54 23 93 |
| | 1,6 CNG Turbo | FR | 02.2009 | | 24.3571-9824.5 | 240500 | FIST CALIPER | 5 42 292, 90544027, 5 42 453, 5 42 459, 9192455, 93173732, 93176427, 5 42 472 |

New partnumbers on stock - according to applications

04/2011



| | | | | | | | |
|--|--|--|--|--|--------------------|-------------------------------|--|
| | | | | | Description | OE numbers per ATE pn. | e.g. replaced pn. / miscellaneous |
|--|--|--|--|--|--------------------|-------------------------------|--|

OPEL

| | | | | | | | | | |
|--|---------------|----|---------|--|----------------|--------|------------------|--|--|
| ZAFIRA II / Vauxhall Zafira II (05-11) | 1,6 CNG Turbo | | 02.2009 | | 24.0101-3803.2 | 260101 | INSTALLATION KIT | 4439 36 , 001 421 04 86 , 34 21 6 772 867 , 93179160 , 54 23 93 | |
| | 1,7 CDTI | FR | 12.2007 | | 24.3571-9824.5 | 240500 | FIST CALIPER | 5 42 292 , 90544027 , 5 42 453 , 5 42 459 , 9192455 , 93173732 , 93176427 , 5 42 472 | |
| | | | 12.2007 | | 24.0101-3803.2 | 260101 | INSTALLATION KIT | 4439 36 , 001 421 04 86 , 34 21 6 772 867 , 93179160 , 54 23 93 | |
| | 1,8 | FR | 07.2005 | | 24.3571-9824.5 | 240500 | FIST CALIPER | 5 42 292 , 90544027 , 5 42 453 , 5 42 459 , 9192455 , 93173732 , 93176427 , 5 42 472 | |
| | | | 07.2005 | | 24.0101-3803.2 | 260101 | INSTALLATION KIT | 4439 36 , 001 421 04 86 , 34 21 6 772 867 , 93179160 , 54 23 93 | |
| | 1,9 CDTI | FR | 07.2005 | | 24.3571-9824.5 | 240500 | FIST CALIPER | 5 42 292 , 90544027 , 5 42 453 , 5 42 459 , 9192455 , 93173732 , 93176427 , 5 42 472 | |
| | | | 07.2005 | | 24.0101-3803.2 | 260101 | INSTALLATION KIT | 4439 36 , 001 421 04 86 , 34 21 6 772 867 , 93179160 , 54 23 93 | |
| | 2,0 Turbo | FR | 07.2005 | | 24.3571-9824.5 | 240500 | FIST CALIPER | 5 42 292 , 90544027 , 5 42 453 , 5 42 459 , 9192455 , 93173732 , 93176427 , 5 42 472 | |
| | | | 07.2005 | | 24.0101-3803.2 | 260101 | INSTALLATION KIT | 4439 36 , 001 421 04 86 , 34 21 6 772 867 , 93179160 , 54 23 93 | |

New partnumbers on stock - according to applications

04/2011



| | | | | | | | |
|---|----------|---|---|---|--------------------|-------------------------------|---|
|  | i |  |  |  | Description | OE numbers per ATE pn. | i e.g. replaced pn. / miscellaneous |
|---|----------|---|---|---|--------------------|-------------------------------|---|

OPEL

| | | | | | | | | | |
|--|-----|----|---------|--|----------------|--------|------------------|--|--|
| ZAFIRA II / Vauxhall Zafira II (05-11) | 2,2 | FR | 07.2005 | | 24.3571-9824.5 | 240500 | FIST CALIPER | 5 42 292 , 90544027 , 5 42 453 , 5 42 459 , 9192455 , 93173732 , 93176427 , 5 42 472 | |
| | | | 07.2005 | | 24.0101-3803.2 | 260101 | INSTALLATION KIT | 4439 36 , 001 421 04 86 , 34 21 6 772 867 , 93179160 , 54 23 93 | |

New partnumbers on stock - according to applications

04/2011



| | | | | | | | |
|--|--|--|--|--|--------------------|-------------------------------|--|
| | | | | | Description | OE numbers per ATE pn. | e.g. replaced pn. / miscellaneous |
|--|--|--|--|--|--------------------|-------------------------------|--|

PEUGEOT

| | | | | | | | | | |
|------------------|-------------|--|---------|--|----------------|--------|------------------|---|--|
| 407 Coupe (05-) | 2,0 HDi | | 06.2009 | | 24.0101-3802.2 | 260100 | INSTALLATION KIT | 4439 36 , 77363365 , 169 421 01 86 , 4439 34 , 4439 44 | |
| | | | 07.2007 | | 24.0101-3802.2 | 260100 | INSTALLATION KIT | 4439 36 , 77363365 , 169 421 01 86 , 4439 34 , 4439 44 | |
| | | | 06.2009 | | 24.0101-3803.2 | 260101 | INSTALLATION KIT | 4439 36 , 001 421 04 86 , 34 21 6 772 867 , 93179160 , 54 23 93 | |
| | | | 07.2007 | | 24.0101-3803.2 | 260101 | INSTALLATION KIT | 4439 36 , 001 421 04 86 , 34 21 6 772 867 , 93179160 , 54 23 93 | |
| | 2,2 16V | | 10.2005 | | 24.0101-3803.2 | 260101 | INSTALLATION KIT | 4439 36 , 001 421 04 86 , 34 21 6 772 867 , 93179160 , 54 23 93 | |
| | 2,7 HDi | | 10.2005 | | 24.0101-3803.2 | 260101 | INSTALLATION KIT | 4439 36 , 001 421 04 86 , 34 21 6 772 867 , 93179160 , 54 23 93 | |
| | 3,0 HDi | | 06.2009 | | 24.0101-3803.2 | 260101 | INSTALLATION KIT | 4439 36 , 001 421 04 86 , 34 21 6 772 867 , 93179160 , 54 23 93 | |
| | 3,0 V6 | | 10.2005 | | 24.0101-3803.2 | 260101 | INSTALLATION KIT | 4439 36 , 001 421 04 86 , 34 21 6 772 867 , 93179160 , 54 23 93 | |
| 407 Saloon (04-) | 1,6 HDi 110 | | 05.2004 | | 24.0101-3802.2 | 260100 | INSTALLATION KIT | 4439 36 , 77363365 , 169 421 01 86 , 4439 34 , 4439 44 | |
| | | | 05.2004 | | 24.0101-3803.2 | 260101 | INSTALLATION KIT | 4439 36 , 001 421 04 86 , 34 21 6 772 867 , 93179160 , 54 23 93 | |
| | 1,8 16V | | 09.2005 | | 24.0101-3803.2 | 260101 | INSTALLATION KIT | 4439 36 , 001 421 04 86 , 34 21 6 772 867 , 93179160 , 54 23 93 | |

New partnumbers on stock - according to applications

04/2011



| | | | | | | | | |
|--|--|--|--|--|-------------|------------------------|--|-----------------------------------|
| | | | | | Description | OE numbers per ATE pn. | | e.g. replaced pn. / miscellaneous |
|--|--|--|--|--|-------------|------------------------|--|-----------------------------------|

PEUGEOT

| | | | | | | | | | |
|------------------|-------------|--|---------|--|----------------|--------|------------------|---|--|
| 407 Saloon (04-) | 1,8 16V | | 05.2004 | | 24.0101-3802.2 | 260100 | INSTALLATION KIT | 4439 36 , 77363365 , 169 421 01 86 , 4439 34 , 4439 44 | |
| | | | 05.2004 | | 24.0101-3803.2 | 260101 | INSTALLATION KIT | 4439 36 , 001 421 04 86 , 34 21 6 772 867 , 93179160 , 54 23 93 | |
| | | | 09.2005 | | 24.0101-3802.2 | 260100 | INSTALLATION KIT | 4439 36 , 77363365 , 169 421 01 86 , 4439 34 , 4439 44 | |
| | 2,0 16V | | 05.2004 | | 24.0101-3802.2 | 260100 | INSTALLATION KIT | 4439 36 , 77363365 , 169 421 01 86 , 4439 34 , 4439 44 | |
| | | | 09.2005 | | 24.0101-3802.2 | 260100 | INSTALLATION KIT | 4439 36 , 77363365 , 169 421 01 86 , 4439 34 , 4439 44 | |
| | | | 05.2004 | | 24.0101-3803.2 | 260101 | INSTALLATION KIT | 4439 36 , 001 421 04 86 , 34 21 6 772 867 , 93179160 , 54 23 93 | |
| | | | 09.2005 | | 24.0101-3803.2 | 260101 | INSTALLATION KIT | 4439 36 , 001 421 04 86 , 34 21 6 772 867 , 93179160 , 54 23 93 | |
| | 2,0 HDi 135 | | 05.2004 | | 24.0101-3802.2 | 260100 | INSTALLATION KIT | 4439 36 , 77363365 , 169 421 01 86 , 4439 34 , 4439 44 | |
| | | | 05.2004 | | 24.0101-3803.2 | 260101 | INSTALLATION KIT | 4439 36 , 001 421 04 86 , 34 21 6 772 867 , 93179160 , 54 23 93 | |
| | 2,0 HDi 140 | | 08.2008 | | 24.0101-3802.2 | 260100 | INSTALLATION KIT | 4439 36 , 77363365 , 169 421 01 86 , 4439 34 , 4439 44 | |
| | | | 08.2008 | | 24.0101-3803.2 | 260101 | INSTALLATION KIT | 4439 36 , 001 421 04 86 , 34 21 6 772 867 , 93179160 , 54 23 93 | |

New partnumbers on stock - according to applications

04/2011



| | | | | | | | |
|--|--|--|--|--|--------------------|-------------------------------|--|
| | | | | | Description | OE numbers per ATE pn. | e.g. replaced pn. / miscellaneous |
|--|--|--|--|--|--------------------|-------------------------------|--|

PEUGEOT

| | | | | | | | | | |
|------------------|-------------|--|---------|--|----------------|--------|------------------|---|--|
| 407 Saloon (04-) | 2,2 16V | | 09.2005 | | 24.0101-3803.2 | 260101 | INSTALLATION KIT | 4439 36 , 001 421 04 86 , 34 21 6 772 867 , 93179160 , 54 23 93 | |
| | | | 05.2004 | | 24.0101-3803.2 | 260101 | INSTALLATION KIT | 4439 36 , 001 421 04 86 , 34 21 6 772 867 , 93179160 , 54 23 93 | |
| | 2,2 HDi | | 06.2008 | | 24.0101-3803.2 | 260101 | INSTALLATION KIT | 4439 36 , 001 421 04 86 , 34 21 6 772 867 , 93179160 , 54 23 93 | |
| | 2,2 HDi 170 | | 05.2006 | | 24.0101-3803.2 | 260101 | INSTALLATION KIT | 4439 36 , 001 421 04 86 , 34 21 6 772 867 , 93179160 , 54 23 93 | |
| | 2,7 HDi | | 10.2005 | | 24.0101-3803.2 | 260101 | INSTALLATION KIT | 4439 36 , 001 421 04 86 , 34 21 6 772 867 , 93179160 , 54 23 93 | |
| | 3,0 V6 | | 05.2004 | | 24.0101-3803.2 | 260101 | INSTALLATION KIT | 4439 36 , 001 421 04 86 , 34 21 6 772 867 , 93179160 , 54 23 93 | |
| 407 SW (04-) | 1,6 HDi 110 | | 05.2004 | | 24.0101-3802.2 | 260100 | INSTALLATION KIT | 4439 36 , 77363365 , 169 421 01 86 , 4439 34 , 4439 44 | |
| | | | 05.2004 | | 24.0101-3803.2 | 260101 | INSTALLATION KIT | 4439 36 , 001 421 04 86 , 34 21 6 772 867 , 93179160 , 54 23 93 | |
| | 1,8 16V | | 05.2004 | | 24.0101-3803.2 | 260101 | INSTALLATION KIT | 4439 36 , 001 421 04 86 , 34 21 6 772 867 , 93179160 , 54 23 93 | |
| | | | 09.2005 | | 24.0101-3803.2 | 260101 | INSTALLATION KIT | 4439 36 , 001 421 04 86 , 34 21 6 772 867 , 93179160 , 54 23 93 | |
| | | | 09.2005 | | 24.0101-3802.2 | 260100 | INSTALLATION KIT | 4439 36 , 77363365 , 169 421 01 86 , 4439 34 , 4439 44 | |

New partnumbers on stock - according to applications

04/2011



| | | | | | | | |
|--|--|---|---|--|-------------|------------------------|-----------------------------------|
| | | | | | Description | OE numbers per ATE pn. | |
| | | ← | → | | | | e.g. replaced pn. / miscellaneous |





PEUGEOT

| 407 SW (04-) | 1,8 16V | | 05.2004 | | 24.0101-3802.2 | 260100 | INSTALLATION KIT | 4439 36 , 77363365 , 169 421 01 86 , 4439 34 , 4439 44 | |
|--------------|-------------|--|---------|---------|----------------|--------|------------------|---|--|
| | 2,0 16V | | 09.2005 | | 24.0101-3803.2 | 260101 | INSTALLATION KIT | 4439 36 , 001 421 04 86 , 34 21 6 772 867 , 93179160 , 54 23 93 | |
| | | | 05.2004 | | 24.0101-3803.2 | 260101 | INSTALLATION KIT | 4439 36 , 001 421 04 86 , 34 21 6 772 867 , 93179160 , 54 23 93 | |
| | | | 09.2005 | | 24.0101-3802.2 | 260100 | INSTALLATION KIT | 4439 36 , 77363365 , 169 421 01 86 , 4439 34 , 4439 44 | |
| | | | 05.2004 | | 24.0101-3802.2 | 260100 | INSTALLATION KIT | 4439 36 , 77363365 , 169 421 01 86 , 4439 34 , 4439 44 | |
| | 2,0 BioFlex | | 01.2008 | | 24.0101-3803.2 | 260101 | INSTALLATION KIT | 4439 36 , 001 421 04 86 , 34 21 6 772 867 , 93179160 , 54 23 93 | |
| | | | 01.2008 | | 24.0101-3802.2 | 260100 | INSTALLATION KIT | 4439 36 , 77363365 , 169 421 01 86 , 4439 34 , 4439 44 | |
| | 2,0 HDi | | 05.2004 | 07.2008 | 24.0101-3803.2 | 260101 | INSTALLATION KIT | 4439 36 , 001 421 04 86 , 34 21 6 772 867 , 93179160 , 54 23 93 | |
| | | | 05.2004 | 07.2008 | 24.0101-3802.2 | 260100 | INSTALLATION KIT | 4439 36 , 77363365 , 169 421 01 86 , 4439 34 , 4439 44 | |
| | 2,0 HDi 135 | | 05.2004 | | 24.0101-3803.2 | 260101 | INSTALLATION KIT | 4439 36 , 001 421 04 86 , 34 21 6 772 867 , 93179160 , 54 23 93 | |
| | | | 05.2004 | | 24.0101-3802.2 | 260100 | INSTALLATION KIT | 4439 36 , 77363365 , 169 421 01 86 , 4439 34 , 4439 44 | |
| | 2,0 HDi 140 | | 08.2008 | | 24.0101-3802.2 | 260100 | INSTALLATION KIT | 4439 36 , 77363365 , 169 421 01 86 , 4439 34 , 4439 44 | |

New partnumbers on stock - according to applications

04/2011



| | | | | | | |
|---|---|--|---|--------------------|-------------------------------|---|
|  |  |  |  | Description | OE numbers per ATE pn. |  e.g. replaced pn. / miscellaneous |
|---|---|--|---|--------------------|-------------------------------|---|

PEUGEOT

| Model | Engine | Year | ATE Part Number | Description | OE numbers |
|--------------|-------------|---------|-----------------|-------------------------|---|
| 407 SW (04-) | 2,0 HDi 140 | 08.2008 | 24.0101-3803.2 | 260101 INSTALLATION KIT | 4439 36 , 001 421 04 86 , 34 21 6 772 867 , 93179160 , 54 23 93 |
| | 2,2 16V | 05.2004 | 24.0101-3803.2 | 260101 INSTALLATION KIT | 4439 36 , 001 421 04 86 , 34 21 6 772 867 , 93179160 , 54 23 93 |
| | | 09.2005 | 24.0101-3803.2 | 260101 INSTALLATION KIT | 4439 36 , 001 421 04 86 , 34 21 6 772 867 , 93179160 , 54 23 93 |
| | 2,2 HDi | 06.2008 | 24.0101-3803.2 | 260101 INSTALLATION KIT | 4439 36 , 001 421 04 86 , 34 21 6 772 867 , 93179160 , 54 23 93 |
| | 2,2 HDi 170 | 05.2006 | 24.0101-3803.2 | 260101 INSTALLATION KIT | 4439 36 , 001 421 04 86 , 34 21 6 772 867 , 93179160 , 54 23 93 |
| | 2,7 HDi | 10.2005 | 24.0101-3803.2 | 260101 INSTALLATION KIT | 4439 36 , 001 421 04 86 , 34 21 6 772 867 , 93179160 , 54 23 93 |
| | 3,0 V6 | 05.2004 | 24.0101-3803.2 | 260101 INSTALLATION KIT | 4439 36 , 001 421 04 86 , 34 21 6 772 867 , 93179160 , 54 23 93 |



| | | | | | | | |
|--|----------|--|--|--|--------------------|-------------------------------|---|
| | i | | | | Description | OE numbers per ATE pn. | i e.g. replaced pn. / miscellaneous |
|--|----------|--|--|--|--------------------|-------------------------------|---|

RENAULT

| | | | | | | | | | |
|--------------------------|-----------------|--|---------|---------|----------------|--------|------------------|---|--|
| CLIO III (BR_/CR_) (05-) | 1,2 | | 10.2005 | | 24.0101-3803.2 | 260101 | INSTALLATION KIT | 4439 36 , 001 421 04 86 , 34 21 6 772 867 , 93179160 , 54 23 93 | |
| | | | 09.2006 | | 24.0101-3803.2 | 260101 | INSTALLATION KIT | 4439 36 , 001 421 04 86 , 34 21 6 772 867 , 93179160 , 54 23 93 | |
| | 1,2 16V | | 06.2005 | | 24.0101-3803.2 | 260101 | INSTALLATION KIT | 4439 36 , 001 421 04 86 , 34 21 6 772 867 , 93179160 , 54 23 93 | |
| | | | 05.2007 | | 24.0101-3803.2 | 260101 | INSTALLATION KIT | 4439 36 , 001 421 04 86 , 34 21 6 772 867 , 93179160 , 54 23 93 | |
| | 1,2 16V Hi-Flex | | 07.2008 | | 24.0101-3803.2 | 260101 | INSTALLATION KIT | 4439 36 , 001 421 04 86 , 34 21 6 772 867 , 93179160 , 54 23 93 | |
| | 1,4 16V | | 06.2005 | | 24.0101-3803.2 | 260101 | INSTALLATION KIT | 4439 36 , 001 421 04 86 , 34 21 6 772 867 , 93179160 , 54 23 93 | |
| | 1,5 D | | 11.2007 | | 24.0101-3803.2 | 260101 | INSTALLATION KIT | 4439 36 , 001 421 04 86 , 34 21 6 772 867 , 93179160 , 54 23 93 | |
| | 1,5 dCi | | 06.2005 | | 24.0101-3803.2 | 260101 | INSTALLATION KIT | 4439 36 , 001 421 04 86 , 34 21 6 772 867 , 93179160 , 54 23 93 | |
| | | | 05.2005 | 10.2006 | 24.0101-3803.2 | 260101 | INSTALLATION KIT | 4439 36 , 001 421 04 86 , 34 21 6 772 867 , 93179160 , 54 23 93 | |
| | 1,6 16V | | 06.2005 | | 24.0101-3803.2 | 260101 | INSTALLATION KIT | 4439 36 , 001 421 04 86 , 34 21 6 772 867 , 93179160 , 54 23 93 | |

New partnumbers on stock - according to applications

04/2011



| | | | | | | | |
|--|--|--|--|--|--------------------|-------------------------------|--|
| | | | | | Description | OE numbers per ATE pn. | e.g. replaced pn. / miscellaneous |
|--|--|--|--|--|--------------------|-------------------------------|--|

RENAULT

| | | | | | | | | | |
|---|-----------------|--|---------|---------|----------------|--------|------------------|---|--|
| CLIO III (BR_/CR_) (05-) | 1,6 16V GT | | 04.2009 | | 24.0101-3803.2 | 260101 | INSTALLATION KIT | 4439 36 , 001 421 04 86 , 34 21 6 772 867 , 93179160 , 54 23 93 | |
| CLIO III Grandtour (KR_) (08-) | 1,2 16V | | 02.2008 | | 24.0101-3803.2 | 260101 | INSTALLATION KIT | 4439 36 , 001 421 04 86 , 34 21 6 772 867 , 93179160 , 54 23 93 | |
| | 1,2 16V Hi-Flex | | 07.2008 | | 24.0101-3803.2 | 260101 | INSTALLATION KIT | 4439 36 , 001 421 04 86 , 34 21 6 772 867 , 93179160 , 54 23 93 | |
| | 1,4 16V | | 02.2010 | | 24.0101-3803.2 | 260101 | INSTALLATION KIT | 4439 36 , 001 421 04 86 , 34 21 6 772 867 , 93179160 , 54 23 93 | |
| | 1,5 dCi | | 02.2008 | | 24.0101-3803.2 | 260101 | INSTALLATION KIT | 4439 36 , 001 421 04 86 , 34 21 6 772 867 , 93179160 , 54 23 93 | |
| | 1,6 16V | | 11.2008 | | 24.0101-3803.2 | 260101 | INSTALLATION KIT | 4439 36 , 001 421 04 86 , 34 21 6 772 867 , 93179160 , 54 23 93 | |
| | | | 02.2008 | | 24.0101-3803.2 | 260101 | INSTALLATION KIT | 4439 36 , 001 421 04 86 , 34 21 6 772 867 , 93179160 , 54 23 93 | |
| MEGANE II Coupe/Convertible (EM_) (03-) | 1,5 dCi | | 05.2007 | 06.2009 | 24.0101-3803.2 | 260101 | INSTALLATION KIT | 4439 36 , 001 421 04 86 , 34 21 6 772 867 , 93179160 , 54 23 93 | |
| | | | 05.2007 | 06.2008 | 24.0101-3803.2 | 260101 | INSTALLATION KIT | 4439 36 , 001 421 04 86 , 34 21 6 772 867 , 93179160 , 54 23 93 | |
| | | | 01.2007 | 04.2007 | 24.0101-3803.2 | 260101 | INSTALLATION KIT | 4439 36 , 001 421 04 86 , 34 21 6 772 867 , 93179160 , 54 23 93 | |

New partnumbers on stock - according to applications

04/2011



| | | | | | | | | |
|--|--|--|--|--|-------------|------------------------|--|-----------------------------------|
| | | | | | Description | OE numbers per ATE pn. | | e.g. replaced pn. / miscellaneous |
|--|--|--|--|--|-------------|------------------------|--|-----------------------------------|

RENAULT

| Model | Engine | Start | End | ATE Part No. | ATE Part No. | Description | OE numbers | Notes |
|---|---------|---------|---------|----------------|--------------|------------------|---|-------|
| MEGANE II Coupe/Convertible (EM_) (03-) | 1,5 dCi | 03.2006 | 04.2007 | 24.0101-3803.2 | 260101 | INSTALLATION KIT | 4439 36 , 001 421 04 86 , 34 21 6 772 867 , 93179160 , 54 23 93 | |
| | | 05.2007 | | 24.0101-3803.2 | 260101 | INSTALLATION KIT | 4439 36 , 001 421 04 86 , 34 21 6 772 867 , 93179160 , 54 23 93 | |
| | | 05.2005 | 04.2007 | 24.0101-3803.2 | 260101 | INSTALLATION KIT | 4439 36 , 001 421 04 86 , 34 21 6 772 867 , 93179160 , 54 23 93 | |
| | 1,6 16V | 05.2007 | | 24.0101-3803.2 | 260101 | INSTALLATION KIT | 4439 36 , 001 421 04 86 , 34 21 6 772 867 , 93179160 , 54 23 93 | |
| | | 01.2007 | 04.2007 | 24.0101-3803.2 | 260101 | INSTALLATION KIT | 4439 36 , 001 421 04 86 , 34 21 6 772 867 , 93179160 , 54 23 93 | |
| | | 06.2005 | 04.2007 | 24.0101-3803.2 | 260101 | INSTALLATION KIT | 4439 36 , 001 421 04 86 , 34 21 6 772 867 , 93179160 , 54 23 93 | |
| | | 09.2003 | 04.2007 | 24.0101-3803.2 | 260101 | INSTALLATION KIT | 4439 36 , 001 421 04 86 , 34 21 6 772 867 , 93179160 , 54 23 93 | |
| | 1,9 dCi | 09.2003 | 04.2007 | 24.0101-3803.2 | 260101 | INSTALLATION KIT | 4439 36 , 001 421 04 86 , 34 21 6 772 867 , 93179160 , 54 23 93 | |
| | | 05.2005 | 04.2007 | 24.0101-3803.2 | 260101 | INSTALLATION KIT | 4439 36 , 001 421 04 86 , 34 21 6 772 867 , 93179160 , 54 23 93 | |
| | | 01.2006 | 04.2007 | 24.0101-3803.2 | 260101 | INSTALLATION KIT | 4439 36 , 001 421 04 86 , 34 21 6 772 867 , 93179160 , 54 23 93 | |

New partnumbers on stock - according to applications

04/2011



| | | | | | | | |
|--|--|--|--|--|--------------------|-------------------------------|--|
| | | | | | Description | OE numbers per ATE pn. | e.g. replaced pn. / miscellaneous |
|--|--|--|--|--|--------------------|-------------------------------|--|

RENAULT

| | | | | | | | | | |
|---|---------------|--|---------|---------|----------------|--------|------------------|---|--|
| MEGANE II Coupe/Convertible (EM_) (03-) | 1,9 dCi | | 05.2007 | | 24.0101-3803.2 | 260101 | INSTALLATION KIT | 4439 36 , 001 421 04 86 , 34 21 6 772 867 , 93179160 , 54 23 93 | |
| | | | 05.2005 | 02.2007 | 24.0101-3803.2 | 260101 | INSTALLATION KIT | 4439 36 , 001 421 04 86 , 34 21 6 772 867 , 93179160 , 54 23 93 | |
| | 2,0 16V | | 09.2003 | 03.2007 | 24.0101-3803.2 | 260101 | INSTALLATION KIT | 4439 36 , 001 421 04 86 , 34 21 6 772 867 , 93179160 , 54 23 93 | |
| | 2,0 16V Turbo | | 05.2007 | | 24.0101-3803.2 | 260101 | INSTALLATION KIT | 4439 36 , 001 421 04 86 , 34 21 6 772 867 , 93179160 , 54 23 93 | |
| | | | 05.2004 | 04.2007 | 24.0101-3803.2 | 260101 | INSTALLATION KIT | 4439 36 , 001 421 04 86 , 34 21 6 772 867 , 93179160 , 54 23 93 | |
| | 2,0 dCi | | 09.2005 | | 24.0124-0223.1 | 424223 | BRAKE DISC | 77 01 208 848 | |
| | | | 05.2007 | | 24.0101-3803.2 | 260101 | INSTALLATION KIT | 4439 36 , 001 421 04 86 , 34 21 6 772 867 , 93179160 , 54 23 93 | |
| | | | 09.2005 | 04.2007 | 24.0101-3803.2 | 260101 | INSTALLATION KIT | 4439 36 , 001 421 04 86 , 34 21 6 772 867 , 93179160 , 54 23 93 | |
| MEGANE II Grandtour (KM_) (03-) | 1,4 16V | | 09.2003 | 04.2007 | 24.0101-3803.2 | 260101 | INSTALLATION KIT | 4439 36 , 001 421 04 86 , 34 21 6 772 867 , 93179160 , 54 23 93 | |
| | | | 05.2007 | | 24.0101-3803.2 | 260101 | INSTALLATION KIT | 4439 36 , 001 421 04 86 , 34 21 6 772 867 , 93179160 , 54 23 93 | |
| | 1,5 dCi | | 05.2007 | 06.2008 | 24.0101-3803.2 | 260101 | INSTALLATION KIT | 4439 36 , 001 421 04 86 , 34 21 6 772 867 , 93179160 , 54 23 93 | |

New partnumbers on stock - according to applications

04/2011



| | | | | | | | |
|--|----------|--|--|--|--------------------|-------------------------------|---|
| | i | | | | Description | OE numbers per ATE pn. | i e.g. replaced pn. / miscellaneous |
|--|----------|--|--|--|--------------------|-------------------------------|---|

RENAULT

| Model | Engine | Start | End | ATE Part No. | ATE Part No. | Description | OE numbers | Notes |
|---------------------------------|--------------|---------|---------|----------------|--------------|------------------|---|-------|
| MEGANE II Grandtour (KM_) (03-) | 1,5 dCi | 09.2003 | 05.2006 | 24.0101-3803.2 | 260101 | INSTALLATION KIT | 4439 36 , 001 421 04 86 , 34 21 6 772 867 , 93179160 , 54 23 93 | |
| | | 05.2005 | 04.2007 | 24.0101-3803.2 | 260101 | INSTALLATION KIT | 4439 36 , 001 421 04 86 , 34 21 6 772 867 , 93179160 , 54 23 93 | |
| | | 01.2007 | 04.2007 | 24.0101-3803.2 | 260101 | INSTALLATION KIT | 4439 36 , 001 421 04 86 , 34 21 6 772 867 , 93179160 , 54 23 93 | |
| | | 05.2007 | | 24.0101-3803.2 | 260101 | INSTALLATION KIT | 4439 36 , 001 421 04 86 , 34 21 6 772 867 , 93179160 , 54 23 93 | |
| | | 02.2004 | 03.2006 | 24.0101-3803.2 | 260101 | INSTALLATION KIT | 4439 36 , 001 421 04 86 , 34 21 6 772 867 , 93179160 , 54 23 93 | |
| | 1,6 16V | 05.2007 | | 24.0101-3803.2 | 260101 | INSTALLATION KIT | 4439 36 , 001 421 04 86 , 34 21 6 772 867 , 93179160 , 54 23 93 | |
| | | 01.2007 | 04.2007 | 24.0101-3803.2 | 260101 | INSTALLATION KIT | 4439 36 , 001 421 04 86 , 34 21 6 772 867 , 93179160 , 54 23 93 | |
| | | 09.2003 | 04.2007 | 24.0101-3803.2 | 260101 | INSTALLATION KIT | 4439 36 , 001 421 04 86 , 34 21 6 772 867 , 93179160 , 54 23 93 | |
| | 1,6 FlexFuel | 02.2008 | | 24.0101-3803.2 | 260101 | INSTALLATION KIT | 4439 36 , 001 421 04 86 , 34 21 6 772 867 , 93179160 , 54 23 93 | |
| | 1,9 dCi | 05.2007 | | 24.0101-3803.2 | 260101 | INSTALLATION KIT | 4439 36 , 001 421 04 86 , 34 21 6 772 867 , 93179160 , 54 23 93 | |

New partnumbers on stock - according to applications

04/2011



| | | | | | | | | |
|--|--|--|--|--|-------------|------------------------|--|-----------------------------------|
| | | | | | Description | OE numbers per ATE pn. | | e.g. replaced pn. / miscellaneous |
|--|--|--|--|--|-------------|------------------------|--|-----------------------------------|

RENAULT

| | | | | | | | | | |
|--|---------|--|---------|---------|----------------|--------|------------------|---|--|
| MEGANE II Grandtour (KM_) (03-) | 1,9 dCi | | 09.2003 | 04.2007 | 24.0101-3803.2 | 260101 | INSTALLATION KIT | 4439 36 , 001 421 04 86 , 34 21 6 772 867 , 93179160 , 54 23 93 | |
| | | | 05.2005 | 04.2007 | 24.0101-3803.2 | 260101 | INSTALLATION KIT | 4439 36 , 001 421 04 86 , 34 21 6 772 867 , 93179160 , 54 23 93 | |
| | | | 05.2005 | 02.2007 | 24.0101-3803.2 | 260101 | INSTALLATION KIT | 4439 36 , 001 421 04 86 , 34 21 6 772 867 , 93179160 , 54 23 93 | |
| | | | 03.2004 | 02.2007 | 24.0101-3803.2 | 260101 | INSTALLATION KIT | 4439 36 , 001 421 04 86 , 34 21 6 772 867 , 93179160 , 54 23 93 | |
| | 2,0 16V | | 05.2007 | | 24.0101-3803.2 | 260101 | INSTALLATION KIT | 4439 36 , 001 421 04 86 , 34 21 6 772 867 , 93179160 , 54 23 93 | |
| | | | 09.2003 | 04.2007 | 24.0101-3803.2 | 260101 | INSTALLATION KIT | 4439 36 , 001 421 04 86 , 34 21 6 772 867 , 93179160 , 54 23 93 | |
| | 2,0 dCi | | 09.2005 | | 24.0124-0223.1 | 424223 | BRAKE DISC | 77 01 208 848 | |
| | | | 05.2007 | | 24.0101-3803.2 | 260101 | INSTALLATION KIT | 4439 36 , 001 421 04 86 , 34 21 6 772 867 , 93179160 , 54 23 93 | |
| | | | 09.2005 | 04.2007 | 24.0101-3803.2 | 260101 | INSTALLATION KIT | 4439 36 , 001 421 04 86 , 34 21 6 772 867 , 93179160 , 54 23 93 | |
| MEGANE II Saloon 3/5-door(BM_/CM_) (02-) | 1,4 16V | | | | 24.0101-3803.2 | 260101 | INSTALLATION KIT | 4439 36 , 001 421 04 86 , 34 21 6 772 867 , 93179160 , 54 23 93 | |
| | 1,5 dCi | | | | 24.0101-3803.2 | 260101 | INSTALLATION KIT | 4439 36 , 001 421 04 86 , 34 21 6 772 867 , 93179160 , 54 23 93 | |

New partnumbers on stock - according to applications

04/2011



| | | | | | | | |
|--|--|--|--|--|-------------|------------------------|---------------------------------------|
| | | | | | Description | OE numbers per ATE pn. | e.g. replaced pn. / miscellaneous |
|--|--|--|--|--|-------------|------------------------|---------------------------------------|

RENAULT

| | | | | | | | | | |
|--|---------------|--|---------|---------|----------------|--------|------------------|---|--|
| MEGANE II Saloon 3/5-door(BM_/CM_) (02-) | 1,6 16V | | | | 24.0101-3803.2 | 260101 | INSTALLATION KIT | 4439 36 , 001 421 04 86 , 34 21 6 772 867 , 93179160 , 54 23 93 | |
| | 1,6 FlexFuel | | | | 24.0101-3803.2 | 260101 | INSTALLATION KIT | 4439 36 , 001 421 04 86 , 34 21 6 772 867 , 93179160 , 54 23 93 | |
| | 1,9 dCi | | | | 24.0101-3803.2 | 260101 | INSTALLATION KIT | 4439 36 , 001 421 04 86 , 34 21 6 772 867 , 93179160 , 54 23 93 | |
| | 2,0 16V | | | | 24.0101-3803.2 | 260101 | INSTALLATION KIT | 4439 36 , 001 421 04 86 , 34 21 6 772 867 , 93179160 , 54 23 93 | |
| | 2,0 16V Sport | | | | 24.0101-3803.2 | 260101 | INSTALLATION KIT | 4439 36 , 001 421 04 86 , 34 21 6 772 867 , 93179160 , 54 23 93 | |
| | 2,0 16V Turbo | | | | 24.0101-3803.2 | 260101 | INSTALLATION KIT | 4439 36 , 001 421 04 86 , 34 21 6 772 867 , 93179160 , 54 23 93 | |
| | 2,0 dCi | | 05.2009 | | 24.0124-0223.1 | 424223 | BRAKE DISC | 77 01 208 848 | |
| | | | | | 24.0101-3803.2 | 260101 | INSTALLATION KIT | 4439 36 , 001 421 04 86 , 34 21 6 772 867 , 93179160 , 54 23 93 | |
| MEGANE II Saloon 4-door (LM_) (03-) | 1,4 16V | | | | 24.0101-3803.2 | 260101 | INSTALLATION KIT | 4439 36 , 001 421 04 86 , 34 21 6 772 867 , 93179160 , 54 23 93 | |
| | | | | 08.2006 | 24.0101-3803.2 | 260101 | INSTALLATION KIT | 4439 36 , 001 421 04 86 , 34 21 6 772 867 , 93179160 , 54 23 93 | |
| | 1,5 dCi | | | 03.2006 | 24.0101-3803.2 | 260101 | INSTALLATION KIT | 4439 36 , 001 421 04 86 , 34 21 6 772 867 , 93179160 , 54 23 93 | |

New partnumbers on stock - according to applications

04/2011







| | | | | | | | |
|--|--|--|--|--|--------------------|-------------------------------|--|
| | | | | | Description | OE numbers per ATE pn. | e.g. replaced pn. / miscellaneous |
|--|--|--|--|--|--------------------|-------------------------------|--|

RENAULT

| | | | | | | | | | |
|-------------------------------------|---------|--|---------|---------|----------------|--------|------------------|---|--|
| MEGANE II Saloon 4-door (LM_) (03-) | 1,5 dCi | | | | 24.0101-3803.2 | 260101 | INSTALLATION KIT | 4439 36 , 001 421 04 86 , 34 21 6 772 867 , 93179160 , 54 23 93 | |
| | | | 01.2007 | | 24.0101-3803.2 | 260101 | INSTALLATION KIT | 4439 36 , 001 421 04 86 , 34 21 6 772 867 , 93179160 , 54 23 93 | |
| | 1,6 16V | | | | 24.0101-3803.2 | 260101 | INSTALLATION KIT | 4439 36 , 001 421 04 86 , 34 21 6 772 867 , 93179160 , 54 23 93 | |
| | | | 01.2007 | | 24.0101-3803.2 | 260101 | INSTALLATION KIT | 4439 36 , 001 421 04 86 , 34 21 6 772 867 , 93179160 , 54 23 93 | |
| | 1,9 dCi | | | | 24.0101-3803.2 | 260101 | INSTALLATION KIT | 4439 36 , 001 421 04 86 , 34 21 6 772 867 , 93179160 , 54 23 93 | |
| | | | | 12.2005 | 24.0101-3803.2 | 260101 | INSTALLATION KIT | 4439 36 , 001 421 04 86 , 34 21 6 772 867 , 93179160 , 54 23 93 | |
| | 2,0 16V | | | | 24.0101-3803.2 | 260101 | INSTALLATION KIT | 4439 36 , 001 421 04 86 , 34 21 6 772 867 , 93179160 , 54 23 93 | |
| | 2,0 dCi | | 09.2005 | | 24.0124-0223.1 | 424223 | BRAKE DISC | 77 01 208 848 | |
| | | | 09.2005 | | 24.0101-3803.2 | 260101 | INSTALLATION KIT | 4439 36 , 001 421 04 86 , 34 21 6 772 867 , 93179160 , 54 23 93 | |
| MODUS/GRAND MODUS (JP0_) (04+) | 1,2 16V | | 08.2004 | | 24.0101-3803.2 | 260101 | INSTALLATION KIT | 4439 36 , 001 421 04 86 , 34 21 6 772 867 , 93179160 , 54 23 93 | |
| | | | 05.2005 | | 24.0101-3803.2 | 260101 | INSTALLATION KIT | 4439 36 , 001 421 04 86 , 34 21 6 772 867 , 93179160 , 54 23 93 | |



| | | | | | | |
|---|---|--|---|--------------------|-------------------------------|---|
|  |  |  |  | Description | OE numbers per ATE pn. |  e.g. replaced pn. / miscellaneous |
|---|---|--|---|--------------------|-------------------------------|---|

RENAULT

| | | | | | | | | | |
|--------------------------------|-----------------|--|---------|---------|----------------|--------|------------------|---|--|
| MODUS/GRAND MODUS (JP0_) (04-) | 1,2 16V | | 05.2007 | | 24.0101-3803.2 | 260101 | INSTALLATION KIT | 4439 36 , 001 421 04 86 , 34 21 6 772 867 , 93179160 , 54 23 93 | |
| | 1,2 16V Hi-Flex | | 10.2008 | | 24.0101-3803.2 | 260101 | INSTALLATION KIT | 4439 36 , 001 421 04 86 , 34 21 6 772 867 , 93179160 , 54 23 93 | |
| | 1,4 16V | | 08.2004 | | 24.0101-3803.2 | 260101 | INSTALLATION KIT | 4439 36 , 001 421 04 86 , 34 21 6 772 867 , 93179160 , 54 23 93 | |
| | 1,5 dCi | | 05.2005 | | 24.0101-3803.2 | 260101 | INSTALLATION KIT | 4439 36 , 001 421 04 86 , 34 21 6 772 867 , 93179160 , 54 23 93 | |
| | | | 05.2007 | | 24.0101-3803.2 | 260101 | INSTALLATION KIT | 4439 36 , 001 421 04 86 , 34 21 6 772 867 , 93179160 , 54 23 93 | |
| | | | 08.2004 | | 24.0101-3803.2 | 260101 | INSTALLATION KIT | 4439 36 , 001 421 04 86 , 34 21 6 772 867 , 93179160 , 54 23 93 | |
| | 1,6 16V | | 08.2004 | | 24.0101-3803.2 | 260101 | INSTALLATION KIT | 4439 36 , 001 421 04 86 , 34 21 6 772 867 , 93179160 , 54 23 93 | |
| SCENIC II (JM_) (03-09) | 1,4 16V | | 06.2003 | 03.2009 | 24.0101-3803.2 | 260101 | INSTALLATION KIT | 4439 36 , 001 421 04 86 , 34 21 6 772 867 , 93179160 , 54 23 93 | |
| | 1,5 dCi | | 05.2005 | 03.2009 | 24.0101-3803.2 | 260101 | INSTALLATION KIT | 4439 36 , 001 421 04 86 , 34 21 6 772 867 , 93179160 , 54 23 93 | |
| | | | 06.2003 | 03.2009 | 24.0101-3803.2 | 260101 | INSTALLATION KIT | 4439 36 , 001 421 04 86 , 34 21 6 772 867 , 93179160 , 54 23 93 | |

New partnumbers on stock - according to applications

04/2011



| | | | | | | | | |
|--|--|--|--|--|-------------|------------------------|--|-----------------------------------|
| | | | | | Description | OE numbers per ATE pn. | | e.g. replaced pn. / miscellaneous |
|--|--|--|--|--|-------------|------------------------|--|-----------------------------------|







RENAULT

| | | | | | | | | | |
|-----------------------------------|---------------|--|---------|---------|----------------|--------|------------------|---|--|
| SCENIC II (JM_) (03-09) | 1,5 dCi | | 11.2003 | 03.2009 | 24.0101-3803.2 | 260101 | INSTALLATION KIT | 4439 36 , 001 421 04 86 , 34 21 6 772 867 , 93179160 , 54 23 93 | |
| | 1,6 | | 06.2006 | 03.2009 | 24.0101-3803.2 | 260101 | INSTALLATION KIT | 4439 36 , 001 421 04 86 , 34 21 6 772 867 , 93179160 , 54 23 93 | |
| | 1,6 16V | | 06.2003 | 03.2009 | 24.0101-3803.2 | 260101 | INSTALLATION KIT | 4439 36 , 001 421 04 86 , 34 21 6 772 867 , 93179160 , 54 23 93 | |
| | 1,9 D | | 06.2006 | 03.2009 | 24.0101-3803.2 | 260101 | INSTALLATION KIT | 4439 36 , 001 421 04 86 , 34 21 6 772 867 , 93179160 , 54 23 93 | |
| | 1,9 dCi | | 06.2003 | 03.2009 | 24.0101-3803.2 | 260101 | INSTALLATION KIT | 4439 36 , 001 421 04 86 , 34 21 6 772 867 , 93179160 , 54 23 93 | |
| | | | 05.2005 | 03.2009 | 24.0101-3803.2 | 260101 | INSTALLATION KIT | 4439 36 , 001 421 04 86 , 34 21 6 772 867 , 93179160 , 54 23 93 | |
| | 2,0 16V | | 06.2003 | 03.2009 | 24.0101-3803.2 | 260101 | INSTALLATION KIT | 4439 36 , 001 421 04 86 , 34 21 6 772 867 , 93179160 , 54 23 93 | |
| | 2,0 16V Turbo | | 05.2004 | 03.2009 | 24.0101-3803.2 | 260101 | INSTALLATION KIT | 4439 36 , 001 421 04 86 , 34 21 6 772 867 , 93179160 , 54 23 93 | |
| | 2,0 dCi 110 | | 09.2005 | 03.2009 | 24.0101-3803.2 | 260101 | INSTALLATION KIT | 4439 36 , 001 421 04 86 , 34 21 6 772 867 , 93179160 , 54 23 93 | |
| TRAFIC I Van (TXX) (89-01) | 2,5 D 4x4 | | 11.1997 | 03.2001 | 24.0225-4019.1 | 480305 | BRAKE DRUM | 77 00 692 363 | |
| TRAFIC I PROPULSION (PXX) (89-97) | 1,7 | | 05.1989 | 08.1994 | 24.0225-4019.1 | 480305 | BRAKE DRUM | 77 00 692 363 | |

New partnumbers on stock - according to applications

04/2011



| | | | | | | | |
|---|---|---|---|---|--------------------|-------------------------------|---|
|  |  |  |  |  | Description | OE numbers per ATE pn. |  e.g. replaced pn. / miscellaneous |
|---|---|---|---|---|--------------------|-------------------------------|---|

RENAULT

| Application | Version | Start | End | ATE PN | ATE PN | Description | OE numbers | Notes |
|-----------------------------------|---------------|---------|---------|----------------|--------|------------------|---|-------|
| TRAFIC I PROPULSION (PXX) (89-97) | 2 | 05.1989 | 10.1997 | 24.0225-4019.1 | 480305 | BRAKE DRUM | 77 00 692 363 | |
| | 2,1 D | 06.1994 | 10.1997 | 24.0225-4019.1 | 480305 | BRAKE DRUM | 77 00 692 363 | |
| | | 05.1989 | 06.1994 | 24.0225-4019.1 | 480305 | BRAKE DRUM | 77 00 692 363 | |
| TWINGO II (CN0_) (07-) | 1,2 | 03.2007 | | 03.0137-0498.2 | 650498 | BRAKE SHOE SET | 77 01 209 586 | |
| | 1,2 16V | 03.2007 | | 03.0137-0498.2 | 650498 | BRAKE SHOE SET | 77 01 209 586 | |
| | 1,2 Turbo | 03.2007 | | 03.0137-0498.2 | 650498 | BRAKE SHOE SET | 77 01 209 586 | |
| | 1,5 dCi | 03.2007 | | 03.0137-0498.2 | 650498 | BRAKE SHOE SET | 77 01 209 586 | |
| | | 04.2008 | | 03.0137-0498.2 | 650498 | BRAKE SHOE SET | 77 01 209 586 | |
| | 1,6 RS | 05.2008 | | 24.0101-3803.2 | 260101 | INSTALLATION KIT | 4439 36 , 001 421 04 86 , 34 21 6 772 867 , 93179160 , 54 23 93 | |
| WIND (E4M_) (10-) | 1,2 16V Turbo | 07.2010 | | 24.0101-3803.2 | 260101 | INSTALLATION KIT | 4439 36 , 001 421 04 86 , 34 21 6 772 867 , 93179160 , 54 23 93 | |
| | 1,6 16V | 07.2010 | | 24.0101-3803.2 | 260101 | INSTALLATION KIT | 4439 36 , 001 421 04 86 , 34 21 6 772 867 , 93179160 , 54 23 93 | |

New partnumbers on stock - according to applications

04/2011



| | | | | | | | |
|--|--|--|--|--|--------------------|-------------------------------|--|
| | | | | | Description | OE numbers per ATE pn. | e.g. replaced pn. / miscellaneous |
|--|--|--|--|--|--------------------|-------------------------------|--|

SEAT

| | | | | | | | | | |
|-------------------|-----------|--|---------|--|----------------|--------|--------------------|---|--|
| ALHAMBRA II (10-) | 1,4 TSI | | 09.2010 | | 03.4153-0186.3 | 010816 | TANDEM MASTER CYL. | 3C1 614 019 A , 3C1 614 019 E , 3C1 614 019 C | |
| | 2,0 TDI | | 09.2010 | | 03.4153-0186.3 | 010816 | TANDEM MASTER CYL. | 3C1 614 019 A , 3C1 614 019 E , 3C1 614 019 C | |
| | 2,0 TSI | | 09.2010 | | 03.4153-0186.3 | 010816 | TANDEM MASTER CYL. | 3C1 614 019 A , 3C1 614 019 E , 3C1 614 019 C | |
| ALTEA (5P1) (04-) | 1,2 TSI | | 04.2010 | | 24.2415-1711.3 | 030130 | CLUTCH CYLINDER | 1K0 721 388 G , 1K0 721 388 L , 1K0 721 388 F , 1K0 721 388 M , 1K0 721 388 S , 1K0 721 388 B | |
| | 1,4 i 16V | | 05.2006 | | 24.2415-1711.3 | 030130 | CLUTCH CYLINDER | 1K0 721 388 G , 1K0 721 388 L , 1K0 721 388 F , 1K0 721 388 M , 1K0 721 388 S , 1K0 721 388 B | |
| | 1,4 TSI | | 11.2007 | | 24.2415-1711.3 | 030130 | CLUTCH CYLINDER | 1K0 721 388 G , 1K0 721 388 L , 1K0 721 388 F , 1K0 721 388 M , 1K0 721 388 S , 1K0 721 388 B | |
| | 1,6 i 16V | | 03.2004 | | 24.2415-1711.3 | 030130 | CLUTCH CYLINDER | 1K0 721 388 G , 1K0 721 388 L , 1K0 721 388 F , 1K0 721 388 M , 1K0 721 388 S , 1K0 721 388 B | |
| | 1,6 LPG | | 09.2009 | | 24.2415-1711.3 | 030130 | CLUTCH CYLINDER | 1K0 721 388 G , 1K0 721 388 L , 1K0 721 388 F , 1K0 721 388 M , 1K0 721 388 S , 1K0 721 388 B | |
| | 1,6 TDI | | 10.2009 | | 24.2415-1711.3 | 030130 | CLUTCH CYLINDER | 1K0 721 388 G , 1K0 721 388 L , 1K0 721 388 F , 1K0 721 388 M , 1K0 721 388 S , 1K0 721 388 B | |

New partnumbers on stock - according to applications

04/2011



| | | | | | | | |
|--|--|--|--|--|-------------|------------------------|---------------------------------------|
| | | | | | Description | OE numbers per ATE pn. | e.g. replaced pn. / miscellaneous |
|--|--|--|--|--|-------------|------------------------|---------------------------------------|





SEAT

| | | | | | | | | | |
|----------------------|-----------|--|---------|--|----------------|--------|-----------------|---|--|
| ALTEA (5P1) (04-) | 1,8 TFSI | | 01.2007 | | 24.2415-1711.3 | 030130 | CLUTCH CYLINDER | 1K0 721 388 G , 1K0 721 388 L , 1K0 721 388 F , 1K0 721 388 M , 1K0 721 388 S , 1K0 721 388 B | |
| | 1,9 TDI | | 03.2004 | | 24.2415-1711.3 | 030130 | CLUTCH CYLINDER | 1K0 721 388 G , 1K0 721 388 L , 1K0 721 388 F , 1K0 721 388 M , 1K0 721 388 S , 1K0 721 388 B | |
| | 2,0 FSI | | 03.2004 | | 24.2415-1711.3 | 030130 | CLUTCH CYLINDER | 1K0 721 388 G , 1K0 721 388 L , 1K0 721 388 F , 1K0 721 388 M , 1K0 721 388 S , 1K0 721 388 B | |
| | 2,0 i 16V | | 03.2004 | | 24.2415-1711.3 | 030130 | CLUTCH CYLINDER | 1K0 721 388 G , 1K0 721 388 L , 1K0 721 388 F , 1K0 721 388 M , 1K0 721 388 S , 1K0 721 388 B | |
| | 2,0 TDI | | 03.2004 | | 24.2415-1711.3 | 030130 | CLUTCH CYLINDER | 1K0 721 388 G , 1K0 721 388 L , 1K0 721 388 F , 1K0 721 388 M , 1K0 721 388 S , 1K0 721 388 B | |
| | | | 03.2006 | | 24.2415-1711.3 | 030130 | CLUTCH CYLINDER | 1K0 721 388 G , 1K0 721 388 L , 1K0 721 388 F , 1K0 721 388 M , 1K0 721 388 S , 1K0 721 388 B | |
| | 2,0 TFSI | | 03.2006 | | 24.2415-1711.3 | 030130 | CLUTCH CYLINDER | 1K0 721 388 G , 1K0 721 388 L , 1K0 721 388 F , 1K0 721 388 M , 1K0 721 388 S , 1K0 721 388 B | |
| ALTEA XL (5P5) (06-) | 1,2 TSI | | 04.2010 | | 24.2415-1711.3 | 030130 | CLUTCH CYLINDER | 1K0 721 388 G , 1K0 721 388 L , 1K0 721 388 F , 1K0 721 388 M , 1K0 721 388 S , 1K0 721 388 B | |

New partnumbers on stock - according to applications

04/2011



| | | | | | | |
|---|---|--|---|--------------------|-------------------------------|---|
|  |  |  |  | Description | OE numbers per ATE pn. |  e.g. replaced pn. / miscellaneous |
|---|---|--|---|--------------------|-------------------------------|---|

SEAT

| ALTEA XL (5P5) (06-) | 1,4 i 16V | | 05.2008 | | 24.2415-1711.3 | 030130 | CLUTCH CYLINDER | 1K0 721 388 G , 1K0 721 388 L , 1K0 721 388 F , 1K0 721 388 M , 1K0 721 388 S , 1K0 721 388 B | |
|----------------------|-----------|--|---------|--|----------------|--------|-----------------|---|--|
| | 1,4 TSI | | 11.2007 | | 24.2415-1711.3 | 030130 | CLUTCH CYLINDER | 1K0 721 388 G , 1K0 721 388 L , 1K0 721 388 F , 1K0 721 388 M , 1K0 721 388 S , 1K0 721 388 B | |
| | 1,6 i 16V | | 10.2006 | | 24.2415-1711.3 | 030130 | CLUTCH CYLINDER | 1K0 721 388 G , 1K0 721 388 L , 1K0 721 388 F , 1K0 721 388 M , 1K0 721 388 S , 1K0 721 388 B | |
| | 1,6 LPG | | 09.2009 | | 24.2415-1711.3 | 030130 | CLUTCH CYLINDER | 1K0 721 388 G , 1K0 721 388 L , 1K0 721 388 F , 1K0 721 388 M , 1K0 721 388 S , 1K0 721 388 B | |
| | 1,6 TDI | | 10.2009 | | 24.2415-1711.3 | 030130 | CLUTCH CYLINDER | 1K0 721 388 G , 1K0 721 388 L , 1K0 721 388 F , 1K0 721 388 M , 1K0 721 388 S , 1K0 721 388 B | |
| | 1,8 TFSI | | 10.2006 | | 24.2415-1711.3 | 030130 | CLUTCH CYLINDER | 1K0 721 388 G , 1K0 721 388 L , 1K0 721 388 F , 1K0 721 388 M , 1K0 721 388 S , 1K0 721 388 B | |
| | 1,9 TDI | | 10.2006 | | 24.2415-1711.3 | 030130 | CLUTCH CYLINDER | 1K0 721 388 G , 1K0 721 388 L , 1K0 721 388 F , 1K0 721 388 M , 1K0 721 388 S , 1K0 721 388 B | |
| | 2,0 FSI | | 10.2006 | | 24.2415-1711.3 | 030130 | CLUTCH CYLINDER | 1K0 721 388 G , 1K0 721 388 L , 1K0 721 388 F , 1K0 721 388 M , 1K0 721 388 S , 1K0 721 388 B | |

New partnumbers on stock - according to applications

04/2011



| | | | | | | | |
|--|--|--|--|--|--------------------|-------------------------------|--|
| | | | | | Description | OE numbers per ATE pn. | e.g. replaced pn. / miscellaneous |
|--|--|--|--|--|--------------------|-------------------------------|--|





SEAT

| | | | | | | | | | |
|----------------------|--------------|--|---------|--|----------------|--------|-----------------|---|--|
| ALTEA XL (5P5) (06-) | 2,0 TDI | | 10.2006 | | 24.2415-1711.3 | 030130 | CLUTCH CYLINDER | 1K0 721 388 G , 1K0 721 388 L , 1K0 721 388 F , 1K0 721 388 M , 1K0 721 388 S , 1K0 721 388 B | |
| | 2,0 TDI 4x4 | | 06.2007 | | 24.2415-1711.3 | 030130 | CLUTCH CYLINDER | 1K0 721 388 G , 1K0 721 388 L , 1K0 721 388 F , 1K0 721 388 M , 1K0 721 388 S , 1K0 721 388 B | |
| | 2,0 TFSI 4x4 | | 06.2007 | | 24.2415-1711.3 | 030130 | CLUTCH CYLINDER | 1K0 721 388 G , 1K0 721 388 L , 1K0 721 388 F , 1K0 721 388 M , 1K0 721 388 S , 1K0 721 388 B | |
| LEON II (1P1) (05-) | 1,2 TSI | | 02.2010 | | 24.2415-1711.3 | 030130 | CLUTCH CYLINDER | 1K0 721 388 G , 1K0 721 388 L , 1K0 721 388 F , 1K0 721 388 M , 1K0 721 388 S , 1K0 721 388 B | |
| | 1,4 i 16V | | 06.2006 | | 24.2415-1711.3 | 030130 | CLUTCH CYLINDER | 1K0 721 388 G , 1K0 721 388 L , 1K0 721 388 F , 1K0 721 388 M , 1K0 721 388 S , 1K0 721 388 B | |
| | | | 08.2005 | | 24.2415-1711.3 | 030130 | CLUTCH CYLINDER | 1K0 721 388 G , 1K0 721 388 L , 1K0 721 388 F , 1K0 721 388 M , 1K0 721 388 S , 1K0 721 388 B | |
| | 1,4 TSI | | 11.2007 | | 24.2415-1711.3 | 030130 | CLUTCH CYLINDER | 1K0 721 388 G , 1K0 721 388 L , 1K0 721 388 F , 1K0 721 388 M , 1K0 721 388 S , 1K0 721 388 B | |
| | 1,6 i | | 08.2005 | | 24.2415-1711.3 | 030130 | CLUTCH CYLINDER | 1K0 721 388 G , 1K0 721 388 L , 1K0 721 388 F , 1K0 721 388 M , 1K0 721 388 S , 1K0 721 388 B | |

New partnumbers on stock - according to applications

04/2011



| | | | | | | |
|---|---|--|---|--------------------|-------------------------------|---|
|  |  |  |  | Description | OE numbers per ATE pn. |  e.g. replaced pn. / miscellaneous |
|---|---|--|---|--------------------|-------------------------------|---|







SEAT

| Model | Engine | Year | Part No. | ATE No. | Description | OE numbers | Notes |
|---------------------|-------------------|---------|----------------|---------|-----------------|---|-------|
| LEON II (1P1) (05-) | 1,6 i 16V | 08.2005 | 24.2415-1711.3 | 030130 | CLUTCH CYLINDER | 1K0 721 388 G , 1K0 721 388 L , 1K0 721 388 F , 1K0 721 388 M , 1K0 721 388 S , 1K0 721 388 B | |
| | 1,6 LPG | 12.2009 | 24.2415-1711.3 | 030130 | CLUTCH CYLINDER | 1K0 721 388 G , 1K0 721 388 L , 1K0 721 388 F , 1K0 721 388 M , 1K0 721 388 S , 1K0 721 388 B | |
| | 1,6 TDI | 11.2010 | 24.2415-1711.3 | 030130 | CLUTCH CYLINDER | 1K0 721 388 G , 1K0 721 388 L , 1K0 721 388 F , 1K0 721 388 M , 1K0 721 388 S , 1K0 721 388 B | |
| | 1,6 TDI Ecomotive | 02.2010 | 24.2415-1711.3 | 030130 | CLUTCH CYLINDER | 1K0 721 388 G , 1K0 721 388 L , 1K0 721 388 F , 1K0 721 388 M , 1K0 721 388 S , 1K0 721 388 B | |
| | 1,8 T 20V | 08.2005 | 24.2415-1711.3 | 030130 | CLUTCH CYLINDER | 1K0 721 388 G , 1K0 721 388 L , 1K0 721 388 F , 1K0 721 388 M , 1K0 721 388 S , 1K0 721 388 B | |
| | 1,8 TSI | 06.2007 | 24.2415-1711.3 | 030130 | CLUTCH CYLINDER | 1K0 721 388 G , 1K0 721 388 L , 1K0 721 388 F , 1K0 721 388 M , 1K0 721 388 S , 1K0 721 388 B | |
| | 1,9 TDI | 08.2005 | 24.2415-1711.3 | 030130 | CLUTCH CYLINDER | 1K0 721 388 G , 1K0 721 388 L , 1K0 721 388 F , 1K0 721 388 M , 1K0 721 388 S , 1K0 721 388 B | |
| | 2,0 FSI | 08.2005 | 24.2415-1711.3 | 030130 | CLUTCH CYLINDER | 1K0 721 388 G , 1K0 721 388 L , 1K0 721 388 F , 1K0 721 388 M , 1K0 721 388 S , 1K0 721 388 B | |

New partnumbers on stock - according to applications

04/2011



| | | | | | | | |
|---|---|---|---|---|--------------------|-------------------------------|---|
|  |  |  |  |  | Description | OE numbers per ATE pn. |  e.g. replaced pn. / miscellaneous |
|---|---|---|---|---|--------------------|-------------------------------|---|





SEAT

| | | | | | | | | | |
|--------------------------|-----------|--|---------|---------|----------------|--------|-----------------|---|--|
| LEON II (1P1) (05-) | 2,0 i 16V | | 08.2005 | | 24.2415-1711.3 | 030130 | CLUTCH CYLINDER | 1K0 721 388 G , 1K0 721 388 L , 1K0 721 388 F , 1K0 721 388 M , 1K0 721 388 S , 1K0 721 388 B | |
| | 2,0 TDI | | 02.2006 | | 24.2415-1711.3 | 030130 | CLUTCH CYLINDER | 1K0 721 388 G , 1K0 721 388 L , 1K0 721 388 F , 1K0 721 388 M , 1K0 721 388 S , 1K0 721 388 B | |
| | | | 08.2005 | | 24.2415-1711.3 | 030130 | CLUTCH CYLINDER | 1K0 721 388 G , 1K0 721 388 L , 1K0 721 388 F , 1K0 721 388 M , 1K0 721 388 S , 1K0 721 388 B | |
| | 2,0 TFSI | | 11.2006 | | 24.2415-1711.3 | 030130 | CLUTCH CYLINDER | 1K0 721 388 G , 1K0 721 388 L , 1K0 721 388 F , 1K0 721 388 M , 1K0 721 388 S , 1K0 721 388 B | |
| | | | 08.2005 | | 24.2415-1711.3 | 030130 | CLUTCH CYLINDER | 1K0 721 388 G , 1K0 721 388 L , 1K0 721 388 F , 1K0 721 388 M , 1K0 721 388 S , 1K0 721 388 B | |
| | | | 09.2005 | | 24.2415-1711.3 | 030130 | CLUTCH CYLINDER | 1K0 721 388 G , 1K0 721 388 L , 1K0 721 388 F , 1K0 721 388 M , 1K0 721 388 S , 1K0 721 388 B | |
| TOLEDO III (5P2) (05-09) | 1,6 i 16V | | 10.2004 | 03.2009 | 24.2415-1711.3 | 030130 | CLUTCH CYLINDER | 1K0 721 388 G , 1K0 721 388 L , 1K0 721 388 F , 1K0 721 388 M , 1K0 721 388 S , 1K0 721 388 B | |
| | 1,8 TFSI | | 01.2007 | 03.2009 | 24.2415-1711.3 | 030130 | CLUTCH CYLINDER | 1K0 721 388 G , 1K0 721 388 L , 1K0 721 388 F , 1K0 721 388 M , 1K0 721 388 S , 1K0 721 388 B | |

New partnumbers on stock - according to applications

04/2011



| | | | | | | |
|---|---|--|---|--------------------|-------------------------------|---|
|  |  |  |  | Description | OE numbers per ATE pn. |  e.g. replaced pn. / miscellaneous |
|---|---|--|---|--------------------|-------------------------------|---|

SEAT

| | | | | | | | | | |
|--------------------------|-----------|--|---------|---------|----------------|--------|-----------------|---|--|
| TOLEDO III (5P2) (05-09) | 1,9 TDI | | 10.2004 | 03.2009 | 24.2415-1711.3 | 030130 | CLUTCH CYLINDER | 1K0 721 388 G , 1K0 721 388 L , 1K0 721 388 F , 1K0 721 388 M , 1K0 721 388 S , 1K0 721 388 B | |
| | 2,0 FSI | | 10.2004 | 03.2009 | 24.2415-1711.3 | 030130 | CLUTCH CYLINDER | 1K0 721 388 G , 1K0 721 388 L , 1K0 721 388 F , 1K0 721 388 M , 1K0 721 388 S , 1K0 721 388 B | |
| | 2,0 i 16V | | 10.2004 | 03.2009 | 24.2415-1711.3 | 030130 | CLUTCH CYLINDER | 1K0 721 388 G , 1K0 721 388 L , 1K0 721 388 F , 1K0 721 388 M , 1K0 721 388 S , 1K0 721 388 B | |
| | 2,0 TDI | | 01.2006 | 03.2009 | 24.2415-1711.3 | 030130 | CLUTCH CYLINDER | 1K0 721 388 G , 1K0 721 388 L , 1K0 721 388 F , 1K0 721 388 M , 1K0 721 388 S , 1K0 721 388 B | |
| | | | 10.2004 | 03.2009 | 24.2415-1711.3 | 030130 | CLUTCH CYLINDER | 1K0 721 388 G , 1K0 721 388 L , 1K0 721 388 F , 1K0 721 388 M , 1K0 721 388 S , 1K0 721 388 B | |
| | 2,0 TFSI | | 11.2005 | 03.2009 | 24.2415-1711.3 | 030130 | CLUTCH CYLINDER | 1K0 721 388 G , 1K0 721 388 L , 1K0 721 388 F , 1K0 721 388 M , 1K0 721 388 S , 1K0 721 388 B | |

New partnumbers on stock - according to applications

04/2011



| | | | | | | |
|--|--|--|--|--------------------|-------------------------------|--|
| | | | | Description | OE numbers per ATE pn. | e.g. replaced pn. / miscellaneous |
|--|--|--|--|--------------------|-------------------------------|--|

SKODA

| Model | Engine | Year | Part No. | ATE No. | Description | OE numbers | Notes |
|-----------------------|-------------|---------|----------------|---------|-----------------|---|-------|
| OCTAVIA II (1Z) (04-) | 1,2 TSI | 02.2010 | 24.2415-1711.3 | 030130 | CLUTCH CYLINDER | 1K0 721 388 G , 1K0 721 388 L , 1K0 721 388 F , 1K0 721 388 M , 1K0 721 388 S , 1K0 721 388 B | |
| | 1,4 i 16V | 06.2004 | 24.2415-1711.3 | 030130 | CLUTCH CYLINDER | 1K0 721 388 G , 1K0 721 388 L , 1K0 721 388 F , 1K0 721 388 M , 1K0 721 388 S , 1K0 721 388 B | |
| | 1,4 TSI | 11.2008 | 24.2415-1711.3 | 030130 | CLUTCH CYLINDER | 1K0 721 388 G , 1K0 721 388 L , 1K0 721 388 F , 1K0 721 388 M , 1K0 721 388 S , 1K0 721 388 B | |
| | 1,6 | 09.2009 | 24.2415-1711.3 | 030130 | CLUTCH CYLINDER | 1K0 721 388 G , 1K0 721 388 L , 1K0 721 388 F , 1K0 721 388 M , 1K0 721 388 S , 1K0 721 388 B | |
| | 1,6 FSI | 06.2004 | 24.2415-1711.3 | 030130 | CLUTCH CYLINDER | 1K0 721 388 G , 1K0 721 388 L , 1K0 721 388 F , 1K0 721 388 M , 1K0 721 388 S , 1K0 721 388 B | |
| | 1,6 i 16V | 06.2004 | 24.2415-1711.3 | 030130 | CLUTCH CYLINDER | 1K0 721 388 G , 1K0 721 388 L , 1K0 721 388 F , 1K0 721 388 M , 1K0 721 388 S , 1K0 721 388 B | |
| | 1,6 TDI | 06.2009 | 24.2415-1711.3 | 030130 | CLUTCH CYLINDER | 1K0 721 388 G , 1K0 721 388 L , 1K0 721 388 F , 1K0 721 388 M , 1K0 721 388 S , 1K0 721 388 B | |
| | 1,6 TDI 4x4 | 06.2009 | 24.2415-1711.3 | 030130 | CLUTCH CYLINDER | 1K0 721 388 G , 1K0 721 388 L , 1K0 721 388 F , 1K0 721 388 M , 1K0 721 388 S , 1K0 721 388 B | |



| | | | | | | | | |
|--|--|--|--|--|-------------|------------------------|--|-----------------------------------|
| | | | | | Description | OE numbers per ATE pn. | | e.g. replaced pn. / miscellaneous |
|--|--|--|--|--|-------------|------------------------|--|-----------------------------------|

SKODA

| | | | | | | | | | |
|-----------------------|-------------|--|---------|--|----------------|--------|-----------------|---|--|
| OCTAVIA II (1Z) (04-) | 1,8 TSI | | 06.2007 | | 24.2415-1711.3 | 030130 | CLUTCH CYLINDER | 1K0 721 388 G , 1K0 721 388 L , 1K0 721 388 F , 1K0 721 388 M , 1K0 721 388 S , 1K0 721 388 B | |
| | 1,8 TSI 4x4 | | 11.2008 | | 24.2415-1711.3 | 030130 | CLUTCH CYLINDER | 1K0 721 388 G , 1K0 721 388 L , 1K0 721 388 F , 1K0 721 388 M , 1K0 721 388 S , 1K0 721 388 B | |
| | 1,9 TDI | | 06.2004 | | 24.2415-1711.3 | 030130 | CLUTCH CYLINDER | 1K0 721 388 G , 1K0 721 388 L , 1K0 721 388 F , 1K0 721 388 M , 1K0 721 388 S , 1K0 721 388 B | |
| | 2,0 FSI | | 11.2004 | | 24.2415-1711.3 | 030130 | CLUTCH CYLINDER | 1K0 721 388 G , 1K0 721 388 L , 1K0 721 388 F , 1K0 721 388 M , 1K0 721 388 S , 1K0 721 388 B | |
| | 2,0 TDI | | 04.2008 | | 24.2415-1711.3 | 030130 | CLUTCH CYLINDER | 1K0 721 388 G , 1K0 721 388 L , 1K0 721 388 F , 1K0 721 388 M , 1K0 721 388 S , 1K0 721 388 B | |
| | | | 06.2004 | | 24.2415-1711.3 | 030130 | CLUTCH CYLINDER | 1K0 721 388 G , 1K0 721 388 L , 1K0 721 388 F , 1K0 721 388 M , 1K0 721 388 S , 1K0 721 388 B | |
| SUPERB II (08-) | 1,4 TSI | | 08.2008 | | 24.2415-1711.3 | 030130 | CLUTCH CYLINDER | 1K0 721 388 G , 1K0 721 388 L , 1K0 721 388 F , 1K0 721 388 M , 1K0 721 388 S , 1K0 721 388 B | |
| | 1,6 i 16V | | 08.2008 | | 24.2415-1711.3 | 030130 | CLUTCH CYLINDER | 1K0 721 388 G , 1K0 721 388 L , 1K0 721 388 F , 1K0 721 388 M , 1K0 721 388 S , 1K0 721 388 B | |

New partnumbers on stock - according to applications

04/2011



| | | | | | | | |
|--|--|--|--|--|--------------------|-------------------------------|--|
| | | | | | Description | OE numbers per ATE pn. | e.g. replaced pn. / miscellaneous |
|--|--|--|--|--|--------------------|-------------------------------|--|







SKODA

| | | | | | | | | | |
|---------------------|--------------|--|---------|--|----------------|--------|-----------------|---|--|
| SUPERB II (08-) | 1,8 TFSI | | 08.2008 | | 24.2415-1711.3 | 030130 | CLUTCH CYLINDER | 1K0 721 388 G , 1K0 721 388 L , 1K0 721 388 F , 1K0 721 388 M , 1K0 721 388 S , 1K0 721 388 B | |
| | 1,8 TFSI 4x4 | | 10.2008 | | 24.2415-1711.3 | 030130 | CLUTCH CYLINDER | 1K0 721 388 G , 1K0 721 388 L , 1K0 721 388 F , 1K0 721 388 M , 1K0 721 388 S , 1K0 721 388 B | |
| | 1,9 TDI | | 08.2008 | | 24.2415-1711.3 | 030130 | CLUTCH CYLINDER | 1K0 721 388 G , 1K0 721 388 L , 1K0 721 388 F , 1K0 721 388 M , 1K0 721 388 S , 1K0 721 388 B | |
| | 2,0 TDI | | 08.2008 | | 24.2415-1711.3 | 030130 | CLUTCH CYLINDER | 1K0 721 388 G , 1K0 721 388 L , 1K0 721 388 F , 1K0 721 388 M , 1K0 721 388 S , 1K0 721 388 B | |
| | 2,0 TDI 4x4 | | 10.2008 | | 24.2415-1711.3 | 030130 | CLUTCH CYLINDER | 1K0 721 388 G , 1K0 721 388 L , 1K0 721 388 F , 1K0 721 388 M , 1K0 721 388 S , 1K0 721 388 B | |
| | 3,6 V6 FSI | | 11.2008 | | 24.2415-1711.3 | 030130 | CLUTCH CYLINDER | 1K0 721 388 G , 1K0 721 388 L , 1K0 721 388 F , 1K0 721 388 M , 1K0 721 388 S , 1K0 721 388 B | |
| SUPERB Estate (09-) | 1,4 TSI | | 11.2009 | | 24.2415-1711.3 | 030130 | CLUTCH CYLINDER | 1K0 721 388 G , 1K0 721 388 L , 1K0 721 388 F , 1K0 721 388 M , 1K0 721 388 S , 1K0 721 388 B | |
| | 1,8 TSI | | 11.2009 | | 24.2415-1711.3 | 030130 | CLUTCH CYLINDER | 1K0 721 388 G , 1K0 721 388 L , 1K0 721 388 F , 1K0 721 388 M , 1K0 721 388 S , 1K0 721 388 B | |

New partnumbers on stock - according to applications

04/2011



| | | | | | | |
|---|---|---|---|--------------------|-------------------------------|---|
|  |  |   |  | Description | OE numbers per ATE pn. |  e.g. replaced pn. / miscellaneous |
|---|---|---|---|--------------------|-------------------------------|---|





SKODA

| | | | | | | | | | |
|---------------------|-------------|--|---------|--|----------------|--------|-----------------|---|--|
| SUPERB Estate (09-) | 1,8 TSI 4x4 | | 11.2009 | | 24.2415-1711.3 | 030130 | CLUTCH CYLINDER | 1K0 721 388 G , 1K0 721 388 L , 1K0 721 388 F , 1K0 721 388 M , 1K0 721 388 S , 1K0 721 388 B | |
| | 2,0 TDI | | 11.2009 | | 24.2415-1711.3 | 030130 | CLUTCH CYLINDER | 1K0 721 388 G , 1K0 721 388 L , 1K0 721 388 F , 1K0 721 388 M , 1K0 721 388 S , 1K0 721 388 B | |
| | 2,0 TDI 4x4 | | 11.2009 | | 24.2415-1711.3 | 030130 | CLUTCH CYLINDER | 1K0 721 388 G , 1K0 721 388 L , 1K0 721 388 F , 1K0 721 388 M , 1K0 721 388 S , 1K0 721 388 B | |
| | 3,6 V6 4x4 | | 11.2009 | | 24.2415-1711.3 | 030130 | CLUTCH CYLINDER | 1K0 721 388 G , 1K0 721 388 L , 1K0 721 388 F , 1K0 721 388 M , 1K0 721 388 S , 1K0 721 388 B | |
| YETI (09-) | 1,2 TSI | | 09.2009 | | 24.2415-1711.3 | 030130 | CLUTCH CYLINDER | 1K0 721 388 G , 1K0 721 388 L , 1K0 721 388 F , 1K0 721 388 M , 1K0 721 388 S , 1K0 721 388 B | |
| | 1,4 TSI | | 06.2010 | | 24.2415-1711.3 | 030130 | CLUTCH CYLINDER | 1K0 721 388 G , 1K0 721 388 L , 1K0 721 388 F , 1K0 721 388 M , 1K0 721 388 S , 1K0 721 388 B | |
| | 1,8 TSI 4x4 | | 05.2009 | | 24.2415-1711.3 | 030130 | CLUTCH CYLINDER | 1K0 721 388 G , 1K0 721 388 L , 1K0 721 388 F , 1K0 721 388 M , 1K0 721 388 S , 1K0 721 388 B | |
| | 2,0 TDI | | 11.2009 | | 24.2415-1711.3 | 030130 | CLUTCH CYLINDER | 1K0 721 388 G , 1K0 721 388 L , 1K0 721 388 F , 1K0 721 388 M , 1K0 721 388 S , 1K0 721 388 B | |

New partnumbers on stock - according to applications

04/2011



| | | | | | | | |
|---|---|---|---|---|--------------------|-------------------------------|---|
|  |  |  |  |  | Description | OE numbers per ATE pn. |  e.g. replaced pn. / miscellaneous |
|---|---|---|---|---|--------------------|-------------------------------|---|

SKODA

| | | | | | | | | | |
|------------|-------------|--|---------|--|----------------|--------|-----------------|---|--|
| YETI (09-) | 2,0 TDI 4x4 | | 11.2009 | | 24.2415-1711.3 | 030130 | CLUTCH CYLINDER | 1K0 721 388 G , 1K0 721 388 L , 1K0 721 388 F , 1K0 721 388 M , 1K0 721 388 S , 1K0 721 388 B | |
| | | | 05.2009 | | 24.2415-1711.3 | 030130 | CLUTCH CYLINDER | 1K0 721 388 G , 1K0 721 388 L , 1K0 721 388 F , 1K0 721 388 M , 1K0 721 388 S , 1K0 721 388 B | |







SUZUKI

| | | | | | | | | | |
|-----------------|---------------|--|---------|---------|----------------|--------|------------------|--|--|
| SPLASH (08-) | 1,0 i 12V | | 01.2008 | | 24.0101-3802.2 | 260100 | INSTALLATION KIT | 4439 36 , 77363365 , 169 421 01 86 , 4439 34 , 4439 44 | |
| | 1,2 i 16V | | 01.2008 | | 24.0101-3802.2 | 260100 | INSTALLATION KIT | 4439 36 , 77363365 , 169 421 01 86 , 4439 34 , 4439 44 | |
| | 1,3 CDTi | | 01.2008 | | 24.0101-3802.2 | 260100 | INSTALLATION KIT | 4439 36 , 77363365 , 169 421 01 86 , 4439 34 , 4439 44 | |
| SWIFT III (05-) | 1,3 DDIS | | 08.2005 | 09.2007 | 24.0101-3802.2 | 260100 | INSTALLATION KIT | 4439 36 , 77363365 , 169 421 01 86 , 4439 34 , 4439 44 | |
| | 1,3 i 16V | | 02.2005 | | 24.0101-3802.2 | 260100 | INSTALLATION KIT | 4439 36 , 77363365 , 169 421 01 86 , 4439 34 , 4439 44 | |
| | 1,3 i 16V 4x4 | | 01.2006 | | 24.0101-3802.2 | 260100 | INSTALLATION KIT | 4439 36 , 77363365 , 169 421 01 86 , 4439 34 , 4439 44 | |
| | 1,5 VVTi | | 02.2005 | | 24.0101-3802.2 | 260100 | INSTALLATION KIT | 4439 36 , 77363365 , 169 421 01 86 , 4439 34 , 4439 44 | |
| | 1,6 VVTi | | 05.2006 | | 24.0101-3802.2 | 260100 | INSTALLATION KIT | 4439 36 , 77363365 , 169 421 01 86 , 4439 34 , 4439 44 | |

New partnumbers on stock - according to applications

04/2011









| | | | | | | | |
|---|---|---|---|---|--------------------|-------------------------------|---|
|  |  |  |  |  | Description | OE numbers per ATE pn. |  e.g. replaced pn. / miscellaneous |
|---|---|---|---|---|--------------------|-------------------------------|---|

TOYOTA

| Model | Engine | Start | End | Application | ATE PN | Description | OE numbers | Notes |
|-----------------|-------------------|---------|---------|----------------|--------|--------------------|---|-------|
| AVENSIS (97-03) | 1,6 i 16V (AT220) | 09.1997 | 09.2000 | 03.2123-2221.3 | 010861 | TANDEM MASTER CYL. | 47201-05050 , 47201-05051 , 47201-05080 | |
| | 1,6 VVTi (ZZT220) | 10.2000 | 02.2003 | 03.2123-2221.3 | 010861 | TANDEM MASTER CYL. | 47201-05050 , 47201-05051 , 47201-05080 | |
| | 1,8 i 16V (AT221) | 09.1997 | 09.2000 | 03.2123-2221.3 | 010861 | TANDEM MASTER CYL. | 47201-05050 , 47201-05051 , 47201-05080 | |
| | 1,8 VVTi (ZZT221) | 10.2000 | 02.2003 | 03.2123-2221.3 | 010861 | TANDEM MASTER CYL. | 47201-05050 , 47201-05051 , 47201-05080 | |
| | 2,0 D4-D (CDT221) | 10.1999 | 02.2003 | 03.2123-2221.3 | 010861 | TANDEM MASTER CYL. | 47201-05050 , 47201-05051 , 47201-05080 | |
| | 2,0 i 16V (ST220) | 09.1997 | 09.2000 | 03.2123-2221.3 | 010861 | TANDEM MASTER CYL. | 47201-05050 , 47201-05051 , 47201-05080 | |
| | 2,0 TD (CT220) | 09.1997 | 02.2003 | 03.2123-2221.3 | 010861 | TANDEM MASTER CYL. | 47201-05050 , 47201-05051 , 47201-05080 | |
| | 2,0 VVTi (AZT220) | 10.2000 | 02.2003 | 03.2123-2221.3 | 010861 | TANDEM MASTER CYL. | 47201-05050 , 47201-05051 , 47201-05080 | |



| | | | | | | |
|---|---|---|---|--------------------|-------------------------------|--|
|  |  |   |  | Description | OE numbers per ATE pn. |  e.g. replaced pn. / miscellaneous |
|---|---|---|---|--------------------|-------------------------------|--|

VOLKSWAGEN

| CADDY III (04-) | 1,2 TSI | | 09.2010 | | 24.2415-1711.3 | 030130 | CLUTCH CYLINDER | 1K0 721 388 G , 1K0 721 388 L , 1K0 721 388 F , 1K0 721 388 M , 1K0 721 388 S , 1K0 721 388 B | |
|-----------------|---------|--|---------|--|----------------|--------|------------------|---|--|
| | | | | | 24.0101-3803.2 | 260101 | INSTALLATION KIT | 4439 36 , 001 421 04 86 , 34 21 6 772 867 , 93179160 , 54 23 93 | |
| | 1,4 | | 02.2004 | | 24.2415-1711.3 | 030130 | CLUTCH CYLINDER | 1K0 721 388 G , 1K0 721 388 L , 1K0 721 388 F , 1K0 721 388 M , 1K0 721 388 S , 1K0 721 388 B | |
| | | | | | 24.0101-3803.2 | 260101 | INSTALLATION KIT | 4439 36 , 001 421 04 86 , 34 21 6 772 867 , 93179160 , 54 23 93 | |
| | 1,4 16V | | 05.2006 | | 24.2415-1711.3 | 030130 | CLUTCH CYLINDER | 1K0 721 388 G , 1K0 721 388 L , 1K0 721 388 F , 1K0 721 388 M , 1K0 721 388 S , 1K0 721 388 B | |
| | | | | | 24.0101-3803.2 | 260101 | INSTALLATION KIT | 4439 36 , 001 421 04 86 , 34 21 6 772 867 , 93179160 , 54 23 93 | |
| | 1,6 | | 04.2004 | | 24.2415-1711.3 | 030130 | CLUTCH CYLINDER | 1K0 721 388 G , 1K0 721 388 L , 1K0 721 388 F , 1K0 721 388 M , 1K0 721 388 S , 1K0 721 388 B | |
| | | | | | 24.0101-3803.2 | 260101 | INSTALLATION KIT | 4439 36 , 001 421 04 86 , 34 21 6 772 867 , 93179160 , 54 23 93 | |
| | 1,6 TDI | | 08.2010 | | 24.2415-1711.3 | 030130 | CLUTCH CYLINDER | 1K0 721 388 G , 1K0 721 388 L , 1K0 721 388 F , 1K0 721 388 M , 1K0 721 388 S , 1K0 721 388 B | |

New partnumbers on stock - according to applications

04/2011



| | | | | | | | |
|--|--|--|--|--|--------------------|-------------------------------|--|
| | | | | | Description | OE numbers per ATE pn. | e.g. replaced pn. / miscellaneous |
|--|--|--|--|--|--------------------|-------------------------------|--|

VOLKSWAGEN

| | | | | | | | | | |
|-----------------|-----------------|--|---------|--|----------------|--------|------------------|---|--|
| CADDY III (04-) | 1,6 TDI | | | | 24.0101-3803.2 | 260101 | INSTALLATION KIT | 4439 36 , 001 421 04 86 , 34 21 6 772 867 , 93179160 , 54 23 93 | |
| | 1,9 TDI | | 02.2004 | | 24.2415-1711.3 | 030130 | CLUTCH CYLINDER | 1K0 721 388 G , 1K0 721 388 L , 1K0 721 388 F , 1K0 721 388 M , 1K0 721 388 S , 1K0 721 388 B | |
| | | | 09.2005 | | 24.2415-1711.3 | 030130 | CLUTCH CYLINDER | 1K0 721 388 G , 1K0 721 388 L , 1K0 721 388 F , 1K0 721 388 M , 1K0 721 388 S , 1K0 721 388 B | |
| | | | | | 24.0101-3803.2 | 260101 | INSTALLATION KIT | 4439 36 , 001 421 04 86 , 34 21 6 772 867 , 93179160 , 54 23 93 | |
| | 1,9 TDI 4motion | | 05.2008 | | 24.2415-1711.3 | 030130 | CLUTCH CYLINDER | 1K0 721 388 G , 1K0 721 388 L , 1K0 721 388 F , 1K0 721 388 M , 1K0 721 388 S , 1K0 721 388 B | |
| | | | | | 24.0101-3803.2 | 260101 | INSTALLATION KIT | 4439 36 , 001 421 04 86 , 34 21 6 772 867 , 93179160 , 54 23 93 | |
| | 2,0 Eco Fuel | | 04.2006 | | 24.2415-1711.3 | 030130 | CLUTCH CYLINDER | 1K0 721 388 G , 1K0 721 388 L , 1K0 721 388 F , 1K0 721 388 M , 1K0 721 388 S , 1K0 721 388 B | |
| | | | | | 24.0101-3803.2 | 260101 | INSTALLATION KIT | 4439 36 , 001 421 04 86 , 34 21 6 772 867 , 93179160 , 54 23 93 | |
| | 2,0 SDI | | 02.2004 | | 24.2415-1711.3 | 030130 | CLUTCH CYLINDER | 1K0 721 388 G , 1K0 721 388 L , 1K0 721 388 F , 1K0 721 388 M , 1K0 721 388 S , 1K0 721 388 B | |

New partnumbers on stock - according to applications

04/2011



| | | | | | | | |
|--|--|--|--|--|--------------------|-------------------------------|--|
| | | | | | Description | OE numbers per ATE pn. | e.g. replaced pn. / miscellaneous |
|--|--|--|--|--|--------------------|-------------------------------|--|

VOLKSWAGEN

| | | | | | | | | | |
|-----------------|-----------------|--|---------|--|----------------|--------|------------------------|---|--|
| CADDY III (04-) | 2,0 SDI | | | | 24.0101-3803.2 | 260101 | INSTALLATION KIT | 4439 36 , 001 421 04 86 , 34 21 6 772 867 , 93179160 , 54 23 93 | |
| | 2,0 TDI | | 09.2007 | | 24.2415-1711.3 | 030130 | CLUTCH CYLINDER | 1K0 721 388 G , 1K0 721 388 L , 1K0 721 388 F , 1K0 721 388 M , 1K0 721 388 S , 1K0 721 388 B | |
| | | | | | 24.0101-3803.2 | 260101 | INSTALLATION KIT | 4439 36 , 001 421 04 86 , 34 21 6 772 867 , 93179160 , 54 23 93 | |
| | 2,0 TDI 4motion | | 10.2010 | | 24.2415-1711.3 | 030130 | CLUTCH CYLINDER | 1K0 721 388 G , 1K0 721 388 L , 1K0 721 388 F , 1K0 721 388 M , 1K0 721 388 S , 1K0 721 388 B | |
| | | | | | 24.0101-3803.2 | 260101 | INSTALLATION KIT | 4439 36 , 001 421 04 86 , 34 21 6 772 867 , 93179160 , 54 23 93 | |
| CRAFTER (06-) | 2,5 TDI | | 04.2006 | | 03.0137-4008.2 | 654008 | BRAKE SHOE SET W. ACC. | 906 420 04 20 , 2E0 698 525 A | |
| EOS (06-) | 1,4 TSI | | 10.2007 | | 24.2415-1711.3 | 030130 | CLUTCH CYLINDER | 1K0 721 388 G , 1K0 721 388 L , 1K0 721 388 F , 1K0 721 388 M , 1K0 721 388 S , 1K0 721 388 B | |
| | | | 10.2007 | | 24.0101-3803.2 | 260101 | INSTALLATION KIT | 4439 36 , 001 421 04 86 , 34 21 6 772 867 , 93179160 , 54 23 93 | |
| | 1,6 FSI | | 05.2006 | | 24.2415-1711.3 | 030130 | CLUTCH CYLINDER | 1K0 721 388 G , 1K0 721 388 L , 1K0 721 388 F , 1K0 721 388 M , 1K0 721 388 S , 1K0 721 388 B | |

New partnumbers on stock - according to applications

04/2011



| | | | | | | | |
|--|--|--|--|--|-------------|------------------------|---------------------------------------|
| | | | | | Description | OE numbers per ATE pn. | e.g. replaced pn. / miscellaneous |
|--|--|--|--|--|-------------|------------------------|---------------------------------------|







VOLKSWAGEN

| | | | | | | | | | |
|-----------|----------|--|---------|--|----------------|--------|------------------|---|--|
| EOS (06-) | 1,6 FSI | | 05.2006 | | 24.0101-3803.2 | 260101 | INSTALLATION KIT | 4439 36 , 001 421 04 86 , 34 21 6 772 867 , 93179160 , 54 23 93 | |
| | 2,0 FSI | | 05.2006 | | 24.2415-1711.3 | 030130 | CLUTCH CYLINDER | 1K0 721 388 G , 1K0 721 388 L , 1K0 721 388 F , 1K0 721 388 M , 1K0 721 388 S , 1K0 721 388 B | |
| | | | 05.2006 | | 24.0101-3803.2 | 260101 | INSTALLATION KIT | 4439 36 , 001 421 04 86 , 34 21 6 772 867 , 93179160 , 54 23 93 | |
| | 2,0 TDI | | 05.2006 | | 24.2415-1711.3 | 030130 | CLUTCH CYLINDER | 1K0 721 388 G , 1K0 721 388 L , 1K0 721 388 F , 1K0 721 388 M , 1K0 721 388 S , 1K0 721 388 B | |
| | | | 05.2006 | | 24.0101-3803.2 | 260101 | INSTALLATION KIT | 4439 36 , 001 421 04 86 , 34 21 6 772 867 , 93179160 , 54 23 93 | |
| | 2,0 TFSI | | 05.2006 | | 24.2415-1711.3 | 030130 | CLUTCH CYLINDER | 1K0 721 388 G , 1K0 721 388 L , 1K0 721 388 F , 1K0 721 388 M , 1K0 721 388 S , 1K0 721 388 B | |
| | | | 05.2006 | | 24.0101-3803.2 | 260101 | INSTALLATION KIT | 4439 36 , 001 421 04 86 , 34 21 6 772 867 , 93179160 , 54 23 93 | |
| | 2,0 TSI | | 11.2009 | | 24.2415-1711.3 | 030130 | CLUTCH CYLINDER | 1K0 721 388 G , 1K0 721 388 L , 1K0 721 388 F , 1K0 721 388 M , 1K0 721 388 S , 1K0 721 388 B | |
| | | | 11.2009 | | 24.0101-3803.2 | 260101 | INSTALLATION KIT | 4439 36 , 001 421 04 86 , 34 21 6 772 867 , 93179160 , 54 23 93 | |

New partnumbers on stock - according to applications

04/2011



| | | | | | | | |
|---|---|---|---|---|--------------------|-------------------------------|---|
|  |  |  |  |  | Description | OE numbers per ATE pn. |  e.g. replaced pn. / miscellaneous |
|---|---|---|---|---|--------------------|-------------------------------|---|

VOLKSWAGEN

| | | | | | | | | | |
|-----------------|---------|--|---------|--|----------------|--------|------------------|---|--|
| EOS (06-) | 3,2 V6 | | 05.2006 | | 24.2415-1711.3 | 030130 | CLUTCH CYLINDER | 1K0 721 388 G , 1K0 721 388 L , 1K0 721 388 F , 1K0 721 388 M , 1K0 721 388 S , 1K0 721 388 B | |
| | | | 05.2006 | | 24.0101-3803.2 | 260101 | INSTALLATION KIT | 4439 36 , 001 421 04 86 , 34 21 6 772 867 , 93179160 , 54 23 93 | |
| | 3,6 V6 | | 05.2009 | | 24.2415-1711.3 | 030130 | CLUTCH CYLINDER | 1K0 721 388 G , 1K0 721 388 L , 1K0 721 388 F , 1K0 721 388 M , 1K0 721 388 S , 1K0 721 388 B | |
| | | | 05.2009 | | 24.0101-3803.2 | 260101 | INSTALLATION KIT | 4439 36 , 001 421 04 86 , 34 21 6 772 867 , 93179160 , 54 23 93 | |
| GOLF Plus (05-) | 1,4 16V | | 01.2005 | | 24.2415-1711.3 | 030130 | CLUTCH CYLINDER | 1K0 721 388 G , 1K0 721 388 L , 1K0 721 388 F , 1K0 721 388 M , 1K0 721 388 S , 1K0 721 388 B | |
| | | | 01.2005 | | 24.0101-3803.2 | 260101 | INSTALLATION KIT | 4439 36 , 001 421 04 86 , 34 21 6 772 867 , 93179160 , 54 23 93 | |
| | 1,4 FSI | | 07.2005 | | 24.2415-1711.3 | 030130 | CLUTCH CYLINDER | 1K0 721 388 G , 1K0 721 388 L , 1K0 721 388 F , 1K0 721 388 M , 1K0 721 388 S , 1K0 721 388 B | |
| | | | 07.2005 | | 24.0101-3803.2 | 260101 | INSTALLATION KIT | 4439 36 , 001 421 04 86 , 34 21 6 772 867 , 93179160 , 54 23 93 | |
| | 1,4 TSI | | 06.2008 | | 24.2415-1711.3 | 030130 | CLUTCH CYLINDER | 1K0 721 388 G , 1K0 721 388 L , 1K0 721 388 F , 1K0 721 388 M , 1K0 721 388 S , 1K0 721 388 B | |

New partnumbers on stock - according to applications

04/2011



| | | | | | | | | |
|--|--|--|--|--|-------------|------------------------|--|-----------------------------------|
| | | | | | Description | OE numbers per ATE pn. | | e.g. replaced pn. / miscellaneous |
|--|--|--|--|--|-------------|------------------------|--|-----------------------------------|





VOLKSWAGEN

| | | | | | | | | | |
|-----------------|------------|--|---------|--|----------------|--------|------------------|---|--|
| GOLF Plus (05-) | 1,4 TSI | | 06.2007 | | 24.2415-1711.3 | 030130 | CLUTCH CYLINDER | 1K0 721 388 G , 1K0 721 388 L , 1K0 721 388 F , 1K0 721 388 M , 1K0 721 388 S , 1K0 721 388 B | |
| | | | 05.2006 | | 24.2415-1711.3 | 030130 | CLUTCH CYLINDER | 1K0 721 388 G , 1K0 721 388 L , 1K0 721 388 F , 1K0 721 388 M , 1K0 721 388 S , 1K0 721 388 B | |
| | | | 06.2008 | | 24.0101-3803.2 | 260101 | INSTALLATION KIT | 4439 36 , 001 421 04 86 , 34 21 6 772 867 , 93179160 , 54 23 93 | |
| | | | 05.2006 | | 24.0101-3803.2 | 260101 | INSTALLATION KIT | 4439 36 , 001 421 04 86 , 34 21 6 772 867 , 93179160 , 54 23 93 | |
| | | | 06.2007 | | 24.0101-3803.2 | 260101 | INSTALLATION KIT | 4439 36 , 001 421 04 86 , 34 21 6 772 867 , 93179160 , 54 23 93 | |
| | 1,6 | | 05.2005 | | 24.2415-1711.3 | 030130 | CLUTCH CYLINDER | 1K0 721 388 G , 1K0 721 388 L , 1K0 721 388 F , 1K0 721 388 M , 1K0 721 388 S , 1K0 721 388 B | |
| | | | 05.2005 | | 24.0101-3803.2 | 260101 | INSTALLATION KIT | 4439 36 , 001 421 04 86 , 34 21 6 772 867 , 93179160 , 54 23 93 | |
| | 1,6 BiFuel | | 05.2009 | | 24.2415-1711.3 | 030130 | CLUTCH CYLINDER | 1K0 721 388 G , 1K0 721 388 L , 1K0 721 388 F , 1K0 721 388 M , 1K0 721 388 S , 1K0 721 388 B | |
| | | | 05.2009 | | 24.0101-3803.2 | 260101 | INSTALLATION KIT | 4439 36 , 001 421 04 86 , 34 21 6 772 867 , 93179160 , 54 23 93 | |

New partnumbers on stock - according to applications

04/2011



| | | | | | | |
|---|---|---|---|--------------------|-------------------------------|---|
|  |  |   |  | Description | OE numbers per ATE pn. |  e.g. replaced pn. / miscellaneous |
|---|---|---|---|--------------------|-------------------------------|---|

VOLKSWAGEN

| | | | | | | | | | |
|-----------------|---------|--|---------|--|----------------|--------|------------------|---|--|
| GOLF Plus (05-) | 1,6 FSI | | 01.2005 | | 24.2415-1711.3 | 030130 | CLUTCH CYLINDER | 1K0 721 388 G , 1K0 721 388 L , 1K0 721 388 F , 1K0 721 388 M , 1K0 721 388 S , 1K0 721 388 B | |
| | | | 01.2005 | | 24.0101-3803.2 | 260101 | INSTALLATION KIT | 4439 36 , 001 421 04 86 , 34 21 6 772 867 , 93179160 , 54 23 93 | |
| | 1,6 TDI | | 02.2009 | | 24.2415-1711.3 | 030130 | CLUTCH CYLINDER | 1K0 721 388 G , 1K0 721 388 L , 1K0 721 388 F , 1K0 721 388 M , 1K0 721 388 S , 1K0 721 388 B | |
| | | | 02.2009 | | 24.0101-3803.2 | 260101 | INSTALLATION KIT | 4439 36 , 001 421 04 86 , 34 21 6 772 867 , 93179160 , 54 23 93 | |
| | 1,9 TDI | | 05.2005 | | 24.2415-1711.3 | 030130 | CLUTCH CYLINDER | 1K0 721 388 G , 1K0 721 388 L , 1K0 721 388 F , 1K0 721 388 M , 1K0 721 388 S , 1K0 721 388 B | |
| | | | 01.2005 | | 24.2415-1711.3 | 030130 | CLUTCH CYLINDER | 1K0 721 388 G , 1K0 721 388 L , 1K0 721 388 F , 1K0 721 388 M , 1K0 721 388 S , 1K0 721 388 B | |
| | | | 05.2005 | | 24.0101-3803.2 | 260101 | INSTALLATION KIT | 4439 36 , 001 421 04 86 , 34 21 6 772 867 , 93179160 , 54 23 93 | |
| | | | 01.2005 | | 24.0101-3803.2 | 260101 | INSTALLATION KIT | 4439 36 , 001 421 04 86 , 34 21 6 772 867 , 93179160 , 54 23 93 | |
| | 2,0 FSI | | 05.2005 | | 24.2415-1711.3 | 030130 | CLUTCH CYLINDER | 1K0 721 388 G , 1K0 721 388 L , 1K0 721 388 F , 1K0 721 388 M , 1K0 721 388 S , 1K0 721 388 B | |

New partnumbers on stock - according to applications

04/2011



| | | | | | | | |
|--|--|--|--|--|--------------------|-------------------------------|---------------------------------------|
| | | | | | Description | OE numbers per ATE pn. | e.g. replaced pn. / miscellaneous |
|--|--|--|--|--|--------------------|-------------------------------|---------------------------------------|

VOLKSWAGEN

| | | | | | | | | | |
|-----------------|---------|--|---------|---------|----------------|--------|------------------|---|--|
| GOLF Plus (05-) | 2,0 FSI | | 05.2005 | | 24.0101-3803.2 | 260101 | INSTALLATION KIT | 4439 36 , 001 421 04 86 , 34 21 6 772 867 , 93179160 , 54 23 93 | |
| | 2,0 TDI | | 05.2005 | | 24.2415-1711.3 | 030130 | CLUTCH CYLINDER | 1K0 721 388 G , 1K0 721 388 L , 1K0 721 388 F , 1K0 721 388 M , 1K0 721 388 S , 1K0 721 388 B | |
| | | | 01.2009 | | 24.2415-1711.3 | 030130 | CLUTCH CYLINDER | 1K0 721 388 G , 1K0 721 388 L , 1K0 721 388 F , 1K0 721 388 M , 1K0 721 388 S , 1K0 721 388 B | |
| | | | 01.2005 | | 24.2415-1711.3 | 030130 | CLUTCH CYLINDER | 1K0 721 388 G , 1K0 721 388 L , 1K0 721 388 F , 1K0 721 388 M , 1K0 721 388 S , 1K0 721 388 B | |
| | | | 01.2009 | | 24.0101-3803.2 | 260101 | INSTALLATION KIT | 4439 36 , 001 421 04 86 , 34 21 6 772 867 , 93179160 , 54 23 93 | |
| | | | 01.2005 | | 24.0101-3803.2 | 260101 | INSTALLATION KIT | 4439 36 , 001 421 04 86 , 34 21 6 772 867 , 93179160 , 54 23 93 | |
| | | | 05.2005 | | 24.0101-3803.2 | 260101 | INSTALLATION KIT | 4439 36 , 001 421 04 86 , 34 21 6 772 867 , 93179160 , 54 23 93 | |
| GOLF V (03-08) | 1,4 16V | | 10.2003 | 09.2008 | 24.2415-1711.3 | 030130 | CLUTCH CYLINDER | 1K0 721 388 G , 1K0 721 388 L , 1K0 721 388 F , 1K0 721 388 M , 1K0 721 388 S , 1K0 721 388 B | |
| | | | 10.2003 | 09.2008 | 24.0101-3803.2 | 260101 | INSTALLATION KIT | 4439 36 , 001 421 04 86 , 34 21 6 772 867 , 93179160 , 54 23 93 | |

New partnumbers on stock - according to applications

04/2011



| | | | | | | | | |
|--|--|--|--|--|-------------|------------------------|--|-----------------------------------|
| | | | | | Description | OE numbers per ATE pn. | | e.g. replaced pn. / miscellaneous |
|--|--|--|--|--|-------------|------------------------|--|-----------------------------------|

VOLKSWAGEN

| Model | Engine | Start | End | ATE Part No. | ATE Part No. | Description | OE numbers | Notes |
|----------------|---------|---------|---------|----------------|--------------|------------------|---|-------|
| GOLF V (03-08) | 1,4 FSI | 10.2003 | 09.2008 | 24.2415-1711.3 | 030130 | CLUTCH CYLINDER | 1K0 721 388 G , 1K0 721 388 L , 1K0 721 388 F , 1K0 721 388 M , 1K0 721 388 S , 1K0 721 388 B | |
| | | 10.2003 | 09.2008 | 24.0101-3803.2 | 260101 | INSTALLATION KIT | 4439 36 , 001 421 04 86 , 34 21 6 772 867 , 93179160 , 54 23 93 | |
| | 1,4 TSI | 11.2005 | 09.2008 | 24.2415-1711.3 | 030130 | CLUTCH CYLINDER | 1K0 721 388 G , 1K0 721 388 L , 1K0 721 388 F , 1K0 721 388 M , 1K0 721 388 S , 1K0 721 388 B | |
| | | 05.2007 | 09.2008 | 24.2415-1711.3 | 030130 | CLUTCH CYLINDER | 1K0 721 388 G , 1K0 721 388 L , 1K0 721 388 F , 1K0 721 388 M , 1K0 721 388 S , 1K0 721 388 B | |
| | | 05.2006 | 09.2008 | 24.2415-1711.3 | 030130 | CLUTCH CYLINDER | 1K0 721 388 G , 1K0 721 388 L , 1K0 721 388 F , 1K0 721 388 M , 1K0 721 388 S , 1K0 721 388 B | |
| | | 11.2005 | 09.2008 | 24.0101-3803.2 | 260101 | INSTALLATION KIT | 4439 36 , 001 421 04 86 , 34 21 6 772 867 , 93179160 , 54 23 93 | |
| | | 05.2006 | 09.2008 | 24.0101-3803.2 | 260101 | INSTALLATION KIT | 4439 36 , 001 421 04 86 , 34 21 6 772 867 , 93179160 , 54 23 93 | |
| | | 05.2007 | 09.2008 | 24.0101-3803.2 | 260101 | INSTALLATION KIT | 4439 36 , 001 421 04 86 , 34 21 6 772 867 , 93179160 , 54 23 93 | |
| | 1,6 16V | 01.2004 | 09.2008 | 24.2415-1711.3 | 030130 | CLUTCH CYLINDER | 1K0 721 388 G , 1K0 721 388 L , 1K0 721 388 F , 1K0 721 388 M , 1K0 721 388 S , 1K0 721 388 B | |

New partnumbers on stock - according to applications

04/2011



| | | | | | | | |
|--|--|--|--|--|--------------------|-------------------------------|--|
| | | | | | Description | OE numbers per ATE pn. | e.g. replaced pn. / miscellaneous |
|--|--|--|--|--|--------------------|-------------------------------|--|

VOLKSWAGEN

| GOLF V (03-08) | 1,6 16V | | 01.2004 | 09.2008 | 24.0101-3803.2 | 260101 | INSTALLATION KIT | 4439 36 , 001 421 04 86 , 34 21 6 772 867 , 93179160 , 54 23 93 | |
|----------------|-----------------|--|---------|---------|----------------|--------|------------------|---|--|
| | 1,6 FSI | | 10.2003 | 09.2008 | 24.2415-1711.3 | 030130 | CLUTCH CYLINDER | 1K0 721 388 G , 1K0 721 388 L , 1K0 721 388 F , 1K0 721 388 M , 1K0 721 388 S , 1K0 721 388 B | |
| | | | 10.2003 | 09.2008 | 24.0101-3803.2 | 260101 | INSTALLATION KIT | 4439 36 , 001 421 04 86 , 34 21 6 772 867 , 93179160 , 54 23 93 | |
| | 1,9 TDI | | 10.2003 | 09.2008 | 24.2415-1711.3 | 030130 | CLUTCH CYLINDER | 1K0 721 388 G , 1K0 721 388 L , 1K0 721 388 F , 1K0 721 388 M , 1K0 721 388 S , 1K0 721 388 B | |
| | | | 05.2004 | 09.2008 | 24.2415-1711.3 | 030130 | CLUTCH CYLINDER | 1K0 721 388 G , 1K0 721 388 L , 1K0 721 388 F , 1K0 721 388 M , 1K0 721 388 S , 1K0 721 388 B | |
| | | | 10.2003 | 09.2008 | 24.0101-3803.2 | 260101 | INSTALLATION KIT | 4439 36 , 001 421 04 86 , 34 21 6 772 867 , 93179160 , 54 23 93 | |
| | | | 05.2004 | 09.2008 | 24.0101-3803.2 | 260101 | INSTALLATION KIT | 4439 36 , 001 421 04 86 , 34 21 6 772 867 , 93179160 , 54 23 93 | |
| | 1,9 TDI 4motion | | 08.2004 | 09.2008 | 24.2415-1711.3 | 030130 | CLUTCH CYLINDER | 1K0 721 388 G , 1K0 721 388 L , 1K0 721 388 F , 1K0 721 388 M , 1K0 721 388 S , 1K0 721 388 B | |
| | 2,0 FSI | | 10.2003 | 09.2008 | 24.2415-1711.3 | 030130 | CLUTCH CYLINDER | 1K0 721 388 G , 1K0 721 388 L , 1K0 721 388 F , 1K0 721 388 M , 1K0 721 388 S , 1K0 721 388 B | |

New partnumbers on stock - according to applications

04/2011



| | | | | | | | |
|--|--|--|--|--|--------------------|-------------------------------|---------------------------------------|
| | | | | | Description | OE numbers per ATE pn. | e.g. replaced pn. / miscellaneous |
|--|--|--|--|--|--------------------|-------------------------------|---------------------------------------|

VOLKSWAGEN

| GOLF V (03-08) | 2,0 FSI | | 10.2003 | 09.2008 | 24.0101-3803.2 | 260101 | INSTALLATION KIT | 4439 36 , 001 421 04 86 , 34 21 6 772 867 , 93179160 , 54 23 93 | |
|----------------|-----------------|--|---------|---------|----------------|--------|------------------|---|--|
| | 2,0 FSI 4motion | | 08.2004 | 09.2008 | 24.2415-1711.3 | 030130 | CLUTCH CYLINDER | 1K0 721 388 G , 1K0 721 388 L , 1K0 721 388 F , 1K0 721 388 M , 1K0 721 388 S , 1K0 721 388 B | |
| | 2,0 GTI | | 09.2006 | 09.2008 | 24.2415-1711.3 | 030130 | CLUTCH CYLINDER | 1K0 721 388 G , 1K0 721 388 L , 1K0 721 388 F , 1K0 721 388 M , 1K0 721 388 S , 1K0 721 388 B | |
| | | | 09.2004 | 09.2008 | 24.2415-1711.3 | 030130 | CLUTCH CYLINDER | 1K0 721 388 G , 1K0 721 388 L , 1K0 721 388 F , 1K0 721 388 M , 1K0 721 388 S , 1K0 721 388 B | |
| | | | 09.2006 | 09.2008 | 24.0101-3803.2 | 260101 | INSTALLATION KIT | 4439 36 , 001 421 04 86 , 34 21 6 772 867 , 93179160 , 54 23 93 | |
| | | | 09.2004 | 09.2008 | 24.0101-3803.2 | 260101 | INSTALLATION KIT | 4439 36 , 001 421 04 86 , 34 21 6 772 867 , 93179160 , 54 23 93 | |
| | 2,0 SDI | | 01.2004 | 09.2008 | 24.2415-1711.3 | 030130 | CLUTCH CYLINDER | 1K0 721 388 G , 1K0 721 388 L , 1K0 721 388 F , 1K0 721 388 M , 1K0 721 388 S , 1K0 721 388 B | |
| | | | 01.2004 | 09.2008 | 24.0101-3803.2 | 260101 | INSTALLATION KIT | 4439 36 , 001 421 04 86 , 34 21 6 772 867 , 93179160 , 54 23 93 | |
| | 2,0 TDI | | 10.2003 | 09.2008 | 24.2415-1711.3 | 030130 | CLUTCH CYLINDER | 1K0 721 388 G , 1K0 721 388 L , 1K0 721 388 F , 1K0 721 388 M , 1K0 721 388 S , 1K0 721 388 B | |

New partnumbers on stock - according to applications

04/2011



| | | | | | | | |
|--|----------|--|--|--|--------------------|-------------------------------|---|
| | i | | | | Description | OE numbers per ATE pn. | i e.g. replaced pn. / miscellaneous |
|--|----------|--|--|--|--------------------|-------------------------------|---|

VOLKSWAGEN

| Model | Engine | Start | End | ATE Part No. | ATE Part No. | Description | OE numbers | Notes |
|------------------------|-----------------|---------|---------|----------------|--------------|------------------|---|-------|
| GOLF V (03-08) | 2,0 TDI | 11.2005 | 09.2008 | 24.2415-1711.3 | 030130 | CLUTCH CYLINDER | 1K0 721 388 G , 1K0 721 388 L , 1K0 721 388 F , 1K0 721 388 M , 1K0 721 388 S , 1K0 721 388 B | |
| | | 11.2005 | 09.2008 | 24.0101-3803.2 | 260101 | INSTALLATION KIT | 4439 36 , 001 421 04 86 , 34 21 6 772 867 , 93179160 , 54 23 93 | |
| | | 10.2003 | 09.2008 | 24.0101-3803.2 | 260101 | INSTALLATION KIT | 4439 36 , 001 421 04 86 , 34 21 6 772 867 , 93179160 , 54 23 93 | |
| | 2,0 TDI 4motion | 08.2004 | 09.2008 | 24.2415-1711.3 | 030130 | CLUTCH CYLINDER | 1K0 721 388 G , 1K0 721 388 L , 1K0 721 388 F , 1K0 721 388 M , 1K0 721 388 S , 1K0 721 388 B | |
| | 3,2 R32 | 11.2005 | 09.2008 | 24.2415-1711.3 | 030130 | CLUTCH CYLINDER | 1K0 721 388 G , 1K0 721 388 L , 1K0 721 388 F , 1K0 721 388 M , 1K0 721 388 S , 1K0 721 388 B | |
| GOLF V Variant (07-09) | 1,4 | 06.2007 | 06.2009 | 24.2415-1711.3 | 030130 | CLUTCH CYLINDER | 1K0 721 388 G , 1K0 721 388 L , 1K0 721 388 F , 1K0 721 388 M , 1K0 721 388 S , 1K0 721 388 B | |
| | 1,4 TSI | 06.2007 | 06.2009 | 24.2415-1711.3 | 030130 | CLUTCH CYLINDER | 1K0 721 388 G , 1K0 721 388 L , 1K0 721 388 F , 1K0 721 388 M , 1K0 721 388 S , 1K0 721 388 B | |
| | | 05.2007 | 06.2009 | 24.2415-1711.3 | 030130 | CLUTCH CYLINDER | 1K0 721 388 G , 1K0 721 388 L , 1K0 721 388 F , 1K0 721 388 M , 1K0 721 388 S , 1K0 721 388 B | |

New partnumbers on stock - according to applications

04/2011



| | | | | | | | |
|--|----------|--|--|--|--------------------|-------------------------------|---|
| | i | | | | Description | OE numbers per ATE pn. | i e.g. replaced pn. / miscellaneous |
|--|----------|--|--|--|--------------------|-------------------------------|---|

VOLKSWAGEN

| Model | Engine | Start Date | End Date | ATE Part No. | ATE Part No. | Description | OE numbers | Notes |
|------------------------|-----------------|------------|----------|----------------|--------------|------------------|---|-------|
| GOLF V Variant (07-09) | 1,4 TSI | 07.2008 | 06.2009 | 24.2415-1711.3 | 030130 | CLUTCH CYLINDER | 1K0 721 388 G , 1K0 721 388 L , 1K0 721 388 F , 1K0 721 388 M , 1K0 721 388 S , 1K0 721 388 B | |
| | 1,6 | 05.2007 | 06.2009 | 24.2415-1711.3 | 030130 | CLUTCH CYLINDER | 1K0 721 388 G , 1K0 721 388 L , 1K0 721 388 F , 1K0 721 388 M , 1K0 721 388 S , 1K0 721 388 B | |
| | 1,9 TDI | 05.2007 | 06.2009 | 24.2415-1711.3 | 030130 | CLUTCH CYLINDER | 1K0 721 388 G , 1K0 721 388 L , 1K0 721 388 F , 1K0 721 388 M , 1K0 721 388 S , 1K0 721 388 B | |
| | 1,9 TDI 4motion | 12.2007 | 06.2009 | 24.2415-1711.3 | 030130 | CLUTCH CYLINDER | 1K0 721 388 G , 1K0 721 388 L , 1K0 721 388 F , 1K0 721 388 M , 1K0 721 388 S , 1K0 721 388 B | |
| | 2 | 06.2007 | 06.2009 | 24.2415-1711.3 | 030130 | CLUTCH CYLINDER | 1K0 721 388 G , 1K0 721 388 L , 1K0 721 388 F , 1K0 721 388 M , 1K0 721 388 S , 1K0 721 388 B | |
| | 2,0 TDI | 05.2007 | 06.2009 | 24.2415-1711.3 | 030130 | CLUTCH CYLINDER | 1K0 721 388 G , 1K0 721 388 L , 1K0 721 388 F , 1K0 721 388 M , 1K0 721 388 S , 1K0 721 388 B | |
| GOLF VI (08-) | 1,2 TSI | 05.2009 | | 24.2415-1711.3 | 030130 | CLUTCH CYLINDER | 1K0 721 388 G , 1K0 721 388 L , 1K0 721 388 F , 1K0 721 388 M , 1K0 721 388 S , 1K0 721 388 B | |
| | | 05.2009 | 10.2009 | 24.0101-3803.2 | 260101 | INSTALLATION KIT | 4439 36 , 001 421 04 86 , 34 21 6 772 867 , 93179160 , 54 23 93 | |

New partnumbers on stock - according to applications

04/2011



| | | | | | | | | |
|--|--|--|--|--|-------------|------------------------|--|-----------------------------------|
| | | | | | Description | OE numbers per ATE pn. | | e.g. replaced pn. / miscellaneous |
|--|--|--|--|--|-------------|------------------------|--|-----------------------------------|

VOLKSWAGEN

| | | | | | | | | | |
|---------------|-------------|--|---------|---------|----------------|--------|------------------|---|--|
| GOLF VI (08-) | 1,4 | | 10.2008 | | 24.2415-1711.3 | 030130 | CLUTCH CYLINDER | 1K0 721 388 G , 1K0 721 388 L , 1K0 721 388 F , 1K0 721 388 M , 1K0 721 388 S , 1K0 721 388 B | |
| | | | 10.2008 | 10.2009 | 24.0101-3803.2 | 260101 | INSTALLATION KIT | 4439 36 , 001 421 04 86 , 34 21 6 772 867 , 93179160 , 54 23 93 | |
| | 1,4 TSI | | 10.2008 | | 24.2415-1711.3 | 030130 | CLUTCH CYLINDER | 1K0 721 388 G , 1K0 721 388 L , 1K0 721 388 F , 1K0 721 388 M , 1K0 721 388 S , 1K0 721 388 B | |
| | | | 10.2008 | 10.2009 | 24.0101-3803.2 | 260101 | INSTALLATION KIT | 4439 36 , 001 421 04 86 , 34 21 6 772 867 , 93179160 , 54 23 93 | |
| | 1,6 | | 10.2008 | | 24.2415-1711.3 | 030130 | CLUTCH CYLINDER | 1K0 721 388 G , 1K0 721 388 L , 1K0 721 388 F , 1K0 721 388 M , 1K0 721 388 S , 1K0 721 388 B | |
| | | | 10.2008 | 10.2009 | 24.0101-3803.2 | 260101 | INSTALLATION KIT | 4439 36 , 001 421 04 86 , 34 21 6 772 867 , 93179160 , 54 23 93 | |
| | 1,6 Bi-Fuel | | 03.2009 | | 24.2415-1711.3 | 030130 | CLUTCH CYLINDER | 1K0 721 388 G , 1K0 721 388 L , 1K0 721 388 F , 1K0 721 388 M , 1K0 721 388 S , 1K0 721 388 B | |
| | | | 03.2009 | 10.2009 | 24.0101-3803.2 | 260101 | INSTALLATION KIT | 4439 36 , 001 421 04 86 , 34 21 6 772 867 , 93179160 , 54 23 93 | |
| | 1,6 TDI | | 02.2009 | | 24.2415-1711.3 | 030130 | CLUTCH CYLINDER | 1K0 721 388 G , 1K0 721 388 L , 1K0 721 388 F , 1K0 721 388 M , 1K0 721 388 S , 1K0 721 388 B | |

New partnumbers on stock - according to applications

04/2011



| | | | | | | | | |
|--|--|--|--|--|-------------|------------------------|--|-----------------------------------|
| | | | | | Description | OE numbers per ATE pn. | | e.g. replaced pn. / miscellaneous |
|--|--|--|--|--|-------------|------------------------|--|-----------------------------------|

VOLKSWAGEN

| Model | Engine | Start | End | ATE Part No. | ATE Part No. | Description | OE numbers | Notes |
|---------------|-----------------|---------|---------|----------------|--------------|------------------|---|-------|
| GOLF VI (08-) | 1,6 TDI | 02.2009 | 10.2009 | 24.0101-3803.2 | 260101 | INSTALLATION KIT | 4439 36 , 001 421 04 86 , 34 21 6 772 867 , 93179160 , 54 23 93 | |
| | 2,0 GTI | 03.2009 | | 24.2415-1711.3 | 030130 | CLUTCH CYLINDER | 1K0 721 388 G , 1K0 721 388 L , 1K0 721 388 F , 1K0 721 388 M , 1K0 721 388 S , 1K0 721 388 B | |
| | | 03.2009 | 10.2009 | 24.0101-3803.2 | 260101 | INSTALLATION KIT | 4439 36 , 001 421 04 86 , 34 21 6 772 867 , 93179160 , 54 23 93 | |
| | 2,0 R 4motion | 11.2009 | | 24.2415-1711.3 | 030130 | CLUTCH CYLINDER | 1K0 721 388 G , 1K0 721 388 L , 1K0 721 388 F , 1K0 721 388 M , 1K0 721 388 S , 1K0 721 388 B | |
| | 2,0 TDI | 04.2009 | | 24.2415-1711.3 | 030130 | CLUTCH CYLINDER | 1K0 721 388 G , 1K0 721 388 L , 1K0 721 388 F , 1K0 721 388 M , 1K0 721 388 S , 1K0 721 388 B | |
| | | 10.2008 | | 24.2415-1711.3 | 030130 | CLUTCH CYLINDER | 1K0 721 388 G , 1K0 721 388 L , 1K0 721 388 F , 1K0 721 388 M , 1K0 721 388 S , 1K0 721 388 B | |
| | | 04.2009 | 10.2009 | 24.0101-3803.2 | 260101 | INSTALLATION KIT | 4439 36 , 001 421 04 86 , 34 21 6 772 867 , 93179160 , 54 23 93 | |
| | | 10.2008 | 10.2009 | 24.0101-3803.2 | 260101 | INSTALLATION KIT | 4439 36 , 001 421 04 86 , 34 21 6 772 867 , 93179160 , 54 23 93 | |
| | 2,0 TDI 4motion | 10.2008 | | 24.2415-1711.3 | 030130 | CLUTCH CYLINDER | 1K0 721 388 G , 1K0 721 388 L , 1K0 721 388 F , 1K0 721 388 M , 1K0 721 388 S , 1K0 721 388 B | |

New partnumbers on stock - according to applications

04/2011



| | | | | | | | |
|--|----------|--|--|--|--------------------|-------------------------------|---|
| | i | | | | Description | OE numbers per ATE pn. | i e.g. replaced pn. / miscellaneous |
|--|----------|--|--|--|--------------------|-------------------------------|---|

VOLKSWAGEN

| | | | | | | | | | |
|-----------------|---------|--|---------|---------|----------------|--------|------------------|---|--|
| GOLF VI (08-) | 2,0 TSI | | 07.2009 | | 24.2415-1711.3 | 030130 | CLUTCH CYLINDER | 1K0 721 388 G , 1K0 721 388 L , 1K0 721 388 F , 1K0 721 388 M , 1K0 721 388 S , 1K0 721 388 B | |
| | | | 07.2009 | 10.2009 | 24.0101-3803.2 | 260101 | INSTALLATION KIT | 4439 36 , 001 421 04 86 , 34 21 6 772 867 , 93179160 , 54 23 93 | |
| | 2,5 FSI | | 08.2009 | | 24.2415-1711.3 | 030130 | CLUTCH CYLINDER | 1K0 721 388 G , 1K0 721 388 L , 1K0 721 388 F , 1K0 721 388 M , 1K0 721 388 S , 1K0 721 388 B | |
| | | | 08.2009 | 10.2009 | 24.0101-3803.2 | 260101 | INSTALLATION KIT | 4439 36 , 001 421 04 86 , 34 21 6 772 867 , 93179160 , 54 23 93 | |
| JETTA V (05-10) | 1,4 TSI | | 05.2007 | 10.2010 | 24.2415-1711.3 | 030130 | CLUTCH CYLINDER | 1K0 721 388 G , 1K0 721 388 L , 1K0 721 388 F , 1K0 721 388 M , 1K0 721 388 S , 1K0 721 388 B | |
| | | | 06.2006 | 10.2010 | 24.2415-1711.3 | 030130 | CLUTCH CYLINDER | 1K0 721 388 G , 1K0 721 388 L , 1K0 721 388 F , 1K0 721 388 M , 1K0 721 388 S , 1K0 721 388 B | |
| | | | 07.2008 | 10.2010 | 24.2415-1711.3 | 030130 | CLUTCH CYLINDER | 1K0 721 388 G , 1K0 721 388 L , 1K0 721 388 F , 1K0 721 388 M , 1K0 721 388 S , 1K0 721 388 B | |
| | 1,6 FSI | | 08.2005 | 10.2010 | 24.2415-1711.3 | 030130 | CLUTCH CYLINDER | 1K0 721 388 G , 1K0 721 388 L , 1K0 721 388 F , 1K0 721 388 M , 1K0 721 388 S , 1K0 721 388 B | |

New partnumbers on stock - according to applications

04/2011



| | | | | | | | |
|--|--|--|--|--|-------------|------------------------|---------------------------------------|
| | | | | | Description | OE numbers per ATE pn. | e.g. replaced pn. / miscellaneous |
|--|--|--|--|--|-------------|------------------------|---------------------------------------|

VOLKSWAGEN

| Model | Engine | Start | End | Part No. | ATE No. | Description | OE numbers | Notes |
|-----------------|-----------|---------|---------|----------------|---------|-----------------|---|-------|
| JETTA V (05-10) | 1,6 i 16V | 08.2005 | 10.2010 | 24.2415-1711.3 | 030130 | CLUTCH CYLINDER | 1K0 721 388 G , 1K0 721 388 L , 1K0 721 388 F , 1K0 721 388 M , 1K0 721 388 S , 1K0 721 388 B | |
| | 1,6 TDI | 06.2009 | 10.2010 | 24.2415-1711.3 | 030130 | CLUTCH CYLINDER | 1K0 721 388 G , 1K0 721 388 L , 1K0 721 388 F , 1K0 721 388 M , 1K0 721 388 S , 1K0 721 388 B | |
| | 1,9 TDI | 08.2005 | 10.2010 | 24.2415-1711.3 | 030130 | CLUTCH CYLINDER | 1K0 721 388 G , 1K0 721 388 L , 1K0 721 388 F , 1K0 721 388 M , 1K0 721 388 S , 1K0 721 388 B | |
| | 2,0 FSI | 08.2005 | 10.2010 | 24.2415-1711.3 | 030130 | CLUTCH CYLINDER | 1K0 721 388 G , 1K0 721 388 L , 1K0 721 388 F , 1K0 721 388 M , 1K0 721 388 S , 1K0 721 388 B | |
| | 2,0 TDI | 06.2006 | 10.2010 | 24.2415-1711.3 | 030130 | CLUTCH CYLINDER | 1K0 721 388 G , 1K0 721 388 L , 1K0 721 388 F , 1K0 721 388 M , 1K0 721 388 S , 1K0 721 388 B | |
| | | 08.2005 | 10.2010 | 24.2415-1711.3 | 030130 | CLUTCH CYLINDER | 1K0 721 388 G , 1K0 721 388 L , 1K0 721 388 F , 1K0 721 388 M , 1K0 721 388 S , 1K0 721 388 B | |
| | | 09.2005 | 10.2010 | 24.2415-1711.3 | 030130 | CLUTCH CYLINDER | 1K0 721 388 G , 1K0 721 388 L , 1K0 721 388 F , 1K0 721 388 M , 1K0 721 388 S , 1K0 721 388 B | |
| | 2,0 TFSI | 10.2005 | 10.2010 | 24.2415-1711.3 | 030130 | CLUTCH CYLINDER | 1K0 721 388 G , 1K0 721 388 L , 1K0 721 388 F , 1K0 721 388 M , 1K0 721 388 S , 1K0 721 388 B | |

New partnumbers on stock - according to applications

04/2011



| | | | | | | | |
|--|--|--|--|--|--------------------|-------------------------------|---------------------------------------|
| | | | | | Description | OE numbers per ATE pn. | e.g. replaced pn. / miscellaneous |
|--|--|--|--|--|--------------------|-------------------------------|---------------------------------------|







VOLKSWAGEN

| | | | | | | | | | |
|-----------------|-----------------|--|---------|---------|----------------|--------|--------------------|---|--|
| JETTA V (05-10) | 2,5 FSI | | 07.2008 | 10.2010 | 24.2415-1711.3 | 030130 | CLUTCH CYLINDER | 1K0 721 388 G , 1K0 721 388 L , 1K0 721 388 F , 1K0 721 388 M , 1K0 721 388 S , 1K0 721 388 B | |
| PASSAT (10-) | 1,4 TSI | | 08.2010 | | 03.4153-0186.3 | 010816 | TANDEM MASTER CYL. | 3C1 614 019 A , 3C1 614 019 E , 3C1 614 019 C | |
| | 1,4 TSI EcoFuel | | 08.2010 | | 03.4153-0186.3 | 010816 | TANDEM MASTER CYL. | 3C1 614 019 A , 3C1 614 019 E , 3C1 614 019 C | |
| | 1,6 TDI | | 08.2010 | | 03.4153-0186.3 | 010816 | TANDEM MASTER CYL. | 3C1 614 019 A , 3C1 614 019 E , 3C1 614 019 C | |
| | 1,8 TSI | | 08.2010 | | 03.4153-0186.3 | 010816 | TANDEM MASTER CYL. | 3C1 614 019 A , 3C1 614 019 E , 3C1 614 019 C | |
| | 2,0 TDI | | 08.2010 | | 03.4153-0186.3 | 010816 | TANDEM MASTER CYL. | 3C1 614 019 A , 3C1 614 019 E , 3C1 614 019 C | |
| | 2,0 TDI 4motion | | 08.2010 | | 03.4153-0186.3 | 010816 | TANDEM MASTER CYL. | 3C1 614 019 A , 3C1 614 019 E , 3C1 614 019 C | |
| | 2,0 TSI | | 11.2010 | | 03.4153-0186.3 | 010816 | TANDEM MASTER CYL. | 3C1 614 019 A , 3C1 614 019 E , 3C1 614 019 C | |
| PASSAT CC (08-) | 1,8 TSI | | 04.2008 | 1,8 | 03.4153-0186.3 | 010816 | TANDEM MASTER CYL. | 3C1 614 019 A , 3C1 614 019 E , 3C1 614 019 C | |
| | 2,0 TDI | | 04.2008 | | 03.4153-0186.3 | 010816 | TANDEM MASTER CYL. | 3C1 614 019 A , 3C1 614 019 E , 3C1 614 019 C | |
| | | | 06.2008 | | 03.4153-0186.3 | 010816 | TANDEM MASTER CYL. | 3C1 614 019 A , 3C1 614 019 E , 3C1 614 019 C | |
| | 2,0 TDI 4motion | | 08.2009 | | 03.4153-0186.3 | 010816 | TANDEM MASTER CYL. | 3C1 614 019 A , 3C1 614 019 E , 3C1 614 019 C | |
| | | | 11.2009 | | 03.4153-0186.3 | 010816 | TANDEM MASTER CYL. | 3C1 614 019 A , 3C1 614 019 E , 3C1 614 019 C | |

New partnumbers on stock - according to applications

04/2011



| | | | | | | | |
|---|---|---|---|---|--------------------|-------------------------------|---|
|  |  |  |  |  | Description | OE numbers per ATE pn. |  e.g. replaced pn. / miscellaneous |
|---|---|---|---|---|--------------------|-------------------------------|---|







VOLKSWAGEN

| | | | | | | | | | |
|--------------------------|-----------------|--|---------|---------|----------------|--------|--------------------|---|--|
| PASSAT CC (08-) | 2,0 TSI | | 04.2008 | | 03.4153-0186.3 | 010816 | TANDEM MASTER CYL. | 3C1 614 019 A , 3C1 614 019 E , 3C1 614 019 C | |
| | 3,6 V6 4motion | | 04.2008 | | 03.4153-0186.3 | 010816 | TANDEM MASTER CYL. | 3C1 614 019 A , 3C1 614 019 E , 3C1 614 019 C | |
| PASSAT Limousine (05-10) | 1,4 TSI | | 10.2007 | 07.2010 | 03.4153-0186.3 | 010816 | TANDEM MASTER CYL. | 3C1 614 019 A , 3C1 614 019 E , 3C1 614 019 C | |
| | 1,6 | | 03.2005 | 07.2010 | 03.4153-0186.3 | 010816 | TANDEM MASTER CYL. | 3C1 614 019 A , 3C1 614 019 E , 3C1 614 019 C | |
| | 1,6 FSI | | 03.2005 | 07.2010 | 03.4153-0186.3 | 010816 | TANDEM MASTER CYL. | 3C1 614 019 A , 3C1 614 019 E , 3C1 614 019 C | |
| | 1,6 TDI | | 08.2009 | 07.2010 | 03.4153-0186.3 | 010816 | TANDEM MASTER CYL. | 3C1 614 019 A , 3C1 614 019 E , 3C1 614 019 C | |
| | 1,8 TSI | | 11.2009 | 07.2010 | 03.4153-0186.3 | 010816 | TANDEM MASTER CYL. | 3C1 614 019 A , 3C1 614 019 E , 3C1 614 019 C | |
| | | | 10.2007 | 07.2010 | 03.4153-0186.3 | 010816 | TANDEM MASTER CYL. | 3C1 614 019 A , 3C1 614 019 E , 3C1 614 019 C | |
| | 1,9 TDI | | 03.2005 | 07.2010 | 03.4153-0186.3 | 010816 | TANDEM MASTER CYL. | 3C1 614 019 A , 3C1 614 019 E , 3C1 614 019 C | |
| | 2,0 FSI | | 03.2005 | 07.2010 | 03.4153-0186.3 | 010816 | TANDEM MASTER CYL. | 3C1 614 019 A , 3C1 614 019 E , 3C1 614 019 C | |
| | 2,0 FSI 4motion | | 03.2005 | 07.2010 | 03.4153-0186.3 | 010816 | TANDEM MASTER CYL. | 3C1 614 019 A , 3C1 614 019 E , 3C1 614 019 C | |
| | 2,0 TDI | | 08.2005 | 07.2010 | 03.4153-0186.3 | 010816 | TANDEM MASTER CYL. | 3C1 614 019 A , 3C1 614 019 E , 3C1 614 019 C | |
| | | | 03.2005 | 07.2010 | 03.4153-0186.3 | 010816 | TANDEM MASTER CYL. | 3C1 614 019 A , 3C1 614 019 E , 3C1 614 019 C | |

New partnumbers on stock - according to applications

04/2011



| | | | | | | | |
|---|---|---|---|---|--------------------|-------------------------------|---|
|  |  |  |  |  | Description | OE numbers per ATE pn. |  e.g. replaced pn. / miscellaneous |
|---|---|---|---|---|--------------------|-------------------------------|---|







VOLKSWAGEN

| | | | | | | | | | |
|--------------------------|--------------------|--|---------|---------|----------------|--------|--------------------|---|--|
| PASSAT Limousine (05-10) | 2,0 TDI 4motion | | 05.2009 | 07.2010 | 03.4153-0186.3 | 010816 | TANDEM MASTER CYL. | 3C1 614 019 A , 3C1 614 019 E , 3C1 614 019 C | |
| | | | 03.2005 | 07.2010 | 03.4153-0186.3 | 010816 | TANDEM MASTER CYL. | 3C1 614 019 A , 3C1 614 019 E , 3C1 614 019 C | |
| | 2,0 TFSI | | 03.2005 | 07.2010 | 03.4153-0186.3 | 010816 | TANDEM MASTER CYL. | 3C1 614 019 A , 3C1 614 019 E , 3C1 614 019 C | |
| | 3,2 V6 FSI | | 11.2005 | 07.2010 | 03.4153-0186.3 | 010816 | TANDEM MASTER CYL. | 3C1 614 019 A , 3C1 614 019 E , 3C1 614 019 C | |
| | 3,2 V6 FSI 4motion | | 09.2005 | 07.2010 | 03.4153-0186.3 | 010816 | TANDEM MASTER CYL. | 3C1 614 019 A , 3C1 614 019 E , 3C1 614 019 C | |
| PASSAT Variant (05-10) | 1,4 TSI | | 10.2007 | 07.2010 | 03.4153-0186.3 | 010816 | TANDEM MASTER CYL. | 3C1 614 019 A , 3C1 614 019 E , 3C1 614 019 C | |
| | 1,6 | | 07.2005 | 07.2010 | 03.4153-0186.3 | 010816 | TANDEM MASTER CYL. | 3C1 614 019 A , 3C1 614 019 E , 3C1 614 019 C | |
| | 1,6 FSI | | 07.2005 | 07.2010 | 03.4153-0186.3 | 010816 | TANDEM MASTER CYL. | 3C1 614 019 A , 3C1 614 019 E , 3C1 614 019 C | |
| | 1,6 TDI | | 08.2009 | 07.2010 | 03.4153-0186.3 | 010816 | TANDEM MASTER CYL. | 3C1 614 019 A , 3C1 614 019 E , 3C1 614 019 C | |
| | 1,8 TSI | | 10.2007 | 07.2010 | 03.4153-0186.3 | 010816 | TANDEM MASTER CYL. | 3C1 614 019 A , 3C1 614 019 E , 3C1 614 019 C | |
| | | | 11.2009 | 07.2010 | 03.4153-0186.3 | 010816 | TANDEM MASTER CYL. | 3C1 614 019 A , 3C1 614 019 E , 3C1 614 019 C | |
| | 1,9 TDI | | 07.2005 | 07.2010 | 03.4153-0186.3 | 010816 | TANDEM MASTER CYL. | 3C1 614 019 A , 3C1 614 019 E , 3C1 614 019 C | |
| | 2,0 FSI | | 07.2005 | 07.2010 | 03.4153-0186.3 | 010816 | TANDEM MASTER CYL. | 3C1 614 019 A , 3C1 614 019 E , 3C1 614 019 C | |

New partnumbers on stock - according to applications

04/2011



| | | | | | | | |
|---|---|---|---|---|--------------------|-------------------------------|---|
|  |  |  |  |  | Description | OE numbers per ATE pn. |  e.g. replaced pn. / miscellaneous |
|---|---|---|---|---|--------------------|-------------------------------|---|







VOLKSWAGEN

| | | | | | | | | | |
|------------------------|--------------------|--|---------|---------|----------------|--------|--------------------|---|--|
| PASSAT Variant (05-10) | 2,0 FSI 4motion | | 09.2005 | 07.2010 | 03.4153-0186.3 | 010816 | TANDEM MASTER CYL. | 3C1 614 019 A , 3C1 614 019 E , 3C1 614 019 C | |
| | 2,0 TDI | | 07.2005 | 07.2010 | 03.4153-0186.3 | 010816 | TANDEM MASTER CYL. | 3C1 614 019 A , 3C1 614 019 E , 3C1 614 019 C | |
| | | | 11.2005 | 07.2010 | 03.4153-0186.3 | 010816 | TANDEM MASTER CYL. | 3C1 614 019 A , 3C1 614 019 E , 3C1 614 019 C | |
| | 2,0 TDI 4motion | | 05.2009 | 07.2010 | 03.4153-0186.3 | 010816 | TANDEM MASTER CYL. | 3C1 614 019 A , 3C1 614 019 E , 3C1 614 019 C | |
| | | | 09.2005 | 07.2010 | 03.4153-0186.3 | 010816 | TANDEM MASTER CYL. | 3C1 614 019 A , 3C1 614 019 E , 3C1 614 019 C | |
| | 2,0 TFSI | | 07.2005 | 07.2010 | 03.4153-0186.3 | 010816 | TANDEM MASTER CYL. | 3C1 614 019 A , 3C1 614 019 E , 3C1 614 019 C | |
| | 3,2 V6 FSI | | 11.2005 | 07.2010 | 03.4153-0186.3 | 010816 | TANDEM MASTER CYL. | 3C1 614 019 A , 3C1 614 019 E , 3C1 614 019 C | |
| | 3,2 V6 FSI 4motion | | 11.2005 | 07.2010 | 03.4153-0186.3 | 010816 | TANDEM MASTER CYL. | 3C1 614 019 A , 3C1 614 019 E , 3C1 614 019 C | |
| SCIROCCO (08-) | 1,4 TSI | | 09.2008 | | 24.2415-1711.3 | 030130 | CLUTCH CYLINDER | 1K0 721 388 G , 1K0 721 388 L , 1K0 721 388 F , 1K0 721 388 M , 1K0 721 388 S , 1K0 721 388 B | |
| | | | 08.2008 | | 24.2415-1711.3 | 030130 | CLUTCH CYLINDER | 1K0 721 388 G , 1K0 721 388 L , 1K0 721 388 F , 1K0 721 388 M , 1K0 721 388 S , 1K0 721 388 B | |
| | | | 08.2008 | | 24.0101-3803.2 | 260101 | INSTALLATION KIT | 4439 36 , 001 421 04 86 , 34 21 6 772 867 , 93179160 , 54 23 93 | |

New partnumbers on stock - according to applications

04/2011



| | | | | | | | |
|---|---|---|---|---|--------------------|-------------------------------|---|
|  |  |  |  |  | Description | OE numbers per ATE pn. |  e.g. replaced pn. / miscellaneous |
|---|---|---|---|---|--------------------|-------------------------------|---|

VOLKSWAGEN

| | | | | | | | | | |
|----------------|---------|--|---------|--|----------------|--------|------------------|---|--|
| SCIROCCO (08-) | 1,4 TSI | | 09.2008 | | 24.0101-3803.2 | 260101 | INSTALLATION KIT | 4439 36 , 001 421 04 86 , 34 21 6 772 867 , 93179160 , 54 23 93 | |
| | | | 09.2008 | | 24.0101-3803.2 | 260101 | INSTALLATION KIT | 4439 36 , 001 421 04 86 , 34 21 6 772 867 , 93179160 , 54 23 93 | |
| | | | 08.2008 | | 24.0101-3803.2 | 260101 | INSTALLATION KIT | 4439 36 , 001 421 04 86 , 34 21 6 772 867 , 93179160 , 54 23 93 | |
| | 2,0 R | | 11.2009 | | 24.2415-1711.3 | 030130 | CLUTCH CYLINDER | 1K0 721 388 G , 1K0 721 388 L , 1K0 721 388 F , 1K0 721 388 M , 1K0 721 388 S , 1K0 721 388 B | |
| | | | 11.2009 | | 24.0101-3803.2 | 260101 | INSTALLATION KIT | 4439 36 , 001 421 04 86 , 34 21 6 772 867 , 93179160 , 54 23 93 | |
| | | | 11.2009 | | 24.0101-3803.2 | 260101 | INSTALLATION KIT | 4439 36 , 001 421 04 86 , 34 21 6 772 867 , 93179160 , 54 23 93 | |
| | 2,0 TDI | | 10.2008 | | 24.2415-1711.3 | 030130 | CLUTCH CYLINDER | 1K0 721 388 G , 1K0 721 388 L , 1K0 721 388 F , 1K0 721 388 M , 1K0 721 388 S , 1K0 721 388 B | |
| | | | 05.2009 | | 24.2415-1711.3 | 030130 | CLUTCH CYLINDER | 1K0 721 388 G , 1K0 721 388 L , 1K0 721 388 F , 1K0 721 388 M , 1K0 721 388 S , 1K0 721 388 B | |
| | | | 05.2009 | | 24.0101-3803.2 | 260101 | INSTALLATION KIT | 4439 36 , 001 421 04 86 , 34 21 6 772 867 , 93179160 , 54 23 93 | |

New partnumbers on stock - according to applications

04/2011



| | | | | | | | | |
|--|--|--|--|--|-------------|------------------------|--|-----------------------------------|
| | | | | | Description | OE numbers per ATE pn. | | e.g. replaced pn. / miscellaneous |
|--|--|--|--|--|-------------|------------------------|--|-----------------------------------|





VOLKSWAGEN

| | | | | | | | | | |
|-----------------|--------------------|--|---------|--|----------------|--------|--------------------|---|--|
| SCIROCCO (08-) | 2,0 TDI | | 10.2008 | | 24.0101-3803.2 | 260101 | INSTALLATION KIT | 4439 36 , 001 421 04 86 , 34 21 6 772 867 , 93179160 , 54 23 93 | |
| | | | 10.2008 | | 24.0101-3803.2 | 260101 | INSTALLATION KIT | 4439 36 , 001 421 04 86 , 34 21 6 772 867 , 93179160 , 54 23 93 | |
| | | | 05.2009 | | 24.0101-3803.2 | 260101 | INSTALLATION KIT | 4439 36 , 001 421 04 86 , 34 21 6 772 867 , 93179160 , 54 23 93 | |
| | 2,0 TSI | | 08.2008 | | 24.2415-1711.3 | 030130 | CLUTCH CYLINDER | 1K0 721 388 G , 1K0 721 388 L , 1K0 721 388 F , 1K0 721 388 M , 1K0 721 388 S , 1K0 721 388 B | |
| | | | 08.2008 | | 24.0101-3803.2 | 260101 | INSTALLATION KIT | 4439 36 , 001 421 04 86 , 34 21 6 772 867 , 93179160 , 54 23 93 | |
| | | | 08.2008 | | 24.0101-3803.2 | 260101 | INSTALLATION KIT | 4439 36 , 001 421 04 86 , 34 21 6 772 867 , 93179160 , 54 23 93 | |
| SHARAN II (10-) | 1,4 TSI BlueMotion | | 07.2010 | | 03.4153-0186.3 | 010816 | TANDEM MASTER CYL. | 3C1 614 019 A , 3C1 614 019 E , 3C1 614 019 C | |
| | 2,0 TDI BlueMotion | | 07.2010 | | 03.4153-0186.3 | 010816 | TANDEM MASTER CYL. | 3C1 614 019 A , 3C1 614 019 E , 3C1 614 019 C | |
| TIGUAN (07-) | 1,4 TSI | | 11.2007 | | 03.4153-0186.3 | 010816 | TANDEM MASTER CYL. | 3C1 614 019 A , 3C1 614 019 E , 3C1 614 019 C | |
| | | | 08.2010 | | 03.4153-0186.3 | 010816 | TANDEM MASTER CYL. | 3C1 614 019 A , 3C1 614 019 E , 3C1 614 019 C | |
| | 2,0 TDi | | 04.2010 | | 03.4153-0186.3 | 010816 | TANDEM MASTER CYL. | 3C1 614 019 A , 3C1 614 019 E , 3C1 614 019 C | |

New partnumbers on stock - according to applications

04/2011



| | | | | | | |
|---|---|--|---|--------------------|-------------------------------|---|
|  |  |  |  | Description | OE numbers per ATE pn. |  e.g. replaced pn. / miscellaneous |
|---|---|--|---|--------------------|-------------------------------|---|







VOLKSWAGEN

| | | | | | | | | | |
|--------------|-----------------|--|---------|---------|----------------|--------|--------------------|---|--|
| TIGUAN (07-) | 2,0 TDI 4motion | | 01.2008 | | 03.4153-0186.3 | 010816 | TANDEM MASTER CYL. | 3C1 614 019 A , 3C1 614 019 E , 3C1 614 019 C | |
| | | | 11.2007 | | 03.4153-0186.3 | 010816 | TANDEM MASTER CYL. | 3C1 614 019 A , 3C1 614 019 E , 3C1 614 019 C | |
| | 2,0 TSI 4motion | | 02.2008 | | 03.4153-0186.3 | 010816 | TANDEM MASTER CYL. | 3C1 614 019 A , 3C1 614 019 E , 3C1 614 019 C | |
| | | | 11.2007 | | 03.4153-0186.3 | 010816 | TANDEM MASTER CYL. | 3C1 614 019 A , 3C1 614 019 E , 3C1 614 019 C | |
| TOURAN (03-) | 1,4 FSI | | 01.2006 | 10.2009 | 24.2415-1711.3 | 030130 | CLUTCH CYLINDER | 1K0 721 388 G , 1K0 721 388 L , 1K0 721 388 F , 1K0 721 388 M , 1K0 721 388 S , 1K0 721 388 B | |
| | 1,4 TSI | | 09.2006 | 10.2009 | 24.2415-1711.3 | 030130 | CLUTCH CYLINDER | 1K0 721 388 G , 1K0 721 388 L , 1K0 721 388 F , 1K0 721 388 M , 1K0 721 388 S , 1K0 721 388 B | |
| | | | 11.2006 | 10.2009 | 24.2415-1711.3 | 030130 | CLUTCH CYLINDER | 1K0 721 388 G , 1K0 721 388 L , 1K0 721 388 F , 1K0 721 388 M , 1K0 721 388 S , 1K0 721 388 B | |
| | 1,4 TSI EcoFuel | | 05.2009 | 10.2009 | 24.2415-1711.3 | 030130 | CLUTCH CYLINDER | 1K0 721 388 G , 1K0 721 388 L , 1K0 721 388 F , 1K0 721 388 M , 1K0 721 388 S , 1K0 721 388 B | |
| | 1,6 | | 07.2003 | 10.2009 | 24.2415-1711.3 | 030130 | CLUTCH CYLINDER | 1K0 721 388 G , 1K0 721 388 L , 1K0 721 388 F , 1K0 721 388 M , 1K0 721 388 S , 1K0 721 388 B | |
| | 1,6 FSI | | 02.2003 | 10.2009 | 24.2415-1711.3 | 030130 | CLUTCH CYLINDER | 1K0 721 388 G , 1K0 721 388 L , 1K0 721 388 F , 1K0 721 388 M , 1K0 721 388 S , 1K0 721 388 B | |

New partnumbers on stock - according to applications

04/2011



| | | | | | | | |
|---|---|---|---|---|--------------------|-------------------------------|---|
|  |  |  |  |  | Description | OE numbers per ATE pn. |  e.g. replaced pn. / miscellaneous |
|---|---|---|---|---|--------------------|-------------------------------|---|



VOLKSWAGEN

| Model | Engine | Start Date | End Date | Part No. | ATE No. | Description | OE numbers | Notes |
|--------------|--------------|------------|----------|----------------|---------|-----------------|---|-------|
| TOURAN (03-) | 1,9 TDI | 08.2003 | 10.2009 | 24.2415-1711.3 | 030130 | CLUTCH CYLINDER | 1K0 721 388 G , 1K0 721 388 L , 1K0 721 388 F , 1K0 721 388 M , 1K0 721 388 S , 1K0 721 388 B | |
| | | 11.2004 | 10.2009 | 24.2415-1711.3 | 030130 | CLUTCH CYLINDER | 1K0 721 388 G , 1K0 721 388 L , 1K0 721 388 F , 1K0 721 388 M , 1K0 721 388 S , 1K0 721 388 B | |
| | | 02.2003 | 10.2009 | 24.2415-1711.3 | 030130 | CLUTCH CYLINDER | 1K0 721 388 G , 1K0 721 388 L , 1K0 721 388 F , 1K0 721 388 M , 1K0 721 388 S , 1K0 721 388 B | |
| | 2,0 Eco Fuel | 02.2006 | 10.2009 | 24.2415-1711.3 | 030130 | CLUTCH CYLINDER | 1K0 721 388 G , 1K0 721 388 L , 1K0 721 388 F , 1K0 721 388 M , 1K0 721 388 S , 1K0 721 388 B | |
| | 2,0 FSI | 10.2003 | 10.2009 | 24.2415-1711.3 | 030130 | CLUTCH CYLINDER | 1K0 721 388 G , 1K0 721 388 L , 1K0 721 388 F , 1K0 721 388 M , 1K0 721 388 S , 1K0 721 388 B | |
| | | 10.2004 | 10.2009 | 24.2415-1711.3 | 030130 | CLUTCH CYLINDER | 1K0 721 388 G , 1K0 721 388 L , 1K0 721 388 F , 1K0 721 388 M , 1K0 721 388 S , 1K0 721 388 B | |
| | 2,0 TDI | 08.2003 | 10.2009 | 24.2415-1711.3 | 030130 | CLUTCH CYLINDER | 1K0 721 388 G , 1K0 721 388 L , 1K0 721 388 F , 1K0 721 388 M , 1K0 721 388 S , 1K0 721 388 B | |
| | | 02.2003 | 10.2009 | 24.2415-1711.3 | 030130 | CLUTCH CYLINDER | 1K0 721 388 G , 1K0 721 388 L , 1K0 721 388 F , 1K0 721 388 M , 1K0 721 388 S , 1K0 721 388 B | |

New partnumbers on stock - according to applications

04/2011



| | | | | | | | |
|---|---|---|---|---|--------------------|-------------------------------|--|
|  |  |  |  |  | Description | OE numbers per ATE pn. |  e.g. replaced pn. / miscellaneous |
|---|---|---|---|---|--------------------|-------------------------------|--|

VOLKSWAGEN

| | | | | | | | | | |
|--------------|---------|--|---------|---------|----------------|--------|-----------------|---|--|
| TOURAN (03-) | 2,0 TDI | | 02.2006 | 10.2009 | 24.2415-1711.3 | 030130 | CLUTCH CYLINDER | 1K0 721 388 G , 1K0 721 388 L , 1K0 721 388 F , 1K0 721 388 M , 1K0 721 388 S , 1K0 721 388 B | |
|--------------|---------|--|---------|---------|----------------|--------|-----------------|---|--|



13.0460-7262.2 607262

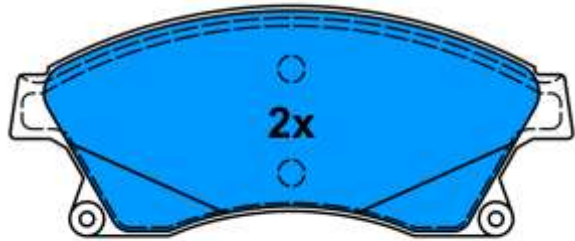

25031 19,1

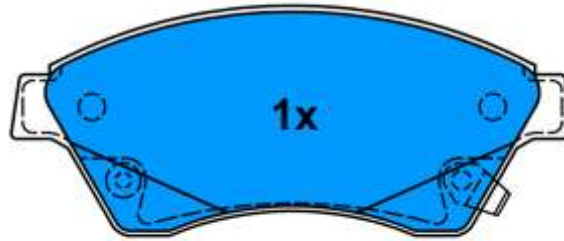

25032 19,1

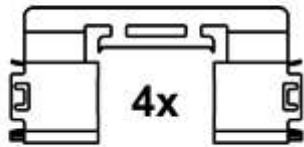

4x

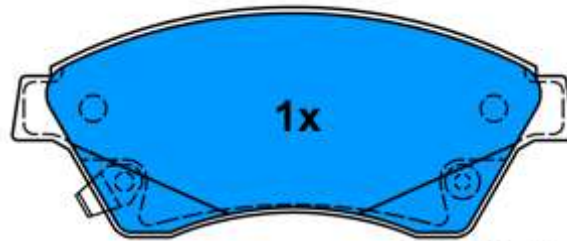

25033 19,1

148,2 x 60,3

Applications:

OPEL ASTRA J / GTC / Vauxhall Astra MK VI (09-)
OPEL ASTRA J Sports Tourer/Vau.Astra Sports Tourer (10-)
CHEVROLET CRUZE (09-)



13.0460-5607.2 605607

Applications:

LEXUS LS 460 (06-)
LEXUS LS 600 (07-)

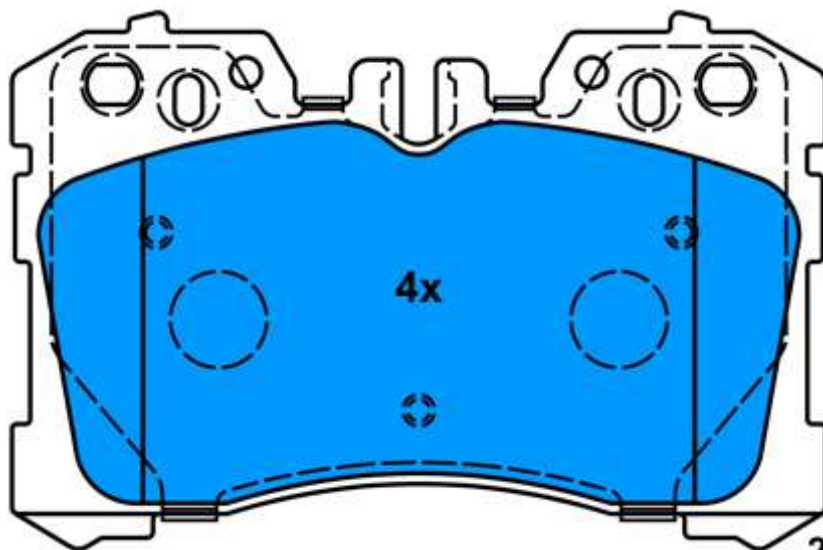

24245 19,1

133,7 x 87,9



13.0460-7263.2 607263

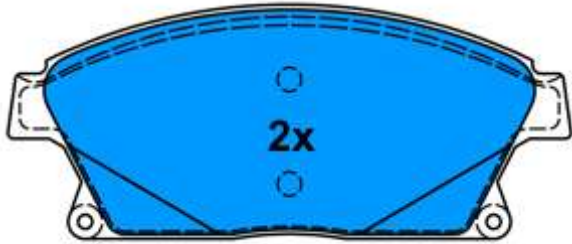

25034 19,1

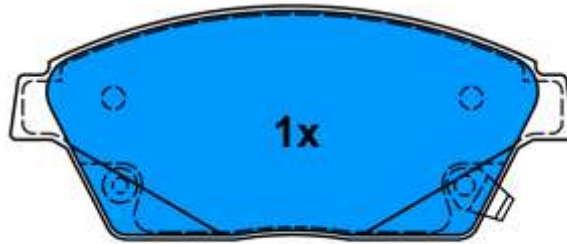

25035 19,1

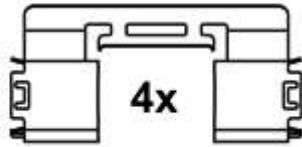

148,2 x 61,1

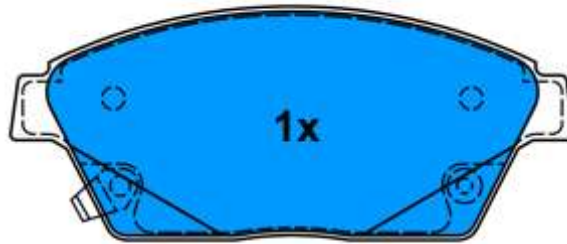

25036 19,1

Applications:

- OPEL ASTRA J / GTC / Vauxhall Astra MK VI (09-)
- OPEL ASTRA J Sports Tourer/Vau.Astra Sports Tourer (10-)
- CHEVROLET CRUZE (09-)
- CHEVROLET ORLANDO (11-)