

ATE Classic

2017



C5

Bremsen-Ersatzteilprogramm

Brake Parts Program



Brakethrough Technology

Kompetenz und Aktualität

Competence and topicality



ATE macht mobil

Unser Produktportfolio können Sie jetzt auch per Smartphone abrufen. Über Stichwort- Fahrzeug- und Artikelsuche finden Sie schnell den passenden Artikel – und per Händlersuche mit integriertem Routenplaner auch gleich den nächsten ATE Vertragspartner.

ATE Online-Katalog

Noch aktuellere Informationen finden Sie im Online-Katalog von ATE. Hier werden die Kataloginformationen mindestens monatlich aktualisiert. Sie finden den ATE Online-Katalog unter www.ate.de.

ATE goes mobile

You can call up our product portfolio on your smartphone. Using keyword, vehicle and article searches, you can quickly find the right article – and then use the dealer search with the integrated route planner to immediately find the nearest ATE authorised distributor.

ATE online-catalog

Even more current information you find in the ATE onlinecatalog. Here the spare part information are posted at least monthly. You find the ATE online-catalog on www.ate-brakes.com.



ATE App
ATE app



ATE Online-Katalog
ATE online-catalog

So benutzen Sie den C5

Fahrzeugtypen		Einbauzeitraum (von/bis)		ATE-Artikelnummer (lang)		Bemerkung (Artikel)		Bemerkung (Fahrzeug)		ATE-Artikelnummer (kurz)		Artikeldefinition	
Vorder-/Hinterachse	Fahrgestellnummer (von/bis)	kW		Bemerkung (Fahrzeug)		ATE-Artikelnummer (lang)		ATE-Artikelnummer (kurz)		Bemerkung (Fahrzeug)		ATE-Artikelnummer (kurz)	
1,8 T 1,8 T Quattro 2,0 2,0 TFSI	120 120 96 120	8E-55-999999	04.02 05.03 05.04	08.06 08.06 08.06	PR: 1LB,1LE PR: 1LB,1LE PR: 1LB,1LE	11.3571-8522.2 11.3571-8521.2 11.0441-5704.2 11.0101-5409.2	220320 220319 250034 260035	+ ESP + ESP	D=57, - Halter D=57, - Halter Dichtungssatz Hülsensatz	ATE ATE ATE ATE			

*Produktgruppen

	Bremskraftverstärker		Bremstrommel
	Hauptbremszylinder		ATE Original Kit ATE Original TopKit
	Ausgleichsbehälter		Trommelbremsbacken für Feststellbremse
	Bremssattel		Handbremsseil
	Scheibenbremsbeläge		Bremskraftregler
	Bremsscheibe ATE PowerDisc		Kupplungs- Geberzylinder
	Bremsschlauch		Kupplungs- Nehmerzylinder
	Radsensor		Kupplungsschlauch
	Radzylinder		Kupplungsseil
	Trommelbremsbacken		

**Lenkungsart

- Linkslenker
- Rechtslenker

****Herstellerkennung

ATE	Continental Teves (ATE)
AKE	Akebono
AP	AP Lockheed
BDX	Bendix
BOS	Bosch
BRE	Brembo
CIT	Citroën
DEL	Delco
FI	Fiat
FTE	FTE Automotive
LUC	Lucas (TRW)
PER	Perrot
SUM	Sumitomo
TOK	Tokico
VW	Volkswagen

***Einbauposition

























- vorne
 - hinten
 - links
 - rechts
 - links vorne
 - links hinten
 - rechts vorne
 - rechts hinten
 - mitte
 - oben
 - unten
 - Vorderachse
 - Vorderachse links
 - Vorderachse rechts
 - Hinterachse
 - Hinterachse links
 - Hinterachse rechts
- Sämtliche Positionsangaben beziehen sich immer auf die Fahrtrichtung.

Abkürzungen

-	Ohne / nicht	L	Legiert / hochgekoht
+	Mit / nur / für	L=	Länge
AUT	Automatische Nachstel- lung	Nz	Nehmerzylinder
B	Beschichtet	PD	PowerDisc
BG	Bremskraftbegrenzer	Rz	Radzylinder
BR	Bremskraftregler	RzR	Radzylinder mit integriertem Regler
BRE	Einschraubregler	S	Fixierschraube / Sattelschraube
BRES	Einschraubreglersatz	THz	Tandem-Hauptzylinder
BRL	Bremskraftregler lastabhängig	V	Belüftet
D=	Durchmesser	WE	Warneinrichtung
Gz	Geberzylinder	WK	Warnkontakt
HEB	Hebel	Zub	Zubehör
Hz	Hauptzylinder		



Artikelinformationen

		KURZNUMMER				KURZNUMMER																					
	03.6199-xxxx.4 → 03.61dy-xxxx.4 → 03.67dy-xxxx.4 → 03.68dy-xxxx.4 → 03.69dy-xxxx.4 → 03.77dy-xxxx.4 →	30nnnn 30nnnn 30nnnn 30nnnn 30nnnn 30nnnn	Bremskraftverstärker T50 T51 T52/3 T52 T53 T52/4	<table border="1" data-bbox="550 369 790 593"> <tr> <td>d</td> <td>y</td> </tr> <tr> <td></td> <td>0 = Einfachgerät 5 = Tandemgerät</td> </tr> <tr> <td>2 = 6"</td> <td></td> </tr> <tr> <td>3 = 7"</td> <td></td> </tr> <tr> <td>4 = 8"</td> <td>0 = Einfachgerät</td> </tr> <tr> <td>5 = 9"</td> <td>3 = Einfachgerät BA</td> </tr> <tr> <td>6 = 10"</td> <td>5 = Einfachgerät</td> </tr> <tr> <td></td> <td>8 = Einfachgerät BA</td> </tr> <tr> <td></td> <td>BA = Bremsassistent</td> </tr> <tr> <td></td> <td>Z = Zugankerbremsgeräte</td> </tr> </table>	d	y		0 = Einfachgerät 5 = Tandemgerät	2 = 6"		3 = 7"		4 = 8"	0 = Einfachgerät	5 = 9"	3 = Einfachgerät BA	6 = 10"	5 = Einfachgerät		8 = Einfachgerät BA		BA = Bremsassistent		Z = Zugankerbremsgeräte		24.02dd-dxxx.x → 230/231 × 47	48nnnn Durchmesser / maximaler Durchmesser × Tiefe
d	y																										
	0 = Einfachgerät 5 = Tandemgerät																										
2 = 6"																											
3 = 7"																											
4 = 8"	0 = Einfachgerät																										
5 = 9"	3 = Einfachgerät BA																										
6 = 10"	5 = Einfachgerät																										
	8 = Einfachgerät BA																										
	BA = Bremsassistent																										
	Z = Zugankerbremsgeräte																										
	03.78dy-xxxx.4 → 03.78dy-xxxx.4 → 03.78dy-xxxx.4 → 03.78dy-xxxx.4 → 03.78dy-xxxx.4 → 03.78dy-xxxx.4 → 03.78dy-xxxx.4 →	30nnnn 30nnnn 30nnnn 30nnnn 30nnnn 30nnnn 30nnnn	T52/4 T52/4Z T52/5 T52/5Z T55/1 T55/1Z		▲ 03.27dd-xxxx.3 → ▲ 03.32dd-xxxx.3 → 03.040x-xxdd.2 → 03.0470-xxdd.2 →	02nnnn 02nnnn 06nnnn 06nnnn	einseitig wirkender Radzylinder Radzylinder Reparatur-Satz (mit Kolben) Dichtungs-Satz (ohne Kolben)																				
	03.78dy-xxxx.4 → 03.78dy-xxxx.4 → 03.78dy-xxxx.4 → 03.78dy-xxxx.4 → 03.78dy-xxxx.4 → 03.78dy-xxxx.4 → 03.78dy-xxxx.4 →	30nnnn 30nnnn 30nnnn 30nnnn 30nnnn 30nnnn 30nnnn	T52/4 T52/4Z T52/5 T52/5Z T55/1 T55/1Z		03.0137-0xxx.2 → 03.0137-9xxx.2 →	650xxx 669xxx	Trommelbremsbacken Bremsbacken-Zubehör																				
	▲ 03.20dd-xxxx.3 → ▲ 03.21dd-xxxx.3 → ▲ 03.23dd-xxxx.3 → ▲ 03.31dd-xxxx.3 → 03.0370-xxdd.2 →	01nnnn 01nnnn 01nnnn 01nnnn 05xxdd	Tandem-Hauptzylinder gestuft Tandem-Hauptzylinder Stufen-Hauptzylinder Hauptzylinder (z. B. 03.2122-: Ø=22,20) Reparaturatz		185 × 31 AUT HEB Zub		Durchmesser × Breite mit automatischer Nachstellung mit Hebel mit Zubehör																				
	03.3508-xxxx.x → 03.3509-xxxx.x → 03.3558.0xxx.x → 03.0101-xxxx.2 →	31nnnn 31nnnn 31nnnn 39nnnn	Ausgleichsbehälter Ausgleichsbehälter Ausgleichsbehälter Reparaturatz		03.0420-xxdd.3 → 03.0520-xxdd.3 →	68xxdd 69xxdd	ATE Original Kit ATE Original TopKit (Radzylinder + Trommelbrems- backen + Einbausatz) dd = Nennmaß Radzylinder																				
	▲ 11.3ddx-xxxx.2 → 11.9ddx-xxxx.2 → ▲ 13.2ddx-xxxx.2 → ▲ 13.4ddx-xxxx.2 → 13.9ddx-xxxx.2 → 24.3ddx-xxxx.5 → 11.0441-ddxx.2 → 13.0441-ddxx.2 → 11.0230-xxxx.2 → 24.0101-xxxx.2 → ▲ 11.0101-xxxx.2 → 11.8116-xxxx.1 →	22nnnn 22nnnn 21nnnn 21nnnn 21nnnn 24nnnn 25nnnn 25nnnn 26nnnn 26nnnn 26nnnn 39nnnn	Faustsattel Faustsattel 2-Zyl. Festsattel 4-Zyl. Festsattel Festsattel Austauschsattel Faustsattel Dichtungs-Satz Dichtungs-Satz Faustsattelhalter-Satz (Halter, Schiebehülzensatz, Führungsbolzen) Bremsattel-Zubehör (Schiebehülzensatz, Führungsbolzen) Schiebehülzensatz Haltefeder		03.0137-0xxx.2 → 03.0137-9xxx.2 →	650xxx 669xxx	Feststellbremse (Trommelbremsbacken) Einbausatz																				
	13.0460-xxxx.2 → 13.0460-0xxx.2 → 24.8190-xxxx.2 →	60xxxx 610xxx 62xxxx	Scheibenbremsbelag Belagsatz-Zubehör Warnkontakt		24.3727-xxxx.2 →	58xxxx	Handbremsseil																				
	20034 15,0 + WE WK S Zub		WVA-Nummer / Dicke weitere WVA-Nummern siehe Anhang Warneinrichtung mit Warnkontakt mit Sattelschraube mit Zubehör		83.5yxx-LLLL.3 → 83.6yxx-LLLL.3 → 83.7yxx-LLLL.3 →	33nnnn 33nnnn 33nnnn	Brems-/Kupplungsschlauch Brems-/Kupplungsschlauch Brems-/Kupplungsschlauch y = 1: Gewinde 1 × innen/1 × außen y = 2: Gewinde 2 × innen y = 3: Gewinde 2 × außen																				
	13.0460-xxxx.2 → 13.0460-0xxx.2 → 24.8190-xxxx.2 →	60xxxx 610xxx 62xxxx	Scheibenbremsbelag Belagsatz-Zubehör Warnkontakt		03.60xx-xxxx.3 → 03.65xx-xxxx.3 → 03.0101-xxxx.2 →	32nnnn 32nnnn 32nnnn	Bremskraftregler (BR) Bremskraftbegrenzer (BG) Einschraubregler (BRE) Bremskraftregler lastabhängig (BRL) Einschraubregler-Satz (BRES)																				
	20034 15,0 + WE WK S Zub		WVA-Nummer / Dicke weitere WVA-Nummern siehe Anhang Warneinrichtung mit Warnkontakt mit Sattelschraube mit Zubehör		35/3 braun (4)		Kennzeichen, Farbmarkierung (Anzahl der Anschlüsse)																				
Bremsbelagsätze haben eine Allgemeine Betriebserlaubnis (ABE) oder eine Homologation nach ECE-R90, bzw. kommen aus derselben Fertigung und unterliegen derselben Qualitätssicherung wie der vom Fahrzeughersteller vorgesehene Belag.					▲ 03.24dd-xxxx.3 → 03.0350-ddxx.2 →	03nnnn 07ddxx	Kupplungs-Geberzylinder (z. B. 03.2419-: Ø=19,05) Dichtungs-Satz																				
	24.01dd-xxxx.x → 24.03dd-xxxx.x →	4ddxxx 5ddxxx	Bremsscheibe ATE PowerDisc dd = Dicke (z.B. 24.0322- : Dicke = 22)		▲ 03.25dd-xxxx.3 → 03.0450-ddxx.2 →	04nnnn 08ddxx	Kupplungs-Nehmerzylinder (z. B. 03.2525-: Ø=25,40) Dichtungs-Satz																				
	284 22 20 V L PD B V L S PD		Durchmesser / Dicke / Mindestdicke beschichtet belüftet legiert / hochgekocht Fixierschraube ATE PowerDisc		24.3728-xxxx.2 →	59xxxx	Kupplungsseil																				
					24.07xx-xxxx.x →	36nnnn	Radsensor																				

nnnn = Die letzten vier Ziffern entsprechen einer Zählnummer.

dd = Nennmaß

▲ Auch 24. bei gleicher Benummerungssystematik möglich.

■ Auch 03., 24. und 83. bei gleicher Benummerungssystematik möglich.

Nachdruck, auch auszugsweise, nur mit unserer Genehmigung gestattet. Ersatzansprüche auf Grund von Angaben in diesem Katalog können nicht anerkannt werden. Konstruktionsänderungen vorbehalten. Soweit wir in unseren Unterlagen Bezug nehmen auf die Ersatzteilnummer des Fahrzeugherstellers, dient dies nur zu Vergleichszwecken. Eine Verwendung derartiger Angaben in Rechnungen an den Fahrzeugbesitzer ist nicht statthaft.

Die Modell- und Ersatzteilvervielfalt einiger Fahrzeughersteller erlaubt nicht immer eine genaue Zuordnung. Bitte beachten Sie daher besonders die im Katalog aufgeführten Bemerkungen und Ersatzteilbeschreibungen.

C5

D Inhaltsverzeichnis

ATE Classic	2
Bremsflüssigkeit	4
Fahrzeugregister	7
Fahrzeugverwendungen	12
Abmessungen Bremsscheiben	497
Armaturen	542
Bremsgeräte komplett	556
Reparatursätze	570
Vergleichsliste	591
Technische Übersetzungen	646
So benutzen Sie den C5	655

EN Table of contents

ATE Classic	2
Brake fluid	4
Index of vehicles	7
Applications of vehicles	12
Dimensions brake discs	497
Fittings	542
Booster units complete	556
Repair kits	570
Cross reference list	591
Technical translations	646
How to use the C5	655

FR Table des matières

ATE Classic	2
Liquides de frein	4
Liste des véhicules	7
Applications	12
Dimensions Disques de frein	497
Composants et accessoires	542
Servo-freins complets	556
Nécessaires de réparation	570
Liste des correspondances	591
Traductions techniques	646
Utilisation du catalogue C5	655

ES Índice

ATE Classic	2
Líquido de freno	4
Índice de vehículos	7
Aplicaciones	12
Medidas disco de freno	497
Assesorios	542
Servofreno completo	556
Juegos de reparación	570
Lista comparativa WVA	591
Traducciones técnicas	646
Use así el C5	655

ATE Classic – Teile und Service

Originalgetreue Bremseninstandsetzung
für Old- und Youngtimer

Wir lieben Oldies

Old- und Youngtimer wecken Emotionen. Sie werden liebevoll restauriert und gepflegt. Denn sie sollen ihren Besitzern möglichst lange erhalten bleiben. Neben dem optischen Anspruch sollen sie natürlich auch sicher im Straßenverkehr unterwegs sein. Hierzu brauchen sie vor allem intakte Bremsen.

Originalgetreue Bremseninstandsetzung

Mit der neuen Produktfamilie ATE Classic unterstützen wir von Continental Freunde klassischer Automobile bei der professionellen und originalgetreuen Bremseninstandsetzung. ATE Classic bietet ein breit gefächertes Programm an Bremsenersatzteilen speziell für Old- und Youngtimer. Zudem gibt es unter dem neuen Produktnamen Classic einen zielgruppenorientierten Service für das Beschaffen rar gewordener Komponenten von Bremssystemen.

Nachschlagewerk für Bremsenersatzteile

In unserem neuen ATE Classic Katalog finden Fachleute ein breites Spektrum verfügbarer Bremsenersatzteile. Dieses Programm haben wir speziell für Pkw und Nkw zusammengestellt, die älter sind als 20 Jahre. Das ATE Classic Programm umfasst alle Produktgruppen innerhalb des Bremssystems und reicht von Verschleißteilen bis hin zu mechanischen und hydraulischen Betätigungskomponenten.

Besonderer Service für besondere Fahrzeuge

Sollte ein Bremsenersatzteil nicht im ATE Classic Katalog zu finden sein, können Sie sich mit Hilfe eines Anfrageformulars unter www.ate-classic.de direkt an unsere ATE Classic Vertriebs-Spezialisten wenden. Wir prüfen, ob das benötigte Ersatzteil im Lager verfügbar ist oder neu produziert werden kann. Darüber hinaus beraten wir Sie über technisch gleichwertige Alternativen und geben Hinweise auf mögliche Bezugsquellen.

Klassik-Kompetenz steigern - neue Kunden gewinnen

Die Marke ATE hat eine lange Tradition in der Automobilgeschichte. Schon seit mehr als hundert Jahren entwickelt und produziert ATE innovative Bremssysteme. Zahlreiche wegweisende Entwicklungen in der Bremsentechnik sind auf das Know-how von ATE zurückzuführen. Mit ATE Classic bündeln wir von Continental im Automotive Aftermarket nun diese Erfahrungen und helfen Ihnen, den Fachleuten aus Handel und Kfz-Werkstätten, ihre Klassik-Kompetenz auszubauen. Zudem öffnet ATE Classic den Zugang zu neuen Kundengruppen.



ATE Classic: Vorteile im Überblick

- umfangreiches Produktprogramm – speziell für Pkw und Nfz, die älter sind als 20 Jahre
- Übersichtlicher ATE Classic Katalog
- schnelle Lieferung der im Katalog gelisteten Ersatzteile über den Fachhandel
- Verfügbarkeit des ATE Classic Programms in elektronischen Teilekatalogen (TecDoc)
- sichere und originalgetreue Bremsenreparatur dank ATE Bremsenersatzteilen in OE-Qualität
- Beratung über technisch gleichwertige Alternativen
- Hilfestellung beim Beschaffen vergriffener Ersatzteile

ATE Classic – parts and service

Brake repairs with authentic parts for classic
and near-classic cars



We love classic cars

Classic cars – and those that are on the way to becoming classics – evoke strong emotions. They are restored and maintained with loving care, and their owners want to keep them in top condition for as long as possible. While preserving a first-rate appearance is an important goal, these cars must be safe on the road as well. And that means having effective brakes.

Brake repairs with authentic parts

Continental's new ATE Classic product family allows classic car enthusiasts to carry out professional brake repairs with parts that match the originals. ATE Classic provides an extensive line of replacement parts suited especially for classic and near-classic cars. In addition, the new Classic service helps owners to procure brake system components that have become hard to find.

Reference work for replacement brake parts

Our new ATE Classic catalog offers professionals a wide range of replacement parts for brakes. We've put together this selection especially for cars and commercial vehicles that are over 20 years old. The ATE Classic product family includes all brake system product groups, from wear parts all the way up to mechanical and hydraulic actuation components.

A special service for special vehicles

If you do not find a particular replacement part in the ATE Classic catalog, you can contact our ATE Classic sales specialists directly using a query form at www.ate-classic.com. We'll check whether we have the part in stock and, if not, whether we can produce a new one. Moreover, we'll advise you on alternatives that are equally effective from a technical standpoint and tell you where you can obtain them.

Enhance your classic car expertise and win new customers

The ATE brand has a longstanding reputation in the automotive industry. For more than one hundred years, ATE has developed and manufactured innovative brake systems, introducing many groundbreaking advances. Now, with ATE Classic, Continental has brought all this experience together. ATE Classic will help you as a dealer or repair facility to enhance your expertise in classic cars, enabling you to gain access to new customer groups.



ATE Classic: summary of the advantages

- Extensive product range geared to cars and commercial vehicles over 20 years old
- Easy-to-use ATE Classic catalog
- Quick delivery, via specialist dealers, of spare parts listed in the catalog
- Availability of ATE Classic products in electronic parts catalogs (TecDoc)
- Reliable brake repairs that are true to the original, using ATE spare parts in OEM quality
- Advisory service for finding equally effective alternatives
- Support in procuring spare parts that are no longer on the market
- Enhancement of classic car expertise for dealers and repair facilities, thus providing access to new customer groups
- Further information at www.ate-classic.com



Mehr als sicher More than safe

Bremsflüssigkeiten

ATE hat für jedes Fahrzeugmodell und jede Fahrweise die optimale Bremsflüssigkeit. Und alle lassen die gesetzlichen und technischen Standards weit hinter sich. Das Highlight für elektronische Bremssysteme: ATE SL.6. Die dünnflüssige Textur sorgt bei Niedrigtemperaturen für eine schnelle Reaktion von ABS oder ESP® – und so für höchste Sicherheit.

Brake fluids

ATE has the optimal brake fluid for every vehicle model and every driving style – and all our fluids leave the legal and technical standards far behind. Our highlight for electronic braking systems – the ATE SL.6. The low-viscosity texture ensures a quick response from ABS or ESP® at low temperatures, guaranteeing maximum safety.

Die Eigenschaften von ATE Bremsflüssigkeiten The properties of ATE brake fluids

	Siedepunkt Boiling point	Nass-Siedepunkt Wet boiling point	Viskosität bei -40 °C Viscosity at -40 °C	Wechselintervall Replacement interval
ATE G DOT 3	min. 245 °C	min. 150 °C	max. 1.500 mm ² /s max. 1,500 mm ² /s	bis 1 Jahr up to 1 year
ATE SL DOT 4	min. 260 °C	min. 165 °C	max. 1.400 mm ² /s max. 1,400 mm ² /s	bis 1 Jahr up to 1 year
ATE SL.6 DOT 4 Ideal für/Ideal for ESP®, ABS, ASR	min. 265 °C	min. 175 °C	max. 700 mm ² /s	bis 2 Jahre up to 2 years
ATE TYP 200 DOT 4 New Racing Quality	min. 280 °C	min. 198 °C	max. 1.400 mm ² /s max. 1,400 mm ² /s	bis 3 Jahre up to 3 years
ATE SUPER DOT 4	min. 260 °C	min. 180 °C	max. 1.400 mm ² /s max. 1,400 mm ² /s	bis 2 Jahre up to 2 years

Typ Type	ATE Sachnummer ATE partnumber	EAN-Nr. 4006633 EAN-No. 4006633	Gebinde Container size	Paletteneinheit* Pallet units*
G SAE Spezifikation J1703-FMVSS 116/DOT 3	705302 03.9901-5302.2/02	10199 8	1 l	D
	705303 03.9901-5303.2/02	10201 8	5 l	F
größere Gebinde auf Anfrage – Bigger container sizes on demand				
SL SAE Spezifikation J1704-FMVSS 116/DOT 4	705808 03.9901-5808.2/02	49000 9	1/4 l	A
	705801 03.9901-5801.2/02	49001 6	1/2 l	B
	705802 03.9901-5802.2/02	49002 3	1 l	D
	705803 03.9901-5803.2/02	49003 0	5 l	F
	705811 03.9901-5811.2/02	29907 7	20 l	R
	705820 03.9901-5820.2/01	10824 9	30 l	H
	705814 03.9901-5814.2/01	10366 4	50 l	P
SL.6 NEW SAE Spezifikation J1704-FMVSS 116/DOT 4 ISO Klasse 6 – niedrigviskos	706408 03.9901-6408.2/02	22762 9	1/4 l	A
	706402 03.9901-6402.2/02	20746 1	1 l	D
	706403 03.9901-6403.2/02	20748 5	5 l	F
	706411 03.9901-6411.2/02	20750 8	20 l	R
	706420 03.9901-6420.2/02	23120 6	30 l	H
	706414 03.9901-6414.2/02	23005 6	50 l	P
	706405 03.9901-6405.2/02	23121 3	200 l	S
TYP 200 New racing quality SAE Spezifikation J1704-FMVSS 116/DOT 4	706202 03.9901-6202.2/02	10825 6	1 l	D
	706203 03.9901-6203.2/02	12166 8	5 l	F
	706220 03.9901-6220.2/01	12780 6	30 l	H
	706214 03.9901-6214.2/01	12779 0	50 l	P
	706205 03.9901-6205.2/01	12778 3	200 l	S
SUPER DOT 4 SAE Spezifikation J1704-FMVSS 116/DOT 4	706003 03.9901-6003.2/02	06249 7	5 l	F
	706020 03.9901-6020.2/01	14544 2	30 l	H
	706005 03.9901-6005.2/01	07769 9	200 l	S
ATE Bremszylinder-Paste ATE Brake Cylinder Paste	700009 03.9902-05XX.2/02	13536 8	180 g	L
	700010 03.9902-0503.2/01	13532 0	5 kg	K
	700011 03.9902-0504.2/01	13530 6	40 kg	P
ATE Prüfflüssigkeit ATE Testing Fluid	700002 03.9902-0116.2/02	10374 9	5 l	F
ATE plastilube™	700014 03.9902-1001.2/02	05176 7	35 ml	I
	700015 03.9902-1002.2/02	05184 2	75 ml	J
ATE Leerkanne ATE neutral empty container	740169 03.9302-1474.1/01	07782 8	25 l	S
Ausgiesser für 5-l-Kanne Spout for 5l container	760070 03.9314-5940.3/01	07786 6	1 St.	S
Kannen-Auslass-Hahn für 5-l- und 20-l-Kanne Tap for 5l and 20l tin	760153 03.9314-5960.3/02	30855 7	1 St.	S

***Paletteneinheit:**

A = 1.728 Kannen je Palette (24 Kannen je Karton)
B = 1.200 Kannen je Palette (20 Kannen je Karton)
D = 600 Kannen je Palette (10 Kannen je Karton)
E = 360 Kannen je Palette (10 Kannen je Karton)
F = 144 Kannen je Palette (4 Kannen je Karton)
G = 50 Kannen je Palette
H = 22 Kannen je Palette
I = 5.040 Tuben je Palette (24 Tuben je Karton)
J = 1.728 Tuben je Palette (12 Tuben je Karton)
K = 60 Eimer je Palette
L = 1.800 Tuben je Palette (40 Tuben je Karton)
M = 18 Kannen je Palette
N = 300 Kannen je Palette (10 Kannen je Karton)
O = 64 Kannen je Palette (4 Kannen je Karton)
P = 12 Kannen je Palette
R = 36 Kannen je Palette
S = 1 Stück

***Pallet units:**

A = 1.728 containers per pallet (24 containers per box)
B = 1.200 containers per pallet (20 containers per box)
D = 600 containers per pallet (10 containers per box)
E = 360 containers per pallet (10 containers per box)
F = 144 containers per pallet (4 containers per box)
G = 50 containers per pallet
H = 22 containers per pallet
I = 5.040 tubes per pallet (24 tubes per box)
J = 1.728 tubes per pallet (12 tubes per box)
K = 60 buckets per pallet
L = 1.800 tubes per pallet (40 tubes per box)
M = 18 containers per pallet
N = 300 containers per pallet (10 tubes per box)
O = 64 containers per pallet (4 containers per box)
P = 12 containers per pallet
R = 36 containers per pallet
S = 1 piece





A large rectangular area containing 30 horizontal lines, intended for writing or drawing.





Ⓛ **Fahrzeugregister**

Ⓛ **Index of vehicles**

Ⓛ **Liste des véhicules**

Ⓛ **Índice de vehículos**

**ALFA ROMEO**

6 (79-86)	12
33 (83-89)	12
33 (90-94)	12
75 (86-92)	13
90 (84-87)	14
155 (92-97)	14
164 (87-91)	15
1300 GT Junior / 2000 GTV (66-79)	15
1750 (68-72)	16
ALFASUD (71-84)	16
ALFETTA (72-84)	16
AR 6 (85-89)	17
AR 8 (78-89)	17
ARNA (83-87)	18
GIULIA (62-79)	18
GIULIETTA (77-85)	18
GTV (81-87)	19
MONTREAL (70-74)	19
R.Z. SPEEDSTER (92-93)	19
SPIDER (68-93)	20
SPRINT (76-89)	20
S.Z. COUPE (89-92)	21

AUDI

50 (74-78)	21
60/75/80/90 (65-73)	21
80 (72-78)	21
80 (79-81)	23
80 (82-84)	24
80 (84-87)	26
80 (87-91)	27
80 (91-95)	29
80 Quattro (78-86)	31
80 Quattro (87-91)	32
80 Quattro (92-95)	33
90 (85-87)	34
90 (87-91)	34
90 Quattro (84-87)	36
90 Quattro (87-91)	36
100 (68-76)	37
100 (76-79)	37
100 (80-81)	38
100 (82)	39
100 (83-90)	39
100 (91-94)	44
100 Quattro (85-90)	46
100 Quattro (91-94)	47
200 Quattro (85-91)	48
200 (80-83)	49
200 (84-91)	49
A6 / A6 Avant (4A/C4) (94-97)	50
COUPE (81-88)	53
COUPE Quattro (85-87)	55
COUPE (89-96)	55
COUPE Quattro (87-96)	57
QUATTRO (80-91)	58
V8 (88-94)	59

AUSTIN

METRO (80-90)	60
MINI (67-93)	60

AUTO UNION

AU 1000 (58-65)	60
-----------------	----

AUTOBIANCHI

A 111 (69-72)	60
A 112 (69-86)	60
GIADINIERA (60-78)	60
Y 10 (85-95)	61

BMW

501 / 502 (55-60)	61
700 / 700 Coupe (59-66)	61
1502 - 2002 (65-77)	61
2000 (66-69)	63
2,5/2,8/3,0/3,3 (68-77)	63
3er Reihe/E21 (75-83)	64
3er Reihe/E30 (82-93)	66
5er Reihe/E12 (72-81)	71
5er Reihe/E28 (81-87)	73
5er Reihe/E34 (88-96)	76
6er Reihe/E24 (76-89)	80
7er Reihe/E23 (77-86)	81
7er Reihe/E32 (86-94)	83
Isetta	85
M1 (79-83)	85
Z1 (88-91)	85

BMW / GLAS

GOGGOMOBIL (55-69)	85
--------------------	----

**BORGWARD**

ISABELLA (54-62)	86
------------------	----

BÜSSING

BUS BS 100 - BS 180	86
BUS KONSUL	86
BUS PRÄFEKT	86
BUS PRÄSIDENT	86
BUS SENATOR	86
BUS TU 5 - TU 11	86
LKW BS 09 - BS 22	86
LKW COMMODORE	87
LKW LS7/LU7 - LS77/LU77	88
LKW SUPERCARGO	88
LKW 6000-8000	88

CHRYSLER

CONCORDE (LP41) (92-97)	88
VISION (XP41) (93-97)	88
VOYAGER (ES) (90-95)	88

CITROEN

2CV (63-90)	89
ACADIANE (78-85)	89
AMI 8 (69-78)	89
BX (82-93)	89
CX I Limousine (74-85)	91
CX I Kombi (75-85)	91
CX II Limousine (86-92)	92
CX II Kombi (86-92)	92
C15 (84-05)	92
C25 (81-94)	94
DYANE (69-83)	95
LN/LNA (76-86)	95
MEHARI (68-87)	96
VISA (78-89)	96
XANTIA (X1) Limousine (93-97)	96
XANTIA (X1) Kombi (95-97)	98
XM (Y3) Limousine (89-94)	99
XM (Y3) Kombi (91-94)	100
ZX (N2) Limousine (91-97)	101

DAEWOO

ARANOS (95-97)	105
----------------	-----

DAF

44 (66-74)	105
55 (67-72)	105
66 (72-75)	106
428-435 (89-93)	106

DAIHATSU

APPLAUSE I (89-97)	106
CHARADE (87-92)	106
CUORE (85-90)	106
CUORE (90-94)	106
FEROZA (88-95)	106

DAIMLER

XJ (40,81) (89-94)	106
--------------------	-----

DE TOMASO

PANTERA	107
---------	-----

DKW

F102 (64-66)	107
Meisterklasse/Sonderklasse/Universal (50-57)	107
Schnell-Laster/Bus	107
3=6 (55-57)	107

FAUN

Kraftkarren (Kraka)	107
---------------------	-----

FERRARI

FERRARI	107
---------	-----

FIAT

124 (66-74)	107
-------------	-----

**FIAT**

125 (66-74)	107
126 (72-90)	108
127 (71-86)	108
128 (69-84)	109
131 (74-84)	109
132 (72-81)	109
500/600 (-75)	109
850 (68-72)	110
900 (78-85)	110
ARGENTA (81-86)	110
CROMA (85-90)	110
CROMA (91-96)	111
DUCATO (81-94)	112
DUNA (87-90)	113
FIORINO (88-93)	113
PANDA (80-85)	114
REGATA (83-89)	114
RITMO (78-88)	115
TALENTO (88-94)	116
TEMPRA (90-93)	117
TEMPRA (93-96)	118
TIPO (88-93)	119
TIPO (93-95)	122
UNO (83-89)	123
UNO (90-06)	124
X 1/9 (72-89)	126

FORD

A-Serie (73-83)	126
12M/15M (62-70)	126
17M/20M/26M (60-71)	126
CAPRI (68-74)	126
CAPRI (74-86)	126
CONSUL / GRANADA (72-85)	127
ECONOVAN (85-92)	128
ESCORT (70-80)	128
ESCORT / ORION (81-85)	128
ESCORT / ORION (86-90)	129
ESCORT / ORION (91-94)	130
FIESTA (76-89)	132
FIESTA III (89-96)	133
MAVERICK (93-96)	136
MONDEO I (93-96)	136
PROBE (91-92)	138
PROBE (93-97)	138
SCORPIO / GRANADA (GB) (85-91)	138
SCORPIO / GRANADA (GB) (92-94)	139
SIERRA (82-86)	140
SIERRA (87-93)	141
TAUNUS / CORTINA (GB) (70-82)	145
Transit FK1000/FK1250 (59-65)	145
TRANSIT (65-77)	145
TRANSIT (78-85)	146
TRANSIT (86-91)	147
TRANSIT (92-94)	149

HANOMAG

A-L 28	152
F 20 - F 86	153
GARANT	153
KURIER	153
MARKANT / ATHLET	153
MATADOR	153

HENSCHEL

F111 - F 261	154
HS 3 - HS 160	154

HONDA

ACCORD (81-85)	154
ACCORD (85-89)	154
ACCORD (90-93)	154
ACURA INTEGRA (84-90)	155
BALLADE (GB) (86-91)	155
CONCERTO (90-95)	155
CIVIC (79-83)	155
CIVIC (83-87)	155
CIVIC (3-tuerig) (87-91)	156
CIVIC (4-tuerig) (87-91)	156
CIVIC (3-tuerig) (91-95)	156
CIVIC (4-tuerig) (91-95)	157
CIVIC (5-tuerig) (94-96)	157
CIVIC COUPE (94-95)	158
CIVIC SHUTTLE (83-87)	158
CIVIC SHUTTLE (87-91)	158
CRX (83-87)	158
CRX (87-91)	158
LEGEND (86-88)	158
LEGEND (91-96)	159
PRELUDE (83-87)	159
PRELUDE (87-91)	159
PRELUDE (92-96)	159
QUINTET (80-83)	159





TOYOTA

LAND CRUISER STATION WAGON 60-62 (80-89)	402
LAND CRUISER STATION WAGON 80 (90-97)	402
MODEL-F (82-88)	402
MODEL-F (88-90)	402
MR2 (84-89)	403
PASEO (91-95)	403
STARLET (84-89)	403
STARLET (89-96)	403
SUPRA (86-93)	403
TERCEL (82-88)	403

TRABANT

1,1 (90-91)	403
601 (65-90)	403

VOLKSWAGEN

411/412 (Typ 4) (68-75)	403
1500/1600 (TYP 3) (61-75)	403
CADDY I (83-92)	404
CORRADO (88-95)	405
DERBY/POLO Stufenheck (77-88)	406
GOLF I (74-83)	407
GOLF I Cabriolet (79-93)	410
GOLF II (84-93)	411
GOLF III (92-97)	416
ILTIS (79-88)	422
JETTA I (79-83)	422
JETTA II (84-92)	423
KÄFER (TYP 1) (49-03)	427
LT/LT 4x4 (75-96)	428
PASSAT Limousine (85-88)	429
PASSAT Variant (73-84)	431
PASSAT Variant (85-88)	433
PASSAT/SANTANA Limousine (73-84)	435
PASSAT (88-93)	437
PASSAT (94-96)	441
POLO I (75-81)	443
POLO II (81-94)	444
SCIROCCO I (74-83)	445
SCIROCCO II (84-92)	447
TARO (89-97)	448
TRANSPORTER (Typ 2) (60-79)	448
TRANSPORTER (Typ 2) (79-92)	449
TYP 181 (69-79)	452

VOLVO



























66 (75-80)	452
140 Limousine (68-75)	452
145 Kombi (68-75)	452
164 (68-74)	452
240 Limousine (74-93)	453
240 Kombi (74-93)	456
260 Limousine (74-82)	459
260 Kombi (75-82)	460
260 Coupe (77-78)	461
340 (76-90)	461
345 (80-89)	461
360 (82-90)	461
440 (88-96)	462
460 (88-96)	464
480 (86-96)	466
740 Limousine (83-92)	467
740 Kombi (85-92)	474
760 Limousine (82-92)	479
760 Kombi (82-92)	481
850 Limousine (91-96)	483
850 Kombi (92-96)	485
940 I Limousine (90-95)	487
940 I Kombi (90-95)	490
960 I Limousine (90-94)	492
960 I Kombi (90-94)	493
960 II Limousine (94-96)	494
960 II Kombi (94-96)	495
1800 Sport (68-72)	495

WARTBURG

1,3 (88-91)	495
353 (69-88)	496

ZASTAVA

101 (73-93)	496
750	496

								
ALFA ROMEO 6 (79-86)								
	2.5 i.e.		04.79	12.86	13.0441-4018.2	250083		Dichtungssatz ATE
	2.5 i.e.		04.79	12.86	13.0460-9034.2	609034		20437 15,0 /WE ATE
	2.5 i.e.		04.79	12.86	13.0441-4212.2	250089		Dichtungssatz ATE
ALFA ROMEO 33 (83-89)								
	1.2 1.3 1.5 Lim. 1.5 Sportwagon 1.7 1.8 TD	77	05.83 05.83 05.83 05.83 03.88 10.86	08.89 08.89 08.89 08.89 08.89 08.89 + ①	11.0101-4802.2	260007		Hülsensatz ATE
	1.7	84	03.88	08.89	11.0441-4810.2	250023		Dichtungssatz ATE
					11.0101-4802.2	260007		Hülsensatz ATE
	1.2 1.3 1.5 Lim. 1.5 Sportwagon 1.7 1.8 TD	77	09.85 09.85 09.85 09.85 03.88 10.86	08.89 08.89 08.89 08.89 08.89 08.89 + ①	13.0460-7055.2	607055		21063 14,8 +/WK ATE
	1.7	84	03.88	08.89	13.0460-3905.2	603905		21132 14,7 +/WK BDX
					13.0460-2969.2	602969		21165 16,8 +/WK TRW
	1.2 1.3 1.5 Lim. 1.5 Sportwagon 1.7 1.8 TD	77	09.85 09.85 09.85 09.85 03.88 10.86	08.89 08.89 08.89 08.89 08.89 08.89 + ①	24.0113-0171.1	413171		239 12,6 9,0
	1.7	84	03.88	08.89	24.0122-0128.1	422128		239 22,0 20,2 V
	1.2 1.3 1.5 Lim. 1.5 Sportwagon 1.7 1.8 TD		09.85 09.85 09.85 09.85 03.88 10.86	08.89 08.89 08.89 08.89 08.89 08.89 + ①	24.3217-1112.3	020175		Rz 17,46 BDX
	1.2 1.3 1.5 4x4 1.5 Lim. 1.7 4x4		05.83 05.83 05.83 05.83 03.88	08.85 08.85 08.89 08.85 08.89	03.0137-0139.2	650139		229 x 42 BDX
					03.0137-9020.2	669020		Bremsbacken-Zubehör BDX
	1.2 1.3 1.5 Lim. 1.5 Sportwagon 1.7 1.8 TD		09.85 09.85 09.85 09.85 03.88 10.86	08.89 08.89 08.89 08.89 08.89 08.89 + ①	03.0137-0262.2	650262		203 x 39 BDX
					03.0137-9125.2	669125		Bremsbacken-Zubehör BDX
	1.2 1.3 1.5 Lim. 1.5 Sportwagon 1.7 1.8 TD		05.83 05.83 05.83 05.83 03.88 10.86	08.89 08.89 08.89 08.89 08.89 08.89 + ①	03.2419-8000.3	030017	- Bodenventil 1)	Gz 19,05
	1.2 1.3 1.5 Lim. 1.5 Sportwagon 1.7 1.8 TD		05.83 05.83 05.83 05.83 03.88 10.86	08.89 08.89 08.89 08.89 08.89 08.89 + ①	03.2525-2201.3	040026		Nz 25,40
ALFA ROMEO 33 (90-94)								
	1.7 1.7 4x4 1.8 TD		09.89 09.89 09.89	08.94 08.94 08.94 + ①	11.0441-4810.2	250023		Dichtungssatz ATE
					11.0101-4802.2	260007		Hülsensatz ATE
	1.4 1.4 4x4 1.5		06.91 07.90 01.90	08.94 08.94 08.94	13.0460-2968.2	602968		20332 17,0 +/WK/S TRW
	1.4 1.4 4x4 1.5 1.8 TD		06.91 07.90 01.90 09.89	08.94 08.94 08.94 08.94 + ①	24.0113-0171.1	413171		239 12,6 9,0
	1.7 1.7 4x4		09.89 09.89	08.94 08.94	24.0122-0128.1	422128		239 22,0 20,2 V
	1.7		09.89	08.94 + ABS	24.0111-0149.1	411149		241 11,0 9,2
	1.4 1.4 4x4 1.5 1.7 1.7 4x4		06.91 07.90 01.90 09.89 09.89	08.94 08.94 08.94 08.94 - ABS 08.94 - ABS	24.3217-1112.3	020175		Rz 17,46 BDX

1) - residual press.center valve / - valvola p.pressione residua / - soup.de pression résiduelle / - válvula de fondo

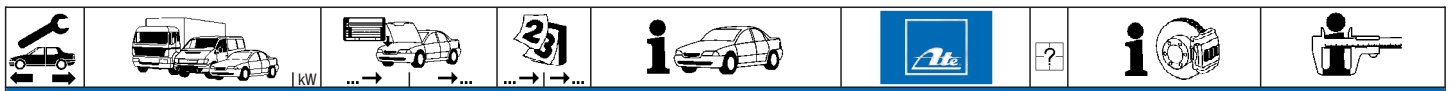

ALFA ROMEO 33 (90-94)											
	1.8 TD			09.89	08.94 + ①		24.3217-1112.3	020175		Rz 17,46	BDX
	1.4 1.4 4x4 1.5 1.7 1.7 4x4 1.8 TD			06.91 07.90 01.90 09.89 09.89 09.89	08.94 08.94 08.94 08.94 - ABS 08.94 - ABS 08.94 + ①		03.0137-0262.2 03.0137-9125.2	650262 669125		203 x 39 Bremsbacken-Zubehör	BDX BDX
	1.4 1.4 4x4 1.5 1.7 1.7 4x4 1.8 TD			06.91 07.90 01.90 09.89 09.89 09.89	08.94 08.94 08.94 08.94 08.94 08.94 + ①		03.2419-8000.3	030017	- Bodenventil ¹⁾	Gz 19,05	
	1.4 1.4 4x4 1.5 1.7 1.7 4x4 1.8 TD			06.91 07.90 01.90 09.89 09.89 09.89	08.94 08.94 08.94 08.94 08.94 08.94 + ①		03.2525-2201.3	040026		Nz 25,40	

ALFA ROMEO 75 (86-92)											
	1.6 1.8 1.8 Turbo 2.0 2.0 T.Spark 2.0 TD 2.4 TD 2.5 i V6 3.0 i V6			09.85 09.85 03.86 09.85 09.87 09.85 10.89 09.85 04.87	03.92 03.92 03.92 08.87 03.92 - gepanzerte Fahrzeuge ²⁾ 03.92 03.92 03.92 03.92		03.2122-0142.3	010128		Thz 22,20	ATE
	1.6 1.8 1.8 Turbo 2.0 2.0 T.Spark 2.0 TD 2.4 TD 2.5 i V6 3.0 i V6			09.85 09.85 03.86 09.85 09.87 09.85 10.89 09.85 04.87	03.92 03.92 03.92 08.87 03.92 03.92 03.92 03.92 03.92		03.3558-0676.3	310077	- ABS	Behälter + WE	
	1.6 1.8 2.0			09.85 09.85 09.85	03.92 03.92 08.87		13.0441-4819.2	250104		Dichtungssatz	ATE
	2.0 T.Spark			09.87	03.92 + gepanzerte Fahrzeuge ³⁾		13.0441-4819.2	250104		Dichtungssatz	ATE
	1.6 1.8 2.0 T.Spark	2050227 2050227		09.85 09.85 09.87	03.92 03.92 + gepanzerte Fahrzeuge ³⁾		13.0441-4018.2	250083		Dichtungssatz	ATE
	1.6 1.8 2.0 T.Spark	2050227 2050227		09.85 09.85 09.87	03.92 03.92 + gepanzerte Fahrzeuge ³⁾		13.0460-4019.2	604019		20911 15,0 +/WK	ATE
	1.6 1.8 1.8 Turbo 2.0 2.0 T.Spark 2.0 TD 2.4 TD 2.5 i V6 3.0 i V6			03.86 09.87 09.85 04.87	03.92 03.92 - gepanzerte Fahrzeuge ²⁾ 03.92 03.92		24.0122-0119.2	422119		269 22,0 20,0 V	
	1.6 1.8 1.8 Turbo 2.0 2.0 T.Spark 2.0 TD 2.4 TD 2.5 i V6 3.0 i V6			09.85 09.85 03.86 09.85 09.87 09.85 10.89 09.85 04.87	03.92 03.92 03.92 08.87 03.92 03.92 03.92 03.92 03.92		13.0441-3810.2	250066		Dichtungssatz	ATE
	1.6 1.8 1.8 Turbo 2.0 2.0 T.Spark 2.0 TD 2.4 TD 2.5 i V6 3.0 i V6	2050227 2050227 2050227		09.85 09.85 03.86 09.85 09.87	03.92 03.92 03.92 08.87		13.0460-3013.2	603013		20912 15,0 +/WK	ATE
	1.6 1.8 1.8 Turbo 2.0 T.Spark 2.0 TD 2.4 TD 2.5 i V6 3.0 i V6	2050228 2050228 2050228 2050228 2050228 2050228 2050228 2050228		03.92 03.92 03.92 03.92 03.92 03.92 03.92 03.92	03.92 03.92 03.92 03.92 03.92 03.92 03.92 03.92		13.0460-3014.2	603014		20387 15,0 +/WK	ATE
	1.6 1.8 1.8 Turbo 2.0 2.0 T.Spark 2.0 TD 2.4 TD			09.85 09.85 09.90 09.85 09.87 09.90 09.90	03.92 03.92 03.92 08.87 03.92 03.92 03.92		24.0110-0166.1	410166		250 9,9 8,0	

1) - residual press.center valve / - valvola p.pressione residua / - soup.de pression résiduelle / - válvula de fondo
 2) - armoured vehicles / - veicoli blindati / - véhicule blindé / - vehículo blindado
 3) + armoured vehicles / + veicoli blindati / + véhicule blindé / + vehículo blindado





ALFA ROMEO 75 (86-92)										
	2.5 i V6			09.90	03.92	24.0110-0166.1	410166			250 9,9 8,0
	3.0 i V6			09.90	03.92					
	1.8 Turbo			03.86	08.90	24.0110-0179.1	410179			250 9,9 8,0
	2.0 TD			09.85	08.90					
	2.4 TD			10.89	08.90					
	2.5 i V6			09.85	08.90					
	3.0 i V6			04.87	08.90					
	1.6			09.85	03.92	03.2419-8900.3	030024			Gz 19,05
	1.8			09.85	03.92					
	1.8 Turbo			03.86	03.92					
	2.0			09.85	08.87					
	2.0 T.Spark			09.87	03.92					
2.0 TD			09.85	03.92						
2.4 TD			10.89	03.92						
2.5 i V6			09.85	03.92						
3.0 i V6			04.87	03.92						

ALFA ROMEO 90 (84-87)											
	1.8			09.84	08.87	03.2122-0142.3	010128			THz 22,20	ATE
	2.0			09.84	08.87						
	2.4 TD			09.84	08.87						
	2.5 i V6			09.84	08.87						
	1.8			09.84	08.87	03.3558-0676.3	310077			Behälter + WE	
	2.0			09.84	08.87						
	2.4 TD			09.84	08.87						
	2.5 i V6			09.84	08.87						
	1.8			09.84	08.87	13.0441-4819.2	250104			Dichtungssatz	ATE
	2.0			09.84	08.87						
	2.4 TD			09.84	08.87						
	2.5 i V6			09.84	08.87	24.0122-0119.2	422119			269 22,0 20,0 V	
	1.8			09.84	08.87	13.0441-3810.2	250066			Dichtungssatz	ATE
	2.0			09.84	08.87						
	2.4 TD			09.84	08.87						
	2.5 i V6			09.84	08.87						
	1.8			09.84	08.87	13.0460-3013.2	603013			20912 15,0 +WK	ATE
	2.0			09.84	08.87						
	2.4 TD			09.84	08.87						
	2.5 i V6			09.84	08.87						
	1.8			09.84	08.87	24.0110-0166.1	410166			250 9,9 8,0	
	2.0			09.84	08.87						
	2.4 TD			09.84	08.87	24.0110-0179.1	410179			250 9,9 8,0	
	2.5 i V6			09.84	08.87						
	1.8			09.84	08.87	03.2419-8900.3	030024			Gz 19,05	
	2.0			09.84	08.87						
	2.4 TD			09.84	08.87						
	2.5 i V6			09.84	08.87						

ALFA ROMEO 155 (92-97)												
	1.7 T.S.			04.93	12.97	24.2122-1716.3	010485			THz 22,20		
	1.8 T.S.			05.92	12.97							
	1.9 TD			03.93	12.97							
	2.0 16V Turbo Q4			11.92	12.97							
	2.0 T.S.			05.92	12.97							
	2.5 TD			03.93	12.97							
	2.5 V6			05.92	12.97							
	1.7 T.S.			04.93	12.97	13.0460-2949.2	602949			20833 17,0 +WK/S	TRW	
	1.8 T.S.			05.92	12.97							
	1.9 TD			03.93	12.97							
	2.0 16V Turbo Q4			11.92	12.97	13.0460-2979.2	602979			21147 19,0 +WK/S	TRW	
	2.5 TD			03.93	10.97							
	2.5 V6			05.92	12.97							
	2.0 T.S.			05.92	12.97	13.0460-2987.2	602987			23168 19,0 +WK/S	TRW	
	1.7 T.S.			04.93	12.97	24.0120-0142.1	420142			258 20,0 18,2 V L +B		
	1.8 T.S.			05.92	12.97	24.0320-0142.1	520142			258 20,0 18,2 V L +B PD		
	1.9 TD			03.93	12.97	24.0112-0127.1	412127			258 12,0 10,2 +B		
	2.5 TD			04.93	12.97							
	2.0 T.S.			11.95	12.97	24.0122-0107.1	422107			284 22,0 20,2 V +B		
2.0 16V Turbo Q4			11.92	12.97	24.0122-0147.1	422147			284 22,0 20,2 V +B			
2.5 TD			03.93	12.97								
2.5 V6			05.92	12.97								
	1.7 T.S.			04.93	12.97	24.3344-1703.5	240117	<input type="checkbox"/> + GG-Sättel ¹⁾ <input type="checkbox"/> + GG-Sättel ¹⁾		D=34, - Halter	TRW	
	1.8 T.S.			05.92	12.97	24.3344-1704.5	240118			D=34, - Halter	TRW	
	1.9 TD			03.93	12.97	24.0101-3601.2	260044			Bremssattel-Zubehör	TRW	
	2.0 16V Turbo Q4			11.92	12.97							
	2.0 T.S.			05.92	12.97							
	2.5 TD			03.93	12.97							
2.5 V6			05.92	12.97								
	1.7 T.S.			04.93	12.97	13.0460-2951.2	602951	<input type="checkbox"/> + GG-Sättel ¹⁾ <input type="checkbox"/> + ALU-Sättel ²⁾ <input type="checkbox"/> + GG-Sättel ¹⁾		21103 14,2 /S	TRW	
	1.8 T.S.			05.92	12.97	13.0460-2826.2	602826			23177 14,2 /S	TRW	
	1.9 TD			03.93	12.97	13.0460-0072.2	610072			Belagsatz-Zubehör	TRW	
	2.0 16V Turbo Q4			11.92	12.97							
	2.0 T.S.			05.92	12.97							































1) + cast iron caliper / + pinza in ghisa / + étriers en fonte grise / + fundición gris-pinza
 2) + aluminium calipers / + pinze in alluminio / + étriers en aluminium / + pinzas de aluminio





ALFA ROMEO 155 (92-97)											
	2.5 TD 2.5 V6			03.93 05.92	12.97 12.97	13.0460-2951.2 13.0460-2826.2 13.0460-0072.2	602951 602826 610072		+ GG-Sättel ¹⁾ + ALU-Sättel ²⁾ + GG-Sättel ¹⁾	21103 14,2 /S 23177 14,2 /S Belagsatz-Zubehör	TRW TRW TRW
	1.7 T.S. 1.8 T.S. 1.9 TD 2.0 16V Turbo Q4 2.0 T.S. 2.5 TD 2.5 V6			04.93 05.92 03.93 11.92 05.92 03.93 05.92	12.97 12.97 12.97 12.97 12.97 12.97 12.97	24.0111-0149.1	411149			241 11,0 9,2	
	1.7 T.S. 1.8 T.S. 1.9 TD 2.0 16V Turbo Q4 2.0 T.S. 2.5 TD 2.5 V6			04.93 05.92 03.93 11.92 05.92 03.93 05.92	12.97 12.97 12.97 12.97 12.97 12.97 12.97	24.5112-0160.3 83.6401-0159.3	330612 330746	2 2		L=160 L=160	
	1.7 T.S. 1.8 T.S. 1.9 TD 2.0 T.S. 2.5 TD 2.5 V6			04.93 05.92 03.93 05.92 03.93 05.92	12.97 12.97 12.97 12.97 12.97 12.97	24.3727-0521.2 24.3727-0006.2	580521 580006	<input type="checkbox"/> <input type="checkbox"/>		L=1517 L=1460	
	1.7 T.S. 1.8 T.S. 1.9 TD 2.0 16V Turbo Q4 2.0 T.S. 2.5 TD	◀ ◀ ◀ ◀ ◀ ◀		04.93 05.92 03.93 11.92 05.92 03.93	12.97 12.97 12.97 12.97 12.97 12.97	24.2419-1721.3	030100			Gz 19,05	
	1.7 T.S. 1.8 T.S. 1.9 TD 2.0 16V Turbo Q4 2.0 T.S. 2.5 TD	◀ ◀ ◀ ◀ ◀ ◀		04.93 05.92 03.93 11.92 05.92 03.93	12.97 12.97 12.97 12.97 12.97 12.97	24.2525-1705.3	040083			Nz 25,40	
	1.7 T.S. 1.8 T.S. 1.9 TD 2.0 16V Turbo Q4 2.0 T.S. 2.5 TD	◀ ◀ ◀ ◀ ◀ ◀		04.93 05.92 03.93 11.92 05.92 03.93	12.97 12.97 12.97 12.97 12.97 12.97	24.2525-1706.3	040088			Nz 25,40	
ALFA ROMEO 164 (87-91)											
	2.0 T.Spark 2.0 Turbo 2.5 TD 3.0 i V6 3.0 i V6 Q.V.	6.142.574		08.91		13.0460-2809.2	602809			21182 19,4 +/WK/S	TRW
	2.0 Turbo 2.5 TD 3.0 i V6 3.0 i V6 Q.V.			09.87 09.87 09.87 07.90	08.91 08.91 08.91 08.91	13.0460-2980.2	602980			21147 19,0 +/WK/S	TRW
	2.0 T.Spark 2.0 Turbo 2.5 TD 3.0 i V6 3.0 i V6 Q.V.	6.142.574	6.142.573	09.87		24.0120-0129.1	420129			257 20,0 18,2 V	
	2.0 Turbo 2.5 TD 3.0 i V6 3.0 i V6 Q.V.			09.87 09.87 09.87 07.90	08.91 08.91 08.91 08.91	24.0122-0130.1	422130			257 22,0 20,2 V	
	2.0 Turbo 2.5 TD 3.0 i V6 3.0 i V6 Q.V.			09.87 09.87 09.87 07.90	08.91 08.91 08.91 08.91	24.0122-0145.1	422145			284 22,0 20,2 V +B	
	2.0 T.Spark 2.0 Turbo 2.5 TD 3.0 i V6 3.0 i V6 Q.V.	135 147		09.87 09.87 09.87 07.90	08.91 08.91 08.91 08.91	13.0460-2962.2	602962			20668 16,6 /S	TRW
	2.0 Turbo 2.5 TD 3.0 i V6 3.0 i V6 Q.V.			09.87 09.87 09.87 07.90	08.91 08.91 08.91 08.91	13.0460-0072.2	610072			Belagsatz-Zubehör	TRW
	2.0 T.Spark 2.0 Turbo 2.5 TD 3.0 i V6 3.0 i V6 Q.V.	135 147		09.87 09.87 09.87 07.90	08.91 08.91 08.91 08.91	24.0110-0190.1	410190			252 10,0 9,0 +B	
	2.0 Turbo 2.5 TD 3.0 i V6 3.0 i V6 Q.V.			09.87 09.87 09.87 07.90	08.91 08.91 08.91 08.91	24.0110-0209.1	410209			251 10,0 9,0 +B	
	2.0 T.Spark 2.0 Turbo 2.5 TD 3.0 i V6 3.0 i V6 Q.V.	135 147		09.87 09.87 09.87 07.90	08.91 08.91 08.91 08.91	24.3727-0514.2	580514	1		L=2950	
	2.0 T.Spark 2.0 Turbo 2.5 TD 3.0 i V6	135	6.219.010	09.87 09.87 09.87 09.87	08.91 08.91 08.91 08.91	24.2523-1702.3	040087			Nz 23,81	
	3.0 i V6 3.0 i V6 Q.V.	135 147	6.219.011	08.91 07.90	08.91 08.91	03.2525-2201.3	040026			Nz 25,40	
ALFA ROMEO 1300 GT Junior / 2000 GTV (66-79)											
	1300 GT Junior	◀		01.72	12.78 + Bremsgerät ³⁾	03.2120-4504.3	010123			THz 20,64	ATE
	1300 GT Junior	◀		01.72	12.78 + Bremsgerät ³⁾	03.3558-0676.3	310077			Behälter + WE	
	1300 GT Junior 2000 GTV			01.66 01.71	12.78 12.79	13.0441-4819.2	250104			Dichtungssatz	ATE
	1300 GT Junior			01.66	12.78	13.0441-4819.2	250104			Dichtungssatz	ATE
	1300 GT Junior			01.66	12.78	13.0460-4035.2 13.0460-0038.2	604035 610038			20173 15,0 Belagsatz-Zubehör	ATE ATE

1) + cast iron caliper / + pinza in ghisa / + étriers en fonte grise / + fundición gris-pinza
2) + aluminium calipers / + pinze in alluminio / + étriers en aluminium / + pinzas de aluminio
3) + booster unit / + servofreno / + servo-frein / + servofreno

								
ALFA ROMEO 1300 GT Junior / 2000 GTV (66-79)								
	1300 GT Junior 2000 GTV		01.66 01.71	12.78 12.79	24.5307-0320.3	330703	2	L=320
	1300 GT Junior 2000 GTV		01.66 01.71	12.78 12.79	13.0441-3001.2 13.0441-3803.2	250041 250060		Dichtungssatz Dichtungssatz
	1300 GT Junior		01.66	12.78	13.0460-3010.2	603010		20009 15,0
	1300 GT Junior		01.66	12.78	24.0109-0101.1	409101		267 9,4 7,5
	1300 GT Junior		01.66	12.78	03.6048-0601.3	320052		BR 18/5 (2)
	1300 GT Junior 2000 GTV		01.69 01.71	12.72 12.79	03.2417-0301.3	030004		Gz 17,46
	1300 GT Junior 2000 GTV		01.70 01.71	12.72 12.79	03.2525-1802.3 03.0450-2509.2	040025 082509		Nz 25,40 Nz Reparatursatz
ALFA ROMEO 1750 (68-72)								
	1750		01.70	12.72 + Bremsgerät ¹⁾	03.2120-4504.3	010123		THz 20,64
	1750		01.70	12.72 + Bremsgerät ¹⁾	03.3558-0676.3	310077		Behälter + WE
	1750		01.68	12.72	13.0441-4819.2	250104		Dichtungssatz
	1750		01.68	12.72	13.0460-6027.2	606027		20011 15,0
	1750		01.68	12.72	24.5307-0320.3	330703	2	L=320
	1750		01.68	12.72	13.0441-3803.2	250060		Dichtungssatz
	1750		01.68	12.72	24.0109-0101.1	409101		267 9,4 7,5
	1750		01.68	12.72	03.2417-0301.3	030004		Gz 17,46
	1750		01.70	12.72	03.2525-1802.3 03.0450-2509.2	040025 082509		Nz 25,40 Nz Reparatursatz
ALFA ROMEO ALFASUD (71-84)								
	1.2 1.3 1.5 TI		01.74 01.74 01.74	09.84 + Bremsgerät ¹⁾ 09.84 + Bremsgerät ¹⁾ 09.84 + Bremsgerät ¹⁾	03.2119-6207.3	010060		THz 19,05
	1.2 1.3 1.5 TI		04.71 04.71 04.71	09.84 09.84 09.84	13.0441-4212.2	250089		Dichtungssatz
	1.2 1.3 1.5 TI		04.71 04.71 04.71	09.84 09.84 09.84	83.7704-0281.3	330804	2	L=280
	1.2 1.3 1.5 TI		04.71 04.71 04.71	09.84 09.84 09.84	13.0441-3302.2	250042		Dichtungssatz
	1.2 1.3 1.5 TI		04.71 04.71 04.71	09.84 09.84 09.84	03.2419-8000.3	030017	- Bodenventil ²⁾	Gz 19,05
	1.2 1.3 1.5 TI		04.71 04.71 04.71	09.84 09.84 09.84	03.2525-2201.3	040026		Nz 25,40
ALFA ROMEO ALFETTA (72-84)								
	1.6 1.8 2.0 2.0 TD 2.4 TD		05.72 05.74 05.72 10.79 10.83	09.84 09.84 09.84 09.84 09.84	03.2122-0142.3	010128		THz 22,20
	1.6 1.8 2.0 2.0 TD 2.4 TD		05.72 05.74 05.72 10.79 10.83	09.84 09.84 09.84 09.84 09.84	03.3558-0676.3	310077		Behälter + WE

¹⁾ + booster unit / + servofreno / + servo-frein / + servofreno

²⁾ - residual press.center valve / - valvola p.pressione residua / - soup.de pression résiduelle / - válvula de fondo



ALFA ROMEO ALFETTA (72-84)

	1.6			05.72	09.84	13.0441-4819.2	250104			Dichtungssatz	ATE
	1.8			05.74	09.84						
	2.0			05.72	09.84	13.0441-4819.2	250104			Dichtungssatz	ATE
	2.0 TD			10.79	09.84						
	1.6			05.72	02.83	13.0460-4035.2	604035	1979-		20173 15,0	ATE
	1.8			05.74	02.83						
	2.0			05.72	02.83	13.0460-0029.2	610029			Belagsatz-Zubehör	ATE
	2.0 TD			10.79	02.83						
	1.6			03.83	09.84	13.0460-4019.2	604019			20911 15,0 +/WK	ATE
	1.8			03.83	09.84						
	2.0			03.83	09.84	13.0441-3810.2	250066			Dichtungssatz	ATE
	2.0 TD			10.79	09.84						
	2.4 TD			10.83	09.84	13.0460-3011.2	603011			20641 15,0 +	ATE
	1.6			05.72	02.83						
	1.8			05.74	02.83	13.0460-3013.2	603013			20912 15,0 +/WK	ATE
	2.0			05.72	02.83						
	2.0 TD			10.79	02.83	13.0460-3013.2	603013			20912 15,0 +/WK	ATE
	2.4 TD			10.83	09.84						
	1.6			11.81	09.84	24.0110-0166.1	410166			250 9,9 8,0	
	1.8			11.81	09.84						
	2.0			11.81	09.84	03.6048-0601.3	320052			BR 18/5 (2)	ATE
	2.0 TD			11.81	09.84						
	2.4 TD			10.83	09.84	03.2419-8601.3	030022			Gz 19,05 + Behälter	
	1.6			09.82	08.83						
	1.8			09.82	08.83	03.2419-8900.3	030024			Gz 19,05	
	2.0			09.82	08.83						
	2.0 TD			09.82	08.83	03.2419-8900.3	030024			Gz 19,05	
	2.4 TD			10.83	09.84						

ALFA ROMEO AR 6 (85-89)

	10			04.85	12.89	24.2122-0801.3	010373			Thz 22,20	
	10 Bus	51		04.85	12.89						
	13			04.85	12.89						
	14			03.86	12.89						
	14 Turbo			09.86	12.89						
	10			04.85	12.89	13.0460-2901.2	602901			20741 19,0 +/WK/S	TRW
	10 Bus	51		04.85	12.89						
	13			04.85	12.89						
	14			03.86	12.89						
	14 Turbo			09.86	12.89						
	10			04.85	12.89	24.0116-0105.1	416105			256 16,1 13,5 +B	
	10 Bus	51		04.85	12.89						
	13			04.85	12.89						
	14			03.86	12.89						
	14 Turbo			09.86	12.89						
	10			04.85	12.89	24.3225-1101.3	020294			Rz 25,40	TRW
	10 Bus	51		04.85	12.89						
	13			04.85	12.89						
	14			03.86	12.89						
	14 Turbo			09.86	12.89						
	10			04.85	12.89	03.0137-0330.2	650330			254 x 57 HEB	TRW
	10 Bus	51		04.85	12.89						
	13			04.85	12.89						
	14			03.86	12.89						
	14 Turbo			09.86	12.89						
	10			04.85	12.89	24.0225-4002.1	480048			254/255,6 x 64,4	
	10 Bus	51		04.85	12.89						
	13			04.85	12.89						
	14			03.86	12.89						
	14 Turbo			09.86	12.89						

ALFA ROMEO AR 8 (78-89)

	30			04.78	05.81	13.0460-0415.2	610415			Belagsatz-Zubehör	AP
	32			04.78	05.81						
	35			04.78	05.81						
	40			04.78	05.81						
	30			06.81	05.86	13.0460-0415.2	610415			Belagsatz-Zubehör	AP
	32			06.81	05.86						
	35			06.81	05.86						
	35 Turbo			04.85	05.86						



ALFA ROMEO AR 8 (78-89)											
	40 40 Turbo			06.81 04.85	05.86 05.86		13.0460-0415.2	610415		Belagsatz-Zubehör	AP
	30 32 35 35 Turbo 40 40 Turbo			06.86 06.86 06.86 06.86 06.86 06.86	12.88 12.88 12.88 12.88 12.88 12.88		13.0460-0415.2	610415		Belagsatz-Zubehör	AP
	30 32 35 35 Turbo 40 40 Turbo			01.89 01.89 01.89 01.89 01.89 01.89	12.89 12.89 12.89 12.89 12.89 12.89		13.0460-4955.2 13.0460-0415.2	604955 610415		21048 18,3 +WK Belagsatz-Zubehör	BRE AP
	30 32			04.78 04.78	12.89 12.89		03.0137-0309.2	650309		254 x 70	
	35 35 Turbo 40 40 Turbo			04.78 04.85 04.78 04.85	12.89 12.89 12.89 12.89		03.0137-0300.2	650300		254 x 89	













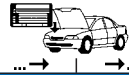

















ALFA ROMEO ARNA (83-87)											
	1.2 1.3 TI			09.83 09.83	12.86 12.86		11.0101-4802.2	260007		Hülsensatz	ATE
	1.2 1.3 TI			09.85 09.85	12.86 12.86		13.0460-7055.2	607055		21063 14,8 +WK	ATE
	1.2 1.3 TI			09.85 09.85	12.86 12.86		24.0113-0171.1	413171		239 12,6 9,0	
	1.2 1.3 TI	◀	◀	09.83 09.83	12.86 12.86		03.2419-8000.3	030017	- Bodenventil ¹⁾	Gz 19,05	
	1.2 1.3 TI			09.83 09.83	12.86 12.86		03.2525-2201.3	040026		Nz 25,40	

ALFA ROMEO GIULIA (62-79)											
	1300/1300 SUPER 1600 SUPER 2000			01.68 01.68 02.76	12.78 12.78 03.79		13.0441-3001.2	250041		Dichtungssatz	ATE
	1300/1300 SUPER 1600 SUPER 2000			01.68 01.68 02.76	12.78 12.78 03.79		13.0460-3010.2	603010		20009 15,0	ATE
	1300/1300 SUPER 1600 SUPER 2000			01.72 01.72 02.76	12.78 12.78 03.79		24.0109-0101.1	409101		267 9,4 7,5	

ALFA ROMEO GIULIETTA (77-85)											
	1.3 1.6 1.8 1.8 Turbo 2.0 2.0 Turbo			10.77 10.77 04.79 01.84 06.80 07.83	06.83 04.85 04.85 12.85 04.85 06.84		03.2122-0142.3	010128		Thz 22,20	ATE
	1.3 1.6 1.8 1.8 Turbo 2.0 2.0 Turbo			10.77 10.77 04.79 01.84 06.80 07.83	06.83 04.85 04.85 12.85 04.85 06.84		03.3558-0676.3	310077		Behälter + WE	
	1.3 1.6 1.8 1.8 Turbo 2.0 2.0 Turbo			10.77 10.77 04.79 01.84 06.80 07.83	06.83 04.85 04.85 12.85 04.85 06.84		13.0441-4819.2	250104		Dichtungssatz	ATE
	1.3 1.6 1.8 2.0			10.77 10.77 04.79 06.80	08.82 08.82 08.82 08.82		13.0460-4035.2 13.0460-0029.2	604035 610029		20173 15,0 Belagsatz-Zubehör	ATE ATE
	1.3 1.6 1.8 1.8 Turbo 2.0 2.0 Turbo			09.82 09.82 09.82 01.84 09.82 07.83	06.83 04.85 04.85 12.85 04.85 12.83		13.0460-4019.2	604019		20911 15,0 +WK	ATE
	2.0 Turbo			07.83	06.84		24.0122-0119.2	422119		269 22,0 20,0 V	
	1.3 1.6 1.8			10.77 10.77 04.79	06.83 04.85 04.85		13.0441-3810.2	250066		Dichtungssatz	ATE
↓	↓										

¹⁾ - residual press.center valve / - valvola p.pressione residua / - soup.de pression résiduelle / - válvula de fondo



								
ALFA ROMEO GIULIETTA (77-85)								
	1.8 Turbo 2.0 2.0 Turbo		01.84 06.80 07.83	12.85 04.85 06.84		13.0441-3810.2	250066	Dichtungssatz ATE
	1.3 1.6 1.8 2.0		10.77 10.77 04.79 06.80	04.83 04.83 04.83 04.83		13.0460-3011.2	603011	20641 15,0 + ATE
	1.3 1.6 1.8 1.8 Turbo 2.0 2.0 Turbo		05.83 05.83 05.83 01.84 05.83 07.83	06.83 04.85 04.85 12.85 04.85 06.84		13.0460-3013.2	603013	20912 15,0 +/WK ATE
	1.3 1.6 1.8 1.8 Turbo 2.0 2.0 Turbo		10.77 10.77 04.79 01.84 06.80 07.83	06.83 04.85 04.85 12.85 04.85 06.84		24.0110-0166.1	410166	250 9,9 8,0
	1.3 1.6 1.8 2.0		10.77 10.77 04.79 06.80	06.83 08.83 08.83 08.83		03.2419-8601.3	030022	Gz 19,05 + Behälter
	1.6 1.8 1.8 Turbo 2.0 2.0 Turbo		09.83 09.83 01.84 09.83 07.83	04.85 04.85 12.85 04.85 06.84		03.2419-8900.3	030024	Gz 19,05
ALFA ROMEO GTV (81-87)								
	2.0 2.5 i V6		11.80 11.80	01.86 02.87		03.2122-0142.3	010128	THz 22,20 ATE
	2.0 2.5 i V6		11.80 11.80	01.86 02.87		03.3558-0676.3	310077	Behälter + WE
	2.0		11.80	01.86		13.0441-4819.2	250104	Dichtungssatz ATE
	2.0		11.80	02.83		13.0460-4035.2 13.0460-0029.2	604035 610029	20173 15,0 ATE Belagsatz-Zubehör ATE
	2.5 i V6		11.80	02.87		24.0122-0119.2	422119	269 22,0 20,0 V
	2.0 2.5 i V6		11.80 11.80	01.86 02.87		13.0441-3810.2	250066	Dichtungssatz ATE
	2.0 2.5 i V6 2.5 i V6		11.80 11.80 03.86	01.86 02.86 02.87		13.0460-3011.2 13.0460-3013.2	603011 603013	20641 15,0 + ATE 20912 15,0 +/WK ATE
	2.0 2.5 i V6		11.80 11.80	01.86 02.87		24.0110-0166.1 24.0110-0179.1	410166 410179	250 9,9 8,0 250 9,9 8,0
	2.0		11.80	10.84		03.6048-0601.3	320052	BR 18/5 (2) ATE
	2.0 2.5 i V6 2.0 2.5 i V6		11.80 11.80 09.83 09.83	08.83 08.83 01.86 02.87		03.2419-8601.3 03.2419-8900.3	030022 030024	Gz 19,05 + Behälter Gz 19,05
ALFA ROMEO MONTREAL (70-74)								
	2.6 i V8 2.6 i V8		01.70 10.73	09.73 12.74		03.2120-4504.3 03.2122-0142.3	010123 010128	THz 20,64 ATE THz 22,20 ATE
	2.6 i V8		01.70	12.74		03.3558-0676.3	310077	Behälter + WE
	2.6 i V8		01.70	12.74		24.5307-0320.3	330703	2 L=320
ALFA ROMEO R.Z. SPEEDSTER (92-93)								
	3.0 i V6		10.92	12.93		03.3558-0676.3	310077	Behälter + WE
	3.0 i V6		10.92	12.93		13.0460-3013.2	603013	20912 15,0 +/WK ATE
	3.0 i V6		10.92	12.93		03.2419-8900.3	030024	Gz 19,05



































ALFA ROMEO SPIDER (68-93)

	1.3 Junior 1.6 1.6 Junior 2.0 2000 Veloce		01.68 12.83 01.68 09.79 01.77	12.77 08.93 11.83 12.93 05.86		03.2120-4504.3	010123		THz 20,64	ATE
	1.3 Junior 1.6 1.6 Junior 2.0 2000 Veloce		01.68 12.83 01.68 09.79 01.77	12.77 08.93 11.83 12.93 05.86		03.3558-0676.3	310077		Behälter + WE	
	1.3 Junior 1.6 Junior		01.68 01.68	12.77 11.83		13.0441-4819.2	250104		Dichtungssatz	ATE
	1.6 2.0 2000 Veloce		12.83 09.79 01.77	08.93 12.93 05.86		13.0441-4819.2	250104		Dichtungssatz	ATE
	1.3 Junior 1.6 Junior		01.68 01.68	12.77 11.83		13.0460-4035.2 13.0460-0038.2	604035 610038		20173 15,0 Belagsatz-Zubehör	ATE ATE
	1.6 2.0 2000 Veloce		12.83 09.79 01.77	08.93 12.93 05.86		13.0460-6027.2	606027		20011 15,0	ATE
	1.6 2.0 2000 Veloce		12.83 09.79 01.77	08.93 12.93 05.86		24.0113-0102.2	413102		272 12,7 10,7	
	1.3 Junior 1.6 1.6 Junior 2.0 2000 Veloce		01.68 12.83 01.68 09.79 01.77	12.77 08.93 11.83 12.93 05.86		24.5307-0320.3	330703	2	L=320	
	1.3 Junior 1.6 1.6 Junior 2.0 2000 Veloce		01.68 12.83 01.68 09.79 01.77	12.77 08.93 11.83 12.93 05.86		13.0441-3803.2	250060		Dichtungssatz	ATE
	1.3 Junior 1.6 1.6 Junior 2.0 2000 Veloce		01.68 12.83 01.68 09.79 01.77	12.77 08.93 11.83 12.93 05.86		13.0460-3011.2 13.0460-0014.2	603011 610014		20641 15,0 + Belagsatz-Zubehör	ATE ATE
	1.3 Junior 1.6 1.6 Junior 2.0 2000 Veloce		01.68 12.83 01.68 09.79 01.77	12.77 08.93 11.83 12.93 05.86		24.0109-0101.1	409101		267 9,4 7,5	
	1.3 Junior 1.6 1.6 Junior 2.0 2000 Veloce		01.68 12.83 01.68 09.79 01.77	12.77 08.93 11.83 12.93 05.86		03.0137-0149.2	650149		160 x 25	
	1.3 Junior 1.6 1.6 Junior 2.0 2000 Veloce		01.68 12.83 01.68 09.79 01.77	12.77 06.90 11.83 12.93 05.86		03.6048-0601.3	320052		BR 18/5 (2)	ATE
	1.3 Junior 1.6 1.6 Junior 2.0 2000 Veloce		01.68 12.83 01.68 09.79 01.77	12.77 08.93 11.83 12.93 05.86		03.2417-0301.3	030004		Gz 17,46	ATE
	1.3 Junior 1.6 1.6 Junior 2.0 2000 Veloce		01.68 12.83 01.68 09.79 01.77	12.77 08.93 11.83 12.93 05.86		03.2525-1802.3 03.0450-2509.2	040025 082509		Nz 25,40 Nz Reparatursatz	

ALFA ROMEO SPRINT (76-89)

	1.3 1.5		09.76 05.78	08.87 08.87		03.2119-6207.3	010060		THz 19,05	ATE
	1.3 1.5		09.76 05.78	11.83 11.83		13.0441-4212.2	250089		Dichtungssatz	ATE
	1.3 1.5		12.83 12.83	12.89 12.87		11.0101-4802.2	260007		Hülssensatz	ATE
	1.7 i.e.		10.87	12.89		11.0441-4810.2 11.0101-4802.2	250023 260007		Dichtungssatz Hülssensatz	ATE ATE
	1.3 1.5		09.85 09.85	12.89 12.87		13.0460-7055.2 13.0460-3905.2	607055 603905		21063 14,8 +/WK 21132 14,7 +/WK	ATE BDX
	1.7 i.e.		10.87	12.89		13.0460-2969.2	602969		21165 16,8 +/WK	TRW
	1.3 1.5		09.87 09.87	12.89 12.87		24.0113-0171.1	413171		239 12,6 9,0	
	1.7 i.e.		10.87	12.89		24.0122-0128.1	422128		239 22,0 20,2 V	



												
ALFA ROMEO SPRINT (76-89)												
	1.3 1.5			09.76 05.78	07.85 07.85		83.7704-0281.3	330804 2	L=280			
	1.3 1.5			09.76 05.78	08.87 08.87		13.0441-3302.2	250042	Dichtungssatz ATE			
	1.3 1.5 1.7 i.e.			09.76 05.78 10.87	12.89 12.87 12.89		03.2419-8000.3	030017	- Bodenventil ¹⁾ Gz 19,05			
	1.3 1.5 1.7 i.e.			09.76 05.78 10.87	12.89 12.87 12.89		03.2525-2201.3	040026	Nz 25,40			
ALFA ROMEO S.Z. COUPE (89-92)												
	3.0 i V6			03.89	12.91		03.3558-0676.3	310077	Behälter + WE			
	3.0 i V6			03.89	12.91		13.0460-3013.2	603013	20912 15,0 +/WK ATE			
	3.0 i V6			03.89	12.91		03.2419-8900.3	030024	Gz 19,05			
AUDI 50 (74-78)												
	0.8 1.1 1.3	◀ ◀ ◀		01.76 08.74 08.77	07.78 07.78 07.78	- Bremsgerät ²⁾ - Bremsgerät ²⁾ - Bremsgerät ²⁾	03.2117-3311.3 03.3526-2002.3	010040 340010	1 1	THz 17,46 Bremslichtschalter	ATE	
	0.8 1.1 1.3	◀ ◀ ◀		01.76 08.74 08.77	07.78 07.78 07.78	+ Bremsgerät ³⁾ + Bremsgerät ³⁾ + Bremsgerät ³⁾	03.2120-1531.3 03.3526-2002.3	010092 340010	1	THz 20,64 Bremslichtschalter	ATE	
	0.8 1.1 1.3	◀ ◀ ◀		01.76 08.74 08.77	07.78 07.78 07.78		03.3508-7504.3	310045		ohne Warneinrichtung	Behälter	ATE
	0.8 1.1 1.3			01.76 08.74 08.77	07.78 07.78 07.78		11.0441-4402.2	250014		Dichtungssatz	ATE	
	0.8 1.1 1.3			01.76 08.74 08.77	07.78 07.78 07.78		13.0460-4028.2	604028		20228 15,3	ATE	
	0.8 1.1 1.3			01.76 08.74 08.77	07.78 07.78 07.78		24.0108-0100.1	408100		239 8,0 7,0		
	0.8 1.1 1.3			01.76 08.74 08.77	07.78 07.78 07.78		24.5170-0296.3	331451	2	L=296		
	0.8 1.1 1.3			01.76 08.74 08.77	07.78 07.78 07.78		24.5204-0180.3	331461	2	L=180		
	0.8 1.1 1.3			01.76 08.74 08.77	07.78 07.78 07.78	- Bremskraftregler ⁴⁾ - Bremskraftregler ⁴⁾ - Bremskraftregler ⁴⁾	03.3214-0812.3 24.3214-0902.3	020011 020147		+ GG ⁵⁾ + ALU ⁶⁾	Rz 14,29 Rz 14,29	
	0.8 1.1 1.3			01.76 08.74 08.77	07.78 07.78 07.78		03.0137-9006.2	669006			Bremsbacken-Zubehör	
	0.8 1.1 1.3			01.76 08.74 08.77	07.78 07.78 07.78		24.0218-0007.1 24.0218-0707.2	480003 480211			180/181 x 38,5 - Lager 180/181 x 38,5 + Lager	
	0.8 1.1 1.3			01.76 08.74 08.77	07.78 07.78 07.78		24.3727-0103.2	580103	1	↓	L=1960	
	0.8 1.1 1.3	◀ ◀ ◀		01.76 08.74 08.77	07.78 07.78 07.78		24.3728-0101.2	590101			L=607	
AUDI 60/75/80/90 (65-73)												
	60 75 80 90			01.68 01.68 01.68 01.68	09.73 09.73 09.73 09.73	+ Schaltgetriebe ⁷⁾ + Schaltgetriebe ⁷⁾ + Schaltgetriebe ⁷⁾ + Schaltgetriebe ⁷⁾	13.0460-4033.2	604033			20034 15,0	ATE
	60 75 80			01.65 01.65 01.65	12.69 12.69 12.69		03.3215-0221.3	020013			Rz 15,87	
AUDI 80 (72-78)												
	1.3 1.5 1.6 Limousine 1.6 Limousine		55 63	01.72 05.72 09.75 09.75	08.78 08.75 08.78 08.78	+ Bremsgerät ³⁾ + Bremsgerät/ + Schaltgetriebe ⁸⁾ + Bremsgerät/ + Schaltgetriebe ⁸⁾ + Bremsgerät/ + Schaltgetriebe ⁸⁾	03.2120-1531.3 03.3526-2002.3 24.3526-1900.0	010092 340010 340038	1 2		THz 20,64 Bremslichtschalter Bremslichtschalter	ATE
	1.5 1.6 1.6 1.6 Avant		55 63 55	05.72 09.75 09.75 01.75	08.75 08.78 08.78 08.78	+ Automatikgetriebe ⁹⁾ + Automatikgetriebe ⁹⁾ + Automatikgetriebe ⁹⁾ + S ¹⁰⁾ ABS	03.3526-2002.3 24.3526-1900.0	340010 340038	1 2		Bremslichtschalter Bremslichtschalter	

¹⁾ - residual press.center valve / - valvola p.pressione residua / - soup.de pression résiduelle / - válvula de fondo

²⁾ - booster unit / - servofreno / - servo-frein / - servofreno

³⁾ + booster unit / + servofreno / + servo-frein / + servofreno

⁴⁾ - brake pressure regulator / - correttore di frenata / - correcteur de freinage / - corrector de frenado



















⁵⁾ + cast iron / + ghisa / + fonte grise / + fundición de gris

⁶⁾ + aluminium / + alluminio / + aluminium / + aluminio

⁷⁾ + manual transmission / + scatola cambio velocità / + transmission mécanique / + cambio de velocidad

⁸⁾ + booster unit/ + manual transim. / + servofreno/ + scatola camb.velocità / + servo-frein/ + transm.mécanique / + servofreno/ + camb.de velocidad

⁹⁾ + autom.transmission / + scatola cambio automatico / + transmission automatique / + cambio automático

								
AUDI 80 (72-78)								
	1.6 Avant	63		01.75 08.78 + (S) (ABS)	03.3526-2002.3 340010 24.3526-1900.0 340038	1 2		Bremslichtschalter Bremslichtschalter
	1.6	61		09.73 07.74	24.3526-1900.0 340038	2		Bremslichtschalter
	1.6	81		09.73 07.74				
	1.6	61		08.74 07.76	24.3526-1900.0 340038	2		Bremslichtschalter
	1.6	81		08.74 07.76				
	1.6	61		08.76 08.78	24.3526-1900.0 340038	2		Bremslichtschalter
	1.6	81		08.76 08.78				
	1.3			01.72 08.78	03.3508-7504.3 310045		ohne Warneinrichtung	Behälter ATE
	1.5			05.72 08.75				
	1.6	55		09.75 08.78 + Schaltgetriebe 1)				
	1.6	61		09.73 07.76				
	1.6	63		09.75 08.78 + Schaltgetriebe 1)				
	1.6	81		09.73 07.76				
	1.3			01.72 08.78	11.0441-4402.2 250014			Dichtungssatz ATE
	1.5			05.72 08.75 + Schaltgetriebe 1)				
	1.6	55		09.75 07.76 + Schaltgetriebe 1)				
	1.6	63		09.75 07.76 + Schaltgetriebe 1)				
	1.5			05.72 08.75 + Automatikgetriebe 2)	11.0441-4402.2 250014			Dichtungssatz ATE
	1.6	55		09.75 07.76 + Automatikgetriebe 2)				
	1.6	55		08.76 08.78				
	1.6	61		09.73 08.78				
	1.6	63		09.75 07.76 + Automatikgetriebe 2)				
	1.6	63		08.76 08.78				
	1.6	81		09.73 08.78	11.0441-4402.2 250014			Dichtungssatz ATE
	1.3			01.72 01.78	13.0460-4028.2 604028			20228 15,3 ATE
	1.5			05.72 08.75 + Schaltgetriebe 1)	13.0460-0029.2 610029			Belagsatz-Zubehör ATE
	1.6 Limousine	55		09.75 07.76 + Schaltgetriebe 1)				
	1.6 Limousine	63		09.75 07.76 + Schaltgetriebe 1)				
	1.3			02.78 08.78	13.0460-4028.2 604028			20228 15,3 ATE
	1.5			05.72 08.75 + Automatikgetriebe 2)	13.0460-0115.2 610115			Belagsatz-Zubehör ATE
	1.6	55		08.76 08.78 + Schaltgetriebe 1)				
	1.6	55		09.75 08.78 + Automatikgetriebe 2)				
	1.6	61		09.73 08.78				
	1.6	63		08.76 08.78 + Schaltgetriebe 1)				
	1.6	63		09.75 08.78 + Automatikgetriebe 2)				
	1.6 Avant	55		01.75 08.78 + (S) (ABS)				
	1.6 Avant	63		01.75 08.78 + (S) (ABS)				
	1.6	81		09.73 08.78	13.0460-4028.2 604028			20228 15,3 ATE
	1.3			01.72 07.76	24.0110-0151.1 410151			239 10,0 8,0 +S +B
	1.5			05.72 08.75 + Schaltgetriebe 1)	24.0310-0151.1 510151			239 10,0 8,0 +S +B PD
	1.6 Limousine	55		09.75 07.76 + Schaltgetriebe 1)				
	1.6 Limousine	63		09.75 07.76 + Schaltgetriebe 1)				
	1.3			08.76 08.78	24.0112-0106.1 412106			239 12,0 10,0 +S +B
	1.5			05.72 08.75 + Automatikgetriebe 2)	24.0312-0106.1 512106			239 12,0 10,0 +S +B PD
	1.6	55		09.75 07.76 + Automatikgetriebe 2)				
	1.6	55		08.76 08.78				
	1.6	61		09.73 08.78				
	1.6	63		09.75 07.76 + Automatikgetriebe 2)				
	1.6	63		08.76 08.78				
	1.6 Avant	55		01.75 08.78 + (S) (ABS)				
	1.6 Avant	63		01.75 08.78 + (S) (ABS)				
	1.6	81		09.73 08.78	24.0120-0123.1 420123 24.0320-0123.1 520123			239 20,0 18,0 V L +S +B 239 20,0 18,0 V L +S +B PD
	1.3			01.72 08.78	24.5170-0315.3 331309	2		L=315
	1.5			05.72 08.75				
	1.6			09.73 08.78				
	1.3			01.72 08.78	24.5204-0180.3 331461	2		L=180
	1.5			05.72 08.75				
	1.6			09.73 08.78				
	1.3			08.74 08.78	03.3214-0812.3 020011		+ GG 3)	Rz 14,29
	1.5	55		08.74 08.75 + Schaltgetriebe 1)	24.3214-0902.3 020147		+ ALU 4)	Rz 14,29
	1.6 Limousine	55		09.75 08.78 + Schaltgetriebe 1)				
	1.5	55		08.74 08.75 + Automatikgetriebe 2)	03.3217-2112.3 020027		+ GG 3)	Rz 17,46
	1.5	63		08.74 08.75 + Schaltgetriebe 1)	24.3217-0908.3 020167		+ ALU 4)	Rz 17,46
	1.6	55		09.75 08.78 + Automatikgetriebe 2)				
	1.6	61 84-52040210		08.78				
	1.6	63		09.75 08.78 + Schaltgetriebe 1)				
	1.6	81 84-52040210		08.78				
	1.6 Avant	55		01.75 08.78 + (S) (ABS)				
	1.6 Avant	63		01.75 08.78 + (S) (ABS)				
	1.3			09.74 08.78	03.0137-9006.2 669006		- autom. Nachstellung 5)	Bremsbacken-Zubehör
	1.5			09.74 08.75 + Schaltgetriebe 1)				
	1.6 Limousine	55		09.75 08.78 + Schaltgetriebe 1)				
	1.6 Limousine	63		09.75 08.78 + Schaltgetriebe 1)				
	1.3			01.72 08.78	24.0218-0007.1 480003			180/181 x 38,5 - Lager
	1.5	55		05.72 08.75 + Schaltgetriebe 1)	24.0218-0707.2 480211			180/181 x 38,5 + Lager
	1.6 Limousine	55		09.75 08.78 + Schaltgetriebe 1)				
	1.6 Limousine	63		09.75 08.78 + Schaltgetriebe 1)				
	1.5			05.72 08.75 + Automatikgetriebe 2)	24.0220-0018.1 480019		ohne Sensorring 6)	200/201 x 50 - Lager
	1.6	55		09.75 08.78 + Automatikgetriebe 2)	24.0220-0718.2 480209		ohne Sensorring 6)	200/201 x 50 + Lager
	1.6	61		09.73 08.78				
	1.6	63		09.75 08.78 + Automatikgetriebe 2)				

1) + manual transmission / + scatola cambio velocità / + transmission mécanique / + cambio de velocidad
2) + autom.transmission / + scatola cambio automatico / + transmission automatique / + cambio automático
3) + cast iron / + ghisa / + fonte grise / + fundición de gris
4) + aluminium / + alluminio / + aluminium / + aluminio
5) - automatic adjustment / - correzione automatica / - ajustage automatique / - reajuste automatico
6) without sensor ring / senza sensori / sans secours ABS / sin anillo sensor ABS





AUDI 80 (72-78)

	1.6 1.6 Avant 1.6 Avant	81 55 63		09.73 01.75 01.75	08.78 08.78 08.78	+ S + S	AUS AUS	24.0220-0018.1 24.0220-0718.2	480019 480209	ohne Sensorring ¹⁾ ohne Sensorring ¹⁾	200/201 x 50 - Lager 200/201 x 50 + Lager	
	1.3 1.5 1.6			10.73 10.73 09.73	08.78 08.75 08.78			03.6565-0101.3	320097		BRL 6/5 (4)	ATE

AUDI 80 (79-81)

	1.3 1.6 1.6 1.6 1.6 D	51 55 63		09.78 09.78 09.78 09.78 08.80	07.81 07.81 07.81 07.81 07.81			03.2120-1531.3 03.3526-2002.3	010092 340010	1		ThZ 20,64 Bremslichtschalter	ATE
	1.6 1.6 1.7 2.2	◀ 61 ◀ 81 ◀ ◀	81-B-055036 81-B-055036 81-B-055036 81-B-055036	09.78 09.78 08.80 10.80		+ Schaltgetriebe ²⁾ + Schaltgetriebe ²⁾ + Schaltgetriebe ²⁾ + Schaltgetriebe/ - S ³⁾		03.3526-2002.3	340010	2		Bremslichtschalter	
	1.6 1.6 1.6 D 1.7 2.2	◀ 61 ◀ 81 ◀ ◀ ◀	81-B-055037 81-B-055037 81-B-055037 81-B-055037	07.81 07.81 08.80 07.81 07.81		+ Schaltgetriebe ²⁾ + Schaltgetriebe ²⁾ + S / + Schaltgetriebe ⁴⁾ + Schaltgetriebe ²⁾ + Schaltgetriebe ²⁾		03.3526-2002.3	340010	2		Bremslichtschalter	
	1.6 1.6 1.6 D 1.7 2.2	▶ 61 ▶ 81 ▶ ▶ ▶		09.78 09.78 08.80 08.80 10.80	07.81 07.81 07.81 07.81 07.81	+ Schaltgetriebe ²⁾ + Schaltgetriebe ²⁾ + Schaltgetriebe ²⁾ + Schaltgetriebe ²⁾ + Schaltgetriebe ²⁾		24.3526-1900.0	340038	2		Bremslichtschalter	
	1.6 1.6 D 2.2			09.78 08.80 10.80	07.81 07.81 07.81	+ Automatikgetriebe ⁵⁾ + Automatikgetriebe ⁵⁾ + Automatikgetriebe ⁵⁾		03.3526-2002.3	340010	1		Bremslichtschalter	
	1.3 1.6		81-A0219025 81-A0219025	09.78 09.78				03.3508-7504.3	310045		ohne Warneinrichtung	Behälter	ATE
	1.3 1.6 1.6 1.6		81-92300000 81-92300000 81-92300000	09.78 09.78 09.78	07.81			11.0441-4402.2	250014			Dichtungssatz	ATE
	1.3 1.6 1.6 1.6	51 55 63	81-92300000 81-92300000 81-92300000	09.78 09.78 09.78	07.81			11.0441-4402.2	250014			Dichtungssatz	ATE
	1.3 1.6 1.6 1.6	51 55 63	81-92300000 81-92300000 81-92300000	09.78 09.78 09.78	07.81			13.0460-4028.2 13.0460-0115.2	604028 610115			20228 15,3 Belagsatz-Zubehör	ATE ATE
	1.3 1.6 1.6 1.6	51 55 63	81-92300000 81-92300000 81-92300000	09.78 09.78 09.78	07.81			13.0460-4029.2	604029			20228 18,5	ATE
	1.3 1.6 1.6 D 1.7 2.2			09.78 09.78 08.80 08.80 10.80	07.81 07.81 07.81 07.81 07.81			24.0110-0151.1 24.0310-0151.1	410151 510151			239 10,0 8,0 +S +B 239 10,0 8,0 +S +B PD	
	1.6 1.6 D 1.7 2.2			09.78 08.80 08.80 10.80	07.81 07.81 07.81 07.81			24.0112-0106.1 24.0312-0106.1	412106 512106			239 12,0 10,0 +S +B 239 12,0 10,0 +S +B PD	
	1.3 1.6 1.6 D 1.7 2.2			09.78 09.78 08.80 08.80 10.80	07.81 07.81 07.81 07.81 07.81			24.5170-0315.3	331309	2		L=315	
	1.3 1.6 1.6 D 1.7 2.2		81-A0190513 81-A0190513 81-A0190513 81-A0190513 81-A0190513	09.78 09.78 08.80 08.80 10.80				24.5201-0164.3	331414	2		L=164	
	1.3 1.6 1.6 D 1.7 2.2		81-A0190514 81-A0190514 81-A0190514 81-A0190514	07.81 07.81 07.81 07.81				83.6224-0200.3 24.5201-0164.3	330729 331414			L=200 L=164	
	1.3 1.6 1.6 D 1.7 2.2			09.78 09.78 08.80 08.80 10.80	07.81 07.81 07.81 07.81 07.81	- Bremskraftregler ⁶⁾ - Bremskraftregler ⁶⁾ - Bremskraftregler ⁶⁾ - Bremskraftregler ⁶⁾ - Bremskraftregler ⁶⁾		03.3214-0812.3 24.3214-0902.3	020011 020147		+ GG ⁷⁾ + ALU ⁸⁾	Rz 14,29 Rz 14,29	
	1.3 1.6 1.6 D 1.7 2.2		81-A0046050 81-A0046050 81-A0046050 81-A0046050	09.78 09.78 08.80 08.80		+ Bremskraftregler ⁹⁾ + Bremskraftregler ⁹⁾ + Bremskraftregler ⁹⁾ + Bremskraftregler ⁹⁾		03.3217-2112.3 24.3217-0908.3	020027 020167		+ GG ⁷⁾ + ALU ⁸⁾	Rz 17,46 Rz 17,46	
	1.3 1.6 1.6 D 1.7 2.2		81-A0046051 81-A0046051 81-A0046051 81-A0046051	07.81 07.81 07.81 07.81		+ Bremskraftregler ⁹⁾ + Bremskraftregler ⁹⁾ + Bremskraftregler ⁹⁾ + Bremskraftregler ⁹⁾		03.3215-2311.3 24.3215-0903.3	020018 020154		+ GG ⁷⁾ + ALU ⁸⁾	Rz 15,87 Rz 15,87	
	1.3 1.6 1.6 D 1.7 2.2			09.78 09.78 08.80 08.80 10.80	07.81 07.81 07.81 07.81 07.81	- verstärkte Bremse ¹⁰⁾ - verstärkte Bremse ¹⁰⁾ - verstärkte Bremse ¹⁰⁾ - verstärkte Bremse ¹⁰⁾ - verstärkte Bremse ¹⁰⁾		03.0137-0126.2 03.0137-9008.2	650126 669008			180 x 31 HEB Bremsbacken-Zubehör	

¹⁾ without sensor ring / senza sensori / sans secours ABS / sin anillo sensor ABS

²⁾ + manual transmission / + scatola cambio velocità / + transmission mécanique / + cambio de velocidad

³⁾ + manual transmission / - S / + scatola camb.velocità / - S / + transmission mécanique / - S / + cambio de velocidad / - S

⁴⁾ + S / + manual transm. / + S / + scatola cambio velocità / + S / + transmission mécanique / + S / + cambio de velocidad

⁵⁾ + autom.transmission / + scatola cambio automatico / + transmission automatique / + cambio automático

⁶⁾ - brake pressure regulator / - correttore di frenata / - correcteur de freinage / - corrector de frenado

⁷⁾ + cast iron / + ghisa / + fonte grise / + fundición de gris

⁸⁾ + aluminium / + alluminio / + aluminium / + aluminio

⁹⁾ + brake pressure regulator / + correctore di frenata / + correcteur de freinage / + corrector de frenado











¹⁰⁾ - heavy duty brake / - freno rinforzato / - frein renforcé / - freno reforzado



AUDI 80 (79-81)									
	1.3 1.6 1.6 D 1.7 2.2			09.78 09.78 08.80 08.80 10.80	07.81 07.81 07.81 07.81 07.81	+ verstärkte Bremse ¹⁾ + verstärkte Bremse ¹⁾ + verstärkte Bremse ¹⁾ + verstärkte Bremse ¹⁾ + verstärkte Bremse ¹⁾	03.0137-0146.2 03.0137-9041.2	650146 669041	200 x 40 HEB Bremsbacken-Zubehör
	1.3 1.6 1.6 D 1.7 2.2			09.78 09.78 08.80 08.80 10.80	07.81 07.81 07.81 07.81 07.81	- verstärkte Bremse ²⁾ - verstärkte Bremse ²⁾ - verstärkte Bremse ²⁾ - verstärkte Bremse ²⁾ - verstärkte Bremse ²⁾	24.0218-0007.1 24.0218-0707.2	480003 480211	180/181 x 38,5 - Lager 180/181 x 38,5 + Lager
	1.3 1.6 1.6 D 1.7 2.2			09.78 09.78 08.80 08.80 10.80	07.81 07.81 07.81 07.81 07.81	+ verstärkte Bremse ¹⁾ + verstärkte Bremse ¹⁾ + verstärkte Bremse ¹⁾ + verstärkte Bremse ¹⁾ + verstärkte Bremse ¹⁾	24.0220-0018.1 24.0220-0718.2	480019 480209	ohne Sensorring ³⁾ ohne Sensorring ³⁾
	1.3 1.6 1.6 D 1.7 2.2			09.78 09.78 08.80 08.80 10.80	07.81 07.81 07.81 07.81 07.81	- Regler/ - verstärkte Bremse ⁴⁾ - Regler/ - verstärkte Bremse ⁴⁾ - Regler/ - verstärkte Bremse ⁴⁾ - Regler/ - verstärkte Bremse ⁴⁾ - Regler/ - verstärkte Bremse ⁴⁾	03.0520-0114.3	690114	14,29/180x31 TopKit VW
	1.3 1.6 1.6 D 1.7 2.2		81-A0046050 81-A0046050 81-A0046050 81-A0046050 81-A0046050	09.78 09.78 08.80 08.80 10.80		+ Regler/ - verstärkte Bremse ⁵⁾ + Regler/ - verstärkte Bremse ⁵⁾ + Regler/ - verstärkte Bremse ⁵⁾ + Regler/ - verstärkte Bremse ⁵⁾ + Regler/ - verstärkte Bremse ⁵⁾	03.0420-0617.3 03.0520-3917.3	680617 693917	+ Rz GG ⁶⁾ + Rz ALU ⁷⁾
	1.3 1.6 1.6 D 1.7 2.2	81-A0046051 81-A0046051 81-A0046051 81-A0046051			07.81 07.81 07.81 07.81 07.81	+ Regler/ - verstärkte Bremse ⁵⁾ + Regler/ - verstärkte Bremse ⁵⁾ + Regler/ - verstärkte Bremse ⁵⁾ + Regler/ - verstärkte Bremse ⁵⁾ + Regler/ - verstärkte Bremse ⁵⁾	03.0520-0215.3	690215	15,87/180x31 TopKit VW
	1.3 1.6 1.6 D 1.7 2.2		81-A0046050 81-A0046050 81-A0046050 81-A0046050 81-A0046050	09.78 09.78 08.80 08.80 10.80		+ Regler/ + verstärkte Bremse ⁸⁾ + Regler/ + verstärkte Bremse ⁸⁾ + Regler/ + verstärkte Bremse ⁸⁾ + Regler/ + verstärkte Bremse ⁸⁾ + Regler/ + verstärkte Bremse ⁸⁾	03.0420-0417.3	680417	17,46/200x40 Kit VW
	1.3 1.6 1.6 D 1.7 2.2			09.78 09.78 08.80 08.80 10.80	07.81 07.81 07.81 07.81 07.81		24.3727-0136.2 24.3727-0139.2	580136 580139	<input type="checkbox"/> <input checked="" type="checkbox"/>
	1.3 1.6 1.6 D 1.7 2.2			09.78 09.78 08.80 08.80 10.80	07.81 07.81 07.81 07.81 07.81		03.6565-0101.3	320097	BRL 6/5 (4) ATE

AUDI 80 (82-84)									
	1.3 1.6 1.6 D 1.6 D 1.6 1.6 TD 1.7 1.9 2.2	55 63	81-C-250000 81-C-250000 81-C-250000 81-C-250000	08.81 08.81 08.81 08.81			03.2120-1531.3 03.3526-2002.3	010092 340010	Hub 16/14/+ Bremslichtschalt. ⁹⁾
	1.6 1.6 TD 1.7 1.9 2.2	81	81-C-250000 81-C-250000 81-C-250000 81-C-250000 81-C-250000	08.81 02.82 08.81 08.81 08.81			03.3526-2002.3	340010	2
	1.3 1.6 1.6 D 1.6 TD 1.7 1.8 1.9	55 63	81-C-250000 81-C-250000 81-C-250000 81-C-250000 81-C-250000 81-C-250000 81-C-250000	08.81 08.81 08.81 02.82 08.81 08.81 08.81	+ Bremskraftregler ¹⁰⁾ + Bremskraftregler ¹⁰⁾ + Bremskraftregler ¹⁰⁾ + Bremskraftregler ¹⁰⁾ + Bremskraftregler ¹⁰⁾ + Bremskraftregler ¹⁰⁾ + Bremskraftregler ¹⁰⁾		03.3526-2002.3	340010	1
	1.6 1.8 2.0 2.2	81 82 81-C-115000 81-C-115000	81-C-115000 81-C-115000 81-C-115000	07.84 07.84 07.84 08.83	+ verstärkte Bremse ¹⁾ + verstärkte Bremse ¹⁾ + verstärkte Bremse ¹⁾ + verstärkte Bremse ¹⁾		03.2122-9612.3	010159	Thz 22,20 ATE
	1.3 1.6 1.6 D 1.6 TD 1.7 1.8 1.9 2.0 2.2			08.81 08.81 08.81 02.82 08.81 08.81 08.83 08.81 08.83	07.84 07.84 07.84 07.84 07.83 07.84 07.83 07.84 08.83		24.0112-0106.1 24.0312-0106.1	412106 512106	239 12,0 10,0 +S +B 239 12,0 10,0 +S +B PD
	1.3 1.6 1.6 D 1.6 TD 1.7 1.8 1.9 2.0			08.81 08.81 08.81 02.82 08.81 08.81 08.81 08.83	07.84 07.84 07.84 07.84 07.83 07.84 07.83 07.84 08.83		24.5170-0315.3	331309	2

¹⁾ + heavy duty brake / + freno rinforzato / + frein renforcé / + freno reforzado
²⁾ - heavy duty brake / - freno rinforzato / - frein renforcé / - freno reforzado
³⁾ without sensor ring / senza sensori / sans securus ABS / sin anillo sensor ABS
⁴⁾ - regulator/ - heavy duty br. / - correctore fr. / - fr.rinforzato / - correcteur/ - frein renforcé / - regulador/ - freno reforzado
⁵⁾ + regulator/ + heavy duty brake / + correctore / - freno rinforzato / + correcteur/ - frein renforcé / + regulador/ - freno reforzado
⁶⁾ + WC cast iron / + CR ghisa / + CR fonte grise / + CR fundición de gris
⁷⁾ + WC aluminium / + CR alluminio / + CR aluminium / + CR aluminio
⁸⁾ + regulator/ + heavy duty brake / + correctore / + freno rinforzato / + correcteur/ + frein renforcé / + regulador/ + freno reforzado
⁹⁾ stroke 16/14/+ stoplight swit. / corsa 16/14/+inter.luce arres. / course 16/14/ + contact.stop / elevac.16/14/+ inter. luz d.fr.
¹⁰⁾ + brake pressure regulator / + correctore di frenata / + correcteur de freinage / + corrector de frenado

AUDI 80 (82-84)											
	2.2			08.81	08.83		24.5170-0315.3	331309	2		L=315
	1.3 1.6 1.6 D 1.6 TD 1.7 1.8 1.9 2.0 2.2			08.81 08.81 08.81 02.82 08.81 08.81 08.81 08.83 08.81	07.84 07.84 07.84 07.84 07.83 07.84 07.83 07.84 08.83		83.6224-0200.3 24.5204-0180.3	330729 331461	<input type="checkbox"/> <input type="checkbox"/>		L=200 L=180
	1.3 1.6 1.6 D 1.6 TD 1.7 1.8 1.9 2.0 2.2			08.81 08.81 08.81 02.82 08.81 08.81 08.81 08.83 08.81	07.84 07.84 07.84 07.84 07.83 07.84 07.83 07.84 08.83	- verstärkte Bremse ¹⁾ - verstärkte Bremse ¹⁾ - verstärkte Bremse ¹⁾ - verstärkte Bremse ¹⁾ - verstärkte Bremse ¹⁾ - verstärkte Bremse ¹⁾ - verstärkte Bremse ¹⁾ - verstärkte Bremse ¹⁾ - verstärkte Bremse ¹⁾	03.3214-0812.3 24.3214-0902.3	020011 020147	+ GG ²⁾ + ALU ³⁾		Rz 14,29 Rz 14,29
	1.3 1.6 1.6 D 1.6 TD 1.7 1.8 1.9 2.0 2.2			08.81 08.81 08.81 02.82 08.81 08.81 08.81 08.83 08.81	07.84 07.84 07.84 07.84 07.83 07.84 07.83 07.84 08.83	+ verstärkte Bremse ⁴⁾ + verstärkte Bremse ⁴⁾ + verstärkte Bremse ⁴⁾ + verstärkte Bremse ⁴⁾ + verstärkte Bremse ⁴⁾ + verstärkte Bremse ⁴⁾ + verstärkte Bremse ⁴⁾ + verstärkte Bremse ⁴⁾ + verstärkte Bremse ⁴⁾	03.3215-2311.3 24.3215-0903.3	020018 020154	+ GG ²⁾ + ALU ³⁾		Rz 15,87 Rz 15,87
	1.3 1.6 1.6 D 1.6 TD 1.7 1.8 1.9 2.0 2.2			08.81 08.81 08.81 02.82 08.81 08.81 08.81 08.83 08.81	07.84 07.84 07.84 07.84 07.83 07.84 07.83 07.84 08.83	- verstärkte Bremse ¹⁾ - verstärkte Bremse ¹⁾ - verstärkte Bremse ¹⁾ - verstärkte Bremse ¹⁾ - verstärkte Bremse ¹⁾ - verstärkte Bremse ¹⁾ - verstärkte Bremse ¹⁾ - verstärkte Bremse ¹⁾ - verstärkte Bremse ¹⁾	03.0137-0126.2 03.0137-9008.2	650126 669008			180 x 31 HEB Bremsbacken-Zubehör
	1.3 1.6 1.6 D 1.6 TD 1.7 1.8 1.9 2.0 2.2			08.81 08.81 08.81 02.82 08.81 08.81 08.81 08.83 08.81	07.84 07.84 07.84 07.84 07.83 07.84 07.83 07.84 08.83	+ verstärkte Bremse ⁴⁾ + verstärkte Bremse ⁴⁾ + verstärkte Bremse ⁴⁾ + verstärkte Bremse ⁴⁾ + verstärkte Bremse ⁴⁾ + verstärkte Bremse ⁴⁾ + verstärkte Bremse ⁴⁾ + verstärkte Bremse ⁴⁾ + verstärkte Bremse ⁴⁾	03.0137-0146.2 03.0137-9041.2	650146 669041			200 x 40 HEB Bremsbacken-Zubehör
	1.3 1.6 1.6 D 1.6 TD 1.7 1.8 1.9 2.0 2.2			08.81 08.81 08.81 02.82 08.81 08.81 08.81 08.83 08.81	07.84 07.84 07.84 07.84 07.83 07.84 07.83 07.84 08.83	- verstärkte Bremse ¹⁾ - verstärkte Bremse ¹⁾ - verstärkte Bremse ¹⁾ - verstärkte Bremse ¹⁾ - verstärkte Bremse ¹⁾ - verstärkte Bremse ¹⁾ - verstärkte Bremse ¹⁾ - verstärkte Bremse ¹⁾ - verstärkte Bremse ¹⁾	24.0218-0007.1 24.0218-0707.2	480003 480211			180/181 x 38,5 - Lager 180/181 x 38,5 + Lager
	1.3 1.6 1.6 D 1.6 TD 1.7 1.8 1.9 2.0 2.2			08.81 08.81 08.81 02.82 08.81 08.81 08.81 08.83 08.81	07.84 07.84 07.84 07.84 07.83 07.84 07.83 07.84 08.83	+ verstärkte Bremse ⁴⁾ + verstärkte Bremse ⁴⁾ + verstärkte Bremse ⁴⁾ + verstärkte Bremse ⁴⁾ + verstärkte Bremse ⁴⁾ + verstärkte Bremse ⁴⁾ + verstärkte Bremse ⁴⁾ + verstärkte Bremse ⁴⁾ + verstärkte Bremse ⁴⁾	24.0220-0018.1 24.0220-0718.2	480019 480209	ohne Sensorring ⁵⁾ ohne Sensorring ⁵⁾		200/201 x 50 - Lager 200/201 x 50 + Lager
	1.3 1.6 1.6 D 1.6 TD 1.7 1.8 1.9 2.0 2.2			08.81 08.81 08.81 02.82 08.81 08.81 08.81 08.83 08.81	07.84 07.84 07.84 07.84 07.83 07.84 07.83 07.84 08.83	- verstärkte Bremse ¹⁾ - verstärkte Bremse ¹⁾ - verstärkte Bremse ¹⁾ - verstärkte Bremse ¹⁾ - verstärkte Bremse ¹⁾ - verstärkte Bremse ¹⁾ - verstärkte Bremse ¹⁾ - verstärkte Bremse ¹⁾ - verstärkte Bremse ¹⁾	03.0520-0114.3	690114			14,29/180x31 TopKit VW
	1.3 1.6 1.6 D 1.6 TD 1.7 1.8 1.9 2.0 2.2			08.81 08.81 08.81 02.82 08.81 08.81 08.81 08.83 08.81	07.84 07.84 07.84 07.84 07.83 07.84 07.83 07.84 08.83	- verstärktes Fahrwerk ⁶⁾ - verstärktes Fahrwerk ⁶⁾ - verstärktes Fahrwerk ⁶⁾ - verstärktes Fahrwerk ⁶⁾ - verstärktes Fahrwerk ⁶⁾ - verstärktes Fahrwerk ⁶⁾ - verstärktes Fahrwerk ⁶⁾ - verstärktes Fahrwerk ⁶⁾ - verstärktes Fahrwerk ⁶⁾	24.3727-0136.2 24.3727-0139.2	580136 580139	<input type="checkbox"/> <input type="checkbox"/>		L=1195 L=1150
	1.3 1.6			08.81 08.81	07.84 07.84	+ verstärktes Fahrwerk ⁷⁾ + verstärktes Fahrwerk ⁷⁾	24.3727-0136.2 24.3727-0139.2	580136 580139	<input type="checkbox"/> <input type="checkbox"/>		L=1195 L=1150

1) - heavy duty brake / - freno rinforzato / - frein renforcé / - freno reforzado
2) + cast iron / + ghisa / + fonte grise / + fundición de gris
3) + aluminium / + alluminio / + aluminium / + aluminio
4) + heavy duty brake / + freno rinforzato / + frein renforcé / + freno reforzado
5) without sensor ring / senza sensori / sans secours ABS / sin anillo sensor ABS
6) - reinforced suspension / - sospensione rinforzata / - châssis renforcé / - suspensión reforzada
7) + reinforced suspension / + sospensione rinforzata / + châssis renforcé / + suspensión reforzada

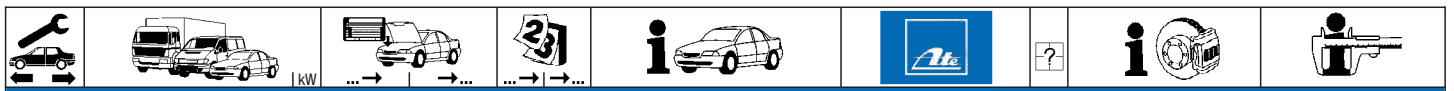

AUDI 80 (82-84)											
	1.6 D			08.81	07.84	+ verstärktes Fahrwerk ¹⁾	24.3727-0136.2	580136	<input type="checkbox"/>	L=1195 L=1150	
	1.6 TD			02.82	07.84	+ verstärktes Fahrwerk ¹⁾	24.3727-0139.2	580139	<input type="checkbox"/>		
	1.7			08.81	07.83	+ verstärktes Fahrwerk ¹⁾					
	1.8			08.81	07.84	+ verstärktes Fahrwerk ¹⁾					
	1.9			08.81	07.83	+ verstärktes Fahrwerk ¹⁾					
	2.0			08.83	07.84	+ verstärktes Fahrwerk ¹⁾					
2.2			08.81	08.83	+ verstärktes Fahrwerk ¹⁾						
	1.3			08.81	07.84		03.6565-0101.3	320097		BRL 6/5 (4)	ATE
	1.6			08.81	07.84						
	1.6 D			08.81	07.84						
	1.6 TD			02.82	07.84						
	1.7			08.81	07.83						
	1.8			08.81	07.84						
	1.9			08.81	07.83						
	2.0			08.83	07.84						
	2.2			08.81	08.83						

AUDI 80 (84-87)											
	1.3		◀	06.84	03.87		03.7750-0302.4	300071		9"	ATE
	1.6		◀	06.84	03.87						
	1.6 D		◀	06.84	03.87						
	1.6 TD		◀	06.84	03.87						
	1.8		◀	06.84	03.87						
	2.0		◀	02.86	03.87						
	1.3			06.84	03.87		03.2120-2331.3	010110	Kompakt-THz ²⁾	THz 20,64	ATE
	1.6			06.84	03.87						
	1.6 D			06.84	03.87						
	1.6 TD			06.84	03.87						
	1.8			06.84	03.87						
	2.0			02.86	03.87						
	1.8			06.84	03.87		13.0460-2936.2	602936		20574 15,3 /S	TRW
	2.0			02.86	03.87						
	1.3			06.84	03.87		24.0112-0106.1	412106		239 12,0 10,0 +S +B 239 12,0 10,0 +S +B PD	
	1.6			06.84	03.87		24.0312-0106.1	512106			
	1.6 D			06.84	03.87						
	1.6 TD			06.84	03.87						
	1.8			06.84	03.87		24.0120-0123.1	420123		239 20,0 18,0 V L +S +B 239 20,0 18,0 V L +S +B PD	
	2.0			02.86	03.87		24.0320-0123.1	520123			
	1.3			06.84	03.87		24.5170-0315.3	331309	2		L=315
	1.6			06.84	03.87						
	1.6 D			06.84	03.87						
	1.6 TD			06.84	03.87						
	1.8			06.84	03.87						
	2.0			02.86	03.87						
	1.3			06.84	03.87		83.6224-0200.3	330729	<input type="checkbox"/>	L=200 L=150	
	1.6			06.84	03.87		83.7804-0150.3	330853	<input type="checkbox"/>		
	1.6 D			06.84	03.87						
	1.6 TD			06.84	03.87						
	1.8			06.84	03.87						
	2.0			02.86	03.87						
	1.3			06.84	03.87		03.3214-0812.3	020011	+ GG ³⁾	Rz 14,29	
	1.6			06.84	03.87		24.3214-0902.3	020147	+ ALU ⁴⁾	Rz 14,29	
	1.6 D			06.84	03.87		03.3215-2311.3	020018	+ GG ³⁾	Rz 15,87	
	1.6 TD			06.84	03.87		24.3215-0903.3	020154	+ ALU ⁴⁾	Rz 15,87	
	1.8			06.84	03.87						
	2.0			02.86	03.87						
	1.3			06.84	03.87		03.0137-0126.2	650126		180 x 31 HEB	Bremsbacken-Zubehör
	1.6			06.84	03.87		03.0137-9008.2	669008			
	1.6 D			06.84	03.87		03.0137-0146.2	650146		200 x 40 HEB	
	1.6 TD			06.84	03.87		03.0137-9041.2	669041		Bremsbacken-Zubehör	
	1.8			06.84	03.87						
2.0			02.86	03.87							
	1.3			06.84	03.87		24.0218-0007.1	480003		180/181 x 38,5 - Lager	
	1.6			06.84	03.87		24.0218-0707.2	480211		180/181 x 38,5 + Lager	
	1.6 D			06.84	03.87		24.0220-0018.1	480019	ohne Sensorring ⁵⁾	200/201 x 50 - Lager	
	1.6 TD			06.84	03.87		24.0220-0718.2	480209	ohne Sensorring ⁵⁾	200/201 x 50 + Lager	
	1.8			06.84	03.87						
	2.0			02.86	03.87		24.0220-0016.1	480018		200/201 x 51,5	
	1.3			06.84	03.87		03.0520-0114.3	690114		14,29/180x31 TopKit	VW
	1.3			06.84	03.87		24.3727-0136.2	580136	<input type="checkbox"/>	L=1195 L=1150	
	1.6			06.84	03.87		24.3727-0139.2	580139	<input type="checkbox"/>		
	1.6 D			06.84	03.87						
	1.6 TD			06.84	03.87						
	1.8			06.84	03.87						
	2.0			02.86	03.87						

¹⁾ + reinforced suspension / + sospensione rinforzata / + châssis renforcé / + suspensión reforzada
²⁾ compact TMC / PFT compatta / MCT compact / CMT compacto
³⁾ + cast iron / + ghisa / + fonte grise / + fundición de gris
⁴⁾ + aluminium / + alluminio / + aluminium / + aluminio
⁵⁾ without sensor ring / senza sensori / sans secours ABS / sin anillo sensor ABS





AUDI 80 (84-87)											
	1.3 1.6 1.6 D 1.6 TD 1.8 2.0			06.84 06.84 06.84 06.84 06.84 02.86	03.87 03.87 03.87 03.87 03.87 03.87	- verstärkte Bremse ¹⁾ - verstärkte Bremse ¹⁾ - verstärkte Bremse ¹⁾ - verstärkte Bremse ¹⁾ - verstärkte Bremse ¹⁾ - verstärkte Bremse ¹⁾	03.6565-0101.3	320097		BRL 6/5 (4)	ATE
	1.3 1.6 1.6 D 1.6 TD 1.8 2.0			06.84 06.84 06.84 06.84 06.84 02.86	03.87 03.87 03.87 03.87 03.87 03.87	+ verstärkte Bremse ²⁾ + verstärkte Bremse ²⁾ + verstärkte Bremse ²⁾ + verstärkte Bremse ²⁾ + verstärkte Bremse ²⁾ + verstärkte Bremse ²⁾	03.6585-0108.3	320115		BRL 8/5 (4)	ATE
	2.0			02.86	03.87		03.2419-8150.3	030019		Gz 19,05	
	2.0			02.86	03.87		03.2522-4211.3	040017		Nz 22,20	

AUDI 80 (87-91)											
	1.6 1.6 D 1.6 TD 1.8 1.9 D 1.9 E 2.0	◀ ◀ ◀ ◀ ◀ ◀ ◀		09.86 02.87 04.88 09.86 08.89 09.86 08.88	07.91 07.89 07.91 07.91 07.91 07.88 07.91		03.7750-0302.4	300071		9"	ATE
	1.6 1.6 D 1.6 TD 1.8 1.9 D 1.9 E 2.0			09.86 02.87 04.88 09.86 08.89 09.86 08.88	07.91 07.89 07.91 07.91 07.91 07.88 07.91		03.2122-9612.3	010159	- ABS	THz 22,20	ATE
	1.6 1.6 1.6 D 1.6 TD 1.6 TD 1.8 1.8 1.8 1.9 D			09.86 08.89 02.87 04.88 08.89 09.86 09.86 08.89	07.89 07.91 + Schaltgetriebe ³⁾ 07.89 07.89 07.89 07.91 07.91 + Schaltgetriebe ⁴⁾ 07.91 + Schaltgetriebe ³⁾ 07.91 + Schaltgetriebe ³⁾		24.3541-1610.5 24.3541-1609.5 11.0441-5405.2 11.0101-5409.2 11.8171-0008.1 24.0101-4301.2 11.0101-5403.2	240040 240039 250030 260035 990049 260047 260010	☐ ☐	D=54, - Halter D=54, - Halter Dichtungssatz Hülzensatz Führungsbolzen Bremsattel-Zubehör Faltenbalgsatz	TRW TRW ATE ATE ATE TRW TRW
	1.6 1.6 TD 1.6 TD 1.8 1.8 1.8 1.9 E 2.0		55 66 82	08.89 04.88 08.89 09.86 09.86 09.86 08.88	07.91 07.91 + Taxi 07.91 + Automatikgetriebe ⁵⁾ 07.91 + Automatikgetriebe ⁵⁾ 07.91 + Automatikgetriebe ⁵⁾ 07.88 07.91		11.3541-8521.2 24.3541-1720.5 24.3541-1719.5 11.0441-5405.2 11.0101-5409.2 11.8171-0008.1 24.0101-4301.2 11.0101-5403.2	220113 240058 240057 250030 260035 990049 260047 260010	☐ ☐ ☐ ☐	D=54, - Halter D=54, - Halter D=54, - Halter Dichtungssatz Hülzensatz Führungsbolzen Bremsattel-Zubehör Faltenbalgsatz	ATE TRW TRW ATE ATE ATE TRW TRW
	1.6 1.6 D 1.6 TD 1.8 1.9 D 1.9 E 2.0			09.86 02.87 04.88 09.86 08.89 09.86 08.88	07.91 07.89 07.91 07.91 07.91 07.88 07.91		13.0460-2934.2	602934		20669 19,0 /S	TRW
	1.6 1.6 1.6 D 1.6 TD 1.6 TD 1.8 1.8 1.9 D			09.86 08.89 02.87 04.88 08.89 09.86 09.86 08.89	07.89 07.91 + Schaltgetriebe ³⁾ 07.89 07.89 07.89 07.91 07.91 + Schaltgetriebe ⁴⁾ 07.91 + Schaltgetriebe ³⁾ 07.91 + Schaltgetriebe ³⁾		24.0113-0160.1	413160		256 13,0 11,0 +B	
	1.6 1.6 TD 1.6 TD 1.8 1.8 1.8 1.9 E 2.0		55 66 82	08.89 04.88 08.89 09.86 09.86 09.86 08.88	07.91 07.91 + Automatikgetriebe ⁵⁾ 07.91 + Taxi 07.91 + Automatikgetriebe ⁵⁾ 07.91 + Automatikgetriebe ⁵⁾ 07.91 + Automatikgetriebe ⁵⁾ 07.88 07.91		24.0122-0118.1	422118		256 22,0 20,0 V +B	
	1.6 1.6 D 1.6 TD 1.8 1.9 D 1.9 E 2.0			8A-L-038656 8A-L-038656 8A-L-038656 8A-L-038656 8A-L-038656 8A-L-038656	09.86 02.87 07.89 04.88 09.86 08.89 09.86 08.88		24.5170-0315.3	331309	2	L=315	
	1.6 1.6 TD 1.8 1.9 D 2.0		8A-L-038657 8A-L-038657 8A-L-038657 8A-L-038657 8A-L-038657		07.91 07.91 07.91 07.91 07.91		24.5237-0288.3 24.5170-0161.3	331442 331308	2 2	am Bremsattel ⁶⁾	L=288 L=161

¹⁾ - heavy duty brake / - freno reforzato / - frein renforcé / - freno reforzado
²⁾ + heavy duty brake / + freno reforzato / + frein renforcé / + freno reforzado
³⁾ + manual transmission / + scatola cambio velocità / + transmission mécanique / + cambio de velocidad
⁴⁾ - Taxi/ + manual transm. / - Taxi/ + scatola cambio velocità / - Taxi/ + transmission mécanique / - Taxi/ + cambio de velocidad
⁵⁾ + autom.transmission / + scatola cambio automatico / + transmission automatique / + cambio automático
⁶⁾ on the brake caliper / sulla pinza freno / sur l'étrier de frein / a la pinza de freno



AUDI 80 (87-91)

	1.6		89-J-225956	09.86	+ ABS	24.0101-3601.2	260044			Bremsattel-Zubehör	TRW							
	1.6 D		89-J-225956	02.87	+ ABS													
	1.6 TD		89-J-225956	04.88	+ ABS													
	1.8	55	89-J-225956	09.86	+ ABS													
	1.8	66	89-J-225956	09.86	+ ABS													
	1.8	82	89-J-225956	09.86	+ ABS													
	1.9 E		89-J-225956	09.86	+ ABS													
	1.6		89-J-221810	07.91	+ ABS													
	1.6 D		89-J-221810	07.89	+ ABS													
	1.6 TD		89-J-221810	07.91	+ ABS													
1.8	55	89-J-221810	07.91	+ ABS														
1.8	66	89-J-221810	07.91	+ ABS														
1.8	82	89-J-221810	07.91	+ ABS														
1.9 D			08.89	+ ABS														
1.9 E		89-J-221810	07.88															
2.0			08.88	07.91														
	1.6			09.86	+ ABS	13.0460-3602.2	603602			21144 15,8 /S	TRW							
	1.6 D			02.87	+ ABS													
	1.6 TD			04.88	+ ABS													
	1.8	55		09.86	+ ABS													
	1.8	66		09.86	+ ABS													
	1.8	82		09.86	+ ABS													
	1.9 D			08.89	+ ABS													
	1.9 E			09.86	07.88													
	2.0			08.88	07.91													
		1.6			09.86							+ ABS	24.0110-0178.1	410178			245 10,0 8,0 +B	
1.6 D				02.87	+ ABS													
1.6 TD				04.88	+ ABS													
1.8		55		09.86	+ ABS													
1.8		66		09.86	+ ABS													
1.8		82		09.86	+ ABS													
1.9 D				08.89	+ ABS													
1.9 E				09.86	07.88													
2.0				08.88	07.91													
		1.6			09.86	+ ABS	83.6224-0200.3	330729			L=200 L=150 L=161							
	1.6 D			02.87	+ ABS													
	1.6 TD			04.88	+ ABS													
	1.8	55		09.86	+ ABS													
	1.8	66		09.86	+ ABS													
	1.8	82		09.86	+ ABS													
	1.9 D			08.89	+ ABS													
	1.9 E			09.86	07.88													
	2.0			08.88	07.91													
		1.6			09.86	+ ABS							83.7804-0150.3	330853	2	am Bremsattel ¹⁾		
1.6 D				02.87	+ ABS													
1.6 TD				04.88	+ ABS													
1.8		55		09.86	+ ABS													
1.8		66		09.86	+ ABS													
1.8		82		09.86	+ ABS													
1.9 D				08.89	+ ABS													
1.9 E				09.86	07.88													
2.0				08.88	07.91													
		1.6	51		09.86	+ ABS/ - Bremskraftregler ²⁾	03.3215-2311.3	020018			Rz 15,87							
	1.6	55		09.86	- ABS													
	1.6 D			02.87	- ABS													
	1.8	55		09.86	- ABS/ + Schaltgetriebe ⁵⁾													
	1.6	51		09.86	- ABS/ + Bremskraftregler ⁶⁾	24.3219-0909.3							020188			Rz 19,05		
	1.6 TD			04.88	- ABS													
	1.8	55		09.86	- ABS/ + Automatikgetriebe ⁷⁾													
	1.8	66		09.86	- ABS													
	1.8 S	65		09.86	- ABS													
	1.9 D			08.89	- ABS													
	1.6		89-K-200000	09.86	- ABS		03.0137-0146.2	650146			200 x 40 HEB	Bremsbacken-Zubehör						
	1.6 D		89-K-200000	02.87	- ABS													
	1.6 TD		89-K-200000	04.88	- ABS													
	1.8	55	89-K-200000	09.86	- ABS													
	1.8	66	89-K-200000	09.86	- ABS													
	1.8		89-K-200000	09.86	- ABS													
	1.9 D		89-K-200000	09.86	- ABS													
	1.6		89-K-200001	08-M-080000	07.89	- ABS							03.0137-0268.2	650268		200 x 40 HEB	Bremsbacken-Zubehör	VW
	1.6 D		89-K-200001	08-M-080000	07.89	- ABS												
	1.6 TD		89-K-200001	08-M-080000	07.89	- ABS												
1.8	55	89-K-200001	08-M-080000	07.89	- ABS													
1.8	66	89-K-200001	08-M-080000	07.89	- ABS													
1.9 D		89-K-200001	08-M-080000	08.89	- ABS													
1.6		8A-M-080001	08-M-080000	07.91	- ABS	03.0137-0146.2	650146		200 x 40 HEB	Bremsbacken-Zubehör								
1.6 TD		8A-M-080001	08-M-080000	07.91	- ABS													
1.8	55	8A-M-080001	08-M-080000	07.91	- ABS													
1.8	66	8A-M-080001	08-M-080000	07.91	- ABS													
1.9 D		8A-M-080001	08-M-080000	07.91	- ABS													
	1.6		89-K-120000	09.86	- ABS							24.0220-0016.1	480018			200/201 x 51,5		
	1.6 D		89-K-120000	02.87	- ABS													
	1.6 TD		89-K-120000	04.88	- ABS													
	1.8	55	89-K-120000	09.86	- ABS													
	1.8	66	89-K-120000	09.86	- ABS													
	1.8		89-K-120000	09.86	- ABS													
	1.9 D		89-K-120000	09.86	- ABS													
	1.6		89-K-200001	8A-M-095094	07.89	- ABS	24.0220-0017.1	480053		200/201 x 52								
	1.6 D		89-K-200001	8A-M-095094	07.89	- ABS												
	1.6 TD		89-K-200001	8A-M-095094	07.89	- ABS												
1.8	55	89-K-200001	8A-M-095094	07.89	- ABS													
1.8	66	89-K-200001	8A-M-095094	07.89	- ABS													
1.9 D		89-K-200001	8A-M-095094	08.89	- ABS													
1.6		8A-M-095095	8A-M-095095	07.91	- ABS	24.0220-0016.1						480018		200/201 x 51,5				
1.6 TD		8A-M-095095	8A-M-095095	07.91	- ABS													
1.8	55	8A-M-095095	8A-M-095095	07.91	- ABS													
1.8	66	8A-M-095095	8A-M-095095	07.91	- ABS													
1.9 D		8A-M-095095	8A-M-095095	07.91	- ABS													

¹⁾ on the brake caliper / sulla pinza freno / sur l'étrier de frein / a la pinza de freno
²⁾ - ABS/ - brake press.regulator / - ABS/ - correttore di frenata / - ABS/ - correcteur de freinage / - ABS/ - corrector de frenado
³⁾ + cast iron / + ghisa / + fonte grise / + fundición de gris
⁴⁾ + aluminium / + alluminio / + aluminium / + aluminio
⁵⁾ - ABS/ + manual transmission / - ABS/+ scatola camb.velocità / - ABS/ + transmission mécanique / - ABS/ + cambio de velocidad
⁶⁾ - ABS/ + brake press.regulator / - ABS/ + correttore di frenata / - ABS/ + correcteur de freinage / - ABS/ + corrector de frenado
⁷⁾ - ABS/ + autom.transmission / - ABS/ + scatola cambio autom. / - ABS/ + transmission automatique / - ABS/ + cambio automático





AUDI 80 (87-91)

	1.6 1.6 D 1.8	55 89-K-200001 89-K-200001	8A-M-080000	07.89	- ABS - ABS - ABS/ + Schaltgetriebe ¹⁾	03.0520-0415.3	690415			15,87/200x40 TopKit	VW
	1.6 1.6 TD 1.8 1.8 1.9 D	51 89-K-200001 89-K-200001 89-K-200001 89-K-200001	8A-M-080000 8A-M-080000 8A-M-080000 8A-M-080000 8A-M-080000	08.89	- ABS/ + Bremskraftregler ²⁾ - ABS - ABS/ + Automatikgetriebe ³⁾ - ABS - ABS	03.0420-4219.3 03.0520-4219.3	684219 694219			19,05/200x40 Kit 19,05/200x40 TopKit	VW VW
	1.6 1.6 D 1.6 TD 1.8 1.8 1.9 D 1.8 1.9 E 2.0	55 66 82		09.86 02.87 04.88 09.86 09.86 08.89 09.86 09.86 08.88	07.91 07.89 07.91 07.91 07.91 07.91 07.88 07.88 07.91	24.3727-0128.2 24.3727-0127.2	580128 580127	<input type="checkbox"/> <input type="checkbox"/>		L=1345 L=1298	
	1.6 1.6 D 1.6 TD 1.8 1.9 D 1.9 E 2.0			09.86 02.87 04.88 09.86 08.89 09.86 08.88	07.91 07.89 07.91 07.91 07.91 07.88 07.91	03.6585-0108.3	320115			BRL 8/5 (4)	ATE
	1.6 1.6 D 1.6 TD 1.8 1.9 D 1.9 E 2.0			09.86 02.87 04.88 09.86 08.89 09.86 08.88	07.91 07.89 07.91 07.91 07.91 07.88 07.91	03.2419-9210.3	030026			Gz 19,05	
	1.6 1.6 D 1.6 TD 1.8 1.9 D 1.9 E 2.0			09.86 02.87 04.88 09.86 08.89 09.86 08.88	07.91 07.89 07.91 07.91 07.91 07.88 07.91	24.2522-1707.3	040103			Nz 22,20	

AUDI 80 (91-95)

	1.6 1.9 TD 1.9 TDI 2.0 2.3	55 66	8C-N-300000 8C-N-300000 8C-N-300000 8C-N-300000 8C-N-300000	08.91 09.91 09.91 08.91 08.91		03.7750-0302.4	300071			9"	ATE
	1.6 1.9 TD 1.9 TDI 2.0 2.3	8C-P-000001 55 8C-P-000001 66 8C-P-000001 8C-P-000001 8C-P-000001		12.95 12.95 12.95 12.95 12.95	- ABS - ABS - ABS - ABS - ABS	03.2123-0491.3	010167			Thz 23,81	ATE
	1.6 1.9 TD 1.9 TDI 2.0 2.3 2.6 2.8	55 66		08.91 09.91 09.91 08.91 09.91 08.92 09.91	12.95 + ABS 12.95 + ABS 12.95 + ABS 12.95 + ABS/ - Hydraulikverstärker ⁴⁾ 12.95 + ABS 12.95 + ABS/ - Hydraulikverstärker ⁴⁾ 12.95 + ABS/ - Hydraulikverstärker ⁴⁾	24.2123-1602.3	010384			Thz 23,81	TRW
	2.0 2.6 2.8			08.91 07.92 09.91	12.95 + ABS/ + Hydraulikverstärker ⁵⁾ 12.95 + ABS/ + Hydraulikverstärker ⁵⁾ 12.95 + ABS/ + Hydraulikverstärker ⁵⁾	03.2123-0566.3	010169			Thz 23,81	ATE
	1.6 1.9 TD 1.9 TDI 2.0	52 55 66 66	8C-N-300000 8C-N-300000 8C-N-300000 8C-N-300000	08.91 08.91 08.91 08.91		24.3541-1610.5 24.3541-1609.5 24.0101-4301.2 11.0101-5403.2	240040 240039 260047 260010	<input type="checkbox"/> <input type="checkbox"/> <input type="checkbox"/> <input type="checkbox"/>		D=54, - Halter D=54, - Halter Bremsattel-Zubehör Fallenbalgsatz	TRW TRW TRW TRW
	1.6 1.6 1.9 TD 1.9 TD 1.9 TDI 2.0	52 52 55 8C-P-000001 55 66 8C-P-000001 66 8C-P-000001	8C-P-000001	07.93 08.93 07.93 08.93 12.95 12.95	+ Schaltgetriebe ⁶⁾ + Schaltgetriebe ⁶⁾ + Schaltgetriebe ⁶⁾ + Schaltgetriebe ⁶⁾	24.3541-1743.5 24.3541-1744.5	240219 240220	<input type="checkbox"/> <input type="checkbox"/>		D=54, - Halter D=54, - Halter	TRW TRW
	1.6 1.6 1.9 TD 1.9 TD 1.9 TDI 2.0 2.0 2.0 2.0 2.0 2.3 2.6 2.8	52 74 55 66 66 85 101 103		08.93 08.91 08.93 08.93 08.91 08.91 08.91 08.91 08.91 08.91 08.92 08.92	+ Automatikgetriebe ⁷⁾ + Automatikgetriebe ⁷⁾ + Automatikgetriebe ⁷⁾ + Automatikgetriebe ⁷⁾ + Automatikgetriebe ⁷⁾ + Automatikgetriebe ⁷⁾ + Automatikgetriebe ⁷⁾ + Automatikgetriebe ⁷⁾ + Automatikgetriebe ⁷⁾ + Automatikgetriebe ⁷⁾ + Automatikgetriebe ⁷⁾ + Automatikgetriebe ⁷⁾	24.3541-1720.5 24.3541-1719.5 24.0101-4301.2 11.0101-5403.2	240058 240057 260047 260010	<input type="checkbox"/> <input type="checkbox"/>		D=54, - Halter D=54, - Halter Bremsattel-Zubehör Fallenbalgsatz	TRW TRW TRW TRW
	2.0 2.0 2.3 2.6			08.91 09.91 08.92	12.95 12.95 12.95	24.0101-3401.2 11.0101-5403.2	260043 260010			Bremsattel-Zubehör Fallenbalgsatz	TRW TRW
	1.6 1.9 TD 1.9 TDI	55 66		08.91 09.91 09.91	12.95 12.95 12.95	13.0460-2934.2 13.0460-2925.2	602934 602925			20669 19,0 /S 20901 19,0 +/WK/S	TRW TRW

1) - ABS/ + manual transmission / - ABS/+ scatola camb.velocità / - ABS/ + transmission mécanique / - ABS/ + cambio de velocidad
2) - ABS/ + brake press.regulator / - ABS/ + correttoire di frenata / - ABS/ + correcteur de freinage / - ABS/ + corrector de frenado
3) - ABS/ + autom.transmission / - ABS/ + scatola cambio autom. / - ABS/ + transmission automatique / - ABS/ + cambio automático
4) + ABS/ - hydraulic booster / + ABS/ - servofreno idraulico / + ABS/ - amplificateur hydraulique / + ABS/ - servo hidráulico
5) + ABS/ + hydraulic booster / + ABS/ + servofreno idraulico / + ABS/ + amplificateur hydraulique / + ABS/ + servo hidráulico
6) + manual transmission / + scatola cambio velocità / + transmission mécanique / + cambio de velocidad
7) + autom.transmission / + scatola cambio automatico / + transmission automatique / + cambio automático



AUDI 80 (91-95)											
	2.0			08.91	12.95	13.0460-2934.2	602934			20669 19,0 /S	TRW
	2.3			09.91	12.95	13.0460-2925.2	602925			20901 19,0 +/WK/S	TRW
	2.6			07.92	12.95						
	2.8			09.91	12.95	13.0460-2963.2	602963			21138 18,8 +/WK/S	TRW
	1.6	52	8C-P-000001	08.91		24.0113-0166.1	413166			256 13,0 11,0 +B	
	1.9 TD	55	8C-P-000001	09.91							
	1.9 TDI	66	8C-P-000001	09.91							
	2.0	66	8C-P-000001	08.91	+ Schaltgetriebe 1)						
	1.6	52	8C-P-000001		12.95 + Schaltgetriebe 1)	24.0113-0179.1	413179			280 13,0 11,0 L +B	
	1.9 TD	55	8C-P-000001		12.95 + Schaltgetriebe 1)						
	1.9 TDI	66	8C-P-000001		12.95						
	2.0	66	8C-P-000001		12.95 + Schaltgetriebe 1)						
	1.6	74	8C-N-300000	08.91		24.0122-0108.1	422108			256 22,0 20,0 V L +B	
	2.0	66	8C-N-300000	08.91	+ Automatikgetriebe 2)						
	2.0	85	8C-N-300000	08.91							
	2.0	101	8C-N-300000	08.91							
	2.3		8C-N-300000	09.91							
	1.6	52	8C-P-000001		12.95 + Automatikgetriebe 2)	24.0122-0139.1	422139			280 22,0 20,0 V L +B	
	1.6	74	8C-P-000001		12.95						
	1.9 TD	55	8C-P-000001		12.95 + Automatikgetriebe 2)						
	2.0	66	8C-P-000001		12.95 + Automatikgetriebe 2)						
	2.0	85	8C-P-000001		12.95						
	2.0	101	8C-P-000001		07.92						
	2.0	103	8C-P-000001		12.95						
	2.3		8C-P-000001		12.95						
	2.6		8C-P-000001		12.95						
	2.8			08.92	12.95						
	2.8			09.91	12.95	24.0125-0106.1	425106			276 25,0 23,0 V L +B	
	1.6			08.91	12.95	24.5237-0288.3	331442	2		L=288	
	1.9 TD	55		09.91	12.95	24.5170-0161.3	331308	2	am Bremssattel 3)	L=161	
	1.9 TDI	66		09.91	12.95						
	2.0			08.91	12.95						
	2.3			09.91	12.95						
	2.6			07.92	12.95						
	2.8			09.91	12.95						
	1.6		8C-P-050000	08.91	+ ABS	24.3384-1701.5	240169			D=38, - Halter	TRW
	1.6		8C-P-050000	09.91	+ ABS	24.3384-1702.5	240170			D=38, - Halter	TRW
	1.9 TD	55	8C-P-050000	09.91	+ ABS						
	1.9 TDI	66	8C-P-050000	09.91	+ ABS						
	1.9 TDI	66	8C-P-050000	09.91	+ ABS						
	2.0	66	8C-P-050000	08.91	+ ABS						
	2.0	66	8C-P-050000		12.95						
	2.0	85		08.91	12.95						
	2.0	101		08.91	07.92						
	2.0	103		08.91	12.95						
	2.3			09.91	12.95						
	2.6			08.92	12.95						
	2.8			09.91	12.95						
	1.6		8C-P-050000	08.91	+ ABS	13.0460-3602.2	603602			21144 15,8 /S	TRW
	1.6	55	8C-P-050000	09.91	+ ABS						
	1.9 TD	55	8C-P-050000	09.91	+ ABS						
	1.9 TDI	66	8C-P-050000	09.91	+ ABS						
	1.9 TDI	66	8C-P-050000	09.91	+ ABS						
	2.0	66	8C-P-050000	08.91	+ ABS						
	2.0	66	8C-P-050000		12.95						
	2.0	85		08.91	12.95						
	2.0	101		08.91	07.92						
	2.0	103		08.91	12.95						
	2.3			09.91	12.95						
	2.6			08.92	12.95						
	2.8			09.91	12.95						
	1.6		8C-P-050000	08.91	- ABS	83.7812-0200.3	330846	2		L=200	
	1.9 TD	55	8C-P-050000	09.91	- ABS						
	1.9 TDI	66	8C-P-050000	09.91	- ABS						
	2.0	66	8C-P-050000	09.91	- ABS						
	1.6		8C-P-050000	08.91	+ ABS	83.7812-0200.3	330846	2		L=200	
	1.6		8C-P-050000	09.91	+ ABS	83.7724-0202.3	330852	2	am Bremssattel 3)	L=200	
	1.9 TD	55	8C-P-050000	09.91	+ ABS						
	1.9 TDI	55	8C-P-050000	09.91	+ ABS						
	1.9 TDI	66	8C-P-050000	09.91	+ ABS						

1) + manual transmission / + scatola cambio velocità / + transmission mécanique / + cambio de velocidad
 2) + autom.transmission / + scatola cambio automatico / + transmission automatique / + cambio automático
 3) on the brake caliper / sulla pinza freno / sur l'étrier de frein / a la pinza de freno





AUDI 80 (91-95)															
	1.9 TDI	66	8C-P-050001		12.95	83.7812-0200.3 83.7724-0202.3	330846 330852	2 2	am Bremssattel ¹⁾	L=200 L=200					
	2.0	66	8C-P-050000	08.91	+ ABS										
	2.0	66	8C-P-050001		12.95										
	2.0	85		08.91	12.95										
	2.0	101		08.91	07.92										
	2.0	103		08.91	12.95										
	2.3			09.91	12.95										
	2.6			08.92	12.95										
2.8			09.91	12.95											
	1.6	52	8C-P-050000	08.91	- ABS	03.3217-2112.3 24.3217-0908.3	020027 020167		+ GG ²⁾ + ALU ³⁾	Rz 17,46 Rz 17,46					
	1.9 TD	55	8C-P-050000	09.91	- ABS										
	1.6	74	8C-N-300000	08.91	- ABS										
	1.9 TDI	66	8C-N-300000	08.91	- ABS										
2.0		8C-N-300000	08.91	- ABS	24.3219-0909.3	020188			Rz 19,05						
	1.6	74	8C-P-000001	8C-P-050000	- ABS	24.3220-0909.3	020210			Rz 20,64					
	1.9 TDI	66	8C-P-000001	8C-P-050000	- ABS										
	2.0		8C-P-000001	8C-P-050000	- ABS										
	1.6	55	8C-P-050000	08.91	- ABS	03.0137-0264.2 03.0137-9164.2	650264 669164			230 x 40 HEB Bremsbacken-Zubehör					
	1.9 TD	66	8C-P-050000	08.91	- ABS										
	1.9 TDI	66	8C-P-050000	08.91	- ABS										
	1.6	55	8C-P-050000	08.91	- ABS	24.0223-0007.1	480037			230/231 x 45,8					
	1.9 TD	66	8C-P-050000	09.91	- ABS										
	1.9 TDI	66	8C-P-050000	09.91	- ABS										
	1.6	74	8C-P-000001	8C-P-050000	- ABS	03.0520-6120.3	696120			20,64/230x40 TopKit					
	1.9 TDI	66	8C-P-000001	8C-P-050000	- ABS										
	2.0		8C-P-000001	8C-P-050000	- ABS										
	1.6		8C-P-050000	08.91	- ABS	24.3727-0148.2	580148	2	+ HA-Trommelbremse ⁴⁾	L=1578					
	1.9 TD	55	8C-P-050000	09.91	- ABS										
	1.9 TDI	66	8C-P-050000	09.91	- ABS										
	2.0	66	8C-P-050000	08.91	- ABS										
	1.6		8C-P-050001	8C-P-235351							24.3727-0147.2	580147	2	+ HA-Scheibenbremse ⁵⁾	L=1722
	1.6		8C-P-050000	09.91	+ ABS										
	1.9 TD	55	8C-P-050001	8C-P-235351											
	1.9 TD	55	8C-P-050000	09.91	+ ABS										
1.9 TDI	66	8C-P-050001	8C-P-235351												
1.9 TDI	66	8C-P-050000	09.91	+ ABS											
2.0	66	8C-P-050001	8C-P-235351												
2.0	66	8C-P-050000	09.91	+ ABS											
2.0	85		8C-P-235351	09.91											
2.0	101		8C-P-235351	09.91											
2.0	103		8C-P-235351	09.91											
2.3			8C-P-235351	09.91											
2.6			8C-P-235351	07.92											
2.8			8C-P-235351	09.91											
	1.6		8C-P-235352		12.95	24.3727-0191.2 24.3727-0192.2	580191 580192		+ HA-Scheibenbremse ⁵⁾ + HA-Scheibenbremse ⁵⁾	L=1723 L=1723					
	1.9 TD	55	8C-P-235352		12.95										
	1.9 TDI	66	8C-P-235352		12.95										
	2.0	66	8C-P-235352		12.95										
	2.0	85	8C-P-235352		12.95										
	2.0	101	8C-P-235352		07.92										
	2.0	103	8C-P-235352		12.95										
	2.3		8C-P-235352		12.95										
	2.6		8C-P-235352		12.95										
	2.8		8C-P-235352		12.95										
	1.6			08.91	12.95	03.6584-0107.3	320110			BRL 8/4 (4)					
	1.9 TD	55		09.91	12.95										
	1.9 TDI	66		09.91	12.95										
	2.0			08.91	12.95										
	2.3			09.91	12.95										
	2.6			07.92	12.95										
2.8			09.91	12.95											
	1.6			08.91	12.95	03.2419-9210.3	030026			Gz 19,05					
	1.9 TD	55		09.91	12.95										
	1.9 TDI	66		09.91	12.95										
	2.0			08.91	12.95										
	2.3			09.91	12.95										
	2.6			07.92	12.95										
2.8			09.91	12.95											
	1.6			08.91	12.95	24.2522-1707.3	040103			Nz 22,20					
	1.9 TD	55		09.91	12.95										
	1.9 TDI	66		09.91	12.95										
	2.0			08.91	12.95										
	2.3			09.91	12.95										
	2.6			07.92	12.95										
2.8			09.91	12.95											

AUDI 80 Quattro (78-86)

	1.8			08.84	08.86	03.7750-0302.4	300071			9"	ATE
	2.2			08.84	08.86						
	2.0			08.83	07.84	03.2122-8012.3	010156			THz 22,20	ATE
	2.2			08.82	07.84						

1) on the brake caliper / sulla pinza freno / sur l'étrier de frein / a la pinza de freno
2) + cast iron / + ghisa / + fonte grise / + fundición de gris
3) + aluminium / + aluminio / + aluminium / + aluminio
4) + RA drum brake / + P freno a tamburo / + frein à tambour essieu AR / + ET-tambores de freno
5) + RA disc brake / + P disco freno / + frein à disque essieu AR / + ET-disco de freno

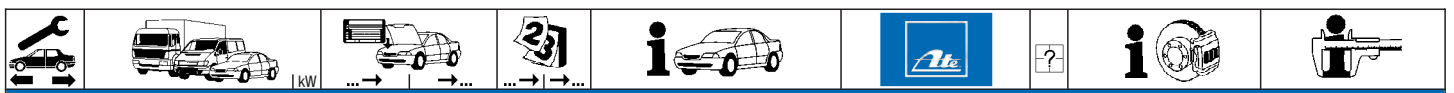

AUDI 80 Quattro (78-86)												
	1.8 2.2				08.84 08.84	08.86 08.86		03.2122-9612.3	010159		Thz 22,20	ATE
	1.8 2.0 2.2				08.84 08.83 08.82	08.86 07.84 08.86		24.3541-1610.5 24.3541-1609.5 24.0101-4301.2 11.0101-5403.2	240040 240039 260047 260010		D=54, - Halter D=54, - Halter Bremsattel-Zubehör Fallenbalgsatz	TRW TRW TRW TRW
	1.8 2.0 2.2				08.84 08.83 08.82	08.86 07.84 08.86		13.0460-2926.2	602926		20669 15,7 /S	TRW
	1.8 2.0 2.2				08.84 08.83 08.82	08.86 07.84 08.86		24.0120-0120.1	420120		256 20,0 18,0 V L	
	1.8 2.0 2.2				08.84 08.83 08.82	08.86 07.84 08.86		24.5170-0315.3	331309	2	L=315	
	1.8 2.0 2.2		85-E-000001 85-E-000001		08.84 08.83 08.82	08.86 07.84 08.86		24.0101-3601.2	260044		Bremsattel-Zubehör	TRW
	1.8 2.0 2.2				08.84 08.83 08.82	08.86 07.84 08.86		13.0460-3602.2	603602		21144 15,8 /S	TRW
	1.8 2.0 2.2				08.84 08.83 08.82	08.86 07.84 08.86		24.0110-0182.1	410182		245 10,0 8,0 +B	
	2.2			85-D-250000	08.82			24.5170-0315.3	331309	2	L=315	
	1.8 2.0 2.2		85-E-000001 85-E-000001		08.84 08.83 08.82	08.86 07.84 08.86		83.6104-0250.3	330720	2	L=250	
	1.8 2.0 2.2				08.84 08.83 08.82	08.86 07.84 08.86		03.6058-0301.3	320072		BR 25/5 (3)	ATE
	1.8 2.0 2.2				08.84 08.83 08.82	08.86 07.84 08.86		03.2419-8150.3	030019		Gz 19,05	
	1.8 2.0 2.2				08.84 08.83 08.82	08.86 07.84 08.86		03.2522-4211.3	040017		Nz 22,20	

AUDI 80 Quattro (87-91)												
	1.8 1.9 E 2.0				09.86 09.86 08.88	09.91 07.88 09.91		03.7750-0302.4	300071		9"	ATE
	1.8 1.9 E 2.0				09.86 09.86 08.88	09.91 07.88 09.91	- ABS - ABS - ABS	03.2122-9612.3	010159		Thz 22,20	ATE
	1.8 1.9 E 2.0		83 103		09.86 09.86 08.88	09.91 07.88 09.91		03.2123-0566.3 03.3517-0101.2	010169 390322		Thz 23,81 Verschlußschraube	ATE
	1.8		66		09.86	09.91		24.3541-1610.5 24.3541-1609.5 11.0441-5405.2 11.0101-5409.2 11.8171-0008.1 24.0101-4301.2 11.0101-5403.2	240040 240039 250030 260035 990049 260047 260010		D=54, - Halter D=54, - Halter Dichtungssatz Hülzensatz Führungsbolzen Bremsattel-Zubehör Fallenbalgsatz	TRW TRW ATE ATE ATE TRW TRW
	1.8 1.9 E 2.0		82		09.86 09.86 08.88	09.91 07.88 09.91		11.3541-8521.2 24.3541-1720.5 24.3541-1719.5 11.0441-5405.2 11.0101-5409.2 11.8171-0008.1 24.0101-4301.2 11.0101-5403.2	220113 240058 240057 250030 260035 990049 260047 260010		D=54, - Halter D=54, - Halter D=54, - Halter Dichtungssatz Hülzensatz Führungsbolzen Bremsattel-Zubehör Fallenbalgsatz	ATE TRW TRW ATE ATE ATE TRW TRW
	1.8 1.9 E 2.0				09.86 09.86 08.88	09.91 07.88 09.91		13.0460-2934.2	602934		20669 19,0 /S	TRW
	1.8 1.9 E 2.0		66 82		09.86 09.86 08.88	09.91 07.88 09.91		24.0113-0160.1 24.0122-0118.1	413160 422118		256 13,0 11,0 +B 256 22,0 20,0 V +B	
	1.8 1.9 E 2.0				09.86 09.86 08.88	07.88		24.5170-0315.3	331309	2	L=315	
	1.8 2.0		8A-L-030001 8A-L-030001		09.91 09.91			24.5237-0288.3 24.5170-0161.3	331442 331308	2 2	am Bremsattel 1)	L=288 L=161
	1.8 1.9 E				09.86 09.86			24.0101-3601.2	260044		Bremsattel-Zubehör	TRW
	1.8 1.9 E 2.0		89-J-240001 89-J-240001		09.86 09.86 08.88	09.91 07.88 09.91		24.3384-1703.5 24.3384-1704.5 24.0101-3601.2	240055 240056 260044		D=38, - Halter D=38, - Halter Bremsattel-Zubehör	TRW TRW TRW

1) on the brake caliper / sulla pinza freno / sur l'étrier de frein / a la pinza de freno



AUDI 80 Quattro (87-91)									
	1.8 1.9 E 2.0			09.86 09.86 08.88	09.91 07.88 09.91	13.0460-3602.2	603602		21144 15,8 /S TRW
	1.8 1.9 E 2.0			09.86 09.86 08.88	09.91 07.88 09.91	24.0110-0182.1	410182		245 10,0 8,0 +B
	1.8 1.9 E 2.0			09.86 09.86 08.88	09.91 07.88 09.91	83.6104-0250.3	330720	2	L=250
	1.8 1.9 E 2.0			09.86 09.86 08.88	09.91 07.88 09.91	03.2419-9210.3	030026		Gz 19,05
	1.8 1.9 E 2.0			09.86 09.86 08.88	09.91 07.88 09.91	24.2522-1707.3	040103		Nz 22,20
AUDI 80 Quattro (92-95)									
	2.0 2.3			09.91 09.91	12.95 12.95	03.7750-0302.4	300071		9" ATE
	RS 2 S2	◀232 ◀169	8C-S-000368	03.94 02.93	12.95 12.95	10.0124-3202.3	340011		Hydraulik Verstärker
	2.0 2.0	◀8C-P-000001 ◀8C-P-000001		12.95 12.95	12.95 12.95	03.2123-0491.3	010167		Thz 23,81 ATE
	RS 2 RS 2 S2	◀232 ▶232 169	8C-S-000368	03.94 03.94 02.93	07.95 07.95 12.95	03.2125-3610.3	010214		Thz 25,40 ATE
	2.0 2.6 2.8	▶ ▶ ▶		09.91 08.92 09.91	12.95 12.95 12.95	03.2123-0566.3	010169		Thz 23,81 ATE
	2.0 2.3 2.6			09.91 09.91 08.92	12.95 12.95 12.95	24.3541-1720.5 24.3541-1719.5 24.0101-4301.2 11.0101-5403.2	240058 240057 260047 260010	<input type="checkbox"/> <input type="checkbox"/>	D=54, - Halter D=54, - Halter Bremsattel-Zubehör Fallenbalgsatz TRW TRW TRW
	2.8 S2	169		09.91 02.93	12.95 12.95	24.0101-3401.2 11.0101-5403.2	260043 260010		Bremsattel-Zubehör Fallenbalgsatz TRW TRW
	2.0 2.3 2.6			09.91 09.91 08.92	12.95 12.95 12.95	13.0460-2934.2	602934		20669 19,0 /S TRW
	2.8 S2	169		09.91 02.93	12.95 12.95	13.0460-2963.2	602963		21138 18,8 +/WK/S TRW
	2.0 2.3		8C-N-300000 8C-N-300000	09.91 09.91		24.0122-0108.1	422108		256 22,0 20,0 V L +B
	2.0 2.3 2.6	8C-P-000001 8C-P-000001		12.95 12.95 08.92	12.95 12.95 12.95	24.0122-0139.1	422139		280 22,0 20,0 V L +B
	2.8 S2	169		09.91 02.93	12.95 12.95	24.0125-0106.1 24.0125-0139.1	425106 425139		276 25,0 23,0 V L +B 276 24,9 23,0 V L +B
	2.0 2.3 2.6 2.8			09.91 09.91 08.92 09.91	12.95 12.95 12.95 12.95	24.5237-0288.3 24.5170-0161.3	331442 331308	2 2	am Bremsattel 1) L=288 L=161
	RS 2 S2	232 169		03.94 02.93	07.95 12.95				
	2.0 2.3 2.6 2.8 S2			09.91 09.91 08.92 09.91 02.93	12.95 12.95 12.95 12.95 12.95	13.0460-3602.2	603602		21144 15,8 /S TRW
	2.0 2.3 2.6 2.8 S2			09.91 09.91 08.92 09.91 02.93	12.95 12.95 12.95 12.95 12.95	24.0110-0182.1	410182		245 10,0 8,0 +B
		169		02.93	12.95	24.0110-0261.1 24.0310-0261.1	410261 510261		245 10,0 8,0 +S +B 245 10,0 8,0 +B PD
	2.0 2.3 2.6 2.8			09.91 09.91 08.92 09.91	12.95 12.95 12.95 12.95	83.6212-0160.3 24.5113-0220.3	330318 331318	2 2	am Bremsattel 1) L=160 L=220
	RS 2 S2	232 169		03.94 02.93	07.95 12.95				
	2.0 2.3 2.6 2.8			09.91 09.91 08.92 09.91	12.95 12.95 12.95 12.95	03.2419-9210.3	030026		Gz 19,05
	2.0 2.3 2.6 2.8 RS 2 S2			09.91 09.91 08.92 09.91 03.94 02.93	12.95 12.95 12.95 12.95 07.95 12.95	24.2522-1707.3	040103		Nz 22,20
		232 169							

¹⁾ on the brake caliper / sulla pinza freno / sur l'étrier de frein / a la pinza de freno



























AUDI 90 (85-87)

	1.6 TD 2.0 2.2			10.84 03.87 10.84 03.87 10.84 03.87		03.7750-0302.4	300071		9"	ATE		
	1.6 TD 2.0 2.2			10.84 03.87 10.84 03.87 10.84 03.87	- verstärkte Bremse ¹⁾ - verstärkte Bremse ¹⁾ - verstärkte Bremse ¹⁾	03.2120-2331.3	010110	Kompakt-THz ²⁾	THz 20,64	ATE		
	1.6 TD 2.0 2.2			10.84 03.87 10.84 03.87 10.84 03.87	+ verstärkte Bremse ³⁾ + verstärkte Bremse ³⁾ + verstärkte Bremse ³⁾	03.2122-9612.3	010159		THz 22,20	ATE		
	1.6 TD 2.0 2.2			10.84 03.87 10.84 03.87 10.84 03.87		24.3541-1610.5 24.3541-1609.5 24.0101-4301.2 11.0101-5403.2	240040 240039 260047 260010	<input type="checkbox"/> <input type="checkbox"/>	D=54, - Halter D=54, - Halter Bremsattel-Zubehör Fallenbalgsatz	TRW TRW TRW TRW		
	1.6 TD 2.0 2.2			10.84 03.87 10.84 03.87 10.84 03.87		13.0460-2926.2	602926		20669	15,7 /S	TRW	
	1.6 TD 2.0 2.2			10.84 03.87 10.84 03.87 10.84 03.87		24.0120-0120.1	420120		256	20,0 18,0 V L		
	1.6 TD 2.0 2.2			10.84 03.87 10.84 03.87 10.84 03.87		24.5170-0315.3	331309	2		L=315		
	2.2	100		10.84 03.87		24.0101-3601.2	260044			Bremsattel-Zubehör	TRW	
	2.2	100		10.84 03.87		13.0460-3602.2	603602			21144	15,8 /S	TRW
	2.2	100		10.84 03.87		24.0110-0178.1	410178			245	10,0 8,0 +B	
	1.6 TD 2.0 2.2			10.84 03.87 10.84 03.87 01.85 03.87		83.6224-0200.3 83.7804-0150.3	330729 330853	<input type="checkbox"/> <input type="checkbox"/>		L=200 L=150		
	2.2	100		10.84 03.87		83.6224-0200.3 83.7804-0150.3 24.5170-0161.3	330729 330853 331308	<input type="checkbox"/> <input type="checkbox"/> 2	am Bremsattel ⁴⁾	L=200 L=150 L=161		
	1.6 TD 2.0 2.2	85		10.84 03.87 10.84 03.87 01.85 03.87		03.3217-2112.3 24.3217-0908.3	020027 020167	<input type="checkbox"/> <input type="checkbox"/>	+ GG ⁵⁾ + ALU ⁶⁾	Rz 17,46 Rz 17,46		
	1.6 TD 2.0 2.2	85		10.84 03.87 10.84 03.87 01.85 03.87		03.0137-0146.2 03.0137-9041.2	650146 669041			200 x 40 HEB Bremsbacken-Zubehör		
	1.6 TD 2.0 2.2	85		10.84 03.87 10.84 03.87 01.85 03.87		24.0220-0016.1	480018			200/201 x 51,5		
	1.6 TD 2.0 2.2	85		10.84 03.87 10.84 03.87 01.85 03.87		03.0420-0417.3	680417			17,46/200x40 Kit	VW	
	1.6 TD 2.0 2.2	85		10.84 03.87 10.84 03.87 01.85 03.87		24.3727-0136.2 24.3727-0139.2	580136 580139	<input type="checkbox"/> <input type="checkbox"/>		L=1195 L=1150		
	1.6 TD 2.0 2.2			10.84 03.87 10.84 03.87 10.84 03.87	- verstärkte Bremse ¹⁾ - verstärkte Bremse ¹⁾ - verstärkte Bremse ¹⁾	03.6565-0101.3	320097			BRL 6/5 (4)	ATE	
	1.6 TD 2.0 2.2			10.84 03.87 10.84 03.87 10.84 03.87	+ verstärkte Bremse ³⁾ + verstärkte Bremse ³⁾ + verstärkte Bremse ³⁾	03.6585-0108.3	320115			BRL 8/5 (4)	ATE	
	1.6 TD 2.0 2.2			10.84 03.87 10.84 03.87 10.84 03.87		03.2419-8150.3	030019			Gz 19,05		
	1.6 TD 2.0 2.2			10.84 03.87 10.84 03.87 10.84 03.87		03.2522-4211.3	040017			Nz 22,20		





























AUDI 90 (87-91)

	1.6 TD 1.8 2.0 2.2 2.3			04.88 07.91 08.89 07.91 04.87 07.91 04.87 07.91 04.87 07.91		03.7750-0302.4	300071		9"	ATE	
	2.0 2.2 2.3 2.3			04.87 07.91 04.87 07.91 04.87 07.91 08.88 07.91		10.0124-3202.3	340011			Hydraulik Verstärker	
	1.6 TD 1.8 2.0 2.2 2.3			04.88 07.91 08.89 07.91 04.87 07.91 04.87 07.91 04.87 07.91	- ABS - ABS - ABS/ - Hydraulikverstärker ⁷⁾ - ABS/ - Hydraulikverstärker ⁷⁾ - ABS/ - Hydraulikverstärker ⁷⁾	03.2122-9612.3	010159			THz 22,20	ATE
	2.0 2.2 2.3			04.87 07.91 04.87 07.91 04.87 07.91	+ Hydraulikverstärker ⁸⁾ + Hydraulikverstärker ⁸⁾ + Hydraulikverstärker ⁸⁾	03.2123-0566.3	010169			THz 23,81	ATE

¹⁾ - heavy duty brake / - freno rinforzato / - frein renforcé / - freno reforzado
²⁾ compact TMC / PFT compatta / MCT compact / CMT compacto
³⁾ + heavy duty brake / + freno rinforzato / + frein renforcé / + freno reforzado
⁴⁾ on the brake caliper / sulla pinza freno / sur l'étrier de frein / a la pinza de freno
⁵⁾ + cast iron / + ghisa / + fonte grise / + fundición de gris
⁶⁾ + aluminium / + alluminio / + aluminium / + aluminio
⁷⁾ - ABS/ - hydraulic booster / - ABS/ - servofreno idraulico / - ABS/ - amplificateur hydraulique / - ABS/ - servo hidráulico
⁸⁾ + hydraulic booster / + servofreno idraulico / + amplificateur hydraulique / + servo hidráulico

AUDI 90 (87-91)															
	2.3	125		08.88	07.91		03.2125-3210.3	010212			THz 25,40	ATE			
	1.8	100		08.89	07.91		11.3541-8521.2	220113	  		D=54, - Halter	ATE			
	2.0			04.87	07.91		24.3541-1720.5	240058			D=54, - Halter	TRW			
	2.2			04.87	07.91		24.3541-1719.5	240057			D=54, - Halter	TRW			
	2.3			04.87	07.91		11.0441-5405.2	250030			Dichtungssatz	ATE			
							11.0101-5409.2	260035			Hülzensatz	ATE			
2.3	125	8A-L-038657		07.91		24.0101-3401.2	260043			Bremssattel-Zubehör	TRW				
						11.0101-5403.2	260010			Faltenbalgsatz	TRW				
	1.6 TD			04.88	07.91		24.3541-1610.5	240040	 		D=54, - Halter	TRW			
	1.8			08.89	07.91		24.3541-1609.5	240039			D=54, - Halter	TRW			
							11.0441-5405.2	250030			Dichtungssatz	ATE			
							11.0101-5409.2	260035			Hülzensatz	ATE			
							11.8171-0008.1	990049			Führungsbolzen	ATE			
2.0			04.87	07.91		24.0101-4301.2	260047			Bremssattel-Zubehör	TRW				
2.2			04.87	07.91		11.0101-5403.2	260010			Faltenbalgsatz	TRW				
2.3	100		04.87	07.91		13.0460-2934.2	602934			20669 19,0 /S	TRW				
	2.3	125		08.88	07.91		13.0460-2963.2	602963			21138 18,8 +/WK/S	TRW			
	1.8			08.89	07.91		24.0122-0118.1	422118			256 22,0 20,0 V +B				
													2.0	04.87	07.91
													2.2	04.87	07.91
													2.3	04.87	07.91
1.6 TD			04.88	07.91		24.0113-0160.1	413160			256 13,0 11,0 +B					
	1.6 TD		8A-L-038656	04.88			24.5170-0315.3	331309	2		L=315				
	1.8		8A-L-038656	08.89											
	2.0		8A-L-038656	04.87											
	2.2		8A-L-038656	04.87											
	2.3	100	8A-L-038656	04.87											
	2.3	125	8A-L-038656	08.88			24.5113-0380.3	331344	2		L=382				
	1.6 TD		8A-L-038657		07.91		24.5237-0288.3	331442	2		L=288				
1.8		8A-L-038657		07.91		24.5170-0161.3	331308	2	am Bremssattel 1)	L=161					
2.0		8A-L-038657		07.91											
2.2		8A-L-038657		07.91											
2.3		8A-L-038657		07.91											
	1.6 TD		89-J-225956	04.88		+ ABS	24.0101-3601.2	260044			Bremssattel-Zubehör	TRW			
	2.0		89-J-225956	04.87											
	2.2		89-J-225956	04.87											
	2.3		89-J-225956	04.87											
	1.6 TD		89-J-221810		08.89	07.91	+ ABS	24.3384-1601.5	240013	 	D=38, - Halter	TRW			
1.8		89-J-221810		07.91		24.3384-1602.5	240014	D=38, - Halter	TRW						
2.0		89-J-221810		07.91		24.0101-3601.2	260044	Bremssattel-Zubehör	TRW						
2.2		89-J-221810		07.91											
2.3		89-J-221810		07.91											
	1.6 TD			04.88	07.91	+ ABS	13.0460-3602.2	603602			21144 15,8 /S	TRW			
	1.8			08.89	07.91										
	2.0			04.87	07.91										
	2.2			04.87	07.91										
	2.3			04.87	07.91										
	1.6 TD			04.88	07.91	+ ABS	24.0110-0178.1	410178			245 10,0 8,0 +B				
	1.8			08.89	07.91										
	2.0			04.87	07.91										
	2.2			04.87	07.91										
	2.3			04.87	07.91										
	1.6 TD			04.88	07.91		83.6224-0200.3	330729	  		L=200				
	1.8			08.89	07.91		83.7804-0150.3	330853			L=150				
	2.0			04.87	07.91		24.5170-0161.3	331308			L=161				
	2.2			04.87	07.91										
	2.3			04.87	07.91										
	1.6 TD			04.88	07.91	- ABS	24.3219-0909.3	020188			Rz 19,05				
	1.6 TD		89-K-200000	04.88		- ABS	03.0137-0146.2	650146			200 x 40 HEB	Bremssackenzubehör			
							03.0137-9041.2	669041							
	1.6 TD		89-K-200001	8A-M-080000			- ABS	03.0137-0268.2	650268			200 x 40 HEB	VW		
	1.6 TD		8A-M-080001		07.91		- ABS	03.0137-9168.2	669168			200 x 40 HEB	Bremssackenzubehör		
03.0137-0146.2								650146							
1.6 TD		89-K-120000	04.88			- ABS	24.0220-0016.1	480018			200/201 x 51,5				
1.6 TD		89-K-120001	8A-M-095094			- ABS	24.0220-0017.1	480053			200/201 x 52				
1.6 TD		8A-M-095095		07.91		- ABS	24.0220-0016.1	480018			200/201 x 51,5				
	1.6 TD		89-K-200001	8A-M-080000		- ABS	03.0420-4219.3	684219			19,05/200x40 Kit	VW			
							03.0520-4219.3	694219					19,05/200x40 TopKit	VW	
	1.8			08.89	07.91		24.3727-0143.2	580143	 		L=1398				
	2.0			04.87	07.91		24.3727-0144.2	580144					L=1358		
	2.2			04.87	07.91										

1) on the brake caliper / sulla pinza freno / sur l'étrier de frein / a la pinza de freno

									
AUDI 90 (87-91)									
	2.3			04.87	07.91	24.3727-0143.2	580143	<input type="checkbox"/>	L=1398
	1.6 TD			04.88	07.91	24.3727-0144.2	580144	<input type="checkbox"/>	L=1358
	1.6 TD			04.88	07.89	03.6585-0108.3	320115	<input type="checkbox"/>	BRL 8/5 (4)
	1.8			08.89	07.91			<input type="checkbox"/>	ATE
	2.0	85		04.87	07.89			<input type="checkbox"/>	L=1345
	2.2			04.87	07.89			<input type="checkbox"/>	L=1298
	2.3	100		04.87	07.89			<input type="checkbox"/>	
	1.6 TD			04.88	07.91	03.2419-9210.3	030026		Gz 19,05
	1.8			08.89	07.91				
	2.0			04.87	07.91				
	2.2			04.87	07.91				
	2.3			04.87	07.91				
	1.6 TD			04.88	07.91	24.2522-1707.3	040103		Nz 22,20
	1.8			08.89	07.91				
	2.0			04.87	07.91				
	2.2			04.87	07.91				
	2.3			04.87	07.91				
AUDI 90 Quattro (84-87)									
	2.2			08.84	03.87	03.7750-0302.4	300071		9"
	2.2			08.84	03.87	03.2122-9612.3	010159		THz 22,20
	2.2			08.84	03.87	24.3541-1610.5	240040	<input type="checkbox"/>	D=54, - Halter
						24.3541-1609.5	240039	<input type="checkbox"/>	TRW
						24.0101-4301.2	260047		Bremssattel-Zubehör
						11.0101-5403.2	260010		Faltenbalgsatz
	2.2			08.84	03.87	13.0460-2926.2	602926		20669 15,7 /S
	2.2			08.84	03.87	24.0120-0120.1	420120		256 20,0 18,0 V L
	2.2			08.84	03.87	24.5170-0315.3	331309	2	L=315
	2.2			08.84	03.87	24.0101-3601.2	260044		Bremssattel-Zubehör
	2.2			08.84	03.87	13.0460-3602.2	603602		21144 15,8 /S
	2.2			08.84	03.87	24.0110-0182.1	410182		245 10,0 8,0 +B
	2.2			08.84	03.87	83.6104-0250.3	330720	2	L=250
	2.2			08.84	03.87	03.6058-0301.3	320072		BR 25/5 (3)
	2.2			08.84	03.87	03.2419-8150.3	030019		Gz 19,05
	2.2			08.84	03.87	03.2522-4211.3	040017		Nz 22,20
AUDI 90 Quattro (87-91)									
	2.0			01.88	09.91	03.7750-0302.4	300071		9"
	2.2			04.87	09.91				ATE
	2.3			04.87	09.91				
	2.0			01.88	09.91	10.0124-3202.3	340011		Hydraulik Verstärker
	2.2			04.87	09.91				
	2.3	100		04.87	09.91				
	2.3	125		06.88	09.91				
	2.0			01.88	09.91	03.2122-9612.3	010159		THz 22,20
	2.2			04.87	09.91				ATE
	2.3	100		04.87	09.91				
	2.3	125		06.88	09.91				
	2.0			01.88	09.91	03.2123-0566.3	010169		THz 23,81
	2.2			04.87	09.91				ATE
	2.3	100		04.87	09.91				
	2.3	125		06.88	09.91	03.2125-3210.3	010212		THz 25,40
									ATE

1) - ABS/ - hydraulic booster / - ABS/ - servofreno idraulico / - ABS/ - amplificateur hydraulique / - ABS/ - servo hidráulico

2) + hydraulic booster / + servofreno idraulico / + amplificateur hydraulique / + servo hidráulico



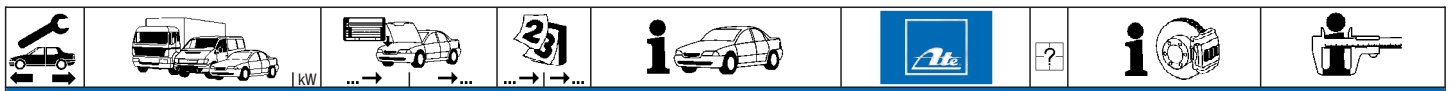

AUDI 90 Quattro (87-91)

	2.0			01.88	09.91		11.3541-8521.2	220113	☐ ☐ ☐	D=54, - Halter D=54, - Halter D=54, - Halter	ATE TRW TRW	
	2.2			04.87	09.91		24.3541-1720.5	240058				
	2.3	100		04.87	09.91		24.3541-1719.5	240057		Dichtungssatz	ATE	
							11.0441-5405.2	250030		Hülensatz	ATE	
							11.0101-5409.2	260035		Führungsbolzen	ATE	
							11.8171-0008.1	990049		Bremssattel-Zubehör	TRW	
							24.0101-4301.2	260047		Faltenbalgssatz	TRW	
							11.0101-5403.2	260010				
	2.3	125	8A-L-045363		09.91		24.0101-3401.2	260043		Bremssattel-Zubehör	TRW	
	2.0			01.88	09.91		13.0460-2934.2	602934		20669 19,0 /S	TRW	
	2.2			04.87	09.91							
	2.3	100		04.87	09.91							
	2.3	125		06.88	09.91		13.0460-2963.2	602963		21138 18,8 +WK/S	TRW	
	2.0			01.88	09.91		24.0122-0118.1	422118		256 22,0 20,0 V +B		
	2.2			04.87	09.91							
	2.3	100		04.87	09.91							
	2.2			04.87			24.5170-0315.3	331309	2		L=315	
	2.3	100	8A-L-030000	04.87								
	2.3	125	8A-L-030000	06.88			24.5113-0380.3	331344	2		L=382	
	2.0			01.88	09.91		24.5237-0288.3	331442	2		L=288	
	2.2		8A-L-030001	09.91	09.91		24.5170-0161.3	331308	2	am Bremssattel 1)	L=161	
	2.3		8A-L-030001	09.91	09.91							
	2.2			04.87			24.0101-3601.2	260044			Bremssattel-Zubehör	TRW
	2.3			04.87								
	2.0			01.88	09.91		24.3384-1703.5	240055	☐ ☐	D=38, - Halter	TRW	
	2.2			09.91	09.91		24.3384-1704.5	240056		D=38, - Halter	TRW	
	2.3		89-J-240001	09.91	09.91		24.0101-3601.2	260044		Bremssattel-Zubehör	TRW	
	2.0			01.88	09.91		13.0460-3602.2	603602		21144 15,8 /S	TRW	
	2.2			04.87	09.91							
	2.3			04.87	09.91							
	2.0			01.88	09.91		24.0110-0182.1	410182		245 10,0 8,0 +B		
	2.2			04.87	09.91							
	2.3			04.87	09.91							
	2.0			01.88	09.91		83.6104-0250.3	330720	2		L=250	
	2.2			04.87	09.91							
	2.3			04.87	09.91							
	2.0			01.88	09.91		03.2419-9210.3	030026		Gz 19,05		
	2.2			04.87	09.91							
	2.3			04.87	09.91							
	2.0			01.88	09.91		24.2522-1707.3	040103		Nz 22,20		
	2.2			04.87	09.91							
	2.3			04.87	09.91							

AUDI 100 (68-76)

	1.7		21Z062041	09.71		+ Bremsgerät 2)	24.3526-0810.3	340037	1		Bremslichtschalter	
	1.9		21Z062041	09.71		+ Bremsgerät 2)						
	1.7			09.73	07.74	+ Automatikgetriebe 3)	24.3526-1900.0	340038	2		Bremslichtschalter	
	1.9			09.73	12.74	+ Automatikgetriebe 3)						
	1.6			01.75	07.76	+ Schaltgetriebe 4)	03.3526-2002.3	340010	1		Bremslichtschalter	
	1.7			09.73	07.74	+ Schaltgetriebe 4)						
	1.9			01.75	12.76	+ Schaltgetriebe 4)						
	1.6			01.75	12.76	+ Automatikgetriebe 3)	24.3526-1900.0	340038	2		Bremslichtschalter	
	1.9			01.75	12.76	+ Automatikgetriebe 3)						
	1.7		51Z000081			07.74 + USA	24.3526-1900.0	340038	2		Bremslichtschalter	
	1.9		51Z000081			12.76 + USA						
	1.7			01.71	09.74	+ Schaltgetriebe 4)	13.0460-4033.2	604033			20034 15,0	ATE
	1.9			01.71	09.74	+ Schaltgetriebe 4)						
	1.6 Limousine		31Z073209	01.75		+ Schaltgetriebe 4)	03.3215-0221.3	020013			Rz 15,87	
	1.6 Limousine		21Z089568	01.75		+ Automatikgetriebe 3)						
	1.7 Limousine		31Z073209	01.70		+ Schaltgetriebe 4)						
	1.7 Limousine		21Z089568	01.70		+ Automatikgetriebe 3)						
	1.9 Coupe		31Z077588	01.70		+ Schaltgetriebe 4)						
	1.9 Coupe		21Z089568	01.71		+ Automatikgetriebe 3)						
	1.9 Coupe			01.70	12.73	+ S						
	1.9 Limousine		31Z073209	01.71		+ Schaltgetriebe 4)						
1.9 Limousine		21Z089568	01.71		+ Automatikgetriebe 3)							

AUDI 100 (76-79)

	1.6		43-82300000	08.76			03.3526-2002.3	340010	1		Bremslichtschalter	
	2.0		43-82300000	06.76			24.3526-1900.0	340038	2		Bremslichtschalter	
	2.2		43-82300000	04.78		+ Schaltgetriebe 4)						
	2.2	85	43-72200000	03.77		+ S	24.3526-1900.0	340038	2		Bremslichtschalter	
	2.2	100	43-82300000	03.77		+ S	03.3526-2002.3	340010	1		Bremslichtschalter	
	2.2 i		43-72200000	03.77		- ABS J						
	2.2		43-82300000	04.78		+ Automatikgetriebe 3)	24.3526-1900.0	340038	2		Bremslichtschalter	
	2.2	85	43-82300000	03.77		+ S						
	2.2 i		43-82300000	03.77		+ ABS J						
	1.6			08.76	07.79		11.0441-4802.2	250017			Dichtungssatz	ATE
	2.0			06.76	07.78							
	2.2 i			03.77	07.79	+ S						

1) on the brake caliper / sulla pinza freno / sur l'étrier de frein / a la pinza de freno

2) + booster unit / + servofreno / + servo-frein / + servofreno

3) + autom.transmission / + scatola cambio automatico / + transmission automatique / + cambio automático

4) + manual transmission / + scatola cambio velocità / + transmission mécanique / + cambio de velocidad



































AUDI 100 (76-79)										
	1.6			08.76	07.79	24.0113-0160.1	413160			256 13,0 11,0 +B
	2.0			06.76	07.78					
	2.0 D			10.78	07.79					- belüftete Scheiben ¹⁾
	2.2			04.78	07.79					- belüftete Scheiben ¹⁾
	2.2	85		03.77	07.79					+
	2.0 D			10.78	07.79	24.0122-0118.1	422118			+ belüftete Scheiben ²⁾
	2.2			08.78	07.79					+ belüftete Scheiben ²⁾
	2.2	100		03.77	07.79					
	1.6			08.76	07.79	83.6124-0362.3	330715	2		L=360
	2.0		43-82300000	06.76						
	2.0 D			10.78	07.79	83.6134-0332.3	330716	2		L=330
	2.2			03.77	07.79					
	1.6			08.76	07.79	24.5204-0180.3	331461			L=180
	2.0			06.76	07.79	83.6224-0300.3	330730			L=300
	2.0 D			10.78	07.79					
	2.2			06.76	07.79					
	1.6			08.76	07.79	03.3215-2311.3	020018		+ GG ³⁾	Rz 15,87
	2.0			06.76	07.78	24.3215-0903.3	020154		+ ALU ⁴⁾	Rz 15,87
	2.0 D			10.78	07.79	03.3217-2112.3	020027		+ GG ³⁾	Rz 17,46
	2.2			03.77	07.79	24.3217-0908.3	020167		+ ALU ⁴⁾	Rz 17,46
	1.6		43-92000001		07.79	03.0137-0146.2	650146			200 x 40 HEB
	2.0 D		43-92000001	10.78	07.79	03.0137-9041.2	669041			Bremsbacken-Zubehör
	2.2		85 43-92000001		07.79					
	2.2	100		03.77	07.79	03.0137-0264.2	650264			230 x 40 HEB
	2.2			03.77	07.79	03.0137-9044.2	669044			Bremsbacken-Zubehör
	2.2	100		03.77	07.79	24.0223-0007.1	480037			230/231 x 45,8
	2.0 D			10.78	07.79	03.0420-0417.3	680417			17,46/200x40 Kit
	2.2		43-92000001	07.79						
	2.2		85 43-92000001		07.79					
	2.2			07.79						
	1.6			08.76	07.79	03.6565-0101.3	320097			BRL 6/5 (4)
	2.0			06.76	07.79					- Niveauregulierung ⁵⁾
	2.0 D			10.78	07.79					- Niveauregulierung ⁵⁾
	2.2			06.76	07.79					- Niveauregulierung ⁵⁾
	2.0 D			10.78	07.79	03.2419-9610.3	030029			Gz 19,05
	2.2			03.77	07.79					
	2.0 D			10.78	07.79	03.2522-4211.3	040017			Nz 22,20
	2.2			03.77	07.79					

AUDI 100 (80-81)										
	1.6		43-B-058000	08.79		11.0441-4802.2	250017			Dichtungssatz
	2.2	100		08.79	07.81	13.0460-2934.2	602934			20669 19,0 /S
	1.6			08.79	07.81	24.0113-0160.1	413160			256 13,0 11,0 +B
	1.9			08.80	07.81					
	2.0 D			08.79	07.81					
	2.2	85		08.79	07.81					
	2.2	100		08.79	07.81	24.0122-0118.1	422118			256 22,0 20,0 V +B
	1.6			08.79	07.81	83.6124-0362.3	330715	2		L=360
	1.9			08.80	07.81	83.6134-0332.3	330716	2		L=330
	2.0 D			08.79	07.81					
	2.2			08.79	07.81					
	1.6			08.79	07.81	24.5204-0180.3	331461			L=180
	1.9			08.80	07.81	83.6224-0300.3	330730			L=300
	2.0 D			08.79	07.81					
	2.2			08.79	07.81					
	1.6			08.79	07.81	03.3215-2311.3	020018		+ GG ³⁾	Rz 15,87
	1.9			08.80	07.81	24.3215-0903.3	020154		+ ALU ⁴⁾	Rz 15,87
	2.0 D			08.79	07.81	03.3217-2112.3	020027		+ GG ³⁾	Rz 17,46
	2.2			08.79	07.81	24.3217-0908.3	020167		+ ALU ⁴⁾	Rz 17,46
	1.6			08.79	07.81	03.0137-0146.2	650146			200 x 40 HEB
	1.9			08.80	07.81	03.0137-9041.2	669041			Bremsbacken-Zubehör
	2.0 D			08.79	07.81					
	2.2		85	08.79	07.81					
	2.2	100		08.79	07.81	03.0137-0264.2	650264			230 x 40 HEB
	2.2			08.79	07.81	03.0137-9164.2	669164			Bremsbacken-Zubehör
	2.2	100		08.79	07.81	24.0223-0007.1	480037			230/231 x 45,8
	1.9			08.80	07.81	03.0420-0417.3	680417			17,46/200x40 Kit
	2.0 D			08.79	07.81					
	2.2	85		08.79	07.81					

1) - ventilated discs / - dischi ventilati / - disques ventilés / - disco ventilado
2) - ventilated discs / + dischi ventilati / + disques ventilés / + disco ventilado
3) - cast iron / + ghisa / + fonte grise / + fundición de gris
4) - aluminium / + alluminio / + aluminium / + aluminio
5) - suspension level control / - correttore assetto / - correcteur d'assiette / - regulación altura suspensión



								
AUDI 100 (80-81)								
	1.6 1.9 2.0 D 2.2			08.79 07.81 08.80 07.81 08.79 07.81 08.79 07.81	- Niveauregulierung ¹⁾ - Niveauregulierung ¹⁾ - Niveauregulierung ¹⁾ - Niveauregulierung ¹⁾	03.6565-0101.3	320097	BRL 6/5 (4) ATE
	2.0 D 2.2			08.79 07.81 08.79 07.81		03.2419-9610.3	030029	Gz 19,05
	2.0 D 2.2			08.79 07.81 08.79 07.81		03.2522-4211.3	040017	Nz 22,20
AUDI 100 (82)								
	1.9 2.0 D 2.0 TD 2.2			08.81 07.82 08.81 07.82 11.81 07.82 08.81 07.82	+ belüftete Scheiben ²⁾ + belüftete Scheiben ²⁾	13.0460-2934.2	602934	20669 19,0 /S TRW
	1.6 1.9 2.0 D 2.2			08.81 07.82 08.81 07.82 08.81 07.82 08.81 07.82		24.0113-0160.1	413160	256 13,0 11,0 +B
	1.9 2.0 D 2.0 TD 2.2			08.81 07.82 08.81 07.82 11.81 07.82 08.81 07.82		24.0122-0118.1	422118	256 22,0 20,0 V +B
	1.6 1.9 2.0 D 2.0 TD 2.2			08.81 07.82 08.81 07.82 11.81 07.82 08.81 07.82		83.6124-0362.3 83.6134-0332.3	330715 330716	2 2 L=360 L=330
	1.6 1.9 2.0 D 2.0 TD 2.2			08.81 07.82 08.81 07.82 08.81 07.82 11.81 07.82 08.81 07.82		24.5204-0180.3 83.6224-0300.3	331461 330730	  L=180 L=300
	1.6 1.9 2.0 D 2.0 TD 2.2			08.81 07.82 08.81 07.82 11.81 07.82 08.81 07.82		03.3215-2311.3 24.3215-0903.3	020018 020154	+ GG ³⁾ + ALU ⁴⁾ Rz 15,87 Rz 15,87
	1.6 1.9 2.0 D 2.0 TD 2.2			08.81 07.82 08.81 07.82 08.81 07.82 11.81 07.82 08.81 07.82		03.3217-2112.3 24.3215-0903.3	020027 020154	+ GG ³⁾ + ALU ⁴⁾ Rz 17,46 Rz 15,87
	1.6 1.9 2.0 D 2.0 TD 2.2			08.81 07.82 08.81 07.82 08.81 07.82 11.81 07.82 08.81 07.82	- belüftete Scheiben ⁵⁾ - belüftete Scheiben/ -  ⁶⁾ - belüftete Scheiben ⁵⁾	03.0137-0146.2 03.0137-9041.2	650146 669041	200 x 40 HEB Bremsbacken-Zubehör
	1.9 2.0 D 2.0 TD 2.2	85		08.81 07.82 08.81 07.82 11.81 07.82 08.81 07.82	+ belüftete Scheiben ²⁾ + belüftete Scheiben/ +  ⁷⁾ + belüftete Scheiben ²⁾	03.0137-0264.2 03.0137-9044.2	650264 669044	230 x 40 HEB Bremsbacken-Zubehör VW VW
	1.9 2.0 D 2.0 TD 2.2	79 100		08.81 07.82 08.81 07.82 11.81 07.82 08.81 07.82	+ 	24.0223-0007.1	480037	230/231 x 45,8
	1.9 2.0 D 2.0 TD 2.2	79 100		08.81 07.82 08.81 07.82 11.81 07.82 08.81 07.82	- belüftete Scheiben ⁵⁾ - belüftete Scheiben/ -  ⁶⁾ - belüftete Scheiben ⁵⁾	03.0420-0417.3	680417	17,46/200x40 Kit VW
	1.6 1.9 2.0 D 2.0 TD 2.2			08.81 07.82 08.81 07.82 08.81 07.82 11.81 07.82 08.81 07.82	- Niveauregulierung ¹⁾ - Niveauregulierung ¹⁾ - Niveauregulierung ¹⁾ - Niveauregulierung ¹⁾ - Niveauregulierung ¹⁾	03.6565-0101.3	320097	BRL 6/5 (4) ATE
	2.0 D 2.0 TD 2.2 i			08.81 07.82 11.81 07.82 08.81 07.82		03.2419-9610.3	030029	Gz 19,05
	2.0 D 2.0 TD 2.2 i			08.81 07.82 11.81 07.82 08.81 07.82		03.2522-4211.3	040017	Nz 22,20
AUDI 100 (83-90)								
	1.8 2.0 2.0 TD 2.4 D 2.5 TDI 2.2 2.2 Turbo 2.3	◀ ◀ ◀ ◀ ◀ 100		08.89 12.90 08.89 12.90 08.89 12.90 08.89 12.90 01.90 12.90 08.82 12.90 08.86 12.90 10.83 12.90		03.7750-0302.4	300071	9" ATE
						10.0124-3202.3	340011	Hydraulik Verstärker

¹⁾ - suspension level control / - correttore assetto / - correcteur d'assiette / - regulación altura suspensión
²⁾ + ventilated discs / + dischi ventilati / + disques ventilés / + disco ventilado
³⁾ + cast iron / + ghisa / + fonte grise / + fundición de gris
⁴⁾ + aluminium / + alluminio / + aluminium / + aluminio
⁵⁾ - ventilated discs / - dischi ventilati / - disques ventilés / - disco ventilado
⁶⁾ - ventilated discs/ -  / - dischi ventilati/ -  / - disques ventilés/ -  / - disco ventilado/ - 
⁷⁾ + ventilated discs/ +  / + dischi ventilati/ +  / + disques ventilés/ +  / + disco ventilado/ + 



AUDI 100 (83-90)											
🔧	1.8		44-J-300000	01.88		03.2122-8012.3	010156		ThZ 22,20	ATE	
	1.8 Limousine			08.82	12.87 + Schaltgetriebe ¹⁾						
	1.9 Limousine			08.82	07.84 + Schaltgetriebe ¹⁾						
	2.0 D Limousine			08.82	12.87						
	2.0 TD Limousine			08.82	12.87 + Schaltgetriebe ¹⁾						
🚗	1.8 Avant			08.82	12.87 - verstärktes Fahrwerk ²⁾	03.2123-8512.3	010194		ThZ 23,81	ATE	
	1.8 Limousine			08.82	12.87 + Automatikgetriebe ³⁾						
	1.9 Avant			08.82	07.84 - verstärktes Fahrwerk ²⁾						
	1.9 Limousine			08.82	07.84 + Automatikgetriebe ³⁾						
	2.0			08.84	12.87						
	2.0 D Avant			08.82	12.87 - verstärktes Fahrwerk ²⁾						
	2.0 TD Avant			08.82	12.87 - verstärktes Fahrwerk ²⁾						
	2.0 TD Limousine			08.82	12.87 + Automatikgetriebe ³⁾						
	2.2	85		08.82	09.86						
	2.2	100		08.82	07.84						
	2.3			10.83	07.84						
🔧	1.8		44-K-300001		12.90 - ABS	03.2122-9612.3	010159		ThZ 22,20	ATE	
	2.0			01.88	12.90 - ABS						
	2.0 D			01.88	07.89 - ABS						
	2.0 TD			01.88	12.90 - ABS						
	2.4 D			08.89	12.90 - ABS						
	2.5 TDI			01.90	12.90 - ABS						
	1.8 Avant			08.82	12.90 + verstärktes Fahrwerk ⁴⁾	03.2123-0566.3	010169		ThZ 23,81	ATE	
	1.9 Avant			08.82	12.90 + verstärktes Fahrwerk ⁴⁾						
	2.0 D Avant			08.82	12.90 + verstärktes Fahrwerk ⁴⁾						
🚗	2.0 TD Avant	100		08.82	12.90 + verstärktes Fahrwerk ⁴⁾						
	2.2			08.84	12.90						
	2.2 Turbo Limousine			08.86	12.90						
	2.3			08.84	12.90						
	2.2 Turbo Avant			08.86	12.90	03.2125-3210.3	010212		ThZ 25,40	ATE	
🔧	1.8 Limousine		44-H-073660	08.82		24.3541-1609.5	240039	☐	D=54, - Halter	TRW	
	1.9 Limousine			08.82	07.84	24.3541-1610.5	240040	☐	D=54, - Halter	TRW	
	2.0 D Limousine			08.82	07.84	11.0441-5405.2	250030		Dichtungssatz	ATE	
	2.0 TD Limousine			08.82	07.84	11.0101-5409.2	260035		Hülsensatz	ATE	
						11.8171-0008.1	990049		Führungsbolzen	ATE	
						24.0101-4301.2	260047		Bremssattel-Zubehör	TRW	
						11.0101-5403.2	260010		Faltenbalgsatz	TRW	
	1.8 Limousine		44-H-073661		12.90	24.3541-1609.5	240039	☐	D=54, - Halter	TRW	
						24.3541-1610.5	240040	☐	D=54, - Halter	TRW	
						11.0441-5405.2	250030		Dichtungssatz	ATE	
						11.0101-5409.2	260035		Hülsensatz	ATE	
						11.8171-0008.1	990049		Führungsbolzen	ATE	
						24.0101-4301.2	260047		Bremssattel-Zubehör	TRW	
						11.0101-5403.2	260010		Faltenbalgsatz	TRW	
	1.8 Avant		44-H-073660	08.82		24.3541-1719.5	240057	☐	D=54, - Halter	TRW	
	1.9 Avant			08.82	07.84	24.3541-1720.5	240058	☐	D=54, - Halter	TRW	
	2.0		44-H-073660	08.84		11.0441-5405.2	250030		Dichtungssatz	ATE	
	2.0 D		44-H-073660	08.84		11.0101-5409.2	260035		Hülsensatz	ATE	
	2.0 D Avant			08.82	07.84	11.8171-0008.1	990049		Führungsbolzen	ATE	
	2.0 TD		44-H-073660	08.84		24.0101-4301.2	260047		Bremssattel-Zubehör	TRW	
	2.0 TD Avant			08.82	07.84	11.0101-5403.2	260010		Faltenbalgsatz	TRW	
	2.2		44-H-073660	08.82							
	2.2	85	44-H-073661			11.3541-8521.2	220113	☐	D=54, - Halter	ATE	
	2.2	100	44-H-073661			24.3541-1719.5	240057	☐	D=54, - Halter	TRW	
	2.3		44-H-073661			24.3541-1720.5	240058	☐	D=54, - Halter	TRW	
			44-H-073661			12.90	11.0441-5405.2	250030		Dichtungssatz	ATE
			44-H-073661			09.86	11.0101-5409.2	260035		Hülsensatz	ATE
			44-H-073661			12.90 für 4-Loch-Felge ⁵⁾	11.8171-0008.1	990049		Führungsbolzen	ATE
			44-H-073661			12.90 für 4-Loch-Felge ⁵⁾	24.0101-4301.2	260047		Bremssattel-Zubehör	TRW
			44-H-073661			12.90	11.0101-5403.2	260010		Faltenbalgsatz	TRW
				08.89	12.90						
2.2 CS	100	44-G-073363	08.84		24.3541-1719.5	240057	☐	D=54, - Halter	TRW		
2.3 CS		44-G-073363	10.83		24.3541-1720.5	240058	☐	D=54, - Halter	TRW		
					24.0101-4301.2	260047		Bremssattel-Zubehör	TRW		
					11.0101-5403.2	260010		Faltenbalgsatz	TRW		
🔧	1.8			08.82	12.90	13.0460-2925.2	602925		20901 19,0 +WK/S	TRW	
	1.9			08.82	07.84						
	2.0			08.84	12.90						
	2.0 D			08.82	07.89						
	2.0 TD			08.82	12.90						
	2.2	85		08.82	09.86						
	2.2	100		08.82	12.90 für 4-Loch-Felge ⁵⁾						
	2.2 CS	100	44-G-073363	08.82							
	2.3			10.83	12.90 für 4-Loch-Felge ⁵⁾						
	2.4 D			08.89	12.90						
	2.2	100		08.82	12.90 für 5-Loch-Felge ⁶⁾	13.0460-2963.2	602963		21138 18,8 +WK/S	TRW	
	2.2 CS	100	44-G-073364	44-K-045093							
	2.2 Turbo			44-K-045093	08.86						
	2.3			10.83	12.90 für 5-Loch-Felge ⁶⁾						
	2.3 CS			44-K-045093	10.83						
2.2 CS	100	44-K-045094			12.90	13.0460-5403.2	605403		21211 18,7 +WE	ATE	
2.2 Turbo		44-K-045094			12.90	13.0460-2963.2	602963		21138 18,8 +WK/S	TRW	
2.3 CS		44-K-045094			12.90						
2.5 TDI				01.90	12.90						

¹⁾ + manual transmission / + scatola cambio velocità / + transmission mécanique / + cambio de velocidad

²⁾ - reinforced suspension / - sospensione rinforzata / - châssis renforcé / - suspensión reforzada

³⁾ + autom.transmission / + scatola cambio automatico / + transmission automatique / + cambio automatico

⁴⁾ + reinforced suspension / + sospensione rinforzata / + châssis renforcé / + suspensión reforzada

⁵⁾ for 4 bore wheel rim / per cerchione a 4 fori / pour jante à 4 trous / para Liantas de 4 taladros

⁶⁾ for 5 bore wheel rim / per cerchione a 5 fori / pour jante à 5 trous / para Liantas de 5 taladros

















AUDI 100 (83-90)

	1.8 Limousine			08.82	12.90	24.0113-0160.1	413160		256 13,0 11,0 +B
	1.9 Limousine			08.82	07.84				
	2.0 D Limousine			08.82	07.84				
	2.0 TD Limousine			08.82	07.84				
	1.8 Avant			08.82	12.90	24.0122-0118.1	422118		256 22,0 20,0 V +B
	1.9 Avant			08.82	07.84				
	2.0			08.84	12.90				
	2.0 D			08.84	07.89				
	2.0 D Avant			08.82	07.84				
	2.0 TD			08.84	12.90				
2.0 TD Avant			08.82	07.84					
2.2	85		08.82	09.86					
2.2	100		08.82	12.90	für 4-Loch-Felge ¹⁾				
2.3			10.83	12.90	für 4-Loch-Felge ¹⁾				
2.4 D			08.89	12.90					
2.2 CS	100	44-G-073363	08.82		24.0122-0120.1	422120		280 22,0 20,0 V L	
2.3 CS		44-G-073363	10.83						
2.2	100		08.82	12.90	24.0125-0102.1	425102		276 25,0 23,0 V L	
2.2 CS	100	44-G-073364		12.90					
2.2 Turbo			08.86	12.90					
2.3			10.83	12.90	für 5-Loch-Felge ²⁾				
2.3 CS		44-G-073364		12.90					
2.5 TDI			01.90	12.90					
	1.8		44-G-200000	08.82		83.6224-0300.3	330730	2	L=300
	1.9			08.82	07.84				
	2.0		44-G-200000	08.84					
	2.0 D		44-G-200000	08.82					
	2.0 TD		44-G-200000	08.82					
	2.2	85	44-G-200000	08.82					
	2.2	100	44-G-200000	08.82					
	2.2 CS	100	44-F-150000	08.82					
	2.3		44-G-200000	10.83					
	2.3 CS		44-F-150000	10.83					
2.2 CS	100	44-G-000001	44-G-200000		83.6134-0332.3	330716	2	L=330	
2.3 CS		44-G-000001	44-G-200000						
1.8		44-G-200001		12.90	- verstärktes Fahrwerk ³⁾	24.5170-0315.3	331309	2	L=315
2.0		44-G-200001		12.90	- verstärktes Fahrwerk ³⁾				
2.0 D		44-G-200001		07.89	- verstärktes Fahrwerk ³⁾				
2.0 TD		44-G-200001		12.90	- verstärktes Fahrwerk ³⁾				
2.2	85	44-G-200001		09.86	- verstärktes Fahrwerk ³⁾				
2.2	100	44-G-200001		12.90	- verstärktes Fahrwerk ³⁾				
2.2 Turbo			08.86	12.90	- verstärktes Fahrwerk ³⁾				
2.3		44-G-200001		12.90	- verstärktes Fahrwerk ³⁾				
2.4 D			08.89	12.90	- verstärktes Fahrwerk ³⁾				
2.5 TDI			01.90	12.90	- verstärktes Fahrwerk ³⁾				
1.8		44-G-200001		12.90	+ verstärktes Fahrwerk ⁴⁾	24.5113-0380.3	331344	2	L=382
2.0		44-G-200001		12.90	+ verstärktes Fahrwerk ⁴⁾				
2.0 D		44-G-200001		07.89	+ verstärktes Fahrwerk ⁴⁾				
2.0 TD		44-G-200001		12.90	+ verstärktes Fahrwerk ⁴⁾				
2.2	85	44-G-200001		09.86	+ verstärktes Fahrwerk ⁴⁾				
2.2	100	44-G-200001		12.90	+ verstärktes Fahrwerk ⁴⁾				
2.2 Turbo			08.86	12.90	+ verstärktes Fahrwerk ⁴⁾				
2.3		44-G-200001		12.90	+ verstärktes Fahrwerk ⁴⁾				
2.4 D			08.89	12.90	+ verstärktes Fahrwerk ⁴⁾				
2.5 TDI			01.90	12.90	+ verstärktes Fahrwerk ⁴⁾				
	1.8	44-E-000001	44-J-039012		+ ABS	24.0101-3601.2	260044		Bremssattel-Zubehör TRW
	1.9	44-E-000001	44-J-039012		+ ABS				
	2.0		44-J-039012	08.84	+ ABS				
	2.0 D		44-E-000001	44-J-039012		+ ABS			
	2.0 TD		44-E-000001	44-J-039012		+ ABS			
	2.2	85	44-E-000001		09.86	+ ABS			
	2.2	100	44-E-000001	44-J-039012					
	2.2 Turbo			44-J-039012	08.86				
	2.3			44-J-039012	10.83				
	2.2 CS	100		08.82	12.87	24.3434-1701.5	240357	<input type="checkbox"/>	D=43, - Halter TRW
2.3 CS			10.83	12.87	24.3434-1702.5	240358	<input type="checkbox"/>	D=43, - Halter TRW	
					11.0101-5403.2	260010	<input type="checkbox"/>	Faltenbalgsatz TRW	
1.8		44-J-039013		12.90	+ ABS	24.3384-1601.5	240013	<input type="checkbox"/>	D=38, - Halter TRW
2.0		44-J-039013		12.90	+ ABS	24.3384-1602.5	240014	<input type="checkbox"/>	D=38, - Halter TRW
2.0 D		44-J-039013		07.89	+ ABS	24.0101-3601.2	260044		Bremssattel-Zubehör TRW
2.0 TD		44-J-039013		12.90	+ ABS				
2.2	100	44-J-039013		12.87					
2.2	100		01.88	12.90					
2.2 Turbo		44-J-039013		12.90					
2.3		44-J-039013		12.87					
2.3			01.88	12.90					
2.4 D			08.89	12.90					
2.5 TDI			01.90	12.90					
	1.8			08.82	12.90	+ ABS	13.0460-3602.2	603602	21144 15,8 /S TRW
	1.9			08.82	07.84	+ ABS			
	2.0			08.84	12.90	+ ABS			
	2.0 D			08.82	07.89	+ ABS			
	2.0 TD			08.82	12.90	+ ABS			
	2.2	85		08.82	09.86	+ ABS			
	2.2	100		08.82	12.90				
2.2 Turbo			08.86	12.90					

¹⁾ for 4 bore wheel rim / per cerchione a 4 fori / pour jante à 4 trous / para Liantas de 4 taladros
²⁾ for 5 bore wheel rim / per cerchione a 5 fori / pour jante à 5 trous / para Liantas de 5 taladros
³⁾ - reinforced suspension / - sospensione rinforzata / - châssis renforcé / - suspensión reforzada
⁴⁾ + reinforced suspension / + sospensione rinforzata / + châssis renforcé / + suspensión reforzada

AUDI 100 (83-90)													
													
	2.3 2.4 D 2.5 TDI			10.83 08.89 01.90	12.90 12.90 + ABS 12.90	13.0460-3602.2	603602					21144 15,8 / S	TRW
	1.8 1.9 2.0 2.0 D 2.0 TD 2.2 2.2 2.3			08.82 08.82 08.84 08.82 08.82 08.82 08.82 10.83	12.87 + ABS 12.87 + ABS 12.87 + ABS 12.87 + ABS 12.87 + ABS 09.86 + ABS 12.87 12.87	24.0110-0178.1	410178					245 10,0 8,0 + B	
	2.2 CS 2.2 Turbo 2.3 CS	85 100		08.82 08.86 10.83	12.87 12.87 12.87	24.0110-0154.1	410154					245 10,0 8,0	
	1.8 2.0 2.0 D 2.0 TD 2.2 2.3 2.4 D 2.5 TDI	100		01.88 01.88 01.88 01.88 01.88 01.88 08.89 01.90	12.90 + ABS 12.90 + ABS 07.89 + ABS 12.90 + ABS 12.90 + 14" Rad 1) 12.90 + 14" Rad 1) 12.90 + ABS 12.90 + 14" Rad 1)	24.0110-0200.1	410200					245 10,0 8,0	
	2.2 CS 2.2 Turbo 2.3 2.3 CS 2.5 TDI	100		01.88 01.88 10.83 01.88 01.90	12.90 + 15" Rad 2) 12.90 + 15" Rad 2) 12.90 + 15" Rad 2) 12.90 + 15" Rad 2) 12.90 + 15" Rad 2)	24.0110-0154.1	410154					245 10,0 8,0	
	1.8 1.9 2.0 D 2.0 TD 2.2	85		08.82 08.82 08.82 08.82 08.82	07.84 + HA-Trommelbremse 3) 07.84 + HA-Trommelbremse 3) 07.84 + HA-Trommelbremse 3) 07.84 + HA-Trommelbremse 3) 07.84 + HA-Trommelbremse 3)	83.6204-0240.3	330718	2				L=240	
	1.8 2.0 2.0 D 2.0 TD 2.2	85	44-G-073362 44-G-073362 44-G-073362 44-G-073362 44-G-073362	08.84 08.84 08.82 08.82 08.84	+ HA-Trommelbremse 3) + HA-Trommelbremse 3) + HA-Trommelbremse 3) + HA-Trommelbremse 3) + HA-Trommelbremse 3)	24.5204-0180.3	331461	2				L=180	
	1.8 2.0 2.0 D 2.0 TD 2.2	85	44-G-073363 44-G-073363 44-G-073363 44-G-073363 44-G-073363	07.89 07.89 07.89 07.89 09.86	+ HA-Trommelbremse 3) + HA-Trommelbremse 3) + HA-Trommelbremse 3) + HA-Trommelbremse 3) + HA-Trommelbremse 3)	83.6204-0240.3	330718	2				L=240	
	1.8 2.0 2.0 D 2.4 D			08.89 08.89 08.89 08.89	12.90 + HA-Trommelbremse 3) 12.90 + HA-Trommelbremse 3) 12.90 + HA-Trommelbremse 3) 12.90 + HA-Trommelbremse 3)	24.5204-0180.3	331461	2				L=180	
	1.8 1.9 2.0 2.0 D 2.0 TD 2.2 2.2 2.3	85 100		08.82 08.82 08.82 08.82 08.82 08.82 10.83	12.85 + HA-Scheibenbremse 4) 12.85 + HA-Scheibenbremse 4) 12.85 + HA-Scheibenbremse 4) 12.85 + HA-Scheibenbremse 4) 12.85 + HA-Scheibenbremse 4) 12.85 + HA-Scheibenbremse 4) 12.85	83.6204-0240.3 83.6301-0150.3 83.6134-0332.3	330718 330342 330716		<input type="checkbox"/> am Bremssattel 5) <input type="checkbox"/> am Bremssattel 5)			L=240 L=150 L=330	
	1.8 2.0 2.0 D 2.0 TD 2.2 2.2 2.2 Turbo 2.3	85 100		01.86 01.86 01.86 01.86 01.86 08.86 01.86	07.89 + HA-Scheibenbremse 4) 07.89 + HA-Scheibenbremse 4) 07.89 + HA-Scheibenbremse 4) 07.89 + HA-Scheibenbremse 4) 09.86 + HA-Scheibenbremse 4) 07.89 07.89	83.6204-0240.3 24.5113-0220.3	330718 331318	2 2	am Bremssattel 5)			L=240 L=220	
	1.8 2.0 2.0 TD 2.2 2.2 Turbo 2.3 2.4 D 2.5 TDI	100		08.89 08.89 08.89 08.89 08.89 08.89 08.89 01.90	12.90 + HA-Scheibenbremse 4) 12.90 + HA-Scheibenbremse 4) 12.90 + HA-Scheibenbremse 4) 12.90 12.90 12.90 12.90 + HA-Scheibenbremse 4) 12.90	24.5204-0180.3 24.5113-0220.3	331461 331318	2 2	am Bremssattel 5)			L=180 L=220	
	1.8 1.9 2.0 2.0 D 2.0 TD 2.2 2.4 D	85		08.82 08.82 08.84 08.82 08.82 08.82 08.89	12.90 - ABS 07.84 - ABS 12.90 - ABS 07.89 - ABS 12.90 - ABS 09.86 - ABS 12.90 - ABS	03.3217-2112.3	020027					Rz 17,46	
	1.8 1.9 2.0 2.0 D 2.0 TD 2.2 2.4 D	85		08.82 08.82 08.84 08.82 08.82 08.82 08.89	12.90 - ABS 07.84 - ABS 12.90 - ABS 07.89 - ABS 12.90 - ABS 09.86 - ABS 12.90 - ABS	03.0137-0264.2 03.0137-9044.2	650264 669044					230 x 40 HEB Bremsbacken-Zubehör	VW VW

1) + 14" wheel / + ruota 14" / + roue 14" / + rueda 14"

2) + 15" wheel / + ruota 15" / + roue 15" / + rueda 15"

3) + RA drum brake / + P freno a tamburo / + frein à tambour essieu AR / + ET-tambores de freno

4) + RA disc brake / + P disco freno / + frein à disque essieu AR / + ET-disco de freno

5) on the brake caliper / sulla pinza freno / sur l'étrier de frein / a la pinza de freno

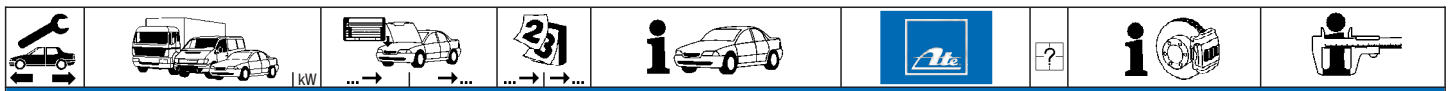

















AUDI 100 (83-90)

	1.8		08.82	12.87	- ABS	24.0223-0007.1	480037		230/231 x 45,8
	1.9		08.82	07.84	- ABS				
	2.0		08.84	12.87	- ABS				
	2.0 D		08.82	12.87	- ABS				
	2.0 TD		08.82	12.87	- ABS				
	2.2	85	08.82	09.86	- ABS				
	1.8		01.88	12.90	- ABS	24.0223-0011.1	480041		230/231 x 45,8
	2.0		01.88	12.90	- ABS				
	2.0 D		01.88	07.89	- ABS				
	2.0 TD		01.88	12.90	- ABS				
	2.4 D		08.89	12.90	- ABS				
	1.8		08.82	12.90	- ABS	03.0420-1217.3	681217		17,46/230x40 Kit VW
	1.9		08.82	07.84	- ABS				
	2.0		01.88	12.90	- ABS				
	2.0 D		01.88	07.89	- ABS				
	2.0 TD		03.88	12.90	- ABS				
	2.2	85	08.82	09.86	- ABS				
2.4 D		08.89	12.90	- ABS					
	1.8		08.82	12.90		24.3727-0119.2	580119	2 + HA-Trommelbremse ¹⁾	L=1395
	1.9		08.82	07.84					
	2.0		08.84	12.90					
	2.0 D		08.82	07.89					
	2.0 TD		08.82	12.90					
	2.2	85	08.82	09.86					
2.4 D		08.89	12.90						
	1.8		08.82	12.87		24.3727-0138.2	580138	2 + HA-Scheibenbremse ²⁾	L=1438
	1.9		08.82	07.84					
	2.0		08.84	12.87					
	2.0 D		08.82	12.87					
	2.0 TD		08.82	12.87					
	2.2	85	08.82	09.86					
	2.2	100	08.82	12.87					
	2.2 Turbo		08.86	12.87					
	2.3		10.83	12.87					
	2.4 D		01.88	12.90					
2.5 TDI		01.90	12.90						
	1.8		01.88	12.90		24.3727-0130.2	580130	2 + HA-Scheibenbremse ²⁾	L=1455
	2.0		01.88	12.90					
	2.0 D		01.88	07.89					
	2.0 TD		01.88	12.90					
	2.2	100	01.88	12.90					
	2.2 Turbo		01.88	12.90					
	2.3		01.88	12.90					
	2.4 D		08.89	12.90					
	2.5 TDI		01.90	12.90					
	1.8		08.82	12.90	- Niveauregulierung ³⁾	03.6585-0108.3	320115		BRL 8/5 (4) ATE
	1.9		08.82	07.84	- Niveauregulierung ³⁾				
	2.0		08.84	12.90	- Niveauregulierung ³⁾				
	2.0 D		08.82	07.89	- Niveauregulierung ³⁾				
	2.0 TD		08.82	12.90	- Niveauregulierung ³⁾				
	2.2	85	08.82	09.86	- Niveauregulierung ³⁾				
	2.2	100	08.82	12.90	- Niveauregulierung ³⁾				
	2.2 Turbo		08.86	12.90	- Niveauregulierung ³⁾				
	2.3		10.83	12.90	- Niveauregulierung ³⁾				
	2.4 D		08.89	12.90	- Niveauregulierung ³⁾				
2.5 TDI		01.90	12.90	- Niveauregulierung ³⁾					
	1.8		01.88	12.90		03.2419-9610.3	030029		Gz 19,05
	2.0		08.84	12.90					
	2.0 D		08.82	07.89					
	2.0 TD		08.82	12.90					
	2.2	100	08.82	12.90					
	2.2 Turbo		08.86	12.90					
2.3		10.83	12.90						
2.4 D		08.89	12.90						
2.5 TDI		01.90	12.90						
	2.0		08.84	12.87		03.2522-4211.3	040017		Nz 22,20
	2.0 D		08.82	12.87					
	2.0 TD		08.82	12.87					
	2.2	100	08.82	12.87					
	2.2 Turbo		08.86	12.87					
	2.3		10.83	12.87					
	1.8		01.88	12.90		24.2522-1707.3	040103		Nz 22,20
	2.0		01.88	12.90					
	2.0 D		01.88	07.89					
	2.0 TD		01.88	12.90					
	2.2	100	01.88	12.90					
	2.2 Turbo		01.88	12.90					
2.3		01.88	12.90						
2.4 D		08.89	12.90						
2.5 TDI		01.90	12.90						
	1.8		08.82	12.87		24.3728-0115.2	590115		L=1264

¹⁾ + RA drum brake / + P freno a tamburo / + frein à tambour essieu AR / + ET-tambores de freno

²⁾ + RA disc brake / + P disco freno / + frein à disque essieu AR / + ET-disco de freno

³⁾ - suspension level control / - correttore assetto / - correcteur d'assiette / - regulación altura suspensión



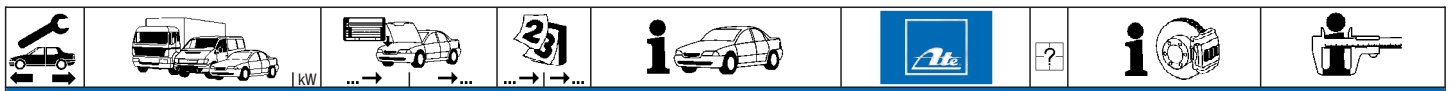



















										
AUDI 100 (91-94)										
	1.6 2.0 2.0 16V 2.3 2.4 D 2.5 TDI 2.6 2.8			03.92 07.93 12.90 07.94 01.92 07.94 12.90 07.94 05.91 07.94 06.91 07.94 04.92 07.94 12.90 07.94		03.2123-0491.3 24.2123-1602.3	010167 010384	- ABS + ABS	THz 23,81 THz 23,81	ATE TRW
	1.6 2.0 2.0 16V 2.3 2.4 D 2.5 TDI		03.92 07.93 12.90 07.94 01.92 07.94 12.90 07.94 05.91 07.94 06.91 07.94		24.3571-8505.5 24.3571-8506.5 11.0441-5704.2 11.0101-5409.2 11.8171-0008.1 11.8116-0143.1	240489 240490 250034 260035 990049 390513	<input type="checkbox"/> <input type="checkbox"/> <input type="checkbox"/> <input type="checkbox"/> <input type="checkbox"/> <input type="checkbox"/>	2 2 2	D=57, - Halter D=57, - Halter Dichtungssatz Hülensatz Führungsbolzen Haltefeder	ATE ATE ATE ATE ATE ATE
	2.6 2.8		04.92 07.94 12.90 07.94		11.3571-8508.2 24.3571-8507.5 24.3571-8508.5 11.0441-5704.2 11.8170-0306.1 11.0101-5409.2 11.8171-0008.1 11.8116-0143.1	220128 240555 240556 250034 260102 260035 990049 390513	<input type="checkbox"/> <input type="checkbox"/> <input type="checkbox"/> <input type="checkbox"/> <input type="checkbox"/> <input type="checkbox"/> <input type="checkbox"/> <input type="checkbox"/>	2 2	D=57, - Halter D=57, - Halter D=57, - Halter Dichtungssatz Halter Hülensatz Führungsbolzen Haltefeder	ATE ATE ATE ATE ATE ATE ATE ATE
	1.6 2.0 2.0 16V 2.3 2.4 D 2.5 TDI 2.6 2.8		03.92 07.93 12.90 07.94 01.92 07.94 12.90 07.94 05.91 07.94 06.91 07.94 04.92 07.94 12.90 07.94		13.0460-7050.2	607050			20678 19,5 +/WK	ATE
	1.6 2.0 2.0 16V 2.3 2.4 D 2.5 TDI		03.92 07.93 12.90 07.94 01.92 07.94 12.90 07.94 05.91 07.94 06.91 07.94		24.0115-0105.1 24.0315-0105.1	415105 515105			288 15,0 13,0 L +B 288 15,0 13,0 L +B PD	
	2.6 2.8		04.92 07.94 12.90 07.94		24.0125-0105.1 24.0325-0105.1	425105 525105			288 25,0 23,0 V L +S +B 288 25,0 23,0 V L +B PD	
	1.6 2.0 2.0 16V 2.3 2.4 D 2.5 TDI 2.6 2.8		03.92 07.93 12.90 07.94 01.92 07.94 12.90 07.94 05.91 07.94 06.91 07.94 04.92 07.94 12.90 07.94		24.5237-0273.3	331444	2		L=273	
	1.6 2.0 2.0 16V 2.3 2.4 D 2.5 TDI 2.6 2.8		03.92 07.93 12.90 07.94 01.92 07.94 12.90 07.94 05.91 07.94 06.91 07.94 04.92 07.94 12.90 07.94	4A-P-078948 4A-P-078948 4A-P-078948 4A-P-078948 4A-P-078948 4A-P-078948 4A-P-078948 4A-P-078948	+ ABS + ABS + ABS	24.3384-1601.5 24.3384-1602.5 24.0101-3601.2	240013 240014 260044	<input type="checkbox"/> <input type="checkbox"/> <input type="checkbox"/> <input type="checkbox"/> <input type="checkbox"/> <input type="checkbox"/> <input type="checkbox"/> <input type="checkbox"/>	D=38, - Halter D=38, - Halter Bremsattel-Zubehör	TRW TRW TRW
	1.6 2.0 2.0 16V 2.3 2.4 D 2.4 D 2.5 TDI 2.6 2.8	4A-P-078949 4A-P-078949 4A-P-078949 4A-P-078949 4A-P-078949 4A-P-078949 4A-P-078949	07.93 07.93 07.93 07.93 06.93 + ABS 07.93 07.93 07.94	+ ABS + ABS + ABS	24.3384-1709.5 24.3384-1710.5	240257 240258	<input type="checkbox"/> <input type="checkbox"/> <input type="checkbox"/> <input type="checkbox"/> <input type="checkbox"/> <input type="checkbox"/> <input type="checkbox"/> <input type="checkbox"/>		D=38, - Halter D=38, - Halter	TRW TRW
	1.6 2.0 2.0 16V 2.3 2.4 D 2.4 D 2.5 TDI 2.6 2.8		03.92 07.93 12.90 06.93 07.93 07.94 01.92 07.94 12.90 07.94 05.91 06.93 07.93 07.94 06.91 07.94 04.92 07.94 12.90 07.94	+ ABS + ABS + ABS	13.0460-3602.2	603602			21144 15,8 /S	TRW
	1.6 2.0 2.0 16V 2.3 2.4 D 2.4 D 2.5 TDI 2.6 2.8		03.92 07.93 12.90 06.93 07.93 07.94 01.92 07.94 12.90 07.94 05.91 06.93 07.93 07.94 06.91 07.94 04.92 07.94 12.90 07.94	+ ABS + ABS + ABS	24.0110-0201.1 24.0310-0201.1	410201 510201			245 10,0 8,0 +B 245 10,0 8,0 +B PD	



AUDI 100 (91-94)

	1.6 2.0 2.0 2.4 D	74 85		03.92 07.93 - ABS 12.90 06.93 - ABS 12.90 06.93 - ABS 05.91 06.93 - ABS	24.5204-0180.3	331461	2		L=180
	1.6 2.0 2.0 2.0 2.0 2.0 16V 2.3 2.4 D 2.4 D 2.5 TDI 2.6 2.8	74 74 85 85		03.92 07.93 + ABS 12.90 06.93 + ABS 07.93 07.94 12.90 06.93 + ABS 07.93 07.94 01.92 07.94 12.90 07.94 05.91 06.93 + ABS 07.93 07.94 06.91 07.94 04.92 07.94 12.90 07.94	24.5204-0180.3 24.5113-0220.3	331461 331318	2 2	am Bremsattel 1)	L=180 L=220
	1.6 2.0 2.0 2.4 D	74 85		03.92 07.93 - ABS 12.90 07.93 - ABS 12.90 07.93 - ABS 05.91 07.93 - ABS	24.3220-0909.3	020210			Rz 20,64
	1.6 2.0 2.0 2.4 D	74 85		03.92 07.93 - ABS 12.90 07.93 - ABS 12.90 07.93 - ABS 05.91 07.93 - ABS	03.0137-0264.2 03.0137-9164.2	650264 669164			230 x 40 HEB Bremsbacken-Zubehör
	1.6 2.0 2.0 2.4 D	74 85		03.92 07.93 - ABS 12.90 06.93 - ABS 12.90 06.93 - ABS 05.91 06.93 - ABS	24.0223-0014.1	480065			230/231 x 51
	1.6 2.0 2.0 2.4 D	74 85		03.92 07.93 - ABS 12.90 07.93 - ABS 12.90 07.93 - ABS 05.91 07.93 - ABS	03.0520-6120.3	696120			20,64/230x40 TopKit
	1.6 2.0 2.0 2.4 D	74 85		03.92 07.93 - ABS 12.90 07.93 - ABS 12.90 07.93 - ABS 05.91 07.93 - ABS	24.3727-0141.2	580141	2		L=1420
	1.6 2.0 2.0 2.0 16V 2.3 2.4 D 2.5 TDI 2.6 2.8	74 85	4A-P-078948 4A-P-078948 4A-P-078948 4A-P-078948 4A-P-078948 4A-P-078948 4A-P-078948 4A-P-078948 4A-P-078948	03.92 07.93 + ABS 12.90 07.93 + ABS 12.90 07.93 + ABS 01.92 07.94 12.90 07.94 05.91 07.94 + ABS 06.91 07.94 04.92 07.94 12.90 07.94	24.3727-0142.2	580142	2		L=1476
	1.6 2.0 2.0 2.0 2.0 16V 2.3 2.4 D 2.4 D 2.5 TDI 2.6 2.8	74 74 85 85	4A-P-078949 4A-P-078949 4A-P-078949 4A-P-078949 4A-P-078949 4A-P-078949 4A-P-078949 4A-P-078949 4A-P-078949	07.93 07.94 + ABS 06.93 07.94 + ABS 07.93 07.94 + ABS 07.93 07.94 07.93 07.94 07.93 07.94 + ABS 07.93 07.94 07.94 07.94 07.94	24.3727-0154.2	580154	2		L=1491
	1.6 2.0 2.0 16V 2.3 2.4 D 2.5 TDI 2.6 2.8			03.92 07.93 12.90 07.94 - Niveauregulierung 2) 01.92 07.94 - Niveauregulierung 2) 12.90 07.94 - Niveauregulierung 2) 05.91 07.94 - Niveauregulierung 2) 06.91 07.94 - Niveauregulierung 2) 04.92 07.94 - Niveauregulierung 2) 12.90 07.94 - Niveauregulierung 2)	03.6585-0108.3	320115			BRL 8/5 (4)
	1.6 2.0 2.0 2.0 16V 2.0 16V 2.3 2.3 2.4 D 2.4 D 2.5 TDI 2.5 TDI 2.6 2.6 2.8 2.8	◀ ▶ ▶ ▶ ▶ ▶ ▶ ▶ ▶ ▶ ▶ ▶ ▶ ▶ ▶ ▶		03.92 09.92 12.90 09.92 12.90 07.94 01.92 09.92 01.92 07.94 12.90 09.92 12.90 07.94 05.91 09.92 05.91 07.94 06.91 09.92 06.91 07.94 04.92 09.92 04.92 07.94 12.90 09.92 12.90 07.94	03.2419-9610.3	030029			Gz 19,05
	1.6 2.0 2.0 16V 2.3 2.4 D 2.5 TDI	◀ ▶ ▶ ▶ ▶ ▶		10.92 07.93 10.92 07.94 10.92 07.94 10.92 07.94 10.92 07.94	24.2419-1731.3	030121			Gz 19,05

1) on the brake caliper / sulla pinza freno / sur l'étrier de frein / a la pinza de freno
2) - suspension level control / - correttore assetto / - correcteur d'assiette / - regulación altura suspensión

AUDI 100 (91-94)		AUDI 100 Quattro (85-90)					
	2.6 2.8		10.92 07.94 10.92 07.94	24.2419-1731.3	030121		Gz 19,05
	1.6 2.0 2.0 16V 2.3 2.4 D 2.5 TDI 2.6 2.8		03.92 07.93 12.90 07.94 01.92 07.94 12.90 07.94 05.91 07.94 06.91 07.94 04.92 07.94 12.90 07.94	24.2522-1707.3	040103		Nz 22,20
	2.2 2.2 Turbo 2.3		08.85 11.90 + Hydraulikverstärker 1) 03.86 11.90 + Hydraulikverstärker 1) 08.86 11.90 + Hydraulikverstärker 1)	10.0124-3202.3	340011		Hydraulik Verstärker
	1.8 Limousine 2.2 Limousine 2.2 Turbo Limousine 2.3 Limousine		10.84 11.90 - Hydraulikverstärker 2) 08.85 11.90 + Hydraulikverstärker 1) 03.86 11.90 + Hydraulikverstärker 1) 08.86 11.90 + Hydraulikverstärker 1)	03.2122-8012.3	010156		THz 22,20 ATE
	2.2 Avant 2.2 Turbo Avant 2.3 Avant		44-J-300000 08.85 + Hydraulikverstärker 1) 44-J-300000 03.86 + Hydraulikverstärker 1) 44-J-300000 08.86 + Hydraulikverstärker 1)	03.2125-2510.3	010209		THz 25,40 ATE
	2.2 Avant 2.2 Turbo Avant 2.3 Avant	44-K-000001 44-K-000001 44-K-000001	11.90 + Hydraulikverstärker 1) 11.90 + Hydraulikverstärker 1) 11.90 + Hydraulikverstärker 1)	03.2125-3210.3	010212		THz 25,40 ATE
	1.8 2.2 2.3		10.84 12.87 44-G-073362 08.85 44-G-073362 08.86	24.3541-1719.5 240057 24.3541-1720.5 240058 24.0101-4301.2 260047 11.0101-5403.2 260010		<input type="checkbox"/> <input type="checkbox"/>	D=54, - Halter TRW D=54, - Halter TRW Bremsattel-Zubehör TRW Fallenbalgsatz TRW
	1.8 2.2 2.3		01.88 11.90 - verstärktes Fahrwerk 5) 01.88 11.90 - verstärktes Fahrwerk 5) 01.88 11.90 - verstärktes Fahrwerk 5)	24.3541-1719.5 240057 24.3541-1720.5 240058 24.0101-4301.2 260047 11.0101-5403.2 260010		<input type="checkbox"/> <input type="checkbox"/> <input type="checkbox"/>	D=54, - Halter TRW D=54, - Halter TRW Bremsattel-Zubehör TRW Fallenbalgsatz TRW
	1.8 2.2 2.3		10.84 12.87 44-G-073362 08.85 44-G-073362 08.86	13.0460-2925.2 602925			20901 19,0 +WK/S TRW
	2.2 2.2 Turbo 2.3	44-G-073363	12.87 03.86 12.87	13.0460-2963.2 602963			21138 18,8 +WK/S TRW
	1.8 2.2 2.3		01.88 11.90 01.88 11.90 01.88 11.90	13.0460-2925.2 602925			20901 19,0 +WK/S TRW
	2.2 Turbo	44-K-045093	01.88	13.0460-2963.2 602963			21138 18,8 +WK/S TRW
	2.2 Turbo	44-K-045094	11.90	13.0460-5403.2 605403 13.0460-2963.2 602963			21211 18,7 +WE ATE 21138 18,8 +WK/S TRW
	1.8 2.2 2.3		10.84 12.87 44-G-073362 08.85 44-G-073362 08.86	24.0122-0118.1 422118 24.0122-0120.1 422120			256 22,0 20,0 V +B 280 22,0 20,0 V L
	2.2 2.2 Turbo 2.3	44-G-073363	12.87 03.86 12.87	24.0125-0102.1 425102			276 25,0 23,0 V L
	1.8 2.2 2.3		01.88 11.90 - verstärktes Fahrwerk 5) 01.88 11.90 - verstärktes Fahrwerk 5) 01.88 11.90 - verstärktes Fahrwerk 5)	24.0122-0118.1 422118			256 22,0 20,0 V +B
	1.8 2.2 2.2 Turbo 2.3		01.88 11.90 + verstärktes Fahrwerk 6) 01.88 11.90 + verstärktes Fahrwerk 6) 01.88 11.90 + verstärktes Fahrwerk 6)	24.0125-0102.1 425102			276 25,0 23,0 V L
	1.8 2.2 2.2 Turbo 2.3		10.84 12.87 44-G-200000 08.85 + ABS 44-G-200000 03.86 + ABS 44-G-200000 08.86 + ABS	83.6224-0300.3 330730	2		L=300
	1.8 2.2 2.2 Turbo 2.3	44-G-200001 44-G-200001 44-G-200001 44-G-200001	11.90 12.87 + ABS 12.87 + ABS 12.87 + ABS	24.5170-0315.3 331309	2		L=315
	2.2 2.2 Turbo 2.3		44-G-200000 08.85 - ABS 44-G-200000 03.86 - ABS 44-G-200000 08.86 - ABS	83.6134-0332.3 330716	2		L=330
	2.2 2.2 2.2 Turbo 2.2 Turbo 2.3 2.3	44-G-200001 44-G-200001 44-G-200001	12.87 - ABS 01.88 11.90 - ABS 01.88 11.90 - ABS 12.87 - ABS	24.5113-0380.3 331344	2		L=382
	1.8 Avant 1.8 Limousine 2.2 Avant 2.2 Limousine 2.2 Turbo Avant 2.2 Turbo Limousine 2.3 Avant 2.3 Limousine		10.84 12.87 - erhöhte Zuladung 7) 10.84 12.87 - erhöhte Zuladung 7) 10.84 12.87 - erhöhte Zuladung 7) 03.86 12.87 - erhöhte Zuladung 7) 03.86 12.87 - erhöhte Zuladung 7) 08.86 12.87 - erhöhte Zuladung 7) 08.86 12.87	24.0101-3601.2 260044			Bremsattel-Zubehör TRW

1) + hydraulic booster / + servofreno idraulico / + amplificateur hydraulique / + servo hidráulico

2) - hydraulic booster / - servofreno idraulico / - amplificateur hydraulique / - servo hidráulico

3) standard TMC / PFT standard / MCT standard / CMT standard

4) compact TMC / PFT compatta / MCT compact / CMT compacto

5) - reinforced suspension / - sospensione rinforzata / - châssis renforcé / - suspensión reforzada

6) + reinforced suspension / + sospensione rinforzata / + châssis renforcé / + suspensión reforzada

7) - increased payload / - carico utile maggiorato / - charge utile augmentée / - incremento de carga



AUDI 100 Quattro (85-90)															
	1.8 Avant			01.88	11.90	- erhöhte Zuladung ¹⁾	24.3384-1704.5	240056	<input type="checkbox"/>	D=38, - Halter D=38, - Halter Bremsattel-Zubehör	TRW				
	1.8 Limousine			01.88	11.90		24.3384-1703.5	240055	<input type="checkbox"/>		TRW				
	2.2 Avant			01.88	11.90	- erhöhte Zuladung ¹⁾	24.0101-3601.2	260044	<input type="checkbox"/>		TRW				
	2.2 Limousine			01.88	11.90										
	2.2 Turbo Avant			01.88	11.90	- erhöhte Zuladung ¹⁾									
	2.2 Turbo Limousine			01.88	11.90										
	2.3 Avant			01.88	11.90	- erhöhte Zuladung ¹⁾									
	2.3 Limousine			01.88	11.90										
	1.8 Avant			10.84	11.90	+ erhöhte Zuladung ²⁾	24.3434-1702.5	240358	<input type="checkbox"/>	D=43, - Halter D=43, - Halter Fallenbalgsatz	TRW				
	2.2 Avant			10.84	11.90	+ erhöhte Zuladung ²⁾	24.3434-1701.5	240357	<input type="checkbox"/>		TRW				
	2.2 Turbo Avant			03.86	11.90	+ erhöhte Zuladung ²⁾	11.0101-5403.2	260010			TRW				
	2.3 Avant			08.86	11.90	+ erhöhte Zuladung ²⁾									
	1.8			10.84	11.90		13.0460-3602.2	603602		21144 15,8 /S	TRW				
	2.2			10.84	11.90										
	2.2 Turbo			03.86	11.90										
	1.8			10.84	11.90		24.0110-0207.1	410207		245 10,0 8,0					
	1.8 Avant			10.84	11.90	- erhöhte Zuladung ¹⁾	24.0110-0116.1	410116			245 9,9 8,0 +B				
	2.2 Avant			10.84	11.90	- erhöhte Zuladung ¹⁾									
	2.2 Limousine			10.84	11.90										
	2.2 Turbo Avant			03.86	11.90	- erhöhte Zuladung ¹⁾									
	2.2 Turbo Limousine			03.86	11.90										
	2.3 Avant			08.86	11.90	- erhöhte Zuladung ¹⁾									
	2.3 Limousine			08.86	11.90										
	1.8 Avant			10.84	11.90	+ erhöhte Zuladung ²⁾			24.0120-0137.1			420137		269 19,9 18,0 V +B	
	2.2 Avant			10.84	11.90	+ erhöhte Zuladung ²⁾									
2.2 Turbo Avant			03.86	11.90	+ erhöhte Zuladung ²⁾										
2.3 Avant			08.86	11.90	+ erhöhte Zuladung ²⁾										
	1.8			10.84	11.90		24.5113-0220.3	331318	2	L=220					
	2.2			10.84	11.90										
	2.2 Turbo			03.86	11.90										
	2.3			08.86	11.90										
	1.8			10.84	11.90		03.2419-9610.3	030029		Gz 19,05					
	2.2			10.84	12.87										
	2.2 Turbo			03.86	11.90										
	2.3			08.86	11.90										
	1.8			10.84	12.87		03.2522-4211.3	040017		Nz 22,20					
	2.2			10.84	12.87										
	2.2 Turbo			03.86	12.87										
	2.3			08.86	12.87										
	1.8			01.88	11.90		24.2522-1707.3	040103		Nz 22,20					
	2.2			01.88	11.90										
	2.2 Turbo			01.88	11.90										
	2.3			01.88	11.90										
AUDI 100 Quattro (91-94)															
	S4			10.92	07.94		10.0124-3202.3	340011		Hydraulik Verstärker					
	S4	169		08.91	07.94										
	S4			10.92	07.94		03.2125-3610.3	010214		THz 25,40	ATE				
	S4	169		08.91	07.94										
	2.0			12.90	07.94		24.3571-8505.5	240489	<input type="checkbox"/>	D=57, - Halter D=57, - Halter Dichtungssatz Hülzensatz Führungsbolzen Haltefeder	ATE				
	2.3			12.90	07.94						24.3571-8506.5	240490	<input type="checkbox"/>	ATE	
											11.0441-5704.2	250034		ATE	
											11.0101-5409.2	260035		ATE	
											11.8171-0008.1	990049		ATE	
											11.8116-0143.1	390513	2	ATE	
											11.3571-8508.2	220128	<input type="checkbox"/>	D=57, - Halter	ATE
											24.3571-8507.5	240555	<input type="checkbox"/>	D=57, - Halter	ATE
											24.3571-8508.5	240556	<input type="checkbox"/>	D=57, - Halter	ATE
											11.8170-0306.1	260102	2	Halter	ATE
						11.0441-5704.2	250034		Dichtungssatz	ATE					
						11.0101-5409.2	260035		Hülzensatz	ATE					
						11.8171-0008.1	990049		Führungsbolzen	ATE					
						11.8116-0143.1	390513	2	Haltefeder	ATE					
	S4	169	4A-P-150000	08.91			11.0441-6003.2	250037		Dichtungssatz					
	2.0			12.90	07.94		13.0460-7050.2	607050		20678 19,5 +/WK	ATE				
	2.3			12.90	07.94										
	2.6			03.92	07.94										
2.8			12.90	07.94											
	S4	169	4A-P-150000	08.91			13.0460-2847.2	602847	2	21219 17,8 +/WE Warnkontakt L=240mm	ATE				
	S4						24.8190-0105.2	620105							
	S4	169	4A-R-000001	10.92	07.94		13.0460-2717.2	602717		21452 18,5 +/WK/S	TRW				
	S4														
	2.0			12.90	07.94		24.0115-0105.1	415105		288 15,0 13,0 L +B 288 15,0 13,0 L +B PD					
	2.3			12.90	07.94										
	2.6			03.92	07.94										
	2.8			12.90	07.94										
	S4			10.92	07.94										
	S4	169	4A-R-000001		07.94						24.0125-0105.1	425105		288 25,0 23,0 V L +S +B 288 25,0 23,0 V L +B PD	
						24.0325-0105.1	525105								
						24.0130-0104.1	430104		314 30,0 28,0 V L +B						

¹⁾ - increased payload / - carico utile maggiorato / - charge utile augmentée / - incremento de carga
²⁾ + increased payload / + carico utile maggiorato / + charge utile augmentée / + incremento de carga

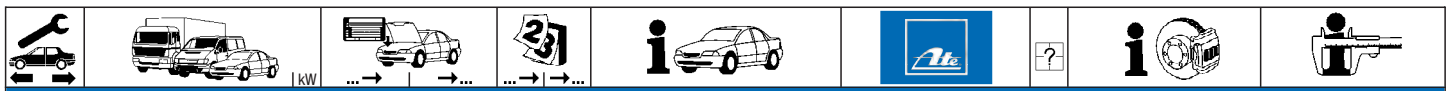

AUDI 100 Quattro (91-94)											
	2.0 2.3 2.6 2.8 S4 S4			12.90 12.90 03.92 12.90 10.92 08.91	07.94 07.94 07.94 07.94 07.94 07.94		24.5237-0273.3	331444	2	L=273	
	2.0 2.3 2.6 2.8			12.90 12.90 03.92 12.90	07.94 07.94 07.94 07.94		24.3384-1704.5 24.3384-1703.5 24.0101-3601.2	240056 240055 260044		D=38, - Halter D=38, - Halter Bremsattel-Zubehör	TRW TRW TRW
	S4 S4			10.92 08.91	07.94 07.94		24.3434-1702.5 24.3434-1701.5 11.0101-5403.2	240358 240357 260010		D=43, - Halter D=43, - Halter Fallenbalgsatz	TRW TRW TRW
	2.0 2.3 2.6 2.8 S4 S4			12.90 12.90 03.92 07.92 10.92 08.91	07.94 07.94 07.94 07.94 07.94 07.94		13.0460-3602.2	603602		21144 15,8 /S	TRW
	2.0 2.3 2.6 2.8 S4 S4			12.90 12.90 03.92 12.90 10.92 08.91	07.94 07.94 07.94 07.94 07.94 07.94	- (N) - (N) - (N) - (N)	24.0110-0201.1 24.0310-0201.1	410201 510201		245 10,0 8,0 +B 245 10,0 8,0 +B PD	
	2.0 2.3 2.8		4A-M-150000 4A-M-150000 4A-M-150000	12.90 12.90 12.90			24.5113-0220.3	331318	2	L=220	
	2.0 2.3 2.6 2.8 S4 S4	4A-N-000001 4A-N-000001 4A-N-000001		07.94 07.94 03.92 07.94 10.92 08.91	07.94 07.94 07.94 07.94 07.94 07.94		24.5113-0209.3	331300	2	L=209	
	2.0 2.0 2.3 2.3 2.6 2.6 2.8 2.8 S4 S4	◀ ▶ ▶ ▶ ▶ ▶ ▶ ▶ ▶169 ▶169	4A-P-038000 4A-P-038000 4A-P-038000 4A-P-038000 4A-P-038000 4A-P-038000	12.90 12.90 12.90 03.92 03.92 12.90 12.90 08.91	07.94 07.94 07.94 07.94 07.94 07.94 07.94 07.94		03.2419-9610.3	030029		Gz 19,05	
	2.0 2.3 2.6 2.8 S4	◀ ◀ ◀ ◀ ◀169	4A-P-038001 4A-P-038001 4A-P-038001 4A-P-038001	07.94 07.94 07.94 07.94	07.94 07.94 07.94 07.94		24.2419-1731.3	030121		Gz 19,05	
	2.0 2.3 2.6 2.8 S4 S4			12.90 12.90 03.92 12.90 12.90 08.91	07.94 07.94 07.94 07.94 07.94 07.94		24.2522-1707.3	040103		Nz 22,20	

AUDI 200 Quattro (85-91)											
	2.2			11.84	11.90		10.0124-3202.3	340011		Hydraulik Verstärker	
	2.2 Limousine			11.84	12.87		03.2123-8512.3	010194		THz 23,81	ATE
	2.2 2.2 2.2 Avant	121 147	44-J-300000 44-J-300000	01.88 01.88			03.2125-2510.3	010209		THz 25,40	ATE
	2.2 2.2 2.2	121 147 162	44-K-000001 44-K-000001	11.90 11.90			03.2125-3210.3	010212		THz 25,40	ATE
	2.2		44-G-073362	11.84			24.3541-1719.5 24.3541-1720.5 24.0101-4301.2 11.0101-5403.2	240057 240058 260047 260010		D=54, - Halter D=54, - Halter Bremsattel-Zubehör Fallenbalgsatz	TRW TRW TRW TRW
	2.2		44-G-073362	11.84			13.0460-2925.2	602925		20901 19,0 +/WK/S	TRW
	2.2 2.2 2.2	121 147	44-G-073363 44-K-045093 44-K-045093	12.87 01.88 01.88			13.0460-2963.2	602963		21138 18,8 +/WK/S	TRW
	2.2 2.2 2.2	121 147 162	44-K-045094 44-K-045094	11.90 11.90			13.0460-5403.2 13.0460-2963.2	605403 602963		21211 18,7 +/WE 21138 18,8 +/WK/S	ATE TRW
	2.2		44-G-073362	11.84			13.0460-2847.2	602847		21219 17,8 +/WE	ATE
	2.2 2.2 2.2	121 147	44-G-073363	12.87 01.88 01.88	11.90 11.90		24.0122-0120.1	422120 425102		280 22,0 20,0 V L 276 25,0 23,0 V L	





AUDI 200 Quattro (85-91)												
	2.2			44-G-200000	11.84			83.6224-0300.3	330730	2		L=300
	2.2		44-G-200001		12.87			24.5113-0380.3	331344	2		L=382
	2.2	121			01.88	11.90						
	2.2	147			01.88	11.90						
	2.2	162			03.89	11.90		83.7813-0252.3	330796	2		L=250
	2.2 Limousine				11.84	12.87		24.0101-3601.2	260044			Bremssattel-Zubehör TRW
	2.2 Limousine	121			01.88	11.90		24.3384-1704.5	240056			D=38, - Halter TRW
	2.2 Limousine	147			01.88	11.90		24.3384-1703.5	240055			D=38, - Halter TRW
	2.2 Avant				11.84	11.90		24.0101-3601.2	260044			Bremssattel-Zubehör TRW
	2.2 Limousine	162			11.84	11.90		24.3434-1702.5	240358			D=43, - Halter TRW
	2.2 Limousine				03.89	11.90		24.3434-1701.5	240357			D=43, - Halter TRW
	2.2 Limousine							11.0101-5403.2	260010			Faltenbalgsatz TRW
	2.2				11.84	11.90		13.0460-3602.2	603602			21144 15,8 /S TRW
	2.2 Limousine				11.84	12.87		24.0110-0116.1	410116			245 9,9 8,0 +B
	2.2 Limousine	121			01.88	11.90						
	2.2 Limousine	147			01.88	11.90						
	2.2 Avant				11.84	11.90		24.0120-0137.1	420137			269 19,9 18,0 V +B
	2.2 Limousine	162			03.89	11.90						
	2.2				11.84	11.90		24.5113-0220.3	331318	2		L=220
	2.2				11.84	11.90		03.2419-9610.3	030029			Gz 19,05
	2.2				11.84	12.87		03.2522-4211.3	040017			Nz 22,20
	2.2				01.88	11.90		24.2522-1707.3	040103			Nz 22,20

AUDI 200 (80-83)												
	2.2				10.79	08.83 + Hydraulikverstärker ¹⁾		10.0124-3202.3	340011			Hydraulik Verstärker
	2.2				10.79	08.83		13.0460-2934.2	602934			20669 19,0 /S TRW
	2.2				10.79	08.83		24.0122-0120.1	422120			280 22,0 20,0 V L
	2.2				10.79	08.83		83.6134-0332.3	330716	2		L=330
	2.2				10.79	08.83		13.0460-3602.2	603602			21144 15,8 /S TRW
	2.2				10.79	08.83		24.0110-0154.1	410154			245 10,0 8,0
	2.2				10.79	08.83		24.5204-0180.3	331461	2		L=180
	2.2							24.5170-0161.3	331308	2	am Bremssattel ²⁾	L=161
	2.2				10.79	08.83 - Niveauregulierung ³⁾		03.6565-0101.3	320097			BRL 6/5 (4) ATE
	2.2				10.79	08.83		03.2419-9610.3	030029			Gz 19,05
	2.2				10.79	08.83		03.2522-4211.3	040017			Nz 22,20

AUDI 200 (84-91)												
	2.1				08.83	01.88		10.0124-3202.3	340011			Hydraulik Verstärker
	2.2				08.84	12.90						
	2.1				08.83	01.88 - erhöhte Zuladung ⁴⁾		03.2123-8512.3	010194			THz 23,81 ATE
	2.2				08.84	01.88 - erhöhte Zuladung ⁴⁾						
	2.1				08.83	01.88 + erhöhte Zuladung ⁵⁾		03.2125-2510.3	010209			THz 25,40 ATE
	2.2				08.84	01.88 + erhöhte Zuladung ⁵⁾						
	2.2				02.88	12.90		03.2125-3210.3	010212			THz 25,40 ATE
	2.1			44-G-073362	08.83			24.3541-1719.5	240057			D=54, - Halter TRW
	2.2			44-G-073362	08.84			24.3541-1720.5	240058			D=54, - Halter TRW
	2.1							24.0101-4301.2	260047			Bremssattel-Zubehör TRW
	2.2							11.0101-5403.2	260010			Faltenbalgsatz TRW
	2.1			44-G-073362	08.83			13.0460-2925.2	602925			20901 19,0 +/WK/S TRW
	2.2			44-G-073362	08.84							
	2.1			44-G-073363		01.88		13.0460-2963.2	602963			21138 18,8 +/WK/S TRW
	2.2			44-G-073363	44-K-045093							
	2.2			44-K-045094		12.90		13.0460-5403.2	605403			21211 18,7 +/WE ATE
	2.2							13.0460-2963.2	602963			21138 18,8 +/WK/S TRW

¹⁾ + hydraulic booster / + servofreno idraulico / + amplificateur hydraulique / + servo hidráulico
²⁾ on the brake caliper / sulla pinza freno / sur l'étrier de frein / a la pinza de freno
³⁾ - suspension level control / - correttore assetto / - correcteur d'assiette / - regulación altura suspensión
⁴⁾ - increased payload / - carico utile maggiorato / - charge utile augmentée / - incremento de carga
⁵⁾ + increased payload / + carico utile maggiorato / + charge utile augmentée / + incremento de carga



AUDI 200 (84-91)											
	2.1			44-G-073362	08.83			24.0122-0120.1	422120		280 22,0 20,0 V L
	2.2			44-G-073362	08.84						
	2.1			44-G-073363		01.88		24.0125-0102.1	425102		276 25,0 23,0 V L
	2.2			44-G-073363		12.90					
	2.1			44-G-200000	08.83			83.6224-0300.3	330730	2	L=300
	2.2			44-G-200000	08.84						
	2.1			44-G-200001		01.88		24.5113-0380.3	331344	2	L=382
	2.2			44-G-200001		12.90					
	2.1				08.83	01.88		24.0101-3601.2	260044		Bremssattel-Zubehör TRW
	2.2				08.84	01.88					
	2.1				08.83	01.88		24.3384-1603.5	240015	<input type="checkbox"/> <input type="checkbox"/>	D=38, - Halter TRW
	2.2				08.84	01.88		24.3384-1604.5	240016		D=38, - Halter TRW
2.2					02.88	12.90		24.0101-3601.2	260044		Bremssattel-Zubehör TRW
	2.1				08.83	01.88		13.0460-3602.2	603602		21144 15,8 /S TRW
	2.2				08.84	12.90					
	2.1				08.83	01.88		24.0110-0154.1	410154		245 10,0 8,0
	2.2				08.84	12.90					
	2.1			44-G-073362	08.83			83.6204-0240.3	330718	<input type="checkbox"/> <input type="checkbox"/>	L=240
	2.2			44-G-073362	08.84			83.6134-0332.3	330716		L=330
2.1				44-G-073363		01.88		83.6301-0150.3	330342		2
	2.1			44-G-073363		01.88		24.5113-0220.3	331318	2	L=220
	2.2			44-G-073363		12.90					am Bremssattel ¹⁾
	2.1				08.83	01.88		24.3727-0138.2	580138	2	L=1438
	2.2				08.84	01.88					
	2.1				08.83	01.88		24.3727-0130.2	580130	2	L=1455
	2.2				08.84	12.90					
	2.1				08.83	01.88	- Niveauregulierung ²⁾	03.6585-0108.3	320115		BRL 8/5 (4) ATE
	2.2				08.84	12.90	- Niveauregulierung ²⁾				
	2.1				08.83	01.88		03.2419-9610.3	030029		Gz 19,05
	2.2				08.84	12.90					
	2.1				08.83	01.88		03.2522-4211.3	040017		Nz 22,20
	2.2				08.84	01.88					
	2.1				08.83	01.88		24.2522-1707.3	040103		Nz 22,20
	2.2				02.88	12.90					

AUDI A6 / A6 Avant (4A/C4) (94-97)

	S6	169			06.94	12.97		10.0124-3202.3	340011		Hydraulik Verstärker
	S6	213			09.94	12.97					
	S6 plus	235			06.96	12.97					
	1.9 TDI				06.94	06.95	- ABS	03.2123-0491.3	010167		THz 23,81 ATE
	2.0				06.94	06.95	- ABS				
	2.0 16V				06.94	06.95	- ABS				
	2.3				06.94	06.95	- ABS				
	2.5 TDI				06.94	06.95	- ABS				
	2.6				06.94	06.95	- ABS				
	2.8	128			06.94	06.95	- ABS				
	1.9 TDI				06.94	06.95	+ ABS/ - EDS	24.2123-1602.3	010384		THz 23,81 TRW
	2.0				06.94	06.95	+ ABS/ - EDS				
	2.0 16V				06.94	06.95	+ ABS/ - EDS				
	2.3				06.94	06.95	+ ABS/ - EDS				
	2.5 TDI				06.94	06.95	+ ABS/ - EDS				
	2.6				06.94	06.95	+ ABS/ - EDS				
	2.8	128			06.94	06.95	+ ABS/ - EDS				
	1.8				10.95	12.97	+ ABS	24.2123-1731.3	010621		THz 23,81
	1.8 quattro				10.95	12.97					
	1.9 TDI				06.94	06.95	+ ABS/ + EDS				
	1.9 TDI				07.95	12.97	+ ABS				
	2.0				06.94	06.95	+ ABS/ + EDS				
	2.0				07.95	12.97	+ ABS				
	2.0 16V				06.94	06.95	+ ABS/ + EDS				
	2.0 16V				07.95	12.97	+ ABS				
	2.0 quattro				06.94	12.97					
	2.3				06.94	06.95	+ ABS/ + EDS				
	2.3				07.95	12.95	+ ABS				
	2.3 quattro				08.94	12.95					
	2.5 TDI				06.94	06.95	+ ABS/ + EDS				
	2.5 TDI				07.95	12.97	+ ABS				
2.5 TDI quattro				07.95	12.97						
2.6				06.94	06.95	+ ABS/ + EDS					
2.6 quattro				07.95	12.97	+ ABS					
2.8	128			06.94	06.95	+ ABS/ + EDS					
2.8	128			07.95	12.97	+ ABS					
2.8	142			10.95	12.97	+ ABS					
2.8 quattro				06.94	12.97						
	1.8				10.95	12.97		24.3571-8505.5	240489	<input type="checkbox"/> <input type="checkbox"/>	D=57, - Halter ATE
	1.9 TDI				06.94	12.97		24.3571-8506.5	240490		D=57, - Halter ATE
	2.0				06.94	12.97		11.0441-5704.2	250034		Dichtungssatz ATE
	2.0 16V				06.94	12.97		11.0101-5409.2	260035		Hülssensatz ATE
	2.3				06.94	12.95		11.8171-0008.1	990049		Führungsbolzen ATE
2.5 TDI	85			06.94	12.97		11.8116-0143.1	390513	2	Haltefeder ATE	

¹⁾ on the brake caliper / sulla pinza freno / sur l'étrier de frein / a la pinza de freno
²⁾ - suspension level control / - correttore assetto / - correcteur d'assiette / - regulación altura suspensión



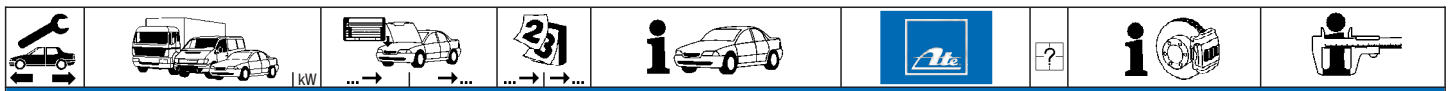

AUDI A6 / A6 Avant (4A/C4) (94-97)

	2.5 TDI	103		10.94	12.97	11.3571-8508.2	220128			D=57, - Halter	ATE
	2.6			06.94	12.97	24.3571-8507.5	240555			D=57, - Halter	ATE
	2.8	128		06.94	12.97	24.3571-8508.5	240556			D=57, - Halter	ATE
	2.8	142		10.95	12.97	11.8170-0306.1	260102	2		Halter	ATE
						11.0441-5704.2	250034			Dichtungssatz	ATE
						11.0101-5409.2	260035			Hülsensatz	ATE
						11.8171-0008.1	990049			Führungsbolzen	ATE
						11.8116-0143.1	390513	2		Haltefeder	ATE
	1.8 quattro			10.95	12.97	24.3571-8505.5	240489			D=57, - Halter	ATE
	2.0 quattro			06.94	12.97	24.3571-8506.5	240490			D=57, - Halter	ATE
	2.3 quattro			08.94	12.95	11.0441-5704.2	250034			Dichtungssatz	ATE
						11.0101-5409.2	260035			Hülsensatz	ATE
					11.8171-0008.1	990049			Führungsbolzen	ATE	
					11.8116-0143.1	390513	2		Haltefeder	ATE	
2.5 TDI quattro			07.95	12.97	11.3571-8508.2	220128			D=57, - Halter	ATE	
2.6 quattro			06.94	12.97	24.3571-8507.5	240555			D=57, - Halter	ATE	
2.8 quattro			06.94	12.97	24.3571-8508.5	240556			D=57, - Halter	ATE	
					11.8170-0306.1	260102	2		Halter	ATE	
					11.0441-5704.2	250034			Dichtungssatz	ATE	
					11.0101-5409.2	260035			Hülsensatz	ATE	
					11.8171-0008.1	990049			Führungsbolzen	ATE	
					11.8116-0143.1	390513	2		Haltefeder	ATE	
	1.8			10.95	12.97	13.0460-7050.2	607050			20678 19,5 +WK	ATE
	1.8 quattro			10.95	12.97						
	1.9 TDI			06.94	12.97						
	2.0			06.94	12.97						
	2.0 16V			06.94	12.97						
	2.0 quattro			06.94	12.97						
	2.3			06.94	12.95						
	2.3 quattro			08.94	12.95						
	2.5 TDI			06.94	12.97						
	2.5 TDI quattro			07.95	12.97						
	2.6			06.94	12.97						
	2.6 quattro			06.94	12.97						
2.8	128		06.94	12.97							
2.8	142		10.95	12.97							
2.8 quattro			06.94	12.97							
S6	169		06.94	12.97	13.0460-2717.2	602717			21452 18,5 +WK/S	TRW	
S6	213		09.94	12.97							
S6 plus	235		06.96	12.97							
	1.8			10.95	12.97	24.0115-0105.1	415105			288 15,0 13,0 L +B	
	1.8 quattro			10.95	12.97	24.0315-0105.1	515105			288 15,0 13,0 L +B PD	
	1.9 TDI			06.94	12.97						
	2.0			06.94	12.97						
	2.0 16V			06.94	12.97						
	2.0 quattro			06.94	12.97						
	2.3			06.94	12.95						
	2.3 quattro			08.94	12.95						
	2.5 TDI	85		06.94	12.97						
	2.5 TDI	103		10.94	12.97	24.0125-0105.1	425105			288 25,0 23,0 V L +S +B	
	2.5 TDI quattro			07.95	12.97	24.0325-0105.1	525105			288 25,0 23,0 V L +B PD	
	2.6			06.94	12.97						
2.6 quattro			06.94	12.97							
2.8	128		06.94	12.97							
2.8	142		10.95	12.97							
2.8 quattro			06.94	12.97							
S6	169		06.94	12.97	24.0130-0104.1	430104			314 30,0 28,0 V L +B		
S6	213		09.94	12.97							
S6 plus	235		06.96	12.97	24.0130-0183.1	430183			323 30,0 28,0 V +B		
	1.8			10.95	12.97	24.5237-0273.3	331444	2		L=273	
	1.8 quattro			10.95	12.97						
	1.9 TDI			06.94	12.97						
	2.0			06.94	12.97						
	2.0 16V			06.94	12.97						
	2.0 quattro			06.94	12.97						
	2.3			06.94	12.95						
	2.3 quattro			08.94	12.95						
	2.5 TDI			06.94	12.97						
	2.5 TDI quattro			07.95	12.97						
	2.6			06.94	12.97						
	2.6 quattro			06.94	12.97						
2.8	128		06.94	12.97							
2.8	142		10.95	12.97							
2.8 quattro			06.94	12.97							
S6	169		06.94	12.97							
S6	213		09.94	12.97							
S6 plus	235		06.96	12.97							
	1.8			10.95	12.97	24.3384-1709.5	240257			D=38, - Halter	TRW
	1.9 TDI			06.94	12.97	24.3384-1710.5	240258			D=38, - Halter	TRW
	2.0			06.94	12.97						
	2.0 16V			06.94	12.97						
	2.3			06.94	12.95						
	2.5 TDI			06.94	12.97						
	2.6			06.94	12.97						
	2.8	128		06.94	12.97						
2.8	142		10.95	12.97							



AUDI A6 / A6 Avant (4A/C4) (94-97)

	1.8 quattro		10.95	12.97	24.3384-1704.5	240056			D=38, - Halter	TRW
	2.0 quattro		06.94	12.97	24.3384-1703.5	240055			D=38, - Halter	TRW
	2.3 quattro		08.94	12.95						
	2.5 TDI quattro		07.95	12.97						
	2.6 quattro		06.94	12.97						
	2.8 quattro		06.94	12.97						
	S6	169	06.94	12.97	24.3434-1702.5	240358			D=43, - Halter	TRW
S6	213	09.94	12.97	24.3434-1701.5	240357			D=43, - Halter	TRW	
				11.0101-5403.2	260010			Faltenbalgsatz	TRW	
	1.8		10.95	12.97	13.0460-3602.2	603602			21144 15,8 /S	TRW
	1.8 quattro		10.95	12.97						
	1.9 TDI		06.94	12.97						
	2.0		06.94	12.97						
	2.0 16V		06.94	12.97						
	2.0 quattro		06.94	12.97						
	2.3		06.94	12.95						
	2.3 quattro		08.94	12.95						
	2.5 TDI		06.94	12.97						
	2.5 TDI quattro		07.95	12.97						
	2.6		06.94	12.97						
	2.6 quattro		06.94	12.97						
	2.8	128	06.94	12.97						
	2.8	142	10.95	12.97						
	2.8 quattro		06.94	12.97						
S6	169	06.94	12.97							
S6	213	09.94	12.97							
S6 plus	235	06.96	12.97							
	1.8		10.95	12.97	24.0110-0201.1	410201			245 10,0 8,0 +B	
	1.8 quattro		10.95	12.97	24.0310-0201.1	510201			245 10,0 8,0 +B PD	
	1.9 TDI		06.94	12.97						
	2.0		06.94	12.97						
	2.0 16V		06.94	12.97						
	2.0 quattro		06.94	12.97						
	2.3		06.94	12.95						
	2.3 quattro		08.94	12.95						
	2.5 TDI		06.94	12.97						
	2.5 TDI quattro		07.95	12.97						
	2.6		06.94	12.97						
	2.6 quattro		06.94	12.97						
	2.8	128	06.94	12.97						
	2.8	142	10.95	12.97						
	2.8 quattro		06.94	12.97						
S6	169	06.94	12.97	24.0120-0172.1	420172			269 19,9 18,0 V L		
S6	213	09.94	12.97							
S6 plus	235	06.96	12.97							
	1.8		10.95	12.97	83.6104-0180.3	330510	2	am Bremssattel ¹⁾	L=180	
	1.9 TDI		06.94	12.97	24.5204-0180.3	331461	2	am Bremssattel ¹⁾	L=180	
	2.0		06.94	12.97						
	2.0 16V		06.94	12.97						
	2.3		06.94	12.95						
	2.5 TDI		06.94	12.97						
	2.6		06.94	12.97						
	2.8	128	06.94	12.97						
	2.8	142	10.95	12.97						
	1.8 quattro		10.95	12.97	24.5113-0209.3	331300	2		L=209	
	2.0 quattro		06.94	12.97						
	2.3 quattro		08.94	12.95						
	2.5 TDI quattro		07.95	12.97						
	2.6 quattro		06.94	12.97						
	2.8 quattro		06.94	12.97						
S6	169	06.94	12.97							
S6	213	09.94	12.97							
S6 plus	235	06.96	12.97							
	1.8		10.95	12.97	24.3727-0154.2	580154	2		L=1491	
	1.9 TDI		06.94	12.97						
	2.0		06.94	12.97						
	2.0 16V		06.94	12.97						
	2.3		06.94	12.95						
	2.5 TDI		06.94	12.97						
	2.6		06.94	12.97						
	2.8	128	06.94	12.97						
2.8	142	10.95	12.97							
	1.8		10.95	12.97	03.6585-0108.3	320115			BRL 8/5 (4)	ATE
	1.9 TDI		06.94	12.97						
	2.0		06.94	12.97						
	2.0 16V		06.94	12.97						
	2.3		06.94	12.95						
	2.5 TDI		06.94	12.97						
	2.6		06.94	12.97						
	2.8	128	06.94	12.97						
2.8	142	10.95	12.97							
	1.8		10.95	12.97	24.2419-1731.3	030121			Gz 19,05	
	1.8 quattro		10.95	12.97						
	1.9 TDI		06.94	12.97						
	2.0		06.94	12.97						
	2.0 16V		06.94	12.97						

¹⁾ on the brake caliper / sulla pinza freno / sur l'étrier de frein / a la pinza de freno

²⁾ - suspension level control / - correttore assetto / - correcteur d'assiette / - regulación altura suspensión





AUDI A6 / A6 Avant (4A/C4) (94-97)

	2.0 quattro			06.94	12.97	24.2419-1731.3	030121		Gz 19,05
	2.3			06.94	12.95				
	2.3 quattro			08.94	12.95				
	2.5 TDI			06.94	12.97				
	2.5 TDI	85		06.94	12.97				
	2.5 TDI	103		10.94	12.97				
	2.5 TDI quattro			07.95	12.97				
	2.6			06.94	12.97				
	2.6 quattro			06.94	12.97				
	2.8			06.94	12.97				
	2.8	128		10.95	12.97				
	2.8 quattro			06.94	12.97				
	S6	169		06.94	12.97				
	1.8			10.95	12.97	03.2419-9610.3	030029		Gz 19,05
	1.8 quattro			10.95	12.97				
	1.9 TDI			06.94	12.97				
	2.0			06.94	12.97				
	2.0 16V			06.94	12.97				
	2.0 quattro			06.94	12.97				
	2.3			06.94	12.95				
	2.3 quattro			08.94	12.95				
	2.5 TDI			06.94	12.97				
	2.5 TDI	85		06.94	12.97				
	2.5 TDI	103		10.94	12.97				
	2.5 TDI quattro			07.95	12.97				
	2.6			06.94	12.97				
	2.6 quattro			06.94	12.97				
	2.8			06.94	12.97				
	2.8	128		10.95	12.97				
	2.8 quattro			06.94	12.97				
	S6	169		06.94	12.97				
	1.8			10.95	12.97	24.2522-1707.3	040103		Nz 22,20
	1.8 quattro			10.95	12.97				
	1.9 TDI			06.94	12.97				
	2.0			06.94	12.97				
	2.0 16V			06.94	12.97				
	2.0 quattro			06.94	12.97				
	2.3			06.94	12.95				
	2.3 quattro			08.94	12.95				
	2.5 TDI			06.94	12.97				
	2.5 TDI quattro			07.95	12.97				
	2.6			06.94	12.97				
	2.6 quattro			06.94	12.97				
	2.8	128		06.94	12.97				
	2.8	142		10.95	12.97				
	2.8 quattro			06.94	12.97				
	S6	169		06.94	12.97				
	S6	213		09.94	12.97				
	S6 plus	235		06.96	12.97				

AUDI COUPE (81-88)

	1.8	85-F-000001		07.88		03.7750-0302.4	300071		9"	ATE
	2.0	85-F-000001		07.88						
	2.2	85-F-000001		07.88						
	2.3	85-F-000001		07.88						
	1.6			02.81	08.81 + Schaltgetriebe ¹⁾	03.2120-1531.3	010092		THz 20,64	ATE
	1.8	85-F-000001		07.88		03.2120-2331.3	010110	1	THz 20,64	ATE
	1.6			02.81	08.81 + Automatikgetriebe ²⁾	03.3526-2002.3	340010	1	Bremslichtschalter	
	1.9		85-C-250000	10.80						
	2.2		85-C-250000	02.81						
	1.9		85-C-250000	10.80		03.3526-2002.3	340010	2	Bremslichtschalter	
	2.2		85-C-250000	02.81						
	2.0	85-F-000001		07.88	- ABS	03.2122-9612.3	010159		THz 22,20	ATE
	2.0	85-F-000001		07.88	- ABS					
	2.2	85-F-000001		07.88	- ABS					
	2.3	100		02.87	07.88 - ABS					
	2.3	100		02.87	07.88 - ABS					
	2.0	85-F-000001		07.87		24.3541-1609.5	240039		D=54, - Halter	TRW
	2.2	85-F-000001		07.88		24.3541-1610.5	240040		D=54, - Halter	TRW
	2.3			02.87		24.0101-4301.2	260047		Bremsmittel-Zubehör	TRW
						11.0101-5403.2	260010		Faltenbalgsatz	TRW
	1.8	85-F-000001		07.88		13.0460-2936.2	602936		20574 15,3 /S	TRW
	2.2	96	85-E-220000	09.81						
	2.0	85-F-000001		07.87		13.0460-2926.2	602926		20669 15,7 /S	TRW
	2.2	85-F-000001		07.88						
	2.3			02.87						
	1.6			02.81	08.81	24.0112-0106.1	412106		239 12,0 10,0 +S +B	
	1.8		85-E-220000	08.81		24.0312-0106.1	512106		239 12,0 10,0 +S +B PD	
	1.9			10.80	08.83					
	2.0		85-E-220000	09.83						
	2.2	77		02.81	08.83 + [Ⓛ]					
	2.2	85		02.81	08.83					
	1.8	85-F-000001		07.88		24.0120-0123.1	420123		239 20,0 18,0 V L +S +B	
	2.2	96	85-E-220000	09.81		24.0320-0123.1	520123		239 20,0 18,0 V L +S +B PD	

¹⁾ + manual transmission / + scatola cambio velocità / + transmission mécanique / + cambio de velocidad

²⁾ + autom.transmission / + scatola cambio automatico / + transmission automatique / + cambio automático

AUDI COUPE (81-88)								
	2.0 2.2 2.3	85-F-000001 85-F-000001		07.87 07.88 02.87 07.88		24.0120-0120.1	420120	256 20,0 18,0 V L
	1.6 1.8 1.9 2.0 2.2 2.3			02.81 08.81 08.81 07.88 10.80 08.83 09.83 07.88 09.84 07.88 02.87 07.88		24.5170-0315.3	331309 2	L=315
	2.2 2.3	100		09.84 07.88 02.87 07.88		24.0101-3601.2	260044	Bremssattel-Zubehör TRW
	2.2 2.3	100		09.84 07.88 02.87 07.88		13.0460-3602.2	603602	21144 15,8 /S TRW
	2.2 2.3	100		09.84 07.88 02.87 07.88		24.0110-0178.1	410178	245 10,0 8,0 +B
	1.6 1.8 1.9 2.0 2.2 2.2 2.2 2.3	85 96 100		02.81 08.81 08.81 07.88 10.80 08.83 09.83 07.88 09.84 07.88 09.84 07.88 08.84 07.88 02.87 07.88		83.6224-0200.3 24.5204-0180.3	330729 331461	L=200 L=180
	1.6 1.8		85-E-220000	02.81 08.81 08.81	+ Schaltgetriebe ¹⁾ + Schaltgetriebe ¹⁾	03.3214-0812.3	020011	+ GG ²⁾ Rz 14,29
	1.6 1.8 1.8 1.9	85-F-000001	85-E-220000	02.81 08.81 08.81 07.88 10.80 08.83	+ Automatikgetriebe ³⁾ + Automatikgetriebe ³⁾	03.3215-2311.3 24.3215-0903.3	020018 020154	+ GG ²⁾ + ALU ⁴⁾ Rz 15,87 Rz 15,87
	2.0 2.2 2.2 2.2	77 85 96		09.83 07.87 02.81 07.84 02.81 07.88 02.81 07.84	+ ⁵⁾	03.3217-2112.3	020027	+ GG ²⁾ Rz 17,46
	1.6 1.8		85-E-220000	02.81 08.81 08.81	+ Schaltgetriebe ¹⁾ + Schaltgetriebe ¹⁾	03.0137-0126.2 03.0137-9008.2	650126 669008	180 x 31 HEB Bremsbacken-Zubehör
	1.6 1.8 1.8 1.9 2.0 2.2 2.2 2.2	85-F-000001	85-E-220000	02.81 08.81 08.81 07.88 10.80 08.83 09.83 07.87 02.81 07.84 02.81 07.88 02.81 07.84	+ Automatikgetriebe ³⁾ + Automatikgetriebe ³⁾ + ⁵⁾	03.0137-0146.2 03.0137-9041.2	650146 669041	200 x 40 HEB Bremsbacken-Zubehör
	1.6 1.8		85-E-220000	02.81 08.81 08.81	+ Schaltgetriebe ¹⁾ + Schaltgetriebe ¹⁾	24.0218-0007.1 24.0218-0707.2	480003 480211	180/181 x 38,5 - Lager 180/181 x 38,5 + Lager
	2.0 2.2	81 85		09.83 07.87 02.81 07.88	+ ⁵⁾	24.0220-0016.1	480018	200/201 x 51,5
	1.6 1.8 1.8 1.9 2.0 2.2 2.2	85-F-000001	85-E-220000	02.81 08.81 08.81 07.88 10.80 08.83 09.83 07.86 09.83 07.86 04.81 07.84 04.81 07.84	+ Automatikgetriebe ³⁾ + Automatikgetriebe ³⁾ + ⁵⁾	24.0220-0018.1 24.0220-0718.2	480019 480209	200/201 x 50 - Lager 200/201 x 50 + Lager
	1.6 1.8		85-E-220000	02.81 08.81 08.81	+ Schaltgetriebe ¹⁾ + Schaltgetriebe ¹⁾	03.0520-0114.3	690114	14,29/180x31 TopKit VW
	2.0 2.2 2.2 2.2	77 85 96		09.83 07.87 02.81 07.84 02.81 07.88 02.81 07.84	+ ⁵⁾	03.0420-0417.3	680417	17,46/200x40 Kit VW
	1.6 1.8 1.9 2.0 2.2 2.2	85 96		02.81 08.81 08.81 07.88 10.80 08.83 09.83 07.88 09.81 07.88 09.81 07.88		24.3727-0136.2 24.3727-0139.2	580136 580139	L=1195 L=1150
	1.6 1.8 1.9 2.0 2.2	100	85-F-000001 85-E-220000	02.81 08.81 10.80 10.80 08.83 09.83	+ ^{6H} ^S	03.6565-0101.3	320097	BRL 6/5 (4) ATE
	1.8 2.0	85-F-000001 85-F-000001		07.88 07.88		03.6585-0108.3	320115	BRL 8/5 (4) ATE
	2.2 2.3	100		09.84 07.88 02.87 07.88		03.2419-8150.3	030019	Gz 19,05
	2.2 2.3	100		09.84 07.88 02.87 07.88		03.2522-4211.3	040017	Nz 22,20

¹⁾ + manual transmission / + scatola cambio velocità / + transmission mécanique / + cambio de velocidad
²⁾ + cast iron / + ghisa / + fonte grise / + fundición de gris
³⁾ + autom.transmission / + scatola cambio automatico / + transmission automatique / + cambio automático
⁴⁾ + aluminium / + alluminio / + aluminium / + aluminio
⁵⁾ without sensor ring / senza sensori / sans secours ABS / sin anillo sensor ABS

AUDI COUPE Quattro (85-87)												
	2.2 2.3	◀			12.84 01.87	12.87 12.87		03.7750-0302.4	300071	9"	ATE	
	2.2 2.3				12.84 01.87	12.87 12.87		03.2122-9612.3	010159	THz 22,20	ATE	
	2.2 2.3				12.84 01.87	12.87 12.87		24.3541-1609.5 24.3541-1610.5 24.0101-4301.2 11.0101-5403.2	240039 240040 260047 260010	□ □	D=54, - Halter D=54, - Halter Bremsattel-Zubehör Fallenbaldsatz	TRW TRW TRW TRW
	2.2 2.3				12.84 01.87	12.87 12.87		13.0460-2926.2	602926		20669 15,7 /S	TRW
	2.2 2.3				12.84 01.87	12.87 12.87		24.0120-0120.1	420120		256 20,0 18,0 V L	
	2.2 2.3				12.84 01.87	12.87 12.87		24.5170-0315.3	331309	2	L=315	
	2.2 2.3				12.84 01.87	12.87 12.87		24.0101-3601.2	260044		Bremsattel-Zubehör	TRW
	2.2 2.3				12.84 01.87	12.87 12.87		13.0460-3602.2	603602		21144 15,8 /S	TRW
	2.2 2.3				12.84 01.87	12.87 12.87		24.0110-0182.1	410182		245 10,0 8,0 +B	
	2.2 2.3				12.84 01.87	12.87 12.87		83.6104-0250.3	330720	2	L=250	
	2.2 2.3				12.84 01.87	12.87 12.87		03.6058-0301.3	320072		BR 25/5 (3)	ATE
	2.2 2.3	◀			12.84 01.87	12.87 12.87		03.2419-8150.3	030019		Gz 19,05	
	2.2 2.3				12.84 01.87	12.87 12.87		03.2522-4211.3	040017		Nz 22,20	

AUDI COUPE (89-96)												
	1.8 2.0 2.0 16V 2.0 20V 2.3 2.3	◀ ◀ ◀ ◀118 ◀98 ◀100		8B-N-500000 08.88 8B-N-500000 08.88 8B-N-500000 01.92 8B-N-500000 08.89 8B-N-500000 03.90 8B-N-500000 08.88				03.7750-0302.4	300071		9"	ATE
	2.3 20V 2.3 20V	123 125		8B-M-020000 08.90 8B-M-020000 08.89				10.0124-3202.3	340011		Hydraulik Verstärker	
	1.8 1.8 2.0 2.0 2.3 2.3 2.3 2.3			08.88 08.89 07.91 - ABS 08.88 07.92 - ABS 08.88 12.96 - ABS 03.90 07.92 - ABS 03.90 07.94 - ABS 08.88 07.92 - ABS 08.88 07.94 - ABS				03.2120-2331.3	010110		THz 20,64	ATE
	2.0 2.3 2.3 2.8	◀ ◀98 ◀100 ◀		08.92 12.96 - ABS/ - Hydraulikverstärker 1) 08.92 12.96 - ABS 08.92 07.94 - ABS 09.91 12.96 - ABS				03.2123-0491.3	010167		THz 23,81	ATE
	2.0 2.3 2.3 2.6 2.8	◀ ◀98 ◀100 ◀ ◀		08.92 12.96 + ABS/ - Hydraulikverstärker 2) 08.92 12.96 + ABS 08.92 07.94 + ABS 08.92 06.94 - Hydraulikverstärker 3) 09.91 06.94 + ABS/ - Hydraulikverstärker 2)				24.2123-1602.3	010384		THz 23,81	TRW
	2.0 2.6 2.8	▶ ▶ ▶		07.94 12.96 + Hydraulikverstärker 4) 08.92 12.96 + Hydraulikverstärker 4) 09.91 12.96 + Hydraulikverstärker 4)				03.2123-0566.3 03.3517-0101.2	010169 390322		THz 23,81 Verschlusschraube	ATE
	2.3 20V 2.3 20V	123 125		08.90 07.91 08.89 07.91				03.2125-3210.3	010212		THz 25,40	ATE
	2.3			08.88	10.88			24.3541-1609.5 24.3541-1610.5 24.0101-4301.2 11.0101-5403.2	240039 240040 260047 260010	□ □	D=54, - Halter D=54, - Halter Bremsattel-Zubehör Fallenbaldsatz	TRW TRW TRW TRW

1) - ABS/ - hydraulic booster / - ABS/ - servofreno idraulico / - ABS/ - amplificateur hydraulique / - ABS/ - servo hidráulico
2) + ABS/ - hydraulic booster / + ABS/ - servofreno idraulico / + ABS/ - amplificateur hydraulique / + ABS/ - servo hidráulico
3) - hydraulic booster / - servofreno idraulico / - amplificateur hydraulique / - servo hidráulico
4) + hydraulic booster / + servofreno idraulico / + amplificateur hydraulique / + servo hidráulico

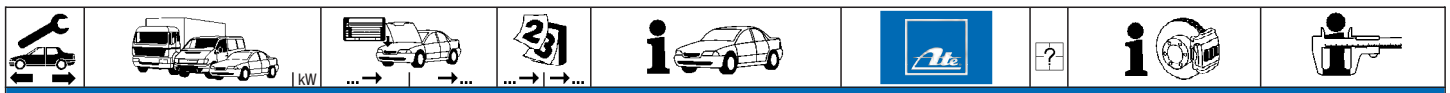

AUDI COUPE (89-96)

	1.8 2.0 2.3 2.3				08.88 05.89 03.90 11.88	07.91 07.92 07.92 07.92			11.3541-8521.2 24.3541-1720.5 24.3541-1719.5 11.0441-5405.2 11.0101-5409.2 11.8171-0008.1 24.0101-4301.2 11.0101-5403.2	220113 240058 240057 250030 260035 990049 260047 260010			D=54, - Halter D=54, - Halter D=54, - Halter Dichtungssatz Hülsensatz Führungsbolzen Bremsattel-Zubehör Fallenbalgsatz	ATE TRW TRW ATE ATE TRW TRW
	2.0 2.3 2.3 2.6	98 100			08.92 08.92 08.92 08.92	12.96 12.96 07.94 12.96			24.3541-1720.5 24.3541-1719.5 24.0101-4301.2 11.0101-5403.2	240058 240057 260047 260010			D=54, - Halter D=54, - Halter Bremsattel-Zubehör Fallenbalgsatz	TRW TRW TRW TRW
	2.3 20V 2.3 20V 2.8	123 125			08.90 08.89 09.91	07.91 07.91 12.96			24.0101-3401.2 11.0101-5403.2	260043 260010			Bremsattel-Zubehör Fallenbalgsatz	TRW TRW
	2.3				08.88	10.88			13.0460-2926.2	602926			20669 15,7 /S	TRW
	1.8 2.0 2.3 2.3 2.6	98 100			08.88 08.88 03.90 11.88 08.92	07.91 12.96 12.96 07.94 12.96			13.0460-2934.2	602934			20669 19,0 /S	TRW
	2.3 20V 2.3 20V 2.8	123 125			08.90 08.89 09.91	07.91 07.91 12.96			13.0460-2963.2	602963			21138 18,8 +/WK/S	TRW
	2.3				08.88	10.88			24.0120-0120.1	420120			256 20,0 18,0 V L	
	1.8 2.0 2.3 2.3	98			08.88 05.89 03.90 11.88	07.91 07.92 07.92 07.92			24.0122-0108.1	422108			256 22,0 20,0 V L +B	
	2.0 2.3 2.3 2.6	98 100			08.92 08.92 08.92 08.92	12.96 12.96 07.94 12.96			24.0122-0139.1	422139			280 22,0 20,0 V L +B	
	2.3 20V 2.3 20V 2.8	123 125			08.90 08.89 09.91	07.91 07.91 12.96			24.0125-0106.1	425106			276 25,0 23,0 V L +B	
	1.8 2.0 2.3				08.88 08.88 08.88				24.5170-0315.3	331309	2		L=315	
	1.8 2.0 2.3 2.6 2.8	8B-L-003792 8B-L-003792 8B-L-003792				07.91 12.96 07.94 12.96 12.96			24.5237-0288.3 24.5170-0161.3	331442 331308	2 2	am Bremsattel 1)	L=288 L=161	
	2.3				08.88	10.88			24.0101-3601.2	260044			Bremsattel-Zubehör	TRW
	1.8 2.0 2.3 2.6 2.8				08.88 08.88 08.88 08.92 09.91	07.91 04.93 04.93 04.93 04.93			24.3384-1601.5 24.3384-1602.5 24.0101-3601.2	240013 240014 260044	 		D=38, - Halter D=38, - Halter Bremsattel-Zubehör	TRW TRW TRW
	2.0 2.3 2.6 2.8				05.93 05.93 05.93 05.93	12.96 07.94 12.96 12.96			24.3384-1709.5 24.3384-1710.5	240257 240258	 		D=38, - Halter D=38, - Halter	TRW TRW
	1.8 2.0 2.3 2.6 2.8				08.88 08.88 08.88 08.92 09.91	07.91 12.96 12.96 12.96 12.96			13.0460-3602.2	603602			21144 15,8 /S	TRW
	1.8 2.0 2.3 2.6 2.8				08.88 08.88 08.88 08.92 09.91	07.91 12.96 07.94 12.96 12.96			24.0110-0178.1	410178			245 10,0 8,0 +B	
	1.8 2.0 2.3				08.88 08.88 08.88	10.88 10.88 10.88			83.6224-0200.3 24.5204-0180.3	330729 331461	 		L=200 L=180	
	2.3	100			08.88	10.88			24.5170-0161.3	331308	2		L=161	
	1.8 2.0 2.3 2.6 2.8				11.88 11.88 11.88 08.92 09.91	07.91 12.96 07.94 12.96 12.96			83.6224-0200.3 83.7804-0150.3 24.5170-0161.3	330729 330853 331308	2	am Bremsattel 1)	L=200 L=150 L=161	
	1.8				08.88	10.88			03.3215-2311.3 24.3215-0903.3	020018 020154		+ GG 2) + ALU 3)	Rz 15,87 Rz 15,87	
	1.8				08.88	10.88			03.0137-0146.2 03.0137-9041.2	650146 669041			200 x 40 HEB Bremsbacken-Zubehör	
	1.8				08.88	10.88			24.0220-0018.1 24.0220-0718.2	480019 480209		ohne Sensorring 4) ohne Sensorring 4)	200/201 x 50 - Lager 200/201 x 50 + Lager	
	1.8 2.0				08.88 08.88	10.88 10.88			24.3727-0136.2 24.3727-0139.2	580136 580139	 		L=1195 L=1150	

1) on the brake caliper / sulla pinza freno / sur l'étrier de frein / a la pinza de freno

2) + cast iron / + ghisa / + fonte grise / + fundición de gris

3) + aluminium / + alluminio / + aluminium / + aluminio

4) without sensor ring / senza sensori / sans secours ABS / sin anillo sensor ABS





AUDI COUPE (89-96)										
	1.8 2.0 2.3 2.6 2.8			11.88 11.88 11.88 08.92 09.91	07.91 04.93 04.93 04.93 04.93		24.3727-0143.2 24.3727-0144.2	580143 580144	<input type="checkbox"/>	L=1398 L=1358
	1.8 2.0 2.0 2.3 2.3 2.6			08.88 08.88 08.88 03.90 08.88 08.92	07.91 12.96 07.94 12.96 07.94 12.96		03.6585-0108.3	320115		BRL 8/5 (4) ATE
	2.3			08.88	10.88		03.2419-8150.3	030019		Gz 19,05
	1.8 2.0 2.3 2.6 2.8			11.88 11.88 11.88 08.92 09.91	07.91 12.96 07.94 12.96 12.96		03.2419-9210.3	030026		Gz 19,05
	2.3			08.88	10.88		03.2522-4211.3	040017		Nz 22,20
	1.8 2.0 2.3 2.6 2.8			11.88 11.88 11.88 08.92 09.91	07.91 12.96 07.94 12.96 12.96		24.2522-1707.3	040103		Nz 22,20

AUDI COUPE Quattro (87-96)										
	2.2 2.3 2.3	◀100 ◀98 ◀100		01.88 05.90 01.88	07.91 12.96 07.94		03.7750-0302.4	300071		9" ATE
	2.0 2.3 20V 2.3 20V S2 S2	◀ ◀123 ◀125 ◀162 ◀169		11.88 05.90 11.88 09.90 10.92	07.91 + F ① 12.96 07.91 09.92 12.96		10.0124-3202.3	340011		Hydraulik Verstärker
	2.0 2.6 2.8	◀ ▶ ▶		11.88 08.92 08.91	07.91 + F ① 12.96 + Hydraulikverstärker 1) 12.96 + Hydraulikverstärker 1)		03.2123-0566.3 03.3517-0101.2	010169 390322		THz 23,81 Verschlußschraube ATE
	2.2 2.3 2.3	100 98 100		01.88 05.90 01.88	07.91 - ABS 12.96 - ABS 07.94 - ABS		03.2122-9612.3	010159		THz 22,20 ATE
	S2 S2	162 169		09.90 10.92	09.92 12.96		03.2125-3610.3	010214		THz 25,40 ATE
	2.3 20V 2.3 20V	123 125		05.90 11.88	12.96 07.91		03.2125-3210.3	010212		THz 25,40 ATE
	2.2 2.3 2.3 2.6	100 98 100		01.88 05.90 01.88 08.92	07.91 07.92 07.92 12.96		11.3541-8521.2 24.3541-1720.5 24.3541-1719.5 11.0441-5405.2 11.0101-5409.2 11.8171-0008.1 24.0101-4301.2 11.0101-5403.2	220113 240058 240057 250030 260035 990049 260047 260010	<input type="checkbox"/> <input type="checkbox"/> <input type="checkbox"/>	D=54, - Halter ATE D=54, - Halter TRW D=54, - Halter TRW Dichtungssatz ATE Hülssensatz ATE Führungsbolzen ATE Bremsattel-Zubehör TRW Fallenbalgsatz TRW
	2.3 2.3	98 100		08.92 08.92	12.96 07.94		24.3541-1720.5 24.3541-1719.5 24.0101-4301.2 11.0101-5403.2	240058 240057 260047 260010	<input type="checkbox"/> <input type="checkbox"/>	D=54, - Halter TRW D=54, - Halter TRW Bremsattel-Zubehör TRW Fallenbalgsatz TRW
	2.0 2.3 20V 2.3 20V 2.8 S2 S2	8B-L-003001 123 8B-L-003001 125 8B-L-003001 162 169		07.91 12.96 07.91 08.91 09.90 10.92	+ F ① 12.96 07.91 12.96 09.92 12.96		24.0101-3401.2 11.0101-5403.2	260043 260010		Bremsattel-Zubehör TRW Fallenbalgsatz TRW
	2.2 2.3 2.3 2.6	100 98 100		01.88 05.90 01.88 08.92	07.91 12.96 07.94 12.96		13.0460-2934.2	602934		20669 19,0 / S TRW
	2.0 2.3 20V 2.3 20V 2.8 S2 S2	123 125 162 169		11.88 05.90 11.88 08.91 09.90 10.92	07.91 + F ① 12.96 07.91 12.96 09.92 12.96		13.0460-2963.2	602963		21138 18,8 +WK/S TRW
	2.0 2.3 20V 2.3 20V 2.8	123 125		11.88 05.90 11.88 08.91	07.91 + F ① 12.96 07.91 12.96 + 15" Rad 2)		24.0125-0106.1	425106		276 25,0 23,0 V L +B
	2.2 2.3 2.3	100 98 100	8B-N-015000 8B-N-015000 8B-N-015000	01.88 05.90 01.88			24.0122-0108.1	422108		256 22,0 20,0 V L +B
	2.3 2.3 2.6	98 100	8B-P-000001 8B-P-000001	12.96 07.94 08.92			24.0122-0139.1	422139		280 22,0 20,0 V L +B
	2.6 2.8 S2 S2	162 169		08.92 08.91 09.90 10.92	12.96 + 15" Rad 2) 12.96 + 16" Rad 3) 12.96 + 16" Rad 3) 09.92 12.96		24.0125-0139.1	425139		276 24,9 23,0 V L +B

1) + hydraulic booster / + servofreno idraulico / + amplificateur hydraulique / + servo hidráulico

2) + 15" wheel / + ruota 15" / + roue 15" / + rueda 15"

3) + 16" wheel / + ruota 16" / + roue 16" / + rueda 16"



AUDI COUPE Quattro (87-96)

	2.0		8B-L-003000	11.88	+ (F) (I)	24.5170-0315.3	331309	2		L=315
	2.2	100	8B-L-003000	01.88						
	2.3	98	8B-L-003000	05.90						
	2.3	100	8B-L-003000	01.88						
	2.3 20V	123	8B-L-003000	05.90						
2.3 20V	125	8B-L-003000	11.88		24.5113-0380.3	331344	2		L=382	
	2.0		8B-L-003001	07.91	+ (F) (I)	24.5237-0288.3	331442	2	am Bremsattel 1)	L=288
	2.2	100	8B-L-003001	07.91						
	2.3	98	8B-L-003001	12.96						
	2.3	100	8B-L-003001	07.94						
	2.3 20V	123	8B-L-003001	12.96						
	2.3 20V	125	8B-L-003001	07.91						
	2.6			08.92	12.96					
	2.8			08.91	12.96					
	S2	162		09.90	09.92					
	S2	169		10.92	12.96					
		2.0			11.88					
2.2		100		01.88	07.91					
2.3		98		05.90	12.96					
2.3		100		01.88	07.94					
2.3 20V		123		05.90	12.96					
2.3 20V		125		11.88	07.91					
2.6				08.92	12.96					
2.8				08.91	12.96					
S2		162		09.90	09.92					
S2		169		10.92	12.96					
		2.0			11.88	07.91	13.0460-3602.2	603602		
	2.2	100		01.88	07.91					
	2.3	98		05.90	12.96					
	2.3	100		01.87	07.94					
	2.3 20V	123		05.90	12.96					
	2.3 20V	125		11.88	07.91					
	2.6			08.92	12.96					
	2.8			08.91	12.96					
	S2	162		09.90	09.92					
	S2	169		10.92	12.96					
		2.0			11.88	07.91				
2.2		100		01.88	07.91					
2.3		98		05.90	12.96					
2.3		100		01.88	07.94					
2.3 20V		123		05.90	12.96					
2.3 20V		125		11.88	07.91					
2.6				08.92	12.96 + 15" Rad 2)					
2.8				08.91	12.96 + 15" Rad 2)					
S2		162		09.90	12.96 + 15" Rad 2)					
S2		169		10.92	12.96 + 15" Rad 2)					
		2.6			08.92	12.96 + 16" Rad 3)	24.0110-0261.1	410261		
	2.8			08.91	12.96 + 16" Rad 3)					
	S2	162		09.90	12.96 + 16" Rad 3)					
	S2	169		10.92	12.96 + 16" Rad 3)					
	S2	169		10.92	12.96 + 16" Rad 3)					
	2.0			11.88	07.91	83.6104-0250.3	330720	2		L=250
	2.2	100		01.88	07.91					
	2.3	98		05.90	12.96					
	2.3	100		01.88	07.94					
	2.3 20V	123		05.90	12.96					
	2.3 20V	125		11.88	07.91					
	2.6			08.92	12.96					
	2.8			08.91	12.96					
	S2	162		09.90	09.92					
	S2	169		10.92	12.96					
		2.0			11.88					
2.2		100		01.88	07.91					
2.3		98		05.90	12.96					
2.3		100		01.88	07.94					
2.3 20V		123		05.90	12.96					
2.3 20V		125		11.88	07.91					
2.6				08.92	12.96					
2.8				08.91	12.96					
S2		162		09.90	09.92					
S2		169		10.92	12.96					
		2.0			11.88	07.91	24.2522-1707.3	040103		
	2.2	100		01.88	07.91					
	2.3	98		05.90	12.96					
	2.3	100		01.88	07.94					
	2.3 20V	123		05.90	12.96					
	2.3 20V	125		11.88	07.91					
	2.6			08.92	12.96					
	2.8			08.91	12.96					
	S2	162		09.90	09.92					
	S2	169		10.92	12.96					

AUDI QUATTRO (80-91)

	2.2	◀119	85-H-902400	08.84		10.0522-4005.1	340029			Warnschalter M10x1
	2.2	◀147	85-H-902400	07.80						
						10.0515-0515.3	340024			Hydraulikspeicher
										ATE

1) on the brake caliper / sulla pinza freno / sur l'étrier de frein / a la pinza de freno

2) + 15" wheel / + ruota 15" / + roue 15" / + rueda 15"

3) + 16" wheel / + ruota 16" / + roue 16" / + rueda 16"



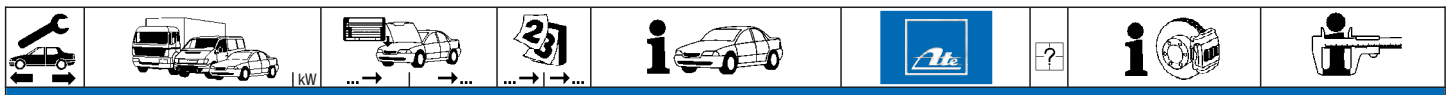































AUDI QUATTRO (80-91)

	2.2	85-C-901032	85-H-900550			03.2123-8512.3	010194			Thz 23,81	ATE
	2.2	85-H-900551		07.91		03.2125-2510.3	010209			Thz 25,40	ATE
	2.2	119 85-D-900001	85-G-902400			24.3541-1719.5	240057			D=54, - Halter	TRW
	2.2	147 85-D-900001	85-G-902400			24.3541-1720.5	240058			D=54, - Halter	TRW
						24.0101-4301.2	260047			Bremssattel-Zubehör	TRW
						11.0101-5403.2	260010			Faltenbalgsatz	TRW
	2.2		85-C-902000	07.80		13.0460-2934.2	602934			20669 19,0 /S	TRW
	2.2	119 85-D-900001	85-G-902400			13.0460-2925.2	602925			20901 19,0 +/WK/S	TRW
	2.2	147 85-D-900001	85-G-902400								
	2.2	119 85-H-900001		07.89		13.0460-2963.2	602963			21138 18,8 +/WK/S	TRW
	2.2	147 85-H-900001		07.91							
	2.2	162 85-H-900001		07.91							
	2.2	119	85-G-902400	08.84		24.0122-0120.1	422120			280 22,0 20,0 V L	
	2.2	147	85-G-902400	07.80							
	2.2	119 85-H-900001		07.89		24.0125-0102.1	425102			276 25,0 23,0 V L	
	2.2	147 85-H-900001		07.91							
	2.2	162 85-H-900001		07.91							
	2.2	119	85-G-902400	08.84		83.6134-0332.3	330716	2		L=330	
	2.2	147	85-G-902400	07.80							
	2.2	119 85-H-900001		07.89		24.5113-0380.3	331344	2		L=382	
	2.2	147 85-H-900001		07.91							
	2.2	162 85-H-900001		07.91							
	2.2	119 85-E-900001		07.89		24.0101-3601.2	260044			Bremssattel-Zubehör	TRW
	2.2	147 85-E-900001		07.91							
	2.2	162		08.89	07.91	24.3434-1701.5	240357			D=43, - Halter	TRW
						24.3434-1702.5	240358			D=43, - Halter	TRW
						11.0101-5403.2	260010			Faltenbalgsatz	TRW
	2.2	119		08.84	07.89	13.0460-3602.2	603602			21144 15,8 /S	TRW
	2.2	147		07.80	07.91						
	2.2	162		07.80	07.91						
	2.2	119		08.84	07.89	24.0110-0154.1	410154			245 10,0 8,0	
	2.2	147		07.80	07.91						
	2.2	162		08.89	07.91	24.0120-0172.1	420172			269 19,9 18,0 V L	
	2.2		85-D-902500	07.80		24.5170-0315.3	331309	2		L=315	
	2.2	119 85-E-900001		07.89		83.6104-0250.3	330720	2		L=250	
	2.2	147 85-E-900001		07.91							
	2.2	162 85-E-900001		07.91							
	2.2	119		08.84	07.89	03.6058-0301.3	320072			BR 25/5 (3)	ATE
	2.2	147		07.80	07.91						
	2.2			07.80	07.91	03.2419-8150.3	030019			Gz 19,05	
	2.2		85-J-900108	07.80		03.2522-4211.3	040017			Nz 22,20	
	2.2	85-J-900109		07.91		24.2522-1707.3	040103			Nz 22,20	

AUDI V8 (88-94)

	3.6			10.88	02.94	10.0124-3202.3	340011			Hydraulik Verstärker	
	4.2			10.91	02.94						
	3.6			10.88	02.94	03.2125-3610.3	010214			Thz 25,40	ATE
	4.2			10.91	02.94						
	3.6			10.88	02.94	13.0460-2847.2	602847	2	07.90-	21219 17,8 +/WE	ATE
	4.2			10.91	02.94	24.8190-0105.2	620105			Warnkontakt L=240mm	
	3.6			10.88	02.94	83.7813-0252.3	330796	2		L=250	
	4.2			10.91	02.94						
	3.6			10.88	02.94	24.3434-1702.5	240358			D=43, - Halter	TRW
	4.2			10.91	02.94	24.3434-1701.5	240357			D=43, - Halter	TRW
						11.0101-5403.2	260010			Faltenbalgsatz	TRW
	3.6			10.88	02.94	13.0460-3602.2	603602			21144 15,8 /S	TRW
	4.2			10.91	02.94						
	3.6			10.88	02.94	24.0120-0172.1	420172			269 19,9 18,0 V L	
	4.2			10.91	02.94						
	3.6		4C-M-020000	10.88		24.5113-0220.3	331318	2		L=220	
	3.6		4C-N-000001		02.94	24.5113-0209.3	331300	2		L=209	
	4.2			10.91	02.94						
	3.6			10.88	02.94	03.2419-9610.3	030029			Gz 19,05	
	3.6			10.88	02.94	24.2522-1707.3	040103			Nz 22,20	
	4.2			10.91	02.94						

								
AUSTIN METRO (80-90)								
	1.0 1.3 1.3 Turbo		10.80 10.80 10.83	05.90 05.90 05.90	03.0137-0080.2 03.0137-9200.2	650080 669200		178 x 32 Bremsbacken-Zubehör AP AP
AUSTIN MINI (67-93)								
	0.85 1.0 1.0 1.0 HLE Mayfair 1.0 Mayfair Sport 1.1 Special 1.275 GT 1.3		10.67 10.67 01.92 08.82 09.88 10.76 10.69 01.92	08.79 09.84 06.93 06.93 06.93 08.81 08.80 + 12" Rad 1) 06.93	13.0460-6914.2	606914		20038 14,0 AP
	0.85 1.0 1.0 1.0 HLE Mayfair 1.0 Mayfair Sport 1.1 Special 1.275 GT		10.67 10.67 01.92 08.82 09.88 10.76 10.69	08.79 09.84 06.93 06.93 06.93 08.81 08.80	24.0110-0239.1	410239		214 9,6 8,6
	1.0 1.0 HLE Mayfair 1.1 Special	31 33	01.69 08.82 10.76	12.84 12.84 08.81	24.2723-1401.3 24.2723-1402.3	020342 020350	2  2 	Rz 23,81 Rz 23,81
	1.0 1.0 1.0 HLE Mayfair 1.0 Mayfair Sport 1.1 Special	30 31 30 33	10.67 01.92 08.82 09.88 10.76	09.84 06.93 06.93 06.93 08.81	24.3219-1401.3	020351		Rz 19,05 AP
	1.0 1.0 1.0 HLE Mayfair 1.0 Mayfair Sport 1.1 Special 1.3	30 31 30 33	10.67 10.67 08.82 09.88 10.76 01.92	09.84 06.93 06.93 06.93 08.81 06.93	03.0137-0080.2 03.0137-9205.2	650080 669205		178 x 32 Bremsbacken-Zubehör AP AP
AUTO UNION AU 1000 (58-65)								
	1.0 1.0 S		04.58 08.59	06.65 03.64	03.3215-0221.3	020013		Rz 15,87
AUTOBIANCHI A 111 (69-72)								
	1.4		08.69	11.72	13.0460-3936.2	603936		20073 17,3 BDX
	1.4		08.69	11.72	24.0111-0130.1	411130		227 10,8 9,0 +B
	1.4		08.69	11.72	24.0111-0130.1	411130		227 10,8 9,0 +B
AUTOBIANCHI A 112 (69-86)								
	0.9 1.0		10.69 11.77	12.85 12.85	24.2119-0806.3	010345		THz 19,05
	0.9 1.0 1.0 Abarth		10.69 11.77 09.71	12.85 12.85 12.84	13.0460-3936.2	603936		20073 17,3 BDX
	0.9 1.0 1.0 Abarth		10.69 11.77 09.71	12.85 12.85 12.84	24.0111-0130.1	411130		227 10,8 9,0 +B
	0.9 1.0 1.0 Abarth		10.69 11.77 09.71	10.82 10.82 10.82	24.3219-0801.3	020181		Rz 19,05 FI
	0.9 1.0 1.0 Abarth		11.82 11.82 11.82	12.85 12.84 12.84	24.3219-0803.3	020183		Rz 19,05
	0.9 1.0 1.0 Abarth		10.69 11.77 09.71	12.85 12.85 12.84	03.0137-0015.2 03.0137-9021.2	650015 669021		185 x 31 AUT Bremsbacken-Zubehör FI FI
	0.9 1.0 1.0 Abarth		10.69 11.77 09.71	12.85 12.85 12.84	24.0218-5001.1	480012		185/186,8 x 37
	0.9 1.0 1.0 Abarth		11.82 11.82 11.82	12.85 12.84 12.84	03.0420-0319.3	680319		19,05/185x31 Kit FI
AUTOBIANCHI GIADINIERA (60-78)								
	120 120 F		01.60 01.60	12.78 12.78	24.3219-0801.3	020181		Rz 19,05 FI
	120 120 F		01.60 01.60	12.78 12.78	24.3219-0801.3	020181		Rz 19,05 FI

1) + 12" wheel / + ruota 12" / + roue 12" / + rueda 12"



AUTOBIANCHI Y 10 (85-95)

	1.0 1.0 i.e. 1.1 i.e. 1.1 Turbo 1.3 GT i.e.		06.85 12.87 01.90 06.85 02.89	12.89 12.89 12.92 12.89 12.92	24.2120-0801.3	010362		THz 20,64	
	1.1 i.e. 1.3 GT i.e.		01.93 01.93	12.95 12.95	24.2120-1733.3	010686		THz 20,64	
	1.0 1.0 i.e. 1.1 i.e.		06.85 12.87 01.90	12.89 12.89 12.95	13.0460-3940.2 13.0460-0410.2	603940 610410		20775 18,0 /WK Belagsatz-Zubehör	BDX BDX
	1.1 Turbo 1.3 GT i.e.		06.85 02.89	12.89 12.95	13.0460-2941.2	602941		20839 17,0 /WK/S	TRW
	1.0 1.0 i.e. 1.1 i.e.		06.85 12.87 01.90	12.89 12.89 12.95	24.0111-0130.1	411130		227 10,8 9,0 +B	
	1.1 Turbo 1.3 GT i.e.		06.85 02.89	12.89 12.95	24.0112-0122.1	412122		240 12,0 10,8	
	1.0 1.0 i.e. 1.1 i.e.		06.85 12.87 01.90	12.89 12.89 12.95	24.3219-0803.3	020183		Rz 19,05	
	1.1 Turbo 1.3 GT i.e.		06.85 02.89	12.89 12.95					
	1.0 1.0 i.e. 1.1 i.e.		06.85 12.87 01.90	12.89 12.89 12.95	03.0137-0015.2 03.0137-0273.2 03.0137-9021.2	650015 650273 669021		185 x 31 AUT 185 x 31 AUT Bremsbacken-Zubehör	FI AP FI
	1.1 Turbo 1.3 GT i.e.		06.85 02.89	12.89 12.95					
	1.0 1.0 i.e. 1.1 i.e.		06.85 12.87 01.90	12.89 12.89 12.95	24.0218-5001.1	480012		185/186,8 x 37	
	1.1 Turbo 1.3 GT i.e.		06.85 02.89	12.89 12.95					
	1.0 1.0 i.e. 1.1 i.e.		06.85 12.87 01.90	12.89 12.89 12.95	03.0420-0319.3 03.0520-4319.3	680319 694319		19,05/185x31 Kit 19,05/185x31 TopKit	FI AP
	1.1 Turbo 1.3 GT i.e.		06.85 02.89	12.89 12.95					
	1.0 1.0 i.e. 1.1 i.e.		06.85 12.87 01.90	12.89 12.89 12.92	24.3727-0519.2	580519	1	L=2385	
	1.1 Turbo 1.3 GT i.e.		06.85 02.89	12.89 12.92					
	1.0 4WD 1.0 i.e. 4WD 1.1 i.e. 4WD		06.85 12.87 01.90	12.89 12.89 12.95	24.3727-0503.2	580503	1	L=2670	
	1.0 1.0 i.e. 1.1 i.e.		06.85 12.87 01.90	12.89 12.89 12.95	24.6513-0801.3	320117		BRL 1/3 (2)	
	1.1 Turbo 1.3 GT i.e.		06.85 02.89	12.89 12.95					

BMW 501 / 502 (55-60)

	2.1		01.55	12.59	03.3122-0502.3	010282		Hz 22,20	ATE
	2.6		01.56	12.60	03.3122-0502.3	010282	03.3517-0300.1 mitverwenden	Hz 22,20	ATE
	3.2		01.55	12.59	03.3517-0300.1	390323	2	Verschlußschraube	

BMW 700 / 700 Coupe (59-66)

	0.7	22	01.59	11.66	24.3215-1105.3	020159		Rz 15,87	
	0.7 A / 0.7 S	24	01.59	11.66					

BMW 1502 - 2002 (65-77)

	1600 2	◀	01.69	12.71 + Bremsgerät 1)	03.2120-3412.3	010121		THz 20,64	ATE
	1600 2 ti	◀ 1588671		12.71					
	1600 Touring	◀	01.71	12.73					
	1602	◀	01.71	12.75					
	1800 Touring	◀	01.71	12.73					
	1802	◀	01.71	12.75					
	1802 Touring	◀	01.73	12.75					
	2000 Touring	◀	01.69	12.71					
	2002	◀	01.69	12.75					
	1800	◀	01.69	12.71	03.2123-6802.3	010186		THz 23,81	ATE
	2000	◀	01.69	12.71					
	2000 tii	◀	01.69	12.75					
	2002 ti/tii	◀	01.69	12.75					
	2002 Turbo	◀	01.73	12.75					
	1502	55	01.75	12.77	03.3508-5851.3	310039	+ Kupplungsabgang 2)	Behälter	
	1600 2		01.69	12.71	03.3508-5951.3	310041	- Kupplungsabgang 3)	Behälter	
	1600 2 ti		01.67	12.71	03.3508-5959.3	310044	- Kupplungsabgang 3)	Behälter + WE	
	1600 Touring		01.71	12.73					
	1602		01.71	12.75					
	1800 Touring		01.71	12.73					
	1802		01.71	12.75					
	1802 Touring		01.73	12.75					
	2000 Touring		01.69	12.71					







1) + booster unit / + servofreno / + servo-frein / + servofreno

2) + outlet port for clutch / + potenz.in uscita lato frizi. / + sortie d'embrayage / + salida conexión embrague

3) - outlet port for clutch / - uscita per frizione / - sortie d'embrayage / - salida conexión embrague



BMW 1502 - 2002 (65-77)



















	2002			01.69	12.75		03.3508-5851.3 310039 03.3508-5951.3 310041 03.3508-5959.3 310044	+ Kupplungsabgang ¹⁾ - Kupplungsabgang ²⁾	Behälter Behälter Behälter + WE
	1502	55		01.75	12.77		13.0441-4825.2 250107		Dichtungssatz ATE
	1600 2	1870200		12.71	12.71		13.4341-8002.2 210152	<input type="checkbox"/>	D=34
	1600 2 ti	1588671		12.71	12.71		13.4341-8001.2 210151	<input type="checkbox"/>	D=34
	1600 Touring			01.71	12.73		13.0441-3401.2 250044		Dichtungssatz ATE
	1602			01.71	12.75				
	1800 Touring			01.71	12.73				
	1802			01.71	12.75				
	1802 Touring			01.73	12.75				
	2000 Touring			01.69	12.73				
	2002	1624531		12.75	12.75				
	1800			01.69	12.71		13.4401-8022.2 210190	<input type="checkbox"/>	D=40
	2000			01.69	12.71		13.4401-8021.2 210189	<input type="checkbox"/>	D=40
	2000 tii			01.69	12.75		13.0441-4018.2 250083		Dichtungssatz ATE
	2002 ti/tii			01.69	12.75				
	2002 Turbo			01.73	12.75		13.0441-4018.2 250083		Dichtungssatz ATE
	1502	55		01.75	12.77		13.0460-4033.2 604033 13.0460-0038.2 610038		20034 15,0 ATE Belagsatz-Zubehör ATE
	1600 2	1870200		12.71	12.71		13.0460-5029.2 605029		20126 15,0 ATE
	1600 2 ti	1588671		12.71	12.71		13.0460-0018.2 610018		Belagsatz-Zubehör ATE
	1600 Touring			01.71	12.73				
	1602			01.71	12.75				
	1800 Touring			01.71	12.73				
	1802			01.71	12.75				
	1802 Touring			01.73	12.75				
	2000 Touring			01.69	12.73				
	2002	1624531		12.75	12.75				
	1800			01.69	12.71		13.0460-9030.2 609030		20092 15,0 ATE
	2000			01.69	12.71				
	2000 tii			01.69	12.75				
	2002 ti/tii			01.69	12.75				
	2002 Turbo			01.73	12.75				
	1502	55		01.75	12.77		24.0110-0109.1 410109		240 10,0 8,4
	1600 2	1870200		12.71	12.71				
	1600 2 ti	1588671		12.71	12.71				
	1600 Touring			01.71	12.73				
	1602			01.71	12.75				
	1800 Touring			01.71	12.73				
	1802			01.71	12.75				
	1802 Touring			01.73	12.75				
	2000 Touring			01.69	12.73				
	2002	1624531		12.75	12.75				
	1600 2			01.66	12.68		83.7704-0290.3 330826	2	L=290
	1600 2 ti			01.67	12.68				
	2000			01.66	12.69				
	2002			01.68	12.69				
	1502	55		01.75	12.77		24.5201-0290.3 331401	4	L=290
	1600 2			01.69	12.71				
	1600 2 ti			01.69	12.71				
	1600 Touring			01.71	12.73				
	1602			01.71	12.75				
	1800 Touring			01.71	12.73				
	1802			01.71	12.75				
	1802 Touring			01.73	12.75				
	2000 Touring			01.69	12.73				
	2002			01.70	12.75				
	1502	55		01.75	12.77		24.5201-0204.3 331400	2	L=204
	1600 2			01.69	12.71				
	1600 2 ti			01.67	12.71				
	1600 Touring			01.71	12.73				
	1602			01.71	12.75				
	1800 Touring			01.71	12.73				
	1802			01.71	12.75				
	1802 Touring			01.73	12.75				
	2000 Touring			01.69	12.71				
	2002			01.69	12.75				
	1800			01.69	12.71		03.3217-0602.3 020024		03.3518-0200.2 mitverwenden ³⁾ Rz 17,46
	1800 ti			01.65	12.71				
	2000			01.65	12.71				
	2000 C/CA/CS			01.65	12.71				
	2000 ti/tilux			01.66	12.71				
	2002			01.68	12.71				
	2002 ti			01.69	12.75				
	2002 ti/tii			01.69	12.75				
	1502	55		01.75	12.77	- (S)	24.3215-1105.3 020159		Rz 15,87
	1600 2 ti			01.67	12.71				
	1800 Touring			01.71	12.73				
	1802			01.71	12.75	- (S)			
	1802 Touring			01.73	12.75	- (S)			
	2000 Touring			01.69	12.73				
	2002			01.68	12.75	- (S)			
	1600 2			01.66	12.71		24.3217-1707.3 020108		Rz 17,46
	1600 Touring			01.71	12.73				

¹⁾ + outlet port for clutch / + potenz.in uscita lato frizi. / + sortie d'embrayage / + salida conexión embrague

²⁾ - outlet port for clutch / - uscita per frizione / - sortie d'embrayage / - salida conexión embrague



























³⁾ 03.3518-0200.2 reuse / 03.3518-0200.2 riutilizzare / 03.3518-0200.2 utiliser / 03.3518-0200.2 emplear



								
BMW 1502 - 2002 (65-77)								
	1602 2000 tii 2002 ti/tii 2002 Turbo		01.71 01.69 01.69 01.73	12.75 12.75 12.75 12.75	- (S)	24.3217-1707.3	020108	Rz 17,46
	1800 2000		01.69 01.65	12.71 12.71		03.0137-0009.2	650009	250 x 42 HEB
	1600 2 1600 Touring 1602 1800 2000		01.66 01.71 01.71 01.69 01.65	12.71 12.73 12.75 12.71 12.71		24.0220-0007.1	480015	200/201 x 45
	1502 1600 2 ti 1800 Touring 1802 1802 Touring 2000 Touring 2002	55	01.75 01.67 01.71 01.71 01.73 01.69 01.68	12.77 12.71 12.73 12.75 12.75 12.73 12.75		24.0225-0001.1	480043	250/251 x 47
	1502 1600 Touring 1602 1800 Touring 1802 2000 Touring 2002	55	01.75 01.71 01.71 01.71 01.69 01.69	12.77 12.73 12.75 12.73 12.71 12.75		24.3727-0202.2	580202	L=1528
	1502	55	01.75	12.77	+(S)	03.6058-0501.3	320074	BR 25/5 (4) ATE
	1600 4 1800 1800 ti	◀ ◀ ◀	931262 976908 985060	12.67 01.69 10.63		03.0350-1508.2 03.3304-0700.1	071508 390082	Gz Reparatursatz Behälterstopfen
	1502 1600 Touring 1602 1800 Touring 1802 1802 Touring 2002	◀ 55 ◀ ◀ ◀ ◀ ◀ ◀	01.75 01.71 01.71 01.71 01.71 01.73 01.69	12.77 12.73 12.75 12.73 12.75 12.75 12.75		03.2419-7800.3 03.0350-1919.2	030016 071919	Gz 19,05 Gz Reparatursatz
	1600 4 1800 1800 ti 2000 2000 C/CA/CS 2000 ti/tilux 2002 2002 ti	◀ ◀ ◀ ◀ ◀ ◀ ◀ ◀	931263 976909 985061 1907278 1962744 1109264 1626693 1681795	12.75 12.75 01.65 01.65 01.66 01.69 01.69		03.2519-1402.3	040005	Nz 19,05
	1502 1600 Touring 1602 1800 1800 Touring 1802 1802 Touring 2000 2000 C/CA/CS 2002 2002 ti	◀ 55 ◀ ◀ ◀ 1907279 ◀ ◀ ◀ ◀ 1962745 ◀ 1109265 ◀ 1626694 ◀ 1681796	01.75 01.71 01.71 01.71 01.71 01.73 12.71 12.71 12.75 12.75	12.77 12.73 12.75 12.71 12.73 12.75 12.71 12.71 12.75 12.75		03.2520-1001.3	040009	Nz 20,64
	1502 1600 4 1800 1800 ti 2000	55	01.75 01.65 01.69 01.65 01.65	07.77 12.75 12.71 12.75 12.71		24.5201-0204.3	331400	L=204
BMW 2000 (66-69)								
	2000		01.66	12.69		13.0441-5406.2	250110	Dichtungssatz ATE
BMW 2,5/2,8/3,0/3,3 (68-77)								
	2.5 CS 2500 2800 3.0 CS 3.0 S/CS 3.0 S/LS/CS 2800 CS 2.8 3.0 S/CS 3.0 S/LS/CS 3.3	◀ ◀ ◀ ◀ ◀ ◀ ◀ ◀ ◀ ◀ ◀ ◀	01.74 01.69 01.69 01.71 01.71 01.71 01.70 01.75 01.73 01.73 01.74	12.77 12.77 12.77 12.72 + Automatikgetriebe 1) 12.72 12.77 + Schaltgetriebe 2) 12.77 12.77 12.77 12.77 + Automatikgetriebe 1) 12.77		03.2122-6202.3	010148	THz 22,20 ATE
	2800 CS	◀	01.70	12.72		03.2123-6802.3	010186	THz 23,81 ATE
	2.8 3.0 S/CS 3.0 S/LS/CS 3.3	◀ ◀ ◀ ◀	01.75 01.73 01.73 01.74	12.77 12.77 12.77 + Automatikgetriebe 1) 12.77		03.2123-7002.3	010187	THz 23,81 ATE

1) + autom.transmission / + scatola cambio automatico / + transmission automatique / + cambio automático

2) + manual transmission / + scatola cambio velocità / + transmission mécanique / + cambio de velocidad

	 kW							
BMW 2,5/2,8/3,0/3,3 (68-77)								
	2.5 CS 2500 2800 3.0 S/LS/CS 3.3			01.74 12.77 01.69 12.77 01.69 12.77 01.71 12.77 01.74 12.77		03.3508-5959.3 310044	- Kupplungsabgang ¹⁾	Behälter + WE
	2.5 CS 2500 2800 2.8 3.0 S/LS/CS 3.3			01.74 12.77 01.69 12.77 01.69 12.77 01.75 12.77 01.71 12.77 01.74 12.77		13.4401-8021.2 210189 13.4401-8022.2 210190 13.0441-4018.2 250083 13.0441-4018.2 250083	<input type="checkbox"/> <input type="checkbox"/>	D=40 D=40 Dichtungssatz ATE Dichtungssatz ATE
	2.5 CS 2500 2800 3.0 S/LS/CS 3.3			01.74 12.77 01.69 12.77 01.69 12.77 01.71 12.77 01.74 12.77		13.0460-9030.2 609030		20092 15,0 ATE
	2.5 CS 2500 2800 3.0 S/LS/CS 3.3			01.74 12.77 01.69 12.77 01.69 12.77 01.71 12.77 01.74 12.77		24.5201-0290.3 331401	4	L=290
	2.5 CS 2500 2800 2.8 3.0 S/LS/CS 3.3			01.74 12.77 01.69 12.77 01.69 12.77 01.75 12.77 01.71 12.77 01.74 12.77		13.2421-8005.2 210053 13.2421-8006.2 210054 24.9242-8005.5 230027 24.9242-8006.5 230028 13.0441-4205.2 250086 24.9242-8007.5 230029 24.9242-8008.5 230030 13.0441-4205.2 250086	<input type="checkbox"/> <input type="checkbox"/> <input type="checkbox"/> <input type="checkbox"/> <input type="checkbox"/> <input type="checkbox"/> <input type="checkbox"/>	D=42 ATE D=42 ATE D=42 ATE D=42 ATE Dichtungssatz ATE D=42 ATE D=42 ATE Dichtungssatz ATE
	2.5 CS 2.8 3.0 S/CS 3.0 S/LS/CS 3.3			01.74 12.77 01.75 12.77 01.71 12.77 01.71 12.77 01.74 12.77		13.0460-3024.2 603024		20436 15,0 /WE ATE
	2.8 2500 2800 3.0 S/LS 3.3			01.75 12.77 01.69 12.77 01.69 12.77 01.71 12.77 01.74 12.77		24.5170-0201.3 331450 24.5201-0204.3 331400	<input type="checkbox"/> <input type="checkbox"/>	L=201 L=204
	2.5 CS 2800 CS 3.0 CS			01.74 12.77 01.70 12.72 01.71 12.77		24.5201-0204.3 331400	2	L=204
	2800 CS			01.70 12.72		03.3222-4211.3 020075		Rz 22,20
	2.5 CS 2500 2800 3.0 S/LS/CS 3.3			01.74 12.77 01.69 12.77 01.69 12.77 01.71 12.77 01.74 12.77		03.0137-0149.2 650149		160 x 25
	2.5 CS 2500 2800 3.0 S/LS/CS 3.3	◀		01.74 05.75 01.69 05.75 01.69 05.75 01.71 05.75 01.74 05.75		03.0350-1919.2 071919		Gz Reparatursatz
	2.5 CS 2500 2800 3.0 S/LS/CS 3.3	◀		06.75 12.77 06.75 12.77 06.75 12.77 06.75 12.77 06.75 12.77		03.0350-1919.2 071919		Gz Reparatursatz
	2.5 CS 2500 2800 3.0 S/LS/CS 3.3	▶		01.74 12.77 01.69 12.77 01.69 12.77 01.71 12.77 01.74 12.77		03.0350-1919.2 071919		Gz Reparatursatz
	2500 2800 3.0 S/LS/CS			01.69 08.73 01.69 08.73 01.71 08.73		03.2522-3001.3 040013		Nz 22,20
	2.5 CS 2500 2800 3.0 S/LS/CS 3.3			09.73 12.77 09.73 12.77 09.73 12.77 09.73 12.77 09.73 12.77		03.2522-3601.3 040014		Nz 22,20
BMW 3er Reihe/E21 (75-83)								
	315 316 318 318 i 320 i 320/4 320/6 323 i	◀		04.81 12.83 06.75 07.83 06.75 08.80 06.75 06.82 10.75 07.78 06.75 07.79 10.77 10.82 02.78 10.82	- (USA) - (USA) - (USA) - (USA) - (USA) - (USA) - (USA)	03.2120-0622.3 010079		THz 20,64 ATE
	315 316	▶		04.81 12.82 08.77 07.83		03.2120-0562.3 010078		THz 20,64 ATE



















¹⁾ - outlet port for clutch / - uscita per frizione / - sortie d'embrayage / - salida conexión embrague



BMW 3er Reihe/E21 (75-83)

	318 i 320 i 320/4 320/6 323 i			01.80 06.82 08.77 07.78 08.77 07.79 10.77 10.82 02.78 10.82			03.2120-0562.3 010078			ThZ 20,64	ATE
	316 320 i 320/4			11.75 07.77 + Schaltgetriebe 1) 11.75 07.77 + Schaltgetriebe 1) 11.75 07.77 + Schaltgetriebe 1)			03.3508-5851.3 310039			Behälter	
	316 320 i 320/4			11.75 07.77 + Automatikgetriebe 2) 11.75 07.77 + Automatikgetriebe 2) 11.75 07.77 + Automatikgetriebe 2)			03.3508-5951.3 310041			Behälter	
	315 316 318 318 i 320 i 320/4 320/6			04.81 12.83 06.75 07.83 06.75 08.80 09.79 12.83 09.78 09.82 + USA 06.75 07.79 08.77 10.82			13.2481-8011.2 210092 13.2481-8012.2 210093 13.0441-4825.2 250107	<input type="checkbox"/> <input type="checkbox"/>		D=48 D=48 Dichtungssatz	ATE ATE ATE
	320 i 323 i			10.75 07.78 01.78 10.82			13.0441-4825.2 250107			Dichtungssatz	ATE
	315 316 318 318 i 320 i 320/4 320/6			04.81 12.83 06.75 07.83 06.75 08.80 09.79 12.83 09.78 09.82 + USA 06.75 07.79 08.77 10.82			13.0460-5032.2 605032 13.0460-0916.2 610916 24.8190-0215.2 620215	1		20588 16,5 /WE Belagsatz-Zubehör Warnkontakt L=162mm	ATE TRW
	320 i 323 i			10.75 07.78 01.78 10.82			13.0460-5032.2 605032 13.0460-0916.2 610916 24.8190-0215.2 620215	1		20588 16,5 /WE Belagsatz-Zubehör Warnkontakt L=162mm	ATE TRW
	315 316 318 318 i 320 i 320/4 320/6			04.81 12.83 06.75 07.83 06.75 08.80 09.79 12.83 09.78 09.82 + USA 06.75 07.79 08.77 10.82			24.0113-0138.1 413138			255 12,7 11,1	
	320 i 323 i			10.75 07.78 01.78 10.82			24.0122-0112.1 422112			255 22,0 20,4 V	
	315 316 318 318 i 320 i 320/4 320/6 323 i			04.81 12.83 06.75 07.83 06.75 08.80 06.75 06.82 10.75 07.78 10.77 10.82 02.78 10.82			24.5201-0290.3 331401	2		L=290	
	323 i			01.78 10.82			13.0460-0121.2 610121 24.8190-0215.2 620215	1		Belagsatz-Zubehör Warnkontakt L=162mm	ATE
	323 i			01.78 10.82			24.0110-0150.1 410150			258 10,0 8,4 +B	
	315 316 318 318 i 320 i 320 i 320/4 320/6 323 i			04.81 12.83 06.75 07.83 06.75 08.80 09.79 12.83 09.78 09.82 + USA 10.75 07.78 06.75 07.79 08.77 10.82 01.78 10.82			24.5170-0201.3 331450 24.5201-0204.3 331400	<input type="checkbox"/> <input type="checkbox"/>		L=201 L=204	
	315 316 318 318 i 320 i 320 i 320/4 320/6			04.81 12.83 06.75 07.83 06.75 08.80 09.79 12.83 09.78 09.82 + USA 10.75 07.78 06.75 07.79 08.77 10.82			03.3219-2106.3 020043	<input type="checkbox"/> <input type="checkbox"/>		Rz 19,05	
	315 316 318 318 i 320 i 320 i 320/4 320/6			04.81 12.83 06.75 07.83 06.75 08.80 09.79 12.83 09.78 09.82 + USA 10.75 07.78 06.75 07.79 08.77 10.82			03.0137-0009.2 650009			250 x 42 HEB	
	315 316 318 318 i 320 i 320 i			04.81 12.83 06.75 07.83 06.75 08.80 09.79 12.83 09.78 09.82 + USA 10.75 07.78			24.0225-0001.1 480043			250/251 x 47	

1) + manual transmission / + scatola cambio velocità / + transmission mécanique / + cambio de velocidad
2) + autom.transmission / + scatola cambio automatico / + transmission automatique / + cambio automático

								
BMW 3er Reihe/E21 (75-83)								
	320/4 320/6			06.75 07.79 08.77 10.82		24.0225-0001.1 480043		250/251 x 47
	323 i			01.78 10.82		03.0137-0149.2 650149 03.0137-9058.2 669058		160 x 25 Bremsbacken-Zubehör
	315 316 318 318 i 320 i 320 i 320/4 320/6 323 i			04.81 12.83 06.75 07.83 06.75 08.80 09.79 12.83 09.78 09.82 + (USA) 10.75 07.78 06.75 07.79 08.77 10.82 01.78 10.82		24.3727-0201.2 580201 24.3727-0206.2 580206	2 2	L=1632 L=1616
	316 318 320 i 320/4 320/6			06.75 07.79 06.75 07.79 10.75 07.78 06.75 07.79 08.77 07.79		03.6058-0501.3 320074		BR 25/5 (4) ATE
	315 316 318 318 i 320 i 320/4 320/6 323 i	◀ ◀ ◀ ◀ ◀ ◀ ◀ ◀		04.81 12.83 06.75 07.83 06.75 08.80 06.75 06.82 10.75 07.78 06.75 07.79 10.77 10.82 02.78 10.82		03.2419-9000.3 030025 03.0350-1919.2 071919		Gz 19,05 Gz Reparatursatz
	315 316 318 318 i 320 i 320/4 320/6 323 i			04.81 12.83 06.75 07.83 06.75 08.80 06.75 06.82 10.75 07.78 06.75 07.79 10.77 10.82 02.78 10.82		03.2520-1201.3 040011 03.0450-2006.2 082006		Nz 20,64 Nz Reparatursatz
BMW 3er Reihe/E30 (82-93)								
	316 316 i 316 i Touring 318 i 318 i Cabrio 318 i Touring 318 iS 320 i 320 i Cabrio 320 i Touring 320 iS 323 i 324 d 324 td 324 td Touring 325 e 325 i 325 i Cabrio 325 i Touring 325 iX	66 95 85		03.82 07.88 07.87 12.91 06.91 06.94 03.82 12.91 07.90 05.93 09.87 06.94 02.89 12.91 01.82 12.91 04.86 12.92 01.88 09.93 09.87 12.91 + (I) (P) 09.82 09.86 04.85 12.91 02.87 12.91 01.88 09.93 10.83 09.87 09.83 12.91 07.85 12.92 07.87 09.93 03.86 11.87		03.7760-0902.4 300088		10" ATE
	316 316 318 i 318 i 320 i 320 i 324 d	◀ 66 ▶ 66 ▶ ▶ ▶ ▶		03.82 04.87 - ABS 03.82 06.86 - ABS 03.82 04.87 - ABS/ - (ABS) 03.82 06.86 - ABS 01.82 04.87 - ABS 01.82 06.86 - ABS 04.85 04.87 - ABS		03.2020-0402.3 010001		Thz 20,64/19,05 ATE
	316 318 i 318 i 320 i 323 i 323 i 325 e 325 i 325 i Cabrio	▶ 66 ▶ ▶ ▶ ▶ ▶		07.86 04.87 - ABS 07.86 04.87 - ABS 03.82 04.87 - ABS/ + (ABS) 07.86 04.87 - ABS 09.82 09.86 - ABS 07.86 09.86 - ABS 10.83 04.87 - ABS 09.83 08.86 - ABS 07.85 09.86 - ABS		03.2120-2082.3 010107		Thz 20,64 ATE
	316 318 i 320 i 323 i 324 d 325 i 325 i Cabrio 325 iX	66		03.82 04.87 + ABS 03.82 04.87 + ABS 01.82 04.87 + ABS 09.82 09.86 + ABS 04.85 04.87 + ABS 09.86 04.87 07.85 04.87 + ABS 03.86 08.86		03.2120-1802.3 010099		Thz 20,64 ATE
	316 316 i 316 i Touring 318 i	66		05.87 07.88 07.87 12.91 06.91 06.94 05.87 12.91		03.2022-1201.3 010009		Thz 22,20/17,46 ATE



BMW 3er Reihe/E30 (82-93)

	318 i Cabrio 318 i Touring 318 iS 320 i 320 i Cabrio 320 i Touring 320 iS 324 d 324 td 324 td Touring 325 e 325 i 325 i Cabrio 325 i Touring 325 iX			07.90 09.87 02.89 05.87 04.86 01.88 09.87 05.87 02.87 01.88 05.87 05.87 05.87 07.87 09.86	06.94 09.93 12.91 12.91 12.92 09.93 12.91 12.91 12.91 09.93 09.87 12.91 12.92 09.93 10.87				03.2022-1201.3 010009			THz 22,20/17,46	ATE	
	316 318 i 318 iS 320 i 320 i Cabrio 320 i Touring 320 iS 324 d 324 td 324 td Touring 325 e 325 i 325 i Cabrio 325 i Touring	66 95 85		07.87 03.82 02.89 01.82 04.86 01.88 09.87 04.85 02.87 01.88 10.83 09.83 07.85 07.87	07.88 12.91 12.91 12.91 12.92 09.93 12.91 12.91 12.91 09.93 09.87 12.91 12.92 09.93	+ Behörde ¹⁾ + Behörde ¹⁾			11.0441-4810.2 11.0101-5402.2 11.8171-0008.1	250023 260009 990049			Dichtungssatz Hülensatz Führungsbolzen	ATE ATE ATE
	316 316 i 316 i Touring 318 i 318 i Cabrio 318 i Touring 323 i 325 iX 325 iX Touring M3 M3 Cabrio	66 95 85		03.82 07.87 06.91 03.82 07.90 09.87 09.82 03.86 03.88 07.86 06.88	07.88 12.91 06.94 12.91 05.93 06.94 09.86 12.91 09.93 12.91 09.92	+ ABS + ABS/ + Behörde ²⁾ + ABS/ + Behörde/ + ABS ³⁾			24.3481-1607.5 24.3481-1608.5	240211 240212			D=48, - Halter D=48, - Halter	TRW TRW
	316 316 i 316 i Touring 318 i 318 i Cabrio 318 i Touring 318 iS 320 i 320 i Cabrio 320 i Touring 320 iS 323 i 324 d 324 td 324 td Touring 325 e 325 i 325 i Cabrio 325 i Touring 325 iX 325 iX Touring M3 M3 Cabrio	66 95 85		03.82 07.87 06.91 03.82 07.90 09.87 09.82 04.85 02.87 01.88 10.83 09.83 07.85 07.87 03.86 03.88 07.86 06.88	07.88 12.91 06.94 12.91 05.93 06.94 12.91 12.91 12.92 09.93 12.91 09.86 12.91 12.91 09.93 09.87 12.91 12.92 09.93 12.91 09.93 12.91 09.92				13.0460-2921.2 24.8190-0201.2	602921 620201	2 1		21173 17,0 /WE/S Warnkontakt L=235mm	TRW ATE
	316 316 i 318 i 316 316 i 316 i Touring 318 i 318 i Cabrio 318 i Touring 318 iS 320 i 320 i Cabrio 320 i Touring 320 iS 323 i 324 d 324 td 324 td Touring 325 e 325 i 325 i Cabrio 325 i Touring 325 iX 325 iX Touring M3 M3 Cabrio	66 66 85		03.82 07.87 06.91 03.82 07.90 09.87 09.82 04.85 02.87 01.88 10.83 09.83 07.85 07.87 03.86 03.88 07.86 06.88	07.88 12.91 06.94 12.91 05.93 06.94 12.91 12.91 12.92 09.93 12.91 12.92 09.93 12.91 09.86 12.91 12.91 09.93 09.87 12.91 12.92 09.93 12.91 09.92	- ABS - ABS/ - Behörde ⁴⁾ - ABS/ - Behörde/ - ABS ⁵⁾			24.0113-0167.1	413167			260 12,7 11,1 +B	
	316 316 i 316 i Touring 318 i 318 i Cabrio 318 i Touring 318 iS 320 i 320 i Cabrio 320 i Touring 320 iS 323 i 324 d 324 td 324 td Touring 325 e 325 i 325 i Cabrio 325 i Touring 325 iX 325 iX Touring M3 M3 Cabrio	66 95 85		03.82 07.87 06.91 03.82 07.90 09.87 09.82 04.85 02.87 01.88 10.83 09.83 07.85 07.87 03.86 03.88 07.86 06.88	07.88 12.91 06.94 12.91 05.93 06.94 12.91 12.91 12.92 09.93 12.91 09.86 12.91 12.91 09.93 09.87 12.91 12.92 09.93 12.91 09.93 12.91 09.92	+ ABS + ABS/ + Behörde ²⁾			24.0122-0122.1 24.0322-0122.1	422122 522122			260 22,0 20,4 V L +B 260 22,0 19,6 V L +B PD	

1) + authority cars / + enti statali / + véhicule communal / + vehiculos oficiales
 2) + ABS/ + authority cars / + ABS/ + enti statali / + ABS/ + véhicule communal / + ABS/ + vehiculos oficiales
 3) + ABS/ + authority cars/ + ABS / + ABS/ + enti statali/ + ABS / + ABS/ + véh.communal/ + ABS / + ABS/ + veh.oficiales/ + ABS
 4) - ABS/ - authority cars / - ABS/ - enti statali / - ABS/ - véhicule communal / - ABS/ - vehiculos oficiales
 5) - ABS/ - authority cars/ - ABS / - ABS/ - enti statali/ - ABS / - ABS/ - véh.communal/ - ABS / - ABS/ - veh.oficiales/ - ABS



BMW 3er Reihe/E30 (82-93)

	318 i Touring 318 iS 320 i 320 i 320 i Cabrio 320 i Touring 320 iS 323 i 324 d 324 td 324 td Touring 325 e 325 i 325 i Cabrio 325 i Touring 325 iX	95 85		09.87 06.94 02.89 12.91 01.82 12.91 + ABS 09.87 12.91 + Behörde 1) 04.86 12.92 01.88 09.93 09.87 12.91 + L P 09.82 09.86 04.85 12.91 + ABS/ + Behörde 2) 02.87 12.91 01.88 09.93 10.83 09.87 09.83 12.91 07.85 12.92 07.87 09.93	24.0110-0150.1 410150 24.0310-0150.1 510150			258 10,0 8,4 +B 258 10,0 7,6 +B PD
	316 316 i 318 i 320 i 324 d 316 316 i 316 i Touring 318 i 318 i Cabrio 318 i Touring 318 iS 320 i 320 i 320 i Cabrio 320 i Touring 320 iS 323 i 324 d 324 td 324 td Touring 325 e 325 i 325 i Cabrio 325 i Touring 325 iX 325 iX Touring M3 M3 Cabrio	66 66		03.82 07.88 - ABS 07.87 12.91 - ABS/ - Behörde 3) 03.82 12.91 - ABS/ - Behörde/ - ABS 4) 01.82 12.91 - ABS/ - Behörde 3) 04.85 12.91 - ABS/ - Behörde 3) 03.82 07.88 + ABS 07.87 12.91 + ABS/ + Behörde 2) 06.91 06.94 03.82 12.91 + ABS/ + Behörde/ + ABS 6) 07.90 05.93 09.87 06.94 02.89 12.91 01.82 12.91 + ABS 09.87 12.91 + Behörde 1) 04.86 12.92 01.88 09.93 09.87 12.91 + L P 09.82 09.86 04.85 12.91 + ABS/ + Behörde 2) 02.87 12.91 01.88 09.93 10.83 09.87 09.83 12.91 07.85 12.92 07.87 09.93 03.86 12.91 03.88 09.93 07.86 12.91 06.88 09.92	24.0110-0263.1 410263 24.5201-0204.3 331400	2 2		258 10,0 8,4 L=204 L=204 L=201
	316 318 i 320 i	66		03.82 08.86 - ABS 03.82 08.86 - ABS/ - Behörde/ - ABS 4) 01.82 12.91 - ABS/ - Behörde 3)	03.3220-3201.3 020065			Rz 20,64 TRW
	316 316 i 318 i 324 d	66		09.86 07.88 - ABS 07.87 12.91 - ABS/ - Behörde 3) 09.86 12.91 - ABS/ - Behörde/ - ABS 4) 04.85 12.91 - ABS/ - Behörde 3)	24.3222-1604.3 020276			Rz 22,20 TRW
	316 316 i 318 i 320 i 324 d	66		03.82 07.88 - ABS 07.87 12.91 - ABS/ - Behörde 3) 03.82 12.91 - ABS/ - Behörde/ - ABS 4) 01.82 12.91 - ABS/ - Behörde 3) 04.85 12.91 - ABS/ - Behörde 3)	03.0137-0151.2 650151 03.0137-9076.2 669076			229 x 42 HEB TRW Bremsbacken-Zubehör TRW
	316 316 i 318 i 320 i 324 d	66		03.82 07.88 - ABS 07.87 12.91 - ABS/ - Behörde 3) 03.82 12.91 - ABS/ - Behörde/ - ABS 4) 01.82 12.91 - ABS/ - Behörde 3) 04.85 12.91 - ABS/ - Behörde 3)	24.0222-8009.1 480026			229/229,5 x 46,4
	316 318 i 320 i	66		03.82 08.86 - ABS 03.82 08.86 - ABS/ - Behörde/ - ABS 4) 01.82 12.91 - ABS/ - Behörde 3)	03.0420-0320.3 680320			20,64/229x42 Kit TRW
	316 316 i 318 i 324 d	66		09.86 07.88 - ABS 07.87 12.91 - ABS/ - Behörde 3) 09.86 12.91 - ABS/ - Behörde/ - ABS 4) 04.85 12.91 - ABS/ - Behörde 3)	03.0420-2822.3 682822			22,20/229x42 Kit TRW
	316 316 i 316 i Touring 318 i 318 i Cabrio 318 i Touring 318 iS 320 i 320 i 320 i Cabrio 320 i Touring 320 iS 323 i 324 d 324 td 324 td Touring 325 e	66 95 85		03.82 07.88 + ABS 07.87 12.91 + ABS/ + Behörde 2) 06.91 06.94 03.82 12.91 + ABS/ + Behörde/ + ABS 6) 07.90 05.93 09.87 06.94 02.89 12.91 01.82 12.91 + ABS 09.87 12.91 + Behörde 1) 04.86 12.92 01.88 09.93 09.87 12.91 + L P 09.82 09.86 04.85 12.91 + ABS/ + Behörde 2) 02.87 12.91 01.88 09.93 10.83 09.87	03.0137-0149.2 650149 03.0137-9058.2 669058			160 x 25 Bremsbacken-Zubehör

1) + authority cars / + enti statali / + véhicule communal / + vehiculos oficiales
 2) + ABS/ + authority cars / + ABS/ + enti statali / + ABS/ + véhicule communal / + ABS/ + vehiculos oficiales
 3) - ABS/ - authority cars / - ABS/ - enti statali / - ABS/ - véhicule communal / - ABS/ - vehiculos oficiales
 4) - ABS/ - authority cars/ - ABS/ - enti statali/ - ABS/ - véh.communal/ - ABS/ - veh.oficiales/ - ABS
 5) on the brake caliper / sulla pinza freno / sur l'étrier de frein / a la pinza de freno
 6) + ABS/ + authority cars/ + ABS/ + enti statali/ + ABS/ + véh.communal/ + ABS/ + veh.oficiales/ + ABS



BMW 3er Reihe/E30 (82-93)

	325 iX 325 iX Touring M3 M3 Cabrio		03.86 03.88 07.86 06.88	12.91 09.93 12.91 09.92		24.2419-0912.3	030044		Gz 19,05
	316 316 i 316 i Touring 318 i 318 i Cabrio 318 i Touring 318 iS 320 i 320 i Cabrio 320 i Touring 320 iS 323 i 324 td 324 td Touring 325 e 325 i 325 i Cabrio 325 i Touring 325 iX 325 iX Touring M3 M3 Cabrio 324 d	66 95 85	03.82 07.87 06.91 03.82 07.90 09.87 02.89 01.82 04.86 01.88 09.87 09.82 02.87 01.88 10.83 09.83 07.85 07.87 03.86 03.88 07.86 06.88 04.85	07.88 12.91 06.94 12.91 05.93 06.94 12.91 12.91 12.92 09.93 12.91 + I P 09.86 12.91 09.93 09.87 12.91 12.92 09.93 12.91 09.93 12.91 09.92		03.2520-1201.3 03.0450-2006.2	040011 082006		Nz 20,64 Nz Reparatursatz
	316 316 i 316 i Touring 318 i 318 i Cabrio 318 i Touring 318 iS 320 i 320 i Cabrio 320 i Touring 320 iS 323 i 324 d 324 td 324 td Touring 325 e 325 i 325 i Cabrio 325 i Touring M3 M3 Cabrio	66 95 85	03.82 07.87 06.91 03.82 07.90 09.87 02.89 01.82 04.86 01.88 09.87 09.82 02.87 01.88 10.83 09.83 07.85 07.87 03.86 03.88 07.86 06.88 04.85	07.88 12.91 06.94 12.91 05.93 06.94 12.91 12.91 12.92 09.93 12.91 + I P 09.86 12.91 09.93 09.87 12.91 12.92 09.93 12.91 09.93 12.91 09.92		24.5802-0320.3	330050	+ Rohrleitung ¹⁾	Nz 22,20 L=320

BMW 5er Reihe/E12 (72-81)

	518 520 4 520 6 520 i 525 528 525 528 528 i M 535 i	 85 90 160	06.74 06.72 08.77 10.72 10.73 01.75 10.73 01.75 03.77 04.80	09.78 01.79 04.79 + Automatikgetriebe ²⁾ 07.79 06.81 + Schaltgetriebe ³⁾ 07.77 + Schaltgetriebe ³⁾ 06.81 + Automatikgetriebe ²⁾ 07.77 + Automatikgetriebe ²⁾ 06.81 + Automatikgetriebe ²⁾ 06.81 + Automatikgetriebe ²⁾ 05.81		03.2123-6802.3	010186		Thz 23,81 ATE
	518 518 i 520 4 520 6 520 i 525 528 528 i	85 90 160	06.74 09.79 06.72 08.77 10.72 10.73 01.75 03.77	05.81 + Automatikgetriebe ²⁾ 06.81 + S / + Automatikgetriebe ⁵⁾ 01.79 + Automatikgetriebe ²⁾ 06.81 + Automatikgetriebe ²⁾ 07.79 + Automatikgetriebe ²⁾ 06.81 + Automatikgetriebe ²⁾ 06.81 + Automatikgetriebe ²⁾ 06.81 + Automatikgetriebe ²⁾		03.3508-8801.3 03.3508-8802.3	310050 310051	im Motorraum ⁴⁾ im Motorraum ⁴⁾	Behälter Behälter + WE
	518 520 4 520 i 525 528	85 160	06.74 06.72 10.72 10.73 01.75	07.76 07.76 07.76 07.76 07.76		13.4401-8021.2 13.4401-8022.2 13.0441-4018.2	210189 210190 250083		D=40 D=40 Dichtungssatz ATE
	518 518 i 520 4 520 6 520 i 525	 85 90 160	08.76 09.79 08.76 08.77 08.76 06.76	05.81 - belüftete Scheiben ⁶⁾ 06.81 + S 01.79 - belüftete Scheiben ⁶⁾ 06.81 - belüftete Scheiben ⁶⁾ 07.79 - belüftete Scheiben ⁶⁾ 06.81 - belüftete Scheiben ⁶⁾		13.0441-4018.2	250083		Dichtungssatz ATE
	518 520 4 520 6 520 i 525 528 528 i	85 90 160	08.76 08.76 08.77 08.76 06.76	05.81 + belüftete Scheiben ⁷⁾ 01.79 + belüftete Scheiben ⁷⁾ 06.81 + belüftete Scheiben ⁷⁾ 07.79 + belüftete Scheiben ⁷⁾ 06.81 + belüftete Scheiben ⁷⁾ 07.77 06.81		13.0441-4018.2	250083		Dichtungssatz ATE

¹⁾ + pipe line / + tubazione / + conduite rigide / + latiguillo
²⁾ + autom.transmission / + scatola cambio automatico / + transmission automatique / + cambio automático
³⁾ + manual transmission / + scatola cambio velocità / + transmission mécanique / + cambio de velocidad
⁴⁾ in engine compartment / nel vano motore / dans compartiment moteur / en compartimento de motor
⁵⁾ + S / + autom.transmission / + S / + scatola cambio autom. / + S / + transmission automatique / + S / + cambio automático
⁶⁾ - ventilated discs / - dischi ventilati / - disques ventilés / - disco ventilado
⁷⁾ + ventilated discs / + dischi ventilati / + disques ventilés / + disco ventilado

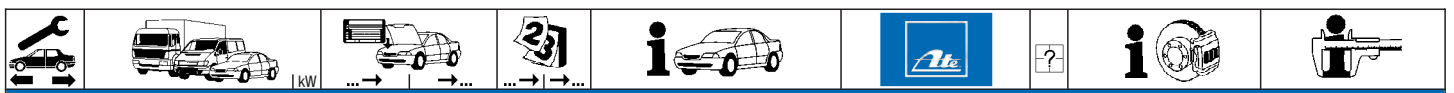

BMW 5er Reihe/E12 (72-81)

	518 520 4 520 i 525 528	85		06.74 06.72 10.72 10.73 01.75	07.76 07.76 07.76 07.76 07.76		13.0460-9030.2	609030			20092 15,0	ATE	
	518 518 i 520 4 520 6 520 i 525 528 528 i	85 90		08.76 09.79 08.76 08.77 08.76 06.76 08.76 03.77	05.81 06.81 + s 01.79 06.81 07.79 06.81 07.77 06.81		13.0460-9031.2 13.0460-0122.2 13.0460-0123.2 24.8190-0215.2	609031 610122 610123 620215	1		- belüftete Scheiben ¹⁾ + belüftete Scheiben ²⁾	20437 19,0 /WE Belagsatz-Zubehör Belagsatz-Zubehör Warnkontakt L=162mm	ATE ATE ATE
	M 535 i	160		04.80	05.81		13.0460-9031.2 24.8190-0215.2	609031 620215	1		20437 19,0 /WE Warnkontakt L=162mm	ATE	
	518 518 i 520 4 520 6 520 i 525 528	85 90		02.76 09.79 02.76 08.77 02.76 02.76 02.76	05.81 06.81 + s 01.79 06.81 07.79 06.81 07.76		24.0113-0139.1	413139			280 12,7 11,1		
	518 520 4 520 6 520 i 525 528 528 i	85 90		08.76 08.76 08.77 08.76 06.76 08.76 03.77	05.81 01.79 06.81 07.79 06.81 07.77 06.81		24.0122-0111.1	422111			280 22,0 20,4 V		
	M 535 i	160		04.80	05.81		24.0125-0100.1	425100			280 25,0 23,4 V L		
	518 518 i 520 4 520 6 520 i 525 528 528 i	85 90		06.74 09.79 06.72 08.77 10.72 10.73 01.75 03.77	05.81 06.81 + s 01.79 06.81 07.79 06.81 07.77 06.81		24.5201-0290.3	331401	4		L=290		
	525 528 528 i M 535 i	160		10.73 01.75 03.77 04.80	06.81 07.77 06.81 05.81		13.2421-8005.2 13.2421-8006.2 24.9242-8005.5 24.9242-8006.5 13.0441-4205.2	210053 210054 230027 230028 250086			D=42 D=42 D=42 D=42 Dichtungssatz	ATE ATE ATE ATE ATE	
	525 528 528 i M 535 i	160		10.73 01.75 03.77 04.80	06.81 07.77 06.81 05.81		13.0460-3024.2 13.0460-0014.2 24.8190-0215.2	603024 610014 620215	1		20436 15,0 /WE Belagsatz-Zubehör Warnkontakt L=162mm	ATE ATE	
	525 528 528 i M 535 i	160		10.73 01.75 03.77 04.80	06.81 07.77 06.81 05.81		24.0110-0110.1	410110			272 9,5 7,9		
	518 518 i 520 4 520 6 520 i 525 528 528 i	85 90		06.74 09.79 06.72 08.77 10.72 10.73 01.75 03.77	05.81 06.81 + s 01.79 06.81 07.79 06.81 07.77 06.81		24.5201-0204.3	331400	2		L=204		
	518 520 4 520 6 520 i	85 90		06.74 06.72 08.77 10.72	05.81 01.79 06.81 07.79		03.3222-4211.3	020075			Rz 22,20		
	518 518 i 520 4 520 6 520 i	85 90		06.74 09.79 06.72 08.77 10.72	05.81 06.81 + s 01.79 06.81 07.79		03.0137-0009.2	650009			250 x 42 HEB		
	525 528 528 i M 535 i	160		10.73 01.75 03.77 04.80	06.81 07.77 06.81 05.81		03.0137-0149.2	650149			160 x 25		
	518 520 4 520 i 525 528	85		06.74 06.72 10.72 10.73 01.75	05.75 05.75 05.75 05.75 05.75		03.0350-1919.2	071919			Gz Reparatursatz		
	518 518 i 520 4 520 6 520 i 525 528 528 i	85 90		06.75 09.79 06.75 08.77 06.75 06.75 06.75 03.77	05.81 06.81 + s 01.79 06.81 07.79 06.81 07.77 06.81		03.2419-9000.3 03.0350-1919.2	030025 071919			Gz 19,05 Gz Reparatursatz		

¹⁾ - ventilated discs / - dischi ventilati / - disques ventilés / - disco ventilado

²⁾ + ventilated discs / + dischi ventilati / + disques ventilés / + disco ventilado





BMW 5er Reihe/E12 (72-81)										
	M 535 i	160		04.80	05.81		03.2419-9000.3	030025		Gz 19,05
							03.0350-1919.2	071919		Gz Reparatursatz
	518 520 4 520 i 525 528	85		06.74 06.72 10.72 10.73 01.75	05.75 05.75 05.75 05.75		03.2520-1001.3	040009		Nz 20,64
	518 518 i 520 4 520 6 520 i 525 528 528 i M 535 i	85 90 160		06.75 09.79 06.75 08.77 06.75 06.75 06.75 03.77 04.80	05.81 06.81 01.79 06.81 07.79 06.81 07.77 06.81 05.81	+ ⑤	03.2520-1201.3 03.0450-2006.2	040011 082006		Nz 20,64 Nz Reparatursatz

BMW 5er Reihe/E28 (81-87)										
	518 518 i 520 i	66		06.81 11.83 06.81	09.84 12.87 12.87		03.7760-0902.4	300088		10" ATE
	524 d 524 td 525 e 525 e	63 85		05.86 09.83 09.81 09.81	12.87 12.87 11.86 12.87	+ ABS + ABS - ABS + ABS				
	525 i 528 i 535 i M 535 i M5	110 135 211		02.81 06.81 01.85 01.85 08.85	12.87 12.87 12.87 12.87 12.87		10.0144-4234.3 10.0504-0113.3 10.0522-4005.1 10.0522-4002.1 10.0515-0515.3	340014 340021 340029 340028 340024		Hydraulik Verstärker DS Regler Warnschalter M10x1 Warnschalter M12x1 Hydraulikspeicher ATE
	518 518 i 520 i	66		06.81 11.83 06.81	09.84 12.87 08.84	- ABS/ - Behörde 1) - ABS/ - Behörde 1) - ABS/ - Behörde 1)	03.2122-6911.3	010153		THz 22,20 ATE
	518 518 i 520 i 520 i 525 e	66		06.81 11.83 09.84 06.81 09.81	09.84 12.87 12.87 12.87 12.87	- ABS/ + Behörde 2) - ABS/ + Behörde 2) - ABS/ - Behörde 1) + Behörde 3) - ABS	03.2123-8311.3	010192		THz 23,81 ATE
	524 td 524 td	85 85		09.83 09.84	08.84 12.87	- ABS/ - Behörde 1) - ABS/ - Behörde 1)	03.2122-6911.3 03.2123-8311.3	010153 010192		THz 22,20 ATE THz 23,81 ATE
	525 i 525 i 528 i 535 i M 535 i	110 110 135		02.81 02.81 06.81 01.85 01.85	12.87 08.86 03.86 08.86 08.86	- ABS - ABS - ABS + ABS + ABS	03.2123-8312.3	010193		THz 23,81 ATE
	518 518 i 520 i 524 d 524 td 525 e 525 i 525 i 528 i 528 i 535 i 535 i M 535 i M 535 i M5	66 63 85 110 110 135 135 211		06.81 11.83 06.81 05.86 09.83 09.81 02.81 02.81 06.81 06.81 01.85 01.85 01.85 01.85 08.85	09.84 12.87 12.87 12.87 12.87 12.87 12.87 08.86 12.87 08.86 12.87 08.86 12.87 08.86 12.87	+ ABS + ABS + ABS + ABS + ABS + ABS + ABS + ABS + ABS + ABS + ABS + ABS + ABS + ABS + ABS	03.2123-8711.3	010196		THz 23,81 ATE
	525 i 528 i 535 i M 535 i M5	110 135 211		09.86 09.86 09.86 09.86 08.85	12.87 12.87 12.87 12.87 12.87		03.2123-0242.3	010163		THz 23,81 ATE
	518 518 i 520 i 524 td	66 85		06.81 11.83 06.81 09.83	09.84 12.87 08.84 08.84	- ABS/ - Behörde 1) - ABS/ - Behörde 1) - ABS/ - Behörde 1) - ABS/ - Behörde 1)	11.0441-5402.2 11.0101-5402.2 11.8171-0008.1 11.8116-0091.1	250028 260009 990049 390502	2	Dichtungssatz ATE Hülensatz ATE Führungsbolzen ATE Haltefeder ATE
	518 518 i 520 i 520 i 524 d 524 td 524 td 525 e 525 i 528 i	66 63 85 85 110 135		06.81 11.83 09.84 06.81 05.86 09.84 09.83 09.81 02.81 06.81	09.84 12.87 12.87 12.87 12.87 12.87 12.87 12.87 12.87 05.84	+ ABS/ + Behörde 4) + ABS/ + Behörde 4) - ABS + ABS/ + Behörde 4) - ABS + ABS/ + Behörde 4)	11.0441-5702.2 11.0101-5402.2 11.8171-0008.1 11.8116-0091.1	250033 260009 990049 390502	2	Dichtungssatz ATE Hülensatz ATE Führungsbolzen ATE Haltefeder ATE
	528 i 535 i M 535 i	135		06.84 01.85 01.85	12.87 12.87 12.87		11.0441-5702.2 11.0101-5402.2 11.8171-0008.1 11.8116-0091.1	250033 260009 990049 390502	2	Dichtungssatz ATE Hülensatz ATE Führungsbolzen ATE Haltefeder ATE
	M5	211		08.85	12.87		13.0441-4018.2	250083		Dichtungssatz ATE

1) - ABS/ - authority cars / - ABS/ - enti statali / - ABS/ - véhicule communal / - ABS/ - vehiculos oficiales
 2) - ABS/ + authority cars / - ABS/ + enti statali / - ABS/ + véhicule communal / - ABS/ + vehiculos oficiales
 3) + authority cars / + enti statali / + véhicule communal / + vehiculos oficiales
 4) + ABS/ + authority cars / + ABS/ + enti statali / + ABS/ + véhicule communal / + ABS/ + vehiculos oficiales



















BMW 5er Reihe/E28 (81-87)

	518	66		06.81	09.84		13.0460-7046.2	607046	1		20629 20,3 +WE Warnkontakt L=262mm	ATE
	518 i			11.83	12.87		24.8190-0213.2	620213				
	520 i			06.81	12.87							
	524 d			05.86	12.87							
	524 td	63		09.83	12.87							
	525 e	85		09.81	12.87							
	525 i	110		02.81	12.87							
	528 i	135		06.81	12.87							
	535 i			01.85	12.87							
	M 535 i			01.85	12.87							
M5	211		08.85	12.87		13.0460-9031.2	609031	1		20437 19,0 /WE Warnkontakt L=235mm	ATE	
518	66		06.81	09.84	- ABS/ - Behörde ¹⁾	24.0112-0111.1	412111					
518 i			11.83	12.87	- ABS/ - Behörde ¹⁾							
520 i			06.81	08.84	- ABS/ - Behörde ¹⁾							
524 td	85		09.83	08.84	- ABS/ - Behörde ¹⁾							
518	66		06.81	09.84	+ ABS/ + Behörde ²⁾	24.0122-0135.1	422135					
518 i			11.83	12.87	+ ABS/ + Behörde ²⁾							
520 i			06.81	08.84	+ ABS/ + Behörde ²⁾							
520 i			09.84	12.87	+ ABS/ + Behörde ²⁾							
524 d	63		05.86	12.87								
524 td	85		09.83	08.84	+ ABS/ + Behörde ²⁾							
524 td	85		09.84	12.87								
525 e	85		09.81	12.87								
525 i	110		02.81	12.87								
528 i	135		06.81	05.84								
528 i	135		06.84	12.87		24.0125-0104.1	425104			282 25,0 23,4 V L		
535 i			01.85	12.87								
M 535 i			01.85	12.87								
	518	66		06.81	09.84		83.6124-0422.3	330269	2		L=420	
	518 i			11.83	12.87							
	520 i			06.81	12.87							
	524 d	63		05.86	12.87							
	524 td	85		09.83	12.87							
	525 e	85		09.81	12.87							
	525 i	110		02.81	12.87							
	528 i	135		06.81	12.87							
	535 i			01.85	12.87							
	M 535 i			01.85	12.87							
	518	66		06.81	09.84	+ ABS	11.3331-8501.2	220004	2	☐ ☐ ☐ ☐	D=33, - Halter D=33, - Halter D=33, - Halter D=33, - Halter Dichtungssatz Hülssensatz Führungsbolzen Haltefeder	ATE ATE ATE ATE ATE ATE ATE
	518 i			11.83	12.87	+ ABS	11.3331-8502.2	220005				
	520 i			06.81	03.86	+ ABS	24.3331-8501.5	240509				
	520 i			04.86	12.87		24.3331-8502.5	240510				
	524 d	63		05.86	12.87		11.0441-3302.2	250004				
	524 td	85		09.83	03.86	+ ABS	11.0101-5402.2	260009				
	524 td	85		04.86	12.87		11.8171-0008.1	990049				
	525 e	85		09.81	12.87		11.8116-0015.1	390492				
	525 i	110		02.81	12.87							
	528 i	135		06.81	12.87							
535 i			01.85	12.87								
M 535 i			01.85	12.87								
M5	211		08.85	12.87		11.0101-5402.2	260009	2		Hülssensatz Führungsbolzen Haltefeder	ATE ATE ATE	
						11.8171-0008.1	990049					
						11.8116-0015.1	390492					
	518	66		06.81	09.84	+ ABS	13.0460-7047.2	607047	1		20675 16,5 +WE Warnkontakt L=162mm	ATE
	518 i			11.83	12.87	+ ABS	24.8190-0215.2	620215				
	520 i			06.81	03.86	+ ABS						
	520 i			04.86	12.87							
	524 d	63		05.86	12.87							
	524 td	85		09.83	03.86	+ ABS						
	524 td	85		04.86	12.87							
	525 e	85		09.81	12.87							
	525 i	110		02.81	12.87							
	528 i	135		06.81	12.87							
535 i			01.85	12.87								
M 535 i			01.85	12.87								
M5	211		08.85	12.87		24.0110-0174.1	410174			284 10,0 8,4		
518	66		06.81	09.84	+ ABS							
518 i			11.83	12.87	+ ABS							
520 i			06.81	03.86	+ ABS							
520 i			04.86	12.87								
524 d	63		05.86	12.87								
524 td	85		09.83	03.86	+ ABS							
524 td	85		04.86	12.87								
525 e	85		09.81	12.87								
525 i	110		02.81	12.87								
528 i	135		06.81	12.87								
535 i			01.85	12.87								
M 535 i			01.85	12.87								
M5	211		08.85	12.87								
	518	66		06.81	09.84	- ABS	24.5201-0204.3	331400	2		L=204	
	518 i			11.83	12.87	- ABS						
	520 i			06.81	03.86	- ABS						
	524 td	85		09.83	03.86	- ABS						
	518	66		06.81	09.84	+ ABS	24.5201-0204.3	331400	2	am Bremsattel ³⁾	L=204	
	518 i			11.83	12.87	+ ABS	24.5170-0201.3	331450				

¹⁾ - ABS/ - authority cars / - ABS/ - enti statali / - ABS/ - véhicule communal / - ABS/ - vehiculos oficiales
²⁾ + ABS/ + authority cars / + ABS/ + enti statali / + ABS/ + véhicule communal / + ABS/ + vehiculos oficiales
³⁾ on the brake caliper / sulla pinza freno / sur l'étrier de frein / a la pinza de freno



										
BMW 5er Reihe/E28 (81-87)										
	520 i 520 i 524 d 524 td 525 e 525 i 528 i 535 i M 535 i M5			06.81 04.86 05.86 09.83 04.86 09.81 02.81 06.81 01.85 01.85 08.85	03.86 + ABS 12.87 12.87 03.86 + ABS 12.87 12.87 12.87 12.87 12.87 12.87	24.5201-0204.3 24.5170-0201.3	331400 331450	2 2	am Bremsattel ¹⁾	L=204 L=201
	518 518 i 520 i 524 td	66 85		06.81 11.83 06.81 09.83	08.84 - ABS 12.87 - ABS 08.84 - ABS 08.84 - ABS	03.3219-2106.3	020043			Rz 19,05
	520 i 524 td	85		09.84 09.84	03.86 - ABS 03.86 - ABS	24.3220-1712.3	020406			Rz 20,64
	518 518 i 520 i 524 td	66 85		06.81 11.83 06.81 09.83	09.84 - ABS 12.87 - ABS 03.86 - ABS 03.86 - ABS	03.0137-0152.2 03.0137-9077.2	650152 669077			250 x 42 HEB Bremsbacken-Zubehör
	518 518 i 520 i 520 i 524 d 524 td 524 td 525 e 525 i 528 i 535 i M 535 i M5	66 63 85 85 110 135 211		06.81 11.83 06.81 04.86 05.86 09.83 04.86 09.81 02.81 06.81 01.85 01.85 08.85	09.84 + ABS 12.87 + ABS 03.86 + ABS 12.87 12.87 03.86 + ABS 12.87 12.87 12.87 12.87 12.87 12.87	03.0137-0150.2 03.0137-9062.2	650150 669062			180 x 25 Bremsbacken-Zubehör
	518 518 i 520 i 524 td	66 85		06.81 11.83 06.81 09.83	09.84 - ABS 12.87 - ABS 03.86 - ABS 03.86 - ABS	24.3727-0209.2	580209	2		L=1866
	518 518 i 520 i 520 i 524 d 524 td 524 td 525 e 525 i 528 i 535 i M 535 i M5	66 63 85 85 110 135 211		06.81 11.83 06.81 04.86 05.86 09.83 04.86 09.81 02.81 06.81 01.85 01.85 08.85	09.84 + ABS 12.87 + ABS 03.86 + ABS 12.87 12.87 03.86 + ABS 12.87 12.87 12.87 12.87 12.87 12.87	24.3727-0220.2	580220	2		L=1715
	518 518 i 520 i 524 d 524 td 525 e 525 i 528 i 535 i M 535 i M5	66 63 85 110 135 211		06.81 11.83 06.81 09.83 09.81 02.81 06.81 01.85 01.85 08.85	09.84 12.87 12.87 12.87 12.87 12.87 12.87 12.87 12.87 12.87	24.2419-0912.3	030044			Gz 19,05
	518 518 i 520 i 524 td 525 e 525 i 528 i 535 i M 535 i M5	66 85 110 135 211		06.81 11.83 06.81 09.83 09.81 02.81 06.81 01.85 01.85 08.85	09.84 12.87 12.87 12.87 12.87 12.87 12.87 12.87 12.87 12.87	03.2520-1201.3 03.0450-2006.2	040011 082006			Nz 20,64 Nz Reparatursatz
	524 d	63		05.86	12.87	03.2522-3601.3	040014			Nz 22,20
	518 518 i 520 i 524 d 524 td M 535 i M5	66 63 85 211		06.81 11.83 06.81 05.86 09.83 01.85 08.85	09.84 12.87 12.87 12.87 12.87 12.87 12.87	24.5802-0320.3	330050		ohne Rohrleitung ²⁾	L=320
	525 e 525 i 528 i 535 i	110 135		09.81 02.81 06.81 01.85	12.87 12.87 12.87 12.87	24.5905-0320.3	330058		ohne Rohrleitung ²⁾	L=320

¹⁾ on the brake caliper / sulla pinza freno / sur l'étrier de frein / a la pinza de freno

²⁾ without pipe line / senza tubazione / sans conduite de frein rigide / sin latiguillo



BMW 5er Reihe/E34 (88-96)

	518 i 520 i 520 i 24V 524 td 525 i 525 i 24V 530 i 535 i M5 3.6 M5 3.8 M5 Touring	95 110 85 125 141 138 155 232 250 250	04.89 01.88 03.89 03.88 01.88 09.89 01.88 01.88 04.88 04.88 09.94	08.91 09.90 08.91 08.91 09.90 08.91 09.95 09.95 09.95 09.95 11.96		03.2125-3011.3 010211			Thz 25,40	ATE
	518 i 520 i 24V 525 i 24V 525 tds	110 141 105	09.91 09.91 09.91 09.91	09.95 09.95 09.95 09.95		03.2025-1211.3 010475			Thz 25,40/20,64	ATE
	530 i V8 530 i V8 Touring 540 i V8	◀160 ◀160 ◀210	03.92 05.92 03.92	08.93 08.93 08.93		24.2125-1716.3 010663			Thz 25,40	
	518 i 518 i Touring 520 i 520 i 24V 524 td 525 td 525 tds	95 110 85 85 105	04.89 03.93 01.88 03.89 03.88 04.93 09.91	09.95 09.95 09.90 09.95 08.91 09.95 09.95	- Behörde 1) - Behörde 1)	11.3601-8501.2 24.3601-8501.5 24.3601-8502.5 11.0441-6003.2 11.0230-0020.2 11.0101-5402.2 11.8171-0008.1 11.8116-0083.1	220145 240533 240534 250037 260023 260009 990049 390501	2 2	D=60, - Halter D=60, - Halter D=60, - Halter Dichtungssatz Haltersatz Hülensatz Führungsbolzen Haltefeder	ATE ATE ATE ATE ATE ATE ATE ATE
	520 i 520 i 24V 520 i Touring 525 i 525 i 24V 525 i Touring 525 td Touring 525 tds Touring 530 i 530 i V8 530 i V8 Touring 535 i	95 110 110 125 141 141 85 105 138 160 160 155	01.88 03.89 11.91 01.88 09.89 11.91 03.93 12.91 01.88 03.92 05.92 01.88	09.90 09.95 11.96 09.90 09.95 11.96 11.96 11.96 09.95 09.95 11.96 09.95	+ Behörde 2) + Behörde 2)	11.3601-8505.2 24.3601-8505.5 24.3601-8506.5 11.0441-6003.2 11.0101-5402.2 11.8171-0008.1 11.8116-0083.1	220149 240537 240538 250037 260009 990049 390501	2	D=60, - Halter D=60, - Halter D=60, - Halter Dichtungssatz Hülensatz Führungsbolzen Haltefeder	ATE ATE ATE ATE ATE ATE ATE
	525 ix 525 ix Touring	141 141	04.91 02.92	09.95 11.96		11.0441-6003.2 11.0101-5402.2 11.8171-0008.1	250037 260009 990049		Dichtungssatz Hülensatz Führungsbolzen	ATE ATE
	540 i Touring 540 i V8	210 210	05.93 03.92	11.96 09.95		24.3601-8503.5 24.3601-8504.5 11.0441-6003.2 11.0101-5402.2 11.8171-0008.1	240535 240536 250037 260009 990049		D=60, - Halter D=60, - Halter Dichtungssatz Hülensatz Führungsbolzen	ATE ATE ATE ATE
	M5 3.6 M5 3.8	232 250	10.88 03.92	09.95 05.94		11.0441-6003.2 11.0101-5402.2 11.8171-0008.1	250037 260009 990049		Dichtungssatz Hülensatz Führungsbolzen	ATE ATE
	518 i 518 i Touring 520 i 520 i 24V 520 i Touring 524 td 525 i 525 i 24V 525 i Touring 525 td 525 td Touring 525 tds 525 tds Touring 530 i 530 i V8 530 i V8 Touring 535 i 540 i Touring 540 i V8 M5 3.6 M5 3.8	95 110 110 85 125 141 141 85 85 105 105 138 160 160 155 210 210 232 250	04.89 03.93 01.88 03.89 11.91 03.88 01.88 09.89 11.91 04.93 03.93 09.91 12.91 01.88 03.92 05.92 01.88 05.93 03.92 10.88 03.92	09.95 11.96 09.90 09.95 11.96 08.91 09.90 09.95 11.96 09.95 11.96 09.95 11.96 09.95 11.96 11.96 09.95 11.96 09.95 05.94		13.0460-6033.2 24.8190-0214.2	606033 620214	1	20968 20,3 +/WE Warnkontakt L=235mm	ATE
	525 ix 525 ix Touring	141 141	04.91 02.92	09.95 11.96		13.0460-6033.2 24.8190-0224.2	606033 620224	1	20968 20,3 +/WE Warnkontakt L=311mm	ATE
	M5 3.8 M5 Touring	250 250	03.92 09.94	09.95 11.96		13.0460-9037.2 24.8190-0214.2	609037 620214	1	20309 17,9 /WE Warnkontakt L=235mm	ATE
	518 i 518 i Touring 520 i 520 i 24V 524 td 525 td 525 tds	95 110 85 85 105	04.89 03.93 01.88 03.89 03.88 04.93 09.91	09.95 11.96 09.90 09.95 08.91 09.95 09.95	- Behörde 1) - Behörde 1)	24.0112-0124.1 412124			302 12,0 10,4 L +S +B	
	520 i 520 i 24V 520 i Touring 525 i 525 i 24V	95 110 110 125 141	01.88 03.89 11.91 01.88 09.89	09.90 09.95 11.96 09.90 09.95	+ Behörde 2) + Behörde 2)	24.0122-0103.1 24.0322-0103.1	422103 522103		302 22,0 20,4 V L +S +B 302 22,0 19,6 V L +S +B PD	

1) - authority cars / - enti statali / - véhicule communal / - vehiculos oficiales
2) + authority cars / + enti statali / + véhicule communal / + vehiculos oficiales







BMW 5er Reihe/E34 (88-96)									
	525 i Touring	141		11.91	11.96	24.0122-0103.1	422103		302 22,0 20,4 V L +S +B
	525 td Touring	85		03.93	11.96	24.0322-0103.1	522103		302 22,0 19,6 V L +S +B PD
	525 tds Touring	105		12.91	11.96				
	530 i	138		01.88	09.95				
	530 i V8	160		03.92	09.95				
	530 i V8 Touring	160		05.92	11.96				
	535 i	155		01.88	09.95				
	525 ix	141		04.91	09.95	24.0128-0122.1	428122		296 28,0 26,4 V L +B
	525 ix Touring	141		02.92	11.96				
	540 i Touring	210		05.93	11.96	24.0128-0101.1	428101		302 28,0 26,4 V L +B
	540 i V8	210		03.92	09.95				
	518 i			04.89	09.95	24.5113-0423.3	331396	2	L=423
	518 i Touring			03.93	11.96				
	520 i	95		01.88	09.90				
	520 i 24V	110		03.89	09.95				
	520 i Touring	110		11.91	11.96				
	524 td	85		03.88	08.91				
	525 i	125		01.88	09.90				
	525 i 24V	141		09.89	09.95				
	525 i Touring	141		11.91	11.96				
	525 ix	141		04.91	08.91				
	525 ix Touring	141		02.92	11.96				
	525 td	85		04.93	09.95				
	525 td Touring	85		03.93	11.96				
	525 tds	105		09.91	09.95				
	525 tds Touring	105		12.91	11.96				
	530 i	138		01.88	09.95				
	530 i V8	160		03.92	09.95				
	530 i V8 Touring	160		05.92	11.96				
	535 i	155		01.88	09.95				
	540 i Touring	210		05.93	11.96				
	540 i V8	210		03.92	09.95				
	M5 3.6	232		10.88	09.95				
	M5 3.8	250		10.88	09.95				
	M5 Touring	250		09.94	11.96				
	518 i			04.89	09.95	11.3381-8504.2	220021	<input type="checkbox"/>	D=38, - Halter
	520 i	95		01.88	09.90	24.3381-8503.5	240515	<input type="checkbox"/>	D=38, - Halter
	520 i 24V	110		03.89	09.95	24.3381-8504.5	240516	<input type="checkbox"/>	D=38, - Halter
	524 td	85		03.88	08.91	11.0441-3803.2	250010	<input type="checkbox"/>	Dichtungssatz
	525 i	125		01.88	09.90	11.0101-5402.2	260009		Hülssensatz
	525 i 24V	141		09.89	09.95	11.8171-0008.1	990049		Führungsbolzen
	525 ix	141		04.91	09.95	11.8116-0066.1	390577	2	Haltefeder
	525 td	85		04.93	09.95				
	525 tds	105		09.91	09.95				
	530 i	138		01.88	09.95				
	530 i V8	160		03.92	09.95				
	535 i	155		01.88	09.95				
	M5 3.6	232		04.88	09.88				
	M5 3.8	250		04.88	09.88				
	M5 3.6	232		10.88	12.89	11.0441-4002.2	250011		Dichtungssatz
	M5 3.8	250		10.88	12.89	11.0101-5402.2	260009		Hülssensatz
						11.8171-0008.1	990049		Führungsbolzen
						11.8116-0296.1	390445	2	Haltefeder
	518 i Touring			11.92	11.96	11.3401-8503.2	220030	<input type="checkbox"/>	D=40, - Halter
	520 i Touring	110		11.91	11.96	11.3401-8504.2	220031	<input type="checkbox"/>	D=40, - Halter
	525 i Touring	141		11.91	11.96	24.3401-8503.5	240521	<input type="checkbox"/>	D=40, - Halter
	525 ix Touring	141		02.92	11.96	24.3401-8504.5	240522	<input type="checkbox"/>	D=40, - Halter
	525 td Touring	85		03.93	11.96	11.0441-4002.2	250011		Dichtungssatz
	525 tds Touring	105		12.91	11.96	11.0101-5402.2	260009		Hülssensatz
	530 i V8 Touring	160		05.92	11.96	11.8171-0008.1	990049		Führungsbolzen
						11.8116-0066.1	390577	2	Haltefeder
	540 i Touring	210		05.93	11.96	11.0441-4002.2	250011		Dichtungssatz
	540 i V8	210		03.92	09.95	11.0101-5402.2	260009		Hülssensatz
	M5 3.6	232		01.90	09.95	11.8171-0008.1	990049		Führungsbolzen
	M5 3.8	250		03.92	05.94	11.8116-0066.1	390577	2	Haltefeder
	M5 3.8	250		06.94	09.95	11.0441-4002.2	250011		Dichtungssatz
	M5 Touring	250		09.94	11.96	11.0101-5402.2	260009		Hülssensatz
						11.8171-0008.1	990049		Führungsbolzen
						11.8116-0315.2	390447	2	Haltefeder
	518 i			04.89	09.95	13.0460-3803.2	603803	1	20995 17,3 +/WE
	518 i Touring			03.93	11.96	24.8190-0214.2	620214		Warnkontakt L=235mm
	520 i	95		01.88	09.90				
	520 i 24V	110		03.89	09.95				
	520 i Touring	110		11.91	11.96				
	524 td	85		03.88	08.91				
	525 i	125		01.88	09.90				
	525 i 24V	141		09.89	09.95				
	525 i Touring	141		11.91	11.96				
	525 ix	141		04.91	09.95				
	525 ix Touring	141		02.92	11.96				
	525 td	85		04.93	09.95				
	525 td Touring	85		03.93	11.96				
	525 tds	105		09.91	09.95				
	525 tds Touring	105		12.91	11.96				
	530 i	138		01.88	09.95				
	530 i V8	160		03.92	09.95				
	530 i V8 Touring	160		05.92	11.96				

BMW 5er Reihe/E34 (88-96)																											
	535 i	155		01.88	09.95	13.0460-3803.2	603803	24.8190-0214.2	620214	1										20995 17,3 +WE	ATE						
	540 i Touring	210		05.93	11.96																						
	540 i V8	210		03.92	09.95																						
	M5 3.6	232		10.88	09.95																						
	M5 3.8	250		03.92	05.94																						
M5 3.8	250		06.94	09.95	24.8190-0214.2	620214	1			Warnkontakt L=235mm																	
	518 i			04.89	09.95	24.0110-0117.1	410117	24.0310-0117.1	510117												300 10,0 8,4 L +S +B						
	518 i Touring			03.93	11.96																						
	520 i	95		01.88	09.90																						
	520 i 24V	110		03.89	09.95																						
	520 i Touring	110		11.91	11.96																						
	524 td	85		03.88	08.91																						
	525 i	125		01.88	09.90																						
	525 i 24V	141		09.89	09.95																						
	525 i Touring	141		11.91	11.96																						
	525 td	85		04.93	09.95																						
	525 td Touring	85		03.93	11.96																						
	525 tds	105		09.91	09.95																						
	525 tds Touring	105		12.91	11.96																						
	530 i	138		01.88	09.95																						
	530 i V8	160		03.92	09.95																						
	530 i V8 Touring	160		05.92	11.96																						
	535 i	155		01.88	09.95																						
	M5 3.6	232		10.88	09.89																						
	525 ix	141		04.91	09.95																	24.0110-0262.1	410262				300 10,0 8,4
	525 ix Touring	141		02.92	11.96																						
540 i Touring	210		05.93	11.96	24.0120-0181.1	420181					300 20,0 18,4 V L +B																
540 i V8	210		03.92	09.95																							
M5 3.6	232		10.89	09.95																							
M5 3.8	250		03.92	05.94																							
	518 i			04.89	08.91	24.5201-0204.3	331400	24.5201-0204.3	331400	2											L=204						
	518 i			04.89	09.95																						
	518 i Touring			03.93	11.96																						
	520 i	95		01.88	09.90																						
	520 i 24V	110		03.89	09.95																						
	520 i Touring	110		11.91	11.96																						
	524 td	85		03.88	08.91																						
	525 i	125		01.88	09.90																						
	525 i 24V	141		09.89	09.95																						
	525 i Touring	141		11.91	11.96																						
	525 ix	141		04.91	09.95																						
	525 ix Touring	141		02.92	11.96																						
	525 td	85		04.93	09.95																						
	525 td Touring	85		03.93	11.96																						
	525 tds	105		09.91	09.95																						
	525 tds Touring	105		12.91	11.96																						
	530 i	138		01.88	09.95																						
	530 i V8	160		03.92	09.95																						
	530 i V8 Touring	160		05.92	11.96																						
	535 i	155		01.88	09.95																						
540 i Touring	210		05.93	11.96																							
540 i V8	210		03.92	09.95																							
M5 3.6	232		10.88	09.95																							
M5 3.8	250		10.88	09.95																							
M5 Touring	250		09.94	11.96																							
518 i			04.89	08.91	03.0137-0152.2	650152															250 x 42 HEB						
					03.0137-9077.2	669077																Bremsbacken-Zubehör					
	518 i			04.89	09.95	03.0137-0150.2	650150	03.0137-9062.2	669062													180 x 25					
	518 i Touring			03.93	11.96																						
	520 i	95		01.88	09.90																						
	520 i 24V	110		03.89	09.95																						
	520 i Touring	110		11.91	11.96																						
	524 td	85		03.88	08.91																						
	525 i	125		01.88	09.90																						
	525 i 24V	141		09.89	09.95																						
	525 i Touring	141		11.91	11.96																						
	525 ix	141		04.91	09.95																						
	525 ix Touring	141		02.92	11.96																						
	525 td	85		04.93	09.95																						
	525 td Touring	85		03.93	11.96																						
	525 tds	105		09.91	09.95																						
	525 tds Touring	105		12.91	11.96																						
	530 i	138		01.88	09.95																						
	530 i V8	160		03.92	09.95																						
	530 i V8 Touring	160		05.92	11.96																						
	535 i	155		01.88	09.95																						
	540 i Touring	210		05.93	11.96																						
540 i V8	210		03.92	09.95																							
M5 3.6	232		10.88	09.95																							
M5 3.8	250		10.88	09.95																							
M5 Touring	250		09.94	11.96																							

¹⁾ on the brake caliper / sulla pinza freno / sur l'étrier de frein / a la pinza de freno



BMW 5er Reihe/E34 (88-96)

	518 i		04.89	09.95 + ABS	24.3727-0215.2	580215	2	L=1755
	518 i Touring		03.93	11.96				
	520 i	95	01.88	09.90				
	520 i 24V	110	03.89	09.95				
	520 i Touring	110	11.91	11.96				
	524 td	85	03.88	08.91				
	525 i	125	01.88	09.90				
	525 i 24V	141	09.89	09.95				
	525 i Touring	141	11.91	11.96				
	525 ix	141	04.91	09.95				
	525 ix Touring	141	02.92	11.96				
	525 td	85	04.93	09.95				
	525 td Touring	85	03.93	11.96				
	525 tds	105	09.91	09.95				
	525 tds Touring	105	12.91	11.96				
	530 i	138	01.88	09.95				
	530 i V8	160	03.92	09.95				
	530 i V8 Touring	160	05.92	11.96				
	535 i	155	01.88	09.95				
	540 i Touring	210	05.93	11.96				
	540 i V8	210	03.92	09.95				
	M5 3.6	232	10.88	09.95				
	M5 3.8	250	10.88	09.95				
	M5 Touring	250	09.94	11.96				
	518 i		04.89	09.95	24.2419-0922.3	030051		Gz 19,05
	518 i Touring		03.93	11.96				
	520 i	95	01.88	09.90				
	520 i 24V	110	03.89	09.95				
	520 i Touring	110	11.91	11.96				
	524 td	85	03.88	08.91				
	525 i	125	01.88	09.90				
	525 i 24V	141	09.89	09.95				
	525 i Touring	141	11.91	11.96				
	525 ix	141	04.91	09.95				
	525 ix Touring	141	02.92	11.96				
	525 td	85	04.93	09.95				
	525 td Touring	85	03.93	11.96				
	525 tds	105	09.91	09.95				
	525 tds Touring	105	12.91	11.96				
	530 i	138	01.88	09.95				
	530 i V8	160	03.92	09.95				
	530 i V8 Touring	160	05.92	11.96				
	535 i	155	01.88	09.95				
	540 i Touring	210	05.93	11.96				
	540 i V8	210	03.92	09.95				
	518 i		04.89	09.95	24.2522-0905.3	040042		Nz 22,20
	518 i Touring		03.93	11.96				
	520 i 24V	110	11.90	09.95				
	520 i Touring	110	11.91	11.96				
	524 td	85	09.90	08.91				
	525 i 24V	141	09.89	09.95				
	525 i Touring	141	11.91	11.96				
	525 ix	141	04.91	09.95				
	525 ix Touring	141	02.92	11.96				
	525 td	85	04.93	09.95				
	525 td Touring	85	03.93	11.96				
	525 tds	105	09.91	09.95				
	525 tds Touring	105	12.91	11.96				
	530 i V8	160	03.92	09.95				
	530 i V8 Touring	160	05.92	11.96				
	520 i	95	01.88	09.90	03.2522-3601.3	040014		Nz 22,20
	520 i 24V	110	03.89	10.90				
	524 td	85	03.88	08.90				
	525 i	125	01.88	09.90				
	530 i	138	01.88	09.95				
	535 i	155	01.88	09.95				
	540 i Touring	210	05.93	11.96	24.2526-0902.3	040052		Nz 26,99
	540 i V8	210	03.92	09.95				
	518 i		04.89	09.95	24.5905-0320.3	330058		L=320
	518 i Touring		03.93	11.96				
	520 i	95	01.88	09.90				
	520 i 24V	110	03.89	09.95				
	520 i Touring	110	11.91	11.96				
	524 td	85	03.88	08.91				
	525 i	125	01.88	09.90				
	525 i 24V	141	09.89	09.95				
	525 i Touring	141	11.91	11.96				
	525 ix	141	04.91	09.95				
	525 ix Touring	141	02.92	11.96				
	525 td	85	04.93	09.95				
	525 td Touring	85	03.93	11.96				
	525 tds	105	09.91	09.95				
	525 tds Touring	105	12.91	11.96				
	530 i	138	01.88	09.95				
	535 i	155	01.88	09.95				

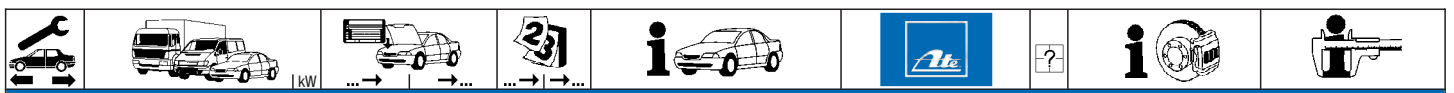

BMW 6er Reihe/E24 (76-89)

	628 CSi 635 CSi M 635 CSi	135		05.82 05.82 04.84	05.87 04.89 04.89	10.0144-4234.3 10.0504-0113.3 10.0522-4005.1 10.0522-4002.1 10.0515-0515.3	340014 340021 340029 340028 340024		Hydraulik Verstärker DS Regler Warnschalter M10x1 Warnschalter M12x1 Hydraulikspeicher	ATE	
	628 CSi 630 CS 633 CSi 635 CSi	◀135 ◀136 ◀ ◀		09.79 02.76 01.76 06.78	04.82 08.79 04.82 04.82	03.2123-7002.3	010187		ThZ 23,81	ATE	
	628 CSi	135		05.82	08.84	- ABS	03.2123-8312.3	010193	ThZ 23,81	ATE	
	628 CSi	◀135		05.82	05.87	+ ABS	03.2123-8711.3	010196	ThZ 23,81	ATE	
	628 CSi	▶135		05.82	08.86	+ ABS					
	635 CSi	◀		05.82	04.89						
	635 CSi	▶		05.82	08.86						
	M 635 CSi	◀		04.84	04.89						
	M 635 CSi	▶		04.84	08.86						
	628 CSi	▶135		09.86	05.87	+ ABS	03.2123-0242.3	010163	ThZ 23,81	ATE	
	635 CSi	▶		09.86	04.89						
	M 635 CSi	▶		09.86	04.89						
	630 CS 633 CSi	◀136 ◀		02.76 01.76	07.78 07.78	+ Automatikgetriebe ¹⁾ + Automatikgetriebe ¹⁾	03.3508-8802.3	310051	Behälter + WE		
	630 CS 633 CSi	136		02.76 01.76	08.76 08.76		13.0441-4018.2	250083	Dichtungssatz	ATE	
	628 CSi	135		09.79	04.82		13.0441-4018.2	250083	Dichtungssatz	ATE	
	630 CS	136		09.76	08.79						
	633 CSi			09.76	04.82						
	635 CSi			06.78	04.82						
	628 CSi	135		05.82	05.87		11.0441-5702.2	250033	Dichtungssatz	ATE	
	635 CSi			05.82	04.89		11.0101-5402.2	260009	Hülssensatz	ATE	
							11.8171-0008.1	990049	Führungsbolzen	ATE	
							11.8116-0091.1	390502	Haltefeder	ATE	
	M 635 CSi			04.84	04.89		13.0441-4018.2	250083	Dichtungssatz	ATE	
	630 CS 633 CSi	136		02.76 01.76	08.76 08.76		13.0460-9030.2	609030	20092 15,0	ATE	
	628 CSi	135		09.79	04.82		13.0460-9031.2	609031	20437 19,0 /WE	ATE	
	630 CS	136		09.76	08.79		13.0460-0123.2	610123	Belagsatz-Zubehör	ATE	
	633 CSi			09.76	04.82		24.8190-0215.2	620215	Warnkontakt L=162mm		
	635 CSi			06.78	04.82						
	628 CSi	135		05.82	05.87		13.0460-7046.2	607046	20629 20,3 +/WE	ATE	
	635 CSi			05.82	04.89		24.8190-0213.2	620213	Warnkontakt L=262mm		
	M 635 CSi			04.84	04.89		13.0460-9031.2	609031	20437 19,0 /WE	ATE	
							24.8190-0214.2	620214	Warnkontakt L=235mm		
	628 CSi 630 CS 633 CSi 635 CSi	135 136		09.79 02.76 01.76 06.78	04.82 08.79 04.82 04.82		24.0122-0111.1	422111	280 22,0 20,4 V		
	628 CSi	135		05.82	05.87		24.0125-0104.1	425104	282 25,0 23,4 V L		
	635 CSi			05.82	04.89						
	628 CSi 630 CS 633 CSi 635 CSi	135 136		09.79 02.76 01.76 06.78	04.82 08.79 04.82 04.82		24.5201-0290.3	331401	4	L=290	
	628 CSi	135		05.82	05.87		83.6124-0422.3	330269	2	L=420	
	635 CSi			05.82	04.89						
	628 CSi 630 CS 633 CSi 635 CSi	135 136		09.79 02.76 01.76 06.78	04.82 08.79 04.82 04.82		24.9242-8007.5 24.9242-8008.5 13.0441-4205.2	230029 230030 250086	<input type="checkbox"/> <input type="checkbox"/> <input type="checkbox"/>	D=42 D=42 Dichtungssatz	
	628 CSi	135		05.82	05.87		11.3331-8501.2	220004	<input type="checkbox"/>	D=33, - Halter	ATE
	635 CSi			05.82	04.89		11.3331-8502.2	220005	<input type="checkbox"/>	D=33, - Halter	ATE
							24.3331-8501.5	240509	<input type="checkbox"/>	D=33, - Halter	ATE
							24.3331-8502.5	240510	<input type="checkbox"/>	D=33, - Halter	ATE
							11.0441-3302.2	250004	<input type="checkbox"/>	Dichtungssatz	ATE
							11.0101-5402.2	260009	<input type="checkbox"/>	Hülssensatz	ATE
							11.8171-0008.1	990049	<input type="checkbox"/>	Führungsbolzen	ATE
							11.8116-0015.1	390492	2 <input type="checkbox"/>	Haltefeder	ATE
	M 635 CSi			04.84	04.89		11.0101-5402.2	260009	<input type="checkbox"/>	Hülssensatz	ATE
							11.8171-0008.1	990049	<input type="checkbox"/>	Führungsbolzen	ATE
							11.8116-0015.1	390492	2 <input type="checkbox"/>	Haltefeder	ATE
	628 CSi 630 CS 633 CSi 635 CSi	135 136		09.79 02.76 01.76 06.78	04.82 08.79 04.82 04.82		13.0460-3024.2 13.0460-0125.2 24.8190-0215.2	603024 610125 620215	1	20436 15,0 /WE Belagsatz-Zubehör Warnkontakt L=162mm	ATE ATE
	628 CSi	135		05.82	05.87		13.0460-7047.2	607047	1	20675 16,5 +/WE	ATE
	635 CSi			05.82	04.89		24.8190-0215.2	620215	1	Warnkontakt L=162mm	
	M 635 CSi			04.84	04.89						
	628 CSi 635 CSi M 635 CSi	135		05.82 05.82 04.84	05.87 04.89 04.89		24.0110-0174.1	410174		284 10,0 8,4	
	628 CSi 630 CS 633 CSi 635 CSi	135 136		09.79 02.76 01.76 06.78	04.82 08.79 04.82 04.82		24.5201-0204.3	331400	2	L=204	

¹⁾ + autom.transmission / + scatola cambio automatico / + transmission automatique / + cambio automático





BMW 6er Reihe/E24 (76-89)

















	628 CSi 635 CSi M 635 CSi	135		05.82 05.82 04.84	05.87 04.89 04.89	24.5201-0204.3 24.5170-0201.3	331400 331450	2 2	am Bremsattel ¹⁾	L=204 L=201
	628 CSi 630 CS 633 CSi 635 CSi	135 136		09.79 02.76 01.76 06.78	04.82 08.79 04.82 04.82	03.0137-0149.2	650149			160 x 25
	628 CSi 635 CSi M 635 CSi	135		05.82 05.82 04.84	05.87 04.89 04.89	03.0137-0150.2 03.0137-9062.2	650150 669062			180 x 25 Bremsbacken-Zubehör
	628 CSi 635 CSi M 635 CSi	135		05.82 05.82 04.84	05.87 04.89 04.89	24.3727-0220.2	580220	2	- Katalysator ²⁾ - Katalysator ²⁾	L=1715
	628 CSi 630 CS 633 CSi 635 CSi	135 136		09.79 02.76 01.76 06.78	04.82 08.79 04.82 04.82	03.2419-9000.3 03.0350-1919.2	030025 071919			Gz 19,05 Gz Reparatursatz
	628 CSi 635 CSi M 635 CSi	135		05.82 05.82 04.84	05.87 04.89 04.89	24.2419-0912.3	030044			Gz 19,05
	628 CSi 630 CS 633 CSi 635 CSi	135 136		09.79 02.76 01.76 06.78	05.87 08.79 04.82 04.89	03.2520-1201.3 03.0450-2006.2	040011 082006			Nz 20,64 Nz Reparatursatz
	628 CSi 635 CSi M 635 CSi	135		05.82 05.82 04.84	05.87 04.89 04.89	24.5905-0320.3	330058		- Rohrleitung ³⁾	L=320
						24.5802-0320.3	330050		+ Rohrleitung ⁴⁾	L=320

BMW 7er Reihe/E23 (77-86)















	728 728 i 730 732 i 733 i 735 i 745 i	125 135 135 145 145 185		04.77 07.78 05.77 05.77 05.77 09.79 04.80	09.79 05.86 08.79 04.86 07.82 04.86 05.86	10.0144-4216.3 10.0504-0113.3 10.0522-4005.1 10.0522-4002.1 10.0515-0515.3	340013 340021 340029 340028 340024			Hydraulik Verstärker DS Regler Warnschalter M10x1 Warnschalter M12x1 Hydraulikspeicher	ATE
	728 728 i 730 732 i 733 i 735 i 745 i	125 135 135 145 145 185		04.77 07.78 05.77 05.77 05.77 09.79 04.80	09.79 05.86 08.79 04.86 07.82 04.86 05.86	03.2122-6912.3	010154		- ABS - ABS - ABS - ABS - ABS - ABS	THz 22,20	ATE
	728 728 i 730 732 i 733 i 735 i 745 i	125 135 135 145 145 185		04.77 07.78 05.77 05.77 05.77 09.79 04.80	09.79 05.86 08.79 04.86 07.82 04.86 05.86	03.2122-7513.3	010155		+ ABS + ABS + ABS + ABS + ABS + ABS	THz 22,20	ATE
	728 728 i 730 732 i 733 i 735 i	125 135 135 145 145		04.77 07.78 05.77 05.77 09.79	09.79 08.82 08.79 08.82 08.81	13.0441-4018.2	250083			Dichtungssatz	ATE
	728 i 732 i 735 i 745 i	135 145 185		09.82 09.82 09.81 04.80	05.86 05.86 05.86 05.86	13.0441-4018.2	250083			Dichtungssatz	ATE
	728 728 i 730 732 i 733 i 735 i	125 135 135 145 145		04.77 07.78 05.77 05.77 05.77 09.79	09.79 08.82 08.79 04.86 07.82 08.81	13.0460-9031.2 13.0460-0123.2 24.8190-0215.2	609031 610123 620215	1		20437 19,0 /WE Belagsatz-Zubehör Warnkontakt L=162mm	ATE ATE
	728 i 735 i 745 i	135 185		09.82 09.81 04.80	05.86 05.86 05.86	13.0460-9031.2 24.8190-0215.2	609031 620215	1		20437 19,0 /WE Warnkontakt L=162mm	ATE
	728 728 i 730 732 i 733 i 735 i	125 135 135 145 145		04.77 07.78 05.77 05.77 05.77 09.79	09.79 08.82 08.79 08.82 07.82 08.81	24.0122-0111.1	422111			280 22,0 20,4 V	
	728 i 732 i 735 i 745 i	135 145 185		09.82 09.82 09.81 04.80	05.86 05.86 05.86 05.86	24.0125-0100.1	425100			280 25,0 23,4 V L	
	728 728 i 730 732 i 733 i	125 135 135 145 145		04.77 07.78 05.77 05.77 05.77	09.79 05.86 08.79 04.86 07.82	24.5201-0290.3	331401	2		L=290	

1) on the brake caliper / sulla pinza freno / sur l'étrier de frein / a la pinza de freno
 2) - catalytic converter / - catalizzatore / - catalyseur / - catalizador
 3) - pipe line / - tubazione / - conduite rigide / - latiguillo
 4) + pipe line / + tubazione / + conduite rigide / + latiguillo



									
BMW 7er Reihe/E23 (77-86)									
	735 i 745 i	185		09.79 04.80	04.86 05.86	24.5201-0290.3	331401	2	L=290
	728 728 i 730 732 i 733 i 735 i 745 i	125 135 135 145 145 185		04.77 07.78 05.77 05.77 05.77 09.79 04.80	09.79 08.81 08.79 08.81 08.81 08.81 08.81	13.0441-3303.2	250043		Dichtungssatz ATE
	728 i 732 i 733 i 735 i 745 i	135 145 145 185		09.81 09.81 09.81 09.81 09.81	05.86 04.86 07.82 04.86 05.86	11.3331-8501.2 11.3331-8502.2 24.3331-8501.5 24.3331-8502.5 11.0441-3302.2 11.0101-5402.2 11.8171-0008.1 11.8116-0015.1	220004 220005 240509 240510 250004 260009 990049 390492	<input type="checkbox"/> <input type="checkbox"/> <input type="checkbox"/> <input type="checkbox"/> <input type="checkbox"/> <input type="checkbox"/> <input type="checkbox"/> <input type="checkbox"/> <input type="checkbox"/>	D=33, - Halter ATE D=33, - Halter ATE D=33, - Halter ATE D=33, - Halter ATE Dichtungssatz ATE Hülzensatz ATE Führungsbolzen ATE Haltefeder ATE
	728 728 i 730 732 i 733 i 735 i 745 i	125 135 135 145 145 185		04.77 07.78 05.77 05.77 05.77 09.79 04.80	09.79 08.81 08.79 08.81 08.81 08.81 08.81	24.8190-0215.2	620215	1	Warnkontakt L=162mm
	728 i 732 i 733 i 735 i 745 i	135 145 145 185		09.81 09.81 09.81 09.81 09.81	05.86 04.86 07.82 04.86 05.86	13.0460-7047.2 24.8190-0215.2	607047 620215	1	20675 16,5 +/WE ATE Warnkontakt L=162mm
	728 728 i 730 732 i 733 i 735 i 745 i	125 135 135 145 145 185		04.77 07.78 05.77 05.77 05.77 09.79 04.80	09.79 08.81 08.79 08.81 08.81 08.81 08.81	24.0110-0147.1	410147		280 10,0 8,4
	728 i 732 i 733 i 735 i 745 i	135 145 145 185		09.81 09.81 09.81 09.81 09.81	05.86 04.86 07.82 04.86 05.86	24.0110-0176.1	410176		284 10,0 8,4
	728 728 i 730 732 i 733 i 735 i 745 i	125 135 135 145 145 185		04.77 07.78 05.77 05.77 05.77 09.79 04.80	09.79 08.81 08.79 08.81 08.81 08.81 08.81	24.5201-0204.3	331400	2	L=204
	728 i 732 i 733 i 735 i 745 i	135 145 145 185		09.81 09.81 09.81 09.81 09.81	05.86 04.86 07.82 04.86 05.86	24.5201-0204.3 24.5170-0201.3	331400 331450	2 2	am Bremssattel ¹⁾
	728 728 i 730 732 i 733 i 735 i 745 i	125 135 135 145 145 185		04.77 07.78 05.77 05.77 05.77 09.79 04.80	09.79 08.81 08.79 08.81 08.81 08.81 08.81	03.0137-0149.2	650149		160 x 25
	728 i 732 i 733 i 735 i 745 i	135 145 145 185		09.81 09.81 09.81 09.81 09.81	05.86 04.86 07.82 04.86 05.86	03.0137-0150.2 03.0137-9062.2	650150 669062		180 x 25 Bremssbacken-Zubehör
	728 728 i 730 732 i 733 i 735 i 745 i	◀125 ◀135 ◀135 ◀145 ◀145 ◀ ◀185		04.77 07.78 05.77 05.77 05.77 09.79 04.80	09.79 05.86 08.79 04.86 07.82 04.86 05.86	03.2419-9000.3 03.0350-1919.2	030025 071919		Gz 19,05 Gz Reparatursatz
	728 728 i 730 732 i 733 i 735 i 745 i	125 135 135 145 145 185		04.77 07.78 05.77 05.77 05.77 09.79 04.80	09.79 05.86 08.79 04.86 07.82 04.86 05.86	03.2522-3601.3	040014		Nz 22,20



















¹⁾ on the brake caliper / sulla pinza freno / sur l'étrier de frein / a la pinza de freno

													
BMW 7er Reihe/E32 (86-94)													
	730 i 6			07.86	02.88	10.0144-4234.3	340014	Hydraulik Verstärker DS Regler Warnschalter M10x1 Warnschalter M12x1 Hydraulikspeicher ATE					
	730 iL 6			12.87	02.88	10.0504-0113.3	340021						
	735 i			09.86	02.88	10.0522-4005.1	340029						
	735 iL			09.86	02.88	10.0522-4002.1	340028						
						10.0515-0515.3	340024						
						10.0522-4005.1	340029						
	750 i	220		07.87	11.90	10.0522-4005.1	340029	Warnschalter M10x1 Warnschalter M12x1					
	750 iL	220		11.86	11.90	10.0522-4002.1	340028						
	750 i	220		12.90	06.94	10.0522-4005.1	340029	Warnschalter M10x1 Warnschalter M12x1 Hydraulikspeicher ATE					
	750 iL	220		12.90	06.94	10.0522-4002.1	340028						
						10.0515-9002.3	340026	ATE					
	730 i 6			07.86	02.88	03.2125-2802.3	010210	THz 25,40 ATE					
	730 iL 6			12.87	02.88								
	735 i			09.86	02.88								
	735 iL			09.86	02.88								
	750 i	220		07.87	06.94								
	750 iL	220		11.86	06.94								
	730 i 6			03.88	06.94				03.2125-3011.3	010211	+ Unterdruckverstärker ¹⁾ THz 25,40 ATE		
	730 iL 6			03.88	06.94								
	735 i			03.88	09.92								
	730 i 6			07.86	10.87	24.3601-8503.5	240535	D=60, - Halter D=60, - Halter Dichtungssatz Hülssensatz Führungsbolzen Haltefeder ATE					
	730 iL 6			12.87	06.94				24.3601-8504.5	240536			
	735 i			09.86	09.92				11.0441-6003.2	250037			
	735 iL			09.86	09.92				11.0101-5402.2	260009			
	740 i	210		09.91	06.94				11.8171-0008.1	990049			
	740 iL	210		10.91	06.94				11.8116-0083.1	390501			
	750 i	220		07.87	12.89								
	750 i	220		01.90	06.94				- ⊕ / + Faustsättel ²⁾				
	750 iL	220		11.86	12.89								
	750 iL	220		01.90	06.94				- ⊕ / + Faustsättel ²⁾				
	730 i 6			11.87	06.94				11.3601-8505.2	220149	D=60, - Halter D=60, - Halter D=60, - Halter Dichtungssatz Hülssensatz Führungsbolzen Haltefeder ATE		
	730 i 8	160		03.91	06.94							24.3601-8505.5	240537
	730 iL 8	160		06.92	06.94							24.3601-8506.5	240538
												11.0441-6003.2	250037
	730 i 6			07.86	06.94	13.0460-6033.2	606033	20968 20,3 +WE Warnkontakt L=235mm ATE					
	730 i 8	160		03.91	06.94				24.8190-0214.2	620214			
	730 iL 6			12.87	06.94								
	730 iL 8	160		06.92	06.94								
	735 i			09.86	09.92								
	735 iL			09.86	09.92								
	740 i	210		09.91	06.94								
	740 iL	210		10.91	06.94								
	750 i	220		07.87	12.89								
	750 i	220		01.90	06.94				- ⊕ / + Faustsättel ²⁾				
	750 iL	220		11.86	12.89								
	750 iL	220		01.90	06.94				- ⊕ / + Faustsättel ²⁾				
	750 i	220		01.90	06.94				+ ⊕ / + Festsättel ³⁾	13.0460-9037.2	609037		
	750 iL	220		01.90	06.94				+ ⊕ / + Festsättel ³⁾	24.8190-0214.2	620214		
	730 i 6			07.86	10.87	24.0128-0101.1	428101	302 28,0 26,4 V L + B					
	730 iL 6			12.87	06.94								
	735 i			09.86	09.92								
	735 iL			09.86	09.92								
	740 i	210		09.91	06.94								
	740 iL	210		10.91	06.94								
	750 i	220		07.87	12.89								
	750 i	220		01.90	06.94				- ⊕ / + Faustsättel ²⁾				
	750 iL	220		11.86	12.89								
	750 iL	220		01.90	06.94				- ⊕ / + Faustsättel ²⁾				
730 i 6			11.87	06.94	24.0122-0103.1	422103	302 22,0 20,4 V L + S + B						
730 i 8	160		03.91	06.94				24.0322-0103.1	522103				
730 iL 8	160		06.92	06.94									
750 i	220		01.90	06.94	+ ⊕ / + Festsättel ³⁾	24.0130-0101.1	430101	324 30,0 28,4 V L + S + B					
750 iL	220		01.90	06.94	+ ⊕ / + Festsättel ³⁾								
	730 i 6			07.86	06.94	24.5113-0423.3	331396	L=423					
	730 i 8	160		03.91	06.94								
	730 iL 6			12.87	06.94								
	730 iL 8	160		06.92	06.94								
	735 i			09.86	09.92								
	735 iL			09.86	09.92								
	740 i	210		09.91	06.94								
	740 iL	210		10.91	06.94								
	750 i	220		07.87	06.94								
	750 iL	220		11.86	06.94								













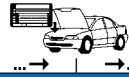



















¹⁾ + vacuum booster / + servofreno a depressione / + amplificateur à dépression / + amplificador de depresión

²⁾ - ⊕ / + fist type calipers / - ⊕ / + pinze flottanti / - ⊕ / + étriers à griffe / - ⊕ / + pinza de puno

³⁾ + ⊕ / + fixed calipers / + ⊕ / + pinze freno fissa / + ⊕ / + étriers fixes / + ⊕ / + pinza de fija





















									
BMW 7er Reihe/E32 (86-94)									
	730 i 6			07.86	10.87	11.3381-8501.2	220018	2	D=38, - Halter ATE D=38, - Halter ATE Dichtungssatz ATE Hülensatz ATE Führungsbolzen ATE Haltefeder ATE
	730 iL 6			12.87	06.94	24.3381-8502.5	240664		
	735 i			09.86	09.92	11.0441-3802.2	250009		
	735 iL			09.86	09.92	11.0101-5402.2	260009		
	730 i 6			11.87	06.94	11.3381-8504.2	220021	2	D=38, - Halter ATE D=38, - Halter ATE D=38, - Halter ATE Dichtungssatz ATE Hülensatz ATE Führungsbolzen ATE Haltefeder ATE
	730 i 8	160		03.91	06.94	24.3381-8503.5	240515		
	730 iL 8	160		06.92	06.94	24.3381-8504.5	240516		
						11.0441-3803.2	250010		
	750 i	220		07.87	12.89	11.0441-3802.2	250009	2	Dichtungssatz ATE Hülensatz ATE Führungsbolzen ATE Haltefeder ATE
	750 iL	220		11.86	12.89	11.0101-5402.2	260009		
						11.8171-0008.1	990049		
						11.8116-0066.1	390577		
	740 i	210		09.91	06.94	11.0441-4002.2	250011	2	Dichtungssatz ATE Hülensatz ATE Führungsbolzen ATE Haltefeder ATE
	740 iL	210		10.91	06.94	11.0101-5402.2	260009		
	750 i	220		01.90	06.94	11.8171-0008.1	990049		
	750 iL	220		01.90	06.94	11.8116-0066.1	390577		
	730 i 6			07.86	06.94	13.0460-3803.2	603803	1	20995 17,3 +/WE ATE Warnkontakt L=235mm
	730 i 8	160		03.91	06.94	24.8190-0214.2	620214		
	730 iL 6			12.87	06.94				
	730 iL 8	160		06.92	06.94				
	735 i			09.86	09.92				
	735 iL			09.86	09.92				
	740 i	210		09.91	06.94				
	740 iL	210		10.91	06.94				
	750 i	220		07.87	06.94				
	750 iL	220		11.86	06.94				
	730 i 6			07.86	10.87	24.0112-0120.1	412120		300 12,0 10,4 L
	730 iL 6			12.87	06.94				
	735 i			09.86	09.92				
	735 iL			09.86	09.92				
	730 i 6			11.87	06.94	24.0110-0118.1	410118		300 9,9 8,4 L
	730 i 8	160		03.91	06.94				
	730 iL 8	160		06.92	06.94				
	740 i	210		09.91	06.94	24.0120-0113.1	420113		300 20,0 18,4 V L
	740 iL	210		10.91	06.94				
	750 i	220		07.87	06.94				
	750 iL	220		11.86	06.94				
	730 i 6			07.86	06.94	24.5201-0204.3	331400	2 2	am Bremsattel 1) L=204 L=201
	730 i 8	160		03.91	06.94	24.5170-0201.3	331450		
	730 iL 6			12.87	06.94				
	730 iL 8	160		06.92	06.94				
	735 i			09.86	09.92				
	735 iL			09.86	09.92				
	740 i	210		09.91	06.94				
	740 iL	210		10.91	06.94				
	750 i	220		07.87	06.94				
	750 iL	220		11.86	06.94				
	730 i 6			07.86	06.94	03.0137-0150.2	650150		180 x 25 Bremsbacken-Zubehör
	730 i 8	160		03.91	06.94	03.0137-9062.2	669062		
	730 iL 6			12.87	06.94				
	730 iL 8	160		06.92	06.94				
	735 i			09.86	09.92				
	735 iL			09.86	09.92				
	740 i	210		09.91	06.94				
	740 iL	210		10.91	06.94				
750 i	220		07.87	06.94					
750 iL	220		11.86	06.94					
	730 i 6			07.86	06.94	24.3727-0219.2	580219	2	L=1855
	730 i 8	160		03.91	06.94				
	735 i			09.86	09.92				
	740 i	210		09.91	06.94				
	750 i	220		07.87	06.94				
	730 i 6			07.86	06.94	24.2419-0922.3	030051		Gz 19,05
	730 i 8	160		03.91	06.94				
	730 iL 6			12.87	06.94				
	730 iL 8	160		06.92	06.94				
	735 i			09.86	09.92				
	735 iL			09.86	09.92				
	730 i 6			07.86	06.94	03.2522-3601.3	040014		Nz 22,20
	730 iL 6			12.87	06.94				
	735 i			09.86	09.92				
	735 iL			09.86	09.92				
	730 i 8	160		03.91	06.94	24.2522-0905.3	040042		Nz 22,20
	730 iL 8	160		06.92	06.94				
	730 i 6			07.86	06.94	24.5905-0320.3	330058		L=320
	730 iL 6			12.87	06.94				
	735 i			09.86	09.92				
	735 iL			09.86	09.92				

¹⁾ on the brake caliper / sulla pinza freno / sur l'étrier de frein / a la pinza de freno

								
BMW Isetta								
	Isetta		01.60	12.62	83.6104-0360.3	330475	2	L=360
	Isetta		01.60	12.62	03.3217-0301.3	020022		(03.3217-0302.3) Rz 17,46
	Isetta		01.60	12.62	83.6104-0360.3	330475		L=360
BMW M1 (79-83)								
	M1		05.79	05.83	13.0460-9031.2	609031		20437 19,0 /WE ATE
	M1		05.79	05.83	13.0460-5032.2	605032		20588 16,5 /WE ATE
BMW Z1 (88-91)								
	2.5	125	07.88	06.91	03.7760-0902.4	300088		10" ATE
	2.5	125	07.88	06.91	03.2022-1201.3	010009		THz 22,20/17,46 ATE
	2.5	125	07.88	06.91	24.3481-1607.5 24.3481-1608.5 11.0441-4810.2 11.0101-5402.2 11.8171-0008.1	240211 240212 250023 260009 990049	<input type="checkbox"/> <input type="checkbox"/>	D=48, - Halter TRW D=48, - Halter TRW Dichtungssatz ATE Hülzensatz ATE Führungsbolzen ATE
	2.5	125	07.88	06.91	13.0460-2921.2 24.8190-0201.2	602921 620201	1	21173 17,0 /WE/S TRW Warnkontakt L=235mm
	2.5	125	07.88	06.91	24.0122-0122.1 24.0322-0122.1	422122 522122		260 22,0 20,4 V L +B 260 22,0 19,6 V L +B PD
	2.5	125	07.88	06.91	24.5102-0304.3	331407	2	L=304
	2.5	125	07.88	08.90	11.0441-3602.2 11.0101-5402.2 11.8171-0008.1 11.8116-0066.1	250008 260009 990049 390577	2	Dichtungssatz ATE Hülzensatz ATE Führungsbolzen ATE Haltefeder ATE
	2.5	125	09.90	06.91	11.3361-8503.2 11.3361-8504.2 24.3361-8503.5 24.3361-8504.5 11.0441-3602.2 11.0101-5402.2 11.8171-0008.1 11.8116-0066.1	220016 220017 240513 240514 250008 260009 990049 390577	<input type="checkbox"/> <input type="checkbox"/> <input type="checkbox"/> <input type="checkbox"/>	D=36, - Halter ATE D=36, - Halter ATE D=36, - Halter ATE D=36, - Halter ATE Dichtungssatz ATE Hülzensatz ATE Führungsbolzen ATE Haltefeder ATE
	2.5	125	07.88	08.90	13.0460-3803.2 24.8190-0213.2	603803 620213	1	20995 17,3 +/WE ATE Warnkontakt L=262mm
	2.5	125	09.90	06.91	13.0460-3605.2 13.0470-3605.2 24.8190-0213.2	603605 LD3605 620213	1	20180 17,3 +/WE ATE 20180 17,3 +/WE ATE Warnkontakt L=262mm
	2.5	125	07.88	08.90	83.6104-0245.3	330525	2	L=245
	2.5	125	09.90	06.91	83.6204-0300.3 24.5170-0201.3	330548 331450	2 2	L=300 L=201 am Bremsattel 1)
	2.5	125	07.88	08.90	03.0137-0149.2 03.0137-9062.2	650149 669062		160 x 25 Bremsbacken-Zubehör
	2.5	125	09.90	06.91	03.0137-0248.2 03.0137-9148.2	650248 669148		161 x 25 Bremsbacken-Zubehör
	2.5	125	07.88	06.91	03.6045-0620.3	320040		BRE 5/25 ATE
	2.5	125	07.88	06.91	24.2419-0922.3	030051		Gz 19,05
	2.5	125	07.88	06.91	03.2520-1201.3 03.0450-2006.2	040011 082006		Nz 20,64 Nz Reparatursatz
	2.5	125	07.88	06.91	24.5802-0320.3	330050		+ Rohrleitung 2) L=320
BMW / GLAS GOGGOMOBIL (55-69)								
	T/TA/TS 300 T/TS 250 T/TS 400		02.55 02.57 05.57	04.67 12.69 05.60	03.3215-0221.3	020013		Rz 15,87

1) on the brake caliper / sulla pinza freno / sur l'étrier de frein / a la pinza de freno

2) + pipe line / + tubazione / + conduite rigide / + latiguillo

									
BORGWARD ISABELLA (54-62)									
	1.5/1500		06.54	02.62		03.2419-1451.3	030012	Gz 19,05	
BÜSSING BUS BS 100 - BS 180									
	BS 113 N		01.69	12.72		03.3134-0300.3 03.3138-2001.3 03.0370-1038.2 03.0370-9998.2	010308 010310 051038 059998	+ Vorderachse ¹⁾ + Hinterachse ²⁾ + Hinterachse ²⁾ + 1. Hinterachse ³⁾ Hz 34,92 Hz 38,10 Hz Reparatursatz Hz Rep. Satz, -Kolben	ATE ATE ATE
	BS 110 N/T/GT BS 120 GT BS 120 V/N BS 170 V/N BS 180 V/N		01.69 01.71 01.69 01.69 01.69	12.72 12.72 12.72 12.72 12.72		03.3134-0300.3	010308	2 Hz 34,92	ATE
BÜSSING BUS KONSUL									
	11		01.62	12.62		83.6103-0320.3	330224	L=320	
BÜSSING BUS PRÄFEKT									
	17/19 Trambus 25/26 Doppeldecker		01.66 01.66	12.67 12.71		03.3138-2001.3 03.0370-1131.2 03.0370-1038.2 03.0370-9998.2	010310 051131 051038 059998	+ Hinterachse ²⁾ + Vorderachse ¹⁾ + Hinterachse ²⁾ + Hinterachse ²⁾ Hz 38,10 Hz Reparatursatz Hz Reparatursatz Hz Rep. Satz, -Kolben	ATE ATE
	26 Doppeldecker		01.68	12.68		03.3134-0300.3 03.3138-2001.3 03.0370-1038.2 03.0370-9998.2	010308 010310 051038 059998	+ Vorderachse ¹⁾ + Hinterachse ²⁾ + Hinterachse ²⁾ + Hinterachse ²⁾ Hz 34,92 Hz 38,10 Hz Reparatursatz Hz Rep. Satz, -Kolben	ATE ATE ATE
	13 Standard		01.68	12.68		03.3138-2001.3 03.0370-1038.2 03.0370-9998.2	010310 051038 059998	2 Hz 38,10 Hz Reparatursatz Hz Rep. Satz, -Kolben	ATE ATE
	13 VÖV		01.67	12.67		03.3134-0300.3	010308	2 Hz 34,92	ATE
	alle Typen		01.65	08.68		83.6103-0320.3	330224	L=320	
BÜSSING BUS PRÄSIDENT									
	alle Typen		01.61	12.64		03.3125-0401.3	010290	Hz 25,40	ATE
	alle Typen		01.61	08.68		83.6103-0320.3	330224	L=320	
BÜSSING BUS SENATOR									
	alle Typen		01.61	12.64		03.3125-0401.3	010290	Hz 25,40	ATE
	alle Typen		01.61	12.65		83.6103-0320.3	330224	L=320	
BÜSSING BUS TU 5 - TU 11									
	TU 5		01.65	12.66		03.3150-0101.3 24.3526-0110.3	010321 340018	2 1 Hz 50,80 Bremslichtschalter	ATE
BÜSSING LKW BS 09 - BS 22									
	BS 12 A/FSA BS 12 L BS 12 L	114 114 141	09.69 09.69 09.71	08.70 08.71 08.72		03.3138-2001.3 03.0370-1038.2 03.0370-9998.2	010310 051038 059998	Hz 38,10 Hz Reparatursatz Hz Rep. Satz, -Kolben	ATE ATE
	BS 13 A/FSA BS 13 L		09.69 09.68	08.70 08.72		03.3138-2001.3 03.0370-1038.2 03.0370-9998.2	010310 051038 059998	+ Hinterachse ²⁾ Hz 38,10 Hz Reparatursatz Hz Rep. Satz, -Kolben	ATE ATE
	BS 14 A/FSA BS 14 L BS 15 L		09.68 09.68 09.68	08.70 08.72 08.72		03.0370-1131.2	051131	Hz Reparatursatz	
	BS 15 A/FSA BS 15 AK		09.69 09.68	08.70 08.70		03.3134-0300.3 03.0370-1131.2	010308 051131	+ Vorderachse ¹⁾ + Hinterachse ²⁾ Hz 34,92 Hz Reparatursatz	ATE
	BS 16 L BS 16 UK		09.67 09.69	08.72 08.70		03.3138-2001.3 03.0370-1131.2 03.0370-1038.2 03.0370-9998.2	010310 051131 051038 059998	+ Hinterachse ²⁾ + Vorderachse ¹⁾ + Hinterachse ²⁾ + Hinterachse ²⁾ Hz 38,10 Hz Reparatursatz Hz Reparatursatz Hz Rep. Satz, -Kolben	ATE ATE ATE
	BS 16 B/SK BS 16 S BS 16 SBB/SBL BS 19 A/SK BS 19 B/BB/BL BS 19 L/K BS 19 S BS 19 SBB/SML		09.69 09.67 09.68 09.69 09.69 09.68 09.67 09.68	08.71 08.72 08.71 08.70 08.71 08.70 08.72 08.69		03.0370-1131.2	051131	Hz Reparatursatz	

¹⁾ + front axle / + asse anteriore / + essieu avant / + eje delantero

²⁾ + rear axle / + asse posteriore / + essieu arrière / + eje trasero

³⁾ + 1. rear axle / + 1. asse posteriore / + 1. essieu arrière / + 1. eje trasero

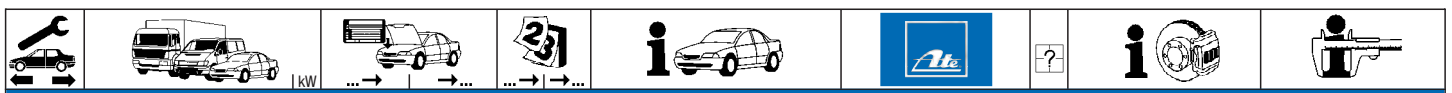

BÜSSING LKW BS 09 - BS 22

	BS 20 S2		09.69	08.72	03.3138-2001.3	010310	3		Hz 38,10 Hz Reparatursatz Hz Rep. Satz, -Kolben	ATE
	BS 22 B		09.69	08.71	03.3138-2001.3	010310		+ 1. Hinterachse ¹⁾	Hz 38,10	ATE
	BS 22 BB/BL		09.70	08.71	03.0370-1038.2	051038		+ Vorderachse ²⁾	Hz Reparatursatz	
	BS 22 K/S		09.70	08.72	03.0370-1038.2	051038		+ 1. Hinterachse ¹⁾	Hz Reparatursatz	
	BS 22 L		09.68	08.72	03.0370-9998.2	059998		+ 1. Hinterachse ¹⁾	Hz Rep. Satz, -Kolben	ATE
	BS 12 A		09.69	08.70	03.3125-0401.3	010290			Hz 25,40	ATE
	BS 12 FSA		09.68	08.70						
	BS 12 L		09.68	08.70						
	BS 13 A/FSA		09.69	08.70						
	BS 13 L		09.68	08.72						
	BS 14 A		09.69	08.70						
	BS 14 FSA		09.67	08.70						
	BS 14 K/AK		09.67	08.68						
	BS 14 L		09.67	08.72						
	BS 15 A/FSA		09.69	08.70						
	BS 15 AK		09.68	08.70						
	BS 15 L		09.68	08.72						
	BS 16 B/BB/SBB/SK		09.69	08.71						
	BS 16 BL/SBL		09.68	08.71						
	BS 16 L/S		09.67	08.72						
	BS 16 S/UK		09.71	08.72						
	BS 16 SK		09.69	08.72						
	BS 19 A/SK		09.69	08.70						
	BS 19 B/BB/BL		09.69	08.71						
	BS 19 K/L/SBB/SBL		09.68	08.70						
	BS 19 S		09.67	08.72						
	BS 20 S2		09.69	08.72						
	BS 22 B		09.69	08.71						
	BS 22 BB/BL		09.70	08.71						
	BS 22 K/S		09.70	08.72						
	BS 22 L		09.68	08.72						
	BS 26 K		09.70	08.72						
	BS 32 K		09.70	08.72						
	BS 12 A		09.69	08.70	83.6103-0260.3	330221			L=260	
	BS 12 FSA		09.68	08.70						
	BS 12 L		09.68	08.70						
	BS 13 A/FSA		09.69	08.70						
	BS 13 L		09.68	08.72						
	BS 14 A		09.69	08.70						
	BS 14 FSA		09.67	08.70						
	BS 14 K/AK		09.67	08.68						
	BS 14 L		09.67	08.72						
	BS 15 A/FSA		09.69	08.70						
	BS 15 AK		09.68	08.70						
	BS 15 L		09.68	08.72						
	BS 16 B/BB/SBB/SK	159	09.69	08.71						
	BS 16 B/BB/SBB/SK	176	09.69	08.71						
	BS 16 BL/SBL	159	09.68	08.71						
	BS 16 BL/SBL	176	09.68	08.71						
	BS 16 L/S	159	09.67	08.72						
	BS 16 L/S	176	09.67	08.72						
	BS 16 SK	159	09.69	08.72						
	BS 16 SK	176	09.69	08.72						
	BS 19 A/SK		09.69	08.70						
	BS 19 B/BB/BL		09.69	08.71						
	BS 19 K/L/SBB/SBL		09.68	08.70						
	BS 19 S		09.67	08.72						
	BS 20 S2		09.69	08.72						
	BS 22 B		09.69	08.71						
	BS 22 BB/BL		09.70	08.71						
	BS 22 K/S		09.70	08.72						
	BS 22 L		09.68	08.72						
	BS 26 K		09.70	08.72						
	BS 32 K		09.70	08.72						

















BÜSSING LKW COMMODORE

	F LS11/16		01.62	08.63	03.3150-0101.3	010321	1		Hz 50,80 Bremslichtschalter	ATE
	FK3		09.63	08.65	24.3526-0110.3	340018				
	FS3		09.63	08.65						
	K LS11/16		01.61	08.63						
	LU11/16		01.62	08.63						
	S LS11/16		01.61	08.63						
	U/UK		08.63	08.68						
	AK LS11/16		01.62	08.63	03.3150-0101.3	010321	2		Hz 50,80	ATE
	FS/SS		09.63	08.65	24.3526-0110.3	340018	1		Bremslichtschalter	
	SA LS11/16		01.62	08.63						
	SAK		09.63	08.68						
	SS		09.65	08.67	03.0370-1131.2	051131			Hz Reparatursatz	
	Export		09.63	08.67	03.3150-0101.3	010321		+ Hinterachse ³⁾	Hz 50,80	ATE
					24.3526-0110.3	340018	1		Bremslichtschalter	
	AK LS11/16		01.62	08.63	03.3508-0501.3	310017			Behälter	
	F LS11/16		01.62	08.63						
	FK3		09.63	08.65						
	FS/SS		09.63	08.65						

¹⁾ + 1. rear axle / + 1. asse posteriore / + 1. essieu arrière / + 1. eje trasero

²⁾ + front axle / + asse anteriore / + essieu avant / + eje delantero

³⁾ + rear axle / + asse posteriore / + essieu arrière / + eje trasero

BÜSSING LKW COMMODORE								
	FS3 K LS11/16 LU11/16 S LS11/16 SA LS11/16 SAK U/UK	09.63 01.61 01.62 01.61 01.62 09.63 08.63	08.65 08.63 08.63 08.63 08.63 08.68 08.68	03.3508-0501.3	310017		Behälter	
BÜSSING LKW LS7/LU7 - LS77/LU77								
	LS 11/F LU 11/A	01.55 01.55	12.62 12.62	03.3150-0101.3 24.3526-0110.3	010321 340018	1	Hz 50,80 Bremslichtschalter	ATE
	LS 55 K/AK	01.61	12.62	24.3526-0110.3	340018	1	Bremslichtschalter	
	LS 75/77	01.59	12.59	24.3526-0110.3	340018	1	Bremslichtschalter	
	LS 75/77 LU 75/77	01.60 01.60	12.62 12.62	03.0370-1131.2	051131		Hz Reparatursatz	
	LS 77 F	01.61	12.61	24.3526-0110.3	340018	1	Bremslichtschalter	
	LS 11/F LU 11/A	01.55 01.55	12.62 12.62	03.3508-0501.3	310017		Behälter	
	LS 55 LU 55	01.60 01.60	12.60 12.60	03.3508-0501.3	310017		Behälter	
	LS 75/77	01.59	12.59	03.3508-0501.3	310017		Behälter	
	LS 75/77 LU 75/77	01.60 01.60	12.62 12.62	03.3508-0401.3	310014		Behälter	
	LS 77 F	01.61	12.61	03.3508-0501.3	310017		Behälter	
	LS 11 LU 11	01.55 01.55	12.57 12.57	83.6103-0500.3	330230		L=500	
	LS 11 LU 11	01.55 01.55	12.57 12.57	83.6103-0600.3	330233		L=600	
BÜSSING LKW SUPERCARGO								
	AK SK/SAK	09.64 09.63	08.66 08.64	03.3150-0101.3 24.3526-0110.3	010321 340018	1	Hz 50,80 Bremslichtschalter	ATE
	AK LU 7/14 S Export SK/SAK U/UK/US	09.65 01.61 09.63 09.63 09.63	08.66 08.63 08.66 08.64 08.66	03.3125-0401.3	010290		Hz 25,40	ATE
	AK LU 7/14 S Export SK/SAK U/UK/US	09.65 01.61 09.63 09.63 09.63	08.66 08.63 08.66 08.64 08.66	83.6103-0260.3	330221		L=260	
BÜSSING LKW 6000-8000								
	6000 S8 7500 S/SU 8000/S	01.59 01.54 01.50	12.60 12.55 12.55	03.3150-0101.3 24.3526-0110.3	010321 340018	1	Hz 50,80 Bremslichtschalter	ATE
	6000 S8 7500 S/SU 8000/S	01.59 01.54 01.50	12.60 12.55 12.55	03.3508-0501.3	310017		Behälter	
	6000 S8	01.59	12.60	83.6103-0700.3	330236		L=700	
	7500 S	01.54	12.55	83.6103-0500.3	330230		L=500	
	7500 SU 8000/S	01.54 01.50	12.55 12.55	83.6103-0600.3	330233		L=600	
	6000 S8 7500 S/SU 8000/S	01.59 01.54 01.50	12.60 12.55 12.55	83.6103-0500.3	330230		L=500	
CHRYSLER CONCORDE (LP41) (92-97)								
	3.3 V6 120	01.95	09.97	13.0460-8003.2	608003		23043 16,0 +	
CHRYSLER VISION (XP41) (93-97)								
	3.5 TSi 155	01.95	12.97	13.0460-8003.2	608003		23043 16,0 +	
CHRYSLER VOYAGER (ES) (90-95)								
	2.5 i 2.5 TD 3.0 i 3.3 i 110 3.3 i 120 3.3 i AWD	08.90 01.92 10.90 08.90 08.90 08.90	12.95 + 15" Rad ¹⁾ 12.95 + 15" Rad ¹⁾ 12.95 + 15" Rad ¹⁾ 12.95 + 15" Rad ¹⁾ 12.95 + 15" Rad ¹⁾ 12.95 + 15" Rad ¹⁾	13.0460-8009.2	608009		21815 18,8 +/WK	
	2.5 i 2.5 TD 3.0 i 3.3 i 110 3.3 i 120	08.90 01.92 10.90 08.90 08.90	12.95 + 15" Rad ¹⁾ 12.95 + 15" Rad ¹⁾ 12.95 + 15" Rad ¹⁾ 12.95 + 15" Rad ¹⁾ 12.95 + 15" Rad ¹⁾	24.0124-0193.1	424193		283 24,0 22,4 V	

¹⁾ + 15" wheel / + ruota 15" / + roue 15" / + rueda 15"



CHRYSLER VOYAGER (ES) (90-95)

	3.3 i AWD		08.90	12.95	+ 15" Rad ¹⁾	24.0124-0193.1	424193		283 24,0 22,4 V
	2.5 i 2.5 TD 3.0 i 3.3 i 3.3 i	110 120	08.90 01.92 10.90 08.90 08.90	12.95 12.95 12.95 12.95 12.95		24.3220-1748.3	020584		Rz 20,64

CITROEN 2CV (63-90)

	4 6 6 Charleston 6 Club 6 Special		07.76 07.76 10.80 07.76 07.79	06.79 06.79		24.2120-1502.3	010405		THz 20,64
	6 Charleston 6 Club 6 Special	ORGA 01666 ORGA 01666 ORGA 01666		12.90 12.90 12.90		13.0460-4906.2 13.0460-4910.2	604906 604910	+ Handbremse ²⁾	20207 12,0 20285 7,1
	6 Charleston 6 Club 6 Special	ORGA 01666 ORGA 01666 ORGA 01666		12.90 12.90 12.90		24.0107-0100.1	407100		244 7,0 6,3
	4 4 6 Charleston 6 Club 6 Special AK 400 Fourgonnette		03.70 07.70 10.80 07.76 07.79 07.70	06.70 06.79		24.3228-1102.3 24.3228-1101.3	020347 020297		Rz 28,57 Rz 28,57
	4 6 6 Charleston 6 Club 6 Special	ORGA 01665 ORGA 01665 ORGA 01665 ORGA 01665	07.70 07.70 10.80 07.79 07.76	06.79 06.79		03.0420-0228.3	680228		28,57/200x36 Kit
	4 6 6 Charleston 6 Club 6 Special		07.70 07.70 10.80 07.79 07.76	06.79 06.79		24.3217-1101.3	020309		Rz 17,46
	6 Charleston 6 Club 6 Special	ORGA 01665 ORGA 01666 ORGA 01666	12.90 12.90 12.90			24.3215-1602.3	020355		Rz 15,87
	4 6 6 Charleston 6 Club 6 Special AK 400 Fourgonnette		03.70 03.70 10.80 07.79 07.76 06.70	06.79 06.79 12.90 12.90 12.90 08.78		03.0137-0092.2 03.0137-9070.2	650092 669070		180 x 34 Bremsbacken-Zubehör

CITROEN ACADIANE (78-85)

	0.6		08.78	12.85		24.0107-0100.1	407100		244 7,0 6,3
	0.6		08.78	12.85		03.0137-0092.2 03.0137-9070.2	650092 669070		180 x 34 Bremsbacken-Zubehör













CITROEN AMI 8 (69-78)

	0.6		08.69	12.78		24.0107-0100.1	407100		244 7,0 6,3
	0.6		08.69	12.78		24.3215-1602.3	020355		Rz 15,87
	0.6 1.0 Super		08.69 01.73	12.78 12.77		03.0137-0092.2 03.0137-9070.2	650092 669070		180 x 34 Bremsbacken-Zubehör

CITROEN BX (82-93)

	1.4 1.4 1.6 1.9 4X4 1.9 D 11 14 15 16 18 D 18 TRD 19 19 19 19 19 4x4 19 D 19 D 19 E	44 52 85 92 52 59 44 66 70 75 77 78 47 51 80		01.87 01.87 01.87 02.92 01.87 10.86 09.82 10.87 09.82 10.85 09.88 02.88 09.85 10.84 06.89 09.82 09.87 02.88	01.92 01.92 01.92 06.94 01.92 06.92 12.93 05.92 12.93 09.93 12.93 12.93 08.85 05.91 08.87 12.93 12.93		13.0460-3915.2 13.0460-0403.2	603915 610403		20635 18,0 +WK Belagsatz-Zubehör
--	---	--	--	--	---	--	----------------------------------	------------------	--	-------------------------------------

¹⁾ + 15" wheel / + ruota 15" / + roue 15" / + rueda 15"
²⁾ + parking brake / + freno di stationamento / + frein à main / + freno de mano

									
CITROEN BX (82-93)									
	19 GTI	88	09.88	12.93	13.0460-3915.2	603915		20635 18,0 +/WK	BDX
	19 GTI	90	06.86	08.88	13.0460-0403.2	610403		Belagsatz-Zubehör	BDX
	19 GTI 16V	108	09.88	12.93	13.0460-3915.2	603915		20635 18,0 +/WK	BDX
	19 GTI 16V	116	09.87	08.88	13.0460-0406.2	610406		Belagsatz-Zubehör	BDX
	1.4	44	01.87	01.92	24.0110-0183.1	410183		266 10,0 8,0	
	1.4	52	01.87	01.92					
	1.6	85	01.87	01.92					
	1.9 4X4	92	02.92	06.94					
	1.9 D	52	01.87	01.92					
	11		10.86	06.92					
	14		09.82	12.93					
	15	59	10.87	05.92					
	16		09.82	12.93					
	18 D	44	10.85	09.93					
	18 TRD	66	09.88	12.93					
	19	70	02.88	12.93					
	19	75	09.85	12.93					
	19	77	10.84	08.85					
	19 4x4	78	06.89	05.91					
	19 D	47	09.82	08.87					
	19 D	51	09.87	12.93					
	19 E	80	02.88	12.93					
	19 GTI	88	09.88	12.93					
	19 GTI	90	06.86	08.88					
	19 GTI 16V	108	09.88	12.93	24.0120-0133.1	420133		266 20,5 18,5 V +S +B	
	19 GTI 16V	116	09.87	08.88	24.0320-0133.1	520133		266 20,5 18,5 V +S +B PD	
	1.4	44	01.87	01.92 - ABS	24.5119-0435.3	330472	2	L=430	
	1.4	52	01.87	01.92 - ABS					
	1.6	85	01.87	01.92 - ABS					
	1.9 4X4	92	02.92	06.94					
	1.9 D	52	01.87	01.92 - ABS					
	11		10.86	06.92 - ABS					
	14		09.82	12.93 - ABS					
	15	59	10.87	05.92 - ABS					
	16		09.82	12.93 - ABS					
	18 D	44	10.85	09.93 - ABS					
	18 TRD	66	09.88	12.93 - ABS					
	19	70	02.88	12.93 - ABS					
	19	75	09.85	12.93 - ABS					
	19	77	10.84	08.85 - ABS					
	19 4x4	78	06.89	05.91 - ABS					
	19 D	47	09.82	08.87 - ABS					
	19 D	51	09.87	12.93 - ABS					
	19 E	80	02.88	12.93 - ABS					
	19 GTI	88	09.88	12.93 - ABS					
	19 GTI	90	06.86	08.88 - ABS					
	1.4	44	01.87	01.92 + ABS	24.5120-0435.3	330488	2	L=430	
	1.4	52	01.87	01.92 + ABS					
	1.6	85	01.87	01.92 + ABS					
	1.9 D	52	01.87	01.92 + ABS					
	11		10.86	06.92 + ABS					
	14		09.86	12.93 + ABS					
	15	59	10.87	05.92 + ABS					
	16		09.86	12.93 + ABS					
	18 D	44	10.85	09.93 + ABS					
	18 TRD	66	09.86	12.93 + ABS					
	19	70	02.88	12.93 + ABS					
	19	75	09.86	12.93 + ABS					
	19 4x4	78	06.89	05.91 + ABS					
	19 D	47	09.86	08.87 + ABS					
	19 D	51	09.87	12.93 + ABS					
	19 E	80	02.88	12.93 + ABS					
	19 GTI	88	09.88	12.93 + ABS					
	19 GTI	90	09.86	08.88 + ABS					
	19 GTI 16V	108	09.88	12.93					
	19 GTI 16V	116	09.87	08.88					
	1.4	44	01.87	01.92	24.0107-0105.2	407105		224 7,0 5,0	
	1.4	52	01.87	01.92					
	1.6	85	01.87	01.92					
	1.9 4X4	92	02.92	06.94					
	1.9 D	52	01.87	01.92					
	11		10.86	06.92					
	14		09.82	12.93					
	15	59	10.87	05.92					
	16		09.82	12.93					
	18 D	44	10.85	09.93					
	18 TRD	66	09.88	12.93					
	19	70	02.88	12.93					
	19	75	09.85	12.93					
	19	77	10.84	08.85					
	19 4x4	78	06.89	05.91					
	19 D	47	09.82	08.87					
	19 D	51	09.87	12.93					
	19 E	80	02.88	12.93					
	19 GTI	88	09.88	12.93					
	19 GTI	90	06.86	08.88					





CITROEN BX (82-93)

	19 GTI 16V 19 GTI 16V	108 116		09.88 09.87	12.93 08.88	24.0107-0105.2	407105		224 7,0 5,0
	1.4 1.4 1.6 1.9 4X4 1.9 D 11 14 15 16 18 D 18 TRD 19 19 19 19 4x4 19 D 19 D 19 E 19 GTi 19 GTi 19 GTi 16V 19 GTi 16V	44 52 85 92 52 59 44 66 70 75 77 78 47 51 80 88 90 108 116		01.87 01.87 01.87 02.92 01.87 10.86 11.82 10.87 11.82 10.85 09.88 02.88 09.85 10.84 06.89 11.82 09.87 02.88 09.88 06.86 09.88 09.87	01.92 01.92 01.92 06.94 01.92 06.92 12.93 05.92 12.93 09.93 12.93 12.93 08.85 05.91 08.87 12.93 12.93 12.93 08.88 08.88 12.93 08.88	24.3727-0310.2	580310	2	L=1651
	1.4 1.4 1.6 1.9 4X4 1.9 D 16 18 D 19 19 19 19 19 D 19 D 19 E 19 GTi 19 GTi	44 52 85 92 52 44 70 75 77 47 51 80 88 90	◀	01.87 01.87 01.87 02.92 01.87 09.82 10.85 02.88 09.85 10.84 09.82 09.87 02.88 09.88 06.86	01.92 01.92 01.92 06.94 01.92 12.93 09.93 12.93 12.93 08.85 08.87 12.93 12.93 12.93 12.93	24.3728-0304.2	590304		L=674

CITROEN CX I Limousine (74-85)

	2000 2000 2200 2200 D 2400 2400 GTi 2400 GTi 2500 D	75 78 82 49 85 94 96 55		07.74 06.79 09.74 10.75 08.76 06.77 06.77 02.78	05.79 05.80 07.76 02.79 05.80 05.80 05.80	13.0460-4900.2	604900	+ Handbremse 1)	20371 8,1 CIT
	2000 2200 2400 2400 GTi 2400 GTi 2500 D 2500 D Turbo 2500 GTi Turbo 2 2500 TRi	78 85 88 94 96 55 70 122 100		06.80 06.81 06.80 06.80 06.80 06.80 04.83 06.84 07.83	08.85 08.85 05.82 06.82 06.82 06.82 08.85 08.85 08.85	13.0460-4900.2 13.0460-0408.2	604900 610408	+ Handbremse 1)	20371 8,1 Belagsatz-Zubehör CIT CIT
	2000 2000 2200 2200 2200 D 2400 2400 2400 GTi 2400 GTi 2500 D 2500 D Turbo 2500 GTi Turbo 2 2500 TRi	75 78 82 85 49 85 88 94 96 55 70 122 100		07.74 06.79 09.74 06.81 10.75 08.76 06.80 06.77 06.77 02.78 04.83 06.84 07.83	05.79 08.85 07.76 08.85 02.79 05.80 05.82 06.82 06.82 06.82 08.85 08.85 08.85	24.0120-0108.1	420108		260 20,0 18,0 V

CITROEN CX I Kombi (75-85)

	2000 2000 2200 D 2400 2500 D	75 78 49 85 55		09.75 06.79 08.76 08.78 02.78	05.79 05.80 02.79 05.80 05.80	13.0460-4900.2	604900	+ Handbremse 1)	20371 8,1 CIT
	2000 2200 2400 2400 GTi 2500 D 2500 D Turbo 2500 TRi	78 85 88 94 55 70 100		06.80 06.81 06.80 07.82 06.80 04.83 07.83	08.85 08.85 05.82 06.83 08.85 08.85 08.85	13.0460-4900.2 13.0460-0408.2	604900 610408	+ Handbremse 1)	20371 8,1 Belagsatz-Zubehör CIT CIT

1) + parking brake / + freno di stationamento / + frein à main / + freno de mano



CITROEN CX I Kombi (75-85)

	2000	75		09.75	05.79	24.0120-0108.1	420108		260 20,0 18,0 V	
	2000	78		06.79	08.85					
	2200	85		06.81	08.85					
	2200 D	49		08.76	02.79					
	2400	85		08.78	05.80					
	2400	88		06.80	05.82					
	2400 GTi	94		07.82	06.83					
	2500 D	55		02.78	08.85					
	2500 D Turbo	70		04.83	08.85					
	2500 TRi	100		07.83	08.85					
	2000	75		09.75	05.79	13.0460-4911.2	604911		20389 15,4	CIT
	2000	78		06.79	08.85	13.0460-0264.2	610264		Belagsatz-Zubehör	
	2200	85		06.81	08.85					
	2200 D	49		08.76	02.79					
	2400	85		08.78	05.80					
	2400	88		06.80	05.82					
	2400 GTi	94		07.82	06.83					
	2500 D	55		02.78	08.85					
	2500 D Turbo	70		04.83	08.85					
	2500 TRi	100		07.83	08.85					

CITROEN CX II Limousine (86-92)

	20	78		09.85	12.92	13.0460-4900.2	604900	+ Handbremse 1)	20371 8,1	CIT
	22 TRS	83		09.85	12.92	13.0460-0408.2	610408		Belagsatz-Zubehör	CIT
	22 TRS	85		09.85	07.89					
	25 D	54		09.85	12.92					
	25 D Turbo	70		09.85	12.86					
	25 D Turbo 2	88		01.87	12.92					
	25 GTi	89		05.86	12.92					
	25 GTi Turbo 2	115		09.86	12.92					
	25 GTi Turbo 2	122		09.85	12.92					
	25 TRi	100		09.85	12.92					
	20	78		09.85	12.92	24.0120-0108.1	420108		260 20,0 18,0 V	
	22 TRS	83		09.85	12.92					
	22 TRS	85		09.85	07.89					
	25 D	54		09.85	12.92					
	25 D Turbo	70		09.85	12.86					
	25 D Turbo 2	88		01.87	12.92					
	25 GTi	89		05.86	12.92					
	25 GTi Turbo 2	115		09.86	12.92					
	25 GTi Turbo 2	122		09.85	12.92					
	25 TRi	100		09.85	12.92					

CITROEN CX II Kombi (86-92)

	20	78		09.85	08.86	13.0460-4900.2	604900	+ Handbremse 1)	20371 8,1	CIT
	22 TRS	83		09.85	12.92	13.0460-0408.2	610408		Belagsatz-Zubehör	CIT
	22 TRS	85		09.85	07.89					
	25 D	54		05.86	12.92					
	25 D Turbo	70		09.85	12.86					
	25 D Turbo 2	88		01.87	12.92					
	25 i	89		05.86	12.92					
	25 TRi	100		09.85	12.92					
	20	78		09.85	08.86	24.0120-0108.1	420108		260 20,0 18,0 V	
	22 TRS	83		09.85	12.92					
	22 TRS	85		09.85	07.89					
	25 D	54		05.86	12.92					
	25 D Turbo	70		09.85	12.86					
	25 D Turbo 2	88		01.87	12.92					
	25 i	89		05.86	12.92					
	25 TRi	100		09.85	12.92					
	20	78		09.85	08.86	13.0460-4911.2	604911		20389 15,4	CIT
	22 TRS	83		09.85	12.92	13.0460-0264.2	610264		Belagsatz-Zubehör	
	22 TRS	85		09.85	07.89					
	25 D	54		05.86	12.92					
	25 D Turbo	70		09.85	12.86					
	25 D Turbo 2	88		01.87	12.92					
	25 i	89		05.86	12.92					
	25 TRi	100		09.85	12.92					

CITROEN C15 (84-05)











	1.0	◀	ORGA 04195	10.84		24.2117-1501.3	010398		THz 17,46	
	1.0	▶	ORGA 04195	10.84		24.2119-1705.3	010460		THz 19,05	
	1.1	▶	ORGA 04195	07.87						
	1.4	▶	ORGA 04195	07.86						
	1.4	▶	ORGA 04195	05.87						
	1.0		ORGA 04196		12.97	24.3481-1609.7	220197	■	D=48, + Halter	TRW
	1.1 (1118)	44	ORGA 04196	09.87	12.96 + (r)	24.3481-1610.7	220198	■	D=48, + Halter	TRW
	1.1 (1124)				12.96					
	1.3			09.87	05.88 + (r)					
	1.4		ORGA 04196		12.96					
	1.4	55		05.87	07.96					
	1.8 D			10.84	12.00					
	1.8 D	44		04.87	08.00					

1) + parking brake / + freno di stationamento / + frein à main / + freno de mano





CITROEN C15 (84-05)

	1.0 1.1 (1118) 1.1 (1124) 1.3 1.4 1.4 1.8 D 1.8 D 1.9 D	44 55 44	ORGA 04196 ORGA 04196 ORGA 04196 ORGA 04196 ORGA 04196	09.87 09.87 07.96 05.87 10.84 04.87 10.00	12.97 12.96 + F 12.96 05.88 + F 12.96 07.96 12.00 08.00 12.05	13.0460-2825.2 13.0460-0060.2	602825 610060	21614 17,7 +WK Belagsatz-Zubehör	TRW TRW
	1.0 1.1 (1124) 1.4 1.4	55	ORGA 04195 ORGA 04195 ORGA 04195 ORGA 04195	10.84 10.84 07.86 05.87	10.84 10.84 07.86 05.87	13.0460-3952.2 13.0460-0403.2	603952 610403	20905 18,0 +WK Belagsatz-Zubehör	BDX BDX
	1.0 1.1 (1118) 1.1 (1124) 1.3 1.4 1.4 1.8 D 1.8 D 1.9 D	44 55 44	ORGA 04196 ORGA 04196 ORGA 04196 ORGA 04196	09.87 09.87 07.86 05.87 10.84 04.87 10.00	12.97 12.96 + F 12.96 05.88 + F 12.96 07.96 12.00 08.00 12.05	24.0110-0187.1	410187	247 10,0 9,0 +S +B	
	1.0 1.1 (1118) 1.1 (1124) 1.3 1.4 1.4 1.8 D 1.8 D	44 55 44	ORGA 04196 ORGA 04196 ORGA 04196 ORGA 04196	09.87 09.87 07.86 05.87 10.84 04.87 10.00	12.97 12.96 + F 12.96 05.88 + F 12.96 07.96 12.00 08.00	24.5112-0325.3	330415	L=355	
	1.0 1.1 (1118) 1.1 (1124) 1.3 1.4 1.4 1.8 D 1.8 D 1.9 D	44 55 44	ORGA 04196 ORGA 04196 ORGA 04196 ORGA 04196	09.87 09.87 07.86 05.87 10.84 04.87 10.00	12.97 12.96 + F 12.96 05.88 + F 12.96 07.96 12.00 08.00 12.05	24.5228-0185.3	330107	L=185	
	1.0 1.1 1.3 1.4 1.4 1.8 D 1.8 D 1.9 D	40 55 44	ORGA 04196 ORGA 04196 ORGA 04196	10.84 10.84 09.87 07.86 05.87 10.84 04.87 10.00	12.97 12.96 05.88 + F 12.96 07.96 12.00 08.00 12.05	24.3222-1118.3	020315	Rz 22,20	BDX
	1.0 1.1 1.3 1.4 1.4 1.8 D 1.8 D 1.9 D	40 55 44	ORGA 04196 ORGA 04196 ORGA 04196	10.84 10.84 09.87 07.86 05.87 10.84 04.87 10.00	12.97 12.96 05.88 + F 12.96 07.96 12.00 08.00 03.01	03.0137-0285.2 03.0137-9188.2	650285 669188	229 x 42 AUT Bremsbacken-Zubehör	BDX BDX
	1.0 1.1 (1118) 1.1 (1124) 1.3 1.4 1.4 1.8 D 1.8 D 1.9 D	44 55 44	ORGA 04196 ORGA 04196 ORGA 04196 ORGA 04196	09.87 09.87 07.86 05.87 10.84 04.87 10.00	12.97 12.96 + F 12.96 05.88 + F 12.96 07.96 12.00 08.00 12.05	24.0222-8017.1	480071	229/230 x 50,8	
	1.0 1.1 1.3 1.4 1.4 1.8 D 1.8 D 1.9 D	40 55 44	ORGA 04196 ORGA 04196 ORGA 04196	10.84 10.84 09.87 07.86 05.87 10.84 04.87 10.00	12.97 12.96 05.88 + F 12.96 07.96 12.00 08.00 12.05	03.0520-2022.3	692022	22,20/229x42 TopKit	BDX
	1.0 1.1 1.3 1.4 1.4 1.8 D 1.8 D 1.9 D	40 55 44	ORGA 04196 ORGA 04196 ORGA 04196	10.84 10.84 09.87 07.86 05.87 10.84 04.87 10.00	12.97 12.96 05.88 + F 12.96 07.96 12.00 08.00 12.05	24.3727-0324.2	580324	Länge beachten ¹⁾	L=1715
	1.0 1.1 (1118) 1.1 (1124) 1.3 1.4	44	ORGA 04196 ORGA 04196 ORGA 04196 ORGA 04196	10.84 09.87 10.84 09.87 07.86	12.97 12.96 + F 12.96 05.88 + F 12.96	24.6512-1507.3	320023	BRL (3)	

¹⁾ notice length / attenzione lunghezza / faire attention longueur / atención largo



CITROEN C15 (84-05)									
	1.4 1.8 D 1.8 D 1.9 D	55 44		05.87 10.84 04.87 10.00	07.96 12.00 08.00 12.05	24.6512-1507.3	320023		BRL (3)
CITROEN C25 (81-94)									
	1.8 1.9 D 1.9 DT 1.9 TD 2.0 2.5 D 2.5 D 4X4 2.5 TD	60 55		07.87 07.87 10.91 04.92 11.81 10.85 11.83 08.87	03.94 03.94 01.94 03.94 03.94 03.94 -1,8 t 12.86 -1,8 t 03.94	24.2122-0801.3	010373	1 Anschluß verschließen ¹⁾	THz 22,20
	1.8 1.9 D 1.9 DT 1.9 TD 2.0 2.5 D 2.5 D 4X4 2.5 TD	155248 155248 60 155248 155248 155248 55 155248 155248		03.94 03.94 01.94 04.92 03.94 03.94 12.86 03.94	-1,8 t -1,8 t -1,8 t	24.0101-3801.2	260045		Bremssattel-Zubehör TRW
	1.8 1.9 D 1.9 DT 1.9 TD 2.0 2.5 D 2.5 D 4X4 2.5 TD	60 55		07.87 07.87 10.91 04.92 11.81 10.85 11.83 08.87	03.94 03.94 01.94 03.94 03.94 03.94 -1,8 t 12.86 -1,8 t 03.94 -1,8 t	13.0460-2901.2	602901		20741 19,0 +/WK/S TRW
	2.5 D 2.5 D 4X4 2.5 TD	55		10.85 11.83 08.87	03.94 +1,8 t 12.86 +1,8 t 03.94 +1,8 t	13.0460-2902.2	602902		21205 19,0 +/WK/S TRW
	1.8 1.9 D 1.9 DT 2.0 2.5 D 2.5 D 4X4 2.5 TD	60 55	155247 155247 155247 155247 155247 155247	07.87 07.87 10.91 11.81 10.85 11.83 08.87	-1,8 t -1,8 t -1,8 t	24.0113-0168.1	413168		256 13,0 11,0
	1.8 1.9 D 1.9 DT 1.9 TD 2.0 2.5 D 2.5 D 4X4 2.5 TD	155248 155248 60 155248 155248 155248 55 155248 155248		03.94 03.94 01.94 04.92 03.94 03.94 12.86 03.94	-1,8 t -1,8 t -1,8 t	24.0116-0105.1	416105		256 16,1 13,5 +B
	2.5 D 2.5 D 4X4 2.5 TD	55		10.85 11.83 08.87	03.94 +1,8 t 12.86 +1,8 t 03.94 +1,8 t	24.0116-0106.1	416106		290 16,0 14,8
	1.8 1.9 D 1.9 DT 2.0 2.5 D 2.5 D 4X4	60 55	171999 171999 171999 171999 171999	07.87 07.87 10.91 11.81 10.85 11.83		24.5112-0362.3	330512	4	L=362
	1.8 1.9 D 1.9 DT 1.9 TD 2.0 2.5 D 2.5 D 4X4 2.5 TD	172000 172000 60 172000 172000 172000 55 172000		03.94 03.94 01.94 04.92 03.94 03.94 12.86 03.94		24.5112-0435.3 24.5112-0436.3	330524 330574	2 2	L=435, + Clip L=435, - Clip
	1.8 2.0 2.5 TD			07.87 11.81 08.87	03.94 03.94 03.94 -1,8 t	24.5112-0260.3	330577	1 <input type="checkbox"/>	L=260
	1.9 D 1.9 DT 2.5 D 2.5 D 4X4 2.5 TD	60 55		07.87 10.91 10.85 11.83 08.87	03.94 01.94 03.94 12.86 03.94 +1,8 t	24.5112-0285.3	330604	1 <input type="checkbox"/>	L=285
	1.8 1.9 D 1.9 DT 1.9 TD 2.0 2.5 D 2.5 D 4X4 2.5 TD	073501 073501 60 073501 073501 073501 55 073501 073501		03.94 03.94 01.94 04.92 03.94 03.94 12.86 03.94	-0,8 t -1,8 t -1,8 t -1,8 t	24.3225-1101.3	020294		Rz 25,40 TRW
	2.5 D 2.5 D 4X4 2.5 TD	55		10.85 11.83 08.87	03.94 +1,8 t 12.86 +1,8 t 03.94 +1,8 t	24.3226-1101.3	020296		Rz 26,99





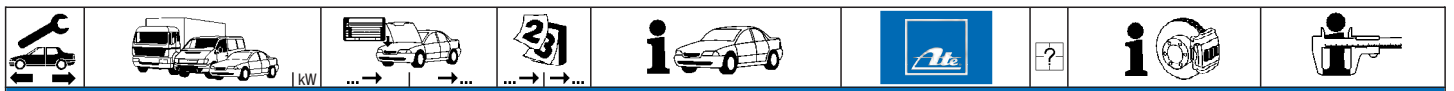













¹⁾ 1 close (plug) connection / tappare 1 raccordo / fermer 1 raccord / cerrar 1 conexión





CITROEN C25 (81-94)										
	1.8			07.87	03.94	03.0137-0330.2 03.0137-9216.2	650330 669216		254 x 57 HEB Bremsbacken-Zubehör	TRW TRW
	1.9 D			07.87	03.94					
	1.9 DT	60		10.91	01.94					
	1.9 TD			04.92	03.94					
	2.0			11.81	03.94					
	2.5 D			10.85	03.94 - 1,8 t					
	2.5 D 4X4	55		11.83	12.86 - 1,8 t					
	2.5 TD			08.87	03.94 - 1,8 t					
	2.5 D			10.85	03.94 + 1,8 t	03.0137-0269.2 03.0137-9169.2	650269 669169		254 x 57 HEB Bremsbacken-Zubehör	
	2.5 D 4X4	55		11.83	12.86 + 1,8 t					
	2.5 TD			08.87	03.94 + 1,8 t					
	1.8			07.87	03.94	24.0225-4002.1	480048		254/255,6 x 64,4	
	1.9 D			07.87	03.94					
	1.9 DT	60		10.91	01.94					
	1.9 TD			04.92	03.94					
	2.0			11.81	03.94					
	2.5 D			10.85	03.94					
	2.5 D 4X4	55		11.83	12.86					
	2.5 TD			08.87	03.94					
	1.8			03.94	- 0,8 t	03.0520-0125.3	690125		25,40/254x57 TopKit	TRW
	1.9 D	073501		03.94						
	1.9 DT	073501		01.94						
	1.9 TD	60 073501		04.92	03.94					
	2.0	073501		03.94						
	2.5 D	073501		03.94	- 1,8 t					
	2.5 D 4X4	55 073501		12.86	- 1,8 t					
	2.5 TD	073501		03.94	- 1,8 t					
	1.8			07.87	03.94 - 0,8 t	24.3727-0527.2	580527	1	L=2566	
	1.9 D			07.87	03.94					
	1.9 DT	60		10.91	01.94					
	1.9 TD			04.92	03.94					
	2.0			11.81	03.94					
	2.5 D			10.85	03.94					
	2.5 D 4X4	55		11.83	12.86					
	2.5 TD			08.87	03.94					
	1.8		073500	07.87		24.6513-1701.3	320160		BRL 3/10 (4)	
	1.9 D		073500	07.87						
	1.9 DT	60	073500	10.91						
	2.0		073500	11.81						
	2.5 D		073500	10.85						
	2.5 D 4X4	55	073500	11.83						
	2.5 TD		073500	08.87						
	1.8			07.87	06.90	24.3728-0515.2	590515		L=1200	
	1.9 D			07.87	06.90					
	2.0			11.81	06.90					
	2.5 D			10.85	06.90					
	2.5 D 4X4	55		11.83	12.86					
	2.5 TD			08.87	06.90					
CITROEN DYANE (69-83)										
	0.6			08.77	07.83	13.0460-4906.2	604906		20207 12,0	CIT
	0.6			08.77	07.83	24.0107-0100.1	407100		244 7,0 6,3	
	0.4			09.69	06.70	24.3228-1102.3	020347		Rz 28,57	
	0.6			09.69	06.70					
	0.4			07.70	07.75					
	0.4			07.70	07.77	24.3228-1101.3	020297		Rz 28,57	
	0.6			07.70	07.77					
	0.6			07.70	07.77					
	0.4			07.70	07.75	03.0420-0228.3	680228		28,57/200x36 Kit	CIT
	0.6			07.70	07.77					
	0.4			07.70	07.75	24.3217-1101.3	020309		Rz 17,46	
	0.6			07.70	07.77					
	0.6			08.78	07.83	24.3215-1602.3	020355		Rz 15,87	
	0.4			01.70	07.75	03.0137-0092.2 03.0137-9070.2	650092 669070		180 x 34 Bremsbacken-Zubehör	BDX BDX
	0.6			01.70	07.83					
CITROEN LN/LNA (76-86)										
	0.6			11.78	12.86	24.2117-1501.3	010398		THz 17,46	
	0.6			10.81	12.86	24.0109-0108.1	409108		245 9,0 7,0	
	1.1			07.82	12.86					
	0.6			07.82	12.86	83.6196-0325.3	330727	■	L=325	
	1.1			07.82	12.86					
	0.6			11.77	06.82 - Citroen-Bremse 1)	24.3222-1102.3	020257		Rz 22,20	BDX
	0.6			11.78	06.82 + Citroen-Bremse 2)					
	0.6			07.82	12.86					
	1.1			07.82	12.86					

1) - Citroen brake / - freno Citroen / - freins Citroen / - freno de Citroen
 2) + Citroen brake / + freno Citroen / + freins Citroen / + freno de Citroen

CITROEN LN/LNA (76-86)												
	0.6 0.6 1.1			11.76 11.77 07.82	10.77 12.86 12.86		03.0137-9032.2 03.0137-9032.2	669032 669032			Bremsbacken-Zubehör Bremsbacken-Zubehör	BDX BDX
CITROEN MEHARI (68-87)												
	0.6			01.77	12.87		24.0107-0100.1	407100			244 7,0 6,3	
	0.6			01.72	07.77		24.3228-1101.3	020297			Rz 28,57	
	0.6			01.68	07.77		24.3217-1101.3	020309			Rz 17,46	
	0.6			01.68	12.87		03.0137-0092.2 03.0137-9070.2	650092 669070			180 x 34 Bremsbacken-Zubehör	BDX BDX
CITROEN VISA (78-89)												
	0.6 1.0 1.1 E 1.1 RE 1.1 Super/E/L 1.2 Super X 1.4			09.78 11.83 05.81 04.83 05.81 09.80 03.82	12.89 12.89 12.89 + Bremsgerät 1) 10.88 + Bremsgerät 1) 12.89 + Bremsgerät 1) 06.82		24.2117-1501.3 24.2119-1705.3	010398 010460			THz 17,46 THz 19,05	
	1.7 D			04.84	12.89		24.3481-1609.7 24.3481-1610.7	220197 220198	<input type="checkbox"/> <input type="checkbox"/>		D=48, + Halter D=48, + Halter	TRW TRW
	1.7 D			04.84	12.89		13.0460-2825.2 13.0460-0060.2	602825 610060			21614 17,7 +WK Belagsatz-Zubehör	TRW TRW
	1.0 1.1 1.1 RE 1.2 Super X 1.4 TRS			11.83 05.81 04.83 09.80 07.84	12.89 12.89 10.88 06.82 12.87		24.0109-0108.1	409108			245 9,0 7,0	
	1.6 GTI 1.7 D			01.85 04.84	12.89 12.89		24.0120-0131.1 24.0110-0187.1	420131 410187			247 20,4 18,5 V 247 10,0 9,0 +S +B	
	0.6 1.0 1.1 1.1 RE 1.2 Super X 1.4			09.78 11.83 09.78 04.83 09.80 03.82	12.89 12.89 12.89 + BVB4-Getriebe 2) 10.88 + BVB4-Getriebe 2) 06.82 + BVB4-Getriebe 2) 12.89 + BVB4-Getriebe 2)		83.6196-0325.3	330727	2		L=325	
	0.6 1.0 1.1 1.1 RE 1.2 Super X 1.4			05.81 11.83 05.81 04.83 05.81 03.82	12.89 12.89 + BVB5-Getriebe 3) 12.89 + BVB5-Getriebe 3) 10.88 + BVB5-Getriebe 3) 06.82 + BVB5-Getriebe 3) 12.89 + BVB5-Getriebe 3)		83.6196-0325.3	330727	<input type="checkbox"/>		L=325	
	0.6 1.1			09.78 09.78	12.89 12.89		24.3222-1102.3	020257			Rz 22,20	BDX
	0.6 1.1			09.78 09.78	12.89 12.89		24.3220-1105.3	020216			Rz 20,64	BDX
	0.6 1.0 1.1 1.2 Super X 1.4			09.78 11.83 09.78 09.80 03.82	12.89 12.89 12.89 06.82 12.89		03.0137-9032.2	669032			Bremsbacken-Zubehör	BDX
	1.6 GTI 1.7 D			01.85 04.84	12.89 12.89		03.0137-9055.2	669055			Bremsbacken-Zubehör	BDX
	0.6 1.0 1.1 1.2 Super X 1.4 1.6 GTI 1.7 D			05.81 11.83 05.81 09.80 03.82 01.85 04.84	12.89 12.89 12.89 06.82 12.89 12.89 12.89		24.6512-1507.3	320023			BRL (3)	
CITROEN XANTIA (X1) Limousine (93-97)												
	1.6 i 1.8 16V 1.8 i 1.8 i 1.9 D 1.9 D 1.9 SD 1.9 TD 2.0 2.0 16V 2.0 16V 2.0 16V 2.0 i	65 81 66 74 50 51 55 66 95 97 110 112 89		03.93 06.95 04.97 03.93 06.94 06.94 02.96 10.94 03.93 06.95 06.94 03.93 03.93	12.97 12.97 12.97 12.97 12.97 12.97 12.97 12.97 05.95 12.97 12.97 12.97 12.97		13.0460-3956.2	603956			21631 17,0 /WK	BDX

1) + booster unit / + servofreno / + servo-frein / + servofreno
2) + BVB4 transmission / + scatola cambio BVV4 / + boîte de vitesse BVV4 / + cambio BVV4
3) + BVV5 transmission / + scatola cambio BVV5 / + boîte de vitesse BVV5 / + cambio BVV5
4) - Citroen brake / - freno Citroen / - freins Citroen / - freno de Citroen
5) + Citroen brake / + freno Citroen / + freins Citroen / + freno de Citroen



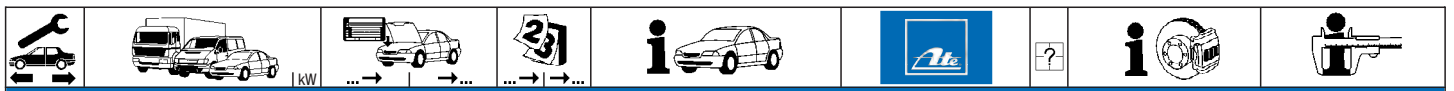

CITROEN XANTIA (X1) Limousine (93-97)

	2.0 Turbo 2.1 TD 3.0 V6	108 80 140		06.95 06.95 01.97	12.97 12.97 12.97	13.0460-3973.2 603973		23146 17,0 /WK	BDX
	1.6 i 1.8 16V 1.8 i 1.8 i 1.9 D 1.9 D 1.9 SD 1.9 TD 2.0 i	65 81 66 74 50 51 55 66 89		03.93 06.95 04.97 03.93 06.94 06.94 02.96 12.97 03.93	12.97 12.97 12.97 12.97 12.97 12.97 12.97 12.97 12.97	24.0120-0133.1 24.0320-0133.1 420133 520133		266 20,5 18,5 V +S +B 266 20,5 18,5 V +S +B PD	
	1.9 TD 2.0 2.0 16V 2.0 16V 2.0 16V 2.0 Turbo 2.1 TD 3.0 V6	66 95 97 110 112 108 80 140	ORGA 07567	10.94 03.93 06.95 06.94 03.93	12.97 05.95 12.97 12.97 12.97	24.0122-0142.1 422142		283 22,0 20,0 V L +B	
	1.6 i 1.8 16V 1.8 i 1.8 i 1.9 D 1.9 D 1.9 SD 1.9 TD 2.0 2.0 16V 2.0 16V 2.0 16V 2.0 i 2.0 Turbo 2.1 TD 3.0 V6	65 81 66 74 50 51 55 66 95 97 110 112 89 108 80 140		03.93 06.95 04.97 03.93 06.94 06.94 02.96 10.94 03.93 06.95 06.94 03.93 03.93 06.95 06.95 01.97	12.97 12.97 12.97 12.97 12.97 12.97 12.97 12.97 05.95 12.97 12.97 12.97 12.97 12.97 12.97 12.97 12.97	24.5111-0355.3 24.5111-0375.3 330757 331128	2 2	L=360 L=375	
	1.6 i 1.8 i 1.9 D 1.9 D 1.9 TD 2.0 16V 2.0 16V 2.0 i 2.0 Turbo 2.1 TD 3.0 V6	65 74 50 51 66 110 112 89	ORGA 06443 ORGA 06443 ORGA 06443 ORGA 06443 ORGA 06443 ORGA 06443 ORGA 06443 ORGA 06443	03.93 03.93 06.94 06.94 10.94 06.94 03.93 03.93	12.97 12.97 12.97 12.97 12.97 12.97 12.97 12.97	24.0731-1133.3 360156	2	Radsensor L=950	
	1.6 i 1.8 16V 1.8 i 1.8 i 1.9 D 1.9 D 1.9 SD 1.9 TD 2.0 2.0 16V 2.0 16V 2.0 16V 2.0 i 2.0 Turbo 2.1 TD 3.0 V6	65 81 66 74 50 51 55 66 95 97 110 112 89 108 80 140	ORGA 06444 ORGA 06444 ORGA 06444 ORGA 06444 ORGA 06444 ORGA 06444 ORGA 06444 ORGA 06444 ORGA 06444 ORGA 06444 ORGA 06444 ORGA 06444 ORGA 06444	03.93 06.95 04.97 12.97 12.97 12.97 02.96 12.97 03.93 06.95 12.97 12.97 12.97 06.95 06.95 01.97	12.97 12.97 12.97 12.97 12.97 12.97 12.97 12.97 05.95 12.97 12.97 12.97 12.97 12.97 12.97 12.97	24.0751-1136.3 360059	2	Radsensor L=950	
	1.6 i 1.8 16V 1.8 i 1.8 i 1.9 D 1.9 D 1.9 SD 1.9 TD 2.0 2.0 16V 2.0 16V 2.0 16V 2.0 i 2.0 Turbo 2.1 TD 3.0 V6	65 81 66 74 50 51 55 66 95 97 110 112 89 108 80 140		03.93 06.95 04.97 03.93 06.94 06.94 02.96 10.94 03.93 06.95 06.94 03.93 03.93 06.95 06.95 01.97	12.97 12.97 12.97 12.97 12.97 12.97 12.97 12.97 05.95 12.97 12.97 12.97 12.97 12.97 12.97 12.97	13.0460-4956.2 13.0460-0437.2 604956 610437		20162 15,4 Belagsatz-Zubehör	CIT CIT
	1.6 i 1.8 16V 1.8 i 1.8 i 1.9 D 1.9 D 1.9 SD 1.9 TD 2.0 2.0 16V 2.0 16V 2.0 16V 2.0 i 2.0 Turbo 2.1 TD 3.0 V6	65 81 66 74 50 51 55 66 95 97 110 112 89 108 80 140		03.93 06.95 04.97 03.93 06.94 06.94 02.96 10.94 03.93 06.95 06.94 03.93 03.93 06.95 06.95 01.97	12.97 12.97 12.97 12.97 12.97 12.97 12.97 12.97 05.95 12.97 12.97 12.97 12.97 12.97 12.97 12.97	24.0109-0122.1 409122		224 9,0 7,0 +B	



CITROEN XANTIA (X1) Limousine (93-97)

	2.0 16V 2.0 16V 2.0 i 2.0 Turbo 2.1 TD 3.0 V6	110 112 89 108 80 140		06.94 12.97 03.93 12.97 06.95 12.97 06.95 12.97 01.97 12.97	12.97 12.97 12.97 12.97 12.97 12.97	24.0109-0122.1	409122		224 9,0 7,0 +B
	1.6 i 1.8 16V 1.8 i 1.8 i 1.9 D 1.9 D 1.9 SD 1.9 TD 2.0 2.0 16V 2.0 16V 2.0 16V 2.0 i 2.0 Turbo 2.1 TD	65 81 66 74 50 51 55 66 95 97 110 112 89 108 80	ORGA 07631 ORGA 07631 ORGA 07631 ORGA 07631 ORGA 07631 ORGA 07631 ORGA 07631 ORGA 07631 ORGA 07631 ORGA 07631 ORGA 07631 ORGA 07631 ORGA 07631 ORGA 07631 ORGA 07631	03.93 06.95 04.97 03.93 06.94 06.94 02.96 10.94 03.93 06.95 06.94 03.93 03.93 06.95 06.95	12.97 12.97 12.97 12.97 12.97 12.97 12.97 12.97 05.95 12.97 12.97 12.97 12.97 12.97 12.97	24.0721-1185.3	360058	2	Radsensor L=765
	1.6 i 1.8 16V 1.8 i 1.8 i 1.9 D 1.9 D 1.9 SD 1.9 TD 2.0 2.0 16V 2.0 16V 2.0 16V 2.0 i 2.0 Turbo 2.1 TD 3.0 V6	65 81 66 74 50 51 55 66 95 97 110 112 89 108 80 140	ORGA 07632 ORGA 07632 ORGA 07632 ORGA 07632 ORGA 07632 ORGA 07632 ORGA 07632 ORGA 07632 ORGA 07632 ORGA 07632 ORGA 07632 ORGA 07632 ORGA 07632 ORGA 07632 ORGA 07632	12.97 12.97 12.97 12.97 12.97 12.97 12.97 12.97 05.95 12.97 12.97 12.97 12.97 12.97 12.97 12.97	12.97 12.97 12.97 12.97 12.97 12.97 12.97 12.97 05.95 12.97 12.97 12.97 12.97 12.97 12.97 12.97	24.0741-1114.3	360067	2	Radsensor L=780
	1.6 i 1.8 16V 1.8 i 1.8 i 1.9 D 1.9 D 1.9 SD 1.9 TD 2.0 2.0 16V 2.0 16V 2.0 16V 2.0 i 2.0 Turbo 2.1 TD 3.0 V6	65 81 66 74 50 51 55 66 95 97 110 112 89 108 80 140		03.93 06.95 04.97 03.93 06.94 06.94 02.96 10.94 03.93 06.95 06.94 03.93 03.93 06.95 06.95 01.97	12.97 12.97 12.97 12.97 12.97 12.97 12.97 12.97 05.95 12.97 12.97 12.97 12.97 12.97 12.97 12.97	24.3727-0312.2 24.3727-0311.2	580312 580311	<input type="checkbox"/> <input type="checkbox"/>	L=1262 L=1333
	2.0 Turbo 2.1 TD 3.0 V6	108 80 140		06.95 06.95 01.97	12.97 12.97 12.97	24.3727-0330.2 24.3727-0311.2	580330 580311	<input type="checkbox"/> <input type="checkbox"/>	L=1313 L=1333 L=1313
	1.6 i 1.8 16V 1.8 i 1.8 i 1.9 D 1.9 D 2.0 i	65 81 66 74 50 51 89		03.93 06.95 04.97 03.93 06.94 06.94 03.93	12.97 12.97 12.97 12.97 04.95 04.95 12.97	24.3728-0310.2	590310		L=778

CITROEN XANTIA (X1) Kombi (95-97)

	1.8 16V 1.8 i 1.8 i 1.8 i	81 66 74 74		06.95 04.97 06.95 12.97	12.97 12.97 12.97 12.97	13.0460-3956.2	603956		21631 17,0 /WK BDX
	1.8 i 1.9 SD 1.9 TD 2.0 16V 2.0 i 2.0 Turbo 2.1 TD	74 55 66 97 89 108 80	ORGA 07482	06.95 04.97 06.95 06.95 06.95 06.95 06.96	12.97 12.97 12.97 12.97 12.97 12.97 12.97	13.0460-3972.2	603972		21632 16,0 /WK BDX
	1.8 16V 1.8 16V 1.8 i 1.8 i	81 81 66 74	ORGA 07483	06.95 12.97 04.97 06.95	12.97 12.97 12.97 12.97	24.0120-0133.1 24.0320-0133.1	420133 520133		266 20,5 18,5 V +S +B 266 20,5 18,5 V +S +B PD
	1.8 16V 1.8 i 1.9 SD 1.9 TD 2.0 16V 2.0 i	81 74 55 66 97 89	ORGA 07482 ORGA 07482	06.95 06.95 04.97 06.95 06.95 06.95	12.97 12.97 12.97 12.97 12.97 12.97	24.0122-0142.1	422142		283 22,0 20,0 V L +B
	2.0 Turbo 2.1 TD	108 80		06.95 06.96	12.97 12.97	24.0126-0106.1 24.0326-0106.1	426106 526106		283 26,0 24,2 V +S +B 283 26,0 24,2 V +S +B PD





CITROEN XANTIA (X1) Kombi (95-97)

	1.8 16V	81		06.95	12.97	24.5111-0355.3	330757	2	L=360 L=375
	1.8 i	66		04.97	12.97	24.5111-0375.3	331128	2	
	1.8 i	74		06.95	12.97				
	1.9 SD	55		04.97	12.97				
	1.9 TD	66		06.95	12.97				
	2.0 16V	97		06.95	12.97				
	2.0 i	89		06.95	12.97				
	2.0 Turbo	108		06.95	12.97				
2.1 TD	80		06.96	12.97					
	1.8 16V	81		06.95	12.97	24.0751-1136.3	360059	2	Radsensor L=950
	1.8 i	66		04.97	12.97				
	1.8 i	74		06.95	12.97				
	1.9 SD	55		04.97	12.97				
	1.9 TD	66		06.95	12.97				
	2.0 16V	97		06.95	12.97				
	2.0 i	89		06.95	12.97				
	2.0 Turbo	108		06.95	12.97				
2.1 TD	80		06.96	12.97					
	1.8 16V	81		06.95	12.97	13.0460-4911.2	604911	20389 15,4 Belagsatz-Zubehör	
	1.8 i	66		04.97	12.97	13.0460-0264.2	610264		
	1.8 i	74		06.95	12.97				
	1.9 SD	55		04.97	12.97				
	1.9 TD	66		06.95	12.97				
	2.0 16V	97		06.95	12.97				
	2.0 i	89		06.95	12.97				
	2.0 Turbo	108		06.95	12.97				
2.1 TD	80		06.96	12.97					
	1.8 16V	81		06.95	12.97	24.0112-0143.1	412143	251 12,0 10,8	
	1.8 i	66		04.97	12.97				
	1.8 i	74		06.95	12.97				
	1.9 SD	55		04.97	12.97				
	1.9 TD	66		06.95	12.97				
	2.0 16V	97		06.95	12.97				
	2.0 i	89		06.95	12.97				
	2.0 Turbo	108		06.95	12.97				
2.1 TD	80		06.96	12.97					
	1.8 16V	81	ORGA 07631	06.95		24.0721-1185.3	360058	2	Radsensor L=765
	1.8 i	66	ORGA 07631	04.97					
	1.8 i	74	ORGA 07631	06.95					
	1.9 SD	55	ORGA 07631	04.97					
	1.9 TD	66	ORGA 07631	06.95					
	2.0 16V	97	ORGA 07631	06.95					
	2.0 i	89	ORGA 07631	06.95					
	2.0 Turbo	108	ORGA 07631	06.95					
2.1 TD	80	ORGA 07631	06.96						
	1.8 16V	81	ORGA 07632		12.97	24.0741-1114.3	360067	2	Radsensor L=780
	1.8 i	66	ORGA 07632		12.97				
	1.8 i	74	ORGA 07632		12.97				
	1.9 SD	55	ORGA 07632		12.97				
	1.9 TD	66	ORGA 07632		12.97				
	2.0 16V	97	ORGA 07632		12.97				
	2.0 i	89	ORGA 07632		12.97				
	2.0 Turbo	108	ORGA 07632		12.97				
2.1 TD	80	ORGA 07632		12.97					
	1.8 16V	81		06.95	12.97	24.3727-0312.2	580312	L=1262 L=1333	
	1.8 i	66		04.97	12.97	24.3727-0311.2	580311		
	1.8 i	74		06.95	12.97				
	1.9 SD	55		04.97	12.97				
	1.9 TD	66		06.95	12.97				
	2.0 16V	97		06.95	12.97				
	2.0 i	89		06.95	12.97				
	2.0 Turbo	108		06.95	12.97	24.3727-0330.2	580330		
2.1 TD	80		06.96	12.97	24.3727-0311.2	580311			
	1.8 16V	81		06.95	12.97	24.3728-0310.2	590310	L=778	
	1.8 i	66		04.97	12.97				
	1.8 i	74		06.95	12.97				
	2.0 i	89		06.95	12.97				

CITROEN XM (Y3) Limousine (89-94)

	2.0	84	ORGA 05228	05.89		13.0460-3916.2	603916	21296 16,5 +/WK Belagsatz-Zubehör
	2.0	94	ORGA 05228	05.89		13.0460-0206.2	610206	
	2.0 i	79	ORGA 05228	05.89				
	2.0 i	89	ORGA 05228	05.89				
	2.0 i	99	ORGA 05228	05.89				
	2.1 D	60	ORGA 05228	05.89				
	2.1 TD	80	ORGA 05228	05.89				
	3.0 24V	147	ORGA 05228	07.90				
3.0 V6	123	ORGA 05228	05.89					
	2.0	84	ORGA 05229		04.94	13.0460-3947.2	603947	21505 17,0 +/WK BDX
	2.0	94	ORGA 05229		06.94			
	2.0 i	79	ORGA 05229		04.94			
	2.0 i	89	ORGA 05229		06.94			
	2.0 i	99	ORGA 05229		06.94			
	2.0 Turbo	104		09.92	06.94			
2.1 D	60	ORGA 05229		06.94				
2.1 TD	80	ORGA 05229		06.94				



CITROEN XM (Y3) Limousine (89-94)

	3.0 24V 3.0 V6	147 123	ORGA 05229 ORGA 05229		06.94 06.94		13.0460-3947.2 603947			21505 17,0 +/WK	BDX
	2.0 2.0 2.0 i 2.0 i 2.0 i 2.1 D 2.1 TD 3.0 24V 3.0 V6	84 94 79 89 99 60 80 147 123	ORGA 05228 ORGA 05228 ORGA 05228 ORGA 05228 ORGA 05228 ORGA 05228 ORGA 05228 ORGA 05228 ORGA 05228	05.89 05.89 05.89 05.89 05.89 05.89 05.89 07.90 05.89			24.0122-0141.1 422141			276 22,0 20,0 V	
	2.0 2.0 2.0 i 2.0 i 2.0 i 2.0 Turbo 2.1 D 2.1 TD 3.0 24V 3.0 V6	84 94 79 89 99 104 60 80 147 123	ORGA 05229 ORGA 05229 ORGA 05229 ORGA 05229 ORGA 05229 ORGA 05229 ORGA 05229 ORGA 05229 ORGA 05229 ORGA 05229		04.94 06.94 04.94 06.94 06.94 09.92 06.94 06.94 06.94 06.94		24.0126-0100.1 426100			283 26,0 24,0 V L	
	2.0 2.0 2.0 i 2.0 i 2.0 i 2.0 Turbo 2.1 D 2.1 TD 3.0 24V 3.0 V6	84 94 79 89 99 104 60 80 147 123		05.89 05.89 05.89 05.89 05.89 09.92 05.89 05.89 07.90 05.89	04.94 06.94 04.94 06.94 06.94 06.94 06.94 06.94 06.94 06.94		24.5411-0550.3 330567	2		L=550	
	2.0 i	79		05.89	04.94		13.0460-4911.2 13.0460-0264.2	604911 610264		20389 15,4 Belagsatz-Zubehör	CIT
	2.0 2.0 2.0 i 2.0 i 2.0 i 2.0 Turbo 2.1 D 2.1 TD 3.0 24V 3.0 V6	84 94 89 99 104 60 80 147 123		05.89 05.89 05.89 05.89 09.92 05.89 05.89 07.90 05.89	04.94 06.94 06.94 06.94 06.94 06.94 06.94 06.94 06.94		13.0460-4956.2 13.0460-0437.2	604956 610437		20162 15,4 Belagsatz-Zubehör	CIT
	2.0 i	79		05.89	04.94		24.0112-0136.2	412136		251 12,0 10,8	
	2.0 2.0 2.0 i 2.0 i 2.0 i 2.0 Turbo 2.1 D 2.1 TD 3.0 24V 3.0 V6	84 94 89 99 104 60 80 147 123		05.89 05.89 05.89 05.89 09.92 05.89 05.89 07.90 05.89	04.94 06.94 06.94 06.94 06.94 06.94 06.94 06.94 06.94		24.0109-0121.2	409121		224 9,0 8,0	
	2.0 2.0 2.0 i 2.0 i 2.0 i 2.0 Turbo 2.1 D 2.1 TD 3.0 V6 3.0 24V	84 94 79 89 99 104 60 80 123 147		05.89 05.89 05.89 05.89 05.89 09.92 05.89 05.89 05.89 07.90	04.94 06.94 04.94 06.94 06.94 06.94 06.94 06.94 06.94 06.94		24.3727-0309.2 24.3727-0308.2	580309 580308	<input type="checkbox"/> <input type="checkbox"/>	L=1030 L=1230	
	3.0 24V	147		07.90	06.94		24.3727-0308.2	580308	<input type="checkbox"/>	L=1230	

CITROEN XM (Y3) Kombi (91-94)

	2.0 2.0 2.0 i 2.0 i 2.1 D 2.1 TD 3.0 V6	85 94 79 89 60 80 123	ORGA 05228 ORGA 05228 ORGA 05228 ORGA 05228 ORGA 05228 ORGA 05228 ORGA 05228	10.91 05.89 11.91 11.91 11.91 11.91 11.91			13.0460-3916.2 13.0460-0206.2	603916 610206		21296 16,5 +/WK Belagsatz-Zubehör	BDX BDX
	2.0 2.0 2.0 i 2.0 i 2.0 Turbo 2.1 D 2.1 TD 3.0 V6	85 94 79 89 104 60 80 123	ORGA 05229 ORGA 05229 ORGA 05229 ORGA 05229 ORGA 05229 ORGA 05229 ORGA 05229 ORGA 05229		07.94 06.94 04.94 04.94 09.92 04.94 04.94 04.94		13.0460-3947.2	603947		21505 17,0 +/WK	BDX
	2.0 2.0 2.0 i 2.0 i 2.1 D	85 94 79 89 60	ORGA 05228 ORGA 05228 ORGA 05228 ORGA 05228 ORGA 05228	10.91 05.89 11.91 11.91 11.91			24.0122-0141.1	422141		276 22,0 20,0 V	



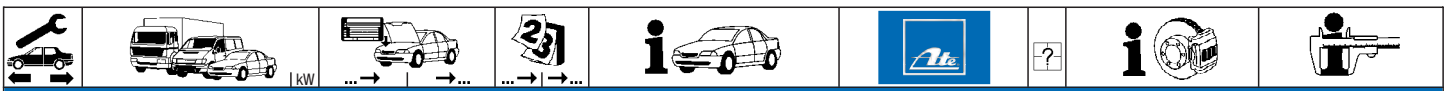















CITROEN XM (Y3) Kombi (91-94)

	2.1 TD 3.0 V6	80 123	ORGA 05228 ORGA 05228	11.91 11.91		24.0122-0141.1 422141		276 22,0 20,0 V
	2.0 2.0 2.0 i 2.0 i 2.0 Turbo 2.1 D 2.1 TD 3.0 V6	85 94 79 89 104 60 80 123	ORGA 05229 ORGA 05229 ORGA 05229 ORGA 05229 ORGA 05229 ORGA 05229 ORGA 05229	07.94 06.94 04.94 04.94 09.92 04.94 04.94 04.94		24.0126-0100.1 426100		283 26,0 24,0 V L
	2.0 2.0 2.0 i 2.0 i 2.0 Turbo 2.1 D 2.1 TD 3.0 V6	85 94 79 89 104 60 80 123		10.91 05.89 11.91 11.91 09.92 11.91 11.91 11.91	07.94 06.94 04.94 04.94 04.94 04.94 04.94 04.94	24.5411-0550.3 330567	2	L=550
	2.0 2.0 2.0 i 2.0 i 2.0 Turbo 2.1 D 2.1 TD 3.0 V6	85 94 79 89 104 60 80 123		10.91 05.89 11.91 11.91 09.92 11.91 11.91 11.91	07.94 06.94 04.94 04.94 04.94 04.94 04.94 04.94	13.0460-4911.2 604911 13.0460-0264.2 610264		20389 15,4 Belagsatz-Zubehör CIT
	2.0 2.0 2.0 i 2.0 i 2.0 Turbo 2.1 D 2.1 TD 3.0 V6	85 94 79 89 104 60 80 123		10.91 05.89 11.91 11.91 09.92 11.91 11.91 11.91	07.94 06.94 04.94 04.94 04.94 04.94 04.94 04.94	24.0112-0136.2 412136		251 12,0 10,8
	2.0 2.0 2.0 i 2.0 i 2.0 Turbo 2.1 D 2.1 TD 3.0 V6	85 94 79 89 104 60 80 123		10.91 05.89 11.91 11.91 09.92 11.91 11.91 11.91	07.94 06.94 04.94 04.94 04.94 04.94 04.94 04.94	24.3727-0309.2 580309 24.3727-0308.2 580308	<input type="checkbox"/> <input type="checkbox"/>	L=1030 L=1230
	3.0 V6	▶123		11.91	04.94	24.3727-0308.2 580308	<input type="checkbox"/>	L=1230

CITROEN ZX (N2) Limousine (91-97)

	1.1 1.1 1.4 1.4 i 1.6 i 1.8 D 1.8 i 1.9 1.9 D 1.9 D 1.9 i 1.9 TD 2.0 i	40 44 55 55 65 44 74 96 47 50 88 66 89		03.91 03.91 03.91 03.91 03.91 06.93 07.92 03.91 03.91 06.94 03.91 07.92 07.92	- ABS - ABS - ABS - ABS - ABS - ABS - ABS - ABS - ABS - ABS - ABS - ABS - ABS	03.7740-4002.4 300108		8" ATE
	1.1 1.1 1.4 1.4 i 1.6 i 1.8 16V 1.8 D 1.8 i 1.9 1.9 D 1.9 D 1.9 i 1.9 TD 2.0 i	40 44 55 55 65 81 44 74 96 47 50 88 66 89	ORGA 07125 ORGA 07125 ORGA 07125 ORGA 07125 ORGA 07125 ORGA 07125 ORGA 07125 ORGA 07125 ORGA 07125 ORGA 07125 ORGA 07125 ORGA 07125 ORGA 07125 ORGA 07125	03.91 03.91 03.91 03.91 03.91 01.96 06.93 07.92 03.91 03.91 06.94 03.91 07.92 07.92	- ABS - ABS - ABS - ABS - ABS - ABS - ABS - ABS - ABS - ABS - ABS - ABS - ABS - ABS	03.2120-2031.3 010106 24.2120-1722.3 010544		THz 20,64 THz 20,64 ATE BDX
	1.1 1.1 1.4 1.4 i 1.6 i 1.8 16V 1.8 D 1.8 i 1.9 1.9 D 1.9 D 1.9 i 1.9 TD 2.0 i	40 44 55 55 65 81 44 74 96 47 50 88 66 89	ORGA 07126 ORGA 07126 ORGA 07126 ORGA 07126 ORGA 07126 ORGA 07126 ORGA 07126 ORGA 07126 ORGA 07126 ORGA 07126 ORGA 07126 ORGA 07126 ORGA 07126 ORGA 07126	08.93 06.97 06.97 06.97 06.97 06.97 06.97 06.97 06.97 06.97 06.97 06.97 06.97 06.97	- ABS - ABS - ABS - ABS - ABS - ABS - ABS - ABS - ABS - ABS - ABS - ABS - ABS - ABS	03.2120-4221.3 010605		THz 20,64 ATE
	1.1	40	ORGA 07069	03.91	+ ABS	24.2122-1704.3 010423		THz 22,20



















									
CITROEN ZX (N2) Limousine (91-97)									
	1.1 1.4 1.4 i 1.6 i 1.8 16V 1.8 D 1.8 i 1.9 1.9 D 1.9 D 1.9 i 1.9 TD 2.0 i	44 55 55 65 81 44 74 96 47 50 88 66 89	ORGA 07069 ORGA 07069 ORGA 07069 ORGA 07069 ORGA 07069 ORGA 07069 ORGA 07069 ORGA 07069 ORGA 07069 ORGA 07069 ORGA 07069 ORGA 07069 ORGA 07069	03.91 03.91 03.91 03.91 01.96 06.93 07.92 03.91 03.91 06.94 03.91 07.92 07.92	+ ABS + ABS + ABS + ABS + ABS + ABS + ABS + ABS + ABS + ABS + ABS + ABS + ABS	24.2122-1704.3 010423		Thz 22,20	
	1.1 1.1 1.4 1.4 i 1.6 i 1.8 16V 1.8 D 1.8 i 1.9 1.9 D 1.9 D 1.9 i 1.9 TD 2.0 i	40 ORGA 07070 44 ORGA 07070 55 ORGA 07070 55 ORGA 07070 65 ORGA 07070 81 ORGA 07070 44 ORGA 07070 74 ORGA 07070 96 ORGA 07070 47 ORGA 07070 50 ORGA 07070 88 ORGA 07070 66 ORGA 07070 89 ORGA 07070		08.93 06.97 06.97 06.97 06.97 06.97 06.97 06.97 06.97 06.97 06.97 06.97 06.97 06.97	+ ABS + ABS + ABS + ABS + ABS + ABS + ABS + ABS + ABS + ABS + ABS + ABS + ABS + ABS	03.2122-1331.3 010607		Thz 22,20 ATE	
	1.6 i 1.8 16V 1.8 i 1.9 1.9 i 1.9 TD 2.0 i	65 81 74 96 88 66 89		03.91 01.96 07.92 03.91 03.91 07.92 07.92	06.97 + ABS 06.97 06.97 06.97 06.97 06.97 06.97	24.3481-1615.5 24.3481-1616.5 24.0101-4806.2	240031 240032 260052	D=48, - Halter D=48, - Halter Bremsattel-Zubehör	TRW TRW TRW
	1.8 D 1.9 D	44 47	ORGA 06049 ORGA 06049	06.93 03.91		24.3481-1609.7 24.3481-1610.7	220197 220198	D=48, + Halter D=48, + Halter	TRW TRW
	1.1 1.1 1.4 1.4 i 1.6 i 1.9 TD	40 44 55 55 65 66		03.91 03.91 03.91 03.91 03.91 07.92	08.93 06.97 06.97 06.97 06.97 06.97	13.0460-3952.2 13.0460-0403.2	603952 610403	20905 18,0 +/WK Belagsatz-Zubehör	BDX BDX
	1.6 i 1.8 16V 1.8 i 1.9 1.9 i 1.9 TD 2.0 i	65 81 74 96 88 66 89		03.91 01.96 07.92 03.91 03.91 07.92 07.92	06.97 06.97 06.97 06.97 06.97 06.97 06.97	13.0460-2981.2	602981	21460 18,0 +/WK/S	TRW
	1.8 D 1.9 D 1.9 D	44 47 50		06.93 03.91 06.94	06.97 06.97 06.97	13.0460-3952.2	603952	20905 18,0 +/WK	BDX
	1.8 D 1.9 D	44 47	ORGA 06049 ORGA 06049	06.93 03.91		13.0460-2825.2 13.0460-0060.2	602825 610060	21614 17,7 +/WK Belagsatz-Zubehör	TRW TRW
	2.0 2.0 16V	122 120		09.96 05.96	10.97 06.97	13.0460-2817.2	602817	21674 19,0 +/WK/S	TRW
	1.1 1.1 1.4 1.4 i 1.9 TD	40 44 55 55 66		03.91 03.91 03.91 03.91 07.92	08.93 06.97 06.97 06.97 06.97	24.0110-0187.1	410187	247 10,0 9,0 +S +B	
	1.6 i 1.8 16V 1.8 i 1.9 1.9 i 1.9 TD 2.0 i	65 81 74 96 88 66 89		03.91 01.96 07.92 03.91 03.91 07.92 07.92	06.97 06.97 06.97 06.97 06.97 06.97 06.97	24.0120-0132.1 24.0320-0132.1	420132 520132	247 20,4 18,5 V +S +B 247 20,4 18,5 V +S +B PD	
	1.8 D 1.9 D 1.9 D	44 47 50		06.93 03.91 06.94	06.97 06.97 06.97	24.0110-0187.1	410187	247 10,0 9,0 +S +B	
	2.0 2.0 16V 2.0 16V 2.0 16V	122 110 112 114		09.96 06.94 07.92 07.92	10.97 10.97 10.94 10.97	24.0120-0133.1 24.0320-0133.1	420133 520133	266 20,5 18,5 V +S +B 266 20,5 18,5 V +S +B PD	
	2.0 2.0 16V	122 120		09.96 05.96	10.97 06.97	24.0122-0142.1	422142	283 22,0 20,0 V L +B	
	1.1 1.1 1.4 1.4 i 1.6 i 1.8 16V 1.8 D 1.8 i	40 44 55 55 65 81 44 74		03.91 03.91 03.91 03.91 03.91 01.96 06.93 07.92	08.93 06.97 06.97 06.97 06.97 06.97 06.97 06.97	24.5111-0425.3	330278	L=425	



CITROEN ZX (N2) Limousine (91-97)

	1.9	96	ORGA 06748	03.91	06.97	- ABS	24.5111-0425.3	330278	2		L=425	
	1.9	96	ORGA 06749		06.97							
	1.9 D	47		03.91	06.97							
	1.9 D	50		06.94	06.97							
	1.9 i	88	ORGA 06748	03.91	06.97							
	1.9 i	88	ORGA 06749		06.97	- ABS						
	1.9 TD	66	ORGA 06748	07.92	06.97	- ABS						
	1.9 TD	66	ORGA 06749		06.97	- ABS						
	2.0 i	89	ORGA 06748	07.92	06.97	- ABS						
	2.0 i	89	ORGA 06749		06.97	- ABS						
	1.8 16V	81		01.96	06.97	+ ABS	24.5111-0438.3	330568	2		L=445	
	1.9	96	ORGA 06749		06.97	+ ABS						
	1.9 i	88	ORGA 06749		06.97	+ ABS						
	1.9 TD	66	ORGA 06749		06.97	+ ABS						
	2.0 16V	110		06.94	06.97							
	2.0 16V	112		07.92	10.94							
	2.0 16V	114		07.92	10.97							
	2.0 i	89	ORGA 06749		06.97	+ ABS						
	2.0	122		09.96	10.97		24.5111-0460.3	330603	2		L=460	
	2.0 16V	120		05.96	06.97							
	1.6 i	65		03.91	06.97		13.0460-3823.2	603823			20974 11,0 Belagsatz-Zubehör	
	1.8 16V	81		01.96	06.97		13.0460-0435.2	610435			BOS BDX	
	1.8 D	44		06.93	06.97							
	1.8 i	74		07.92	06.97							
	1.9	96		03.91	06.97							
	1.9 D	47		03.91	06.97							
	1.9 D	50		06.94	06.97							
	1.9 i	88		03.91	06.97							
	1.9 TD	66		07.92	06.97							
	2.0 i	89		07.92	06.97							
	2.0	122		09.96	10.97		13.0460-3954.2	603954			20973 11,0 + Belagsatz-Zubehör	
	2.0 16V	110		06.94	06.97		13.0460-0435.2	610435			BOS BDX	
	2.0 16V	112		07.92	10.94							
	2.0 16V	114		07.92	10.97							
	2.0 16V	120		05.96	06.97							
		1.6 i	65		03.91	06.97		24.0108-0106.1	408106			247 8,0 6,0 +S +B
		1.8 16V	81		01.96	06.97						
		1.8 D	44		06.93	06.97						
		1.8 i	74		07.92	06.97						
		1.9	96		03.91	06.97						
1.9 D		47		03.91	06.97							
1.9 D		50		06.94	06.97							
1.9 i		88		03.91	06.97							
1.9 TD		66		07.92	06.97							
2.0		122		09.96	10.97							
	2.0 16V	110		06.94	06.97							
	2.0 16V	112		07.92	10.94							
	2.0 16V	114		07.92	10.97							
	2.0 16V	120		05.96	06.97							
	2.0 i	89		07.92	06.97							
		1.1	40		03.91	08.93		24.5228-0195.3	330469	2		L=202
		1.1	44	ORGA 09748	03.91							
		1.4	55	ORGA 06748	03.91							
		1.4 i	55	ORGA 06748	03.91							
		1.6 i	65	ORGA 06748	03.91							
1.8 D		44	ORGA 06748	06.93								
1.8 i		74	ORGA 06748	07.92								
1.9 D		47	ORGA 06748	03.91								
1.9 D		50	ORGA 06748	06.94								
		1.9	96	ORGA 06748	03.91	06.97	+ ABS	24.5112-0155.3	330507	2	Länge beachten ¹⁾	L=155
	1.9	96		03.91	06.97	- ABS	24.5228-0195.3	330469	2	Länge beachten ¹⁾	L=202	
	1.9 i	88	ORGA 06748	03.91	06.97	+ ABS						
	1.9 i	88		03.91	06.97	- ABS						
	1.9 TD	66	ORGA 09748	07.92	06.97	+ ABS						
	1.9 TD	66		07.92	06.97	- ABS						
	2.0 16V	110	ORGA 06748	03.91	06.97	+ ABS						
	2.0 16V	110		06.94	06.97	- ABS						
	2.0 16V	112		07.92	10.94							
	2.0 16V	114		07.92	10.97							
	2.0 i	89	ORGA 06748	07.92	06.97	+ ABS						
	2.0 i	89		07.92	06.97	- ABS						
	1.1	44	ORGA 06749		06.97		24.5228-0245.3	330531	<input type="checkbox"/>		L=245	
	1.4	55	ORGA 06749		06.97		24.5228-0195.3	330469	<input type="checkbox"/>		L=202	
	1.4 i	55	ORGA 06749		06.97							
	1.6 i	65	ORGA 06749		06.97							
	1.8 16V	81		01.96	06.97							
	1.8 D	44	ORGA 06749		06.97							
	1.8 i	74	ORGA 06749		06.97							
	1.9	96	ORGA 06749		06.97	+ ABS						
	1.9 D	47	ORGA 06749		06.97							
	1.9 D	50	ORGA 06749		06.97							
	1.9 i	88	ORGA 06749		06.97	+ ABS						
	1.9 TD	66	ORGA 06749		06.97	+ ABS						
	2.0	122		09.96	10.97							
	2.0 16V	110	ORGA 06749		06.97	+ ABS						
	2.0 16V	120		05.96	06.97							

¹⁾ notice length / attenzione lunghezza / faire attention longueur / atención largo

CITROEN ZX (N2) Limousine (91-97)										
										
	2.0 i	89 ORGA 06749			06.97 + ABS	24.5228-0245.3 330531 24.5228-0195.3 330469			L=245 L=202	
	1.1 1.1 i 1.4 1.4 i 1.6 i 1.9 D 1.9 D	40 44 55 55 65 47 50	ORGA 05718 ORGA 05718 ORGA 05718 ORGA 05718 ORGA 05718 ORGA 05718 ORGA 05718	03.91 03.91 03.91 03.91 03.91 03.91 06.94	- ABS - ABS - ABS - ABS - ABS - ABS - ABS	24.3220-1603.3 020230 24.3220-1604.3 020231 24.3220-1607.3 020234 24.3220-1608.3 020235			RzR 20,64 RzR 20,64 RzR 20,64 RzR 20,64	BDX BDX TRW TRW
	1.1 1.1 1.4 1.4 i 1.6 i 1.9 D 1.9 D 1.9 TD	40 ORGA 05719 44 ORGA 05719 55 ORGA 05719 55 ORGA 05719 65 ORGA 05719 47 ORGA 05719 50 ORGA 05719 66			08.93 - ABS 06.97 - ABS 06.97 - ABS 06.97 - ABS 06.97 - ABS 06.97 - ABS 06.97 - ABS 07.92 06.97 - ABS	24.3220-1617.3 020244 24.3220-1618.3 020245 24.3220-1615.3 020242 24.3220-1616.3 020243			RzR 20,64 RzR 20,64 RzR 20,64 RzR 20,64	BDX BDX TRW TRW
	1.1 1.4 1.4 i 1.6 i 1.8 16V 1.8 D 1.8 i 1.9 D 1.9 D 1.9 TD	44 ORGA 06749 55 ORGA 06749 55 ORGA 06749 65 ORGA 06749 81 44 ORGA 06749 74 ORGA 06749 47 ORGA 06749 50 ORGA 06749 66 ORGA 06749		01.96	06.97 + ABS 06.97 + ABS 06.97 + ABS 06.97 + ABS 06.97 06.97 + ABS 06.97 + ABS 06.97 + ABS 06.97 + ABS 06.97 + ABS	24.3220-1711.3 020409		+ GG ¹⁾	Rz 20,64	TRW
	1.1 1.1 1.4 1.4 i 1.6 i 1.8 D 1.8 i 1.9 D 1.9 D 1.9 TD	40 44 55 55 65 44 74 47 50 66		03.91 03.91 03.91 03.91 03.91 06.93 07.92 03.91 06.94 07.92	08.93 - ABS 06.97 - ABS 06.97 - ABS 06.97 - ABS 06.97 - ABS 06.97 - ABS 06.97 - ABS 06.97 - ABS 06.97 - ABS 06.97 - ABS	03.0137-0261.2 650261 03.0137-0197.2 650197 03.0137-9086.2 669086 03.0137-9175.2 669175			180 x 32 180 x 32 HEB Bremsbacken-Zubehör Bremsbacken-Zubehör	BDX TRW BDX TRW
	1.1 1.4 1.4 i 1.6 i 1.8 16V 1.8 D 1.8 i 1.9 D 1.9 D 1.9 TD	44 ORGA 06749 55 ORGA 06749 55 ORGA 06749 65 ORGA 06749 81 44 ORGA 06749 74 ORGA 06749 47 ORGA 06749 50 ORGA 06749 66 ORGA 06749		01.96	06.97 + ABS 06.97 + ABS 06.97 + ABS 06.97 + ABS 06.97 06.97 + ABS 06.97 + ABS 06.97 + ABS 06.97 + ABS 06.97 + ABS	03.0137-0312.2 650312 03.0137-9158.2 669158			203 x 38 HEB Bremsbacken-Zubehör	TRW TRW
	1.1 1.1 1.4 1.4 i 1.6 i 1.8 D 1.8 i 1.9 D 1.9 D 1.9 TD	40 44 55 55 65 44 74 47 50 66		03.91 03.91 03.91 03.91 03.91 06.93 07.92 03.91 06.94 07.92	08.93 - ABS 06.97 - ABS 06.97 - ABS 06.97 - ABS 06.97 - ABS 06.97 - ABS 06.97 - ABS 06.97 - ABS 06.97 - ABS 06.97 - ABS	24.0218-0016.1 480011 24.0218-0716.2 480203			180/181 x 44,5 - Lager 180/181 x 44,5 + Lager	
	1.1 1.4 1.4 i 1.6 i 1.8 16V 1.8 D 1.8 i 1.9 D 1.9 D 1.9 TD	44 ORGA 06749 55 ORGA 06749 55 ORGA 06749 65 ORGA 06749 81 44 ORGA 06749 74 ORGA 06749 47 ORGA 06749 50 ORGA 06749 66 ORGA 06749		01.96	06.97 + ABS 06.97 + ABS 06.97 + ABS 06.97 + ABS 06.97 06.97 + ABS 06.97 + ABS 06.97 + ABS 06.97 + ABS 06.97 + ABS	24.0220-3014.1 480090			203/204,4 x 46,5	
	1.1 1.1 1.4 1.4 i 1.6 i 1.9 D 1.9 D	40 44 55 55 65 47 50	ORGA 05718 ORGA 05718 ORGA 05718 ORGA 05718 ORGA 05718 ORGA 05718 ORGA 05718	03.91 03.91 03.91 03.91 03.91 03.91 06.94	- ABS - ABS - ABS - ABS - ABS - ABS - ABS	03.0420-1620.3 681620 03.0520-1820.3 691820			20,64/180x32 Kit 20,64/180x32 TopKit	BDX TRW
	1.1 1.1 1.4 1.4 i 1.6 i 1.9 D 1.9 D 1.9 TD	40 ORGA 05719 44 ORGA 05719 55 ORGA 05719 55 ORGA 05719 65 ORGA 05719 47 ORGA 05719 50 ORGA 05719 66			08.93 - ABS 06.97 - ABS 06.97 - ABS 06.97 - ABS 06.97 - ABS 06.97 - ABS 06.97 - ABS 07.92 06.97 - ABS	03.0520-2620.3 692620 03.0520-2520.3 692520			20,64/180x32 TopKit 20,64/180x32 TopKit	BDX TRW
	1.1 1.4 1.4 i	44 ORGA 06749 55 ORGA 06749 55 ORGA 06749			06.97 + ABS 06.97 + ABS 06.97 + ABS	03.0520-5720.3 695720		+ GG ¹⁾	20,64/203x39 TopKit	TRW

¹⁾ + cast iron / + ghisa / + fonte grise / + fundición de gris



CITROEN ZX (N2) Limousine (91-97)

	1.6 i 1.8 16V 1.8 D 1.8 i 1.9 D 1.9 D 1.9 TD	65 ORGA 06749 81 44 ORGA 06749 74 ORGA 06749 47 ORGA 06749 50 ORGA 06749 66 ORGA 06749		01.96	06.97 + ABS 06.97 06.97 + ABS 06.97 + ABS 06.97 + ABS 06.97 + ABS 06.97 + ABS	03.0520-5720.3	695720	+ GG ¹⁾	20,64/203x39 TopKit TRW
	1.1 1.1 1.4 1.4 i 1.6 i 1.8 16V 1.8 D 1.8 i 1.9 1.9 D 1.9 D 1.9 i 1.9 TD 2.0 2.0 16V 2.0 16V 2.0 16V 2.0 16V 2.0 i	40 44 55 55 65 81 44 74 96 47 50 88 66 122 110 112 114 120 89	ORGA 07330 ORGA 07330 ORGA 07330 ORGA 07330 ORGA 07330 ORGA 07330 ORGA 07330 ORGA 07330 ORGA 07330 ORGA 07330 ORGA 07330 ORGA 07330 ORGA 07330 ORGA 07330 ORGA 07330 ORGA 07330 ORGA 07330 ORGA 07330 ORGA 07330	03.91 03.91 03.91 03.91 03.91 01.96 06.93 07.92 03.91 03.91 06.94 03.91 07.92 09.96 06.94 07.92 07.92 05.96 03.91	08.93	24.3727-0307.2 24.3727-0306.2 24.3727-0304.2 24.3727-0305.2	580307 580306 580304 580305	<input type="checkbox"/> + HA-Trommelbremse ²⁾ <input type="checkbox"/> + HA-Trommelbremse ²⁾ <input type="checkbox"/> + HA-Scheibenbremse ³⁾ <input type="checkbox"/> + HA-Scheibenbremse ³⁾	L=1585 L=1493 L=1612 L=1533
	1.1 1.4 1.4 i 1.6 i 1.8 16V 1.8 D 1.8 i 1.9 1.9 D 1.9 D 1.9 i 1.9 TD 2.0 2.0 16V 2.0 16V 2.0 16V 2.0 i	44 ORGA 07331 55 ORGA 07331 55 ORGA 07331 65 ORGA 07331 81 ORGA 07331 44 ORGA 07331 74 ORGA 07331 96 ORGA 07331 47 ORGA 07331 50 ORGA 07331 88 ORGA 07331 66 ORGA 07331 122 ORGA 07331 110 ORGA 07331 114 ORGA 07331 120 ORGA 07331 89 ORGA 07331			06.97 06.97 06.97 06.97 06.97 06.97 06.97 06.97 06.97 06.97 06.97 06.97 09.96 06.97 10.97 06.97 06.97	24.3727-0316.2 24.3727-0317.2	580316 580317	<input type="checkbox"/> + HA-Trommelbremse ²⁾ <input type="checkbox"/> + HA-Trommelbremse ²⁾	L=1582 L=1488
	1.1 1.1 1.4 1.4 i	40 44 55 55	ORGA 06567 ORGA 06567 ORGA 06567	03.91 03.91 03.91	08.93	24.3728-0305.2	590305		L=606

DAEWOO ARANOS (95-97)

	1.5 1.8 2.0	66 70 77		01.95 01.95 01.95	11.97 11.97 11.97	13.0460-7052.2	607052		21190 17,5 +/WE ATE
	1.5 1.8 2.0	66 70 77		01.95 01.95 01.95	11.97 11.97 11.97	24.0124-0115.1	424115		256 24,0 21,0 V L +S +B
	1.5 1.8 2.0	66 70 77		01.95 01.95 01.95	11.97 11.97 11.97	24.3219-1767.3	020552		Rz 19,05
	1.5 1.8 2.0	66 70 77		01.95 01.95 01.95	11.97 11.97 11.97	03.0137-0267.2 03.0137-9167.2	650267 669167		200 x 46 HEB Bremsbacken-Zubehör
	1.5 1.8 2.0	66 70 77		01.95 01.95 01.95	11.97 11.97 11.97	24.0220-0036.1	480149		200/201 x 52,5





























DAF 44 (66-74)

	0.8			09.72	09.74	03.3508-8302.3	310046		Behälter ATE
	0.8			11.66	09.74	83.6104-0220.3	330474		L=220
	0.8			11.66	09.74	03.3217-0401.3	020023		Rz 17,46

DAF 55 (67-72)



























	1.1			10.67	09.72	03.3508-8302.3	310046		Behälter ATE
	1.1			10.67	09.72	13.0460-3010.2	603010		20009 15,0 ATE

¹⁾ + cast iron / + ghisa / + fonte grise / + fundición de gris
²⁾ + RA drum brake / + P freno a tamburo / + frein à tambour essieu AR / + ET-tambores de freno
³⁾ + RA disc brake / + P disco freno / + frein à disque essieu AR / + ET-disco de freno



































        												
DAF 55 (67-72)												
	1.1				10.67	09.72			83.6104-0220.3	330474	2	L=220
	1.1				10.67	09.72			83.6104-0220.3	330474	2	L=220
	1.1				10.67	09.72			03.3217-0401.3	020023		Rz 17,46
DAF 66 (72-75)												
	1.1 1.3				09.72 09.73	06.75 06.75			13.0460-3010.2	603010		20009 15,0 ATE
	1.1 1.3				09.72 09.73	06.75 06.75			83.6104-0220.3	330474	2	L=220
	1.1 1.3				09.72 09.73	06.75 06.75			03.0137-9173.2	669173		Bremsbacken-Zubehör
DAF 428-435 (89-93)												
	428 431 435				01.89 01.89 01.89	08.93 08.93 08.93			03.0137-0309.2	650309		254 x 70
DAIHATSU APPLAUSE I (89-97)												
	1.6 16V (A101) 1.6 16V 4WD (A111)				06.89 06.89	07.97 07.97			24.0118-0126.1	418126		235 18,0 17,0 V
	1.6 16V (A101)				06.89	07.97 + ABS			13.0460-5972.2	605972		21559 11,5
	1.6 16V (A101) 1.6 16V 4WD (A111)				06.89 06.89	07.97 - ABS 07.97			03.0137-0315.2 03.0137-9271.2	650315 669271		200 x 32 Bremsbacken-Zubehör
DAIHATSU CHARADE (87-92)												
	1.0 (G100) 1.0 (G100) 1.0 (G100) 1.0 D (G101) 1.0 TD (G101) 1.0 Turbo (G100) 1.3 (G102)	38 40 41 27 35 50 66			02.87 11.90 04.89 02.87 02.87 02.87 06.88	12.92 12.92 12.92 12.92 12.92 10.90 12.92			24.0111-0139.1	411139		234 11,0 10,0
	1.0 GTi (G100) 1.3 (G102)	74 66			02.87 06.88	12.92 12.92 + 4 türig ¹⁾			24.0118-0126.1	418126		235 18,0 17,0 V
	1.0 (G100) 1.0 (G100) 1.0 (G100) 1.0 D (G101) 1.0 TD (G101) 1.0 Turbo (G100) 1.3 (G102)	38 40 41 27 35 50 66			02.87 11.90 04.89 02.87 02.87 02.87 06.88	12.92 12.92 12.92 12.92 12.92 10.90 12.92			03.0137-0186.2 03.0137-9126.2	650186 669126		180 x 28 Bremsbacken-Zubehör
	1.0 (G100) 1.3 (G102)	74 66			02.87 06.88	12.92 12.92 + 4 türig ¹⁾			03.0137-0315.2 03.0137-9271.2	650315 669271		200 x 32 Bremsbacken-Zubehör
DAIHATSU CUORE (85-90)												
	0.85 (L80) 0.85 4WD (L81)	32			09.85 09.86	12.90 10.88			24.0110-0235.1	410235		211 10,0 9,0
DAIHATSU CUORE (90-94)												
	0.7 4WD (L201) 0.8 (L201)	47 30			08.90 10.90	12.94 12.94			24.0116-0127.1	416127		211 16,0 14,0 V
DAIHATSU FERZA (88-95)												
	1.6 16V (F300)				10.88	12.95 + belüftete Scheiben ²⁾			13.0460-5816.2	605816		21243 14,0
	1.6 16V (F300)				10.88	12.95			24.0118-0121.1	418121		277 18,0 17,0 V
	1.6 16V (F300)				10.88	12.95			03.0137-0316.2	650316		254 x 45
DAIMLER XJ (40,81) (89-94)												
	Double Six 6.0 Sovereign 4.0				02.93 09.89	09.94 09.94			13.0460-7138.2 24.8190-1302.2	607138 621302	2	23126 17,5 +WE Warnkontakt L=276mm ATE

¹⁾ + 4 door / + 4 porte / + 4 portes / + 4 puertas

²⁾ + ventilated discs / + dischi ventilati / + disques ventilés / + disco ventilado

								
DAIMLER XJ (40,81) (89-94)								
	Double Six 6.0 Sovereign 4.0		02.93 09.89	09.94 09.94	24.0123-0108.1 24.0128-0138.1	423108 428138		295 22,5 21,0 V 291 28,1 26,0 V +B
DE TOMASO PANTERA								
	Pantera		01.71	12.93	13.0460-4964.2	604964		21381 15,0 BRE
DKW F102 (64-66)								
	1.2	44	03.64	08.66	24.3215-1105.3	020159		Rz 15,87
DKW Meisterklasse/Sonderklasse/Universal (50-57)								
	0.7 Meisterklasse 0.7 Universal		01.50 01.50	12.52 12.52	03.3125-0401.3	010290	alte Kolbenstange verwenden ¹⁾	Hz 25,40 ATE
	0.7 Meisterklasse 0.7 Universal 0.9 Sonderklasse 0.9 Universal		01.53 01.50 01.53 01.53	12.54 12.53 12.55 12.55	24.3526-0100.3	340017	1	Bremslichtschalter
DKW Schnell-Laster/Bus								
	0.7 Bus 0.7 Schnell-Laster 0.8 DKW 30 (F 800) 0.9 3=6		01.54 01.55	12.53 12.53 12.55 12.56	24.3526-0100.3	340017	1	Bremslichtschalter
DKW 3=6 (55-57)								
	0.9 Post 3=6		01.55	12.56	03.3125-0401.3	010290	alte Kolbenstange verwenden ¹⁾	Hz 25,40 ATE
FAUN Kraftkarren (Kraka)								
	Kraka				03.3122-0101.3 24.3526-0110.3	010277 340018	1 (03.3122-1315.3)	Hz 22,20 Bremslichtschalter ATE
FERRARI FERRARI								
	308 GTB/GTS 328 GTB/GTS Mondial		04.81 09.85 04.81	08.85 08.89	11.0441-5702.2 11.0101-5407.2 11.8171-0008.1 11.8116-0091.1	250033 260011 990049 390502	2	Dichtungssatz Hülzensatz Führungsbolzen Haltefeder ATE
	Testarossa		01.84	12.91	13.0441-4009.2	250077		Dichtungssatz ATE
	Dino 308 GT 2+2 Mondial		09.73 01.80	12.80 03.81	83.6215-0400.3 24.5224-0330.3	330323 331263	2	L=400 L=330
	308 GTB/GTS Mondial		04.81 04.81	08.85	83.7758-0381.3	331485	2	L=380
	400i 412i Testarossa		01.85 01.85 01.84		24.5224-0330.3	331263	4	L=330
	308 GTB/GTS 328 GTB/GTS Mondial Testarossa		04.81 09.85 04.81 01.84	08.85 08.89	11.0441-4805.2 11.0101-5407.2 11.8171-0008.1 13.0441-3406.2	250020 260011 990049 250048		Dichtungssatz Hülzensatz Führungsbolzen Dichtungssatz ATE
	Mondial 308 GTB/GTS		01.80 04.81	08.85	83.6101-0325.3 83.6101-0240.3	330206 330202	2	L=325 L=240
FIAT 124 (66-74)								
	alle Typen		01.66	08.74	24.2119-0831.3	010416		Thz 19,05
	alle Typen		01.66	08.74	13.0460-3936.2	603936		20073 17,3 BDX
	alle Typen		01.66	08.74	24.0111-0130.1	411130		227 10,8 9,0 +B
	alle Typen		01.66	08.74	24.0111-0130.1	411130		227 10,8 9,0 +B
	alle Typen		01.66	08.74	24.5105-0139.3	331216	2	L=139
FIAT 125 (66-74)								
	1.6 1.6 Special		07.67 05.69	03.74 10.73	24.2119-0806.3	010345		Thz 19,05
	1.6 1.6 Special		07.67 05.69	03.74 10.73	13.0460-3936.2	603936		20073 17,3 BDX

¹⁾ reuse old piston rod / riutilizz. vecchio puntalino / utiliser l'ancien. tige d.pist. / utilice el vástago viejo

								
FIAT 125 (66-74)								
	1.6 1.6 Special			07.67 05.69	03.74 10.73	24.0111-0130.1	411130	227 10,8 9,0 +B
	1.6 1.6 Special			07.67 05.69	03.74 10.73	24.0111-0130.1	411130	227 10,8 9,0 +B
	1.6 1.6 Special			07.67 05.69	03.74 10.73	24.5105-0139.3	331216 2	L=139
FIAT 126 (72-90)								
	600 650 700	6129390			06.77 07.77 09.87	24.2119-0815.3	010347	THz 19,05
	600 600 650 700			09.72 04.76 07.77 09.87	03.76 06.77 08.87 07.90	24.3223-0801.3	020316	Rz 23,81
	600 600 650 700			09.72 04.76 07.77 09.87	03.76 06.77 08.87 07.90	24.3223-0802.3	020286	Rz 23,81 FI
	600 600 650 700			09.72 04.76 07.77 09.87	03.76 06.77 08.87 07.90	03.0137-9178.2	669178	Bremsbacken-Zubehör AP
	600 600 650 700			04.76 07.77 09.87	06.77 08.87 07.90	03.0137-0015.2	650015	185 x 31 AUT FI
	600 600 650 700			07.77 09.87	08.87 07.90	03.0137-9021.2	669021	Bremsbacken-Zubehör FI
	600 600 650 700			09.72 04.76 07.77 09.87	03.76 06.77 08.87 07.90	24.0218-5001.1	480012	185/186,8 x 37
	600 650 700			09.72 07.77 09.87	06.77 08.87 07.90	24.5207-0205.3	330042 2	L=205
	600 600 650 700			09.72 04.76 07.77 09.87	03.76 06.77 08.87 07.90	24.3215-0802.3	020308	Rz 15,87 FI
	600 600 650 700			04.76 07.77 09.87	06.77 08.87 07.90	24.3219-0801.3	020181	Rz 19,05 FI
	600 600 650 700			09.72 04.76 07.77 09.87	03.76 06.77 08.87 07.90	03.0137-9178.2	669178	Bremsbacken-Zubehör AP
	600 600 650 700			04.76 07.77 09.87	06.77 08.87 07.90	03.0137-0015.2	650015	185 x 31 AUT FI
	600 600 650 700			07.77 09.87	08.87 07.90	03.0137-9021.2	669021	Bremsbacken-Zubehör FI
	600 600 650 700			04.76 07.77 09.87	06.77 08.87 07.90	24.0218-5001.1	480012	185/186,8 x 37
FIAT 127 (71-86)								
	1.0 L/C/CL 1.0 Sport 1.3 D 1.3 Sport Fiorino	8050133		07.78 04.81 04.81 10.77	05.83 02.82 12.86 12.86	24.2119-0806.3	010345	THz 19,05
	0.9 1.0 1.0 Sport 1.3 D 1.3 Sport			02.71 04.77 07.78 04.81 04.81	05.83 05.83 02.82 12.86 12.86	13.0460-3936.2	603936	20073 17,3 BDX
	0.9 1.0 1.0 Sport 1.3 D 1.3 Sport			02.71 04.77 07.78 04.81 04.81	05.83 05.83 02.82 12.86 12.86	24.0111-0130.1	411130	227 10,8 9,0 +B
	0.9 1.0 1.0 Sport 1.3 D 1.3 Sport Fiorino		7054471	02.71 04.77 07.78 04.81 04.81 10.77	05.83 05.83 02.82 12.86 12.86	24.5209-0280.3	330044 2	L=280
	Fiorino	7054472			12.86	24.5209-0280.3	330044	L=280
	0.9 1.0 1.0 Sport 1.3 Sport Fiorino			02.71 04.77 07.78 04.81 10.77	05.83 05.83 02.82 12.86 12.86	24.5209-0250.3	330043 2	L=250
	0.9 1.0 1.0 Sport 1.3 Sport			02.71 04.77 07.78 04.81	05.83 05.83 02.82 10.82	24.3219-0801.3	020181	Rz 19,05 FI
	1.3 Sport Fiorino			11.82 10.77	12.86 12.86	24.3219-0803.3	020183	Rz 19,05
	0.9 1.0 1.0 Sport 1.3 Sport Fiorino			02.71 04.77 07.78 04.81 10.77	05.83 05.83 02.82 12.86 12.86	03.0137-0015.2 03.0137-9021.2	650015 669021	185 x 31 AUT FI Bremsbacken-Zubehör FI

1) - brake booster / - servofreno / - servo-frein / - refuerzo de la presión de fr.

FIAT 127 (71-86)									
	0.9 1.0 1.0 Sport 1.3 Sport Fiorino			02.71 04.77 07.78 04.81 10.77	05.83 05.83 02.82 12.86 12.86		24.0218-5001.1	480012	185/186,8 x 37
	1.3 Sport Fiorino			11.82 10.77	12.86 12.86		03.0420-0319.3	680319	19,05/185x31 Kit FI
FIAT 128 (69-84)									
	1.1 1.3			01.69 09.71	12.84 12.84		13.0460-3936.2	603936	20073 17,3 BDX
	1.1 1.3			01.69 09.71	12.84 12.84		24.0111-0130.1	411130	227 10,8 9,0 +B
	1.1 1.3			04.73 04.73	12.84 12.84		24.5209-0280.3	330044	2 L=280
	1.1 1.3			04.73 04.73	12.84 12.84		24.5209-0250.3	330043	2 L=250
	1.1 1.3			01.69 09.71	12.84 12.84		24.3219-0801.3	020181	Rz 19,05 FI
	1.1 1.3			01.69 09.71	12.84 12.84		03.0137-0015.2 03.0137-9021.2	650015 669021	185 x 31 AUT Bremsbacken-Zubehör FI FI
	1.1 1.3			09.76 09.76	12.84 12.84		24.0218-5001.1	480012	185/186,8 x 37
FIAT 131 (74-84)									
	alle Typen			06.74	06.79		13.0460-3936.2	603936	20073 17,3 BDX
	alle Typen			09.82	06.84		13.0460-3940.2 13.0460-0410.2	603940 610410	20775 18,0 /WK Belagsatz-Zubehör BDX BDX
	alle Typen			06.74	12.80		24.0111-0130.1	411130	227 10,8 9,0 +B
	alle Typen			06.74	02.81		24.5209-0280.3	330044	2 L=280
	alle Typen			06.74	02.81		24.5105-0139.3	331216	2 L=139
	alle Typen			06.74	06.84		03.0137-0139.2 03.0137-0124.2 03.0137-9020.2	650139 650124 669020	229 x 42 229 x 42 HEB AUT Bremsbacken-Zubehör BDX BDX BDX
FIAT 132 (72-81)									
	2000 alle Typen	370702		05.77 04.72	08.77	- 2000	24.2119-0806.3	010345	THz 19,05
	alle Typen			04.72	05.81		13.0460-3936.2	603936	20073 17,3 BDX
	alle Typen			04.72	12.76		24.0111-0130.1	411130	227 10,8 9,0 +B
	alle Typen			01.77	05.81		24.0111-0129.1	411129	251 11,0 9,5
	alle Typen			04.72	05.81		24.5209-0353.3	330046	2 L=350
	alle Typen			04.72	12.76		24.0111-0130.1	411130	227 10,8 9,0 +B
	alle Typen			05.77	05.81		24.5105-0139.3	331216	2 L=139
	alle Typen			01.77	05.81		03.0137-0139.2 03.0137-0124.2 03.0137-9020.2	650139 650124 669020	229 x 42 229 x 42 HEB AUT Bremsbacken-Zubehör BDX BDX BDX
FIAT 500/600 (-75)									
	500 F 600				12.73 12.70		24.3222-0801.3	020248	Rz 22,20
	500 R			11.72	12.75		24.3223-0801.3	020316	Rz 23,81
	500			01.57	12.75		03.0137-9178.2	669178	Bremsbacken-Zubehör AP
	500 R			11.72	12.75		24.5207-0205.3	330042	2 L=205



FIAT 500/600 (-75)										
	500 F 600				12.73 12.70			24.3219-0802.3	020182	Rz 19,05
	500 R				11.72 12.75			24.3215-0802.3	020308	Rz 15,87 FI
	500				01.57 12.75			03.0137-9178.2	669178	Bremsbacken-Zubehör AP
FIAT 850 (68-72)										
	850 Sport Coupe 850 Sport Spider				02.68 03.68	10.72 10.72		24.0111-0130.1	411130	227 10,8 9,0 +B
	850 Sport Coupe 850 Sport Spider				02.68 03.68	10.72 10.72		24.5209-0353.3	330046 2	L=350
	850 Sport Coupe 850 Sport Spider				02.68 03.68	10.72 10.72		24.3219-0801.3	020181	Rz 19,05 FI
	850 Sport Coupe 850 Sport Spider				02.68 03.68	10.72 10.72		03.0137-0015.2 03.0137-9021.2	650015 669021	185 x 31 AUT Bremsbacken-Zubehör FI FI
FIAT 900 (78-85)										
	0.9				01.78 12.85			24.5207-0205.3	330042 2	L=205
	0.9				01.78 12.85			03.0137-0015.2 03.0137-9021.2	650015 669021	185 x 31 AUT Bremsbacken-Zubehör FI FI
FIAT ARGENTA (81-86)										
	1.6 (100) 2.0 (110) 2.0 i.e. (120) 2.5 D 2.5 TD				06.83 06.83 06.83 06.83 06.83	08.83 07.86 07.86 11.85 07.86		13.0460-2941.2	602941	20839 17,0 /WK/S TRW
	1.6 (100) 2.0 (110) 2.0 i.e. (120) 2.5 D 2.5 TD				09.81 09.81 09.81 09.81 09.81	08.83 07.86 07.86 11.85 07.86		24.0112-0112.1	412112	257 12,0 10,8
	2.5 TD				09.81	07.86		13.0460-3942.2	603942	20841 12,0 /WE BDX
	1.6 (100) 2.0 (110) 2.0 i.e. (120) 2.5 D				09.81 09.81 09.81 09.81	08.83 07.86 07.86 11.85		03.0137-0139.2 03.0137-0124.2 03.0137-9020.2	650139 650124 669020	229 x 42 229 x 42 HEB AUT Bremsbacken-Zubehör BDX BDX BDX
FIAT CROMA (85-90)										
	1.6 1.9 TD 2.0 2.0 i.e. 2.0 i.e. Turbo 2.5 D 2.5 TD	0182985 0182985 0182985 0182985 0182985			12.88 10.90 10.90 10.90 10.90 10.90			13.0460-2952.2	602952	21185 19,4 +/WK/S TRW
	2.0 i.e. 2.0 i.e. Turbo				12.85 12.85	10.90 10.90	+ gepanzerte Fahrzeuge ²⁾ + gepanzerte Fahrzeuge ²⁾	13.0460-2979.2	602979	21147 19,0 +/WK/S TRW
	1.6 1.9 TD 2.0 2.0 i.e. 2.5 D	0182985 0182985 0182985 0182985			12.88 10.90 10.90 10.90 10.90		- ABS - ABS - ABS/ - gepanzerte Fzg. ³⁾ - ABS	24.0114-0102.1	414102	258 14,0 12,8
	2.0 i.e. 2.0 i.e. Turbo 2.5 D 2.5 TD		0182984 0182984 0182984 0182984		12.85 12.85 12.85 12.85		+ ABS/ - gepanzerte Fzg. ⁴⁾ - gepanzerte Fahrzeuge ¹⁾ + ABS	24.0120-0129.1	420129	257 20,0 18,2 V
	1.9 TD 2.0 i.e. 2.0 i.e. Turbo 2.5 D 2.5 TD	0182985 0182985 0182985 0182985			12.88 10.90 10.90 10.90 10.90		+ ABS + ABS/ - gepanzerte Fzg. ⁴⁾ - gepanzerte Fahrzeuge ¹⁾ + ABS	24.0122-0130.1	422130	257 22,0 20,2 V
	2.0 i.e. 2.0 i.e. Turbo				12.85 12.85	10.90 10.90	+ gepanzerte Fahrzeuge ²⁾ + gepanzerte Fahrzeuge ²⁾	24.0122-0145.1	422145	284 22,0 20,2 V +B
	1.6 1.9 TD 2.0 2.0 i.e. 2.0 i.e. Turbo 2.5 D 2.5 TD				12.85 12.88 12.85 12.85 12.85 12.85 12.85	10.90 10.90 10.90 10.90 10.90 10.90 10.90	- ABS - ABS - ABS - ABS/ - gepanzerte Fzg. ³⁾ - ABS/ - gepanzerte Fzg. ³⁾ - ABS - ABS	13.0460-3904.2	603904	21107 12,0 BDX
	1.6 1.9 TD 2.0				12.85 12.88 12.85	10.90 10.90 10.90	+ ABS + ABS + ABS	13.0460-2962.2 13.0460-0072.2	602962 610072	20668 16,6 /S TRW Belagsatz-Zubehör TRW

1) - armoured vehicles / - veicoli blindati / - véhicule blindé / - vehículo blindado
2) + armoured vehicles / + veicoli blindati / + véhicule blindé / + vehículo blindado
3) - ABS/ - armoured vehicles / - ABS/ - veicoli blindati / - ABS/ - véhicule blindé / - ABS/ - vehículo blindado
4) + ABS/ - armoured vehicles / + ABS/ - veicoli blindati / + ABS/ - véhicule blindé / + ABS/ - vehículo blindado





FIAT CROMA (85-90)											
	2.0 i.e.			12.85	10.90	+ ABS/ + gepanzerte Fzg. ¹⁾	13.0460-2962.2	602962		20668 16,6 /S Belagsatz-Zubehör	TRW TRW
	2.0 i.e. Turbo			12.85	10.90	+ ABS/ + gepanzerte Fzg. ¹⁾	13.0460-0072.2	610072			
	2.5 D			12.85	10.90	+ ABS					
	2.5 TD			12.85	10.90	+ ABS					
	1.6			12.85	10.90		24.0110-0190.1	410190		252 10,0 9,0 +B	
	1.9 TD			12.88	10.90						
	2.0			12.85	10.90						
	2.0 i.e.			12.85	10.90	- gepanzerte Fahrzeuge ²⁾					
	2.0 i.e. Turbo			12.85	10.90	- gepanzerte Fahrzeuge ²⁾					
	2.5 D			12.85	10.90						
2.5 TD			12.85	10.90							
	2.0 i.e.			12.85	10.90	+ gepanzerte Fahrzeuge ³⁾	24.0110-0209.1	410209		251 10,0 9,0 +B	
	2.0 i.e. Turbo			12.85	10.90	+ gepanzerte Fahrzeuge ³⁾					
	1.6			12.85	10.90		24.3727-0514.2	580514	1 ↓	L=2950	
	1.9 TD			12.88	10.90						
	2.0			12.85	10.90						
	2.0 i.e.			12.85	10.90						
	2.0 i.e. Turbo			12.85	10.90						
	2.5 D			12.85	10.90						
2.5 TD			12.85	10.90							
	1.6			12.85	10.90		03.2525-2201.3	040026		Nz 25,40	
	1.9 TD			12.88	10.90						
	2.0			12.85	10.90						
	2.0 i.e.			12.85	10.90						
	2.0 i.e. Turbo			12.85	10.90						
	2.5 D			12.85	10.90						
2.5 TD			12.85	10.90							

FIAT CROMA (91-96)											
	1.6			11.90	12.92		13.0460-2952.2	602952		21185 19,4 +/WK/S	TRW
	1.9 TD			11.90	10.96						
	2.0			11.90	12.92						
	2.0 i.e.			11.90	10.96	- gepanzerte Fahrzeuge ²⁾					
	2.0 i.e. 16V			12.92	10.96	- gepanzerte Fahrzeuge ²⁾					
	2.0 i.e. Turbo			11.90	10.96	- gepanzerte Fahrzeuge ²⁾					
2.5 TD			11.90	10.96							
	2.0 i.e.			11.90	10.96	+ gepanzerte Fahrzeuge ³⁾	13.0460-2979.2	602979		21147 19,0 +/WK/S	TRW
	2.0 i.e. Turbo			11.90	10.96	+ gepanzerte Fahrzeuge ³⁾					
	2.0 i.e. Turbo			01.93	10.96						
	2.5 i.e. V6			04.93	10.96						
	1.6			11.90	12.92		24.0114-0102.1	414102		258 14,0 12,8	
	1.9 TD			11.90	10.96	- ABS					
	2.0			11.90	12.92						
	2.0 i.e.			11.90	10.96	- ABS/ - gepanzerte Fzg. ⁴⁾					
	1.9 TD			11.90	10.96	+ ABS					
	2.0 i.e.			11.90	10.96	+ ABS/ - gepanzerte Fzg. ⁵⁾					
2.0 i.e. 16V			12.92	10.96	- gepanzerte Fahrzeuge ²⁾						
2.0 i.e. Turbo			11.90	10.96	- gepanzerte Fahrzeuge ²⁾						
2.5 TD			11.90	10.96							
	2.0 i.e.			11.90	10.96	+ gepanzerte Fahrzeuge ³⁾	24.0122-0145.1	422145		284 22,0 20,2 V +B	
	2.0 i.e. Turbo			11.90	10.96	+ gepanzerte Fahrzeuge ³⁾					
	2.5 i.e. V6			04.93	10.96		24.0122-0147.1	422147		284 22,0 20,2 V +B	
	1.6			11.90	12.92	- ABS					
	1.9 TD			11.90	10.96	- ABS					
	2.0			11.90	12.92	- ABS					
	2.0 i.e.			11.90	10.96	- ABS/ - gepanzerte Fzg. ⁴⁾					
	2.0 i.e. 16V			12.92	10.96	- ABS/ - gepanzerte Fzg. ⁴⁾					
2.0 i.e. Turbo			11.90	10.96	- ABS/ - gepanzerte Fzg. ⁴⁾						
2.5 TD			11.90	10.96	- ABS						
	1.6			11.90	12.92	+ ABS	13.0460-2962.2	602962		20668 16,6 /S	TRW
	1.9 TD			11.90	10.96	+ ABS					
	2.0			11.90	12.92	+ ABS					
	2.0 i.e.			11.90	10.96	+ ABS/ + gepanzerte Fzg. ¹⁾					
	2.0 i.e. 16V			12.92	10.96	+ ABS/ + gepanzerte Fzg. ¹⁾					
	2.0 i.e. Turbo			11.90	10.96	+ ABS/ + gepanzerte Fzg. ¹⁾					
2.5 i.e. V6			04.93	10.96							
2.5 TD			11.90	10.96	+ ABS						
	1.6			11.90	12.92		24.0110-0190.1	410190		252 10,0 9,0 +B	
	1.9 TD			11.90	10.96						
	2.0			11.90	12.92						
	2.0 i.e.			11.90	10.96	- gepanzerte Fahrzeuge ²⁾					
	2.0 i.e. 16V			12.92	10.96	- gepanzerte Fahrzeuge ²⁾					
	2.0 i.e. Turbo			11.90	10.96	- gepanzerte Fahrzeuge ²⁾					
2.5 i.e. V6			04.93	10.96							
2.5 TD			11.90	10.96							
	2.0 i.e.			11.90	10.96	+ gepanzerte Fahrzeuge ³⁾	24.0110-0209.1	410209		251 10,0 9,0 +B	
	2.0 i.e. Turbo			11.90	10.96	+ gepanzerte Fahrzeuge ³⁾					
	1.6			11.90	12.92		24.3727-0514.2	580514	1 ↓	L=2950	
	1.9 TD			11.90	10.96						
	2.0			11.90	12.92						
	2.0 i.e.		2025078	11.90	10.96						
	2.0 i.e. Turbo		2025078	11.90	10.96						
	2.5 TD		2025078	11.90	10.96						
2.0 i.e.		2025079	10.96	10.96							
2.0 i.e. 16V			12.92	10.96							

¹⁾ + ABS/ + armoured vehicles / + ABS/ + veicoli blindati / + ABS/ + véhicule blindé / + ABS/ + vehiculo blindado
²⁾ - armoured vehicles / - veicoli blindati / - véhicule blindé / - vehiculo blindado
³⁾ + armoured vehicles / + veicoli blindati / + véhicule blindé / + vehiculo blindado
⁴⁾ - ABS/ - armoured vehicles / - ABS/ - veicoli blindati / - ABS/ - véhicule blindé / - ABS/ - vehiculo blindado
⁵⁾ + ABS/ - armoured vehicles / + ABS/ - veicoli blindati / + ABS/ - véhicule blindé / + ABS/ - vehiculo blindado

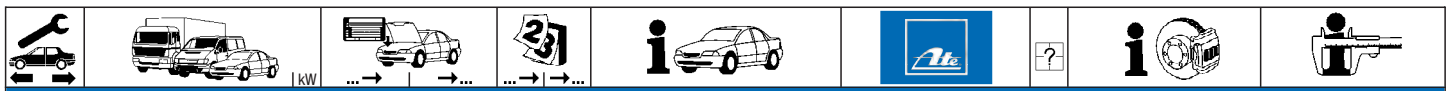

FIAT CROMA (91-96)

	2.0 i.e. Turbo 2.5 i.e. V6 2.5 TD	2025079		04.93	10.96 10.96 10.96	24.3727-0545.2	580545	1		L=2945
	1.6 1.9 TD 2.0 2.0 i.e. 2.0 i.e. 16V 2.0 i.e. Turbo 2.5 i.e. V6 2.5 TD				11.90 12.92 11.90 11.90 11.90 12.92 10.96 11.90 10.96 04.93 10.96 11.90 10.96	03.2525-2201.3	040026			Nz 25,40

FIAT DUCATO (81-94)

	1.8 1.9 D 2.0 2.0 4x4 2.4 D 2.4 TD 2.5 D 2.5 TD 2.5 TD 4x4			09.81 02.87 09.81 06.90 05.81 01.86 01.86 07.90 01.86	01.94 01.94 01.94 01.94 12.85 06.90 01.94 01.94 01.94 - Maxi 1,8 t - Maxi 1,8 t - Maxi 1,8 t	24.2122-0801.3	010373			THz 22,20
	1.8 1.9 D 2.0 2.0 4x4 2.4 D 2.4 TD 2.5 D 2.5 TD 2.5 TD 4x4			09.81 02.87 09.81 06.90 05.81 01.86 01.86 07.90 01.86	01.94 01.94 01.94 01.94 12.85 06.90 01.94 01.94 01.94 - Maxi 1,8 t - Maxi 1,8 t - Maxi 1,8 t	13.0460-2901.2	602901			20741 19,0 +/WK/S TRW
	1.8 1.9 D 2.0 2.0 4x4 2.4 D 2.4 TD 2.5 D 2.5 TD 2.5 TD 4x4		154461 154461 154461 154461	09.81 09.81 06.90 05.81	01.94 01.94 01.94 01.94 12.85 06.90 01.94 01.94 01.94 - Maxi 1,8 t - Maxi 1,8 t - Maxi 1,8 t	24.0113-0168.1	413168			256 13,0 11,0
	1.8 1.9 D 2.0 2.0 4x4 2.4 D 2.4 TD 2.5 D 2.5 TD 2.5 TD 4x4	154462 154462 154462		02.87 01.94 01.94 01.94 12.85 01.86 01.86 07.90 01.86	01.94 01.94 01.94 01.94 12.85 06.90 01.94 01.94 01.94 - Maxi 1,8 t - Maxi 1,8 t - Maxi 1,8 t	24.0116-0105.1	416105			256 16,1 13,5 +B
	1.8 1.9 D 2.0 2.0 4x4 2.4 D 2.4 TD 2.5 D 2.5 TD 2.5 TD 4x4			09.81 02.87 09.81 06.90 05.81 01.86 01.86 07.90 01.86	01.94 01.94 01.94 01.94 12.85 06.90 01.94 01.94 01.94 - Maxi 1,8 t - Maxi 1,8 t - Maxi 1,8 t	24.0116-0106.1	416106			290 16,0 14,8
	1.8 1.9 D 2.0 2.0 4x4 2.4 D 2.4 TD 2.5 D 2.5 TD 2.5 TD 4x4			09.81 09.81 05.81 09.84 02.87 09.84 06.90 09.84 01.86 01.86 07.90 01.86	08.84 08.84 08.84 01.94 01.94 01.94 12.85 06.90 01.94 01.94 01.94 01.94 - Maxi 1,8 t - Maxi 1,8 t - Maxi 1,8 t	24.5112-0362.3	330512	2		L=362
	1.8 1.9 D 2.0 2.0 4x4 2.4 D 2.4 TD 2.5 D 2.5 TD 2.5 TD 4x4			09.84 02.87 09.84 06.90 09.84 01.86 01.86 07.90 01.86	01.94 01.94 01.94 01.94 12.85 06.90 01.94 01.94 01.94 - Maxi 1,8 t - Maxi 1,8 t - Maxi 1,8 t	24.5112-0435.3 24.5112-0436.3	330524 330574	2 2		L=435, + Clip L=435, - Clip
	1.8 1.9 D 2.0 2.0 4x4 2.4 D 2.4 TD 2.5 D 2.5 TD 2.5 TD 4x4			09.81 02.87 09.81 06.90 05.81 01.86 01.86 07.90 01.86	01.94 01.94 01.94 01.94 12.85 06.90 01.94 01.94 01.94 - Maxi 1,8 t - Maxi 1,8 t - Maxi 1,8 t	24.5112-0260.3	330577	1	▣	L=260
	1.8 1.9 D 2.0 2.0 4x4 2.4 D 2.4 TD 2.5 D 2.5 TD 2.5 TD 4x4			01.86 07.90 01.86	01.94 01.94 01.94 + Maxi 1,8 t + Maxi 1,8 t + Maxi 1,8 t	24.5112-0285.3	330604	1	▣	L=285
	1.8 1.9 D 2.0 2.0 4x4 2.4 D 2.4 TD 2.5 D 2.5 TD 2.5 TD 4x4	77161 77161 77161 77161		02.87 01.94 01.94 01.94 12.85 01.86 01.86 07.90 01.86	01.94 01.94 01.94 01.94 12.85 06.90 01.94 01.94 01.94 - Maxi 1,8 t - Maxi 1,8 t - Maxi 1,8 t	24.3225-1101.3	020294			Rz 25,40 TRW
	2.5 D 2.5 TD 2.5 TD 4x4			01.86 07.90 01.86	01.94 01.94 01.94 + Maxi 1,8 t + Maxi 1,8 t + Maxi 1,8 t	24.3226-1101.3	020296			Rz 26,99



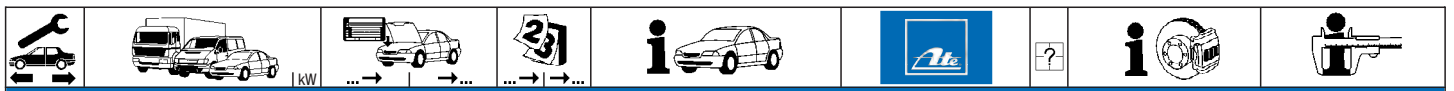

FIAT DUCATO (81-94)											
	2.5 TD 4x4			01.86	01.94	+ Maxi 1,8 t	24.3226-1101.3	020296		Rz 26,99	
	1.8 1.9 D 2.0 2.0 4x4 2.4 D 2.4 TD 2.5 D 2.5 TD 2.5 TD 4x4			09.81 02.87 09.81 06.90 05.81 01.86 01.86 07.90 01.86	01.94 01.94 01.94 01.94 12.85 06.90 01.94 01.94 01.94	- Maxi 1,8 t - Maxi 1,8 t - Maxi 1,8 t	03.0137-0330.2 03.0137-9216.2	650330 669216		254 x 57 HEB Bremsbacken-Zubehör	TRW TRW
	2.5 D 2.5 TD 2.5 TD 4x4			01.86 07.90 01.86	01.94 01.94 01.94	+ Maxi 1,8 t + Maxi 1,8 t + Maxi 1,8 t	03.0137-0269.2 03.0137-9169.2	650269 669169		254 x 57 HEB Bremsbacken-Zubehör	
	1.8 1.9 D 2.0 2.0 4x4 2.4 D 2.4 TD 2.5 D 2.5 TD 2.5 TD 4x4			09.81 02.87 09.81 06.90 05.81 01.86 01.86 07.90 01.86	01.94 01.94 01.94 01.94 12.85 06.90 01.94 01.94 01.94		24.0225-4002.1	480048		254/255,6 x 64,4	
	1.8 1.9 D 2.0 2.0 4x4 2.4 D 2.4 TD 2.5 D 2.5 TD 2.5 TD 4x4	77161 77161 77161 77161		02.87 01.86 01.86 07.90 01.86	01.94 01.94 01.94 12.85 06.90 01.94 01.94 01.94	- Maxi 1,8 t - Maxi 1,8 t - Maxi 1,8 t	03.0520-0125.3	690125		25,40/254x57 TopKit	TRW
	1.8 1.9 D 2.0 2.0 4x4 2.4 D 2.4 TD 2.5 D 2.5 TD 2.5 TD 4x4			09.81 02.87 09.81 06.90 05.81 01.86 01.86 07.90 01.86	01.94 01.94 01.94 01.94 12.85 06.90 01.94 01.94 01.94		24.3727-0527.2	580527	1	L=2566	
	1.8 2.0 2.4 D			09.81 09.81 05.81	12.84 12.84 12.84		24.6513-1701.3	320160		BRL 3/10 (4)	
	1.8 1.9 D 2.0 2.0 4x4 2.4 D 2.4 TD 2.5 D 2.5 TD 2.5 TD 4x4			09.81 02.87 09.81 06.90 05.81 01.86 07.90 01.86	01.94 01.94 01.94 01.94 01.94 01.94 01.94 01.94		24.3728-0515.2	590515		L=1200	
FIAT DUNA (87-90)											
	1.1 1.3 1.7 D			03.87 03.87 03.87	12.90 12.90 12.90		13.0460-5409.2 13.0460-5410.2	605409 605410		21193 18,0 + 21195 18,0 +/WK	ATE ATE
	1.1 1.3 1.7 D			03.87 03.87 03.87	12.90 12.90 12.90		24.0112-0122.1	412122		240 12,0 10,8	
	1.1 1.3 1.7 D			03.87 03.87 03.87	12.90 12.90 12.90		24.3219-1103.3	020408		Rz 19,05	
	1.1 1.3 1.7 D			03.87 03.87 03.87	12.90 12.90 12.90		03.0137-0015.2 03.0137-9021.2	650015 669021		185 x 31 AUT Bremsbacken-Zubehör	FI FI
	1.1 1.3 1.7 D			03.87 03.87 03.87	12.90 12.90 12.90		24.0218-5001.1	480012		185/186,8 x 37	
	1.1 1.3 1.7 D			03.87 03.87 03.87	12.90 12.90 12.90		24.3727-0517.2	580517	1	L=2833	
	1.1 1.3 1.7 D			03.87 03.87 03.87	12.90 12.90 12.90		24.6513-0801.3	320117		BRL 1/3 (2)	
FIAT FIORINO (88-93)											
	1.1 1.3 1.5 1.7 D			09.88 09.88 09.88 09.88	08.93 08.93 08.93 08.93		24.2120-0802.3	010363		Thz 20,64	ATE

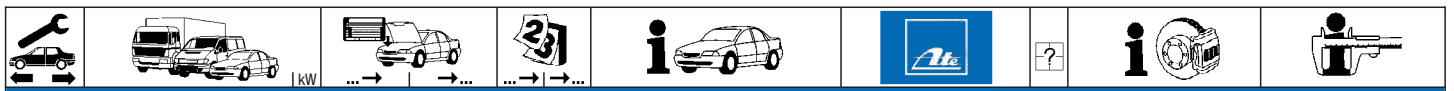

FIAT FIORINO (88-93)

	1.1 1.3 1.5 1.7 D			09.88 09.88 09.88 09.88	08.93 08.93 08.93 08.93		13.0460-5409.2	605409			21193 18,0 +	ATE
	1.1 1.3 1.5 1.7 D			09.88 09.88 09.88 09.88	08.93 08.93 08.93 08.93		24.0112-0122.1	412122			240 12,0 10,8	
	1.1 1.3 1.5 1.7 D			09.88 09.88 09.88 09.88	08.93 08.93 08.93 08.93		24.3219-1103.3	020408			Rz 19,05	
	1.1 1.3 1.5 1.7 D			09.88 09.88 09.88 09.88	08.93 08.93 08.93 08.93		03.0137-0015.2 03.0137-9021.2	650015 669021			185 x 31 AUT Bremsbacken-Zubehör	FI FI
	1.1 1.3 1.5 1.7 D			09.88 09.88 09.88 09.88	08.93 08.93 08.93 08.93		24.0218-5001.1	480012			185/186,8 x 37	
	1.1 1.3 1.5 1.7 D			09.88 09.88 09.88 09.88	08.93 08.93 08.93 08.93		24.3727-0517.2	580517	1		L=2833	
	1.1 1.3 1.5 1.7 D		8220596	09.88 09.88 09.88 09.88	08.93 08.93 08.93 08.93		24.6513-0801.3	320117			BRL 1/3 (2)	

FIAT PANDA (80-85)

	30 34 45 4x4	6166304 6166304 6166304	6223907 6223907 6223907 5242876		09.83		24.2119-0827.3	010350			THz 19,05	
	30 34 45 4x4	6223908 6223908 6223908 5242877			12.85 12.85 12.85 12.85		24.2119-0826.3	010349			THz 19,05	
	30 34 45			05.80 05.80 05.80	08.82 08.82 08.82		13.0460-3936.2	603936			20073 17,3	BDX
	30 34 45 4x4			09.82 09.82 09.82 09.83	12.85 12.85 12.85 12.85		13.0460-3939.2 13.0460-0410.2	603939 610410			20775 18,0 /WE Belagsatz-Zubehör	BDX BDX
	30 34 45 4x4			05.80 05.80 05.80 09.83	12.85 12.85 12.85 12.85		24.0111-0130.1	411130			227 10,8 9,0 +B	
	30 34 45			05.80 05.80 05.80	08.82 08.82 08.82		24.5209-0280.3	330044	2		L=280	
	30 34 45 4x4	6261412 6261412 6261412			12.85 12.85 12.85 12.85		24.3219-0803.3	020183			Rz 19,05	
	30 34 45 4x4			05.80 05.80 05.80 09.83	12.85 12.85 12.85 12.85		03.0137-0015.2 03.0137-9021.2	650015 669021			185 x 31 AUT Bremsbacken-Zubehör	FI FI
	30 34 45 4x4			05.80 05.80 05.80 09.83	12.85 12.85 12.85 12.85		24.0218-5001.1	480012			185/186,8 x 37	
	30 34 45 4x4	6261412 6261412 6261412			12.85 12.85 12.85 12.85		03.0420-0319.3	680319			19,05/185x31 Kit	FI
	30 34 45 4x4			05.80 05.80 05.80 09.83	12.85 12.85 12.85 12.85		24.3727-0503.2	580503	1		L=2670	
	30 34 45 4x4	6166304 6166304 6166304	6261411 6261411 6261411		09.83 12.85		24.6046-0801.3	320116			BR 4/6 (2)	

FIAT REGATA (83-89)

	1.3 1.5 1.6 1.7 D 1.9 D 1.9 TD		7128841 7128841 7128841 7128841 7128841 7128841	09.83 09.83 09.83 09.83 04.84 05.86			24.2119-0827.3	010350			THz 19,05	
--	---	--	--	--	--	--	----------------	--------	--	--	-----------	--



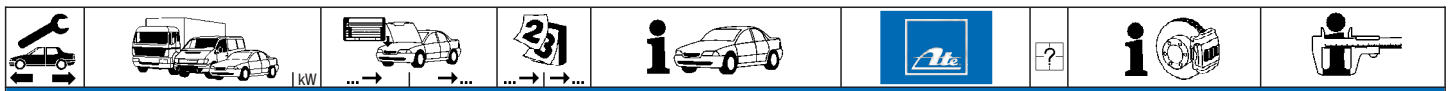

FIAT REGATA (83-89)

	1.3 1.5 1.6 1.7 D 1.9 D 1.9 TD	7128842 7128842 7128842 7128842 7128842 7128842		09.89 09.89 09.89 03.89 09.89 09.89		24.2120-0801.3	010362			THz 20,64	
	1.5 Kombi 1.6 Kombi 1.9 D Kombi 1.9 TD Kombi			09.83 09.83 04.84 05.86	09.89 09.89 09.89 09.89	24.3481-1703.5 24.3481-1704.5	240051 240052			D=48, - Halter D=48, - Halter	TRW TRW
	1.3 1.5 Lim. 1.6 Lim. 1.7 D 1.9 D Lim. 1.9 TD Lim.			09.83 09.83 09.83 09.83 04.84 05.86	09.89 09.89 09.89 09.89 09.89 09.89	13.0460-3940.2 13.0460-0410.2	603940 610410			20775 18,0 /WK Belagsatz-Zubehör	BDX BDX
	1.5 Kombi 1.6 Kombi 1.9 D Kombi 1.9 TD Kombi			09.83 09.83 04.84 05.86	09.89 09.89 09.89 09.89	13.0460-2941.2	602941			20839 17,0 /WK/S	TRW
	1.3 1.5 Lim. 1.6 (90) Lim. 1.7 D 1.9 D Lim. 1.9 TD Lim.			09.83 09.83 09.83 09.83 04.84 05.86	09.89 09.89 09.89 03.89 09.89 09.89	24.0111-0130.1	411130			227 10,8 9,0 +B	
	1.5 Kombi 1.6 (100 S) Lim. 1.6 Kombi 1.9 D Kombi 1.9 TD Kombi			09.83 09.83 09.83 04.84 05.86	09.89 09.89 09.89 09.89 09.89	24.0112-0112.1	412112			257 12,0 10,8	
	1.3 1.5 1.6 1.7 D 1.9 D 1.9 TD			09.83 09.83 09.83 09.83 04.84 05.86	09.89 09.89 09.89 03.89 09.89 09.89	24.3219-0803.3	020183			Rz 19,05	
	1.3 1.5 1.6 1.7 D 1.9 D 1.9 TD			09.83 09.83 09.83 09.83 04.84 05.86	09.89 09.89 09.89 03.89 09.89 09.89	03.0137-0015.2 03.0137-9021.2	650015 669021			185 x 31 AUT Bremsbacken-Zubehör	FI FI
	1.3 1.5 1.6 1.7 D 1.9 D 1.9 TD			09.83 09.83 09.83 09.83 04.84 05.86	09.89 09.89 09.89 03.89 09.89 09.89	24.0218-5001.1	480012			185/186,8 x 37	
	1.3 1.5 1.6 1.7 D 1.9 D 1.9 TD			09.83 09.83 09.83 09.83 04.84 05.86	09.89 09.89 09.89 03.89 09.89 09.89	03.0420-0319.3	680319			19,05/185x31 Kit	FI

FIAT RITMO (78-88)

	1.1 1.3 1.5 1.7 D 60			05.85 05.85 05.85 10.82 10.82	12.85 12.85 12.85 12.85 04.85	24.2119-0827.3	010350			THz 19,05	
	1.1 1.3 1.5 1.7 D 1.9 TD			01.86 01.86 01.86 01.86 06.86	09.87 09.87 09.87 09.87 06.88	24.2120-0801.3	010362			THz 20,64	
	105 TC			05.81	12.85	24.2119-0827.3	010350			THz 19,05	
	125 TC 130 TC			09.81 07.83	12.86 09.87	03.2122-0142.3	010128			THz 22,20	ATE
	1.7 D 60 65 75			03.80 09.78 09.78 09.78	08.82 08.82 09.82 09.82	13.0460-3936.2	603936			20073 17,3	BDX
	1.1 1.3 1.5 1.7 D 60			05.85 05.85 05.85 09.82 09.82	09.87 09.87 09.87 09.87 04.85	13.0460-3940.2 13.0460-0410.2	603940 610410			20775 18,0 /WK Belagsatz-Zubehör	BDX BDX
	1.9 TD 105 TC			06.86 05.81	06.88 12.85	13.0460-2941.2	602941			20839 17,0 /WK/S	TRW























FIAT RITMO (78-88)

	1.1	05.85	09.87	24.0111-0130.1	411130			227 10,8 9,0 +B						
	1.3	05.85	09.87											
	1.5	05.85	09.87											
	1.7 D	03.80	09.87											
	60	09.78	04.85											
	65	09.78	09.82											
105 TC	05.81	08.83	24.0111-0129.1	411129			251 11,0 9,5							
	1.9 TD	06.86	06.88	24.0112-0112.1	412112			257 12,0 10,8						
	105 TC	09.83	12.85											
	1.7 D	03.80	04.85	24.5209-0280.3	330044	2		L=280						
	60	09.78	04.85											
	65	09.78	09.82											
	1.7 D	08.82	04.85	24.3217-1115.3	020310			Rz 17,46 FI						
	60	08.82	04.85											
	65	08.82	09.82											
	75	08.82	09.82											
	1.1	05.85	09.87	24.3219-0803.3	020183			Rz 19,05						
	1.3	05.85	09.87											
	1.5	05.85	09.87											
	1.7 D	05.85	09.87											
	1.9 TD	06.86	06.88											
	105 TC	05.81	12.85											
	125 TC	09.81	12.86											
	130 TC	07.83	06.88											
		1.1	05.85						09.87	03.0137-0015.2	650015			185 x 31 AUT FI
		1.3	05.85						09.87					
1.5		05.85	09.87											
1.7 D		03.80	09.87											
1.9 TD		06.86	06.88											
105 TC		05.81	12.85											
125 TC		09.81	12.86											
130 TC		07.83	06.88											
60		09.78	04.85											
65		09.78	09.82											
75		09.78	09.82											
	1.1	05.85	09.87	24.0218-5001.1	480012			185/186,8 x 37						
	1.3	05.85	09.87											
	1.5	05.85	09.87											
	1.7 D	03.80	09.87											
	1.9 TD	06.86	06.88											
	105 TC	05.81	12.85											
	125 TC	09.81	12.86											
	130 TC	07.83	06.88											
	60	09.78	04.85											
	65	09.78	09.82											
	75	09.78	09.82											
	1.7 D	08.82	04.85	03.0420-0917.3	680917			17,46/185x31 Kit FI						
	60	08.82	04.85											
	65	08.82	09.82											
	75	08.82	09.82											
	1.1	05.85	09.87	03.0420-0319.3	680319			19,05/185x31 Kit FI						
	1.3	05.85	09.87											
	1.5	05.85	09.87											
	1.7 D	05.85	09.87											
	1.9 TD	06.86	06.88											
	105 TC	05.81	12.85											
	125 TC	09.81	12.86											
	130 TC	07.83	06.88											

FIAT TALENTO (88-94)

	1.9 D	10.88	12.94	24.2122-0801.3	010373			ThZ 22,20
	2.0	07.90	12.94					
	1.9 D	10.88	12.94	13.0460-2901.2	602901			20741 19,0 +WK/S TRW
	2.0	07.90	12.94					
	1.9 D	10.88	12.94	24.0116-0105.1	416105			256 16,1 13,5 +B
	2.0	07.90	12.94					
	1.9 D	10.88	12.94	24.5112-0435.3	330524	2		L=435, + Clip
	2.0	07.90	12.94					
	1.9 D	10.88	12.94	24.5112-0436.3	330574	2		L=435, - Clip
	2.0	07.90	12.94					
	1.9 D	10.88	12.94	24.5112-0315.3	330509	1		L=315
	2.0	07.90	12.94					
	1.9 D	10.88	12.94	03.0137-0330.2	650330			254 x 57 HEB TRW
	2.0	07.90	12.94					
	1.9 D	10.88	12.94	03.0137-9216.2	669216			Bremsbacken-Zubehör TRW
	2.0	07.90	12.94					
	1.9 D	10.88	12.94	24.0225-4002.1	480048			254/255,6 x 64,4
	2.0	07.90	12.94					



								
FIAT TALENTO (88-94)								
	1.9 D 2.0			10.90 10.90	12.94 12.94		24.3728-0515.2 590515	L=1200
FIAT TEMPRA (90-93)								
	1.4 i.e. 1.6 i.e. 1.8 i.e. 1.9 D 1.9 TD 2.0 i.e.	◀ ◀ ◀ ◀ ◀ ◀		03.90 03.90 03.90 03.90 03.90 03.90	04.93 04.93 04.93 04.93 04.93 04.93		24.2120-1710.3 010468	- ABS THz 20,64
	1.4 i.e. Lim. 1.6 i.e. Lim.			03.90 03.90	04.93 04.93	- ABS/ + Schaltgetriebe ¹⁾ - ABS/ + Schaltgetriebe ¹⁾	24.0101-3601.2 260044	Bremssattel-Zubehör TRW
	1.4 i.e. Kombi 1.4 i.e. Lim. 1.4 i.e. Lim. 1.6 i.e. Kombi 1.6 i.e. Lim. 1.6 i.e. Lim. 1.8 i.e. Lim. 1.9 D 1.9 TD Lim.			03.90 03.90 03.90 03.90 03.90 03.90 03.90 03.90 03.90	04.93 04.93 04.93 04.93 04.93 04.93 04.93 04.93 04.93	+ ABS/ + Schaltgetriebe ²⁾ + Automatikgetriebe ³⁾ + ABS/ + Schaltgetriebe ²⁾ + Automatikgetriebe ³⁾	24.3481-1703.5 240051 24.3481-1704.5 240052 24.0101-4301.2 260047	D=48, - Halter TRW D=48, - Halter TRW Bremssattel-Zubehör TRW
	1.4 i.e. Lim. 1.6 i.e. Lim.			03.90 03.90	04.93 04.93	- ABS/ + Schaltgetriebe ¹⁾ - ABS/ + Schaltgetriebe ¹⁾	13.0460-2948.2 602948	21100 16,7 +WK/S TRW
	1.4 i.e. Kombi 1.4 i.e. Lim. 1.4 i.e. Lim. 1.6 i.e. Kombi 1.6 i.e. Lim. 1.6 i.e. Lim. 1.8 i.e. 1.9 D 1.9 TD 2.0 i.e.			03.90 03.90 03.90 03.90 03.90 03.90 03.90 03.90 03.90 03.90	04.93 04.93 04.93 04.93 04.93 04.93 04.93 04.93 04.93 04.93	+ ABS/ + Schaltgetriebe ²⁾ + Automatikgetriebe ³⁾ + ABS/ + Schaltgetriebe ²⁾ + Automatikgetriebe ³⁾	13.0460-2949.2 602949	20833 17,0 +WK/S TRW
	1.4 i.e. Lim. 1.6 i.e. Lim.			03.90 03.90	04.93 04.93	- ABS/ + Schaltgetriebe ¹⁾ - ABS/ + Schaltgetriebe ¹⁾	24.0111-0119.1 411119	241 11,0 9,2 +B
	1.4 i.e. Kombi 1.4 i.e. Lim. 1.4 i.e. Lim. 1.6 i.e. Kombi 1.6 i.e. Lim. 1.6 i.e. Lim. 1.8 i.e. Lim. 1.9 D 1.9 TD Lim.			03.90 03.90 03.90 03.90 03.90 03.90 03.90 03.90 03.90	04.93 04.93 04.93 04.93 04.93 04.93 04.93 04.93 04.93	+ ABS/ + Schaltgetriebe ²⁾ + Automatikgetriebe ³⁾ + ABS/ + Schaltgetriebe ²⁾ + Automatikgetriebe ³⁾	24.0112-0127.1 412127	258 12,0 10,2 +B
	1.8 i.e. Kombi 1.9 TD Kombi 2.0 i.e.			03.90 03.90 03.90	04.93 04.93 04.93		24.0120-0142.1 420142 24.0320-0142.1 520142	258 20,0 18,2 V L +B 258 20,0 18,2 V L +B PD
	1.4 i.e. 1.6 i.e.			03.90 03.90	04.93 04.93		24.5112-0360.3 330513 24.5112-0384.3 330651	2 2 L=360 L=387
	1.4 i.e. 1.6 i.e. 1.8 i.e. 1.9 D 1.9 TD 2.0 i.e.			03.90 03.90 03.90 03.90 03.90 03.90	04.93 04.93 04.93 04.93 04.93 04.93	+ ABS + ABS + ABS + ABS + ABS + ABS	24.3344-1703.5 240117 24.3344-1704.5 240118 24.0101-3601.2 260044	D=34, - Halter TRW D=34, - Halter TRW Bremssattel-Zubehör TRW
	1.4 i.e. 1.6 i.e. 1.8 i.e. 1.9 D 1.9 TD 2.0 i.e.			03.90 03.90 03.90 03.90 03.90 03.90	04.93 04.93 04.93 04.93 04.93 04.93	+ ABS + ABS + ABS + ABS + ABS + ABS	13.0460-2951.2 602951 13.0460-0072.2 610072	21103 14,2 /S TRW Belagsatz-Zubehör TRW
	1.4 i.e. 1.6 i.e. 1.8 i.e. 1.9 D 1.9 TD 2.0 i.e.			03.90 03.90 03.90 03.90 03.90 03.90	04.93 04.93 04.93 04.93 04.93 04.93	+ ABS + ABS + ABS + ABS + ABS + ABS	24.0111-0119.1 411119	241 11,0 9,2 +B
	1.4 i.e. Lim. 1.6 i.e. Lim.			03.90 03.90	04.93 04.93	- ABS/ + Schaltgetriebe ¹⁾ - ABS/ + Schaltgetriebe ¹⁾	24.3219-1102.3 020190	Rz 19,05 BDX
	1.4 i.e. Lim. 1.6 i.e. Lim.			03.90 03.90	04.93 04.93	- ABS/ + Schaltgetriebe ¹⁾ - ABS/ + Schaltgetriebe ¹⁾	03.0137-0207.2 650207 03.0137-9088.2 669088	180 x 32 BDX Bremsbacken-Zubehör BDX
	1.4 i.e. Kombi 1.4 i.e. Lim. 1.6 i.e. Kombi 1.6 i.e. Lim. 1.8 i.e. 1.9 D 1.9 TD			03.90 03.90 03.90 03.90 03.90 03.90 03.90	04.93 04.93 04.93 04.93 04.93 04.93 04.93	- ABS - ABS/ + Automatikgetriebe ⁴⁾ - ABS - ABS/ + Automatikgetriebe ⁴⁾ - ABS - ABS - ABS	03.0137-0208.2 650208 03.0137-9081.2 669081	228 x 42 HEB Bremsbacken-Zubehör

1) - ABS/ + manual transmission / - ABS/+ scatola camb.velocità / - ABS/ + transmission mécanique / - ABS/ + cambio de velocidad
2) + ABS/ + manual transm. / + ABS/+ scatola camb.velocità / + ABS/ + transmission mécanique / + ABS/ + cambio de velocidad
3) + autom.transmission / + scatola cambio automatico / + transmission automatique / + cambio automático
4) - ABS/ + autom.transmission / - ABS/ + scatola cambio autom. / - ABS/ + transmission automatique / - ABS/ + cambio automático



FIAT TEMPRA (90-93)

	1.4 i.e. Lim. 1.6 i.e. Lim.			03.90 04.93 - ABS/ + Schaltgetriebe ¹⁾ 03.90 04.93 - ABS/ + Schaltgetriebe ¹⁾	24.0218-0011.1	480006		180/181,4 x 40
	1.4 i.e. Kombi 1.4 i.e. Lim. 1.6 i.e. Kombi 1.6 i.e. Lim. 1.8 i.e. 1.9 D 1.9 TD			03.90 04.93 - ABS 03.90 04.93 - ABS/ + Automatikgetriebe ²⁾ 03.90 04.93 - ABS 03.90 04.93 - ABS/ + Automatikgetriebe ²⁾ 03.90 04.93 - ABS 03.90 04.93 - ABS 03.90 04.93 - ABS	24.0222-8018.1	480078		228/230 x 48
	1.4 i.e. Lim. 1.6 i.e. Lim.			03.90 04.93 - ABS/ + Schaltgetriebe ¹⁾ 03.90 04.93 - ABS/ + Schaltgetriebe ¹⁾	03.0520-1219.3	691219		19,05/180x32 TopKit BDX
	1.4 i.e. Lim. 1.6 i.e. Lim.			03.90 04.93 - ABS/ + Schaltgetriebe ¹⁾ 03.90 04.93 - ABS/ + Schaltgetriebe ¹⁾	24.3727-0511.2 24.3727-0510.2	580511 580510	<input type="checkbox"/> <input type="checkbox"/>	L=1415 L=1375
	1.4 i.e. Kombi 1.4 i.e. Lim. 1.6 i.e. Kombi 1.6 i.e. Lim. 1.8 i.e. 1.9 D 1.9 TD			03.90 04.93 - ABS 03.90 04.93 - ABS/ + Automatikgetriebe ²⁾ 03.90 04.93 - ABS 03.90 04.93 - ABS/ + Automatikgetriebe ²⁾ 03.90 04.93 - ABS 03.90 04.93 - ABS 03.90 04.93 - ABS	24.3727-0513.2	580513	<input type="checkbox"/>	L=1445
	1.4 i.e. 1.6 i.e. 1.8 i.e. 1.9 D 1.9 TD 2.0 i.e.			03.90 04.93 + ABS 03.90 04.93 + ABS 03.90 04.93 + ABS 03.90 04.93 + ABS 03.90 04.93 + ABS 03.90 04.93 + ABS	24.3727-0521.2 24.3727-0006.2	580521 580006	<input type="checkbox"/> <input type="checkbox"/>	L=1517 L=1460
	1.4 i.e. 1.6 i.e. 1.8 i.e. 2.0 i.e.			03.90 04.93 03.90 04.93 03.90 04.93 03.90 04.93	24.3728-0503.2	590503		L=729
	1.8 i.e. 1.9 D 1.9 TD 2.0 i.e.	7003767 7003767		03.90 04.93 03.90 04.93 03.90 04.93 03.90 04.93	24.3728-0502.2	590502		L=764

FIAT TEMPRA (93-96)

	1.4 i.e. 1.6 i.e. 1.8 i.e. 1.9 D 1.9 TD 2.0 i.e. 2.0 i.e. 4x4			05.93 09.96 05.93 09.96 05.93 09.96 05.93 09.96 05.93 09.96 05.93 09.96 05.93 09.96	13.0460-2949.2	602949		20833 17,0 +WK/S TRW
	1.4 i.e. Lim. 1.6 i.e. Lim. 1.9 D Lim.			05.93 09.96 - ABS 05.93 09.96 - ABS/ + Schaltgetriebe ¹⁾ 05.93 09.96 - ABS	24.0111-0119.1	411119		241 11,0 9,2 +B
	1.4 i.e. Kombi 1.4 i.e. Lim. 1.6 i.e. Kombi 1.6 i.e. Lim. 1.8 i.e. Lim. 1.9 D Kombi 1.9 D Lim. 1.9 TD Lim.			05.93 09.96 05.93 09.96 + ABS 05.93 09.96 05.93 09.96 + ABS/ + Automatikgetriebe ³⁾ 05.93 09.96 05.93 09.96 + ABS 05.93 09.96	24.0112-0127.1	412127		258 12,0 10,2 +B
	1.8 i.e. Kombi 1.9 TD Kombi 2.0 i.e. 2.0 i.e. 4x4			05.93 09.96 05.93 09.96 05.93 09.96 05.93 09.96	24.0120-0142.1 24.0320-0142.1	420142 520142		258 20,0 18,2 V L +B 258 20,0 18,2 V L +B PD
	1.4 i.e. 1.6 i.e. 1.8 i.e. 1.9 D 1.9 TD 2.0 i.e. 2.0 i.e. 4x4			05.93 09.96 + ABS 05.93 09.96 + ABS 05.93 09.96 + ABS 05.93 09.96 + ABS 05.93 09.96 + ABS 05.93 09.96 05.93 09.96	24.3344-1703.5 24.3344-1704.5 24.0101-3601.2	240117 240118 260044	<input type="checkbox"/> <input type="checkbox"/>	D=34, - Halter TRW D=34, - Halter TRW Bremsattel-Zubehör TRW
	1.4 i.e. 1.6 i.e. 1.8 i.e. 1.9 D 1.9 TD 2.0 i.e. 2.0 i.e. 4x4			05.93 09.96 + ABS 05.93 09.96 + ABS 05.93 09.96 + ABS 05.93 09.96 + ABS 05.93 09.96 + ABS 05.93 09.96 05.93 09.96	13.0460-2951.2 13.0460-0072.2	602951 610072		21103 14,2 /S TRW Belagsatz-Zubehör TRW
	1.4 i.e. 1.6 i.e. 1.8 i.e. 1.9 D 1.9 TD 2.0 i.e. 2.0 i.e. 4x4			05.93 09.96 + ABS 05.93 09.96 + ABS 05.93 09.96 + ABS 05.93 09.96 + ABS 05.93 09.96 + ABS 05.93 09.96 05.93 09.96	24.0111-0119.1	411119		241 11,0 9,2 +B
	1.8 i.e. 2.0 i.e. 2.0 i.e. 4x4			05.93 09.96 05.93 09.96 05.93 09.96	24.5228-0223.3	330530	2	L=223

¹⁾ - ABS/ + manual transmission / - ABS/+ scatola camb.velocità / - ABS/ + transmission mécanique / - ABS/ + cambio de velocidad
²⁾ - ABS/ + autom.transmission / - ABS/ + scatola cambio autom. / - ABS/ + transmission automatique / - ABS/ + cambio automático
³⁾ + ABS/ + autom.transmission / + ABS/ + scatola cambio autom. / + ABS/ + transmission automatique / + ABS/ + cambio automático



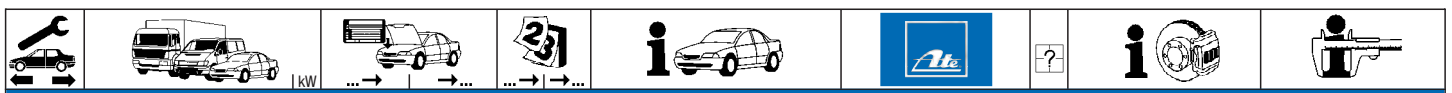

FIAT TEMPRA (93-96)

	1.4 i.e. 1.6 i.e. 1.9 D		05.93 05.93 05.93	09.96 09.96 09.96	- ABS - ABS/ + Schaltgetriebe 1) - ABS	24.3222-1701.3	020376		Rz 22,20
	1.6 i.e. 1.8 i.e. 1.9 TD		05.93 05.93 05.93	09.96 09.96 09.96	- ABS/ + Automatikgetriebe 2) - ABS - ABS	24.3220-1116.3	020313		Rz 20,64
	1.4 i.e. Lim. 1.6 i.e. Lim. 1.9 D Lim.		05.93 05.93 05.93	09.96 09.96 09.96	- ABS - ABS/ + Schaltgetriebe 1) - ABS	03.0137-0207.2 03.0137-9088.2	650207 669088		180 x 32 Bremsbacken-Zubehör BDX
	1.4 i.e. Kombi 1.6 i.e. Kombi 1.6 i.e. Lim. 1.8 i.e. 1.9 D Kombi 1.9 TD		05.93 05.93 05.93 05.93 05.93 05.93	09.96 09.96 09.96 09.96 09.96 09.96	- ABS - ABS - ABS/ + Automatikgetriebe 2) - ABS - ABS - ABS	03.0137-0208.2 03.0137-9081.2	650208 669081		228 x 42 HEB Bremsbacken-Zubehör
	1.4 i.e. Lim. 1.6 i.e. Lim. 1.9 D Lim.		05.93 05.93 05.93	09.96 09.96 09.96	- ABS - ABS/ + Schaltgetriebe 1) - ABS	24.0218-0011.1	480006		180/181,4 x 40
	1.4 i.e. Kombi 1.6 i.e. Kombi 1.6 i.e. Lim. 1.8 i.e. 1.9 D Kombi 1.9 TD		05.93 05.93 05.93 05.93 05.93 05.93	09.96 09.96 09.96 09.96 09.96 09.96	- ABS - ABS - ABS/ + Automatikgetriebe 2) - ABS - ABS - ABS	24.0222-8018.1	480078		228/230 x 48
	1.4 i.e. Lim. 1.6 i.e. Lim. 1.9 D Lim.		05.93 05.93 05.93	09.96 09.96 09.96	- ABS - ABS/ + Schaltgetriebe 1) - ABS	03.0420-4322.3	684322		22,20/180x32 Kit BDX
	1.6 i.e. Lim. 1.8 i.e. 1.9 TD		05.93 05.93 05.93	09.96 09.96 09.96	- ABS/ + Automatikgetriebe 2) - ABS - ABS	03.0420-4520.3	684520		20,64/228x42 Kit
	1.4 i.e. Lim. 1.6 i.e. Lim.		05.93 05.93	09.96 09.96	- ABS - ABS/ + Schaltgetriebe 1)	24.3727-0511.2 24.3727-0510.2	580511 580510	<input type="checkbox"/> <input type="checkbox"/>	L=1415 L=1375
	1.4 i.e. Kombi 1.6 i.e. Kombi 1.6 i.e. Lim. 1.8 i.e. 1.9 D 1.9 TD		05.93 05.93 05.93 05.93 05.93 05.93	09.96 09.96 09.96 09.96 09.96 09.96	- ABS - ABS - ABS/ + Automatikgetriebe 2) - ABS - ABS - ABS	24.3727-0513.2	580513	<input type="checkbox"/>	L=1445
	1.4 i.e. 1.6 i.e. 1.8 i.e. 1.9 D 1.9 TD 2.0 i.e.		05.93 05.93 05.93 05.93 05.93 05.93	09.96 09.96 09.96 09.96 09.96 09.96	+ ABS + ABS + ABS + ABS + ABS	24.3727-0521.2 24.3727-0006.2	580521 580006	<input type="checkbox"/> <input type="checkbox"/>	L=1517 L=1460
	1.4 i.e. 1.6 i.e.	◀	05.93 05.93	09.96 09.96		24.3728-0503.2	590503		L=729
	1.8 i.e. 1.9 TD 2.0 i.e. 2.0 i.e. 4x4	◀ ◀ ◀ ◀	05.93 05.93 05.93 05.93	09.96 09.96 09.96 09.96		24.3728-0502.2	590502		L=764

FIAT TIPO (88-93)

	1.1 1.4 1.4 i.e. 1.6 1.6 i.e. 1.7 D 1.8 i.e. 1.8 i.e. 16V 1.9 D 1.9 TD 2.0 i.e. 2.0 i.e. 16V	◀ ◀ ◀ ◀ ◀ ◀ ◀ ◀101 ◀ ◀ ◀ ◀ ◀	01.88 01.88 01.88 01.88 01.88 01.88 03.90 10.89 01.88 01.88 09.90 01.91	04.93 04.93 04.93 04.93 04.93 04.93 04.93 04.93 04.93 04.93 04.93 04.93		24.2120-1710.3	010468	- ABS	Thz 20,64
	1.1 1.4 1.4 i.e. 1.6 1.6 i.e. 1.7 D 1.9 D		01.88 01.88 01.88 01.88 01.88 01.88 01.88	04.93 04.93 04.93 04.93 04.93 04.93 04.93	- ABS - ABS - ABS - ABS/ + Schaltgetriebe 1) - ABS/ + Schaltgetriebe 1) - ABS - ABS	24.0101-3601.2	260044		Bremsattel-Zubehör TRW
	1.1 1.4 1.4 i.e. 1.6 1.6 i.e. 1.6 i.e. 1.6 i.e. 1.7 D 1.8 i.e. 1.9 D 1.9 TD	57 57 66	01.88 01.88 01.88 01.88 01.88 01.88 01.88 01.88 03.90 01.88 01.88	04.93 04.93 04.93 04.93 04.93 04.93 04.93 04.93 04.93 04.93 04.93	+ ABS + ABS + ABS + ABS/ + Schaltgetriebe 3) + Automatikgetriebe 4) + ABS/ + Schaltgetriebe 3) + Automatikgetriebe 4) + ABS + ABS	24.3481-1703.5 24.3481-1704.5 24.0101-4301.2	240051 240052 260047	<input type="checkbox"/> <input type="checkbox"/>	D=48, - Halter D=48, - Halter Bremsattel-Zubehör TRW TRW TRW

1) - ABS/ + manual transmission / - ABS/+ scatola camb.velocità / - ABS/ + transmission mécanique / - ABS/ + cambio de velocidad
 2) - ABS/ + autom.transmission / - ABS/ + scatola cambio autom. / - ABS/ + transmission automatique / - ABS/ + cambio automático
 3) + ABS/ + manual transm. / + ABS/+ scatola camb.velocità / + ABS/ + transmission mécanique / + ABS/ + cambio de velocidad
 4) + autom.transmission / + scatola cambio automatico / + transmission automatique / + cambio automático

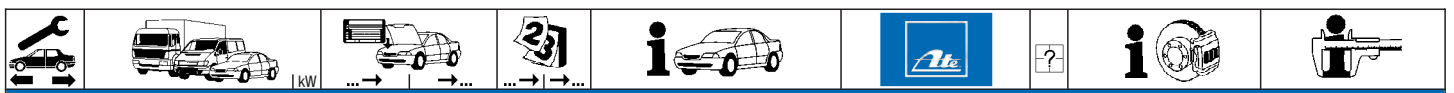

FIAT TIPO (88-93)

	1.1		01.88	04.93	- ABS	13.0460-2948.2	602948		21100	16,7 +WK/S	TRW
	1.4		01.88	04.93	- ABS						
	1.4 i.e.		01.88	04.93	- ABS						
	1.6		01.88	04.93	- ABS/ + Schaltgetriebe ¹⁾						
	1.6 i.e.	57	01.88	04.93	- ABS/ + Schaltgetriebe ¹⁾						
	1.7 D		01.88	04.93	- ABS						
	1.9 D		01.88	04.93	- ABS						
	1.1		01.88	04.93	+ ABS						
	1.4		01.88	04.93	+ ABS						
	1.4 i.e.		01.88	04.93	+ ABS						
1.6		01.88	04.93	+ ABS/ + Schaltgetriebe ²⁾							
1.6		01.88	04.93	+ Automatikgetriebe ³⁾							
1.6 i.e.	57	01.88	04.93	+ ABS/ + Schaltgetriebe ²⁾							
1.6 i.e.	57	01.88	04.93	+ Automatikgetriebe ³⁾							
1.6 i.e.	66	01.88	12.91	+ ABS							
1.7 D		01.88	04.93	+ ABS							
1.8 i.e.		03.90	04.93								
1.8 i.e. 16V	101	10.89	04.93								
1.9 D		01.88	04.93	+ ABS							
1.9 TD		01.88	04.93								
2.0 i.e.	80	09.90	04.93								
2.0 i.e. 16V	107	01.91	04.93								
	1.1		01.88	04.93	- ABS	24.0111-0119.1	411119		241	11,0 9,2 +B	TRW
	1.4		01.88	04.93	- ABS						
	1.4 i.e.		01.88	04.93	- ABS						
	1.6		01.88	04.93	- ABS/ + Schaltgetriebe ¹⁾						
	1.6 i.e.	57	01.88	04.93	- ABS/ + Schaltgetriebe ¹⁾						
	1.7 D		01.88	04.93	- ABS						
	1.9 D		01.88	04.93	- ABS						
	1.1		01.88	04.93	+ ABS						
	1.4		01.88	04.93	+ ABS						
	1.4 i.e.		01.88	04.93	+ ABS						
1.6		01.88	04.93	+ ABS/ + Schaltgetriebe ²⁾							
1.6		01.88	04.93	+ Automatikgetriebe ³⁾							
1.6 i.e.	57	01.88	04.93	+ ABS/ + Schaltgetriebe ²⁾							
1.6 i.e.	57	01.88	04.93	+ Automatikgetriebe ³⁾							
1.6 i.e.	66	01.88	12.91	+ ABS							
1.7 D		01.88	04.93	+ ABS							
1.8 i.e.		03.90	04.93								
1.9 D		01.88	04.93	+ ABS							
1.9 TD		01.88	04.93								
1.8 i.e. 16V	101	10.89	04.93								
2.0 i.e.	80	09.90	04.93								
2.0 i.e. 16V	107	01.91	04.93								
	1.1		01.88	04.93		24.5112-0360.3	330513	2		L=360	TRW
	1.4		01.88	04.93							
	1.4 i.e.		01.88	04.93							
	1.6		01.88	04.93							
	1.6 i.e.		01.88	04.93							
	1.9 D		01.88	04.93							
	1.9 TD		01.88	04.93							
1.1		01.88	04.93		24.5112-0384.3	330651	2		L=387	TRW	
1.4		01.88	04.93								
1.4 i.e.		01.88	04.93								
1.6		01.88	04.93								
1.6 i.e.		01.88	04.93								
1.9 D		01.88	04.93								
1.9 TD		01.88	04.93								
	1.1		01.88	04.93	+ ABS	24.3344-1703.5	240117	<input type="checkbox"/>	D=34, - Halter	TRW	
	1.4		01.88	04.93	+ ABS						
	1.4 i.e.		01.88	04.93	+ ABS						
	1.6		01.88	04.93	+ ABS						
	1.6 i.e.		01.88	04.93	+ ABS						
	1.7 D		01.88	04.93	+ ABS						
	1.8 i.e.		03.90	04.93	+ ABS						
	1.8 i.e. 16V	101	10.89	04.93							
	1.9 D		01.88	04.93	+ ABS						
	1.9 TD		01.88	04.93	+ ABS						
2.0 i.e.		09.90	04.93								
2.0 i.e. 16V		01.91	04.93								
	1.1		01.88	04.93	+ ABS	13.0460-2951.2	602951		21103	14,2 /S	TRW
	1.4		01.88	04.93	+ ABS						
	1.4 i.e.		01.88	04.93	+ ABS						
	1.6		01.88	04.93	+ ABS						
	1.6 i.e.		01.88	04.93	+ ABS						
	1.7 D		01.88	04.93	+ ABS						
	1.8 i.e.		03.90	04.93	+ ABS						
	1.8 i.e. 16V	101	10.89	04.93							
	1.9 D		01.88	04.93	+ ABS						
	1.9 TD		01.88	04.93	+ ABS						
2.0 i.e.		09.90	04.93								
2.0 i.e. 16V		01.91	04.93								
	1.1		01.88	04.93	+ ABS	24.0111-0119.1	411119		241	11,0 9,2 +B	TRW
	1.4		01.88	04.93	+ ABS						
	1.4 i.e.		01.88	04.93	+ ABS						
	1.6		01.88	04.93	+ ABS						
	1.6 i.e.		01.88	04.93	+ ABS						
	1.7 D		01.88	04.93	+ ABS						
	1.8 i.e.		03.90	04.93	+ ABS						
	1.8 i.e. 16V	101	10.89	04.93							
	1.9 D		01.88	04.93	+ ABS						
	1.9 TD		01.88	04.93	+ ABS						
2.0 i.e.		09.90	04.93								
2.0 i.e. 16V		01.91	04.93								

¹⁾ - ABS/ + manual transmission / - ABS/+ scatola camb.velocità / - ABS/ + transmission mécanique / - ABS/ + cambio de velocidad

²⁾ + ABS/ + manual transm. / + ABS/+ scatola camb.velocità / + ABS/ + transmission mécanique / + ABS/ + cambio de velocidad

³⁾ + autom.transmission / + scatola cambio automatico / + transmission automatique / + cambio automático





FIAT TIPO (88-93)										
	2.0 i.e. 16V			01.91	04.93		24.0111-0119.1	411119		241 11,0 9,2 +B
	1.1 1.4 1.4 i.e. 1.6 1.6 i.e.			01.88 01.88 01.88 01.88 01.88	04.93 04.93 04.93 04.93 04.93		24.5228-0223.3	330530	2	L=223
	1.1 1.4 1.4 i.e. 1.6 1.6 i.e.			01.88 01.88 01.88 01.88 01.88	04.93 04.93 04.93 04.93 04.93	- ABS - ABS/ + Schaltgetriebe ¹⁾ - ABS/ + Schaltgetriebe ¹⁾ - ABS/ + Schaltgetriebe ¹⁾ - ABS/ + Schaltgetriebe ¹⁾	24.3215-1102.3	020156		Rz 15,87 BDX
	1.4 1.4 i.e. 1.7 D 1.9 D	57		01.88 01.88 01.88 01.88	04.93 04.93 04.93 04.93	- ABS/ + Automatikgetriebe ²⁾ - ABS/ + Automatikgetriebe ²⁾ - ABS - ABS	24.3219-1102.3	020190		Rz 19,05 BDX
	1.1 1.4 1.4 i.e. 1.6 1.6 i.e. 1.7 D 1.9 D			01.88 01.88 01.88 01.88 01.88 01.88 01.88	04.93 04.93 04.93 04.93 04.93 04.93 04.93	- ABS - ABS - ABS - ABS/ + Schaltgetriebe ¹⁾ - ABS/ + Schaltgetriebe ¹⁾ - ABS - ABS	03.0137-0207.2 03.0137-9088.2	650207 669088		180 x 32 Bremsbacken-Zubehör BDX
	1.6 1.6 i.e. 1.6 i.e. 1.8 i.e. 1.9 TD	57 66		01.88 01.88 01.88 03.90 01.88	04.93 04.93 12.91 04.93 04.93	- ABS/ + Automatikgetriebe ²⁾ - ABS/ + Automatikgetriebe ²⁾ - ABS - ABS - ABS	03.0137-0208.2 03.0137-9081.2	650208 669081		228 x 42 HEB Bremsbacken-Zubehör
	1.1 1.4 1.4 i.e. 1.6 1.6 i.e. 1.7 D 1.9 D			01.88 01.88 01.88 01.88 01.88 01.88 01.88	04.93 04.93 04.93 04.93 04.93 04.93 04.93	- ABS - ABS - ABS - ABS/ + Schaltgetriebe ¹⁾ - ABS/ + Schaltgetriebe ¹⁾ - ABS - ABS	24.0218-0011.1	480006		180/181,4 x 40
	1.6 1.6 i.e. 1.6 i.e. 1.8 i.e. 1.9 TD	57 66		01.88 01.88 01.88 03.90 01.88	04.93 04.93 12.91 04.93 04.93	- ABS/ + Automatikgetriebe ²⁾ - ABS/ + Automatikgetriebe ²⁾ - ABS - ABS - ABS	24.0222-8018.1	480078		228/230 x 48
	1.4 1.4 i.e. 1.7 D 1.9 D			01.88 01.88 01.88 01.88	04.93 04.93 04.93 04.93	- ABS/ + Automatikgetriebe ²⁾ - ABS/ + Automatikgetriebe ²⁾ - ABS - ABS	03.0520-1219.3	691219		19,05/180x32 TopKit BDX
	1.1 1.4 1.4 i.e. 1.6 1.6 i.e. 1.7 D 1.9 D			01.88 01.88 01.88 01.88 01.88 01.88 01.88	04.93 04.93 04.93 04.93 04.93 04.93 04.93	- ABS - ABS - ABS - ABS/ + Schaltgetriebe ¹⁾ - ABS/ + Schaltgetriebe ¹⁾ - ABS - ABS	24.3727-0511.2 24.3727-0510.2	580511 580510	<input type="checkbox"/> <input type="checkbox"/>	L=1415 L=1375
	1.6 1.6 i.e. 1.6 i.e. 1.8 i.e. 1.9 TD	57 66		01.88 01.88 01.88 03.90 01.88	04.93 04.93 12.91 04.93 04.93	- ABS/ + Automatikgetriebe ²⁾ - ABS/ + Automatikgetriebe ²⁾ - ABS - ABS - ABS	24.3727-0513.2	580513	<input type="checkbox"/>	L=1445
	1.1 1.4 1.4 i.e. 1.6 1.6 i.e. 1.7 D 1.8 i.e. 1.8 i.e. 16V 1.9 D 1.9 TD 2.0 i.e. 2.0 i.e. 16V	57 66 101		01.88 01.88 01.88 01.88 01.88 01.88 03.90 10.89 01.88 01.88 09.90 01.91	04.93 04.93 04.93 04.93 04.93 04.93 04.93 04.93 04.93 04.93 04.93 04.93	+ ABS + ABS + ABS + ABS + ABS + ABS + ABS + ABS + ABS + ABS	24.3727-0521.2 24.3727-0006.2	580521 580006	<input type="checkbox"/> <input type="checkbox"/>	L=1517 L=1460
	1.1 1.4 1.4 i.e. 1.6 1.6 i.e. 1.7 D 1.9 TD			01.88 01.88 01.88 01.88 01.88 01.88 01.88	04.93 04.93 04.93 04.93 04.93 04.93 04.93		24.3728-0503.2	590503		L=729
	1.8 i.e. 1.8 i.e. 16V 1.9 D 1.9 TD 2.0 i.e. 2.0 i.e. 16V	101	2067624	03.90 10.89 01.88 01.88 09.90 01.91	04.93 04.93 04.93 04.93 04.93 04.93		24.3728-0502.2	590502		L=764

¹⁾ - ABS/ + manual transmission / - ABS/+ scatola camb.velocità / - ABS/ + transmission mécanique / - ABS/ + cambio de velocidad
²⁾ - ABS/ + autom.transmission / - ABS/+ scatola cambio autom. / - ABS/ + transmission automatique / - ABS/ + cambio automático

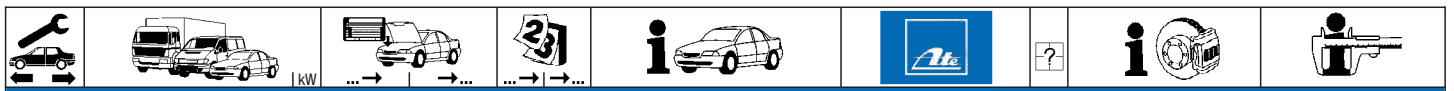

FIAT TIPO (93-95)

	1.4 i.e. 1.6 i.e. 1.7 D 1.8 i.e. 1.9 D 1.9 TD 2.0 i.e.	83	05.93 05.93 05.93 05.93 05.93 05.93 05.93	09.95 09.95 09.95 09.95 09.95 09.95 09.95	13.0460-2949.2	602949		20833	17,0 +WK/S	TRW
	2.0 i.e. 16V		05.93	09.95	13.0460-2979.2	602979		21147	19,0 +WK/S	TRW
	1.4 i.e. 1.6 i.e. 1.7 D 1.9 D		05.93 05.93 05.93 05.93	09.95 09.95 09.95 09.95	24.0111-0119.1	411119		241	11,0 9,2 +B	
	1.4 i.e. 1.6 i.e. 1.8 i.e. 1.9 TD		05.93 05.93 05.93 05.93	09.95 09.95 09.95 09.95	24.0112-0127.1	412127		258	12,0 10,2 +B	
	2.0 i.e.	83	05.93	09.95	24.0120-0142.1	420142 24.0320-0142.1 520142		258	20,0 18,2 V L +B 258 20,0 18,2 V L +B PD	
	2.0 i.e. 16V		05.93	09.95	24.0122-0107.1	422107		284	22,0 20,2 V +B	
	1.4 i.e. 1.6 i.e. 1.7 D 1.8 i.e. 1.9 D 1.9 TD 2.0 i.e. 2.0 i.e. 16V	83	05.93 05.93 05.93 05.93 05.93 05.93 05.93 05.93	09.95 09.95 09.95 09.95 09.95 09.95 09.95 09.95	24.3344-1703.5 24.3344-1704.5 24.0101-3601.2	240117 240118 260044	<input type="checkbox"/> <input type="checkbox"/>	D=34, - Halter D=34, - Halter Bremsattel-Zubehör	TRW TRW TRW	
	1.4 i.e. 1.6 i.e. 1.7 D 1.8 i.e. 1.9 D 1.9 TD 2.0 i.e. 2.0 i.e. 16V	83	05.93 05.93 05.93 05.93 05.93 05.93 05.93 05.93	09.95 09.95 09.95 09.95 09.95 09.95 09.95 09.95	13.0460-2951.2 13.0460-0072.2	602951 610072		21103	14,2 /S Belagsatz-Zubehör	TRW TRW
	1.4 i.e. 1.6 i.e. 1.7 D 1.8 i.e. 1.9 D 1.9 TD 2.0 i.e. 2.0 i.e. 16V	83	05.93 05.93 05.93 05.93 05.93 05.93 05.93 05.93	09.95 09.95 09.95 09.95 09.95 09.95 09.95 09.95	24.0111-0119.1	411119		241	11,0 9,2 +B	
	1.4 i.e. 1.6 i.e. 1.7 D 1.8 i.e. 1.9 D 1.9 TD 2.0 i.e. 2.0 i.e. 16V	83	05.93 05.93 05.93 05.93 05.93 05.93 05.93 05.93	09.95 09.95 09.95 09.95 09.95 09.95 09.95 09.95	83.6401-0159.3	330746	2	L=160		
	1.4 i.e. 1.6 i.e. 1.7 D 1.9 D		05.93 05.93 05.93 05.93	09.95 09.95 09.95 09.95	24.3222-1701.3	020376		Rz 22,20		
	1.6 i.e. 1.8 i.e. 1.9 TD		05.93 05.93 05.93	09.95 09.95 09.95	24.3220-1116.3	020313		Rz 20,64		
	1.4 i.e. 1.6 i.e. 1.7 D 1.9 D		05.93 05.93 05.93 05.93	09.95 09.95 09.95 09.95	03.0137-0207.2 03.0137-9088.2	650207 669088		180 x 32 Bremsbacken-Zubehör	BDX BDX	
	1.6 i.e. 1.8 i.e. 1.9 TD		05.93 05.93 05.93	09.95 09.95 09.95	03.0137-0208.2 03.0137-9081.2	650208 669081		228 x 42 HEB Bremsbacken-Zubehör		
	1.4 i.e. 1.6 i.e. 1.7 D 1.9 D		05.93 05.93 05.93 05.93	09.95 09.95 09.95 09.95	24.0218-0011.1	480006		180/181,4 x 40		
	1.6 i.e. 1.8 i.e. 1.9 TD		05.93 05.93 05.93	09.95 09.95 09.95	24.0222-8018.1	480078		228/230 x 48		
	1.4 i.e. 1.6 i.e. 1.7 D 1.9 D		05.93 05.93 05.93 05.93	09.95 09.95 09.95 09.95	03.0420-4322.3	684322		22,20/180x32 Kit	BDX	
	1.6 i.e. 1.8 i.e. 1.9 TD		05.93 05.93 05.93	09.95 09.95 09.95	03.0420-4520.3	684520		20,64/228x42 Kit		
	1.4 i.e. 1.6 i.e. 1.7 D 1.9 D		05.93 05.93 05.93 05.93	09.95 09.95 09.95 09.95	24.3727-0511.2 24.3727-0510.2	580511 580510	<input type="checkbox"/> <input type="checkbox"/>	L=1415 L=1375		
	1.6 i.e.		05.93	09.95	24.3727-0513.2	580513	<input type="checkbox"/>	L=1445		

1) - ABS/ + manual transmission / - ABS/+ scatola camb.velocità / - ABS/ + transmission mécanique / - ABS/ + cambio de velocidad
2) - ABS/ + autom.transmission / - ABS/ + scatola cambio autom. / - ABS/ + transmission automatique / - ABS/ + cambio automático



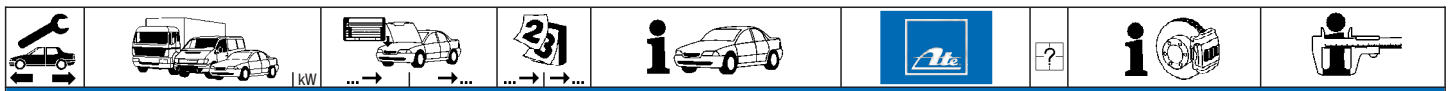

FIAT TIPO (93-95)										
	1.8 i.e.			05.93	09.95	- ABS	24.3727-0513.2	580513	<input type="checkbox"/>	L=1445
	1.9 TD			05.93	09.95	- ABS				
	1.4 i.e.			05.93	09.95	+ ABS	24.3727-0521.2	580521	<input type="checkbox"/>	L=1517
	1.6 i.e.			05.93	09.95	+ ABS	24.3727-0006.2	580006	<input type="checkbox"/>	L=1460
	1.7 D			05.93	09.95	+ ABS				
	1.8 i.e.			05.93	09.95	+ ABS				
	1.9 D			05.93	09.95	+ ABS				
1.9 TD			05.93	09.95	+ ABS					
2.0 i.e.	83			05.93	09.95					
2.0 i.e. 16V				05.93	09.95					
	1.4 i.e.			05.93	09.95		24.3728-0503.2	590503		L=729
	1.6 i.e.			05.93	09.95					
	1.7 D			05.93	09.95					
	1.8 i.e.			05.93	09.95		24.3728-0502.2	590502		L=764
	1.9 D			05.93	09.95					
	1.9 TD			05.93	09.95					
	2.0 i.e.	83			05.93	09.95				
2.0 i.e. 16V				05.93	09.95					

FIAT UNO (83-89)										
	45			03.83	12.85		24.2119-0826.3	010349		THz 19,05
	45			01.86	09.89		24.2120-0801.3	010362		THz 20,64
	1.3 D		0038672	03.83			24.2119-0827.3	010350		THz 19,05
	1.7 D		0038672	02.84						
	55		2125560	03.83						
	55		1570528	03.83						
	60		2125560	03.83						
	60		1570528	03.83						
	70		2125560	03.83						
	70		1570528	03.83						
	1.3 D	0038673			12.85		24.2119-0826.3	010349		THz 19,05
	1.7 D	0038673			12.85					
55	1570529			12.85						
55	2125561			12.85						
60	1570529			12.85						
60	2125561			12.85						
70	1570529			12.85						
70	2125561			12.85						
	1.3 D			01.86	09.89		24.2120-0801.3	010362		THz 20,64
	1.7 D			01.86	09.89					
	1.7 TD			05.86	09.89	+ ①				
	55			01.86	09.89					
	60			01.86	09.89					
	70			01.86	09.89					
	70			01.86	09.89					
	1.3 D			03.83	09.89		13.0460-3939.2	603939		20775 18,0 /WE BDX
	1.7 D			02.84	09.89		13.0460-3940.2	603940		20775 18,0 /WK BDX
	45			03.83	09.89		13.0460-0410.2	610410		Belagsatz-Zubehör BDX
	55			03.83	09.89					
	60			03.83	09.89					
	70			03.83	09.89					
	75			10.85	09.89					
	1.3 i.e. Turbo			05.85	09.89		13.0460-2941.2	602941		20839 17,0 /WK/S TRW
	1.7 TD			05.86	09.89	+ ①				
	75			10.85	09.89					
	1.3 D			03.83	09.89		24.0111-0130.1	411130		227 10,8 9,0 +B
	1.7 D			02.84	09.89					
	45			03.83	09.89					
	55			03.83	09.89					
	60			03.83	09.89					
	70			03.83	09.89					
	75			10.85	09.89					
	1.7 TD			05.86	09.89	+ ①	24.0112-0122.1	412122		240 12,0 10,8
	75			10.85	09.89					
	1.3 i.e. Turbo			05.85	09.89		24.0120-0143.1	420143		240 20,0 18,2 V
	75			05.85	09.89					
	45			03.83	09.89		24.5112-0410.3	330494	2	L=410
	55			03.83	09.89					
	1.3 i.e. Turbo			05.85	09.89		24.0111-0130.1	411130		227 10,8 9,0 +B
	75			05.85	09.89					
	1.3 D			03.83	09.89		24.5228-0200.3	330470	2	L=200
	1.7 D			02.84	09.89					
	1.7 TD			05.86	09.89	+ ①				
	45			03.83	09.89					
	55			03.83	09.89					
	60			03.83	09.89					
	70			03.83	09.89					
75			10.85	09.89						
	1.3 D			03.83	09.89		24.3219-0803.3	020183		Rz 19,05
	1.7 D			02.84	09.89					
	1.7 TD			05.86	09.89	+ ①				
	45			03.83	09.89					
	55			03.83	09.89					
	60			03.83	09.89					
↓	↓			03.83	09.89					























FIAT UNO (83-89)































	70 75			03.83 10.85	09.89 09.89		24.3219-0803.3	020183			Rz 19,05	
	1.3 D 1.7 D 1.7 TD 45 55 60 70 75			03.83 02.84 05.86 03.83 03.83 03.83 03.83 10.85	09.89 09.89 09.89 + ① 09.89 09.89 09.89 09.89 09.89		03.0137-0015.2 03.0137-9021.2	650015 669021			185 x 31 AUT Bremsbacken-Zubehör	FI FI
	1.3 D 1.7 D 1.7 TD 45 55 60 70 75			03.83 02.84 05.86 03.83 03.83 03.83 03.83 10.85	09.89 09.89 09.89 + ① 09.89 09.89 09.89 09.89 09.89		24.0218-5001.1	480012			185/186,8 x 37	
	1.3 D 1.7 D 1.7 TD 45 55 60 70 75			03.83 02.84 05.86 03.83 03.83 03.83 03.83 10.85	09.89 09.89 09.89 + ① 09.89 09.89 09.89 09.89 09.89		03.0420-0319.3	680319			19,05/185x31 Kit	FI
	1.3 D 1.7 D 1.7 TD 45 55 60 70 75			03.83 02.84 05.86 03.83 03.83 03.83 03.83 10.85	09.89 09.89 09.89 + ① 09.89 09.89 09.89 09.89 09.89		24.3727-0507.2 24.3727-0508.2	580507 580508	<input type="checkbox"/> <input type="checkbox"/>		L=521 L=2018	
	1.3 D 1.3 i.e. Turbo 1.7 D 1.7 TD 45 55 60 70 75			03.83 05.85 02.84 05.86 03.83 03.83 03.83 03.83 10.85	09.89 09.89 09.89 09.89 + ① 09.89 09.89 09.89 09.89 09.89		24.6513-0801.3	320117			BRL 1/3 (2)	
	1.3 D 1.7 D 1.7 TD 45 55 60 70 75			03.83 02.84 05.86 03.83 03.83 03.83 03.83 10.85	09.89 09.89 09.89 + ① 09.89 09.89 09.89 09.89 09.89		24.3728-0501.2	590501			L=625	

FIAT UNO (90-06)

	0.9 1.0 1.1 1.4 1.4 TD 1.5 1.6 1.7 D 1.9 TD			10.89 10.89 10.89 10.89 10.89 10.89 12.89 10.89 10.89	06.95 06.95 06.95 06.95 06.95 06.95 06.95 06.95 06.95 + ①		24.2120-0801.3	010362			THz 20,64	
	1.4 TD 1.5 1.9 TD			10.89 10.89 10.89	06.95 06.95 06.95 + ①		24.3481-1703.5 24.3481-1704.5	240051 240052	<input type="checkbox"/> <input type="checkbox"/>		D=48, - Halter D=48, - Halter	TRW TRW
	0.9 1.0 1.1 1.4 1.5 1.6 1.7 D 1.3 Turbo i.e. 1.4 TD 1.4 Turbo i.e. 1.5 1.9 TD			10.89 10.89 10.89 10.89 10.89 12.89 10.89 10.89 10.89 10.89 10.89 10.89 10.89	06.95 06.95 06.95 06.95 06.95 06.95 06.95 03.92 06.95 06.95 06.95 06.95 06.95 + ①		13.0460-3940.2 13.0460-3939.2 13.0460-0410.2	603940 603939 610410			20775 18,0 /WK 20775 18,0 /WE Belagsatz-Zubehör	BDX BDX BDX
	0.9 1.0 1.1 1.4 1.5 1.6 1.7 D			10.89 10.89 10.89 10.89 12.89 10.89	06.95 06.95 06.95 06.95 06.95 06.95		13.0460-2941.2	602941			20839 17,0 /WK/S	TRW
	0.9 1.0 1.1 1.4 1.5 1.6 1.7 D			10.89 10.89 10.89 10.89 12.89 10.89	06.95 06.95 06.95 06.95 06.95 06.95		24.0111-0130.1	411130			227 10,8 9,0 +B	

















									
FIAT UNO (90-06)									
	1.4 TD 1.5 1.9 TD 1.3 Turbo i.e. 1.4 Turbo i.e.			10.89 06.95 10.89 06.95 10.89 06.95 + ① 10.89 03.92 10.89 06.95		24.0112-0122.1 412122 24.0120-0143.1 420143		240 12,0 10,8 240 20,0 18,2 V	
	0.9 1.0 1.1 1.4 1.4 TD 1.5 1.6 1.7 D 1.9 TD			10.89 06.95 10.89 06.95 10.89 06.95 10.89 06.95 10.89 06.95 12.89 06.95 10.89 06.95 10.89 06.95 + ①		24.5112-0390.3 330517 24.5112-0386.3 330516	2 2	L=390, + Clip L=385	
	1.3 Turbo i.e. 1.4 Turbo i.e.			10.89 03.92 10.89 06.95		24.0111-0130.1 411130		227 10,8 9,0 +B	
	0.9 1.0 1.1 1.4 1.4 TD 1.5 1.7 D 1.9 TD			10.89 06.95 10.89 06.95 10.89 06.95 10.89 06.95 10.89 06.95 10.89 06.95 10.89 06.95 + ①		24.5228-0200.3 330470	2	L=200	
	0.9 1.0 1.1 1.4 1.4 TD 1.5 1.7 D 1.9 TD			10.89 06.95 10.89 06.95 10.89 06.95 10.89 06.95 10.89 06.95 10.89 06.95 10.89 06.95 + ①		24.3219-0803.3 020183		Rz 19,05	
	0.9 1.0 1.1 1.4 1.4 TD 1.5 1.7 D 1.9 TD			10.89 06.95 10.89 06.95 10.89 06.95 10.89 06.95 10.89 06.95 10.89 06.95 10.89 06.95 + ①		03.0137-0015.2 650015 03.0137-0273.2 650273 03.0137-9021.2 669021		185 x 31 AUT 185 x 31 AUT Bremsbacken-Zubehör	FI AP FI
	0.9 1.0 1.1 1.4 1.4 TD 1.5 1.7 D 1.9 TD			10.89 06.95 10.89 06.95 10.89 06.95 10.89 06.95 10.89 06.95 10.89 06.95 10.89 06.95 + ①		24.0218-5001.1 480012		185/186,8 x 37	
	0.9 1.0 1.1 1.4 1.4 TD 1.5 1.7 D 1.9 TD			10.89 06.95 10.89 06.95 10.89 06.95 10.89 06.95 10.89 06.95 10.89 06.95 10.89 06.95 + ①		03.0420-0319.3 680319 03.0520-4319.3 694319		19,05/185x31 Kit 19,05/185x31 TopKit	FI AP
	0.9 1.0 1.1 1.4 1.4 TD 1.5 1.7 D 1.9 TD		7767870 7767870 7767870 7767870 7767870 7767870 7767870	10.89 10.89 10.89 10.89 10.89 10.89 10.89 + ①		24.3727-0507.2 580507 24.3727-0508.2 580508	<input type="checkbox"/> <input type="checkbox"/>	L=521 L=2018	
	0.9 1.0 1.1 1.4 1.4 TD 1.5 1.7 D 1.9 TD	7767871 7767871 7767871 7767871 7767871 7767871 7767871		06.95 06.95 06.95 06.95 06.95 06.95 06.95 + ①		24.3727-0509.2 580509 24.3727-0518.2 580518	<input type="checkbox"/> <input type="checkbox"/>	L=523 L=2016	
	0.9 1.0 1.1 1.3 Turbo i.e. 1.4 1.4 TD 1.4 Turbo i.e. 1.5 1.7 D 1.9 TD			10.89 06.95 10.89 06.95 10.89 06.95 10.89 03.92 10.89 06.95 10.89 06.95 10.89 06.95 10.89 06.95 + ①		24.6513-0801.3 320117		BRL 1/3 (2)	

								
FIAT X 1/9 (72-89)								
	1.3 1.5			10.72 11.78	12.79 09.82	13.0460-3936.2	603936	20073 17,3 BDX
	1.3 1.5			10.72 11.78	12.79 12.89	24.0111-0130.1	411130	227 10,8 9,0 +B
	1.3 1.5			10.72 11.78	12.79 12.89	24.5209-0280.3	330044	2 L=280
	1.3 1.5			10.72 11.78	12.79 12.89	24.0111-0130.1	411130	227 10,8 9,0 +B
FORD A-Serie (73-83)								
	alle Typen			04.73	07.83	83.7704-0320.3	330851	1 <input type="checkbox"/> L=320
FORD 12M/15M (62-70)								
	12M (P4) 12M (P6) 15M (P6)			01.62 01.66 01.66	12.66 12.70 12.70	13.0441-4819.2	250104	Dichtungssatz ATE
	12M (P4) 12M (P6) 15M (P6)			01.62 01.66 01.66	12.66 12.70 12.70	13.0460-4035.2	604035	20173 15,0 ATE
FORD 17M/20M/26M (60-71)								
	17M / 20M (P5) 26M (P7)			01.64 01.69	12.67 12.71	24.3526-0810.3	340037	1 Bremslichtschalter
	17M / 20M (P5)			01.64	12.67	13.0441-4819.2	250104	Dichtungssatz ATE
	17M / 20M (P5)			01.64	12.67	13.0460-4035.2	604035	20173 15,0 ATE
	17M / 20M (P5) 26M (P7)			01.64 01.69	12.67 12.71	13.0460-6027.2	606027	20011 15,0 ATE
	17M / 20M (P5)			01.64	12.71	03.3217-0602.3	020024	Rz 17,46
FORD CAPRI (68-74)								
	1600 1700 2000 2300 2600 2600 RS 3000	55 92 110		08.72 12.68 02.69 02.69 08.70 08.70 01.70	02.74 02.74 02.74 02.74 02.74 02.74 02.74	13.0441-5409.2	250112	Dichtungssatz ATE
	1600 1700 2000 2300 2600 2600 RS 3000	55 92 110		08.72 12.68 02.69 02.69 08.70 08.70 01.70	02.74 02.74 02.74 02.74 02.74 02.74 02.74	13.0460-7042.2 13.0460-0126.2	607042 610126	20491 15,0 TRW Belagsatz-Zubehör TRW
	1600 1700 2000 2300 2600 2600 RS 3000	55 92 110		08.72 12.68 02.69 02.69 08.70 08.70 01.70	02.74 02.74 02.74 02.74 02.74 02.74 02.74	24.0113-0118.1	413118	245 12,7 11,4
FORD CAPRI (74-86)								
	alle Typen			02.74	06.85 + Bremsgerät/ - 2,8 i ¹⁾	03.2120-0148.3	010070	Thz 20,64 + Behälter ATE
	1.3 3.0 alle Typen			01.75 02.78 02.74	12.82 12.86 12.86 - 2,8 i	13.0441-5409.2	250112	Dichtungssatz ATE
	2.8 i			02.81	12.86	13.0441-5409.2	250112	Dichtungssatz ATE
	1.3 3.0 alle Typen			01.75 02.78 02.74	12.82 12.86 12.86 - 2,8 i	13.0460-7042.2 13.0460-0126.2	607042 610126	20491 15,0 TRW Belagsatz-Zubehör TRW
	1.3 alle Typen			01.75 02.74	12.82 12.86 - 2,8 i/ - 3,0	24.0113-0118.1	413118	245 12,7 11,4
	1.3 1.3 alle Typen 2.8 i	40 44		01.78 11.74 11.74 02.81	12.82 12.82 12.86 - 2,8 i 12.86	24.3219-0903.3 24.3217-1706.3 24.3219-0903.3	020184 020044 020184	8" Bremse ²⁾ Rz 19,05 9" Bremse ³⁾ Rz 17,78 Rz 19,05

¹⁾ + booster unit/ - 2,8 i / + servofreno/ - 2,8 i / + servo-frein/ - 2,8 i / + servofreno/ - 2,8 i

²⁾ 8" brake / servofreno da 8" / frein de 8" / freno de 8"













³⁾ 9" brake / servofreno da 9" / frein de 9" / freno de 9"

        											
FORD CAPRI (74-86)											
	1.3 2.8 i 3.0	40		02.74 02.81 02.78	12.82 12.82 09.81		24.0220-3001.2 24.0222-8010.2	480020 480027	203/204 x 45 229/229,4 x 64		
FORD CONSUL / GRANADA (72-85)											
	1.7 Kombi 1.7 Lim. 2.0 Kombi 2.0 Lim. 2.0 Kombi 2.0 Lim. 2.1 D Lim. 2.3 Kombi 2.3 Lim. 2.5 D Kombi 2.5 D Lim. 2.8 i Kombi 2.8 i Lim. 2.8 Kombi 2.8 Lim.			02.72 02.72 02.72 02.72 08.81 08.81 08.81 08.81 08.81 08.82 08.82 08.81 08.81 08.81 08.81	05.73 05.73 05.73 05.73 06.85 06.85 12.83 06.85 06.85 06.85 06.85 06.85 06.85 06.85 06.85		03.2120-5503.3 03.2123-8611.3	010124 010195	Anschlagschraube oben ¹⁾ THz 20,64 + Behälter THz 23,81	ATE ATE	
	1.6 Lim. 1.7 Kombi 1.7 Lim. 1.9 D Lim. 2.0 Kombi 2.0 Kombi 2.0 Lim. 2.0 Lim. 2.1 D Lim. 2.3 Kombi 2.3 Lim.		66 66	08.81 11.74 11.74 08.77 11.74 01.75 11.74 09.74 08.77 11.74 11.74	12.83 07.81 07.81 12.79 06.85 06.85 06.85 08.85 12.83 06.85 06.85		13.0441-5409.2	250112	Dichtungssatz	ATE	
	1.6 Lim. 1.7 Kombi 1.7 Lim. 1.9 D Lim. 2.0 Kombi 2.0 Kombi 2.0 Lim. 2.0 Lim. 2.1 D Lim. 2.3 Kombi 2.3 Lim.		66 66	08.81 11.74 11.74 08.77 11.74 01.75 11.74 09.74 08.77 11.74 11.74	12.83 07.81 07.81 12.79 06.85 06.85 06.85 08.85 12.83 06.85 06.85		13.0460-7042.2 13.0460-0126.2	607042 610126	20491 15,0 Belagsatz-Zubehör	TRW TRW	
	1.7 Lim. 1.9 D Lim. 2.0 Lim. 2.1 D Lim. 2.3 Kombi 2.3 Lim. 2.6 Kombi 2.6 Lim. 3.0 Kombi 3.0 Lim.			02.72 08.77 08.77 08.77 08.77 08.77 08.77 08.77 08.77 08.77	04.79 04.79 + DK (N S FIN) 04.79 + 4 Zylinder ²⁾ 04.79 + DK (N S FIN) 04.79 + DK (N S FIN) 04.79 + DK (N S FIN) 04.79 + DK (N S FIN) 04.79 + DK (N S FIN) 04.79 + DK (N S FIN) 04.79 + DK (N S FIN) 04.79 + DK (N S FIN)		24.3220-1112.3	020223	Rz 20,64		
	1.7 Kombi 1.9 D Lim. 2.0 Kombi 2.0 Lim. 2.1 D Lim. 2.3 Kombi 2.3 Lim. 2.6 Kombi 2.6 Lim. 2.8 i Kombi 2.8 i Lim. 2.8 Kombi 2.8 Lim. 3.0 Kombi 3.0 Lim.		66	02.72 08.77 02.72 02.72 08.77 02.72 02.72 02.72 02.72 08.77 08.77 08.77 08.77 02.72 02.72	04.79 04.79 - DK (N S FIN) 04.79 - DK (N S FIN) 04.79 - DK (N S FIN) 04.79 - DK (N S FIN) 04.79 - DK (N S FIN) 04.79 - DK (N S FIN) 04.79 - DK (N S FIN) 04.79 - DK (N S FIN) 04.79 - DK (N S FIN) 04.79 - DK (N S FIN) 04.79 - DK (N S FIN) 04.79 - DK (N S FIN) 02.76 02.76		24.3219-1107.3	020338	nur paarweise austauschen ³⁾	Rz 19,05	TRW
	1.7 Kombi 1.7 Lim. 1.9 D Lim. 2.0 Kombi 2.0 Lim. 2.1 D Lim. 2.3 Kombi 2.3 Lim. 2.8 i Kombi 2.8 i Lim. 2.8 Kombi 2.8 Lim.		66	05.79 05.79 05.79 05.79 05.79 05.79 05.79 05.79 05.79 05.79 05.79 05.79	07.81 + DK (FIN) 07.81 + DK (FIN) 07.81 + DK (FIN) 07.81 + DK (FIN) 07.81 + DK (FIN) 07.81 + DK (FIN) 07.81 + DK (FIN) 07.81 + DK (FIN) 07.81 + DK (FIN) 07.81 + DK (FIN) 07.81 + DK (FIN) 07.81 + DK (FIN)		24.3219-1107.3	020338	nur paarweise austauschen ³⁾	Rz 19,05	TRW
	1.7 Kombi 1.7 Lim. 1.9 D Lim. 2.0 Kombi 2.0 Lim. 2.1 D Lim. 2.3 Kombi 2.3 Lim.		66	05.79 05.79 05.79 05.79 05.79 05.79 05.79 05.79	07.81 - DK (FIN) 07.81 - DK (FIN) 07.81 - DK (FIN) 07.81 - DK (FIN) 07.81 - DK (FIN) 07.81 - DK (FIN) 07.81 - DK (FIN) 07.81 - DK (FIN)		24.3220-1112.3	020223	Rz 20,64		

¹⁾ stop screw, top / vite di fermo in alto / vis de butée en haut / tornillo tope arriba

²⁾ + 4 cylinder / + 4 cilindro / + 4 cylindre / + 4 cilindro

³⁾ to change only by pairs / sostituire solo a coppie / à changer seulement par paires / cambiar solamente por parejas

FORD CONSUL / GRANADA (72-85)									
	2.3 Lim. 2.8 i Kombi 2.8 i Lim. 2.8 Kombi 2.8 Lim.		05.79 05.79 05.79 05.79 05.79	07.81 07.81 07.81 07.81 07.81	- (OK) (FIN) - (OK) (FIN) - (OK) (FIN) - (OK) (FIN) - (OK) (FIN)	24.3220-1112.3	020223		Rz 20,64
	1.6 Lim. 1.9 D Lim. 2.0 Kombi 2.0 Lim. 2.1 D Lim. 2.3 Kombi 2.3 Lim. 2.5 D Kombi 2.5 D Lim. 2.8 i Kombi 2.8 i Lim. 2.8 Kombi 2.8 Lim.		08.81 08.81 08.81 08.81 08.81 08.81 08.81 08.81 08.81 08.81 08.81 08.81 08.81	08.85 08.82 08.85 08.85 08.82 08.85 08.85 08.85 08.85 08.85 08.85 08.85 08.85		24.3222-1117.3	020272		Rz 22,20
	1.7 Lim. 1.9 D Lim. 2.0 Lim. 2.1 D Lim. 2.3 Lim. 2.5 Lim. 2.8 i Lim. 2.8 Lim. 3.0 Lim.		02.72 02.72 02.72 02.72 02.72 02.72 02.72 02.72 02.72	04.79 04.79 04.79 04.79 04.79 12.74 04.79 04.79 02.76		03.0137-9013.2	669013		Bremsbacken-Zubehör TRW
	1.7 Kombi 2.0 Kombi 2.3 Kombi 2.5 Kombi 2.8 i Kombi 2.8 Kombi 3.0 Kombi		02.72 02.72 02.72 02.72 02.72 02.72 02.72	04.79 04.79 04.79 02.76 04.79 04.79 02.76		03.0137-0036.2 03.0137-9013.2	650036 669013		254 x 57 Bremsbacken-Zubehör TRW
FORD ECONOVAN (85-92)									
	1.4 2.0 D		09.85 02.86	03.92 03.92		13.0460-5806.2	605806		20002 15,0 +/WK
FORD ESCORT (70-80)									
	alle Typen	◀	12.74	09.78	VA-Scheibenbremse/+ Bremsgerät ¹⁾	03.2119-0525.3	010046		THz 19,05 + Behälter ATE
	alle Typen	◀	10.78	07.80	+ Bremsgerät/ + Kent-Motor ²⁾	03.2119-0525.3	010046		THz 19,05 + Behälter ATE
	alle Typen	◀	10.78	07.80	+ Bremsgerät/ + Taunus-Motor ³⁾	03.2120-0148.3	010070		THz 20,64 + Behälter ATE
	RS 2000	◀	08.75	07.80		03.2120-0148.3	010070		THz 20,64 + Behälter ATE
	alle Typen		12.74	07.80		13.0441-5409.2	250112		Dichtungssatz ATE
	alle Typen		12.74	07.80		13.0460-7042.2 13.0460-0126.2	607042 610126		20491 15,0 Belagsatz-Zubehör TRW
	alle Typen RS 2000		12.74 03.75	07.80 07.80	- RS 2000	24.0113-0122.1 24.0113-0118.1	413122 413118		248 12,7 11,4 245 12,7 11,4
	alle Typen 1.3 1.6 1.3 RS 2000	51 51	12.74 12.74 12.74 03.75	04.76 11.75 07.80 07.80	VA-Trommelbremse ⁴⁾	24.3219-0903.3 24.3217-1706.3	020184 020044		Rz 19,05 Rz 17,78 Rz 19,05
	1.0 Lim. 1.1 Lim. 1.3 Lim.	57	09.70 09.70 09.70	07.80 07.80 07.80		24.0220-3001.2	480020		203/204 x 45
FORD ESCORT / ORION (81-85)									
	alle Typen	◀	02.84	12.85	+ Bremsgerät/- Turbo/-Kastenw. ⁵⁾	24.2122-1712.3	010462		THz 22,20
	1.1 1.3 1.6 D 1.6 XR3 XR3i 1.6 RS Turbo		08.80 08.80 08.80 08.80 08.80 09.82 09.84	12.85 12.85 12.85 12.85 10.82 12.85 12.85		11.0441-5402.2 11.0101-5407.2 11.8171-0008.1 11.0441-5402.2 11.0101-5407.2 11.8171-0008.1 11.0441-6003.2 11.0101-5407.2 11.8171-0008.1 11.8116-0052.1	250028 260011 990049 250028 260011 990049 250037 260011 990049 390496		Dichtungssatz ATE Hülssensatz ATE Führungsbolzen ATE Dichtungssatz ATE Hülssensatz ATE Führungsbolzen ATE Dichtungssatz ATE Hülssensatz ATE Führungsbolzen ATE Haltefeder ATE
	alle Typen 1.6 RS Turbo		08.80 09.84	12.85 12.85	- Turbo	13.0460-7071.2 13.0460-7027.2 13.0460-7040.2	607071 607027 607040		20640 17,5 + 20783 17,5 +/WK 20907 18,0 +

1) FA disc brake/ + booster unit / A disco freno/ + servofreno / fr.à disque ess.AV/ + servofr. / ED disco de freno/ + servofreno
2) + booster unit/ + Kent engine / + servofreno/ + motore Kent / + servo-frein/ + moteur Kent / + servofreno/ + motor Kent
3) + booster unit/ + Taunus engine / + servofreno/ + motore Taunus / + servo-frein/ + moteur Taunus / + servofreno/ + motor Taunus
4) FA drum brake / A freno a tamburo / frein à tambour essieu AV / ED tambores de freno
5) + booster unit/- Turbo/- Van / + servofreno/ - Turbo/ - furgone / + servo-frein/ - Turbo/ - fourgonnette / + servofreno/ - Turbo/ - furgón

FORD ESCORT / ORION (81-85)											
	1.1			08.80	12.85		24.0110-0193.1	410193			240 10,2 8,7
	1.3			08.80	12.85						
	1.6 D			08.80	12.85						
	1.6 XR3			08.80	12.85	- Turbo	24.0124-0112.1	424112			240 24,2 22,2 V +B
	XR3i			08.80	10.82						
	1.6 RS Turbo			09.82	12.85		24.0124-0113.1	424113			260 24,2 22,2 V
	alle Typen			05.83	12.85		24.5305-0370.3	331392	2		L=370
	alle Typen			02.82	12.85	- Kastenwagen ¹⁾	83.6339-0253.3	330362			L=250 L=225
							83.6339-0228.3	330361			
	alle Typen			08.80	02.83	- Kastenwagen/ - XR3i ²⁾	24.3219-1107.3	020338		nur paarweise austauschen ³⁾	Rz 19,05 TRW
	alle Typen			03.83	12.85	- Kastenwagen ¹⁾	24.3219-1107.3	020338		nur paarweise austauschen ³⁾	Rz 19,05 TRW
	XR3i			09.82	12.85						
	Kastenwagen			08.80	12.85		24.3222-1117.3	020272			Rz 22,20
	alle Typen			08.80	12.85	- Kastenwagen/ - XR3i/ - Turbo ⁴⁾	03.0137-0138.2	650138			180 x 32 HEB
							03.0137-9043.2	669043			Bremsbacken-Zubehör
	Kastenwagen			08.80	12.85						Bremsbacken-Zubehör
	XR3i			09.82	12.85		03.0137-9122.2	669122			
	alle Typen			08.80	12.85	- Kastenwagen/ - XR3i/ - Turbo ⁴⁾	24.0218-0010.2	480005		ohne Sensorring ⁵⁾	180/181,3 x 41,5
	Kastenwagen			08.80	12.85		24.0220-3001.2	480020			203/204 x 45
	XR3i			09.82	12.85						
	alle Typen			08.80	02.83	- Kastenwagen/ - XR3i ²⁾	03.0520-0219.3	690219			19,05/180x32 TopKit TRW
	alle Typen			08.84	12.85	- Kastenwagen ¹⁾	24.3727-0628.2	580628	1		L=151
	alle Typen			08.80	12.85	- XR3i	24.3728-0615.2	590615			L=1210

FORD ESCORT / ORION (86-90)											
	alle Typen			01.86	07.88	- SCS/ - Turbo	24.2122-1712.3	010462			THz 22,20
	alle Typen			01.86	07.88	+ SCS/ - Turbo	24.2122-0906.3	010378			THz 22,20
	1.1			01.86	08.90		11.0441-5402.2	250028			Dichtungssatz
	1.3			01.86	08.90	- SCS	11.0101-5407.2	260011			Hülssensatz
	1.6 D			01.86	03.89	- SCS	11.8171-0008.1	990049			Führungsbolzen
	1.3			01.86	08.90	+ SCS	11.0441-5402.2	250028			Dichtungssatz
	1.4			01.86	08.90		11.0101-5407.2	260011			Hülssensatz
	1.6			01.86	08.90		11.8171-0008.1	990049			Führungsbolzen
	1.6 D			01.86	03.89	+ SCS					
	1.8 D			04.89	08.90						
	XR3i			01.86	08.90						
	1.6 RS Turbo			01.86	08.90		11.0441-6003.2	250037			Dichtungssatz
						11.0101-5407.2	260011			Hülssensatz	
						11.8171-0008.1	990049			Führungsbolzen	
						11.8116-0052.1	390496	2		Haltefeder	
	1.1			01.86	08.90		13.0460-7071.2	607071			20640 17,5 +
	1.6			01.86	08.90						ATE
	alle Typen			01.86	08.90	- Turbo					ATE
	XR3i			01.86	08.90						ATE
	1.6 RS Turbo			01.86	08.90		13.0460-7040.2	607040			20907 18,0 +
											ATE
	1.1			01.86	08.90		24.0110-0193.1	410193			240 10,2 8,7
	1.3			01.86	08.90	- SCS					
	1.6 D			01.86	03.89	- SCS					
	1.3			01.86	08.90	+ SCS	24.0124-0112.1	424112			240 24,2 22,2 V +B
	1.4			01.86	08.90						
	1.6			01.86	08.90	- Turbo					
	1.6 D			01.86	03.89	+ SCS					
	1.8 D			04.89	08.90						
	XR3i			01.86	08.90						
	1.6 RS Turbo			01.86	08.90		24.0124-0113.1	424113			260 24,2 22,2 V
	alle Typen			01.86	08.90		24.5305-0370.3	331392	2		L=370
	alle Typen			01.86	08.90	- Kastenwagen ¹⁾	83.6339-0253.3	330362			L=250
							83.6339-0228.3	330361			L=225
	alle Typen			01.86	08.90	- SCS/ - Turbo/ - Kastenwagen ⁶⁾	24.3219-1107.3	020338		nur paarweise austauschen ³⁾	Rz 19,05 TRW
	alle Typen			01.86	08.90	+ SCS/ - Turbo	24.3222-1117.3	020272			Rz 22,20
	Kastenwagen			01.86	08.90						
	alle Typen			01.86	08.90	- SCS/ - Turbo/ - Kastenwagen ⁶⁾	03.0137-0138.2	650138			180 x 32 HEB
							03.0137-9043.2	669043			Bremsbacken-Zubehör
	alle Typen			01.86	08.90	+ SCS/ - Turbo	03.0137-9122.2	669122			Bremsbacken-Zubehör
	Kastenwagen			01.86	08.90						
	1.6 RS Turbo			01.86	08.90		03.0137-9043.2	669043			Bremsbacken-Zubehör

¹⁾ - Van / - furgone / - fourgonnette / - furgón

²⁾ - Van/ - XR3i / - furgone/ - XR3i / - fourgonnette/ - XR3i / - furgón/ - XR3i

³⁾ to change only by pairs / sostituire solo a coppie / à changer seulement par paires / cambiar solamente por parejas

⁴⁾ - Van/ - XR3i/ - Turbo / - furgone/ - XR3i/ - fourgonnette/ - XR3i/ - furgón/ - XR3i/ - Turbo

⁵⁾ without sensor ring / senza sensori / sans secours ABS / sin anillo sensor ABS

⁶⁾ - SCS/ - Turbo/ - Van / - SCS/ - Turbo/ - furgone / - SCS/ - Turbo/ - fourgonnette / - SCS/ - Turbo/ - furgón



FORD ESCORT / ORION (86-90)

	alle Typen		01.86	08.90	- SCS/ - Turbo/ - Kastenwagen ¹⁾	24.0218-0010.2	480005	ohne Sensorring ²⁾	180/181,3 x 41,5
	alle Typen		01.86	08.90	+ SCS/ - Turbo	24.0220-3001.2	480020		203/204 x 45
	Kastenwagen		01.86	08.90					
	alle Typen		01.86	08.90	- SCS/ - Turbo/ - Kastenwagen ¹⁾	03.0520-0219.3	690219		19,05/180x32 TopKit TRW
	1.1 alle Typen		01.86	08.90	- SCS/ - Kastenwagen/ - XR3i ³⁾	24.3727-0628.2	580628	1	L=151
			01.86	08.90	- SCS/ - Kastenwagen/ - XR3i ³⁾	24.3727-0625.2	580625	1	L=2942
	1.6 RS Turbo alle Typen		01.86	08.90		24.3727-0628.2	580628	1	L=151
	XR3i		01.86	08.90	+ SCS/ - Kastenwagen ⁴⁾	24.3727-0622.2	580622	1	L=2965
	1.1		01.86	04.86		24.3728-0615.2	590615		L=1210
	1.1		02.87	08.90					
	1.3		01.86	04.86					
	1.3		02.87	08.90					
	1.4		01.86	04.86					
	1.4		02.87	08.90	mit geregeltm Katalysator ⁵⁾				
	1.6		01.86	04.86					
	1.6		02.87	08.90					
	1.6 D		01.86	04.86					
	1.6 D		02.87	07.88					
	XR3i		01.86	04.86					
	1.4		02.87	08.90	ohne geregelten Katalysator ⁶⁾	24.3728-0622.2	590622		L=1360
	1.6 D		08.88	03.89					
	1.8 D		04.89	08.90					
	XR3i		02.87	08.90					

FORD ESCORT / ORION (91-94)

	1.3 1.4 1.6 1.8 D 1.8 TD 2.0 RS Cosworth T. alle Typen RS 2000 RS 2000 4x4	66	09.90	01.95		24.2123-1606.3	010386	- ABS	Thz 23,81
	1.1 1.3 Kastenw. 1.3 Kombi 1.3 Lim. 1.4 1.6 1.8 D 1.8 i 16V 1.8 TD	77	09.90	01.95	+ ABS	24.3541-1707.5 24.3541-1708.5 24.0101-5401.2	240067 240068 260059		D=54, - Halter BDX D=54, - Halter BDX Bremsmittel-Zubehör BDX
	1.8 i 16V RS 2000	96	01.92	01.95		11.0441-6007.2 11.0101-5407.2	250146 260011		Dichtungssatz ATE Hülssensatz ATE Führungsbolzen ATE
	RS 2000 4x4		05.91	01.95		11.8171-0008.1	990049		
	2.0 RS Cosworth T.		09.92	01.95		11.0441-6007.2 11.0101-5407.2 11.8171-0008.1 11.8116-0073.1	250146 260011 990049 390498	2	Dichtungssatz ATE Hülssensatz ATE Führungsbolzen ATE Haltefeder ATE
	1.1 1.3 1.4 1.6 1.8 D 1.8 i 16V 1.8 TD	77	09.90	01.95		13.0460-3965.2 13.0460-0412.2 13.0460-0413.2	603965 610412 610413	+ Feder ⁸⁾ - ABS + ABS	23300 18,0 + BDX Belagsatz-Zubehör BDX Belagsatz-Zubehör BDX
	1.8 i 16V RS 2000 RS 2000 4x4	96	01.92	01.95		13.0460-7040.2	607040		20907 18,0 + ATE
	2.0 RS Cosworth T.		09.92	01.95		13.0460-7165.2	607165		21358 19,8 + ATE
	1.1 1.3 Lim.		09.90	01.95	- ABS	24.0110-0196.1	410196		240 10,0 8,0 +B
	1.1 1.3 Kastenw. 1.3 Kombi 1.3 Lim. 1.4 1.6 1.8 D 1.8 i 16V 1.8 TD	77	09.90	01.95	+ ABS	24.0120-0147.1 24.0320-0147.1	420147 520147		240 20,0 18,0 V +B 240 20,0 18,0 V +B PD
	1.8 i 16V RS 2000 RS 2000 4x4	96	01.92	01.95		24.0124-0125.1	424125		260 24,2 22,2 V
	2.0 RS Cosworth T.		09.92	01.95		24.0124-0148.1	424148		278 24,0 22,2 V
	alle Typen		09.90	01.95		24.5129-0395.3 24.5129-0396.3	330582 330583		L=395 L=395
	1.3 1.4 1.8 D		09.90	01.95		24.0711-1323.1	360019	2	Radsensor L=902

1) - SCS/ - Turbo/ - Van / - SCS/ - Turbo/ - furgone / - SCS/ - Turbo/ - fourgonnette / - SCS/ - Turbo/ - furgón
2) without sensor ring / senza sensori / sans secours ABS / sin anillo sensor ABS
3) - SCS/ - Van/ - XR3i / - SCS/ - furgone/ - XR3i / - SCS/ - fourgonnette/ - XR3i / - SCS/ - furgón/ - XR3i
4) + SCS/ - Van / + SCS/ - furgone / + SCS/ - fourgonnette / + SCS/ - furgón
5) with controlled catalytic conv. / con regolazione del catalizzatore / avec catalyseur réglé / con catalizador regulado
6) uncontrolled catalytic conv. / senza regolazione del catalizzatore / sauf catalyseur réglé / sin catalizador regulado
7) - ABS/ - 1,8 i-16V / - ABS/ - 1,8 i-16V / - ABS/ - 1,8 i-16V / - ABS/ - 1,8 i-16V
8) + spring / + molla / + ressort / + muelle





FORD ESCORT / ORION (91-94)

	1.8 TD			02.93	01.95		24.0711-1323.1	360019	2		Radsensor L=902
	1.6 1.8 D 1.8 i 16V 1.8 TD RS 2000			09.90 09.90 01.92 02.93 05.91	01.95 + ABS 01.95 + ABS 01.95 + ABS 01.95 + ABS 01.95		13.0460-4058.2 13.0460-0436.2	604058 610436			21832 14,9 Belagsatz-Zubehör ATE ATE
	1.6 1.8 D 1.8 i 16V 1.8 TD RS 2000			09.90 09.90 01.92 02.93 05.91	01.95 + ABS 01.95 + ABS 01.95 + ABS 01.95 + ABS 01.95		24.0110-0213.1	410213			270 10,0 8,6
	1.4 alle Typen			09.90 09.90	01.95 01.95		24.5303-0455.3	330588	2		L=455
	1.6 1.8 i 16V RS 2000			09.90 01.92 05.91	01.95 01.95 01.95		24.0711-1333.3	360020	2		Radsensor L=952
	1.1 1.3 Lim. 1.4 Lim. 1.3 Kombi 1.4 Cabrio 1.4 Kombi 1.4 Lim. 1.6 1.8 D 1.8 i 16V 1.8 TD			09.90 09.90 09.90 09.90 09.90 09.90 01.92 02.93	01.95 - ABS 01.95 - ABS 01.95 - ABS/ + Schaltgetriebe ¹⁾ 01.95 - ABS 01.95 - ABS 01.95 - ABS/ + Automatikgetriebe ³⁾ 01.95 - ABS 01.95 - ABS/ - Kastenwagen ⁴⁾ 01.95 - ABS 01.95 - ABS		24.3220-1112.3 24.3219-1107.3	020223 020338			Rz 20,64 Rz 19,05 TRW
	1.1 1.3 1.4 1.4 Kastenw. 1.8 D Kastenw.			09.90 09.90 09.90 09.90 09.90	01.95 + ABS 01.95 + ABS 01.95 + ABS 01.95 01.95 - ABS		24.3222-1117.3	020272			Rz 22,20
	1.1 1.3 Lim. 1.4 Lim. 1.1 1.3 Lim. 1.4 Lim.			09.90 09.90 09.90 01.94 01.94 01.94	12.93 - ABS 12.93 - ABS 12.93 - ABS/ + Schaltgetriebe ¹⁾ 01.95 - ABS 01.95 - ABS 01.95 - ABS/ + Schaltgetriebe ¹⁾		03.0137-0237.2 03.0137-0237.2 03.0137-9217.2	650237 650237 669217			180 x 32 HEB 180 x 32 HEB Bremsbacken-Zubehör TRW
	1.1 1.3 1.3 Kombi 1.4 1.4 Cabrio 1.4 Kombi 1.4 Lim. 1.6 1.8 D 1.8 i 16V 1.8 TD			09.90 09.90 09.90 09.90 09.90 09.90 01.92 02.93	12.93 + ABS 12.93 + ABS 12.93 - ABS 12.93 + ABS 12.93 - ABS 12.93 - ABS 12.93 - ABS/ + Automatikgetriebe ³⁾ 12.93 - ABS 12.93 - ABS/ - Kastenwagen ⁴⁾ 12.93 - ABS 12.93 - ABS		03.0137-0238.2 03.0137-9124.2	650238 669124			203 x 38 HEB Bremsbacken-Zubehör
	1.1 1.3 1.3 Kombi 1.4 1.4 Cabrio 1.4 Kombi 1.4 Lim. 1.6 1.8 D 1.8 i 16V 1.8 TD			01.94 01.94 01.94 01.94 01.94 01.94 01.94 01.94 01.94 01.94	01.95 + ABS 01.95 + ABS 01.95 - ABS 01.95 + ABS 01.95 - ABS 01.95 - ABS 01.95 - ABS/ + Automatikgetriebe ³⁾ 01.95 - ABS 01.95 - ABS/ - Kastenwagen ⁴⁾ 01.95 - ABS 01.95 - ABS		03.0137-0238.2 03.0137-9251.2	650238 669251			203 x 38 HEB Bremsbacken-Zubehör
	1.4 Kastenw. 1.8 D Kastenw.			09.90 09.90	01.95 01.95 - ABS		03.0137-0282.2 03.0137-9184.2	650282 669184			229 x 45 HEB Bremsbacken-Zubehör
	1.1 1.3 Lim. 1.4 Lim. 1.1 1.3 1.3 Kombi 1.4 1.4 Cabrio 1.4 Kombi 1.4 Lim. 1.6 1.8 D 1.8 i 16V 1.8 TD			09.90 09.90 09.90 09.90 09.90 09.90 09.90 01.92 02.93	01.95 - ABS 01.95 - ABS 01.95 - ABS/ + Schaltgetriebe ¹⁾ 01.95 + ABS 01.95 + ABS 01.95 - ABS 01.95 + ABS 01.95 - ABS 01.95 - ABS 01.95 - ABS/ + Automatikgetriebe ³⁾ 01.95 - ABS 01.95 - ABS/ - Kastenwagen ⁴⁾ 01.95 - ABS 01.95 - ABS		24.0218-0024.2 24.0218-0724.2	480079 480206			ohne Sensorring ⁵⁾ ohne Sensorring ⁵⁾ 180/181,3 x 44 - Lager 180/181,3 x 44 + Lager
	1.1 1.3 1.3 Kombi 1.4 1.4 Cabrio 1.4 Kombi 1.4 Lim. 1.6 1.8 D 1.8 i 16V 1.8 TD			09.90 09.90 09.90 09.90 09.90 09.90 09.90 01.92 02.93	01.95 + ABS 01.95 + ABS 01.95 - ABS 01.95 + ABS 01.95 - ABS 01.95 - ABS 01.95 - ABS/ + Automatikgetriebe ³⁾ 01.95 - ABS 01.95 - ABS/ - Kastenwagen ⁴⁾ 01.95 - ABS 01.95 - ABS		24.0220-3004.2	480023			ohne Sensorring ⁵⁾ 203/204 x 49
	1.1 1.3 Lim. 1.4 Lim. 1.1 1.3 Lim. 1.4 Lim.			09.90 09.90 09.90 01.94 01.94 01.94	12.93 - ABS 12.93 - ABS 12.93 - ABS/ + Schaltgetriebe ¹⁾ 01.95 - ABS 01.95 - ABS 01.95 - ABS/ + Schaltgetriebe ¹⁾		03.0520-2120.3 03.0520-7020.3	692120 697020			20,64/180x32 TopKit 20,64/180x32 TopKit TRW TRW

1) - ABS/ + manual transmission / - ABS/+ scatola camb.velocità / - ABS/ + transmission mécanique / - ABS/ + cambio de velocidad
2) to change only by pairs / sostituire solo a coppie / à changer seulement par paires / cambiar solamente por parejas
3) - ABS/ + autom.transmission / - ABS/ + scatola cambio autom. / - ABS/ + transmission automatique / - ABS/ + cambio automático
4) - ABS/ - Van / - ABS/ - furgone / - ABS/ - fourgonnette / - ABS/ - furgón
5) without sensor ring / senza sensori / sans secours ABS / sin anillo sensor ABS

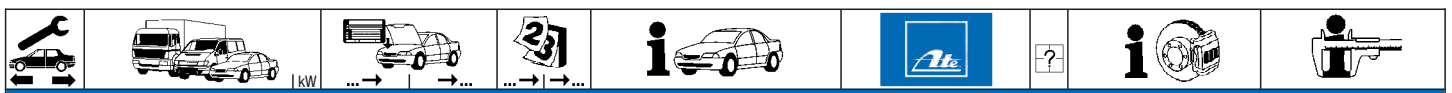

FORD ESCORT / ORION (91-94)

	1.1			01.94	01.95	+ ABS	03.0520-6122.3	696122		22,20/203x38 TopKit	TRW
	1.3			01.94	01.95	+ ABS					
	1.4			01.94	01.95	+ ABS					
	1.3 Kombi			09.90	12.93	- ABS	03.0520-1119.3	691119		19,05/203x38 TopKit	TRW
	1.4 Cabrio			09.90	12.93	- ABS					
	1.4 Kombi			09.90	12.93	- ABS					
	1.4 Lim.			09.90	12.93	- ABS/ + Automatikgetriebe ¹⁾					
	1.6			09.90	12.93	- ABS					
	1.8 D			09.90	12.93	- ABS/ - Kastenwagen ²⁾					
	1.8 i 16V	77		01.92	12.93	- ABS					
	1.8 TD			02.93	12.93	- ABS					
	1.3 Kombi			01.94	01.95	- ABS	03.0520-5619.3	695619		19,05/203x38 TopKit	TRW
	1.4 Cabrio			01.94	01.95	- ABS					
	1.4 Kombi			01.94	01.95	- ABS					
	1.4 Lim.			01.94	01.95	- ABS/ + Automatikgetriebe ¹⁾					
	1.6			01.94	01.95	- ABS					
	1.8 D			01.94	01.95	- ABS/ - Kastenwagen ²⁾					
	1.8 i 16V	77		01.94	01.95	- ABS					
	1.8 TD			01.94	01.95	- ABS					
	1.6			09.90	01.95	+ ABS	03.0137-9701.2	669701		Bremsbacken-Zubehör	
	1.8 D			09.90	01.95	+ ABS					
	1.8 i 16V			01.92	01.95	+ ABS					
	1.8 TD			02.93	01.95	+ ABS					
	RS 2000			05.91	01.95						
	1.3			09.90	01.95		24.3727-0628.2	580628	1	↑	L=151
	1.4			09.90	01.95						
	1.6			09.90	01.95						
	1.8 D			09.90	01.95						
	1.8 i 16V			09.91	01.95						
	1.8 TD			02.93	01.95						
	alle Typen			09.90	01.95						
	1.3			09.90	01.95	- Kastenwagen/- Cosworth/- RS2000 ³⁾	24.3727-0627.2	580627	1	↓	L=3273
	1.4			09.90	01.95	- Kastenwagen/- Cosworth/- RS2000 ³⁾					
	1.6			09.90	01.95	- Kastenwagen/- Cosworth/- RS2000 ³⁾					
	1.8 D			09.90	01.95	- Kastenwagen/- Cosworth/- RS2000 ³⁾					
	1.8 i 16V			09.91	01.95	- Kastenwagen/- Cosworth/- RS2000 ³⁾					
	1.8 TD			02.93	01.95	- Kastenwagen/- Cosworth/- RS2000 ³⁾					
	alle Typen			09.90	01.95	- Kastenwagen/- Cosworth/- RS2000 ³⁾					

FORD FIESTA (76-89)

	1.0			06.76	07.83	+ Bremsgerät ⁴⁾	24.2119-0905.3	010353		THz 19,05	
	1.1			06.76	07.83	+ Bremsgerät ⁴⁾					
	1.3			09.77	07.83	+ Bremsgerät ⁴⁾					
	1.0		◀	08.83	04.89	+ Bremsgerät ⁴⁾	24.2120-0905.3	010364		THz 20,64	
1.1		◀	08.83	04.89	+ Bremsgerät ⁴⁾						
1.3		◀	08.83	08.86	+ Bremsgerät ⁴⁾						
1.4		◀	01.86	04.89	+ Bremsgerät ⁴⁾						
1.6 D		◀	03.84	04.89	+ Bremsgerät ⁴⁾						
	1.0			08.83	04.89		11.0441-4805.2	250020		Dichtungssatz	ATE
	1.1			08.83	04.89		11.0101-5407.2	260011		Hülssensatz	ATE
	1.3			08.83	08.86		11.8171-0008.1	990049		Führungsbolzen	ATE
	1.4			01.86	04.89						
	1.6 D			03.84	04.89						
	1.6 XR2			09.81	04.89		24.3541-1701.5	240005	◻	D=54, - Halter	ATE
							11.0441-5402.2	250028		Dichtungssatz	ATE
							11.0101-5407.2	260011		Hülssensatz	ATE
							11.8171-0008.1	990049		Führungsbolzen	ATE
	1.0			08.83	04.89		13.0460-7005.2	607005		20857 17,5 +	ATE
	1.1			08.83	04.89						
	1.3			08.83	08.86						
	1.4			01.86	04.89						
	1.6 D			03.84	04.89						
	1.6 XR2			09.81	04.89		13.0460-7071.2	607071		20640 17,5 +	ATE
							24.0110-0148.1	410148		221 10,0 8,7	
	1.0			06.76	07.83	- Bremskraftregler ⁵⁾	24.3215-1104.3	020158		Rz 15,87	
	1.1			06.76	07.83	- Bremskraftregler ⁵⁾					
	1.0			08.83	04.89		24.3217-1114.3	020177		Rz 17,46	
	1.1			08.83	04.89						
	1.3			08.83	04.89						
	1.4			01.86	04.89						
	1.0			08.83	04.89		03.0137-0164.2	650164		178 x 32 AUT	
	1.1			08.83	04.89		03.0137-9091.2	669091		Bremsbacken-Zubehör	
	1.3			08.83	04.89						
	1.4			01.86	04.89						
	1.6 D			03.84	04.89						
	1.6 XR2			02.84	04.89						
	alle Typen			08.83	04.89		24.3727-0617.2	580617	1	↓	L=2750

¹⁾ - ABS/ + autom.transmission / - ABS/ + scatola cambio autom. / - ABS/ + transmission automatique / - ABS/ + cambio automático
²⁾ - ABS/ - Van / - ABS/ - furgone / - ABS/ - fourgonnette / - ABS/ - furgón
³⁾ - Van/ - Cosworth/ - RS2000 / - furgone/ - Cosworth/ - RS2000 / - fourgonn./ - Cosworth/ - RS2000 / - furgón/ - Cosworth/ - RS2000
⁴⁾ + booster unit / + servofreno / + servo-frein / + servofreno
⁵⁾ - brake pressure regulator / - correttore di frenata / - correcteur de freinage / - corrector de frenado

















FORD FIESTA (76-89)										
	alle Typen			06.76	04.89	+ Bremsgerät ¹⁾	24.3728-0623.2	590623		L=650
FORD FIESTA III (89-96)										
	1.1			05.89	04.91	- SCS	24.2120-1739.3	010762		Thz 20,64 - Behälter TRW
	1.3	44		03.89	04.91	- SCS				
	1.4			03.89	04.91	- SCS				
	1.8 D	44		05.89	04.91	- SCS				
	1.1			05.91	01.94	- SCS	24.2120-1604.3	010370		Thz 20,64
	1.3	44		05.91	01.94	- SCS				
	1.3 Kastenw.			09.91	01.94	- SCS				
	1.4			05.91	01.94	- SCS				
	1.8 D	44		05.91	01.94	- SCS				
	1.8 D Kastenw.			09.91	01.94	- SCS				
	1.1			02.94	11.96	- SCS	24.2120-1606.3	010582		Thz 20,64 + Behälter
	1.3	44		02.94	11.96	- SCS				
	1.3 Kastenw.			02.94	11.96	- SCS				
	1.4			02.94	11.96	- SCS				
	1.8 D	44		02.94	11.96	- SCS				
	1.8 D Kastenw.			02.94	11.96	- SCS				
	1.0	33		03.89	12.95	+ SCS	24.2122-1603.3	010381		Thz 22,20
	1.1			05.89	11.96	+ SCS				
	1.3	44		03.89	11.96	+ SCS				
	1.3 Kastenw.			09.91	11.96	+ SCS				
	1.4			03.89	11.96	+ SCS				
	1.6			01.89	11.96	+ SCS				
	1.6 Turbo	96		03.90	10.92	+ SCS				
	1.6 XR2i			03.89	11.96	+ SCS				
	1.6i 16V	65		01.94	11.96	+ SCS				
	1.8 16V	77		02.92	11.96	+ SCS				
	1.8 D	44		05.89	11.96	+ SCS				
	1.8 D Kastenw.			09.91	11.96	+ SCS				
	1.8 XR2i	96		02.92	12.95	+ SCS				
	1.0	33		03.89	10.95		11.3481-8512.2	220338	<input type="checkbox"/> - belüftete Scheiben ²⁾	D=48, - Halter ATE
	1.1			05.89	10.95		11.0441-4805.2	250020	<input type="checkbox"/> - belüftete Scheiben ²⁾	Dichtungssatz ATE
	1.3	44		03.89	10.95		24.3541-1701.5	240005	<input type="checkbox"/> + belüftete Scheiben ³⁾	D=54, - Halter ATE
	1.3 Kastenw.			09.91	10.95		11.0441-5402.2	250028	+ belüftete Scheiben ³⁾	Dichtungssatz ATE
	1.4			03.89	10.95		11.8171-0008.1	990049		Führungsbolzen ATE
	1.6			01.89	10.95		11.0101-5407.2	260011		Hülssensatz ATE
	1.6 Turbo	96		03.90	10.92					
	1.6 XR2i			03.89	10.95					
	1.6i 16V	65		01.94	10.95					
	1.8 16V	77		02.92	10.95					
	1.8 D	44		05.89	10.95					
	1.8 D Kastenw.			09.91	10.95					
	1.8 XR2i	96		02.92	10.95					
	1.0	33		11.95	11.96		11.3481-8513.2	220335	<input type="checkbox"/> - belüftete Scheiben ²⁾	D=48, - Halter ATE
	1.1			11.95	11.96		11.3481-8514.2	220336	<input type="checkbox"/> - belüftete Scheiben ²⁾	D=48, - Halter ATE
	1.3	44		11.95	11.96		11.0230-0687.1	260106	- belüftete Scheiben ²⁾	Halter ATE
	1.3 Kastenw.			11.95	11.96		11.0441-4805.2	250020	- belüftete Scheiben ²⁾	Dichtungssatz ATE
	1.4			11.95	11.96		11.3541-8529.2	220341	<input type="checkbox"/> + belüftete Scheiben ³⁾	D=54, - Halter ATE
	1.6			11.95	11.96		11.3541-8530.2	220342	<input type="checkbox"/> + belüftete Scheiben ³⁾	D=54, - Halter ATE
	1.6 XR2i			11.95	11.96		24.3541-8529.5	240553	<input type="checkbox"/> + belüftete Scheiben ³⁾	D=54, - Halter ATE
	1.6i 16V	65		11.95	11.96		24.3541-8530.5	240554	<input type="checkbox"/> + belüftete Scheiben ³⁾	D=54, - Halter ATE
	1.8 16V	77		11.95	11.96		11.0441-5402.2	250028	<input type="checkbox"/> + belüftete Scheiben ³⁾	Dichtungssatz ATE
	1.8 D	44		11.95	11.96		11.8171-0008.1	990049		Führungsbolzen ATE
	1.8 D Kastenw.			11.95	11.96		11.0101-5407.2	260011		Hülssensatz ATE
	1.8 XR2i	96		11.95	11.96					
	1.0	33		03.89	12.95		13.0460-7073.2	607073	- belüftete Scheiben ²⁾	21202 16,9 + ATE
	1.1			05.89	11.96		13.0460-7071.2	607071	+ belüftete Scheiben ³⁾	20640 17,5 + ATE
	1.3	44		03.89	11.96					
	1.3 Kastenw.			09.91	11.96					
	1.4			03.89	11.96					
	1.6			01.89	11.96					
	1.6 Turbo	96		03.90	10.92					
	1.6 XR2i			03.89	11.96					
	1.6i 16V	65		01.94	11.96					
	1.8 16V	77		02.92	11.96					
	1.8 D	44		05.89	11.96					
	1.8 D Kastenw.			09.91	11.96					
	1.8 XR2i	96		02.92	12.95					
	1.0	33		03.89	10.95		24.0110-0196.1	410196	- belüftete Scheiben ²⁾	240 10,0 8,0 +B
	1.1			05.89	10.95		24.0120-0147.1	420147	+ belüftete Scheiben ³⁾	240 20,0 18,0 V +B
	1.3	44		03.89	10.95		24.0320-0147.1	520147	+ belüftete Scheiben ³⁾	240 20,0 18,0 V +B PD
	1.3 Kastenw.			09.91	10.95					
	1.4			03.89	10.95					
	1.6			01.89	10.95					
	1.6 Turbo	96		03.90	10.92					
	1.6 XR2i			03.89	10.95					
	1.6i 16V	65		01.94	10.95					
	1.8 16V	77		02.92	10.95					
	1.8 D	44		05.89	10.95					
	1.8 D Kastenw.			09.91	10.95					
	1.8 XR2i	96		02.92	10.95					

¹⁾ + booster unit / + servofreno / + servo-frein / + servofreno









²⁾ - ventilated discs / - dischi ventilati / - disques ventilés / - disco ventilado

³⁾ + ventilated discs / + dischi ventilati / + disques ventilés / + disco ventilado

        							
FORD FIESTA III (89-96)							
	1.0 33	11.95	12.95	24.0112-0141.1	412141	- belüftete Scheiben ¹⁾ + belüftete Scheiben ²⁾ + belüftete Scheiben ²⁾	239 12,0 10,0 +B 240 20,0 18,0 V +B 240 20,0 18,0 V +B PD
	1.1	11.95	11.96	24.0120-0147.1	420147		
	1.3 44	11.95	11.96	24.0320-0147.1	520147		
	1.3 Kastenw.	11.95	11.96				
	1.4	11.95	11.96				
	1.6	11.95	11.96				
	1.6 XR2i	11.95	11.96				
	1.6i 16V 65	11.95	11.96				
	1.8 16V 77	11.95	11.96				
	1.8 D 44	11.95	11.96				
	1.8 D Kastenw.	11.95	11.96				
1.8 XR2i 96	11.95	12.95					
	1.0 33	03.89	12.95	24.5303-0400.3	330404	2	L=400
	1.1	05.89	11.96				
	1.3 44	03.89	11.96				
	1.3 Kastenw.	09.91	11.96				
	1.4	03.89	11.96				
	1.6	01.89	11.96				
	1.6 Turbo 96	03.90	10.92				
	1.6 XR2i	03.89	11.96				
	1.6i 16V 65	01.94	11.96				
	1.8 16V 77	02.92	11.96				
	1.8 D 44	05.89	11.96				
1.8 D Kastenw.	09.91	11.96					
1.8 XR2i 96	02.92	12.95					
	1.0 33	03.89	12.95	24.5302-0295.3	330403	2	L=295
	1.1	05.89	11.96	24.5306-0295.3	330662	2	
	1.3 44	03.89	11.96				
	1.4	03.89	11.96				
	1.6	01.89	11.96				
	1.6 Turbo 96	03.90	10.92				
	1.6 XR2i	03.89	11.96				
	1.6i 16V 65	01.94	11.96				
	1.8 16V 77	02.92	11.96				
	1.8 D 44	05.89	11.96				
	1.8 XR2i 96	02.92	12.95				
1.3 Kastenw.	09.91	11.96	24.5304-0280.3	330589	2	L=280	
1.8 D Kastenw.	09.91	11.96					
	1.0 33	03.89	12.93	24.3217-1601.3	020180		Rz 17,46
	1.1 44	05.89	12.93				
	1.3 44	03.89	12.93				
	1.4 44	03.89	12.93				
	1.8 D 44	05.89	11.96				
	1.6 96	01.89	11.96	24.3219-1106.3	020192		
	1.6 Turbo 96	03.90	10.92				
	1.6 XR2i	03.89	11.96				
	1.6i 16V 65	01.94	11.96				
	1.8 16V 77	02.92	11.96				
	1.8 XR2i 96	02.92	12.95				
1.0 33	01.94	12.95	24.3219-1717.3	020415		Rz 19,05	
1.1 44	01.94	11.96					
1.3 44	01.94	11.96					
1.4 44	01.94	11.96					
1.0 33	03.89	12.95	24.3222-1111.3	020266		Rz 22,20	
1.1 44	05.89	11.96					
1.3 44	03.89	11.96					
1.3 Kastenw.	09.91	01.94					
1.4 44	03.89	11.96					
1.6 96	01.89	11.96					
1.6 Turbo 96	03.90	10.92					
1.6 XR2i	03.89	11.96					
1.6i 16V 65	01.94	11.96					
1.8 16V 77	02.92	11.96					
1.8 D 44	05.89	11.96					
1.8 D Kastenw.	09.91	01.94					
1.8 XR2i 96	02.92	12.95					
1.3 Kastenw.	02.94	11.96	24.3222-1117.3	020272		Rz 22,20	
1.8 D Kastenw.	02.94	11.96					
	1.0 33	03.89	12.95	03.0137-0235.2	650235		180 x 32 AUT Bremsbacken-Zubehör
	1.1 44	05.89	11.96	03.0137-9121.2	669121		
	1.3 44	03.89	11.96				
	1.4 44	03.89	11.96				
	1.8 D 44	05.89	11.96				
	1.0 33	03.89	12.95	03.0137-0236.2	650236		
	1.1 44	05.89	11.96	03.0137-9120.2	669120		
	1.3 44	03.89	11.96				
	1.3 Kastenw.	09.91	11.96				
	1.4 44	03.89	11.96				
	1.6 96	01.89	11.96				
1.6 Turbo 96	03.90	10.92					
1.6 XR2i	03.89	11.96					
1.6i 16V 65	01.94	11.96					
1.8 16V 77	02.92	11.96					
1.8 D 44	05.89	11.96					
1.8 D Kastenw.	09.91	11.96					
1.8 XR2i 96	02.92	12.95					

¹⁾ - ventilated discs / - dischi ventilati / - disques ventilés / - disco ventilado

²⁾ + ventilated discs / + dischi ventilati / + disques ventilés / + disco ventilado

FORD FIESTA III (89-96)											
	1.0	33	03.89	12.95	- SCS	24.0218-0024.2	480079	ohne Sensorring ¹⁾	180/181,3 x 44 - Lager 180/181,3 x 44 + Lager		
	1.1		05.89	11.96	- SCS	24.0218-0724.2	480206				
	1.3	44	03.89	11.96	- SCS						
	1.4		03.89	11.96	- SCS						
	1.8 D	44	05.89	11.96	- SCS						
	1.0	33	03.89	12.95	+ SCS	24.0220-3002.2	480021			ohne Sensorring ¹⁾	203/204 x 46,5
	1.1		05.89	11.96	+ SCS						
	1.3	44	03.89	11.96	+ SCS						
	1.4		03.89	11.96	+ SCS						
	1.6		01.89	11.96							
1.6 Turbo	96	03.90	10.92								
1.6 XR2i		03.89	11.96								
1.6i 16V	65	01.94	11.96								
1.8 16V	77	02.92	11.96								
1.8 D	44	05.89	11.96	+ SCS							
1.8 XR2i	96	02.92	12.95								
1.3 Kastenw.		09.91	11.96		24.0220-3008.2	480075		203/204 x 45			
1.8 D Kastenw.		09.91	11.96								
	1.0	33	03.89	12.93	- SCS	03.0520-1417.3	691417		17,46/180x32 TopKit BDX		
	1.1		05.89	12.93	- SCS						
	1.3	44	03.89	12.93	- SCS						
	1.4		03.89	12.93	- SCS						
	1.8 D	44	05.89	11.96	- SCS						
	1.0	33	01.94	12.95	- SCS	03.0520-4419.3	694419				19,05/180x32 TopKit
	1.1		01.94	11.96	- SCS						
	1.3	44	01.94	11.96	- SCS						
	1.4		01.94	11.96	- SCS						
	1.0	33	03.89	12.95	+ SCS	03.0420-2922.3	682922				
1.1		05.89	11.96	+ SCS							
1.3	44	03.89	11.96	+ SCS							
1.3 Kastenw.		09.91	01.94								
1.4		03.89	11.96	+ SCS							
1.6		01.89	11.96	+ SCS							
1.6 Turbo	96	03.90	10.92	+ SCS							
1.6 XR2i		03.89	11.96	+ SCS							
1.6i 16V	65	01.94	11.96	+ SCS							
1.8 16V	77	02.92	11.96	+ SCS							
1.8 D	44	05.89	11.96	+ SCS							
1.8 D Kastenw.		09.91	01.94								
1.8 XR2i	96	02.92	12.95	+ SCS							
	1.0	33	03.89	12.95		24.3727-0628.2	580628	1 	L=151		
	1.1		05.89	11.96							
	1.3	44	03.89	11.96							
	1.4		03.89	11.96							
	1.6		01.89	11.96							
	1.6 Turbo	96	03.90	10.92							
	1.6 XR2i		03.89	11.96							
	1.6i 16V	65	01.94	11.96							
	1.8 16V	77	02.92	11.96							
	1.8 D	44	05.89	11.96							
1.8 XR2i	96	02.92	12.95								
	1.0	33	03.89	07.91		24.3727-0623.2	580623	1 	L=3268		
	1.1		05.89	07.91							
	1.3	44	03.89	07.91							
	1.4		03.89	07.91							
	1.6		01.89	07.91							
	1.6 Turbo	96	03.90	07.91							
	1.6 XR2i		03.89	07.91							
	1.8 D	44	05.89	07.91							
	1.0	33	08.91	01.94		24.3727-0626.2	580626			1 	L=3242
	1.1		08.91	01.94							
1.3	44	08.91	01.94								
1.4		08.91	01.94								
1.6		08.91	01.94								
1.6 Turbo	96	08.91	10.92								
1.6 XR2i		08.91	01.94								
1.8 16V	77	02.92	01.94								
1.8 D	44	08.91	01.94								
1.8 XR2i	96	02.92	01.94								
	1.0	33	02.94	12.95		24.3727-0662.2	580662	1 	L=3255		
	1.1		02.94	11.96							
	1.3	44	02.94	11.96							
	1.4		02.94	11.96							
	1.6		02.94	11.96							
	1.6 XR2i		02.94	11.96							
	1.6i 16V	65	01.94	11.96							
	1.8 16V	77	02.94	11.96							
	1.8 D	44	02.94	11.96							
	1.8 XR2i	96	02.94	12.95							
	1.0	33	03.89	12.93		24.3728-0601.2	590601		L=673		
	1.1		05.89	12.93							
	1.3	44	03.89	12.93							
	1.3 Kastenw.		09.91	12.93							
	1.4		03.89	12.93							
	1.6		01.89	12.93							
	1.6 Turbo	96	03.90	10.92							

¹⁾ without sensor ring / senza sensori / sans secours ABS / sin anillo sensor ABS



FORD FIESTA III (89-96)									
	1.6 XR2i 1.8 16V 1.8 D 1.8 D Kastenw. 1.8 XR2i	77 44 44 96	03.89 02.92 05.89 09.91 02.92	12.93 12.93 12.93 12.93 12.93	24.3728-0601.2	590601			L=673
FORD MAVERICK (93-96)									
	2.4 i 2.7 TD		02.93 02.93	09.96 09.96	24.2123-1726.3	010557			Thz 23,81 - Behälter
	2.4 i 2.7 TD		02.93 02.93	09.96 09.96	13.0460-5959.2	605959			21481 15,5 TRW
	2.4 i 2.7 TD		02.93 02.93	09.96 09.96	24.0126-0109.1	426109			277 26,0 24,0 V +B
	2.4 i 2.7 TD		02.93 02.93	09.96 + 2 türig ¹⁾ 09.96 + 2 türig ¹⁾	24.3222-1717.3	020443			Rz 22,20
	2.4 i 2.7 TD		02.93 02.93	09.96 + 4 türig ²⁾ 09.96 + 4 türig ²⁾	24.3223-1709.3	020444			Rz 23,81
	2.4 i 2.7 TD		02.93 02.93	09.96 09.96	03.0137-0376.2 03.0137-9169.2	650376 669169			254 x 58 HEB Bremsbacken-Zubehör
	2.4 i 2.7 TD		02.93 02.93	09.96 09.96	24.0225-4014.1	480155			254/255,5 x 65
FORD MONDEO I (93-96)									
	1.6 i 16V 1.8 i 16V 1.8 TD 2.0 i 16V 2.0 i 16V 4x4		01.96 01.96 01.96 01.96 01.96	09.96 - ABS 09.96 - ABS 09.96 - ABS 09.96 - ABS 09.96 - ABS	24.2125-1706.3	010496			Thz 25,40
	1.6 i 16V 1.8 i 16V 1.8 TD 2.0 i 16V 2.0 i 16V 4x4 2.5 i 24V		01.93 01.93 01.93 01.93 04.93 08.94	12.95 + ABS 12.95 + ABS 12.95 + ABS 12.95 + ABS 12.95 + ABS 12.95	24.2125-1707.3	010497			Thz 25,40
	1.6 i 16V 1.8 i 16V 1.8 TD 2.0 i 16V 2.0 i 16V 4x4 2.5 i 24V		01.96 01.96 01.96 01.96 01.96 01.96	09.96 + ABS 09.96 + ABS 09.96 + ABS 09.96 + ABS 09.96 + ABS 09.96	24.2125-1708.3	010498			Thz 25,40
	1.6 i 16V 1.8 i 16V 1.8 TD 2.0 i 16V		01.93 01.93 01.93 01.93	09.96 09.96 09.96 09.96	24.3601-8527.5 24.3601-8528.5 11.0441-6007.2 11.0101-5407.2 11.8171-0008.1 11.8116-0301.1	240503 240504 250146 260011 990049 390610	<input type="checkbox"/> <input type="checkbox"/>		D=60, - Halter ATE D=60, - Halter ATE Dichtungssatz ATE Hülssensatz ATE Führungsbolzen ATE Haltefeder ATE
	2.0 i 16V 4x4 2.5 i 24V		04.93 08.94	09.96 09.96	11.0441-6007.2 11.0101-5407.2 11.8171-0008.1 11.8116-0143.1	250146 260011 990049 390513		2	Dichtungssatz ATE Hülssensatz ATE Führungsbolzen ATE Haltefeder ATE
	1.6 i 16V 1.8 i 16V 1.8 TD 2.0 i 16V		01.93 01.93 01.93 01.93	09.96 09.96 09.96 09.96	13.0460-7057.2 13.0460-7056.2	607057 607056			21394 17,5 + ATE 21396 17,5 +WK ATE
	2.0 i 16V 4x4 2.5 i 24V		04.93 08.94	09.96 09.96	13.0460-7165.2 13.0460-7163.2	607165 607163			21358 19,8 + ATE 21910 19,8 +WK ATE
	1.6 i 16V 1.8 i 16V 1.8 TD 2.0 i 16V		01.93 01.93 01.93 01.93	09.96 09.96 09.96 09.96	24.0124-0120.1 24.0324-0120.1	424120 524120			260 24,0 22,2 V +B 260 24,0 22,2 V +B PD
	2.0 i 16V 4x4 2.5 i 24V		04.93 08.94	09.96 09.96	24.0124-0149.1	424149			278 24,1 22,2 V +B
	1.6 i 16V 1.8 i 16V 1.8 TD 2.0 i 16V 2.0 i 16V 4x4 2.5 i 24V		01.93 01.93 01.93 01.93 04.93 08.94	09.96 09.96 09.96 09.96 09.96 09.96	83.7114-0376.3	330373		2	L=370
	1.6 i 16V Lim. 1.8 i 16V Lim. 1.8 TD Lim. 2.0 i 16V Lim. 2.5 i 24V Lim.		01.93 01.93 01.93 01.93 08.94	09.96 09.96 09.96 09.96 09.96	24.3364-1703.5 24.3364-1704.5	240309 240310	<input type="checkbox"/> <input type="checkbox"/>		D=36, - Halter BOS D=36, - Halter BOS
	1.6 i 16V Kombi 1.8 i 16V Kombi 1.8 TD Kombi 2.0 i 16V Kombi 2.5 i 24V Kombi		01.93 01.93 01.93 01.93 08.94	09.96 09.96 09.96 09.96 09.96	24.3364-1705.5 24.3364-1706.5	240311 240312	<input type="checkbox"/> <input type="checkbox"/>		D=36, - Halter BOS D=36, - Halter BOS

¹⁾ + 2 door / + 2 porte / + 2 portes / + 2 puertas
²⁾ + 4 door / + 4 porte / + 4 portes / + 4 puertas





























FORD MONDEO I (93-96)

	1.6 i 16V 1.8 i 16V 1.8 TD 2.0 i 16V 2.0 i 16V 4x4 2.5 i 24V			01.93 09.96 01.93 09.96 01.93 09.96 01.93 09.96 04.93 09.96 08.94 09.96			13.0460-3963.2 603963 13.0460-3964.2 603964 13.0460-0428.2 610428		- Ghia Modelle ¹⁾ + Ghia Modelle ²⁾	21586 15,0 23410 15,0 +/WK Belagsatz-Zubehör	BDX BDX BDX
	1.6 i 16V 1.8 i 16V 1.8 TD 2.0 i 16V 2.0 i 16V 4x4 2.5 i 24V			01.93 09.96 01.93 09.96 01.93 09.96 01.93 09.96 04.93 09.96 08.94 09.96			24.0120-0146.1 420146 24.0320-0146.1 520146			253 20,0 18,0 V +B 253 20,0 18,0 V +B PD	
	1.6 i 16V Lim. 1.8 i 16V Lim. 1.8 TD Lim. 2.0 i 16V 4x4 2.0 i 16V Lim. 2.5 i 24V Lim.			01.93 12.95 01.93 12.95 01.93 12.95 04.93 12.95 01.93 12.95 08.94 12.95			83.6227-0281.3 330424	2	+ HA-Trommelbremse ³⁾	L=280	
	1.6 i 16V Lim. 1.8 i 16V Lim. 1.8 TD Lim. 2.0 i 16V 4x4 2.0 i 16V Lim. 2.5 i 24V Lim.			01.96 09.96 01.96 09.96 01.96 09.96 01.96 09.96 01.96 09.96 01.96 09.96			83.6118-0281.3 330483 24.5309-0540.3 331368	2 2	+ HA-Trommelbremse ³⁾ + HA-Scheibenbremse ⁴⁾	L=280 L=540	
	1.6 i 16V Kombi 1.8 i 16V Kombi 1.8 TD Kombi 2.0 i 16V Kombi 2.5 i 24V Kombi			01.93 09.96 01.93 09.96 01.93 09.96 01.93 09.96 08.94 09.96			83.6114-0300.3 330258 24.5164-0315.3 331209	2 2	+ HA-Trommelbremse ³⁾ + HA-Scheibenbremse ⁴⁾	L=300 L=315	
	1.6 i 16V Lim. 1.8 i 16V Lim. 1.8 TD Lim. 2.0 i 16V Lim.			01.93 05.94 01.93 05.94 01.93 05.94 01.93 05.94			24.3220-1111.3 020222			Rz 20,64	
	1.6 i 16V Lim. 1.8 i 16V Lim. 1.8 TD Lim. 2.0 i 16V Lim.			06.94 09.96 06.94 09.96 06.94 09.96 06.94 09.96			24.3222-1114.3 020269			Rz 22,20	
	1.6 i 16V Kombi 1.8 i 16V Kombi 1.8 TD Kombi 2.0 i 16V Kombi			01.93 09.96 01.93 09.96 01.93 09.96 01.93 09.96			24.3222-1116.3 020271			Rz 22,20	
	1.6 i 16V Lim. 1.8 i 16V Lim. 1.8 TD Lim. 2.0 i 16V Lim.			01.93 05.94 01.93 05.94 01.93 05.94 01.93 05.94			03.0137-0253.2 650253 03.0137-9153.2 669153			228 x 45 HEB Bremsbacken-Zubehör	
	1.6 i 16V Lim. 1.8 i 16V Lim. 1.8 TD Lim. 2.0 i 16V Lim.			06.94 09.96 06.94 09.96 06.94 09.96 06.94 09.96			03.0137-0272.2 650272 03.0137-9177.2 669177			203 x 39 HEB Bremsbacken-Zubehör	
	1.6 i 16V Kombi 1.8 i 16V Kombi 1.8 TD Kombi 2.0 i 16V Kombi			01.93 09.96 01.93 09.96 01.93 09.96 01.93 09.96			03.0137-0253.2 650253 03.0137-9153.2 669153			228 x 45 HEB Bremsbacken-Zubehör	
	1.6 i 16V Lim. 1.8 i 16V Lim. 1.8 TD Lim. 2.0 i 16V Lim.			01.93 05.94 01.93 05.94 01.93 05.94 01.93 05.94			24.0222-8014.1 480031			229/230,1 x 54	
	1.6 i 16V Lim. 1.8 i 16V Lim. 1.8 TD Lim. 2.0 i 16V Lim.			06.94 09.96 06.94 09.96 06.94 09.96 06.94 09.96			24.0220-3006.1 480062			203/204,5 x 49,3	
	1.6 i 16V Kombi 1.8 i 16V Kombi 1.8 TD Kombi 2.0 i 16V Kombi			01.93 09.96 01.93 09.96 01.93 09.96 01.93 09.96			24.0222-8014.1 480031			229/230,1 x 54	
	1.6 i 16V Lim. 1.8 i 16V Lim. 1.8 TD Lim. 2.0 i 16V Lim.			01.93 05.94 01.93 05.94 01.93 05.94 01.93 05.94			03.0520-2320.3 692320			20,64/228x45 TopKit	TRW
	1.6 i 16V Lim. 1.8 i 16V Lim. 1.8 TD Lim. 2.0 i 16V Lim.			06.94 09.96 06.94 09.96 06.94 09.96 06.94 09.96			03.0420-2122.3 682122			22,20/203x39 Kit	TRW
	1.6 i 16V Kombi 1.8 i 16V Kombi 1.8 TD Kombi 2.0 i 16V Kombi			01.93 09.96 01.93 09.96 01.93 09.96 01.93 09.96			03.0520-2222.3 692222			22,20/228x45 TopKit	TRW
	1.6 i 16V Lim. 1.8 i 16V Lim. 1.8 TD Lim. 2.0 i 16V 4x4 2.0 i 16V Lim. 2.5 i 24V Lim.			01.93 09.96 01.93 09.96 01.93 09.96 04.93 09.96 01.93 09.96 08.94 09.96			24.3727-0638.2 580638 24.3727-0639.2 580639 24.3727-0644.2 580644	1 2 2	+ HA-Trommelbremse ³⁾ + HA-Scheibenbremse ⁴⁾	L=270 L=1611 L=1462	

1) - Ghia model / - modelo Ghia / - modèles Ghia / - modelo Ghia
2) + Ghia model / + modelo Ghia / + modèles Ghia / + modelo Ghia
3) + RA drum brake / + P freno a tamburo / + frein à tambour essieu AR / + ET-tambores de freno
4) + RA disc brake / + P disco freno / + frein à disque essieu AR / + ET-disco de freno

FORD MONDEO I (93-96)												
	1.6 i 16V Kombi 1.8 i 16V Kombi 1.8 TD Kombi 2.0 i 16V Kombi 2.5 i 24V Kombi			01.93 09.96 01.93 09.96 01.93 09.96 01.93 09.96 08.94 09.96			24.3727-0638.2 580638 24.3727-0639.2 580639 24.3727-0641.2 580641		1  2  2 	+ HA-Trommelbremse 1) + HA-Scheibenbremse 2)	L=270 L=1611 L=1647	
	1.6 i 16V Lim. 1.8 i 16V Lim. 2.0 i 16V Lim.			01.93 12.95 - ABS 01.93 12.95 - ABS 01.93 12.95 - ABS			03.6043-1774.3 320031 03.6043-1784.3 320034			THz primär Anschluß M10x1 3) THz sekundär Anschluß M12x1 4)	BRE 3/30 BRE 3/30	ATE ATE
	1.6 i 16V Lim. 1.8 i 16V Lim. 2.0 i 16V Lim.			01.96 09.96 - ABS 01.96 09.96 - ABS 01.96 09.96 - ABS			03.6043-1954.3 320226	2			BRE 3/30	ATE
	1.6 i 16V Kombi 1.8 i 16V Kombi 1.8 TD 2.0 i 16V Kombi			01.93 12.95 - ABS 01.93 12.95 - ABS 01.93 12.95 - ABS 01.93 12.95 - ABS			03.6043-1773.3 320030 03.6043-1783.3 320033			THz primär Anschluß M10x1 3) THz sekundär Anschluß M12x1 4)	BRE 3/25 BRE 3/25	ATE ATE
	1.6 i 16V Kombi 1.8 i 16V Kombi 1.8 TD Kombi 2.0 i 16V Kombi			01.96 09.96 - ABS 01.96 09.96 - ABS 01.96 09.96 - ABS 01.96 09.96 - ABS			03.6043-1953.3 320201	2			BRE 3/45	ATE
	1.6 i 16V 1.8 i 16V 1.8 TD 2.0 i 16V 2.5 i 24V			01.93 12.95 + ABS 01.93 12.95 + ABS 01.93 12.95 + ABS 01.93 12.95 + ABS 08.94 12.95			03.6043-1776.3 320032 03.6043-1786.3 320035			THz primär Anschluß M10x1 3) THz sekundär Anschluß M12x1 4)	BRE 3/40 BRE 3/40	ATE ATE
	1.6 i 16V 1.8 i 16V 1.8 TD 2.0 i 16V 2.5 i 24V			01.96 09.96 + ABS 01.96 09.96 + ABS 01.96 09.96 + ABS 01.96 09.96 + ABS 01.96 09.96			03.6043-1956.3 320202	2			BRE 3/40	ATE
	1.6 i 16V 1.8 i 16V 1.8 TD 2.0 i 16V 2.5 i 24V			08.94 09.96 08.94 09.96 08.94 09.96 08.94 09.96 08.94 09.96			24.2419-1723.3 030112				Gz 19,05	
	1.6 i 16V 1.8 i 16V 1.8 TD 2.0 i 16V 2.0 i 16V 4x4 2.5 i 24V			08.94 09.96 08.94 09.96 08.94 09.96 08.94 09.96 04.93 09.96 08.94 09.96			24.2532-5003.3 090013				Zentralausrücker D=32	
FORD PROBE (91-92)												
	2.2 i 2.2 i Turbo 3.0 i V6			12.90 12.92 12.90 12.92 12.90 12.92			13.0460-5932.2 605932 13.0460-0313.2 610313				21378 15,0 +/WK Belagsatz-Zubehör	AKE AKE
	2.2 i 2.2 i Turbo 3.0 i V6			12.90 12.92 12.90 12.92 12.90 12.92			24.0124-0105.1 424105				264 24,0 22,0 V	
	2.2 i 2.2 i Turbo 3.0 i V6			12.90 12.92 12.90 12.92 12.90 12.92			13.0460-5995.2 605995				21558 13,0	
	2.2 i 2.2 i Turbo 3.0 i V6			12.90 12.92 12.90 12.92 12.90 12.92			24.0110-0181.1 410181				259 10,0 8,0	
FORD PROBE (93-97)												
	2.0 i 16V 2.5 i 24V			01.94 09.97 01.93 09.97			13.0460-5954.2 605954 13.0460-0443.2 610443				23845 15,8 +/WK/Zub Belagsatz-Zubehör	SUM SUM
	2.0 i 16V 2.5 i 24V			01.94 09.97 01.93 09.97			24.0124-0129.1 424129				258 24,0 22,0 V +B	
	2.0 i 16V 2.5 i 24V			01.94 09.97 01.93 09.97			13.0460-5973.2 605973 13.0460-0245.2 610245				21766 13,5 Belagsatz-Zubehör	
	2.0 i 16V 2.5 i 24V			01.94 09.97 01.93 09.97			24.0110-0234.1 410234				261 10,0 8,0 +B	
FORD SCORPIO / GRANADA (GB) (85-91)												
	alle Typen			03.85 01.92 - 2,9 i-24V			11.0441-6003.2 250037 11.0101-5407.2 260011 11.8171-0008.1 990049 11.8116-0052.1 390496		2		Dichtungssatz Hülssensatz Führungsbolzen Haltefeder	ATE ATE ATE
	2.9 i 24V			01.91 01.92			11.0441-6007.2 250146 11.0101-5407.2 260011 11.8171-0008.1 990049 11.8116-0073.1 390498		2		Dichtungssatz Hülssensatz Führungsbolzen Haltefeder	ATE ATE ATE ATE
	alle Typen			03.85 01.92 - 2,9 i-24V			13.0460-7040.2 607040 13.0460-7041.2 607041				20907 18,0 + 20909 18,0 +/WK	ATE ATE
	alle Typen			03.85 11.86			24.0124-0109.1 424109				260 24,2 22,2 V	

1) + RA drum brake / + P freno a tamburo / + frein à tambour essieu AR / + ET-tambores de freno

2) + RA disc brake / + P disco freno / + frein à disque essieu AR / + ET-disco de freno

3) TMC primary: connection M10x1 / PFT primario: attacco M10x1 / MCT raccordement primaire M10x1 / CMT primario: conexión M10x1

4) TMC secondary: connection M12x1 / PFT secundario: attacco M12x1 / MCT raccordement secondaire M12x1 / CMT secundario: conexión M12x1





















FORD SCORPIO / GRANADA (GB) (85-91)

	alle Typen			12.86	01.92	- 2,9 i-24V	24.0124-0121.1	424121			260 24,0 22,2 V	
	alle Typen			03.85	01.92		24.5305-0310.3	331326	2		L=310	
	alle Typen			03.85	01.92		24.0711-1129.1	360002	2		Radsensor L=830	
	alle Typen			03.85	01.92	- 2,9 i-24V	24.3434-1601.5 24.3434-1602.5 24.0101-4301.2	240019 240020 260047			D=43, - Halter D=43, - Halter Bremsattel-Zubehör	TRW TRW TRW
	alle Typen			03.85	01.92		13.0460-2928.2 13.0460-2933.2	602928 602933			20981 13,8 /S 21079 13,8 +/WK/S	TRW TRW
	alle Typen			03.85	01.92	- 2,9 i-24V	24.0110-0186.1	410186			253 10,2 8,9 +B	
	alle Typen			03.85	01.92		24.5302-0296.3 83.6327-0180.3	330476 330740	2 2	am Bremsattel ¹⁾	L=295 L=180	
	alle Typen			03.85	01.92		24.0711-1301.1	360015	2		Radsensor L=870	
	alle Typen 4x4			03.85	01.92		24.0711-1301.1	360015	2		Radsensor L=870	
	alle Typen			03.85	04.91		24.3727-0618.2	580618	1		L=3724	
	1.8 1.8 2.0 2.0 2.0 i	◀ ◀ ◀ ◀ ◀		03.85 10.87 03.85 10.87 03.85	09.87 01.92 09.87 01.92 01.92	+ Klimaanlage ²⁾ + Klimaanlage ²⁾	24.3728-0625.2	590625			L=1405	

FORD SCORPIO / GRANADA (GB) (92-94)

	2.0 i 2.4 i V6 2.5 TD 2.9 i V6 2.9 i 24V			02.92 02.92 02.92 02.92 02.92	09.94 09.94 09.94 09.94 09.94		11.0441-6003.2 11.0101-5407.2 11.8171-0008.1 11.8116-0052.1	250037 260011 990049 390496	2		Dichtungssatz Hülzensatz Führungsbolzen Haltefeder	ATE ATE ATE ATE
	2.0 i 2.4 i V6 2.5 TD 2.9 i V6 2.9 i V6 4x4			02.92 02.92 02.92 02.92 08.92	07.92 07.92 07.92 07.92 09.94		13.0460-7040.2	607040			20907 18,0 +	ATE
	2.0 i 2.4 i V6 2.5 TD 2.5 TD Kombi 2.5 TD Lim. 2.9 i V6			08.92 08.92 08.92 02.92 02.92 08.92	09.94 09.94 09.94 09.94 09.94 09.94		13.0460-7057.2 13.0460-7060.2	607057 607060			21394 17,5 + 21638 17,5 +/WK	ATE ATE
	2.0 i 2.4 i V6 2.5 TD 2.5 TD Kombi 2.5 TD Lim. 2.9 i V6			02.92 02.92 02.92 02.92 02.92 02.92	09.94 09.94 09.94 09.94 09.94 09.94		24.0124-0121.1	424121			260 24,0 22,2 V	
	2.0 i 2.4 i V6 2.5 TD 2.5 TD Kombi 2.5 TD Lim. 2.9 i 24V 2.9 i V6 2.9 i V6 4x4			02.92 02.92 02.92 02.92 02.92 02.92 02.92 02.92	09.94 09.94 09.94 09.94 09.94 09.94 09.94 09.94		24.5305-0310.3	331326	2		L=310	
	2.0 i 2.4 i V6 2.5 TD 2.5 TD Kombi 2.5 TD Lim. 2.9 i V6			02.92 02.92 02.92 02.92 02.92 02.92	09.94 09.94 09.94 09.94 09.94 09.94		13.0460-2928.2	602928			20981 13,8 /S	TRW
	2.0 i Lim. 2.4 i V6 Lim. 2.5 TD Lim. 2.9 i V6 Lim.			02.92 02.92 02.92 02.92	09.94 09.94 09.94 09.94		24.0110-0186.1	410186			253 10,2 8,9 +B	
	2.0 i 2.4 i V6 2.5 TD 2.5 TD Kombi 2.5 TD Lim. 2.9 i 24V 2.9 i V6 2.9 i V6 4x4			02.92 02.92 02.92 02.92 02.92 02.92 02.92 02.92	09.94 09.94 09.94 09.94 09.94 09.94 09.94 09.94		24.5302-0296.3 83.6327-0180.3	330476 330740	2 2	am Bremsattel ¹⁾	L=295 L=180	

¹⁾ on the brake caliper / sulla pinza freno / sur l'étrier de frein / a la pinza de freno
²⁾ + air conditioning / + aria condizionata / + air conditionné / + aire acondicionado

									
FORD SCORPIO / GRANADA (GB) (92-94)									
	2.0 i 2.4 i V6 2.5 TD 2.5 TD Kombi 2.5 TD Lim. 2.9 i 24V 2.9 i V6 2.9 i V6 4x4			02.92 02.92 02.92 02.92 02.92 02.92 02.92 02.92	09.94 09.94 09.94 09.94 09.94 09.94 09.94 09.94	24.3727-0642.2	580642	1	L=3760
FORD SIERRA (82-86)									
	1.3 1.6 1.8 2.0 2.0 i 2.3 2.3 D	◀ ◀ ◀ ◀ ◀ ◀ ◀		08.82 08.82 10.84 08.82 02.85 08.82 08.82	12.86 12.86 12.86 12.86 12.86 12.86 12.86	- ABS - ABS - ABS - ABS - ABS - ABS - ABS	24.2122-1713.3	010463	Thz 22,20
	1.6 Kombi 1.8 2.0 2.0 i 2.3 2.3 D alle Typen 2.0 RS Cosworth Turbo 2.8 i 2.8 XR4i			05.86 10.84 08.82 02.85 08.82 08.82 03.86 01.86 02.85 04.83	12.86 12.86 12.86 12.86 12.86 12.86 12.86 12.86 12.86 03.85	- ABS - ABS - ABS - ABS - ABS - ABS + ABS/ - Cosworth-Turbo - ABS - ABS	11.0441-5402.2 11.0101-5407.2 11.8171-0008.1 11.0441-6003.2 11.0101-5407.2 11.8171-0008.1 13.0441-4015.2	250028 260011 990049 250037 260011 990049 250080	Dichtungssatz Hülensatz Führungsbolzen Dichtungssatz Hülensatz Führungsbolzen Dichtungssatz ATE ATE ATE
	1.3 1.6 1.6 Lim. 1.6 Kombi 1.8 2.0 2.0 i 2.3 2.3 D 2.8 i Lim. alle Typen 2.8 i 4x4 2.8 i Kombi 2.8 XR4i			08.82 08.82 05.86 05.86 10.84 08.82 02.85 08.82 08.82 02.85 03.86 02.85 02.85 04.83	12.86 04.86 12.86 12.86 12.86 12.86 12.86 12.86 12.86 12.86 12.86 12.86 12.86 03.85	- ABS - ABS - ABS - ABS - ABS - ABS - ABS - ABS - ABS + ABS/ - Cosworth-Turbo - ABS - ABS	13.0460-2912.2 13.0460-7071.2 13.0460-7027.2 13.0460-7040.2 13.0460-7041.2	602912 607071 607027 607040 607041	20861 17,7 /S 20640 17,5 + 20783 17,5 +/WK 20907 18,0 + 20909 18,0 +/WK ATE ATE ATE
	1.6 Kombi 1.8 2.0 2.0 i 2.3 2.3 D 2.8 i 2.8 XR4i alle Typen 2.8 i 4x4			05.86 10.84 08.82 02.85 08.82 08.82 02.85 04.83 03.86 02.85	12.86 12.86 12.86 12.86 12.86 12.86 12.86 03.85 12.86 12.86	- ABS - ABS - ABS - ABS - ABS - ABS + ABS/ - Cosworth-Turbo	24.0124-0112.1 24.0124-0113.1 24.0124-0151.1	424112 424113 424151	240 24,2 22,2 V +B 260 24,2 22,2 V 260 24,3 22,8 V
	1.3 1.6 1.8 2.0 2.0 i 2.3 2.3 D 2.8 i			08.85 08.85 08.85 08.85 08.85 08.85 08.85 08.85	12.86 12.86 12.86 12.86 12.86 12.86 12.86 12.86		24.5305-0310.3	331326	2 L=310
	2.0 i 2.0 RS Cosworth Turbo 2.8 i 2.8 i 4x4 alle Typen			02.85 01.86 02.85 02.85 03.86	12.86 12.86 12.86 12.86 12.86	+ ABS	24.3434-1601.5 24.3434-1602.5 24.0101-4301.2	240019 240020 260047	D=43, - Halter D=43, - Halter Bremsattel-Zubehör TRW TRW TRW
	2.0 i 2.8 i 2.8 i 4x4 alle Typen			02.85 02.85 02.85 03.86	12.86 12.86 12.86 12.86	+ ABS	13.0460-2928.2	602928	20981 13,8 /S TRW
	2.0 i 2.8 i 2.8 i 4x4 alle Typen			02.85 02.85 02.85 03.86	12.86 12.86 12.86 12.86	+ ABS	24.0110-0115.1	410115	253 10,2 8,9 +B
	1.3 1.6 1.8 2.0 2.0 i 2.3 2.3 D 2.8 i 2.8 XR4i 2.0 RS Cosworth Turbo			08.82 08.82 10.84 08.82 02.85 08.82 08.82 02.85 04.83 01.86	12.86 12.86 12.86 12.86 12.86 12.86 12.86 12.86 03.85 12.86		24.5302-0296.3 83.6327-0180.3	330476	2 L=295 L=180



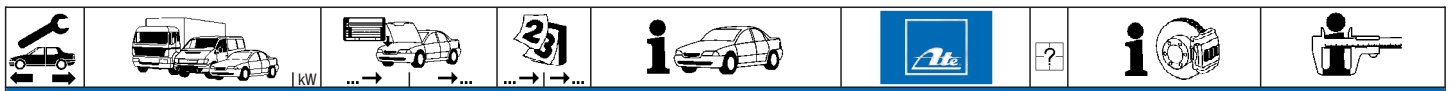

FORD SIERRA (82-86)

	2.8 i 4x4			02.85	12.86		83.6327-0180.3	330740	2		L=180
	1.6 Kombi			08.82	12.86	- ABS	24.3220-1112.3	020223		9" Bremse ¹⁾	Rz 20,64
	1.8			10.84	12.86	- ABS					
	2.0			08.82	12.86	- ABS					
	2.3			08.82	12.86	- ABS					
	2.3 D			08.82	12.86	- ABS					
	2.8 XR4i			04.83	03.85	- ABS	24.3222-1117.3	020272		10" Bremse ²⁾	Rz 22,20
	1.6 Kombi			08.82	12.86	- ABS	03.0137-0157.2	650157			229 x 58 HEB TRW
	1.8			10.84	12.86	- ABS	03.0137-9046.2	669046			Bremsbacken-Zubehör TRW
	2.0			08.82	12.86	- ABS					
	2.3			08.82	12.86	- ABS					
	2.3 D			08.82	12.86	- ABS					
	1.3			08.82	12.86	- ABS	24.0220-3001.2	480020			203/204 x 45
	1.6 Lim.			08.82	12.86	- ABS					
	1.6 Kombi			08.82	12.86	- ABS	24.0222-8010.2	480027			229/229,4 x 64
	1.8			10.84	12.86	- ABS					
	2.0			08.82	12.86	- ABS					
	2.3			08.82	12.86	- ABS					
	2.3 D			08.82	12.86	- ABS					
	1.6 Kombi			08.82	12.86	- ABS	03.0420-0220.3	680220			20,64/229x58 Kit TRW
	1.8			10.84	12.86	- ABS					
	2.0			08.82	12.86	- ABS					
	2.3			08.82	12.86	- ABS					
	2.3 D			08.82	12.86	- ABS					
	1.3			04.84	12.86		24.3727-0616.2	580616	1	↓	L=3313
	1.6			04.84	12.86						
	1.8			10.84	12.86						
	2.0			04.84	12.86						
	2.0 i			02.85	12.86						
	2.3			04.84	12.86						
	2.3 D			04.84	12.86						
	2.8 i			02.85	12.86						
	2.8 XR4i			04.84	03.85						
	2.0 RS Cosworth Turbo			01.86	12.86		24.3727-0624.2	580624	1	↓	L=3375
	2.8 i 4x4			02.85	12.86						
	1.8	◀		10.84	12.86		24.3728-0625.2	590625			L=1405
	2.0	◀		08.82	12.86	Reihenmotor/ - Klimaanlage ³⁾					



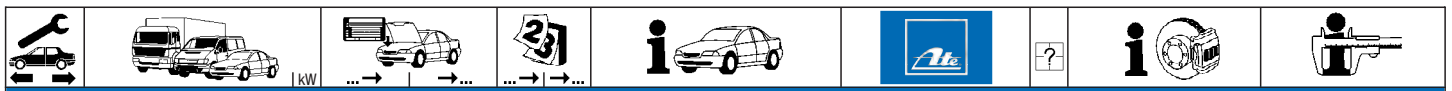

FORD SIERRA (87-93)

	1.6 Kombi	◀		01.87	02.93	- ABS	24.2122-1713.3	010463			Thz 22,20
	1.6 Lim.	◀		01.87	02.93	- ABS					
	1.8 Kombi	◀		01.87	03.93	- ABS					
	1.8 Lim.	◀		01.87	02.93	- ABS					
	1.8 TD Kombi	◀		08.88	02.93	- ABS					
	1.8 TD Lim.	◀		01.90	02.93	- ABS					
	2.0 i Kombi	◀		01.87	02.93	- ABS					
	2.0 i Lim.	◀		01.87	02.93	- ABS/ + HA-Trommelbremse ⁴⁾					
	2.0 Kombi	◀		01.87	02.93	- ABS					
	2.0 Lim.	◀		01.87	02.93	- ABS					
	2.3 D Kombi	◀		01.87	02.93	- ABS					
	2.3 D Lim.	◀		01.87	02.93	- ABS					
	1.6 Kombi			01.87	02.93	- ABS	11.0441-5402.2	250028			Dichtungssatz ATE
	1.6 Lim.			01.87	02.93	- ABS	11.0101-5407.2	260011			Hülsensatz ATE
	1.8 Kombi			01.87	02.93	- ABS	11.8171-0008.1	990049			Führungsbolzen ATE
	1.8 Lim.			01.87	02.93	- ABS					
	1.8 TD Kombi			08.88	02.93	- ABS					
	1.8 TD Lim.			01.90	02.93	- ABS					
	2.0 i 4x4			01.90	02.93	- ABS					
	2.0 i Kombi			01.87	02.93	- ABS					
	2.0 i Lim.			01.87	02.93	- ABS					
	2.0 Kombi			01.87	02.93	- ABS					
	2.0 Lim.			01.87	02.93	- ABS					
	2.3 D Kombi			01.87	02.93	- ABS					
	2.3 D Lim.			01.87	02.93	- ABS					
	1.6 Kombi			01.87	02.93	+ ABS	11.0441-6003.2	250037			Dichtungssatz ATE
	1.6 Lim.			01.87	02.93	+ ABS	11.0101-5407.2	260011			Hülsensatz ATE
	1.8 Kombi			01.87	02.93	+ ABS	11.8171-0008.1	990049			Führungsbolzen ATE
	1.8 Lim.			01.87	02.93	+ ABS	11.8116-0052.1	390496	2		Haltefeder ATE
	1.8 TD Kombi			08.88	02.93	+ ABS					
	1.8 TD Lim.			01.90	02.93	+ ABS					
	2.0 i 4x4			01.90	02.93	+ ABS					
	2.0 Kombi			01.87	02.93	+ ABS					
	2.0 Lim.			01.87	02.93	+ ABS					
	2.3 D Kombi			01.87	02.93	+ ABS					
	2.3 D Lim.			01.87	02.93	+ ABS					
	2.8 i 4x4 Kombi			01.87	02.93						
	2.8 i Kombi			01.87	02.93						
	2.8 i Lim.			01.87	08.88						
	2.9 i 4x4 Kombi			08.88	02.93						
	2.9 i 4x4 Lim.			08.88	02.93						
	2.9 i Kombi			08.88	02.93						
	2.9 i Lim.			08.88	02.93						

1) 9" brake / servofreno da 9" / frein de 9" / freno de 9"
 2) 10" brake / servofreno da 10" / frein de 10" / freno de 10"
 3) R engine/ - air conditioning / motore di serie/ - aria condizionata / mot.en ligne/ - air conditionné / motor de RV-aire acondicionado
 4) - ABS/ + RA drum brake / - ABS/ + P freno a tamburo / - ABS/ + fr. à tambour essieu AR / - ABS/ + ET tambores de freno



FORD SIERRA (87-93)

	2.0 RS Cosworth Turbo		01.87	12.89		13.0441-4015.2	250080		Dichtungssatz	ATE							
	2.0 RS Cosworth T.4x4		01.90	02.93		11.0441-6007.2	250146		Dichtungssatz	ATE							
						11.0101-5407.2	260011		Hülzensatz	ATE							
						11.8171-0008.1	990049		Führungsbolzen	ATE							
	1.6 Kombi		01.87	02.93	- ABS	13.0460-7071.2	607071		20640	17,5 +	ATE						
	1.6 Lim.		01.87	02.93	- ABS												
	1.8 Kombi		01.87	02.93	- ABS												
	1.8 Lim.		01.87	02.93	- ABS												
	1.8 TD Kombi		08.88	02.93	- ABS												
	1.8 TD Lim.		01.90	02.93	- ABS												
	2.0 i 4x4		01.90	02.93	- ABS												
	2.0 i Kombi		01.87	02.93	- ABS												
	2.0 i Lim.		01.87	02.93	- ABS												
	2.0 Kombi		01.87	02.93	- ABS												
	2.0 Lim.		01.87	02.93	- ABS												
	2.3 D Kombi		01.87	02.93	- ABS												
	2.3 D Lim.		01.87	02.93	- ABS												
	1.6 Kombi		01.87	02.93	+ ABS							13.0460-7040.2	607040		20907	18,0 +	ATE
	1.6 Lim.		01.87	02.93	+ ABS												
	1.8 Kombi		01.87	02.93	+ ABS												
	1.8 Lim.		01.87	02.93	+ ABS												
	1.8 TD Kombi		08.88	02.93	+ ABS												
	1.8 TD Lim.		01.90	02.93	+ ABS												
	2.0 i 4x4		01.90	02.93	+ ABS												
	2.0 i Kombi		01.87	02.93	+ ABS												
	2.0 i Lim.		01.87	02.93	+ ABS												
	2.0 Kombi		01.87	02.93	+ ABS												
	2.0 Lim.		01.87	02.93	+ ABS												
	2.3 D Kombi		01.87	02.93	+ ABS												
	2.3 D Lim.		01.87	02.93	+ ABS												
	2.8 i 4x4 Kombi		01.87	02.93													
	2.8 i Kombi		01.87	02.93													
	2.8 i Lim.		01.87	08.88													
	2.9 i 4x4 Kombi		08.88	02.93													
	2.9 i 4x4 Lim.		08.88	02.93													
	2.9 i Kombi		08.88	02.93													
	2.9 i Lim.		08.88	02.93													
	1.6 Kombi		01.87	02.93	- ABS	24.0124-0112.1	424112		240	24,2 22,2 V +B							
	1.6 Lim.		01.87	02.93	- ABS												
	1.8 Kombi		01.87	02.93	- ABS												
	1.8 Lim.		01.87	02.93	- ABS												
	1.8 TD Kombi		08.88	02.93	- ABS												
	1.8 TD Lim.		01.90	02.93	- ABS												
	2.0 i Kombi		01.87	02.93	- ABS/ + HA-Trommelbremse ¹⁾												
	2.0 i Lim.		01.87	02.93	- ABS/ + HA-Trommelbremse ¹⁾												
	2.0 Kombi		01.87	02.93	- ABS												
	2.0 Lim.		01.87	02.93	- ABS												
	2.3 D Kombi		01.87	02.93	- ABS												
	2.3 D Lim.		01.87	02.93	- ABS												
	1.6 Kombi		01.87	02.93	+ ABS							24.0124-0113.1	424113		260	24,2 22,2 V	
	1.6 Lim.		01.87	02.93	+ ABS												
	1.8 Kombi		01.87	02.93	+ ABS												
	1.8 Lim.		01.87	02.93	+ ABS												
	1.8 TD Kombi		08.88	02.93	+ ABS												
	1.8 TD Lim.		01.90	02.93	+ ABS												
	2.0 i Kombi		01.87	02.93	- ABS/ + HA-Scheibenbremse ²⁾												
	2.0 i Lim.		01.87	02.93	- ABS/ + HA-Scheibenbremse ²⁾												
	2.3 D Kombi		01.87	02.93	+ ABS												
	2.3 D Lim.		01.87	02.93	+ ABS												
	2.8 i 4x4 Kombi		01.87	02.93													
	2.8 i Kombi		01.87	02.93													
	2.8 i Lim.		01.87	02.93													
	2.9 i 4x4 Kombi		08.88	02.93													
	2.9 i 4x4 Lim.		08.88	02.93													
	2.9 i Kombi		08.88	02.93													
	2.9 i Lim.		08.88	02.93													
	2.0 i 4x4 Kombi		05.89	02.93		24.0124-0151.1	424151		260	24,3 22,8 V							
	2.0 i 4x4 Lim.		01.90	02.93	+ ABS												
	2.8 i 4x4 Kombi		01.87	08.88													
	2.9 i 4x4 Kombi		08.88	02.93													
	2.9 i 4x4 Lim.		08.88	02.93													
	2.0 RS Cosworth T.4x4		01.90	02.93		24.0124-0148.1	424148		278	24,0 22,2 V							
	1.6 Kombi		01.87	02.93		24.5305-0310.3	331326	2	L=310								
	1.6 Lim.		01.87	02.93													
	1.8 Kombi		01.87	02.93													
	1.8 Lim.		01.87	02.93													
	1.8 TD Kombi		08.88	02.93													
	1.8 TD Lim.		01.90	02.93													
	2.0 i 4x4 Kombi		05.89	02.93													
	2.0 i 4x4 Lim.		01.90	02.93													
	2.0 i Kombi		01.87	02.93													
	2.0 i Lim.		01.87	02.93													
	2.0 Kombi		01.87	02.93													
	2.0 Lim.		01.87	02.93													
	2.0 RS Cosworth Turbo		01.87	02.93													
	2.3 D Kombi		01.87	02.93													

¹⁾ - ABS/ + RA drum brake / - ABS/ + P freno a tamburo / - ABS/ + fr. à tambour essieu AR / - ABS/ + ET tambores de freno















²⁾ - ABS/ + RA disc brake / - ABS/ + P disco freno / - ABS/ + fr. à disque essieu AR / - ABS/ + ET disco de freno





FORD SIERRA (87-93)

	2.3 D Lim. 2.8 i 4x4 Kombi 2.8 i Kombi 2.8 i Lim. 2.9 i 4x4 Kombi 2.9 i 4x4 Lim. 2.9 i Kombi 2.9 i Lim.		01.87 02.93 01.87 02.93 01.87 02.93 01.87 02.93 08.88 02.93 08.88 02.93 08.88 02.93 08.88 02.93	24.5305-0310.3	331326	2		L=310	
	1.6 Kombi 1.6 Lim. 1.8 Kombi 1.8 Lim. 1.8 TD Kombi 1.8 TD Lim. 2.0 i 4x4 Kombi 2.0 i 4x4 Lim. 2.0 i Kombi 2.0 i Lim. 2.0 Kombi 2.0 Lim. 2.0 RS Cosworth Turbo 2.8 i 4x4 Kombi 2.8 i Kombi 2.8 i Lim. 2.9 i 4x4 Kombi 2.9 i 4x4 Lim. 2.9 i Kombi 2.9 i Lim.		01.87 02.93 + ABS 01.87 02.93 + ABS 01.87 02.93 + ABS 01.87 02.93 + ABS 08.88 02.93 + ABS 01.87 02.93 + ABS 05.89 02.93 01.90 02.93 01.87 02.93 - ABS 01.87 02.93 - ABS 01.87 02.93 + ABS 01.87 02.93 + ABS 01.87 12.89 01.87 02.93 01.87 02.93 01.87 02.93 08.88 02.93 08.88 02.93 08.88 02.93 08.88 02.93 08.88 02.93	24.3434-1601.5 24.3434-1602.5 24.0101-4301.2	240019 240020 260047	<input type="checkbox"/> <input type="checkbox"/>		D=43, - Halter D=43, - Halter Bremsattel-Zubehör	TRW TRW TRW
	1.6 Kombi 1.6 Lim. 1.8 Kombi 1.8 Lim. 1.8 TD Kombi 1.8 TD Lim. 2.0 i 4x4 Kombi 2.0 i 4x4 Lim. 2.0 i Kombi 2.0 i Lim. 2.0 Kombi 2.0 Lim. 2.0 RS Cosworth Turbo 2.8 i 4x4 Kombi 2.8 i Kombi 2.8 i Lim. 2.9 i 4x4 Kombi 2.9 i 4x4 Lim. 2.9 i Kombi 2.9 i Lim.		01.87 02.93 + ABS 01.87 02.93 + ABS 01.87 02.93 + ABS 01.87 02.93 + ABS 08.88 02.93 + ABS 01.90 02.93 + ABS 05.89 02.93 01.90 02.93 01.87 02.93 - ABS 01.87 02.93 - ABS 01.87 02.93 + ABS 01.87 02.93 + ABS 01.87 12.89 01.87 02.93 01.87 02.93 01.87 08.88 08.88 02.93 08.88 02.93 08.88 02.93 08.88 02.93	13.0460-2928.2	602928			20981 13,8 /S	TRW
	1.6 Kombi 1.6 Lim. 1.8 Kombi 1.8 Lim. 1.8 TD Kombi 1.8 TD Lim. 2.0 i 4x4 Kombi 2.0 i 4x4 Lim. 2.0 i Kombi 2.0 i Lim. 2.0 Kombi 2.0 Lim. 2.0 RS Cosworth Turbo 2.8 i 4x4 Kombi 2.8 i Kombi 2.8 i Lim. 2.9 i 4x4 Kombi 2.9 i 4x4 Lim. 2.9 i Kombi 2.9 i Lim.		01.87 02.93 + ABS 01.87 02.93 + ABS 01.87 02.93 + ABS 01.87 02.93 + ABS 08.88 02.93 + ABS 01.90 02.93 + ABS 05.89 02.93 01.90 02.93 01.87 02.93 - ABS 01.87 02.93 - ABS 01.87 02.93 + ABS 01.87 02.93 + ABS 01.87 12.89 01.87 02.93 01.87 02.93 01.87 02.93 08.88 02.93 08.88 02.93 08.88 02.93 08.88 02.93	24.0110-0115.1	410115			253 10,2 8,9 +B	
	1.6 Kombi 1.6 Lim. 1.8 Kombi 1.8 Lim. 1.8 TD Kombi 1.8 TD Lim. 2.0 i Kombi 2.0 i Lim. 2.0 Kombi 2.0 Lim. 2.3 D Kombi 2.3 D Lim.		01.87 02.93 01.87 02.93 01.87 02.93 01.87 02.93 08.88 02.93 01.90 02.93 01.87 02.93 01.87 02.93 01.87 02.93 01.87 02.93 01.87 02.93 01.87 02.93	24.5302-0296.3	330476	2		L=295	
	1.6 Kombi 1.6 Lim. 1.8 Kombi 1.8 Lim. 1.8 TD Kombi 1.8 TD Lim. 2.0 i 4x4 Kombi 2.0 i 4x4 Lim.		01.87 02.93 + ABS 01.87 02.93 + ABS 01.87 02.93 + ABS 01.87 02.93 + ABS 08.88 02.93 + ABS 01.90 02.93 + ABS 05.89 02.93 + ABS 01.90 02.93 + ABS	83.6327-0180.3	330740	2		L=180	

FORD SIERRA (87-93)											
											
	2.0 i Kombi 2.0 i Lim. 2.0 Kombi 2.0 Lim. 2.0 RS Cosworth Turbo 2.8 i 4x4 Kombi 2.8 i Kombi 2.8 i Lim. 2.9 i 4x4 Kombi 2.9 i 4x4 Lim. 2.9 i Kombi 2.9 i Lim.			01.87 02.93 + ABS 01.87 02.93 + ABS 01.87 02.93 + ABS 01.87 02.93 + ABS 01.87 12.89 01.87 02.93 01.87 02.93 01.87 02.93 08.88 02.93 08.88 02.93 08.88 02.93 08.88 02.93		83.6327-0180.3	330740	2		L=180	
	1.8 Lim. 1.8 TD Lim. 2.0 i 4x4 Lim. 2.0 i Lim. 2.0 Lim. 2.3 D Lim. 2.9 i 4x4 Lim.			01.87 02.93 - ABS 01.90 02.93 - ABS 01.90 02.93 - ABS 01.87 02.93 - ABS 01.87 02.93 - ABS 01.87 02.93 - ABS 08.88 02.93 - ABS		24.3220-1112.3	020223		9" Bremse ¹⁾	Rz 20,64	
	1.6 Kombi 1.8 Kombi 1.8 TD Kombi 2.0 i 4x4 Kombi 2.0 i Kombi 2.0 Kombi 2.3 D Kombi 2.8 i 4x4 Kombi 2.9 i 4x4 Kombi			01.87 02.93 - ABS 01.87 02.93 - ABS 08.88 02.93 - ABS 05.89 02.93 - ABS 01.87 02.93 - ABS 01.87 02.93 - ABS 01.87 02.93 - ABS 01.87 02.93 - ABS 08.88 02.93 - ABS		24.3222-1117.3	020272		10" Bremse ²⁾	Rz 22,20	
	1.6 Kombi 1.8 Kombi 1.8 Lim. 1.8 TD Kombi 1.8 TD Lim. 2.0 i Kombi 2.0 i Lim. 2.0 Kombi 2.0 Lim. 2.3 D Kombi 2.3 D Lim.			01.87 02.93 - ABS 01.87 02.93 - ABS 01.87 02.93 - ABS 08.88 02.93 - ABS 01.90 02.93 - ABS 01.87 02.93 - ABS 01.87 02.93 - ABS 01.87 02.93 - ABS 01.87 02.93 - ABS 01.87 02.93 - ABS 01.87 02.93 - ABS		03.0137-0157.2 03.0137-9046.2	650157 669046			229 x 58 HEB Bremsbacken-Zubehör	TRW TRW
	1.6 Lim. 1.6 Kombi 1.8 Kombi 1.8 Lim. 1.8 TD Kombi 1.8 TD Lim. 2.0 i Kombi 2.0 i Lim. 2.0 Kombi 2.0 Lim. 2.3 D Kombi 2.3 D Lim.			01.87 02.93 - ABS 01.87 02.93 - ABS 01.87 02.93 - ABS 08.88 02.93 - ABS 01.90 02.93 - ABS 01.87 02.93 - ABS 01.87 02.93 - ABS 01.87 02.93 - ABS 01.87 02.93 - ABS 01.87 02.93 - ABS 01.87 02.93 - ABS		24.0220-3001.2 24.0222-8010.2	480020 480027			203/204 x 45 229/229,4 x 64	
	1.8 Lim. 1.8 TD Lim. 2.0 i 4x4 Lim. 2.0 i Lim. 2.0 Lim. 2.3 D Lim. 2.8 i Lim. 2.9 i 4x4 Lim. 2.9 i Lim.			01.87 02.93 - ABS 01.90 02.93 - ABS 01.90 02.93 - ABS 01.87 02.93 - ABS 01.87 02.93 - ABS 01.87 02.93 - ABS 08.88 02.93 - ABS 08.88 02.93 - ABS 08.88 02.93 - ABS		03.0420-0220.3	680220			20,64/229x58 Kit	TRW
	1.6 Kombi 1.6 Lim. 1.8 Kombi 1.8 Lim. 1.8 TD Kombi 1.8 TD Lim. 2.0 i 4x4 Kombi 2.0 i 4x4 Lim. 2.0 i Kombi 2.0 i Lim. 2.0 Kombi 2.0 Lim. 2.3 D Kombi 2.3 D Lim. 2.8 i Kombi 2.8 i Lim.			01.87 02.93 - ABS 01.87 02.93 - ABS 01.87 02.93 - ABS 01.87 02.93 - ABS 08.88 02.93 - ABS 01.90 02.93 - ABS 05.89 02.93 - ABS 01.90 02.93 - ABS 01.87 02.93 - ABS 01.87 02.93 - ABS 01.87 02.93 - ABS 01.87 02.93 - ABS 01.87 02.93 - ABS 01.87 02.93 - ABS 01.87 02.93 - ABS		24.3727-0616.2	580616	1	↓		L=3313
	1.6 Kombi 1.6 Lim. 1.8 Kombi 1.8 Lim. 2.0 i 4x4 Kombi 2.0 i 4x4 Lim. 2.0 i Kombi 2.0 i Lim. 2.0 Kombi 2.0 Lim. 2.3 D Kombi 2.3 D Lim. 2.8 i Kombi 2.8 i Lim.			01.87 02.93 + ABS 01.87 02.93 + ABS 01.87 02.93 + ABS 01.87 02.93 + ABS 05.89 02.93 + ABS 01.90 02.93 + ABS 01.87 02.93 + ABS 01.87 02.93 + ABS 01.87 02.93 + ABS 01.87 02.93 + ABS 01.87 02.93 + ABS 01.87 02.93 + ABS 01.87 02.93 + ABS 01.87 02.93 + ABS		24.3727-0624.2	580624	1	↓		L=3375

¹⁾ 9" brake / servofreno da 9" / frein de 9" / freno de 9"

²⁾ 10" brake / servofreno da 10" / frein de 10" / freno de 10"



FORD SIERRA (87-93)

	2.0 RS Cosworth T.4x4 2.0 RS Cosworth Turbo 2.3 D Kombi 2.3 D Lim. 2.8 i Kombi 2.8 i Lim. 2.9 i 4x4 Kombi 2.9 i 4x4 Lim. 2.9 i Kombi 2.9 i Lim.			01.90 01.87 01.87 01.87 01.87 01.87 08.88 08.88 08.88 08.88	02.93 02.93 + ABS + ABS + ABS + ABS + ABS + ABS + ABS + ABS	24.3727-0624.2	580624	1		L=3375
--	--	--	--	--	--	----------------	--------	---	--	--------

FORD TAUNUS / CORTINA (GB) (70-82)

	alle Typen			07.70	08.78 + Bremsgerät ¹⁾	03.2120-5503.3	010124			THz 20,64 + Behälter	ATE
	alle Typen			09.78	+ Bremsgerät ¹⁾	03.2120-0151.3	010071			THz 20,64	ATE
	1.1 1.3 1.6 1.6 Lim. 2.0 2.0 Lim. 2.3 alle Typen	51 65 51		01.70 07.70 07.70 07.70 07.70 07.70 08.71 07.70	09.82 09.82 09.82 09.82 09.82 09.82 09.82 09.82	13.0441-5409.2	250112			Dichtungssatz	ATE
	1.1 1.3 1.6 1.6 Lim. 2.0 2.0 Lim. 2.3 alle Typen	51 65 51		01.70 07.70 07.70 07.70 07.70 07.70 08.71 07.70	09.82 09.82 09.82 09.82 09.82 09.82 09.82 09.82	13.0460-7042.2 13.0460-0126.2	607042 610126			20491 15,0 Belagsatz-Zubehör	TRW TRW
	1.1 1.3 1.6 1.6 Lim. 2.0 2.0 Lim. 2.3 alle Typen	51 65 51		01.70 07.70 07.70 07.70 07.70 07.70 08.71 07.70	09.82 09.82 09.82 09.82 09.82 09.82 09.82 09.82	24.0113-0122.1	413122			248 12,7 11,4	
	1.3 Kombi 1.3 Lim. 1.6 Kombi 1.6 Lim.	51		07.70 07.70 07.70 07.70	03.71 03.71 - verstärkte Bremse ²⁾ - verstärkte Bremse ²⁾	24.3220-1112.3	020223			Rz 20,64	
	1.3 Kombi 1.3 Lim. 1.6 Kombi			07.70 04.71 07.70	12.75 12.75 + verstärkte Bremse ³⁾ + verstärkte Bremse ³⁾	24.3219-1107.3	020338		nur paarweise austauschen ⁴⁾	Rz 19,05	TRW
	1.6 Lim. 2.0 Lim.	65		07.70 07.70	12.75 12.75	24.3217-1706.3	020044			Rz 17,78	
	1.3 Kombi 1.6 Kombi			01.76 01.76	09.82 09.82 - (S)	24.3219-1107.3	020338		nur paarweise austauschen ⁴⁾	Rz 19,05	TRW
	1.6 Kombi 1.6 Lim. 2.0 Lim.			01.76 01.76 01.76	09.82 09.82 + (S) 09.82	24.3217-1715.3	020463		9" Bremse/nur paarw. tauschen ⁵⁾	Rz 17,78	TRW
	alle Typen			07.70	07.79	03.0137-9013.2	669013			Bremsbacken-Zubehör	TRW
	alle Typen Lim.			01.76	09.82	24.0220-3001.2	480020			203/204 x 45	

FORD Transit FK1000/FK1250 (59-65)

	FK 1000 FK 1250			01.59 01.59	12.65 12.65	24.3526-0810.3	340037	1		Bremslichtschalter	
--	--------------------	--	--	----------------	----------------	----------------	--------	---	--	--------------------	--

FORD TRANSIT (65-77)

	FT 100/L FT 115 FT 120 FT 125 FT 130 FT 150 FT 175 FT 190 FT 60 FT 75			11.73 11.73 11.73 11.73 11.73 11.73 11.73 11.73 11.73 11.73	12.77 12.77 12.77 12.77 12.77 12.77 12.77 12.77 12.77 12.77	13.0460-6910.2 13.0460-6911.2 13.0460-0414.2 13.0460-0415.2	606910 606911 610414 610415		+ 2-Kolbensattel ⁶⁾ + 4-Kolbensattel ⁷⁾ + 2-Kolbensattel ⁶⁾ + 4-Kolbensattel ⁷⁾	20364 15,0 +/-Zub 20359 18,0 /Zub Belagsatz-Zubehör Belagsatz-Zubehör	AP AP AP AP
	FT 100/L FT 115 FT 120 FT 125 FT 130 FT 150			11.73 11.73 11.73 11.73 11.73 11.73	12.77 12.77 12.77 12.77 12.77 12.77	24.0114-0100.1	414100			270 14,3 12,9	

1) + booster unit / + servofreno / + servo-frein / + servofreno
2) - heavy duty brake / - freno rinforzato / - frein renforcé / - freno reforzado
3) + heavy duty brake / + freno rinforzato / + frein renforcé / + freno reforzado
4) to change only by pairs / sostituire solo a coppie / à changer seulement par paires / cambiar solamente por parejas
5) 9"br./to change only by pairs / servofr.9"/sosti.solo coppie / fr.d.9"/chang.seulem.p.paires / fr.de 9"/camb.solam.p.parejas
6) + 2 piston caliper / + pinza freno a 2 pistoni / + étrier à 2 pistons / + pinza de dos pistones
7) + 4 piston caliper / + pinza freno a 4 pistoni / + étrier à 4 pistons / + pinza con 4 pistones



FORD TRANSIT (65-77)







	FT 175 FT 190 FT 60 FT 75			11.73 11.73 11.73 11.73	12.77 12.77 12.77 12.77	24.0114-0100.1	414100			270 14,3 12,9
	FT 100/L FT 115 FT 120 FT 125 FT 130 FT 150 FT 175 FT 190 FT 60 FT 75			09.65 09.65 09.65 09.65 09.65 09.65 09.65 09.65 09.65 09.65	05.76 05.76 05.76 05.76 05.76 05.76 05.76 05.76 05.76 05.76	83.6104-0450.3	330251	2	+ VA-Trommelbremse ¹⁾	L=450
	FT 100/L FT 115 FT 120 FT 125 FT 130 FT 150 FT 175 FT 190 FT 60 FT 75			11.68 11.68 11.68 11.68 11.68 11.68 11.68 11.68 11.68 11.68	08.76 08.76 08.76 08.76 08.76 08.76 08.76 08.76 08.76 08.76	83.6104-0450.3	330251	2	+ VA-Trommelbremse ¹⁾	L=450
	FT 100/L FT 115 FT 120 FT 125 FT 75			06.76 06.76 06.76 08.76 06.76	12.77 12.77 12.77 12.77 12.77	24.3727-0619.2	580619	1	↓	L=2875

FORD TRANSIT (78-85)

	1.6 Bus 1.6 Kasten 1.6 Pritsche/Fahrg. 2.0 Bus 2.0 Bus 2.0 Kasten 2.0 Kasten 2.0 Kasten 2.0 Pritsche/Fahrg. 2.0 Pritsche/Fahrg. 2.4 D Bus 2.4 D Kasten 2.4 D Pritsche/Fahrg. 2.5 D Bus 2.5 D Kasten 2.5 D Pritsche/Fahrg.	48 48 48 43 55 57 43 55 57 43 57 46 46 46 50 50 50		04.80 04.80 04.80 04.80 04.80 04.80 04.80 04.80 04.80 04.80 04.80 04.80 04.80 04.80 04.80 04.80 04.80	10.85 10.85 10.85 10.85 10.85 10.85 10.85 10.85 10.85 10.85 10.85 10.85 10.85 10.85 10.85 10.85 10.85	FT80/100L/115/120 FT80/100L/115/120 FT80/100L/115/120 FT80/100L/115/120 FT80/100L/115/120 FT80/100L/115/120 FT80/100L/115/120 FT80/100L/115/120 FT80/100L/115/120 FT80/100L/115/120 FT80/100L/115/120 FT80/100L/115/120 FT80/100L/115/120 FT80/100L/115/120 FT80/100L/115/120 FT80/100L/115/120 FT80/100L/115/120	24.2122-1702.3	010421		Thz 22,20	
	1.6 Bus 1.6 Kasten 1.6 Pritsche/Fahrg. 2.0 Bus 2.0 Bus 2.0 Kasten 2.0 Kasten 2.0 Kasten 2.0 Pritsche/Fahrg. 2.0 Pritsche/Fahrg. 2.4 D Bus 2.4 D Kasten 2.4 D Pritsche/Fahrg. 2.5 D Bus 2.5 D Kasten 2.5 D Pritsche/Fahrg.	48 48 48 43 55 57 43 55 57 43 57 46 46 46 50 50 50		01.78 01.78 01.78 01.78 01.78 01.78 01.78 01.78 01.78 01.78 01.78 01.78 01.78 01.78 01.78 01.78 01.78	10.85 10.85 10.85 10.85 10.85 10.85 10.85 10.85 10.85 10.85 10.85 10.85 10.85 10.85 10.85 10.85 10.85	FT80/100L/115/120 FT80/100L/115/120 FT80/100L/115/120 FT80/100L/115/120 FT80/100L/115/120 FT80/100L/115/120 FT80/100L/115/120 FT80/100L/115/120 FT80/100L/115/120 FT80/100L/115/120 FT80/100L/115/120 FT80/100L/115/120 FT80/100L/115/120 FT80/100L/115/120 FT80/100L/115/120 FT80/100L/115/120 FT80/100L/115/120	13.0460-6910.2 13.0460-6911.2 13.0460-0414.2 13.0460-0415.2	606910 606911 610414 610415	+ 2-Kolbensattel ²⁾ + 4-Kolbensattel ³⁾ + 2-Kolbensattel ²⁾ + 4-Kolbensattel ³⁾	20364 15,0 +/Zub 20359 18,0 /Zub Belagsatz-Zubehör Belagsatz-Zubehör	AP AP AP AP
	1.6 Bus 1.6 Kasten 1.6 Pritsche/Fahrg. 2.0 Bus 2.0 Bus 2.0 Kasten 2.0 Kasten 2.0 Kasten 2.0 Pritsche/Fahrg. 2.0 Pritsche/Fahrg. 2.4 D Bus 2.4 D Kasten 2.4 D Pritsche/Fahrg. 2.5 D Bus 2.5 D Kasten 2.5 D Pritsche/Fahrg.	48 48 48 43 55 57 43 55 57 43 57 46 46 46 50 50 50		01.78 01.78 01.78 01.78 01.78 01.78 01.78 01.78 01.78 01.78 01.78 01.78 01.78 01.78 01.78 01.78	03.80 03.80 03.80 03.80 03.80 03.80 03.80 03.80 03.80 03.80 03.80 03.80 03.80 03.80 03.80 03.80 03.80	FT80/100L/115/120 FT80/100L/115/120 FT80/100L/115/120 FT80/100L/115/120 FT80/100L/115/120 FT80/100L/115/120 FT80/100L/115/120 FT80/100L/115/120 FT80/100L/115/120 FT80/100L/115/120 FT80/100L/115/120 FT80/100L/115/120 FT80/100L/115/120 FT80/100L/115/120 FT80/100L/115/120 FT80/100L/115/120 FT80/100L/115/120	24.0114-0100.1	414100		270 14,3 12,9	
	1.6 Bus 1.6 Kasten 1.6 Pritsche/Fahrg. 2.0 Bus 2.0 Bus	48 48 48 43 55		01.78 01.78 01.78 01.78 01.78	10.85 10.85 10.85 10.85 10.85	FT80/100L/115/120 FT80/100L/115/120 FT80/100L/115/120 FT80/100L/115/120 FT80/100L/115/120	03.0137-9230.2	669230		Bremsbacken-Zubehör	

¹⁾ + FA drum brake / + A freno a tamburo / + frein à tambour ess.AV / + ED tambores de freno
²⁾ + 2 piston caliper / + pinza freno a 2 pistoni / + étrier à 2 pistons / + pinza de dos pistones
³⁾ + 4 piston caliper / + pinza freno a 4 pistoni / + étrier à 4 pistons / + pinza con 4 pistones



FORD TRANSIT (86-91)												
	2.0 Pritsche/Fahrg.	57	01.86	09.92	FT80/100/115/120	24.0114-0103.1	414103		254 14,3 12,9			
	2.5 D Bus	50	12.85	01.89	FT80/100/115/120							
	2.5 D Bus	52	09.88	09.92	FT80/100/115/120							
	2.5 D Kasten	50	01.86	09.91	FT80/100/115/120							
	2.5 D Kasten	52	10.88	09.91	FT80/100/115/120							
	2.5 D Pritsche/Fahrg.	50	01.86	01.89	FT80/100/115/120							
	2.5 DI Prits./Fahrg.	52	09.88	09.92	FT80/100/115/120							
	1.6 Bus	46	12.85	01.89	FT100L/130/160/190/190A					24.0114-0100.1	414100	270 14,3 12,9
	1.6 Kasten	46	09.85	09.92	FT100L/130/160/190/190A							
	2.0 Bus	57	11.85	09.92	FT100L/130/160/190/190A							
2.0 Bus KAT	57	12.85	09.92	FT100L/130/160/190/190A								
2.0 Kasten	57	09.85	09.92	FT100L/130/160/190/190A								
2.0 Prits./Fahrg. KAT	57	11.85	09.92	FT100L/130/160/190/190A								
2.0 Pritsche/Fahrg.	57	01.86	09.92	FT100L/130/160/190/190A								
2.5 D Bus	50	12.85	01.89	FT100L/130/160/190/190A								
2.5 D Bus	52	09.88	09.92	FT100L/130/160/190/190A								
2.5 D Kasten	50	01.86	09.91	FT100L/130/160/190/190A								
2.5 D Kasten	52	10.88	09.91	FT100L/130/160/190/190A								
2.5 D Pritsche/Fahrg.	50	01.86	01.89	FT100L/130/160/190/190A								
2.5 DI Prits./Fahrg.	52	09.88	09.92	FT100L/130/160/190/190A								
	1.6 Bus	46	12.85	01.89	FT80/100/115/120	24.5245-0405.3	330686	2	vertikal Bremssystem 1)	L=405		
	1.6 Kasten	46	09.85	09.92								
	2.0 Bus	57	11.85	09.92								
	2.0 Bus KAT	57	12.85	09.92								
	2.0 Kasten	57	09.85	09.92								
	2.0 Prits./Fahrg. KAT	57	11.85	09.92								
	2.0 Pritsche/Fahrg.	57	01.86	09.92								
	2.5 D Bus	50	12.85	01.89								
	2.5 D Bus	52	09.88	09.92								
	2.5 D Kasten	50	01.86	09.91								
2.5 D Kasten	52	10.88	09.91									
2.5 D Pritsche/Fahrg.	50	01.86	01.89									
2.5 DI Prits./Fahrg.	52	09.88	09.92									
	1.6 Bus	46	12.85	01.89	FT80/100/115/120	03.0137-0254.2	650254		229 x 45			
	1.6 Kasten	46	09.85	09.92	FT80/100/115/120							
	2.0 Bus	57	11.85	09.92	FT80/100/115/120							
	2.0 Bus KAT	57	12.85	09.92	FT80/100/115/120							
	2.0 Kasten	57	09.85	09.92	FT80/100/115/120							
	2.0 Prits./Fahrg. KAT	57	11.85	09.92	FT80/100/115/120							
	2.0 Pritsche/Fahrg.	57	01.86	09.92	FT80/100/115/120							
	2.5 D Bus	50	12.85	01.89	FT80/100/115/120							
	2.5 D Bus	52	09.88	09.92	FT80/100/115/120							
	2.5 D Kasten	50	01.86	09.91	FT80/100/115/120							
2.5 D Kasten	52	10.88	09.91	FT80/100/115/120								
2.5 D Pritsche/Fahrg.	50	01.86	01.89	FT80/100/115/120								
2.5 DI Prits./Fahrg.	52	09.88	09.92	FT80/100/115/120								
	1.6 Bus	46	12.85	01.89	FT130/160/190/190A	03.0137-0292.2	650292		254 x 70/56			
	1.6 Kasten	46	09.85	09.92	FT130/160/190/190A							
	2.0 Bus	57	11.85	09.92	FT130/160/190/190A							
	2.0 Bus KAT	57	12.85	09.92	FT130/160/190/190A							
	2.0 Kasten	57	09.85	09.92	FT130/160/190/190A							
	2.0 Prits./Fahrg. KAT	57	11.85	09.92	FT130/160/190/190A							
	2.0 Pritsche/Fahrg.	57	01.86	09.92	FT130/160/190/190A							
	2.5 D Bus	50	12.85	01.89	FT130/160/190/190A							
	2.5 D Bus	52	09.88	09.92	FT130/160/190/190A							
	2.5 D Kasten	50	01.86	09.91	FT130/160/190/190A							
2.5 D Kasten	52	10.88	09.91	FT130/160/190/190A								
2.5 D Pritsche/Fahrg.	50	01.86	01.89	FT130/160/190/190A								
2.5 DI Prits./Fahrg.	52	09.88	09.92	FT130/160/190/190A								
	1.6 Bus	46	12.85	01.89	FT80/100/115/120	24.0222-8011.1	480028		229/230 x 54			
	1.6 Kasten	46	09.85	09.92	FT80/100/115/120							
	2.0 Bus	57	11.85	09.92	FT80/100/115/120							
	2.0 Bus KAT	57	12.85	09.92	FT80/100/115/120							
	2.0 Kasten	57	09.85	09.92	FT80/100/115/120							
	2.0 Prits./Fahrg. KAT	57	11.85	09.92	FT80/100/115/120							
	2.0 Pritsche/Fahrg.	57	01.86	09.92	FT80/100/115/120							
	2.5 D Bus	50	12.85	01.89	FT80/100/115/120							
	2.5 D Bus	52	09.88	09.92	FT80/100/115/120							
	2.5 D Kasten	50	01.86	09.91	FT80/100/115/120							
2.5 D Kasten	52	10.88	09.91	FT80/100/115/120								
2.5 D Pritsche/Fahrg.	50	01.86	01.89	FT80/100/115/120								
2.5 DI Prits./Fahrg.	52	09.88	09.92	FT80/100/115/120								
	1.6 Bus	46	12.85	01.89	FT80/100/115/120	24.3727-0631.2	580631	1	L=2968			
	1.6 Kasten	46	09.85	09.92	FT80/100/115/120							
	2.0 Bus	57	11.85	09.92	FT80/100/115/120							
	2.0 Bus KAT	57	12.85	09.92	FT80/100/115/120							
	2.0 Kasten	57	09.85	09.92	FT80/100/115/120							
	2.0 Prits./Fahrg. KAT	57	11.85	09.92	FT80/100/115/120							
	2.0 Pritsche/Fahrg.	57	01.86	09.92	FT80/100/115/120							
	2.5 D Bus	50	12.85	01.89	FT80/100/115/120							
	2.5 D Bus	52	09.88	09.92	FT80/100/115/120							
	2.5 D Kasten	50	01.86	09.91	FT80/100/115/120							
2.5 D Kasten	52	10.88	09.91	FT80/100/115/120								
2.5 D Pritsche/Fahrg.	50	01.86	01.89	FT80/100/115/120								
2.5 DI Prits./Fahrg.	52	09.88	09.92	FT80/100/115/120								
	1.6 Bus	46	12.85	01.89	FT100L	24.3727-0630.2	580630	1	L=2865			

1) vertical brake system / sistema del freno verticale / système de freinage vertical / sistema de freno vertical



FORD TRANSIT (86-91)

	1.6 Kasten	46	09.85	09.92	FT100L	24.3727-0630.2	580630	1	↓	L=2865					
	2.0 Bus	57	11.85	09.92	FT100L										
	2.0 Bus KAT	57	12.85	09.92	FT100L										
	2.0 Kasten	57	09.85	09.92	FT100L										
	2.0 Prits./Fahrg. KAT	57	11.85	09.92	FT100L										
	2.0 Pritsche/Fahrg.	57	01.86	09.92	FT100L										
	2.5 D Bus	50	12.85	01.89	FT100L										
	2.5 D Bus	52	09.88	09.92	FT100L										
	2.5 D Kasten	50	01.86	09.91	FT100L										
	2.5 D Kasten	52	10.88	09.91	FT100L										
	2.5 D Pritsche/Fahrg.	50	01.86	01.89	FT100L										
	2.5 DI Prits./Fahrg.	52	09.88	09.92	FT100L										
	1.6 Bus	46	12.85	01.89	FT/130/160/190/190A						24.3727-0632.2	580632	1	↓	L=2386
	1.6 Kasten	46	09.85	09.92	FT/130/160/190/190A										
	2.0 Bus	57	11.85	09.92	FT/130/160/190/190A										
	2.0 Bus KAT	57	12.85	09.92	FT/130/160/190/190A										
	2.0 Kasten	57	09.85	09.92	FT/130/160/190/190A										
2.0 Prits./Fahrg. KAT	57	11.85	09.92	FT/130/160/190/190A											
2.0 Pritsche/Fahrg.	57	01.86	09.92	FT/130/160/190/190A											
2.5 D Bus	50	12.85	01.89	FT/130/160/190/190A											
2.5 D Bus	52	09.88	09.92	FT/130/160/190/190A											
2.5 D Kasten	50	01.86	09.91	FT/130/160/190/190A											
2.5 D Kasten	52	10.88	09.91	FT/130/160/190/190A											
2.5 D Pritsche/Fahrg.	50	01.86	01.89	FT/130/160/190/190A											
2.5 DI Prits./Fahrg.	52	09.88	09.92	FT/130/160/190/190A											

FORD TRANSIT (92-94)

	2.0 Bus	66	09.91	09.94		24.2123-1724.3	010566		- ABS	THz 23,81	BDX						
	2.0 i Bus	72	09.91	07.94								10.6123-0154.3	010578		+ ABS	THz 23,81	ATE
	2.0 i Kasten	72	09.91	06.94													
	2.0 Kasten	66	09.91	06.94													
	2.0 Pritsche/Fahrg.	72	09.91	08.94													
	2.5 DI Bus	51	08.91	07.94													
	2.5 DI Bus	59	09.91	07.94													
	2.5 DI Kasten	51	05.91	06.94													
	2.5 DI Kasten	59	05.91	06.94													
	2.5 DI Kasten	63	10.92	06.94													
	2.5 DI Prits./Fahrg.	51	09.91	08.94													
	2.5 DI Prits./Fahrg.	59	09.91	08.94													
	2.5 TD Bus	63	10.92	07.94													
	2.5 TD Bus	74	09.91	07.94													
	2.5 TD Kasten	74	05.91	06.94													
	2.5 TD Prits./Fahrg.	63	11.92	08.94													
	2.5 TD Prits./Fahrg.	74	09.91	08.94													
2.9 i Bus	107	01.91	08.94														
	2.0 Bus	66	09.91	09.94		24.3421-1709.5	240697		☐ + 15" Rad ¹⁾	D=42, - Halter	TRW						
	2.0 i Bus	72	09.91	07.94								24.3421-1710.5	240698		☐ + 15" Rad ¹⁾	D=42, - Halter	TRW
	2.0 i Kasten	72	09.91	06.94													
	2.0 Kasten	66	09.91	06.94													
	2.0 Pritsche/Fahrg.	72	09.91	08.94													
	2.5 DI Bus	51	08.91	07.94													
	2.5 DI Bus	59	09.91	07.94													
	2.5 DI Kasten	51	05.91	06.94													
	2.5 DI Kasten	59	05.91	06.94													
	2.5 DI Kasten	63	10.92	06.94													
	2.5 DI Prits./Fahrg.	51	09.91	08.94													
	2.5 DI Prits./Fahrg.	59	09.91	08.94													
	2.5 TD Bus	63	10.92	07.94													
	2.5 TD Bus	74	09.91	07.94													
	2.5 TD Kasten	74	05.91	06.94													
	2.5 TD Prits./Fahrg.	63	11.92	08.94													
	2.5 TD Prits./Fahrg.	74	09.91	08.94													
2.9 i Bus	107	01.91	08.94														
	2.0 Bus	66	09.91	09.94		13.0460-3960.2	603960		+ 14" Rad ²⁾	21470 18,0 /WE	BDX						
	2.0 i Bus	72	09.91	07.94								13.0460-0427.2	610427		+ 14" Rad ²⁾	Belagsatz-Zubehör	BDX
	2.0 i Kasten	72	09.91	06.94													
	2.0 Kasten	66	09.91	06.94													
	2.0 Pritsche/Fahrg.	72	09.91	08.94													
	2.5 DI Bus	51	08.91	07.94													
	2.5 DI Bus	59	09.91	07.94													
	2.5 DI Kasten	51	05.91	06.94													
	2.5 DI Kasten	59	05.91	06.94													
	2.5 DI Kasten	63	10.92	06.94													
	2.5 DI Prits./Fahrg.	51	09.91	08.94													
	2.5 DI Prits./Fahrg.	59	09.91	08.94													
	2.5 TD Bus	63	10.92	07.94													
	2.5 TD Bus	74	09.91	07.94													
	2.5 TD Kasten	74	05.91	06.94													
	2.5 TD Prits./Fahrg.	63	11.92	08.94													
	2.5 TD Prits./Fahrg.	74	09.91	08.94													
2.9 i Bus	107	01.91	08.94														
	2.0 Bus	66	09.91	09.94		13.0460-3959.2	603959		+ 15" Rad ¹⁾	21469 18,0 /WE	BDX						
	2.0 i Bus	72	09.91	07.94								13.0460-0427.2	610427		+ 15" Rad ¹⁾	Belagsatz-Zubehör	BDX
	2.0 i Kasten	72	09.91	06.94													
	2.0 Kasten	66	09.91	06.94													
	2.0 Pritsche/Fahrg.	72	09.91	08.94													
	2.5 DI Bus	51	08.91	07.94													
2.5 DI Bus	51	08.91	07.94														

¹⁾ + 15" wheel / + ruota 15" / + roue 15" / + rueda 15"
²⁾ + 14" wheel / + ruota 14" / + roue 14" / + rueda 14"





FORD TRANSIT (92-94)

	2.5 DI Bus	59		09.91	07.94	13.0460-3959.2	603959	+ 15" Rad ¹⁾	21469 18,0 /WE Belagsatz-Zubehör	BDX BDX
	2.5 DI Kasten	51		05.91	06.94	13.0460-0427.2	610427	+ 15" Rad ¹⁾		
	2.5 DI Kasten	59		05.91	06.94					
	2.5 DI Kasten	63		10.92	06.94					
	2.5 DI Prits./Fahrg.	51		09.91	08.94					
	2.5 DI Prits./Fahrg.	59		09.91	08.94					
	2.5 TD Bus	63		10.92	07.94					
	2.5 TD Bus	74		09.91	07.94					
	2.5 TD Kasten	74		05.91	06.94					
	2.5 TD Prits./Fahrg.	63		11.92	08.94					
	2.5 TD Prits./Fahrg.	74		09.91	08.94					
	2.9 i Bus	107		01.91	08.94					
	2.0 Bus	66		09.91	09.94	24.0124-0131.1	424131	+ 14" Rad ²⁾	254 24,2 22,2 V +B	
	2.0 i Bus	72		09.91	07.94					
	2.0 i Kasten	72		09.91	06.94					
	2.0 Kasten	66		09.91	06.94					
	2.0 Pritsche/Fahrg.	72		09.91	08.94					
	2.5 DI Bus	51		08.91	07.94					
	2.5 DI Bus	59		09.91	07.94					
	2.5 DI Kasten	51		05.91	06.94					
	2.5 DI Kasten	59		05.91	06.94					
	2.5 DI Kasten	63		10.92	06.94					
	2.5 DI Prits./Fahrg.	51		09.91	08.94					
	2.5 DI Prits./Fahrg.	59		09.91	08.94					
2.5 TD Bus	63		10.92	07.94						
2.5 TD Bus	74		09.91	07.94						
2.5 TD Kasten	74		05.91	06.94						
2.5 TD Prits./Fahrg.	63		11.92	08.94						
2.5 TD Prits./Fahrg.	74		09.91	08.94						
2.9 i Bus	107		01.91	08.94						
	2.0 Bus	66		09.91	09.94	24.0124-0132.1	424132	+ 15" Rad ¹⁾	270 24,2 22,2 V +B	
	2.0 i Bus	72		09.91	07.94					
	2.0 i Kasten	72		09.91	06.94					
	2.0 Kasten	66		09.91	06.94					
	2.0 Pritsche/Fahrg.	72		09.91	08.94					
	2.5 DI Bus	51		08.91	07.94					
	2.5 DI Bus	59		09.91	07.94					
	2.5 DI Kasten	51		05.91	06.94					
	2.5 DI Kasten	59		05.91	06.94					
	2.5 DI Kasten	63		10.92	06.94					
	2.5 DI Prits./Fahrg.	51		09.91	08.94					
	2.5 DI Prits./Fahrg.	59		09.91	08.94					
2.5 TD Bus	63		10.92	07.94						
2.5 TD Bus	74		09.91	07.94						
2.5 TD Kasten	74		05.91	06.94						
2.5 TD Prits./Fahrg.	63		11.92	08.94						
2.5 TD Prits./Fahrg.	74		09.91	08.94						
2.9 i Bus	107		01.91	08.94						
	2.0 Bus	66		09.91	09.94	24.5236-0430.3	330587		L=429	
	2.0 i Bus	72		09.91	07.94					
	2.0 i Kasten	72		09.91	06.94					
	2.0 Kasten	66		09.91	06.94					
	2.0 Pritsche/Fahrg.	72		09.91	08.94					
	2.5 DI Bus	51		08.91	07.94					
	2.5 DI Bus	59		09.91	07.94					
	2.5 DI Kasten	51		05.91	06.94					
	2.5 DI Kasten	59		05.91	06.94					
	2.5 DI Kasten	63		10.92	06.94					
	2.5 DI Prits./Fahrg.	51		09.91	08.94					
	2.5 DI Prits./Fahrg.	59		09.91	08.94					
2.5 TD Bus	63		10.92	07.94						
2.5 TD Bus	74		09.91	07.94						
2.5 TD Kasten	74		05.91	06.94						
2.5 TD Prits./Fahrg.	63		11.92	08.94						
2.5 TD Prits./Fahrg.	74		09.91	08.94						
2.9 i Bus	107		01.91	08.94						
	2.0 Bus	66		09.91	09.94	24.5245-0405.3	330686	2	vertikal Bremssystem ³⁾	L=405
	2.0 i Bus	72		09.91	07.94					
	2.0 i Kasten	72		09.91	06.94					
	2.0 Kasten	66		09.91	06.94					
	2.0 Pritsche/Fahrg.	72		09.91	08.94					
	2.5 DI Bus	51		08.91	07.94					
	2.5 DI Bus	59		09.91	07.94					
	2.5 DI Kasten	51		05.91	06.94					
	2.5 DI Kasten	59		05.91	06.94					
	2.5 DI Kasten	63		10.92	06.94					
	2.5 DI Prits./Fahrg.	51		09.91	08.94					
	2.5 DI Prits./Fahrg.	59		09.91	08.94					
2.5 TD Bus	63		10.92	07.94						
2.5 TD Bus	74		09.91	07.94						
2.5 TD Kasten	74		05.91	06.94						
2.5 TD Prits./Fahrg.	63		11.92	08.94						
2.5 TD Prits./Fahrg.	74		09.91	08.94						
2.9 i Bus	107		01.91	08.94						
	2.0 Bus	66		09.91	09.94	24.5245-0398.3	331188	2	diagonal Bremssystem ⁴⁾	L=398
	2.0 i Bus	72		09.91	07.94					
	2.0 i Kasten	72		09.91	06.94					
	2.0 Kasten	66		09.91	06.94					
	2.0 Pritsche/Fahrg.	72		09.91	08.94					
	2.5 DI Bus	51		08.91	07.94					
	2.5 DI Bus	59		09.91	07.94					
	2.5 DI Kasten	51		05.91	06.94					
	2.5 DI Kasten	59		05.91	06.94					
	2.5 DI Kasten	63		10.92	06.94					
	2.5 DI Prits./Fahrg.	51		09.91	08.94					
	2.5 DI Prits./Fahrg.	59		09.91	08.94					
2.5 TD Bus	63		10.92	07.94						
2.5 TD Bus	74		09.91	07.94						
2.5 TD Kasten	74		05.91	06.94						
2.5 TD Prits./Fahrg.	63		11.92	08.94						
2.5 TD Prits./Fahrg.	74		09.91	08.94						
2.9 i Bus	107		01.91	08.94						

¹⁾ + 15" wheel / + ruota 15" / + roue 15" / + rueda 15"

²⁾ + 14" wheel / + ruota 14" / + roue 14" / + rueda 14"

³⁾ vertical brake system / sistema del freno verticale / système de freinage vertical / sistema de freno vertical

















⁴⁾ diagonal brake system / sistema freno diagonalmente / système de freinage en diagonal / sistema de freno en diagonal



FORD TRANSIT (92-94)

	2.0 Bus 66 2.0 i Bus 72 2.0 i Kasten 72 2.0 Kasten 66 2.0 Pritsche./Fahrg. 72 2.9 i Bus 107	kW ... → → ...	09.91 09.94 FT80/100S/100L/115/120 09.91 07.94 FT80/100S/100L/115/120 09.91 06.94 FT80/100S/100L/115/120 09.91 06.94 FT80/100S/100L/115/120 09.91 08.94 FT80/100S/100L/115/120 01.91 08.94 FT80/100S/100L/115/120	24.3222-1124.3 020344			Rz 22,20
	2.5 DI Bus 51 2.5 DI Bus 59 2.5 DI Kasten 51 2.5 DI Kasten 59 2.5 DI Kasten 63 2.5 DI Prits./Fahrg. 51 2.5 DI Prits./Fahrg. 59 2.5 TD Bus 63 2.5 TD Bus 74 2.5 TD Kasten 74 2.5 TD Prits./Fahrg. 63 2.5 TD Prits./Fahrg. 74		08.91 07.94 FT80/100S/100L/115/120 09.91 07.94 FT80/100S/100L/115/120 05.91 06.94 FT80/100S/100L/115/120 05.91 06.94 FT80/100S/100L/115/120 10.92 06.94 FT80/100S/100L/115/120 09.91 08.94 FT80/100S/100L/115/120 09.91 08.94 FT80/100S/100L/115/120 10.92 07.94 FT80/100S/100L/115/120 09.91 07.94 FT80/100S/100L/115/120 05.91 06.94 FT80/100S/100L/115/120 11.92 08.94 FT80/100S/100L/115/120 09.91 08.94 FT80/100S/100L/115/120	24.3220-1121.3 020343		Rz 20,64	
	2.0 Bus 66 2.0 i Bus 72 2.0 i Kasten 72 2.0 Kasten 66 2.0 Pritsche./Fahrg. 72 2.5 DI Bus 51 2.5 DI Bus 59 2.5 DI Kasten 51 2.5 DI Kasten 59 2.5 DI Kasten 63 2.5 DI Prits./Fahrg. 51 2.5 DI Prits./Fahrg. 59 2.5 TD Bus 63 2.5 TD Bus 74 2.5 TD Kasten 74 2.5 TD Prits./Fahrg. 63 2.5 TD Prits./Fahrg. 74 2.9 i Bus 107		09.91 09.94 FT130/150S/150L 09.91 07.94 FT130/150S/150L 09.91 06.94 FT130/150S/150L 09.91 06.94 FT130/150S/150L 09.91 08.94 FT130/150S/150L 08.91 07.94 FT130/150S/150L 09.91 07.94 FT130/150S/150L 05.91 06.94 FT130/150S/150L 05.91 06.94 FT130/150S/150L 10.92 06.94 FT130/150S/150L 09.91 08.94 FT130/150S/150L 09.91 08.94 FT130/150S/150L 10.92 07.94 FT130/150S/150L 09.91 07.94 FT130/150S/150L 05.91 06.94 FT130/150S/150L 11.92 08.94 FT130/150S/150L 09.91 08.94 FT130/150S/150L 01.91 08.94 FT130/150S/150L	24.3220-1121.3 020343			Rz 20,64
	2.0 Bus 66 2.0 i Bus 72 2.0 i Kasten 72 2.0 Kasten 66 2.0 Pritsche./Fahrg. 72 2.5 DI Bus 51 2.5 DI Bus 59 2.5 DI Kasten 51 2.5 DI Kasten 59 2.5 DI Kasten 63 2.5 DI Prits./Fahrg. 51 2.5 DI Prits./Fahrg. 59 2.5 TD Bus 63 2.5 TD Bus 74 2.5 TD Kasten 74 2.5 TD Prits./Fahrg. 63 2.5 TD Prits./Fahrg. 74 2.9 i Bus 107		09.91 09.94 FT190/190A/190EF 09.91 07.94 FT190/190A/190EF 09.91 06.94 FT190/190A/190EF 09.91 06.94 FT190/190A/190EF 09.91 08.94 FT190/190A/190EF 08.91 07.94 FT190/190A/190EF 09.91 07.94 FT190/190A/190EF 05.91 06.94 FT190/190A/190EF 05.91 06.94 FT190/190A/190EF 10.92 06.94 FT190/190A/190EF 09.91 08.94 FT190/190A/190EF 09.91 08.94 FT190/190A/190EF 10.92 07.94 FT190/190A/190EF 09.91 07.94 FT190/190A/190EF 05.91 06.94 FT190/190A/190EF 11.92 08.94 FT190/190A/190EF 09.91 08.94 FT190/190A/190EF 01.91 08.94 FT190/190A/190EF	24.3225-1103.3 020346			Rz 25,40
	2.0 Bus 66 2.0 i Bus 72 2.0 i Kasten 72 2.0 Kasten 66 2.0 Pritsche./Fahrg. 72 2.5 DI Bus 51 2.5 DI Bus 59 2.5 DI Kasten 51 2.5 DI Kasten 59 2.5 DI Kasten 63 2.5 DI Prits./Fahrg. 51 2.5 DI Prits./Fahrg. 59 2.5 TD Bus 63 2.5 TD Bus 74 2.5 TD Kasten 74 2.5 TD Prits./Fahrg. 63 2.5 TD Prits./Fahrg. 74 2.9 i Bus 107		09.91 09.94 FT80/100S/100L/115/120 09.91 07.94 FT80/100S/100L/115/120 09.91 06.94 FT80/100S/100L/115/120 09.91 06.94 FT80/100S/100L/115/120 09.91 08.94 FT80/100S/100L/115/120 08.91 07.94 FT80/100S/100L/115/120 09.91 07.94 FT80/100S/100L/115/120 05.91 06.94 FT80/100S/100L/115/120 05.91 06.94 FT80/100S/100L/115/120 10.92 06.94 FT80/100S/100L/115/120 09.91 08.94 FT80/100S/100L/115/120 09.91 08.94 FT80/100S/100L/115/120 10.92 07.94 FT80/100S/100L/115/120 09.91 07.94 FT80/100S/100L/115/120 05.91 06.94 FT80/100S/100L/115/120 11.92 08.94 FT80/100S/100L/115/120 09.91 08.94 FT80/100S/100L/115/120 01.91 08.94 FT80/100S/100L/115/120	03.0137-0290.2 650290 03.0137-9193.2 669193		+ Einfachbereifung ¹⁾ + Einfachbereifung ¹⁾	254 x 52 Bremsbacken-Zubehör
	2.0 Bus 66 2.0 i Bus 72 2.0 i Kasten 72 2.0 Kasten 66 2.0 Pritsche./Fahrg. 72 2.5 DI Bus 51 2.5 DI Bus 59 2.5 DI Kasten 51 2.5 DI Kasten 59 2.5 DI Kasten 63 2.5 DI Prits./Fahrg. 51 2.5 DI Prits./Fahrg. 59 2.5 TD Bus 63 2.5 TD Bus 74 2.5 TD Kasten 74		09.91 09.94 FT130/150S/150L/190/190A/190EF 09.91 07.94 FT130/150S/150L/190/190A/190EF 09.91 06.94 FT130/150S/150L/190/190A/190EF 09.91 06.94 FT130/150S/150L/190/190A/190EF 09.91 08.94 FT130/150S/150L/190/190A/190EF 08.91 07.94 FT130/150S/150L/190/190A/190EF 09.91 07.94 FT130/150S/150L/190/190A/190EF 05.91 06.94 FT130/150S/150L/190/190A/190EF 05.91 06.94 FT130/150S/150L/190/190A/190EF 10.92 06.94 FT130/150S/150L/190/190A/190EF 09.91 08.94 FT130/150S/150L/190/190A/190EF 09.91 08.94 FT130/150S/150L/190/190A/190EF 10.92 07.94 FT130/150S/150L/190/190A/190EF 09.91 07.94 FT130/150S/150L/190/190A/190EF 05.91 06.94 FT130/150S/150L/190/190A/190EF	03.0137-0291.2 650291 03.0137-9194.2 669194		+ Doppelbereifung ²⁾ + Doppelbereifung ²⁾	280 x 65 Bremsbacken-Zubehör

¹⁾ + single tyre / + ruota singola / + roue simple / + cubierta simple
²⁾ + twin tyres / + ruote gemellate / + roue jumelée / + cubierta doble

        											
FORD TRANSIT (92-94)											
	2.5 TD Prits./Fahrg. 2.5 TD Prits./Fahrg. 2.9 i Bus	63 74 107		11.92 08.94 01.91	08.94 08.94 08.94	FT130/150S/150L/190/190A/190EF FT130/150S/150L/190/190A/190EF FT130/150S/150L/190/190A/190EF	03.0137-0291.2 03.0137-9194.2	650291 669194	+ Doppelbereifung ¹⁾ + Doppelbereifung ¹⁾	280 x 65 Bremsbacken-Zubehör	
	2.0 Bus 2.0 i Bus 2.0 i Kasten 2.0 Kasten 2.0 Pritsche/Fahrg. 2.5 DI Bus 2.5 DI Bus 2.5 DI Kasten 2.5 DI Kasten 2.5 DI Kasten 2.5 DI Prits./Fahrg. 2.5 DI Prits./Fahrg. 2.5 TD Bus 2.5 TD Bus 2.5 TD Kasten 2.5 TD Prits./Fahrg. 2.5 TD Prits./Fahrg. 2.9 i Bus	66 72 72 66 72 51 59 51 59 63 51 59 63 74 74 63 74 107		09.91 09.91 09.91 09.91 09.91 08.91 09.91 05.91 05.91 10.92 09.91 09.91 10.92 09.91 05.91 11.92 09.91 01.91	09.94 07.94 06.94 06.94 08.94 07.94 07.94 06.94 06.94 06.94 08.94 08.94 07.94 07.94 06.94 08.94 08.94 08.94	FT80/100S/100L/115/120 FT80/100S/100L/115/120 FT80/100S/100L/115/120 FT80/100S/100L/115/120 FT80/100S/100L/115/120 FT80/100S/100L/115/120 FT80/100S/100L/115/120 FT80/100S/100L/115/120 FT80/100S/100L/115/120 FT80/100S/100L/115/120 FT80/100S/100L/115/120 FT80/100S/100L/115/120 FT80/100S/100L/115/120 FT80/100S/100L/115/120 FT80/100S/100L/115/120 FT80/100S/100L/115/120 FT80/100S/100L/115/120	24.0225-4004.1	480069	+ Einfachbereifung ²⁾	254/256 x 57,5	
	2.0 Bus 2.0 i Bus 2.0 i Kasten 2.0 Kasten 2.0 Pritsche/Fahrg. 2.5 DI Bus 2.5 DI Bus 2.5 DI Kasten 2.5 DI Kasten 2.5 DI Kasten 2.5 DI Prits./Fahrg. 2.5 DI Prits./Fahrg. 2.5 TD Bus 2.5 TD Bus 2.5 TD Kasten 2.5 TD Prits./Fahrg. 2.5 TD Prits./Fahrg. 2.9 i Bus	66 72 72 66 72 51 59 51 59 63 51 59 63 74 74 63 74 107		09.91 09.91 09.91 09.91 09.91 08.91 09.91 05.91 05.91 10.92 09.91 09.91 10.92 09.91 05.91 11.92 09.91 01.91	09.94 07.94 06.94 06.94 08.94 07.94 07.94 06.94 06.94 06.94 08.94 08.94 07.94 07.94 06.94 08.94 08.94 08.94	FT130/150S/150L/190/190A/190EF FT130/150S/150L/190/190A/190EF FT130/150S/150L/190/190A/190EF FT130/150S/150L/190/190A/190EF FT130/150S/150L/190/190A/190EF FT130/150S/150L/190/190A/190EF FT130/150S/150L/190/190A/190EF FT130/150S/150L/190/190A/190EF FT130/150S/150L/190/190A/190EF FT130/150S/150L/190/190A/190EF FT130/150S/150L/190/190A/190EF FT130/150S/150L/190/190A/190EF FT130/150S/150L/190/190A/190EF FT130/150S/150L/190/190A/190EF FT130/150S/150L/190/190A/190EF FT130/150S/150L/190/190A/190EF FT130/150S/150L/190/190A/190EF	24.0228-0001.1	480068	+ Doppelbereifung ¹⁾	280/282 x 75,5	
	2.0 Bus 2.0 i Bus 2.0 i Kasten 2.0 Kasten 2.0 Pritsche/Fahrg. 2.5 DI Bus 2.5 DI Bus 2.5 DI Kasten 2.5 DI Kasten 2.5 DI Kasten 2.5 DI Prits./Fahrg. 2.5 DI Prits./Fahrg. 2.5 TD Bus 2.5 TD Bus 2.5 TD Kasten 2.5 TD Prits./Fahrg. 2.5 TD Prits./Fahrg. 2.9 i Bus	66 72 72 66 72 51 59 51 59 63 51 59 63 74 74 63 74 107		09.91 09.91 09.91 09.91 09.91 08.91 09.91 05.91 05.91 10.92 09.91 09.91 10.92 09.91 05.91 11.92 09.91 01.91	09.94 07.94 06.94 06.94 08.94 07.94 07.94 06.94 06.94 06.94 08.94 08.94 07.94 07.94 06.94 08.94 08.94 08.94	FT130/150S/150L/190/190A/190EF FT130/150S/150L/190/190A/190EF FT130/150S/150L/190/190A/190EF FT130/150S/150L/190/190A/190EF FT130/150S/150L/190/190A/190EF FT130/150S/150L/190/190A/190EF FT130/150S/150L/190/190A/190EF FT130/150S/150L/190/190A/190EF FT130/150S/150L/190/190A/190EF FT130/150S/150L/190/190A/190EF FT130/150S/150L/190/190A/190EF FT130/150S/150L/190/190A/190EF FT130/150S/150L/190/190A/190EF FT130/150S/150L/190/190A/190EF FT130/150S/150L/190/190A/190EF FT130/150S/150L/190/190A/190EF FT130/150S/150L/190/190A/190EF	24.3727-0636.2 24.3727-0637.2	580636 580637	1  + Einfachbereifung ²⁾ 1  + Doppelbereifung ¹⁾	L=2823 L=2730	
	2.0 Bus 2.0 i Bus 2.0 i Kasten 2.0 Kasten 2.0 Pritsche/Fahrg. 2.5 DI Bus 2.5 DI Bus 2.5 DI Kasten 2.5 DI Kasten 2.5 DI Kasten 2.5 DI Prits./Fahrg. 2.5 DI Prits./Fahrg. 2.5 TD Bus 2.5 TD Bus 2.5 TD Kasten 2.5 TD Prits./Fahrg. 2.5 TD Prits./Fahrg. 2.9 i Bus	66 72 72 66 72 51 59 51 59 63 51 59 63 74 74 63 74 107		09.91 09.91 09.91 09.91 09.91 08.91 09.91 05.91 05.91 10.92 09.91 09.91 10.92 09.91 05.91 11.92 09.91 01.91	09.94 07.94 06.94 06.94 08.94 07.94 07.94 06.94 06.94 06.94 08.94 08.94 07.94 07.94 06.94 08.94 08.94 08.94	FT130/150S/150L/190/190A/190EF FT130/150S/150L/190/190A/190EF FT130/150S/150L/190/190A/190EF FT130/150S/150L/190/190A/190EF FT130/150S/150L/190/190A/190EF FT130/150S/150L/190/190A/190EF FT130/150S/150L/190/190A/190EF FT130/150S/150L/190/190A/190EF FT130/150S/150L/190/190A/190EF FT130/150S/150L/190/190A/190EF FT130/150S/150L/190/190A/190EF FT130/150S/150L/190/190A/190EF FT130/150S/150L/190/190A/190EF FT130/150S/150L/190/190A/190EF FT130/150S/150L/190/190A/190EF FT130/150S/150L/190/190A/190EF FT130/150S/150L/190/190A/190EF	24.3728-0627.2	590627		L=1376	
HANOMAG A-L 28											
	A-L 28			01.58	12.69	+ 1,5/ 2,5 t	03.3131-0102.3 24.3526-0110.3	010296 340018	1	Hz 31,75 Bremslichtschalter	ATE
	A-L 28			01.58	12.69	+ 1,5/ 2,5 t	83.6103-0620.3	330234		L=620	

¹⁾ + twin tyres / + ruote gemellate / + roue jumelée / + cubierta doble
²⁾ + single tyre / + ruota singola / + roue simple / + cubierta simple

HANOMAG F 20 - F 86											
	F 20		01.67	12.71	+ 2-Kreis-Bremse ¹⁾	03.2122-0704.3	010134	2		THz 22,20	ATE
	F 20		01.72	08.74		03.3526-2002.3	340010	1	+ 1-Kreis-Bremse ²⁾	Bremslichtschalter	
	F 25/30/35		01.67	12.71	- Bremsgerät ³⁾	24.3526-0810.3	340037	1		Bremslichtschalter	
	F 25/30/35		01.67	12.71	+ Bremsgerät ⁴⁾	03.3122-0101.3	010277	1		HZ 22,20	ATE
	F 25/30/35		01.72	12.72	- Bremsgerät ³⁾	24.3526-0110.3	340018	1		Bremslichtschalter	
	F 25/30/35		01.72	08.74	+ Bremsgerät/ -	24.3526-0810.3	340037	2		THz 23,81	ATE
	F 25/30/35		01.72	08.74	+ / + Bremsgerät ⁶⁾	03.2123-3302.3	010180	2		Bremslichtschalter	
	F 35 3-Achser		01.72	08.74	+ Bremsgerät ⁴⁾	24.3526-0810.3	340037	2		THz 23,81	ATE
	F 35 Zugkopf		01.72	08.74	+ Bremsgerät ⁴⁾	03.3122-0101.3	010277	1		Bremslichtschalter	
	F 45/46		01.68	12.74		24.3526-0110.3	340018	1		Bremslichtschalter	
	F 45/46 Hydrair		01.68	12.74	+ Radstand 3050mm ⁷⁾	03.0370-1828.2	051828	1	+ Hz 28,57 ⁸⁾	HZ Reparatursatz	
	F 55		01.67	12.74		24.3526-0110.3	340018	1		Bremslichtschalter	
	F 65/66		01.67	12.74		03.0370-1828.2	051828	1		HZ Reparatursatz	
	F 75/76		01.67	12.74		24.3526-0110.3	340018	1		Bremslichtschalter	
	F 85		01.67	12.74							
	F 86		01.69	12.74							
	F 20		01.67	12.71	+ Bremsgerät ⁴⁾	83.6103-0200.3	330219			L=200	
	F 25/30/35		01.67	12.71	+ Bremsgerät ⁴⁾						
	F 45/46		01.68	12.74		83.6123-0471.3	330263			L=470	
	F 55/65/66		01.67	12.74							
	F 75/76		01.67	12.74							
	F 85		01.67	12.74							
	F 86		01.69	12.74							
	F 20 L/DL		01.73	08.74		24.3222-1733.3	020538			Rz 22,20	
	F 25 L/DL		01.73	08.74							
	F 35 L/DL		01.73	08.74							
	F 20		01.67	12.71	- Bremsgerät ³⁾	83.6203-0200.3	330298			L=200	
	F 25/30/35		01.67	12.71	- Bremsgerät ³⁾						
	F 20		01.67	12.71	+ Bremsgerät ⁴⁾	83.6203-0200.3	330298			L=200	
	F 25/30/35		01.67	08.74	+ Bremsgerät ⁴⁾						
	F 35 3-Achser		01.72	08.74							
	F 20		01.72	08.74	+	03.3222-4401.3	020076			Rz 22,20	
	F 25	6400229		08.74		03.3222-4401.3	020076			Rz 22,20	
	F 30	6600417		08.74							
	F 35	6800096		08.74							
	F 20 L/DL		01.73	08.74		03.3222-4401.3	020076			Rz 22,20	
	F 25 L/DL		01.73	08.74							
	F 35 L/DL		01.73	08.74							
	F 20/25/30/35		01.73	08.74		03.6521-0012.3	320094			BRL 2/1 (3)	ATE
	F 20/25/30/35		01.67	12.72		03.0450-2509.2	082509			Nz Reparatursatz	
	F 35 Zugkopf		01.72	12.72							
	F 20/25/30/35		01.73	08.74		03.2525-2602.3	040029			Nz 25,40	
	F 35 Zugkopf		01.73	08.74		03.0450-2510.2	082510			Nz Reparatursatz	
HANOMAG GARANT											
	Garant/S		01.59	12.67		83.6123-0471.3	330263			L=470	
HANOMAG KURIER											
	Kurier		01.58	12.67		83.6123-0471.3	330263			L=470	
	Kurier		01.58	12.67	- Kastenwagen ⁹⁾	83.6103-0470.3	330229			L=470	
	Kurier Kastenw.		01.61	12.67		83.6103-0470.3	330229			L=470	
						83.6203-0200.3	330298			L=200	
HANOMAG MARKANT / ATHLET											
	Markant		01.60	12.67		83.6123-0471.3	330263			L=470	
HANOMAG MATADOR											
	1.6		01.66	12.68	+ 1,0/ 1,3/ 1,75 t	24.3526-0810.3	340037	1		Bremslichtschalter	
	E		01.66	12.68	+ 1,5 t						
	1.5		01.55	12.62	+ 1,3/ 1,5 t	83.6103-0350.3	330225			L=350	
	1.5		01.55	12.62	+ 1,3/ 1,5 t	83.6103-0200.3	330219			L=200	
	1.6		01.63	12.68	+ 1,0 t	83.6203-0200.3	330298			L=200	
	1.6		01.64	12.68	+ 1,3 t						
	1.6		01.64	12.65	+ 1,6 t						
	1.6		01.66	12.68	+ 1,75 t						
	E		01.66	12.68	+ 1,5 t						

¹⁾ + two circuit brake / + impianto frenante doppio circuito / + frein à deux circuits / + freno de 2 circuitos

²⁾ + single circuit brake / + impianto freni circuito singolo / + frein à 1 circuit / + freno de 1 circuito

³⁾ - booster unit / - servofreno / - servo-frein / - servofreno

⁴⁾ + booster unit / + servofreno / + servo-frein / + servofreno

























⁵⁾ + booster unit/ - / + servofreno/ - / + servo-frein/ - / + servofreno/ -

⁶⁾ + / + booster unit / + / + servofreno / + / + servo-frein / + / + servofreno

































⁷⁾ + wheel base 3050 mm / + passo 3050 mm / + empattement 3050 mm / + distancia entre ejes 3050 mm

⁸⁾ + MC 28,57 / + PF 28,57 / + MC 28,57 / + CM 28,57

⁹⁾ - Van / - furgone / - fourgonnette / - furgón





































								
HANOMAG MATADOR								
	1.6		01.63	12.63	+ 1,3/ 1,6 t	03.3222-4401.3	020076	Rz 22,20
HENSCHEL F111 - F 261								
	F 130/A F 131/S		01.71 01.69	12.74 12.74		03.3508-0401.3	310014	Behälter
	F 130 F 131/S F 150/A		01.71 01.69 01.67	12.74 12.74 06.71	- F 130 A	83.6103-0600.3	330233	L=600
HENSCHEL HS 3 - HS 160								
	HS 120 T HS 90 HS 95/R		01.57 01.57 01.60	12.62 12.62 12.61		03.2419-1451.3	030012	Gz 19,05
	HS 14/15/16/18/19 HS 22 HS 3-125 T/TS HS 3-14		06.62 06.62 01.62 01.63	05.65 05.65 12.64 12.65		03.2522-2612.3	040012	Nz 22,20
	HS 120 T HS 14 HS 15 HS 16 HS 160-USL HS 18/19/20 HS 3-125 T/TS HS 3-14 HS 90 HS 95/R		01.57 01.60 06.62 01.60 01.62 06.62 01.62 01.63 01.57 01.60	12.62 03.64 03.64 03.64 12.64 03.64 12.64 12.65 12.62 12.61		83.6103-0320.3	330224	L=320
HONDA ACCORD (81-85)								
	1.6 (AC) 1.8 (AD)		09.83 09.83	08.85 08.85		13.0460-5936.2 13.0460-0439.2	605936 610439	21012 15,0 Belagsatz-Zubehör AKE AKE
	1.6 (AC) 1.8 (AD)		09.83 09.83	08.85 08.85		24.0119-0104.1	419104	242 19,0 17,0 V
HONDA ACCORD (85-89)								
	1.6 (CA4) 2.0 i (CA5) 2.0 i Aero Deck (CA5)		09.85 09.85 09.85	12.89 08.87 08.87		13.0460-5918.2	605918	20099 15,0 +/WK AKE
	1.6 (CA4) 2.0 i (CA5) 2.0 i Aero Deck (CA5)		09.85 09.85 09.85	12.89 08.87 08.87		24.0119-0104.1	419104	242 19,0 17,0 V
	2.0 i (CA5) 2.0 i 16V (CA5) 2.0 i Aero Deck (CA5)		09.87 12.86 09.87	12.89 12.89 12.89		24.0121-0102.1	421102	262 21,0 19,0 V
	2.0 i (CA5) 2.0 i 16V (CA5) 2.0 i Aero Deck (CA5)		09.85 12.86 09.85	12.89 12.89 12.89		24.0101-3004.2	260042	Bremssattel-Zubehör TRW
	2.0 i (CA5) 2.0 i 16V (CA5) 2.0 i Aero Deck (CA5)		09.85 12.86 09.85	12.89 12.89 12.89		13.0460-5998.2 13.0460-0430.2	605998 610430	21312 12,8 +/WK Belagsatz-Zubehör AKE AKE
	2.0 i (CA5) 2.0 i 16V (CA5) 2.0 i Aero Deck (CA5)		09.85 12.86 09.85	12.89 12.89 12.89		24.0110-0212.1	410212	239 10,0 8,0 +S +B
	1.6 (CA4) 2.0 i (CA5) 2.0 i Aero Deck (CA5)		09.85 09.85 09.85	12.89 12.89 12.89	- ABS	03.0137-0294.2 03.0137-9097.2	650294 669097	200 x 36 Bremsbacken-Zubehör
HONDA ACCORD (90-93)								
	2.0 i 16V (CB3) 2.0 i 16V Coupe (CC1)		01.90 01.92	12.93 12.93		13.0460-5818.2	605818	21497 18,0 +/WK AKE
	2.0 i Aero Deck (CC9) 2.2 i Aero Deck (CB8)		01.93 01.91	12.93 12.93		13.0460-5982.2 13.0460-0075.2	605982 610075	21651 17,5 +/WK Belagsatz-Zubehör
	2.0 i 16V (CB3) 2.0 i 16V Coupe (CC1)		01.90 01.92	12.93 + 14" Rad 1) 12.93 + 14" Rad 1)		24.0123-0103.1	423103	260 23,0 21,0 V
	2.0 i Aero Deck (CC9) 2.2 i Aero Deck (CB8)		01.93 01.91	12.93 12.93		24.0125-0130.1	425130	282 25,0 23,0 V
	2.0 i 16V (CB3) 2.0 i 16V Coupe (CC1) 2.0 i Aero Deck (CC9) 2.2 i 16V (CB7) 2.2 i Aero Deck (CB8)		01.90 01.92 01.93 01.90 01.91	12.93 + ABS 12.93 12.93 12.93 12.93		13.0460-5929.2 13.0460-0287.2	605929 610287	21719 15,0 +/WK Belagsatz-Zubehör AKE
	2.0 i 16V (CB3) 2.0 i 16V Coupe (CC1) 2.0 i Aero Deck (CC9) 2.2 i 16V (CB7) 2.2 i Aero Deck (CB8)		01.90 01.92 01.93 01.90 01.91	12.93 + ABS 12.93 12.93 12.93 12.93		24.0110-0233.1	410233	260 10,0 8,0 +S +B
	2.2 i 16V 4WD (CB7)		01.90	12.93		24.0110-0267.1	410267	260 10,0 8,0

1) + 14" wheel / + ruota 14" / + roue 14" / + rueda 14"































								
HONDA ACCORD (90-93)								
	2.0 i 16V (CB3)		01.90	12.93	- ABS	24.3219-1723.3 24.3219-1724.3	020427 020428	Rz 19,05 Rz 19,05
	2.0 i 16V (CB3)		01.90	12.93	- ABS	03.0137-0287.2 03.0137-9190.2	650287 669190	220 x 36 Bremsbacken-Zubehör
	2.0 i 16V (CB3)		01.90	12.93	- ABS	24.0222-0001.1	480123	220/221 x 44,5
HONDA ACURA INTEGRA (84-90)								
	1.5 1.6		05.86 05.86	05.90 + Europa ¹⁾ 05.90 + Europa ¹⁾		13.0460-5918.2	605918	20099 15,0 +WK AKE
	1.6		02.84	04.86 + (USA) / + Europa ²⁾		24.0117-0101.1	417101	231 17,0 15,0 V AKE
	1.5 1.6		05.86 05.86	05.90 + (USA) / + Europa ²⁾ 05.90 + (USA) / + Europa ²⁾		24.0119-0106.1	419106	242 19,0 17,0 V
	1.5 1.6		05.86 05.86	05.90 + Europa ¹⁾ 05.90 + Europa ¹⁾		03.0137-9097.2	669097	Bremsbacken-Zubehör
HONDA BALLADE (GB) (86-91)								
	1.5 (HJ)		02.86	08.91		24.0117-0101.1	417101	231 17,0 15,0 V AKE
	1.5 (HJ)		02.86	08.91		03.0137-0179.2 03.0137-9096.2	650179 669096	180 x 31 Bremsbacken-Zubehör
HONDA CONCERTO (90-95)								
	1.4 (HW) 1.5 i (HW) 1.6 i 16V (HW) 1.6 i 16V (HW)	66 66 82 90	08.89 01.90 01.90 01.90	01.95 01.95 01.95 01.95		24.3541-1813.5 24.3541-1814.5	240381 240382	D=54, - Halter D=54, - Halter TRW TRW
	1.4 (HW) 1.5 i (HW) 1.6 i 16V (HW) 1.6 i 16V (HW)	66 66 82 90	08.89 01.90 01.90 01.90	01.95 01.95 01.95 01.95		13.0460-5920.2 13.0460-0308.2 13.0460-2803.2 13.0460-0142.2	605920 610308 602803 610142	21322 15,0 +WK Belagsatz-Zubehör AKE 21515 17,5 +WK/S Belagsatz-Zubehör TRW
	1.4 (HW) 1.5 i (HW) 1.6 i 16V (HW) 1.6 i 16V (HW)	66 66 82 90	08.89 01.90 01.90 01.90	01.95 01.95 01.95 01.95		24.0121-0107.1	421107	262 21,0 19,0 V +B
	1.6 i 16V (HW) 1.6 i 16V (HW)	82 90	01.90 01.90	01.95 01.95		24.3304-1701.5 24.3304-1702.5 24.0101-3004.2	240113 240114 260042	D=30, - Halter D=30, - Halter Bremsattel-Zubehör TRW TRW TRW
	1.6 i 16V (HW) 1.6 i 16V (HW)	82 90	01.90 01.90	01.95 01.95		13.0460-5998.2 13.0460-0430.2	605998 610430	21312 12,8 +WK Belagsatz-Zubehör AKE AKE
	1.6 i 16V (HW) 1.6 i 16V (HW)	82 90	01.90 01.90	01.95 01.95		24.0110-0212.1	410212	239 10,0 8,0 +S +B
	1.4 (HW) 1.5 i (HW)	66 66	08.89 01.90	01.95 01.95		03.0137-0339.2 03.0137-9221.2	650339 669221	203 x 38 Bremsbacken-Zubehör
	1.4 (HW) 1.5 i (HW)	66 66	08.89 01.90	01.95 01.95		24.0220-3016.1	480107	203/204 x 45,5
	1.4 (HW) 1.5 i (HW)	66 66	08.89 01.90	01.95 01.95		03.0420-3719.3	683719	19,05/203x38 Kit TRW
HONDA CIVIC (79-83)								
	1.3 (SL) 1.3 (SL) 1.3 (SS)	33 44 44	09.79 09.79 09.79	08.83 08.83 08.83		13.0460-5916.2	605916	20731 15,3 AKE
	1.3 (SL) 1.3 (SL) 1.3 (SS) 1.3 S (SL)	33 44 44 52	01.82 01.82 01.82 01.82	08.83 08.83 08.83 08.83		24.3219-1121.3 24.3219-1122.3	020363 020364	Rz 19,05 Rz 19,05
HONDA CIVIC (83-87)								
	1.2 (AL) 1.3 (AG) 1.5 (AH) 1.5 GTI (AH) 1.5 i (AH)	63 66 74	09.83 09.83 09.83 01.85	08.87 08.87 08.87 08.87		24.0112-0102.1	412102	231 12,0 10,0
	1.2 (AL) 1.3 (AG) 1.5 (AH) 1.5 GTI (AH) 1.5 i (AH)	63 66 74	09.83 09.83 09.83 01.85	08.87 08.87 08.87 08.87		24.0117-0101.1	417101	231 17,0 15,0 V AKE
	1.2 (AL) 1.3 (AG) 1.5 (AH) 1.5 GTI (AH) 1.5 i (AH)	63 66 74	09.83 09.83 09.83 01.85	08.87 08.87 08.87 08.87		24.3219-1121.3 24.3219-1122.3	020363 020364	Rz 19,05 Rz 19,05

































¹⁾ + Europa / + Europa / + Europa / + Europa































²⁾ + (USA) / + Europa / + (USA) / + Europa / + (USA) / + Europa / + (USA) / + Europa

								
HONDA CIVIC (83-87)								
	1.2 (AL) 1.3 (AG) 1.5 (AH) 1.5 GTI (AH) 1.5 i (AH)	63 66 74	09.83 09.83 09.83 09.83 01.85	08.87 08.87 08.87 08.87 08.87	03.0137-0179.2 03.0137-9096.2	650179 669096		180 x 31 Bremsbacken-Zubehör
	1.2 (AL) 1.3 (AG) 1.5 (AH) 1.5 GTI (AH) 1.5 i (AH)	63 66 74	09.83 09.83 09.83 09.83 01.85	08.87 08.87 08.87 08.87 08.87	24.0218-0018.1	480063		180/181 x 38
HONDA CIVIC (3-tuerig) (87-91)								
	1.3 (EC8) 1.4 (EC9) 1.5 i 16V (ED6) 1.6 i 16V (ED7)		09.87 09.87 09.89 09.87	08.91 12.89 08.91 08.91	13.0460-5919.2	605919		20959 15,0 +WK AKE
	1.3 (EC8) 1.4 (EC9) 1.5 i 16V (ED6) 1.6 i 16V (ED7) 1.6 i 16V VTEC (EE9)		09.87 09.87 09.89 09.87 06.90	08.91 12.89 08.91 08.91 08.91	24.0112-0102.1 24.0117-0101.1 24.0119-0106.1 24.0121-0105.1	412102 417101 419106 421105		231 12,0 10,0 231 17,0 15,0 V AKE 242 19,0 17,0 V 262 21,0 19,0 V +S +B
	1.6 i 16V (ED7) 1.6 i 16V VTEC (EE9)		09.87 06.90	08.91 08.91	24.0101-3004.2	260042		Bremssattel-Zubehör TRW
	1.6 i 16V (ED7) 1.6 i 16V VTEC (EE9)		09.87 06.90	08.91 08.91	13.0460-5998.2 13.0460-0430.2	605998 610430		21312 12,8 +WK AKE Belagsatz-Zubehör AKE
	1.6 i 16V (ED7) 1.6 i 16V VTEC (EE9)		09.87 06.90	08.91 08.91	24.0110-0212.1	410212		239 10,0 8,0 +S +B
	1.3 (EC8) 1.4 (EC9) 1.5 i 16V (ED6)		09.87 09.87 09.89	12.89 12.89 08.91	24.3219-1121.3 24.3219-1122.3	020363 020364	 	Rz 19,05 Rz 19,05
	1.3 (EC8) 1.4 (EC9) 1.5 i 16V (ED6)		01.90 01.90 09.87	08.91 08.91 08.91	24.3219-1723.3 24.3219-1724.3	020427 020428	 	Rz 19,05 Rz 19,05
	1.3 (EC8) 1.4 (EC9) 1.5 i 16V (ED6)		09.87 09.87 09.89	08.91 12.89 08.91	03.0137-0179.2 03.0137-9096.2	650179 669096		180 x 31 Bremsbacken-Zubehör
	1.3 (EC8) 1.4 (EC9) 1.5 i 16V (ED6)		09.87 09.87 09.89	08.91 12.89 08.91	24.0218-0018.1	480063		180/181 x 38
HONDA CIVIC (4-tuerig) (87-91)								
	1.4 (ED2) 1.5 i 16V (ED3) 1.6 i 16V (ED4) 1.6 i 16V 4x4 (ED4)		09.87 09.89 09.87 09.87	12.89 08.91 08.91 08.91	13.0460-5919.2	605919		20959 15,0 +WK AKE
	1.4 (ED2) 1.5 i 16V (ED3) 1.6 i 16V (ED4) 1.6 i 16V 4x4 (ED4)		09.87 09.89 09.87 09.87	12.89 08.91 08.91 08.91	24.0117-0101.1 24.0119-0106.1	417101 419106		231 17,0 15,0 V AKE 242 19,0 17,0 V
	1.6 i 16V (ED4) 1.6 i 16V 4x4 (ED4)		09.87 09.87	08.91 08.91	24.0101-3004.2	260042		Bremssattel-Zubehör TRW
	1.6 i 16V (ED4) 1.6 i 16V 4x4 (ED4)		09.87 09.87	08.91 08.91	13.0460-5998.2 13.0460-0430.2	605998 610430		21312 12,8 +WK AKE Belagsatz-Zubehör AKE
	1.6 i 16V (ED4) 1.6 i 16V 4x4 (ED4)		09.87 09.87	08.91 08.91	24.0110-0212.1	410212		239 10,0 8,0 +S +B
	1.4 (ED2) 1.5 i 16V (ED3)		09.87 09.89	12.89 08.91	24.3219-1121.3 24.3219-1122.3	020363 020364	 	Rz 19,05 Rz 19,05
	1.4 (ED2) 1.5 i 16V (ED3)		09.87 09.89	12.89 08.91	03.0137-0179.2 03.0137-9096.2	650179 669096		180 x 31 Bremsbacken-Zubehör
	1.4 (ED2) 1.5 i 16V (ED3)		09.87 09.89	12.89 08.91	24.0218-0018.1	480063		180/181 x 38
HONDA CIVIC (3-tuerig) (91-95)								
	1.3 16V (EG3) 1.3 16V (EG3) 1.5 16V (EG4) 1.6 16V VTEC (EG5) 1.6 16V VTEC (EG5) 1.6 16V VTEC (EG6)	92 92 118	09.91 09.91 09.91 09.91 09.91 09.91	10.95 10.95 10.95 - ABS + ABS 10.95	13.0460-5919.2	605919		20959 15,0 +WK AKE
	1.3 16V (EG3) 1.3 16V (EG3) 1.5 16V (EG4) 1.6 16V VTEC (EG5)	92	09.91 09.91 09.91 09.91	10.95 10.95 10.95 - ABS	13.0460-5943.2 13.0460-5820.2	605943 605820		21697 15,0 +WK SUM 21694 16,3 +WK SUM
	1.3 16V (EG3) 1.3 16V (EG3) 1.5 16V (EG4) 1.6 16V VTEC (EG5)	92	09.91 09.91 09.91 09.91	10.95 10.95 10.95 - ABS	24.0117-0101.1 24.0121-0104.1	417101 421104		231 17,0 15,0 V AKE 240 21,0 19,0 V +S +B SUM



								
HONDA CIVIC (3-tuerig) (91-95)								
	1.6 16V VTEC (EG5) 1.6 16V VTEC (EG6)	92 118		09.91 09.91	10.95 + ABS 10.95	24.0121-0105.1 421105		262 21,0 19,0 V +S +B
	1.6 16V VTEC (EG5) 1.6 16V VTEC (EG6)	92 118		09.91 09.91	10.95 10.95	13.0460-5998.2 605998 13.0460-0430.2 610430		21312 12,8 +/WK AKE Belagsatz-Zubehör AKE
	1.6 16V VTEC (EG5) 1.6 16V VTEC (EG6)	92 118		09.91 09.91	10.95 10.95	24.0109-0111.1 409111		239 9,0 8,0 +S +B
	1.3 16V (EG3) 1.5 16V (EG4)			09.91 09.91	10.95 10.95	24.3219-1723.3 020427 24.3219-1724.3 020428	<input type="checkbox"/> <input type="checkbox"/>	Rz 19,05 Rz 19,05
	1.3 16V (EG3) 1.5 16V (EG4)			09.91 09.91	10.95 10.95	03.0137-0284.2 650284 03.0137-9096.2 669096		180 x 31 Bremsbacken-Zubehör
	1.3 16V (EG3) 1.5 16V (EG4)			09.91 09.91	10.95 10.95	24.0218-0018.1 480063		180/181 x 38
HONDA CIVIC (4-tuerig) (91-95)								
	1.5 16V (EG8) 1.6 16V VTEC (EH9)	92		09.91 09.91	10.95 10.95 - ABS	13.0460-5943.2 605943		21697 15,0 +/WK SUM
	1.6 16V 4WD VTEC(EH1) 1.6 16V VTEC (EG9) 1.6 16V VTEC (EH9)	92 118 92		09.91 09.91 09.91	10.95 10.95 10.95 + ABS	13.0460-5820.2 605820		21694 16,3 +/WK SUM
	1.5 16V (EG8) 1.6 16V VTEC (EH9)	92		09.91 09.91	10.95 10.95 - ABS	24.0121-0104.1 421104		240 21,0 19,0 V +S +B SUM
	1.6 16V 4WD VTEC(EH1) 1.6 16V VTEC (EG9) 1.6 16V VTEC (EH9)	92 118 92		09.91 09.91 09.91	10.95 10.95 10.95 + ABS	24.0121-0105.1 421105		262 21,0 19,0 V +S +B
	1.6 16V VTEC (EG9) 1.6 16V VTEC (EH9)	118 92		09.91 09.91	10.95 10.95	13.0460-5998.2 605998 13.0460-0430.2 610430		21312 12,8 +/WK AKE Belagsatz-Zubehör AKE
	1.6 16V VTEC (EG9) 1.6 16V VTEC (EH9)	118 92		09.91 09.91	10.95 10.95	24.0109-0111.1 409111		239 9,0 8,0 +S +B
	1.5 16V (EG8) 1.6 16V 4WD VTEC(EH1)	92		09.91 09.91	10.95 10.95	24.3219-1723.3 020427 24.3219-1724.3 020428	<input type="checkbox"/> <input type="checkbox"/>	Rz 19,05 Rz 19,05
	1.5 16V (EG8) 1.6 16V 4WD VTEC(EH1)	92		09.91 09.91	10.95 10.95	03.0137-0294.2 650294 03.0137-9097.2 669097		200 x 36 Bremsbacken-Zubehör
HONDA CIVIC (5-tuerig) (94-96)								
	1.4 i (MA8) 1.5 VTEC E (MA9) 1.6 i (MB1) 1.6 VTEC (MB1)			09.94 09.94 09.94 09.94	12.96 12.96 12.96 12.96	24.3541-1813.5 240381 24.3541-1814.5 240382	<input type="checkbox"/> <input type="checkbox"/>	D=54, - Halter TRW D=54, - Halter TRW
	1.4 i (MA8) 1.5 VTEC E (MA9) 1.6 i (MB1) 1.6 VTEC (MB1)			09.94 09.94 09.94 09.94	12.96 12.96 12.96 12.96	13.0460-5920.2 605920 13.0460-0308.2 610308 13.0460-2803.2 602803 13.0460-0142.2 610142		21322 15,0 +/WK AKE Belagsatz-Zubehör AKE 21515 17,5 +/WK/S TRW Belagsatz-Zubehör
	1.4 i (MA8) 1.5 VTEC E (MA9) 1.6 i (MB1) 1.6 VTEC (MB1)			09.94 09.94 09.94 09.94	12.96 12.96 12.96 12.96	24.0121-0105.1 421105		262 21,0 19,0 V +S +B
	1.4 i (MA8) 1.5 VTEC E (MA9) 1.6 i (MB1) 1.6 VTEC (MB1)			09.94 09.94 09.94 09.94	12.96 + ABS 12.96 + ABS 12.96 12.96	24.3304-1701.5 240113 24.3304-1702.5 240114 24.0101-3004.2 260042	<input type="checkbox"/> <input type="checkbox"/>	D=30, - Halter TRW D=30, - Halter TRW Bremsattel-Zubehör TRW
	1.4 i (MA8) 1.5 VTEC E (MA9) 1.6 i (MB1) 1.6 VTEC (MB1)			09.94 09.94 09.94 09.94	12.96 + ABS 12.96 + ABS 12.96 12.96	13.0460-5998.2 605998 13.0460-0430.2 610430		21312 12,8 +/WK AKE Belagsatz-Zubehör AKE
	1.4 i (MA8) 1.5 VTEC E (MA9) 1.6 i (MB1) 1.6 VTEC (MB1)			09.94 09.94 09.94 09.94	12.96 + ABS 12.96 + ABS 12.96 12.96	24.0110-0212.1 410212		239 10,0 8,0 +S +B
	1.4 i (MA8) 1.5 VTEC E (MA9)			01.96 01.96	12.96 - ABS 12.96 - ABS	24.3219-1743.3 020485		Rz 19,05
	1.4 i (MA8) 1.5 VTEC E (MA9)			09.94 09.94	12.95 - ABS 12.95 - ABS	03.0137-0339.2 650339 03.0137-9221.2 669221		203 x 38 Bremsbacken-Zubehör
	1.4 i (MA8) 1.5 VTEC E (MA9)			01.96 01.96	12.96 - ABS 12.96 - ABS	03.0137-0339.2 650339		203 x 38
	1.4 i (MA8) 1.5 VTEC E (MA9)			09.94 09.94	12.96 - ABS 12.96 - ABS	24.0220-3016.1 480107		203/204 x 45,5
	1.4 i (MA8) 1.5 VTEC E (MA9)			09.94 09.94	12.95 - ABS 12.95 - ABS	03.0420-3719.3 683719		19,05/203x38 Kit TRW
	1.4 i (MA8) 1.5 VTEC E (MA9)			01.96 01.96	12.96 - ABS 12.96 - ABS	03.0420-4519.3 684519		19,05/203x38 Kit





















									
HONDA CIVIC COUPE (94-95)									
	1.6 i (EJ6)	77		01.94	12.95	- ABS	24.2120-1751.3	010909	ThZ 20,64
	1.5 i (EJ2)	74		01.94	12.95		13.0460-5943.2	605943	21697 15,0 +/WK SUM
	1.6 i (EJ6)	77		01.94	12.95		13.0460-0073.2	610073	Belagsatz-Zubehör
	1.6 VTEC (EJ1)	92		01.94	12.95		13.0460-5820.2	605820	21694 16,3 +/WK SUM
							13.0460-0073.2	610073	Belagsatz-Zubehör
	1.5 i (EJ2)	74		01.94	12.95		24.0121-0104.1	421104	240 21,0 19,0 V +S +B SUM
	1.6 i (EJ6)	77		01.94	12.95				
	1.6 VTEC (EJ1)	92		01.94	12.95		24.0121-0105.1	421105	262 21,0 19,0 V +S +B
	1.5 i (EJ2)	74		01.94	12.95		24.3219-1723.3	020427	Rz 19,05
	1.6 i (EJ6)	77		01.94	12.95		24.3219-1724.3	020428	Rz 19,05
	1.6 VTEC (EJ1)	92		01.94	12.95				
	1.5 i (EJ2)	74		01.94	12.95		03.0137-0294.2	650294	200 x 36
	1.6 i (EJ6)	77		01.94	12.95		03.0137-9097.2	669097	Bremsbacken-Zubehör
	1.6 VTEC (EJ1)	92		01.94	12.95				
HONDA CIVIC SHUTTLE (83-87)									
	1.5 (AN)			09.83	08.87	- CH	13.0460-5919.2	605919	20959 15,0 +/WK AKE
	1.5 (AN)			09.83	08.87	- CH	24.0112-0102.1	412102	231 12,0 10,0
	1.5 (AN)			09.83	08.87	+ CH	24.0117-0101.1	417101	231 17,0 15,0 V AKE
	1.5 4WD (AR)			01.85	08.87				
	1.5 (AN)			09.83	08.87		24.3219-1121.3	020363	Rz 19,05
	1.5 4WD (AR)			01.85	08.87		24.3219-1122.3	020364	Rz 19,05
	1.5 (AN)			09.83	08.87		03.0137-9097.2	669097	Bremsbacken-Zubehör
	1.5 4WD (AR)			01.85	08.87				
HONDA CIVIC SHUTTLE (87-91)									
	1.4 (EE1)			09.87	12.89		13.0460-5920.2	605920	21322 15,0 +/WK AKE
	1.6 i 16V 4WD (EE4)			09.87	08.91		13.0460-0308.2	610308	Belagsatz-Zubehör AKE
	1.4 (EE1)			09.87	12.89		24.0119-0106.1	419106	242 19,0 17,0 V
	1.5 16V (EE2)			09.87	12.89				
	1.6 i 16V 4WD (EE4)			09.87	08.91				
	1.4 (EE1)			09.87	12.89		03.0137-9097.2	669097	Bremsbacken-Zubehör
	1.6 i 16V 4WD (EE4)			09.87	08.91				
HONDA CRX (83-87)									
	1.5 (AF)	74		01.86	08.87	- D	13.0460-5919.2	605919	20959 15,0 +/WK AKE
	1.6 i 16V (AS)	92		12.86	08.87		13.0460-5918.2	605918	20099 15,0 +/WK AKE
	1.5 (AF)	74		09.83	12.85	+ D	24.0117-0101.1	417101	231 17,0 15,0 V AKE
	1.5 (AF)	74		01.86	08.87	- D	24.0112-0102.1	412102	231 12,0 10,0
	1.6 i 16V (AS)	92		12.86	08.87		24.0119-0106.1	419106	242 19,0 17,0 V
	1.5 (AF)	74		09.83	08.87		03.0137-0179.2	650179	180 x 31
	1.6 i 16V (AS)	92		12.86	08.87		03.0137-9096.2	669096	Bremsbacken-Zubehör
	1.5 (AF)	74		09.83	08.87		24.0218-0018.1	480063	180/181 x 38
	1.6 i 16V (AS)	92		12.86	08.87				
HONDA CRX (87-91)									
	1.6 i 16V (ED9)			09.87	08.91		13.0460-5920.2	605920	21322 15,0 +/WK AKE
							13.0460-0308.2	610308	Belagsatz-Zubehör AKE
	1.6 i 16V (ED9)			09.87	08.91		24.0119-0106.1	419106	242 19,0 17,0 V
	1.6 i 16V VTEC (EE8)			06.90	08.91		24.0121-0105.1	421105	262 21,0 19,0 V +S +B
	1.6 i 16V (ED9)			09.87	08.91		24.0101-3004.2	260042	Bremssattel-Zubehör TRW
	1.6 i 16V VTEC (EE8)			06.90	08.91				
	1.6 i 16V (ED9)			09.87	08.91		13.0460-5998.2	605998	21312 12,8 +/WK AKE
	1.6 i 16V VTEC (EE8)			06.90	08.91		13.0460-0430.2	610430	Belagsatz-Zubehör AKE
	1.6 i 16V (ED9)			09.87	08.91		24.0110-0212.1	410212	239 10,0 8,0 +S +B
	1.6 i 16V VTEC (EE8)			06.90	08.91				
HONDA LEGEND (86-88)									
	2.5 i (HS)			08.86	08.87		24.0121-0100.1	421100	285 21,0 19,0 V
	2.7 i (HS)			09.87	08.88				
	2.5 i (HS)			08.86	08.87		13.0460-2800.2	602800	20087 14,6 +/WK TRW
	2.7 i (HS)			09.87	08.88				

								
HONDA LEGEND (86-88)								
	2.5 i (HS) 2.7 i (HS)		08.86 09.87	08.87 08.88	24.0110-0255.1	410255		260 10,0 8,0
HONDA LEGEND (91-96)								
	3.2 i 24V (KA7) 3.2 i 24V Coupe (KA8)	151 151	01.91 01.91	01.96 01.96	13.0460-5982.2	605982		21651 17,5 +/WK
	3.2 i 24V (KA7) 3.2 i 24V Coupe (KA8)	151 151	01.91 01.91	01.96 01.96	24.0128-0722.1	428722		282 28,0 26,0 V
	3.2 i 24V (KA7) 3.2 i 24V Coupe (KA8)	151 151	01.91 01.91	01.96 01.96	13.0460-5711.2	605711		23652 15,7 +/WK
	3.2 i 24V (KA7) 3.2 i 24V Coupe (KA8)	151 151	01.91 01.91	01.96 01.96	24.0109-0132.1	409132		282 9,0 7,5
HONDA PRELUDE (83-87)								
	1.8 (AB)		03.83	08.87	13.0460-5919.2	605919		20959 15,0 +/WK AKE
	2.0 i 16V (BA2)		09.85	08.87	24.0121-0102.1	421102		262 21,0 19,0 V
	2.0 i 16V (BA2)		09.85	08.87	13.0460-5998.2 13.0460-0430.2	605998 610430		21312 12,8 +/WK AKE Belagsatz-Zubehör AKE
HONDA PRELUDE (87-91)								
	2.0 (BA4)	80	09.87	12.91	13.0460-5920.2 13.0460-0308.2	605920 610308		21322 15,0 +/WK AKE Belagsatz-Zubehör AKE
	2.0 (BA4) 2.0 i 16V (BA4) 2.0 i 16V (BA4)	80 101 103	09.87 09.87 09.87	12.91 12.91 12.91	24.0119-0104.1 24.0121-0102.1	419104 421102		242 19,0 17,0 V 262 21,0 19,0 V
	2.0 (BA4) 2.0 i 16V (BA4) 2.0 i 16V (BA4)	80 101 103	09.87 09.87 09.87	12.91 12.91 12.91	13.0460-5998.2 13.0460-0430.2	605998 610430		21312 12,8 +/WK AKE Belagsatz-Zubehör AKE
	2.0 (BA4) 2.0 i 16V (BA4) 2.0 i 16V (BA4)	80 101 103	09.87 09.87 09.87	12.91 12.91 12.91	24.0110-0212.1	410212		239 10,0 8,0 +S +B
HONDA PRELUDE (92-96)								
	2.0 i 16V (BB3) 2.2 i 16V VTEC (BB1) 2.3 i 16V (BB2)	98 136 118	01.92 01.93 01.92	12.96 + 14" Rad ¹⁾ 12.96 + 15" Rad ²⁾ 12.96 + 15" Rad ²⁾	13.0460-5955.2 13.0460-0453.2	605955 610453		21879 18,6 +/WK AKE Belagsatz-Zubehör AKE
	2.0 i 16V (BB3) 2.2 i 16V VTEC (BB1) 2.3 i 16V (BB2)	98 136 118	01.92 01.93 01.92	12.96 + 14" Rad ¹⁾ 12.96 + 15" Rad ²⁾ 12.96 + 15" Rad ²⁾	24.0123-0105.1 24.0123-0106.1	423105 423106		260 23,0 21,0 V 282 23,0 21,0 V
	2.0 i 16V (BB3) 2.2 i 16V VTEC (BB1) 2.3 i 16V (BB2)	98 136 118	01.92 01.93 01.92	12.96 12.96 12.96	13.0460-5929.2	605929		21719 15,0 +/WK AKE
	2.0 i 16V (BB3) 2.2 i 16V VTEC (BB1) 2.3 i 16V (BB2)	98 136 118	01.92 01.93 01.92	12.96 12.96 12.96	24.0110-0267.1	410267		260 10,0 8,0
HONDA QUINTET (80-83)								
	1.6 (SU)	59	09.80	06.83	24.3219-1121.3 24.3219-1122.3	020363 020364	<input type="checkbox"/> <input type="checkbox"/>	Rz 19,05 Rz 19,05
HYUNDAI LANTRA/ELANTRA (90-95)								
	1.5		12.90	04.95	24.3541-1807.5 24.3541-1808.5	240335 240336	<input type="checkbox"/> <input type="checkbox"/>	D=54, - Halter AKE D=54, - Halter AKE
	1.5 1.6 16V 1.8 16V		12.90 12.90 12.90	04.95 04.95 04.95	13.0460-5936.2 13.0460-0439.2 13.0460-5933.2	605936 610439 605933		21012 15,0 AKE Belagsatz-Zubehör AKE 21725 16,8 +/WK AKE
	1.5 1.6 16V 1.8 16V		12.90 12.90 12.90	04.95 04.95 04.95	24.0119-0111.1 24.0122-0170.1 24.0322-0170.1	419111 422170 522170		242 19,2 17,0 V 257 22,0 20,0 V 257 22,0 20,0 V PD
	1.5 1.6 16V 1.8 16V		12.90 12.90 12.90	04.95 04.95 04.95	- ABS - ABS - ABS	03.0137-0369.2 650369 03.0137-9270.2 669270		203 x 39 HEB Bremsbacken-Zubehör



























¹⁾ + 14" wheel / + ruota 14" / + roue 14" / + rueda 14"















²⁾ + 15" wheel / + ruota 15" / + roue 15" / + rueda 15"

HYUNDAI PONY/EXCEL (89-94)																			
	1.3 1.5			08.89 08.89	06.94 06.94			24.3541-1807.5 24.3541-1808.5	240335 240336	<input type="checkbox"/>				D=54, - Halter D=54, - Halter	AKE AKE				
	1.3 1.5			08.89 08.89	06.94 06.94			13.0460-5936.2 13.0460-0439.2	605936 610439					21012 15,0 Belagsatz-Zubehör	AKE AKE				
	1.3 1.5			08.89 08.89	06.94 06.94			24.0119-0109.1	419109					242 19,1 17,0 V +B					
	1.3 1.5			06.90 06.90	06.94 06.94			03.0137-0367.2 03.0137-9277.2	650367 669277					180 x 37 HEB Bremsbacken-Zubehör					
HYUNDAI PONY/EXCEL (94-95)																			
	1.3 1.5			07.94 07.94	12.95 12.95			13.0460-5936.2	605936					21012 15,0	AKE				
	1.3 1.5			07.94 07.94	12.95 12.95			24.0119-0109.1	419109					242 19,1 17,0 V +B					
	1.3 1.5			07.94 07.94	12.95 12.95			03.0137-0366.2 03.0137-9277.2	650366 669277					180 x 32 HEB Bremsbacken-Zubehör					
	1.3 1.5			07.94 07.94	12.95 12.95			24.0218-0027.1	480099					180/182 x 44					
	1.3 1.5			07.94 07.94	12.95 12.95			24.3727-3103.2 24.3727-3102.2	583103 583102	<input type="checkbox"/> <input type="checkbox"/>				L=1485 L=1485					
HYUNDAI SONATA (88-93)																			
	1.8 2.0 2.4 3.0 i V6	95 83 107		10.88 10.88 10.88 09.90	04.93 04.93 04.93			13.0460-5933.2	605933					21725 16,8 +/WK	AKE				
	1.8 2.0 2.4 3.0 i V6	95 83 107		10.88 10.88 10.88 09.90	04.93 04.93 04.93			24.0122-0169.1	422169					257 22,0 20,0 V					
HYUNDAI S-COUPE (90-96)																			
	1.5 (G4DJ) 1.5 (G4EK) 1.5 i Turbo	62 65 85		03.90 06.92 04.91	05.92 04.96 05.96			24.3541-1807.5 24.3541-1808.5	240335 240336	<input type="checkbox"/> <input type="checkbox"/>				D=54, - Halter D=54, - Halter	AKE AKE				
	1.5 (G4EK) 1.5 i Turbo	65 85		06.92 06.92	04.96 05.96			13.0460-5936.2 13.0460-0439.2	605936 610439					21012 15,0 Belagsatz-Zubehör	AKE AKE				
	1.5 (G4DJ) 1.5 (G4EK) 1.5 i Turbo	62 65 85		03.90 06.92 04.91	05.92 04.96 05.96			24.0119-0109.1	419109					242 19,1 17,0 V +B					
	1.5 (G4EK) 1.5 i Turbo	65 85		06.92 06.92	04.96 05.96			03.0137-0367.2 03.0137-9277.2	650367 669277					180 x 37 HEB Bremsbacken-Zubehör					
HYUNDAI STELLAR (84-90)																			
	1.4 1.6 1.6	50 56 56		02.84 02.84 06.86	01.87 05.86 02.90	- ABS		13.0460-7042.2	607042					20491 15,0	TRW				
	1.4 1.6	50 56		02.84 02.84	01.87 02.90	- ABS		13.0460-5936.2 13.0460-0439.2	605936 610439					21012 15,0 Belagsatz-Zubehör	AKE AKE				
	1.4 1.6	50 56		02.84 02.84	01.87 02.90	- ABS		24.0113-0122.1	413122					248 12,7 11,4					
INNOCENTI INNOCENTI																			
	Mille Mini 120 Mini 650 Mini 90 Mini Diesel Mini Turbo De Tomaso Minitre Small 500/990			01.80 01.84 01.85 05.74 01.84 01.83 01.83 01.86	12.83 12.88 12.87 02.82 12.86 12.90 12.86 12.92			13.0460-6914.2	606914					20038 14,0	AP				
	Elba Mille 1.0 i.e.			01.91 01.94				13.0460-5409.2	605409					21193 18,0 +	ATE				
	Mini 120 Mini 90 Mini Turbo De Tomaso			01.84 05.74 01.83	12.88 02.82 12.90			03.0137-0080.2 03.0137-9205.2	650080 669205					178 x 32 Bremsbacken-Zubehör	AP AP				
ISUZU TROOPER (81-86)																			
	2.0 (UBS13) 2.2 D (UBS52)	45		09.81 09.81	11.86 11.86			24.0112-0145.1	412145					266 12,0 10,6					

										
ISUZU TROOPER (86-91)										
	2.2 TD (UBS52) 2.3 (UBS16) 2.6 i (UBS17) 2.8 TD (UBS55)	53 66 85		02.90 12.91 02.90 12.91		24.3601-1715.5 24.3601-1716.5	240389 240390	 	D=60, - Halter D=60, - Halter	AKE AKE
	2.2 TD (UBS52) 2.3 (UBS16) 2.6 i (UBS17) 2.8 TD (UBS55)	53 4524289 66 4524289 85 4524289 4524289		12.91 12.91 12.91 12.91		13.0460-5942.2 13.0460-0337.2	605942 610337		21544 16,5 +/WK Belagsatz-Zubehör	AKE AKE
	2.2 TD (UBS52) 2.3 (UBS16) 2.6 i (UBS17) 2.8 TD (UBS55)	53 4524289 66 4524289 85 4524289 4524289		12.91 12.91 12.91 12.91		24.0122-0156.1	422156		257 22,0 20,6 V	
	2.2 TD (UBS52) 2.3 (UBS16) 2.6 i (UBS17) 2.8 TD (UBS55)	53 K7100001 66 K7100001 85 K7100001 K7100001		12.91 12.91 12.91 12.91		24.0112-0145.1	412145		266 12,0 10,6	
	2.2 TD (UBS52) 2.3 (UBS16) 2.6 i (UBS17) 2.8 TD (UBS55)	53 66 85		11.86 10.88 11.86 10.88		24.3225-1702.3	020425		Rz 25,40	
IVECO EUROCARGO										
	60 E10 60 E12 60 E14 65 E10 65 E12 65 E14 75 E12 75 E14 75 E15			01.91 01.91 01.91 01.91 01.91 01.91 06.96 06.96 06.96		13.0460-4914.2	604914		29122 22,3 /WE	BRE
	100 E15 100 E18 180 E21 80 E15 80 E18 85 E15			01.91 01.91 01.91 01.87 01.87 01.87		13.0460-2843.2 24.8190-2901.2	602843 622901	2	29067 22,3 /WE Warnkontakt L=500mm	TRW
	60 E10 60 E12 60 E14 65 E10 65 E12 65 E14 75 E12 75 E14 75 E15			01.91 01.91 01.91 01.91 01.91 01.91 06.96 06.96 06.96		13.0460-4914.2	604914		29122 22,3 /WE	BRE
	100 E15 100 E18 180 E21 80 E15 80 E18 85 E15			01.91 01.91 01.91 01.87 01.87 01.87		13.0460-2843.2 24.8190-2901.2	602843 622901	2	29067 22,3 /WE Warnkontakt L=500mm	TRW
IVECO LKW 75-330										
	110-13 A/AH 110-16 A 130-13 A/AH 130-16 A/AH/AHT 75-9 A 80-13 A/AH/AT/AW 80-16 A/AW 90-13 A/AH/AT 90-16 AW			01.83 01.83 01.83 01.83 01.82 01.83 01.83 01.83 01.83		24.2423-0905.3	030070		Gz 23,81	
	110-13 A/AH 110-16 A 130-13 A/AH 130-16 A/AH/AHT 75-9 A 80-13 A/AH/AT 80-13 AW 80-16 A/AW 90-13 A/AH/AT 90-16 AW			01.83 01.83 01.83 01.83 01.82 01.83 01.83 01.83 01.83 01.83	+ ZF-Getriebe ¹⁾ + ZF-Getriebe ¹⁾ + ZF-Getriebe ¹⁾ + ZF-Getriebe ¹⁾ + ZF-Getriebe ¹⁾ + ZF-Getriebe ¹⁾	24.2538-0901.3	040056		Nz 38,10	
IVECO Z-REIHE / ZETA										
	65 79.10 79.12 79.13 79.14			01.83 01.83 01.83 01.83 01.83		13.0460-4914.2	604914		29122 22,3 /WE	BRE
	109.14 95.14			01.83 01.83		13.0460-2843.2 24.8190-2901.2	602843 622901	2	29067 22,3 /WE Warnkontakt L=500mm	TRW

¹⁾ + ZF transmission / + scatola cambio ZF / + boîte de vitesse ZF / + cambio ZF

								
IVECO Z-REIHE / ZETA								
	65 79.10 79.12 79.13 79.14		01.83 01.83 01.83 01.83 01.83		13.0460-4914.2 604914			29122 22,3 /WE BRE
JAGUAR XJ (XJ40,81) (86-96)								
	XJ12 6.0 229 XJ6 2.9 XJ6 3.2 24V 146 XJ6 3.6 XJ6 4.0 163		03.93 11.94 10.86 08.90 09.90 11.94 10.86 08.89 09.89 11.94		13.0460-7138.2 607138 24.8190-1302.2 621302	2		23126 17,5 +/WE Warnkontakt L=276mm ATE
	XJ12 6.0 229 XJ6 2.9 XJ6 3.2 24V 146 XJ6 3.6 XJ6 4.0 163		03.93 11.94 10.86 08.90 09.90 11.94 10.86 08.89 09.89 11.94		24.0123-0108.1 423108 24.0128-0138.1 428138			295 22,5 21,0 V 291 28,1 26,0 V +B
	XJ12 6.0 229 XJ6 2.9 XJ6 3.2 24V 146 XJ6 3.6 XJ6 4.0 163		03.93 11.94 10.86 08.90 09.90 11.94 10.86 08.89 09.89 11.94		13.0460-7246.2 607246			21275 17,0 +/WE ATE
	XJ12 6.0 229 XJ6 2.9 XJ6 3.2 24V 146 XJ6 3.6 XJ6 4.0 163		03.93 11.94 10.86 08.90 09.90 11.94 10.86 08.89 09.89 11.94		24.0110-0319.1 410319			295 10,0 8,8
JAGUAR XJ (X300) (94-97)								
	12 6.0 229 6 3.2 155 6 Sovereign 4.0 177 R Super Charged 4.0 235		11.94 07.97 11.94 07.97 11.94 07.97 11.94 07.97		11.9601-9782.2 220992 11.0441-6003.2 250037 11.8116-0073.1 390498 11.8171-0008.1 990049 11.0101-5407.2 260011	2	<input type="checkbox"/>	D=60, - Halter Dichtungssatz Haltefeder Führungsbolzen Hülssensatz ATE ATE ATE ATE
	12 6.0 229 6 3.2 155 6 Sovereign 4.0 177 R Super Charged 4.0 235		11.94 07.97 11.94 07.97 11.94 07.97 11.94 07.97		13.0460-7138.2 607138 24.8190-1302.2 621302	2		23126 17,5 +/WE Warnkontakt L=276mm ATE
	12 6.0 229 6 3.2 155 6 Sovereign 4.0 177 R Super Charged 4.0 235		11.94 07.97 11.94 07.97 11.94 07.97 11.94 07.97		24.0128-0138.1 428138			291 28,1 26,0 V +B
	6 3.2 155 6 Sovereign 4.0 177 R Super Charged 4.0 235		11.94 07.97 11.94 07.97 11.94 07.97		83.6314-0375.3 330558 83.7835-0412.3 331275	2 1	<input type="checkbox"/> <input type="checkbox"/>	L=375 L=410
	12 6.0 229 6 3.2 155 6 Sovereign 4.0 177 R Super Charged 4.0 235		11.94 07.97 11.94 07.97 11.94 07.97 11.94 07.97		11.9481-9871.2 220681 11.9481-9872.2 220682		<input type="checkbox"/> <input type="checkbox"/>	D=48, - Halter D=48, - Halter ATE ATE
	12 6.0 229 6 3.2 155 6 Sovereign 4.0 177 R Super Charged 4.0 235		11.94 07.97 11.94 07.97 11.94 07.97 11.94 07.97		24.0120-0188.1 420188			305 20,0 18,5 V +B
	12 6.0 229 6 3.2 155 6 Sovereign 4.0 177 R Super Charged 4.0 235		11.94 07.97 11.94 07.97 11.94 07.97 11.94 07.97		03.0137-9700.2 669700			Bremsbacken-Zubehör
JAGUAR XJS (88-96)								
	XJS 4.0 Cabrio XJS 4.0 Coupe XJS 5.3 Coupe XJS 6.0 Coupe		05.91 03.96 05.91 09.94 01.88 08.93 05.93 03.96		13.0460-7138.2 607138 24.8190-1302.2 621302	2		23126 17,5 +/WE Warnkontakt L=276mm ATE
	XJS 4.0 Cabrio XJS 4.0 Coupe XJS 5.3 Coupe XJS 6.0 Coupe		05.91 03.96 05.91 09.94 01.88 08.93 05.93 03.96		24.0124-0174.1 424174			284 24,2 22,9 V
	XJS 4.0 Cabrio XJS 4.0 Coupe XJS 5.3 Coupe XJS 6.0 Coupe		05.91 03.96 05.91 09.94 01.88 08.93 05.93 03.96		13.0460-7246.2 607246			21275 17,0 +/WE ATE
	XJS 4.0 Cabrio XJS 4.0 Coupe XJS 5.3 Coupe XJS 6.0 Coupe		05.91 03.96 05.91 09.94 01.88 08.93 05.93 03.96		24.0110-0319.1 410319			295 10,0 8,8
JEEP CHEROKEE(XJ)/WAGON(XJ)/COMANCHE(MJ) (87-04)								
	2.1 TD 4x4 2.5 i 4x4 2.5 TD 4x4 4.0 i 4x4		01.87 12.89 01.87 12.89 01.87 12.89 01.87 12.89		24.0122-0181.1 422181			280 22,2 20,7 V
	2.1 TD 2.1 TD 4x4 2.5 i 2.5 i 4x4 2.5 TD		01.94 01.99 01.90 12.93 01.94 01.99 01.90 12.93 01.94 01.99		24.0124-0702.1 424702			280 24,0 22,7 V +B

        									
JEEP CHEROKEE(XJ)/WAGON(XJ)/COMANCHE(MJ) (87-04)									
	2.5 TD 4x4 4.0 i 4.0 i 4x4		01.90 01.94 01.90	12.93 01.99 12.93	24.0124-0702.1	424702			280 24,0 22,7 V +B
JEEP WRANGLER I (YJ) (87-96)									
	2.5 4.0 4.2	131	01.87 01.87 08.86	12.89 12.89 08.89	24.0122-0181.1	422181			280 22,2 20,7 V
	2.5 4.0	131	01.90 01.90	12.96 12.96	24.0124-0702.1	424702			280 24,0 22,7 V +B
KÄSSBOHRER S 6 - S 215									
	S 100/A S 110/A S 120 A S 80 S 80 B S 80 E/H		01.67 01.67 01.67 01.67 01.75 01.68	12.69 12.69 12.69 12.69 12.77 12.77	03.3131-0601.3	010299			Hz 31,75 ATE
	S 120 S 125 S 130 S 140 S 150		01.67 01.67 01.67 01.71 01.67	12.77 + Trommelbremse ¹⁾ 12.71 + Trommelbremse ¹⁾ 12.84 + Trommelbremse ¹⁾ 12.83 + Trommelbremse ¹⁾ 12.77 + Trommelbremse ¹⁾	03.3131-0601.3	010299	+ Vorderachse ²⁾		Hz 31,75 ATE
	SG 180 S 208 S 211		01.71 01.79 01.76	12.83 + Trommelbremse ¹⁾ 12.83 + Trommelbremse ¹⁾	03.3131-0601.3	010299	+ Vorderachse ²⁾		Hz 31,75 ATE
	S 212/213/215 S 212/213/215		01.76 01.76	+ Trommelbremse ¹⁾ + Scheibenbremse ³⁾	03.3134-0300.3 03.3138-2010.3	010308 010311	+ Vorderachse ²⁾ + Vorderachse ²⁾		Hz 34,92 ATE Hz 38,10 ATE
	S 100/A S 110/A S 12 S 120 S 120 A S 125 S 130 S 14 S 140 S 150 S 200 S 208 S 6 S 80 S 80 B S 80 E/H S 9/10/11 SG 180		01.67 01.67 01.60 01.67 01.67 01.67 01.62 01.71 01.67 01.72 01.79 01.57 01.67 01.75 01.68 01.60 01.71	12.69 12.69 12.60 12.77 12.69 12.71 12.67 12.83 12.77 12.76 12.83 12.67 12.77 12.77 12.67 12.83	83.6103-0500.3	330230			L=500
	S 211 S 212/213/215 S 212/213/215		01.76 01.76 01.78	12.77 12.77 12.77	83.6103-0350.3 83.6103-0500.3 83.6103-0500.3	330225 330230 330230			L=350 L=500 L=500
	S 12 S 14 S 6 S 9/10/11 S 80		01.60 01.62 01.57 01.60 01.67	12.67 12.67 12.67 12.67	83.6103-0450.3 83.6103-0500.3	330228 330230	■ ■		L=450 L=500
	S 100/A S 110/A S 120 S 120 A S 125 S 130 S 140 S 150 S 208 S 211 S 212/213/215 S 80 B S 80 E/H		01.67 01.67 01.67 01.67 01.67 01.71 01.67 01.79 01.76 01.76 01.75 01.68	12.69 12.69 12.77 12.69 12.71 12.83 12.77 12.83 12.77 12.83 12.77 12.77	83.6103-0500.3	330230	■ ■		L=500
	S 100 S 110 H/P S 12 S 120 S 125 S 130 S 130 S S 14 S 140 S 140 ES S 150 S 6/9/10/11 S 80 SG 175	155101	01.67 01.67 01.60 01.67 01.65 01.67 01.67 01.62 01.71 01.71 01.67 01.67 01.65	12.69 12.76 12.60 12.77 12.71 12.84 12.84 12.67 12.76 12.76 12.77 12.77 12.71	03.3125-0401.3	010290			Hz 25,40 ATE
				- Druckluftunterstützung ⁴⁾					

¹⁾ + drum brake / + freno a tamburo / + freins à tambour / + tambores de freno

²⁾ + front axle / + asse anteriore / + essieu avant / + eje delantero

³⁾ + disc brake / + disco freno / + disques de frein / + disco de freno

⁴⁾ - air brake assistance / - comando aria compressa / - assistance pneumatique / - freno de aire auxiliár



KÄSSBOHRER S 6 - S 215

	S 130 S	155102	01.71	12.84	+ Druckluftunterstützung ¹⁾	03.0450-3801.2	083801		Nz Reparatursatz
	S 140 ES		12.83	12.83					
	SG 180	162031	01.71	12.83		03.0450-3801.2	083801		Nz Reparatursatz
	S 200		12.76	12.76					
	S 208		01.79	12.83					
	S 209		01.77	12.83					
	S 211/212/213/215		01.76	12.83					

KIA PRIDE Limousine (90-94)

	1.1 i	38	01.91	04.94		13.0460-5970.2	605970		21355 13,5 +/WK	SUM
	1.3 i 16V	44	01.90	04.94						
	1.3 i 16V	51	01.90	04.94						
	1.3 i 16V	53	01.90	04.94						
	1.1 i	38	01.91	04.94		24.0113-0165.1	413165		219 13,0 11,0	
	1.3 i 16V	44	01.90	04.94						
	1.3 i 16V	51	01.90	04.94						
	1.3 i 16V	53	01.90	04.94						
	1.1 i	38	01.91	04.94		03.0137-0204.2	650204		170 x 25	
	1.3 i 16V	44	01.90	04.94						
	1.3 i 16V	51	01.90	04.94						
	1.3 i 16V	53	01.90	04.94						

LADA 1200-1600 (2101/2102/2103/2106) (73-86)































	1200		05.73	06.86		24.2119-0831.3	010416		THz 19,05	
	1300		09.74	06.86						
	1500		09.75	06.85						
	1600		12.75	06.85						
	1200		05.73	06.86		13.0460-2966.2	602966		20166 16,0	TRW
	1300		09.74	06.86						
	1500		09.75	06.85						
	1600		12.75	06.85						
	1200		05.73	06.86		24.0111-0115.1	411115		253 10,0 9,0 +B	
	1300		09.74	06.86						
	1500		09.75	06.85						
	1600		12.75	06.85						
	1200		05.73	06.86		24.3220-1102.3	020213		Rz 20,64	
	1300		09.74	06.86						
	1500		09.75	06.85						
	1600		12.75	06.85						
	1200		05.73	06.86		03.0137-0232.2	650232		250 x 51	Bremsbacken-Zubehör
	1300		09.74	06.86						
	1500		09.75	06.85						
	1600		12.75	06.85						
	1200		05.73	06.86		03.0420-0620.3	680620		20,64/250x51 Kit	
	1300		09.74	06.86						
	1500		09.75	06.85						
	1600		12.75	06.85						
	1200		05.73	06.86		24.3727-2402.2	582402	1	L=2503	
	1300		09.74	06.86						
	1500		09.75	06.85						
	1600		12.75	06.85						
	1200		05.73	06.86		24.2419-1101.3	030085		Gz 19,05	
	1300		09.74	06.86						
	1500		09.75	06.85						
	1600		12.75	06.85						
	1200		05.73	06.86		24.2519-0505.3	040070		Nz 19,05	
	1300		09.74	06.86						
	1500		09.75	06.85						
	1600		12.75	06.85						































LADA FORMA (2108) (89-95)

	1100		07.91	12.95		24.2120-0803.3	010415		THz 20,64	
	1300		05.89	12.95						
	1500		07.91	12.95						
	1100		07.91	12.95		13.0460-2965.2	602965		21170 17,3	TRW
	1300		05.89	12.95						
	1500		07.91	12.95						
	1100		07.91	12.95		24.0112-0125.1	412125		239 12,0 10,8 +B	239 12,0 10,8 +B PD
	1300		05.89	12.95						
	1500		07.91	12.95						
	1100		07.91	12.95		24.5127-0305.3	330578	2	L=305	
	1300		05.89	12.95						
	1500		07.91	12.95						
	1100		07.91	12.95		24.3220-1103.3	020214		Rz 20,64	
	1300		05.89	12.95						
	1500		07.91	12.95						
	1100		07.91	12.95		03.0137-0231.2	650231		200 x 41	Bremsbacken-Zubehör
	1300		05.89	12.95						
	1500		07.91	12.95						
	1100		07.91	12.95		24.0220-0020.1	480059		200/201,5 x 50	
	1300		05.89	12.95						
	1500		07.91	12.95						

¹⁾ + air brake assistance / + servofreno ad aria / + assistance pneumatique / + freno de aire auxiliar



	 kW							
LADA FORMA (2108) (89-95)								
	1100 1300 1500		07.91 05.89 07.91	12.95 12.95 12.95	24.3727-2403.2	582403	2	L=1617
LADA NIVA (2121) (76-95)								
	1.6		12.76	03.95	24.2119-0832.3	010417		THz 19,05
	1.6		12.76	03.95	13.0460-8006.2	608006		20660 15,6
	1.6		12.76	03.95	24.0112-0130.1	412130		272 11,0 9,9
	1.6		12.76	03.95	24.3220-1102.3	020213		Rz 20,64
	1.6		12.76	03.95	03.0137-0232.2 03.0137-9117.2	650232 669117		250 x 51 Bremsbacken-Zubehör
	1.6		12.76	03.95	24.0225-0004.1	480058		250/251,5 x 57,5
	1.6		12.76	03.95	03.0420-0620.3	680620		20,64/250x51 Kit
	1.6		12.76	03.95	24.3727-2401.2	582401	1	L=2122
LADA NIVA (2121) (93-)								
	1700 i 1700 i 4x4 1900 Diesel 1900 Diesel	59 60 47 55	06.96 10.00 03.93 01.99		24.2119-0832.3	010417		THz 19,05
	1700 i 1700 i 4x4 1900 Diesel 1900 Diesel	59 60 47 55	06.96 10.00 03.93 01.99		13.0460-8006.2	608006		20660 15,6
	1700 i 1700 i 4x4 1900 Diesel 1900 Diesel	59 60 47 55	06.96 10.00 03.93 01.99		24.0112-0130.1	412130		272 11,0 9,9
	1700 i 1700 i 4x4 1900 Diesel 1900 Diesel	59 60 47 55	06.96 10.00 03.93 01.99		24.3220-1102.3	020213		Rz 20,64
	1700 i 1700 i 4x4 1900 Diesel 1900 Diesel	59 60 47 55	06.96 10.00 03.93 01.99		03.0137-0232.2	650232		250 x 51
	1700 i 1700 i 4x4 1900 Diesel 1900 Diesel	59 60 47 55	06.96 10.00 03.93 01.99		24.0225-0004.1	480058		250/251,5 x 57,5
LADA NOVA (2104/2105) (75-96)								
	1200 1300 1500 1600 1700		02.81 02.81 09.75 01.88 08.94	12.96 12.96 12.96 12.96 12.96	24.2119-0832.3	010417		THz 19,05
	1200 1300 1500 1600 1700		02.81 02.81 09.75 01.88 08.94	12.96 12.96 12.96 12.96 12.96	13.0460-2966.2	602966		20166 16,0 TRW
	1200 1300 1500 1600 1700		02.81 02.81 09.75 01.88 08.94	12.96 12.96 12.96 12.96 12.96	24.0111-0115.1	411115		253 10,0 9,0 +B
	1200 1300 1500		02.81 02.81 09.75	12.96 12.96 12.96	24.3220-1103.3	020214		Rz 20,64
	1200 1300 1500		02.81 02.81 09.75	12.96 12.96 12.96	03.0137-0232.2 03.0137-9117.2	650232 669117		250 x 51 Bremsbacken-Zubehör
	1200 1300 1500		02.81 02.81 09.75	12.96 12.96 12.96	24.3727-2402.2	582402	1	L=2503

									
LADA TOSCANA (2107) (83-96)									
	1300 1500			09.85 09.83	12.96 02.93		13.0460-2966.2	602966	20166 16,0 TRW
	1300 1500			09.85 09.83	12.96 02.93		24.0111-0115.1	411115	253 10,0 9,0 +B
	1300 1500			09.85 09.83	12.96 02.93		24.3220-1103.3	020214	Rz 20,64
	1300 1500			09.85 09.83	12.96 02.93		03.0137-0232.2 03.0137-9117.2	650232 669117	250 x 51 Bremsbacken-Zubehör
	1300 1500			09.85 09.83	12.96 02.93		24.3727-2402.2	582402	1  L=2503
LANCIA DEDRA (90-93)									
	1.6 i.e. 1.8 i.e. 1.9 TD 2.0 i.e. 2.0 TD	66		01.90 01.90 01.90 01.90 01.90	10.93 10.93 10.93 10.93 10.93		24.2120-1710.3	010468	- ABS Thz 20,64
	2.0 i.e. Turbo 2.0 Integrale			05.91 09.91	10.93 10.93		24.2122-1716.3	010485	Thz 22,20
	1.6 i.e. 1.6 i.e. 1.8 i.e. 1.9 TD 2.0 i.e. 2.0 TD	66		01.90 02.93 01.90 01.90 01.90 01.90	10.93 10.93 10.93 10.93 10.93 10.93	- ABS + ABS	13.0460-2948.2 13.0460-2949.2	602948 602949	21100 16,7 +WK/S TRW 20833 17,0 +WK/S TRW
	2.0 i.e. Turbo 2.0 Integrale			05.91 09.91	10.93 10.93		13.0460-2979.2	602979	21147 19,0 +WK/S TRW
	1.6 i.e. 1.6 i.e. 1.6 i.e. 1.8 i.e. 1.9 TD 2.0 TD	66		01.90 01.90 02.93 01.90 01.90 01.90	10.93 10.93 10.93 10.93 10.93 10.93	- ABS + ABS	24.0111-0119.1 24.0112-0127.1	411119 412127	241 11,0 9,2 +B 258 12,0 10,2 +B
	2.0 i.e. 2.0 i.e. Turbo 2.0 Integrale			01.90 05.91 09.91	10.93 10.93 10.93		24.0120-0142.1 24.0320-0142.1 24.0122-0107.1	420142 520142 422107	258 20,0 18,2 V L +B 258 20,0 18,2 V L +B PD 284 22,0 20,2 V +B
	1.6 i.e. 1.8 i.e. 1.9 TD 2.0 i.e. 2.0 i.e. Turbo 2.0 Integrale 2.0 TD	66		01.90 01.90 01.90 01.90 05.91 09.91 01.90	10.93 10.93 10.93 10.93 10.93 10.93 10.93	+ ABS	24.3344-1703.5 24.3344-1704.5 24.0101-3601.2	240117 240118 260044	<input type="checkbox"/> <input type="checkbox"/> D=34, - Halter TRW D=34, - Halter TRW Bremsattel-Zubehör TRW
	1.6 i.e. 1.8 i.e. 1.9 TD 2.0 i.e. 2.0 i.e. Turbo 2.0 Integrale 2.0 TD	66		01.90 01.90 01.90 01.90 05.91 09.91 01.90	10.93 10.93 10.93 10.93 10.93 10.93 10.93	+ ABS	13.0460-2951.2 13.0460-0072.2	602951 610072	21103 14,2 /S TRW Belagsatz-Zubehör TRW
	1.6 i.e. 1.8 i.e. 1.9 TD 2.0 i.e. 2.0 i.e. Turbo 2.0 Integrale 2.0 TD	66		01.90 01.90 01.90 01.90 05.91 09.91 01.90	10.93 10.93 10.93 10.93 10.93 10.93 10.93	+ ABS	24.0111-0119.1	411119	241 11,0 9,2 +B
	1.6 i.e. 1.6 i.e.			01.90 02.93	10.93 10.93	- ABS - ABS	24.3219-1102.3 24.3222-1701.3	020190 020376	Rz 19,05 BDX Rz 22,20
	1.6 i.e.			01.90	10.93	- ABS	03.0137-0207.2 03.0137-9088.2	650207 669088	180 x 32 Bremsbacken-Zubehör BDX BDX
	1.6 i.e.			01.90	10.93	- ABS	24.0218-0011.1	480006	180/181,4 x 40
	1.6 i.e. 1.6 i.e.			01.90 02.93	01.93 10.93	- ABS - ABS	03.0520-1219.3 03.0420-4322.3	691219 684322	19,05/180x32 TopKit BDX 22,20/180x32 Kit BDX
	1.6 i.e.			01.90	10.93	- ABS	24.3727-0511.2 24.3727-0510.2	580511 580510	<input type="checkbox"/> <input type="checkbox"/> L=1415 L=1375
	1.6 i.e. 1.8 i.e. 1.9 TD 2.0 i.e. 2.0 i.e. Turbo	66		01.90 01.90 01.90 01.90 05.91	10.93 10.93 10.93 10.93 10.93	+ ABS	24.3727-0521.2 24.3727-0006.2	580521 580006	<input type="checkbox"/> <input type="checkbox"/> L=1517 L=1460





LANCIA DEDRA (90-93)



































	2.0 TD			01.90	10.93		24.3727-0521.2	580521	<input type="checkbox"/>		L=1517 L=1460
	1.6 i.e.			01.90	10.93		24.3728-0503.2	590503			L=729
	1.8 i.e.			01.90	10.93						
	2.0 i.e.			01.90	10.93		24.3728-0502.2	590502			L=764

LANCIA DELTA (79-86)

	1.6 GT 1.6 HF Turbo 1300 1500			04.83 08.83 10.79 10.79	06.86 06.86 06.86 06.86		24.2119-0829.3	010351			Thz 19,05
	1.6 GT 1.6 HF Turbo	285797 272995			06.86 06.86		13.0460-2941.2	602941			20839 17,0 /WK/S TRW
	1300 1500			10.79 10.79	06.86 06.86		24.0111-0130.1	411130			227 10,8 9,0 +B
	1.6 GT 1.6 HF Turbo			04.83 08.83	06.86 06.86		24.0112-0112.1	412112			257 12,0 10,8
	1.6 GT 1.6 HF Turbo			04.83 08.83	06.86 06.86		13.0460-3942.2	603942			20841 12,0 /WE BDX
	1.6 GT 1.6 HF Turbo			04.83 08.83	06.86 06.86		24.0111-0130.1	411130			227 10,8 9,0 +B
	1300 1500		262990 262990	10.79 10.79			24.3217-1115.3	020310			Rz 17,46 FI
	1300 1500	262991 262991			06.86 06.86		24.3219-0803.3	020183			Rz 19,05
	1300 1500			10.79 10.79	06.86 06.86		03.0137-0015.2 03.0137-9021.2	650015 669021			185 x 31 AUT Bremsbacken-Zubehör FI FI
	1300 1500			10.79 10.79	06.86 06.86		24.0218-5001.1	480012			185/186,8 x 37
	1300 1500		262990 262990	10.79 10.79			03.0420-0917.3	680917			17,46/185x31 Kit FI
	1300 1500	262991 262991			06.86 06.86		03.0420-0319.3	680319			19,05/185x31 Kit FI

LANCIA DELTA (86-93)





















	1.3 1.5 1.6 GT i.e. 1.6 i.e. 2.0 TD			07.86 07.86 08.86 07.86 07.86	10.93 10.93 10.93 10.93 10.93		24.2119-0829.3	010351			Thz 19,05
	1.6 i.e.			07.86	04.90		13.0460-2941.2	602941			20839 17,0 /WK/S TRW
	2.0 HF Integrale 2.0 i.e.16V Integrale			11.87 06.89	10.93 10.93		13.0460-4958.2	604958			21381 17,3 +/WK BRE
	2.0 i.e. 16V			07.86	12.91		13.0460-2980.2	602980			21147 19,0 +/WK/S TRW
	2.0 i.e. 16V Turbo			07.86	12.91		13.0460-2979.2	602979			21147 19,0 +/WK/S TRW
	1.3 1.5			07.86 07.86	10.93 10.93		24.0111-0130.1	411130			227 10,8 9,0 +B
	1.6 i.e. 2.0 TD			07.86 07.86	10.93 10.93		24.0112-0112.1	412112			257 12,0 10,8
	1.6 GT i.e. 2.0 i.e. Turbo			08.86 07.86	10.93 12.91		24.0120-0129.1	420129			257 20,0 18,2 V
	2.0 HF Integrale 2.0 i.e.16V Integrale			11.87 06.89	10.93 10.93		24.0126-0114.1	426114			281 26,0 24,2 V
	2.0 i.e. 16V 2.0 i.e. 16V Turbo			07.86 07.86	12.91 12.91		24.0122-0147.1	422147			284 22,0 20,2 V +B
	1.6 GT i.e. 1.6 i.e. 2.0 i.e. 16V 2.0 i.e. 16V Turbo			08.86 07.86 07.86 07.86	10.93 10.93 12.91 12.91		13.0460-3942.2	603942			20841 12,0 /WE BDX
	1.6 GT i.e. 1.6 i.e. 2.0 i.e. 16V 2.0 i.e. 16V Turbo 2.0 i.e. Turbo			08.86 07.86 07.86 07.86 07.86	10.93 10.93 12.91 12.91 12.91		24.0111-0130.1	411130			227 10,8 9,0 +B
	2.0 HF Integrale 2.0 i.e.16V Integrale			11.87 06.89	10.93 10.93		24.0110-0209.1	410209			251 10,0 9,0 +B
	1.3 1.5 2.0 TD			07.86 07.86 07.86	10.93 10.93 10.93		24.3219-0803.3	020183			Rz 19,05
	1.3 1.5 2.0 TD			07.86 07.86 07.86	10.93 10.93 10.93		03.0137-0015.2 03.0137-9021.2	650015 669021			185 x 31 AUT Bremsbacken-Zubehör FI FI
	1.3 1.5 2.0 TD			07.86 07.86 07.86	10.93 10.93 10.93		24.0218-5001.1	480012			185/186,8 x 37

        									
LANCIA DELTA (86-93)									
	1.3 1.5 2.0 TD		07.86 07.86 07.86	10.93 10.93 10.93	03.0420-0319.3	680319		19,05/185x31 Kit	FI
LANCIA PRISMA (83-86)									
	1.6 1.9 TD 1300 1500		04.83 06.85 04.83 04.83	06.86 06.86 06.86 06.86	24.2119-0829.3	010351		THz 19,05	
	1.6	3067650		06.86	13.0460-2941.2	602941		20839 17,0 /WK/S	TRW
	1300 1500		04.83 04.83	06.86 06.86	24.0111-0130.1	411130		227 10,8 9,0 +B	
	1.6 1.9 TD		04.83 06.85	06.86 06.86	24.0112-0112.1	412112		257 12,0 10,8	
	1.6		04.83	06.86	13.0460-3942.2	603942		20841 12,0 /WE	BDX
	1.6		04.83	06.86	24.0111-0130.1	411130		227 10,8 9,0 +B	
	1300 1500		3032272 3032272	04.83 04.83	24.3217-1115.3	020310		Rz 17,46	FI
	1.9 TD 1300 1500	3032273 3032273		06.85 06.86 06.86	24.3219-0803.3	020183		Rz 19,05	
	1.9 TD 1300 1500		06.85 04.83 04.83	06.86 06.86 06.86	03.0137-0015.2 03.0137-9021.2	650015 669021		185 x 31 AUT Bremsbacken-Zubehör	FI FI
	1.9 TD 1300 1500		06.85 04.83 04.83	06.86 06.86 06.86	24.0218-5001.1	480012		185/186,8 x 37	
	1300 1500		3032272 3032272	04.83 04.83	03.0420-0917.3	680917		17,46/185x31 Kit	FI
	1.9 TD 1300 1500	3032273 3032273		06.85 06.86 06.86	03.0420-0319.3	680319		19,05/185x31 Kit	FI
LANCIA PRISMA (86-89)									
	1.3 1.5 1.6 1.6 i.e. 1.9 TD		07.86 07.86 07.86 07.86 07.86	06.89 06.89 06.89 06.89 06.89	24.2119-0829.3	010351		THz 19,05	
	1.3 1.5		07.86 07.86	06.89 06.89	24.0111-0130.1	411130		227 10,8 9,0 +B	
	1.6 1.6 i.e. 1.9 TD 2.0 i.e. 2.0 i.e. Allrad		07.86 07.86 07.86 01.87 03.87	06.89 06.89 06.89 06.89 06.89	24.0112-0112.1	412112		257 12,0 10,8	
	1.6 1.6 i.e.		07.86 07.86	06.89 06.89	13.0460-3942.2	603942		20841 12,0 /WE	BDX
	1.6 1.6 i.e. 2.0 i.e. 2.0 i.e. Allrad		07.86 07.86 01.87 03.87	06.89 06.89 06.89 08.88	24.0111-0130.1	411130		227 10,8 9,0 +B	
	1.3 1.5 1.9 TD		07.86 07.86 07.86	06.89 06.89 06.89	24.3219-0803.3	020183		Rz 19,05	
	1.3 1.5 1.9 TD		07.86 07.86 07.86	06.89 06.89 06.89	03.0137-0015.2 03.0137-9021.2	650015 669021		185 x 31 AUT Bremsbacken-Zubehör	FI FI
	1.3 1.5 1.9 TD		07.86 07.86 07.86	06.89 06.89 06.89	24.0218-5001.1	480012		185/186,8 x 37	
	1.3 1.5 1.9 TD		07.86 07.86 07.86	06.89 06.89 06.89	03.0420-0319.3	680319		19,05/185x31 Kit	FI
LANCIA THEMA (84-88)									
	2.9 i.e. 8.32		09.87	01.89	13.0460-2980.2	602980		21147 19,0 +/WK/S	TRW
	2.0 i.e. 2.0 i.e. Turbo 2.5 TD 2.8 i.e. V6		10.84 10.84 10.84 10.84	01.89 01.89 01.89 01.89	24.0120-0129.1	420129		257 20,0 18,2 V	
	2.0 i.e. 2.0 i.e. Turbo 2.8 i.e. V6		10.84 10.84 10.84	01.89 01.89 01.89	24.0122-0145.1	422145		284 22,0 20,2 V +B	
									

1) + ABS/ - armoured vehicles / + ABS/ - veicoli blindati / + ABS/ - véhicules blindé / + ABS/ - vehiculo blindado

2) - armoured vehicles / - veicoli blindati / - véhicules blindé / - vehiculo blindado

3) + armoured vehicles / + veicoli blindati / + véhicules blindé / + vehiculo blindado

										
LANCIA THEMA (84-88)										
	2.9 i.e. 8.32			09.87	01.89		24.0122-0145.1	422145	284 22,0 20,2 V +B	
	2.0 i.e. 2.0 i.e. Turbo 2.5 TD 2.8 i.e. V6 2.9 i.e. 8.32			10.84 10.84 10.84 10.84 09.87	01.89 01.89 01.89 01.89 01.89		13.0460-2962.2 13.0460-0072.2	602962 610072	20668 16,6 /S Belagsatz-Zubehör	TRW TRW
	2.0 i.e. 2.0 i.e. Turbo 2.5 TD 2.8 i.e. V6			10.84 10.84 10.84 10.84	01.89 01.89 01.89 01.89	- gepanzerte Fahrzeuge ¹⁾ - gepanzerte Fahrzeuge ¹⁾ - gepanzerte Fahrzeuge ¹⁾	24.0110-0190.1	410190	252 10,0 9,0 +B	
	2.0 i.e. 2.0 i.e. Turbo 2.8 i.e. V6 2.9 i.e. 8.32			10.84 10.84 10.84 09.87	01.89 01.89 01.89 01.89	+ gepanzerte Fahrzeuge ²⁾ + gepanzerte Fahrzeuge ²⁾ + gepanzerte Fahrzeuge ²⁾	24.0110-0209.1	410209	251 10,0 9,0 +B	
	2.0 i.e. 2.0 i.e. Turbo 2.5 TD 2.8 i.e. V6 2.9 i.e. 8.32			10.84 10.84 10.84 10.84 09.87	01.89 01.89 01.89 01.89 01.89	- langer Radstand ³⁾	24.3727-0514.2	580514	1 	L=2950
LANCIA THEMA (89-92)										
	2.0 i.e. 2.0 i.e. 16V 2.0 i.e. Turbo 2.5 TD 2.8 i.e. V6			02.89 10.89 02.89 02.89 02.89	09.92 09.92 09.92 09.92 09.92	- gepanzerte Fahrzeuge ¹⁾ - gepanzerte Fahrzeuge ¹⁾ - gepanzerte Fahrzeuge ¹⁾ - gepanzerte Fahrzeuge ¹⁾	13.0460-2952.2	602952	21185 19,4 +/WK/S	TRW
	2.0 i.e. 2.0 i.e. 16V 2.0 i.e. 16V Turbo 2.0 i.e. Turbo 2.8 i.e. V6 2.9 i.e. 8.32			02.89 10.89 10.89 02.89 02.89 02.89	09.92 09.92 09.92 09.92 09.92 09.92	+ gepanzerte Fahrzeuge ²⁾ + gepanzerte Fahrzeuge ²⁾ + gepanzerte Fahrzeuge ²⁾ + gepanzerte Fahrzeuge ²⁾	13.0460-2979.2	602979	21147 19,0 +/WK/S	TRW
	2.0 i.e. 2.0 i.e. 2.0 i.e. 16V 2.5 TD 2.8 i.e. V6			02.89 02.89 10.89 02.89 02.89	09.92 09.92 09.92 09.92 09.92	- ABS/ - gepanzerte Fzg. ⁴⁾ + ABS/ - gepanzerte Fzg. ⁵⁾ - gepanzerte Fahrzeuge ¹⁾ - gepanzerte Fahrzeuge ¹⁾	24.0114-0102.1	414102	258 14,0 12,8	
	2.0 i.e. 2.0 i.e. 16V 2.0 i.e. 16V Turbo 2.0 i.e. Turbo 2.8 i.e. V6 2.9 i.e. 8.32			02.89 10.89 10.89 02.89 02.89 02.89	09.92 09.92 09.92 09.92 09.92 09.92	- gepanzerte Fahrzeuge ¹⁾ - gepanzerte Fahrzeuge ¹⁾ - gepanzerte Fahrzeuge ¹⁾ + gepanzerte Fahrzeuge ²⁾ + gepanzerte Fahrzeuge ²⁾ + gepanzerte Fahrzeuge ²⁾	24.0122-0130.1	422130	257 22,0 20,2 V	
	2.0 i.e. 2.0 i.e. 16V Turbo 2.0 i.e. Turbo			10.89 02.89 02.89	09.92 09.92 09.92	- gepanzerte Fahrzeuge ¹⁾ - gepanzerte Fahrzeuge ¹⁾	24.0122-0147.1	422147	284 22,0 20,2 V +B	
	2.0 i.e. 2.0 i.e. 16V 2.0 i.e. 16V Turbo 2.0 i.e. Turbo 2.8 i.e. V6 2.9 i.e. 8.32			02.89 10.89 10.89 02.89 02.89 02.89	09.92 09.92 09.92 09.92 09.92 09.92	+ gepanzerte Fahrzeuge ²⁾ + gepanzerte Fahrzeuge ²⁾ + gepanzerte Fahrzeuge ²⁾ + gepanzerte Fahrzeuge ²⁾	24.0122-0145.1	422145	284 22,0 20,2 V +B	
	2.0 i.e. 2.0 i.e. 16V 2.0 i.e. 16V Turbo 2.0 i.e. Turbo 2.5 TD 2.8 i.e. V6 2.9 i.e. 8.32			02.89 10.89 10.89 02.89 02.89 02.89	09.92 09.92 09.92 09.92 09.92 09.92		13.0460-2962.2 13.0460-0072.2	602962 610072	20668 16,6 /S Belagsatz-Zubehör	TRW TRW
	2.0 i.e. 2.0 i.e. 16V 2.0 i.e. 16V Turbo 2.0 i.e. Turbo 2.5 TD 2.8 i.e. V6			02.89 10.89 10.89 02.89 02.89 02.89	09.92 09.92 09.92 09.92 09.92 09.92	- gepanzerte Fahrzeuge ¹⁾ - gepanzerte Fahrzeuge ¹⁾ - gepanzerte Fahrzeuge ¹⁾ - gepanzerte Fahrzeuge ¹⁾	24.0110-0190.1	410190	252 10,0 9,0 +B	
	2.0 i.e. 2.0 i.e. 16V 2.0 i.e. 16V Turbo 2.0 i.e. Turbo 2.8 i.e. V6 2.9 i.e. 8.32			02.89 10.89 10.89 02.89 02.89 02.89	09.92 09.92 09.92 09.92 09.92 09.92	+ gepanzerte Fahrzeuge ²⁾ + gepanzerte Fahrzeuge ²⁾ + gepanzerte Fahrzeuge ²⁾ + gepanzerte Fahrzeuge ²⁾	24.0110-0209.1	410209	251 10,0 9,0 +B	
	2.0 i.e. 2.0 i.e. 16V 2.0 i.e. 16V Turbo 2.0 i.e. Turbo 2.5 TD 2.8 i.e. V6 2.9 i.e. 8.32			02.89 10.89 10.89 02.89 02.89 02.89	09.92 09.92 09.92 09.92 09.92 09.92		24.3727-0514.2	580514	1 	L=2950
LANCIA THEMA (92-94)										
	2.0 i.e. 2.0 i.e. 16V 2.5 TD			10.92 10.92 10.92	12.94 12.94 12.94	- gepanzerte Fahrzeuge ¹⁾	13.0460-2952.2	602952	21185 19,4 +/WK/S	TRW
	2.0 i.e. 16V 2.0 i.e. 16V Turbo 3.0 i.e. V6			10.92 10.92 10.92	12.94 12.94 12.94	+ gepanzerte Fahrzeuge ²⁾	13.0460-2979.2	602979	21147 19,0 +/WK/S	TRW

¹⁾ - armoured vehicles / - veicoli blindati / - véhicules blindés / - vehículo blindado

²⁾ + armoured vehicles / + veicoli blindati / + véhicules blindés / + vehículo blindado

³⁾ - long wheel base / - passo lungo / - empattement long / - distancia larga entre ejes



















⁴⁾ - ABS/ - armoured vehicles / - ABS/ - veicoli blindati / - ABS/ - véhicules blindés / - ABS/ - vehículo blindado

⁵⁾ + ABS/ - armoured vehicles / + ABS/ - veicoli blindati / + ABS/ - véhicules blindés / + ABS/ - vehículo blindado

LANCIA THEMA (92-94)								
	2.0 i.e.		10.92	12.94		24.0122-0130.1	422130	257 22,0 20,2 V
	2.0 i.e. 16V		10.92	12.94	- gepanzerte Fahrzeuge 1)			
	2.5 TD		10.92	12.94				
	2.0 i.e. 16V Turbo		10.92	12.94	- gepanzerte Fahrzeuge 1)	24.0122-0147.1	422147	284 22,0 20,2 V +B
3.0 i.e. V6		10.92	12.94	- gepanzerte Fahrzeuge 1)				
2.0 i.e. 16V		10.92	12.94	+ gepanzerte Fahrzeuge 2)	24.0122-0145.1	422145	284 22,0 20,2 V +B	
2.0 i.e. 16V Turbo		10.92	12.94	+ gepanzerte Fahrzeuge 2)				
3.0 i.e. V6		10.92	12.94	+ gepanzerte Fahrzeuge 2)				
	2.0 i.e.		10.92	12.94		13.0460-2962.2	602962	20668 16,6 /S TRW
	2.0 i.e. 16V		10.92	12.94		13.0460-0072.2	610072	Belagsatz-Zubehör TRW
	2.0 i.e. 16V Turbo		10.92	12.94				
	2.5 TD		10.92	12.94				
	3.0 i.e. V6		10.92	12.94				
	2.0 i.e.		10.92	12.94		24.0110-0190.1	410190	252 10,0 9,0 +B
	2.0 i.e. 16V		10.92	12.94	- gepanzerte Fahrzeuge 1)			
	2.0 i.e. 16V Turbo		10.92	12.94	- gepanzerte Fahrzeuge 1)			
	2.5 TD		10.92	12.94				
	3.0 i.e. V6		10.92	12.94	- gepanzerte Fahrzeuge 1)			
	2.0 i.e. 16V		10.92	12.94	+ gepanzerte Fahrzeuge 2)	24.0110-0209.1	410209	251 10,0 9,0 +B
2.0 i.e. 16V Turbo		10.92	12.94	+ gepanzerte Fahrzeuge 2)				
3.0 i.e. V6		10.92	12.94	+ gepanzerte Fahrzeuge 2)				
	2.0 i.e.		10.92	12.94		24.3727-0545.2	580545	1 ↘ L=2945
	2.0 i.e. 16V		10.92	12.94				
	2.0 i.e. 16V Turbo		10.92	12.94				
	2.5 TD		10.92	12.94				
	3.0 i.e. V6		10.92	12.94				
LANCIA Y 10 (85-95)								
	1.0 Fire		06.85	02.92		24.2120-0801.3	010362	THz 20,64
	1.0 Fire 4WD		06.85	02.92				
	1.0 Turbo		06.85	02.89				
	1.1 4WD		12.86	12.92				
	1.1 Fire		01.90	12.92				
	1.3 Fire		02.89	12.92				
	1.1 4WD		01.93	12.95		24.2120-1733.3	010686	THz 20,64
1.1 Fire		01.93	12.95					
1.3 Fire		01.93	12.95					
	1.0 Fire		06.85	12.95		13.0460-3940.2	603940	20775 18,0 /WK BDX
	1.0 Fire 4WD		12.86	12.95		13.0460-0410.2	610410	Belagsatz-Zubehör BDX
	1.1 4WD		01.90	12.95				
	1.1 Fire		01.90	12.95				
	1.0 Turbo		06.85	12.95		13.0460-2941.2	602941	20839 17,0 /WK/S TRW
1.3 Fire		02.89	12.95					
	1.0 Fire		06.85	12.95		24.0111-0130.1	411130	227 10,8 9,0 +B
	1.0 Fire 4WD		12.86	12.95				
	1.1 4WD		01.90	12.95				
	1.1 Fire		01.90	12.95				
	1.0 Turbo		06.85	12.95		24.0112-0122.1	412122	240 12,0 10,8
1.3 Fire		02.89	12.95					
	1.0 Fire		06.85	12.95		24.3219-0803.3	020183	Rz 19,05
	1.0 Fire 4WD		12.86	12.95				
	1.0 Turbo		06.85	12.95				
	1.1 4WD		01.90	12.95				
	1.1 Fire		01.90	12.95				
	1.3 Fire		02.89	12.95				
	1.0 Fire		06.85	12.95		03.0137-0015.2	650015	185 x 31 AUT FI
	1.0 Fire 4WD		12.86	12.95		03.0137-0273.2	650273	185 x 31 AUT AP
	1.0 Turbo		06.85	12.95		03.0137-9021.2	669021	Bremsbacken-Zubehör FI
	1.1 4WD		01.90	12.95				
	1.1 Fire		01.90	12.95				
	1.3 Fire		02.89	12.95				
	1.0 Fire		06.85	12.95		24.0218-5001.1	480012	185/186,8 x 37
1.0 Fire 4WD		12.86	12.95					
1.0 Turbo		06.85	12.95					
1.1 4WD		01.90	12.95					
1.1 Fire		01.90	12.95					
1.3 Fire		02.89	12.95					
	1.0 Fire		06.85	12.95		03.0420-0319.3	680319	19,05/185x31 Kit FI
	1.0 Fire 4WD		12.86	12.95		03.0520-4319.3	694319	19,05/185x31 TopKit AP
	1.0 Turbo		06.85	12.95				
	1.1 4WD		01.90	12.95				
	1.1 Fire		01.90	12.95				
1.3 Fire		02.89	12.95					
	1.0 Fire		06.85	12.92		24.3727-0519.2	580519	1 ↘ L=2385
	1.0 Turbo		06.85	12.92				
	1.1 Fire		01.90	12.92				
	1.3 Fire		02.89	12.92				
	1.0 Fire 4WD		12.86	12.95		24.3727-0503.2	580503	1 ↘ L=2670
	1.1 4WD		01.90	12.95				
	1.0 Fire		06.85	12.95		24.6513-0801.3	320117	BRL 1/3 (2)
	1.0 Fire 4WD		12.86	12.95				
1.0 Turbo		06.85	12.95					
1.1 4WD		01.90	12.95					
1.1 Fire		01.90	12.95					

1) - armoured vehicles / - veicoli blindati / - véhicule blindé / - vehículo blindado

2) + armoured vehicles / + veicoli blindati / + véhicule blindé / + vehículo blindado

									
LANCIA Y 10 (85-95)									
	1.3 Fire			02.89	12.95		24.6513-0801.3	320117	BRL 1/3 (2)
LAND ROVER 90/110 (83-90)									
	2.5 4x4	62		09.85	07.90		13.0460-6925.2	606925	21519 17,8 /Zub AP
	2.5 TD 4x4	63		09.86	09.90				
	3.5 4x4	100		09.83	07.90				
	2.5 4x4	62		09.85	07.90		24.0114-0108.1	414108	299 14,0 13,0 +B
	2.5 TD 4x4	63		09.86	09.90				
	3.5 4x4	100		09.83	07.90				
LAND ROVER DEFENDER (LD) (90-)									
	2.5 D 4x4	51		09.90	09.01		13.0460-6922.2	606922	21459 17,5 /Zub AP
	2.5 TD5	90	(V)HA701009	06.98		+ Radstand 2286 mm ¹⁾	13.0460-0154.2	610154	Belagsatz-Zubehör AP
	2.5 TDI	83	(V)HA701009	09.90		+ Radstand 2286 mm ¹⁾			
	3.9 V8	136	(V)HA701009	11.98		+ Radstand 2286 mm ¹⁾			
	2.4 Td4	90		05.07			13.0460-6925.2	606925	21519 17,8 /Zub AP
	2.5 TD5	90	(V)HA701010						
	2.5 TDI	83	(V)HA701010						
	3.9 V8	136	(V)HA701010						
	2.4 Td4	90		05.07			24.0114-0108.1	414108	299 14,0 13,0 +B
	2.5 TD5	90		06.98					
	2.5 TDI	83		09.90					
	3.9 V8	136		11.98					
	2.4 Td4	90	(V)LA930456				24.0124-0143.1	424143	299 24,0 22,0 V +B
	2.5 D 4x4	51		09.90					
	2.5 TD5	90	(V)LA930456						
	2.5 TDI	83	(V)LA930456						
	3.9 V8	136	(V)LA930456						
	2.4 Td4	90	(V)1A614447	05.07		+ Radstand 2794 mm ²⁾	13.0460-6923.2	606923	23471 14,5 + AP
	2.4 Td4	90	(V)1A614447	05.07		+ Radstand 3302 mm ³⁾			
	2.5 TD5	90	(V)1A614447	06.98		+ Radstand 2794 mm ²⁾			
	2.5 TD5	90	(V)1A614447	06.98		+ Radstand 3302 mm ³⁾			
	2.5 TDI	83	(V)1A614447	09.90		+ Radstand 2794 mm ²⁾			
	2.5 TDI	83	(V)1A614447	09.90		+ Radstand 3302 mm ³⁾			
	3.9 V8	136	(V)1A614447	11.98		+ Radstand 2794 mm ²⁾			
	3.9 V8	136	(V)1A614447	11.98		+ Radstand 3302 mm ³⁾			
	2.4 Td4	90	(V)1A614448			+ Radstand 2794 mm ²⁾	13.0460-6924.2	606924	23471 17,5 +/Zub AP
	2.4 Td4	90	(V)1A614448			+ Radstand 3302 mm ³⁾			
	2.5 TD5	90	(V)1A614448			+ Radstand 2794 mm ²⁾			
	2.5 TD5	90	(V)1A614448			+ Radstand 3302 mm ³⁾			
	2.5 TDI	83	(V)1A614448			+ Radstand 2794 mm ²⁾			
	2.5 TDI	83	(V)1A614448			+ Radstand 3302 mm ³⁾			
	3.9 V8	136	(V)1A614448			+ Radstand 2794 mm ²⁾			
	3.9 V8	136	(V)1A614448			+ Radstand 3302 mm ³⁾			
	2.4 Td4	90		05.07		+ Radstand 2286 mm ¹⁾	24.0113-0189.1	413189	290 12,5 11,7 +B
	2.5 D 4x4	51		09.90	09.01				
	2.5 TD5	90		06.98		+ Radstand 2286 mm ¹⁾			
	2.5 TDI	83		09.90		+ Radstand 2286 mm ¹⁾			
	3.9 V8	136		11.98		+ Radstand 2286 mm ¹⁾			
	2.4 Td4	90	(V)WA159806	05.07		- ABS/ + Radstand 2794 mm ⁴⁾	24.0114-0108.1	414108	299 14,0 13,0 +B
	2.4 Td4	90	(V)WA159806	05.07		- ABS/ + Radstand 3302 mm ⁵⁾			
	2.5 TD5	90	(V)WA159806	06.98		- ABS/ + Radstand 2794 mm ⁴⁾			
	2.5 TD5	90	(V)WA159806	06.98		- ABS/ + Radstand 3302 mm ⁵⁾			
	2.5 TDI	83	(V)WA159806	09.90		- ABS/ + Radstand 2794 mm ⁴⁾			
	2.5 TDI	83	(V)WA159806	09.90		- ABS/ + Radstand 3302 mm ⁵⁾			
	3.9 V8	136	(V)WA159806	11.98		- ABS/ + Radstand 2794 mm ⁴⁾			
	3.9 V8	136	(V)WA159806	11.98		- ABS/ + Radstand 3302 mm ⁵⁾			
	2.4 Td4	90	(V)XA159807			+ Radstand 2794 mm ²⁾	24.0114-0115.1	414115	298 14,0 13,0
	2.4 Td4	90	(V)XA159807			+ Radstand 3302 mm ³⁾			
	2.5 TD5	90	(V)XA159807			+ Radstand 2794 mm ²⁾			
	2.5 TD5	90	(V)XA159807			+ Radstand 3302 mm ³⁾			
	2.5 TDI	83	(V)XA159807			+ Radstand 2794 mm ²⁾			
	2.5 TDI	83	(V)XA159807			+ Radstand 3302 mm ³⁾			
	3.9 V8	136	(V)XA159807			+ Radstand 2794 mm ²⁾			
	3.9 V8	136	(V)XA159807			+ Radstand 3302 mm ³⁾			
LAND ROVER RANGE ROVER I (70-94)									
	2.4 D	78		04.86	12.90		24.2125-1710.3	010559	Thz 25,40
	3.5 VOGUE	93		10.85	09.90				
	3.9 KAT	127		11.88	07.94				
	4.3 VOGUE LSE	149		09.92	07.94				
	2.4 D	78	(V)FA399972	04.86			13.0460-6926.2	606926	21160 19,2 +WK/Zub AP
	3.5	107	(V)FA399972	01.87					
	3.5 VOGUE	120	(V)FA399972	10.85					
	3.9 KAT	127	(V)FA399972	11.88					
	3.9 VOGUE	134	(V)FA399972	11.88					
	2.4 D	78	(V)GA399973		12.90		13.0460-6916.2	606916	21459 18,5 +WK AP
	3.5	107	(V)GA399973		09.90		13.0460-0154.2	610154	Belagsatz-Zubehör AP
	3.5 VOGUE	120	(V)GA399973		09.90				
	3.9 KAT	127	(V)GA399973		07.94				
	3.9 VOGUE	134	(V)GA399973		07.94				
	4.3 VOGUE LSE	149		09.92	07.94				

¹⁾ + wheel base 2286 mm / + passo 2286 mm / + empattement 2286 mm / + distancia entre ejes 2286 mm
²⁾ + wheel base 2794 mm / + passo 2794 mm / + empattement 2794 mm / + distancia entre ejes 2794 mm
³⁾ + wheel base 3302 mm / + passo 3302 mm / + empattement 3302 mm / + distancia entre ejes 3302 mm
⁴⁾ - ABS/ + wheel base 2794 mm / - ABS/ + passo 2794 mm / - ABS/ + empattement 2794 mm / - ABS/ + dist.rueda 2794 mm
⁵⁾ - ABS/ + wheel base 3302 mm / - ABS/ + passo 3302 mm / - ABS/ + empattement 3302 mm / - ABS/ + dist.rueda 3302 mm



LAND ROVER RANGE ROVER I (70-94)

	2.4 D	78	(V)FA399972	04.86		24.0114-0108.1	414108		299 14,0 13,0 +B
	3.5	107	(V)FA399972	07.87					
	3.5 VOGUE	120	(V)FA399972	10.85					
	3.9 KAT	127	(V)FA399972	11.88					
	3.9 VOGUE	134	(V)FA399972	11.88					
	2.4 D	78	(V)GA399973	12.90		24.0124-0143.1	424143		299 24,0 22,0 V +B
	3.5	107	(V)GA399973	09.90					
	3.5 VOGUE	120	(V)GA399973	09.90					
	3.9 KAT	127	(V)GA399973	07.94					
	3.9 VOGUE	134	(V)GA399973	07.94					
4.3 VOGUE LSE	149		09.92	07.94					
	2.4 D	78		04.86	12.90	13.0460-6917.2	606917		21237 15,5 +WK/Zub Belagsatz-Zubehör
	3.5	107		07.87	09.90	13.0460-0414.2	610414		
	3.5 VOGUE	120		10.85	09.90				
	3.9 KAT	127		11.88	07.94				
	3.9 VOGUE	134		11.88	07.94				
4.3 VOGUE LSE	149		09.92	07.94					
	2.4 D	78		04.86	12.90	24.0113-0189.1	413189		290 12,5 11,7 +B
	3.5	107		07.87	09.90				
	3.5 VOGUE	120		10.85	09.90				
	3.9 KAT	127		11.88	07.94				
	3.9 VOGUE	134		11.88	07.94				
4.3 VOGUE LSE	149		09.92	07.94					

LEXUS S 300 (93-97)

	300 (JZS147)	156		03.93	08.97	03.0137-0400.2	650400		190 x 45 Bremsbacken-Zubehör
						03.0137-9272.2	669272		

LLOYD (55-61)

	LP 250			01.56	12.58	83.7704-0290.3	330826		L=290
	LP/LC/LS 400			01.55	12.58				
	LP/LC/LS 600			01.55	12.58				
	LS 600 - Alexander			01.56	12.61				
	LP 250			01.56	12.58	03.3215-0221.3	020013		Rz 15,87
	LP/LC/LS 400			01.55	12.58				
	LP/LC/LS 600			01.55	12.58				
	LS 600 - Alexander			01.56	12.61				

MAGIRUS BUS SATURN

	Saturn II			01.58	12.64	24.3526-0110.3	340018	1	Bremslichtschalter
	Saturn II			01.58	12.64	83.6103-0500.3	330230		L=500

MAGIRUS BUS 100

	100 R 170					83.6103-0500.3	330230		L=500
	100 R 170					83.6103-0550.3	330231		L=550





















MAGIRUS BUS 110

	110 E 6					83.6103-0550.3	330231		L=550
	110 E 6					83.6103-0500.3	330230		L=500
	110 E 6					83.6103-0550.3	330231		L=550

MAGIRUS BUS 120

	120 R 80			01.69	12.77	03.3138-2001.3	010310		Hz 38,10	ATE
						03.0370-1038.2	051038		Hz Reparatursatz	
						03.0370-9998.2	059998		Hz Rep. Satz, -Kolben	
	120 R 80			01.69	12.77	83.6103-0300.3	330223		L=300	
						83.6103-0450.3	330228		L=450	
	120 R 80			01.69	12.77	83.6103-0650.3	330235		L=650	
	120 L 80			01.68	12.69	83.6103-0300.3	330223		L=300	
	120 R 80			01.69	12.77					





































								
MAGIRUS BUS 130								
	130 L/R 81 130 R 81 F		01.77 01.77	12.82 12.82	83.6103-0300.3 83.6103-0550.3	330223 330231	■	L=300 L=550
MAGIRUS BUS 150								
	150 L/R 10 150 L/R 12		01.64 01.64	12.69 12.67	24.3526-0110.3	340018	1	Bremslichtschalter
	150 LS 12 150 S 11		01.64 01.64	12.67 12.68	03.0370-1131.2	051131		+ Vorder- u. Hinterachse ¹⁾ Hz Reparatursatz
	150 KVB S 11		01.67	12.68	03.3134-0300.3	010308	2	Hz 34,92 ATE
	150 KVB S11 150 L/R 10 150 L/R 12 150 LS 12 150 S 11		01.67 01.64 01.64 01.64 01.64	12.68 12.69 12.67 12.67 12.68	83.6103-0500.3	330230		L=500
MAGIRUS BUS 160-180								
	170 E 100 170 DSH/SH 110 170 L/R 120 170 S 11 H 180 SH 110		01.71 01.69 01.68 01.74	12.76 12.74 12.71 12.76	03.3134-0300.3	010308	2	Hz 34,92 ATE
	160 R 81 170 E 100 170 DSH/SH/EV 110 170 E 100 170 L/R 120 170 L/R/TL/TR 100 170 S 11 H 180 SH 110		01.77 01.77 01.71 01.70 01.69 01.68 01.74	12.82 12.82 + 2x Hz 31,75 ²⁾ 12.76 12.74 12.78 12.71 12.76	83.6103-0300.3 83.6103-0550.3 83.6103-0500.3	330223 330231 330230	■	L=300 L=550 L=500 + Hz 34,92/38,10 ³⁾
	170 E 100 170 L/R 120 170 L/R/TL/TR 100		01.69 01.69	12.74 12.78	83.6103-0550.3	330231		L=550
MAGIRUS BUS 200								
	200 L/TL 120 200 R/TR 120 200 SH 110		01.70 01.70 01.73	12.74 12.76 12.77	03.3134-0300.3	010308	2	Hz 34,92 ATE
	200 L/R/TL/TR 100 200 L/R/TL/TR 120 200 SH 110		01.69 01.70 01.73	12.77 12.76 12.77	83.6103-0500.3	330230		L=500
	200 L/R/TL/TR 100 200 L/R/TL/TR 120		01.69 01.70	12.77 12.76	83.6103-0550.3	330231		L=550
MAGIRUS BUS 230								
	230 E 100 230 L 120 230 L/T/TR 117 230 R/TL/TR 120 230 SH 110		01.69 01.73 01.69	12.74 12.82 12.78	03.3134-0300.3 03.3134-0300.3	010308 010308	2 2	Hz 34,92 ATE Hz 34,92 ATE
	230 R 120		01.69	12.78	83.6103-0650.3	330235		L=650
	230 E 110 230 L 120 230 L/R/T 100 230 R/TL/TR 120 230 SH 110 230 TL/TR 100		01.69 01.69	12.74 12.78	83.6103-0500.3	330230		L=500
	230 E 110 230 E 120 230 E/L/R/T 100 230 L/TL/TR 120 230 TL/TR 100 230 R 120 230 R 120		01.69 01.69	12.78 12.72 12.78	83.6103-0550.3 83.6103-0550.3 83.6103-0550.3	330231 330231 330231		L=550 L=550 L=550
MAGIRUS BUS 232/260								
	232 TR 100		01.70	12.78	83.6103-0500.3	330230		L=500
MAGIRUS LKW JUPITER								
	Jupiter 6x6		01.63	12.64	03.3138-2001.3	010310		Hz 38,10 ATE
	Jupiter 6x6		01.63	12.64	83.6103-0300.3	330223		L=300
	Jupiter 6x6		01.63	12.64	83.6103-0650.3 83.6103-0400.3	330235 330226	■	L=650 L=400

¹⁾ + front axle and rear axle / + asse anteriore + posteriore / + ess. avant et ess. arrière / + eje delantero + eje trasero

²⁾ + 2x MC 31,75 / + 2x PF 31,75 / + 2x MC 31,75 / + 2x CM 31,75

³⁾ + MC 34,92/38,10 / + PF 34,92/38,10 / + MC 34,92/38,10 / + CM 34,92/38,10

									
MAGIRUS LKW MERCUR									
	Mercur 126 Mercur F 150 A		01.63 01.62	12.64 12.64		03.0370-1131.2	051131	Hz Reparatursatz	
	Mercur F 126 Mercur F 150 A		01.63 01.62	12.64 12.64		83.6103-0550.3	330231	L=550	
	Mercur F 126 Mercur F 150 A		01.63 01.62	12.64 12.64		83.6103-0500.3	330230	L=500	
	Mercur F 150 A		01.62	12.64		03.2515-1101.3 03.0450-1502.2	040001 081502	Nz 15,87 Nz Reparatursatz	
MAGIRUS LKW SATURN/PLUTO									
	Saturn 150 Saturn A/AK Saturn S Saturn II		01.60 01.58 01.59 01.58	12.64 12.64 12.64 12.64		24.3526-0110.3	340018	1 Bremslichtschalter	
	Saturn 150 Saturn A/AK Saturn S		01.60 01.58 01.59	12.64 12.64 12.64		83.6103-0550.3	330231	L=550	
	Pluto 200 Saturn 200		01.60 01.60	12.64 12.64		83.6103-0650.3	330235	L=650	
	Saturn 150 Saturn A/AK Saturn S		01.60 01.58 01.59	12.64 12.64 12.64		83.6103-0550.3	330231	L=550	
	Pluto 200 Saturn 200		01.60 01.60	12.64 12.64		83.6103-0650.3	330235	L=650	
	Saturn II		01.60	12.64		83.6103-0500.3	330230	L=500	
	Saturn S		01.59	12.63		03.2515-1101.3 03.0450-1502.2	040001 081502	Nz 15,87 Nz Reparatursatz	
MAGIRUS LKW SIRIUS									
	Sirius A Sirius S		01.59 01.59	12.63 12.63		24.3526-0110.3	340018	1 Bremslichtschalter	
	Sirius S		01.59	12.63		83.6103-0500.3	330230	L=500	
	Sirius A		01.59	12.63		83.6103-0500.3	330230	L=500	
MAGIRUS LKW 100									
	100 D7 FA/FK/FL/FS 100 D8 FA/FK/FL/FS 100 D9 FA/FL		01.66 01.66 01.67	12.68 12.68 12.68		24.3526-0110.3	340018	1 Bremslichtschalter	
	100 D 7 FK/FL 100 D 8 FK/FL 100 D 9 FL		01.66 01.66 01.67	12.68 12.68 12.68		83.6103-0300.3	330223	L=300	
	100 D 7 FS 100 D 8 FS		01.67 01.67	12.68 12.68		83.6103-0400.3	330226	L=400	
	100 D 7 FA 100 D 8 FA 100 D 9 FA		01.66 01.66 01.67	12.68 12.68 12.68		83.6103-0550.3	330231	L=550	
	100 D 6 FAL 100 D 7 FK/FL/FS 100 D 8 FK/FL/FS 100 D 9 FL		01.66 01.66 01.67	12.68 12.68 12.68		83.6103-0450.3 83.6103-0550.3 83.6103-0500.3	330228 330231 330230	L=450 L=550 L=500	
	100 D 7 FA 100 D 8 FA 100 D 9 FA		01.66 01.66 01.67	12.68 12.68 12.68		83.6103-0500.3	330230	L=500	
	100 M 6 FAL					24.2423-0905.3	030070	Gz 23,81	
	100 M 6 FAL					24.2538-0901.3	040056	Nz 38,10	
MAGIRUS LKW 110									
	110 D 7 FL 110 D 9 FL 110 D 11 F		01.68 01.68 01.68	12.71 12.71 12.71		03.3134-0300.3	010308	separater Behälter ¹⁾ Hz 34,92	ATE
	110 D 7 FA 110 D 7 FK/FL 110 D 7 FL		01.68 01.68 01.68	12.71 12.71 + Hz 38,10 ²⁾ 12.71 + Hz 34,92 ³⁾		24.3526-0110.3 83.6103-0650.3 83.6103-0300.3	340018 330231 330223	1 Bremslichtschalter L=550 L=650 L=300	
	110 D 7 FS 110 D 8 FK/FL 110 D 9 FL		01.68 01.69 01.68	12.71 12.71 12.71		83.6103-0600.3 83.6103-0650.3	330233 330235	L=600 L=650	
	110 D 11 F		01.68	12.71		83.6103-0550.3	330231	L=550	

¹⁾ separate reservoir / serbatoio separato / réservoir séparé / depósito independiente

²⁾ + MC 38,10 / + PF 38,10 / + MC 38,10 / + CM 38,10

³⁾ + MC 34,92 / + PF 34,92 / + MC 34,92 / + CM 34,92

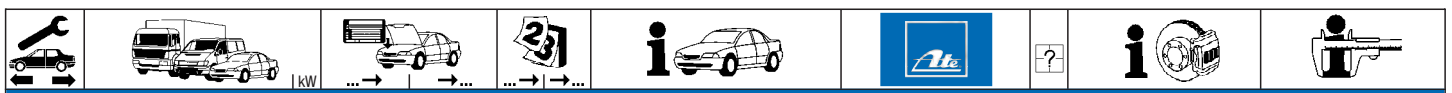

MAGIRUS LKW 110

	110 D 7 FA/FK/FL		01.68	12.71	83.6103-0500.3	330230		L=500
	110 D 7 FL		01.68	12.71 + Hz 34,92 ¹⁾	83.6103-0550.3	330231		L=550
	110 D 7 FS		01.68	12.71	83.6103-0500.3	330230		L=500
	110 D 8 FK/FL		01.69	12.71				
	110 D 9 FL		01.68	12.71	83.6103-0550.3	330231		L=550
	110 D 11 F		01.68	12.71	83.6103-0650.3	330235		L=650
	110 D 9 FL		01.68	12.71	83.6103-0550.3	330231		L=550

MAGIRUS LKW 120

	120 D 9 FG/FGB		01.74	12.75	03.0370-1131.2	051131		Hz Reparatursatz
	120 D 11 FL		01.69	12.73 + 1-Kreis-Bremse ²⁾	03.3134-0300.3	010308		Hz 34,92 ATE
	120 D 9 FL		01.72	12.73				
	120 D 11 FL		01.69	12.73 + 2-Kreis-Bremse ³⁾	03.0370-1131.2	051131		Hz Reparatursatz
	120 D 12 AK/K		01.69	12.74 + 1-Kreis-Bremse ²⁾	03.0370-1131.2	051131		Hz Reparatursatz
	120 D 13 L		01.69	12.74				
	120 D 13 FL		01.69	12.73	03.0370-1131.2	051131		Hz Reparatursatz
	120 D 7 FA		01.71	12.75 + 1-Kreis-Bremse ²⁾	83.6103-0620.3	330234		L=620
	120 D 7 FA		01.71	12.75 + 2-Kreis-Bremse ³⁾	83.6103-0650.3	330235		L=650
	120 D 7 FGB		01.74	12.75				
	120 D 7 FK/FL/FS		01.71	12.75				
	120 D 8 FK/FL							
	120 D 9 FG/FGB		01.74	12.75	83.6103-0600.3	330233		L=600
	120 D 11 FL		01.69	12.73	83.6103-0650.3	330235		L=650
	120 D 9 FL		01.72	12.73				
	120 D 12 AK/K		01.69	12.74 + HA-Rz 38,10 ⁴⁾	83.6103-0550.3	330231		L=550
	120 D 12 AK/K		01.69	12.74 + HA-Rz 34,92 ⁵⁾	83.6103-0650.3	330235		L=650
	120 D 13 FL		01.69	12.73				
	120 D 13 L		01.69	12.74				
	120 D 7 FA		01.71	12.75	83.6103-0500.3	330230		L=500
	120 D 7 FGB		01.74	12.75				
	120 D 7 FK/FL/FS		01.71	12.75				
	120 D 8 FK/FL							
	120 D 9 FG/FGB		01.74	12.75	83.6103-0300.3	330223		L=300
					83.6103-0600.3	330233		L=600
	120 D 11 FL		01.69	12.73	83.6103-0550.3	330231		L=550
	120 D 12 AK/K		01.69	12.74				
	120 D 13 FL		01.69	12.73				
	120 D 13 L		01.69	12.74				
	120 D 9 FL		01.72	12.73				
	120 D 11 FL		01.69	12.73	83.6103-0550.3	330231		L=550
	120 D 12 AK/K		01.69	12.72				
	120 D 13 FL		01.69	12.73				
	120 D 13 L		01.69	12.72				
	120 D 9 FL		01.72	12.73				

MAGIRUS LKW 126

	126 D 11 A/AK/L		01.64	12.67	03.0370-1131.2	051131		Hz Reparatursatz
	126 D 11 FL/FS		01.64	12.67				
	126 D 12 L		01.65	12.67				
	126 D 11 A/AK/L		01.64	12.67	83.6103-0550.3	330231		L=550
	126 D 11 FL/FS		01.64	12.67	83.6103-0500.3	330230		L=500
	126 D 13 F		01.66	12.67	83.6103-0400.3	330226		L=400
	126 D 14 F		01.66	12.67				
	126 D 11 A/AK/L		01.64	12.67	83.6103-0550.3	330231		L=550
	126 D 11 FL/FS		01.64	12.67	83.6103-0300.3	330223		L=300
	126 D 13 F		01.66	12.67	83.6103-0550.3	330231		L=550
	126 D 14 F		01.66	12.67	83.6103-0500.3	330230	■	L=500

MAGIRUS LKW 130

	130 D 7 FA/FAL		01.72	12.74	03.0370-1131.2	051131		Hz Reparatursatz
	130 D 8 FA		01.72	12.74				
	130 D 9 AL		01.72	12.74	03.3134-0300.3	010308	2	Hz 34,92 ATE
					03.0370-1131.2	051131	+ Hz 31,75 ⁶⁾	Hz Reparatursatz
	130 D 9 FA		01.72	12.74	03.0370-1131.2	051131		Hz Reparatursatz
	130 D 11 FL		01.73	12.76 + 1-Kreis-Bremse ²⁾	03.3134-0300.3	010308		Hz 34,92 ATE
	130 D 9 FL		01.73	12.76				
	130 D 11 FL		01.73	12.76 + 2-Kreis-Bremse ³⁾	03.0370-1131.2	051131		Hz Reparatursatz
	130 D 12 AK		01.73	12.82 + 1-Kreis-Bremse ²⁾	03.0370-1131.2	051131		Hz Reparatursatz
	130 D 12 K		01.73	12.80 + 1-Kreis-Bremse ²⁾				
	130 D 12 AK		01.73	12.82 + 2-Kreis-Bremse ³⁾	03.3134-0300.3	010308	2	Hz 34,92 ATE
	130 D 12 K		01.73	12.80 + 2-Kreis-Bremse ³⁾				
	130 D 13 AK/F		01.72	12.82	03.3134-0300.3	010308		Hz 34,92 ATE
	130 D 13 L		01.72	12.82 + 1-Kreis-Bremse ²⁾	03.0370-1131.2	051131		Hz Reparatursatz
	130 D 13 LH/LHD		01.72	12.82				
	130 D 13 L		01.72	12.82 + 2-Kreis-Bremse ³⁾	03.0370-1131.2	051131		Hz Reparatursatz
	130 D 14 FL		01.74	12.80				
	130 M 7 FAL		01.75	12.82				
	130 M 8 FAL		01.75	12.82				

¹⁾ + MC 34,92 / + PF 34,92 / + MC 34,92 / + CM 34,92

²⁾ + single circuit brake / + impianto freni circuito singolo / + frein à 1 circuit / + freno de 1 circuito

³⁾ + two circuit brake / + impianto frenante doppio circuito / + frein à deux circuits / + freno de 2 circuitos

⁴⁾ + RA WC 38,10 / + P CR 38,10 / + ess. AR CR 38,10 / + ET CR 38,10

⁵⁾ + RA WC 34,92 / + P CR 34,92 / + ess. AR CR 34,92 / + ET CR 34,92

⁶⁾ + MC 31,75 / + PF 31,75 / + MC 31,75 / + CM 31,75



MAGIRUS LKW 130

	130 M 7 FAL		01.75	12.82	03.3138-2001.3	010310	+ Hinterachse ¹⁾	Hz 38,10	ATE
	130 M 8 FAL		01.75	12.82	03.0370-1131.2	051131	+ Vorderachse ²⁾	Hz Reparatursatz	
					03.0370-1038.2	051038	+ Hinterachse ¹⁾	Hz Reparatursatz	
					03.0370-9998.2	059998	+ Hinterachse ¹⁾	Hz Rep. Satz, -Kolben	
	130 M 8 FK/FL/FS		01.75	12.82	03.3138-2001.3	010310		Hz 38,10	ATE
					03.0370-1038.2	051038		Hz Reparatursatz	
					03.0370-9998.2	059998		Hz Rep. Satz, -Kolben	ATE
	130 M 9 FA		01.72	12.74	03.0370-1131.2	051131		Hz Reparatursatz	
	130 M 13 L		01.72	12.74	03.0370-1131.2	051131		Hz Reparatursatz	
	130 D 7 FA		01.72	12.74	83.6103-0450.3	330228		L=450	
	130 D 8 FA		01.72	12.74	83.6103-0550.3	330231		L=550	
	130 D 8 FK/FL		01.72	12.74	83.6103-0650.3	330235		L=650	
	130 D 9 AL		01.72	12.74	+ Hz 31,75 ³⁾				
	130 D 9 FA		01.72	12.74	83.6103-0550.3	330231		L=550	
	130 D 11 FL		01.73	12.76	83.6103-0650.3	330235		L=650	
	130 D 12 AK/K		01.73	12.82					
	130 D 9 FGB		01.72	12.74					
	130 D 9 FK/FL		01.75	12.76					
	130 D 13 F		01.72	12.82	83.6103-0650.3	330235		L=650	
	130 D 13 L/LH/LHD		01.72	12.82					
	130 D 14 FL		01.74	12.80					
	130 M 8 FK/FL/FS		01.75	12.82					
	130 M 9 FA		01.72	12.74	83.6103-0550.3	330231		L=550	
	130 M 11 FG/FGB		01.76	12.82	83.6103-0650.3	330235		L=650	
	130 M 13 L		01.72	12.74					
	130 M 9 FG/FGB		01.76	12.82					
	130 M 9 FK/FL/FS		01.75	12.82					
	130 D 7 FA		01.72	12.74	83.6103-0620.3	330234		L=620	
	130 D 7 FAL		01.72	12.74	83.6103-0450.3	330228		L=450	
	130 D 8 FA		01.72	12.74	83.6103-0550.3	330231		L=550	
	130 D 8 FK/FL		01.72	12.74	83.6103-0620.3	330234	■	L=620	
	130 D 9 AL/FA		01.72	12.74	83.6103-0550.3	330231		L=550	
	130 D 9 FK/FL		01.75	12.76	+ HA-Rz 44,45 ⁴⁾	83.6103-0620.3	330234	■	L=620
	130 D 11 FL		01.73	12.76	83.6103-0550.3	330231		L=550	
	130 D 12 AK/K		01.73	12.82					
	130 D 9 FL		01.75	12.76	+ HA-Rz 28,57/31,75 ⁵⁾				
	130 D 13 L/LH/LHD		01.72	12.82	83.6103-0550.3	330231		L=550	
	130 D 14 FL		01.74	12.80					
	130 M 7 FAL		01.75	12.82	83.6103-0450.3	330228		L=450	
	130 M 8 FAL		01.75	12.82					
	130 M 8 FK/FL/FS		01.75	12.82	83.6103-0620.3	330234		L=620	
	130 M 9 FA		01.72	12.82	83.6103-0550.3	330231		L=550	
	130 M 9 FK/FL/FS		01.75	12.82	83.6103-0620.3	330234	■	L=620	
	130 M 11 FK/FL		01.75	12.82	83.6103-0620.3	330234		L=620	
	130 M 13 FK/FL		01.75	12.82					
	130 D 7 FAL		01.72	12.74	24.2423-0905.3	030070		Gz 23,81	
	130 D 8 FK/FL		01.72	12.74					
	130 D 9 FGB		01.72	12.75					
	130 D 9 FK		01.72	12.76					
	130 M 7 FAL		01.75	12.82	24.2423-0905.3	030070		Gz 23,81	
130 M 8 FAL/FL		01.75	12.82						
130 M 8 FK/FS		01.75	12.82						
130 M 11 FG/FGB		01.75	12.82	24.2423-0905.3	030070		Gz 23,81		
130 M 11 FK/FL		01.75	12.82						
130 M 13 FK/FL		01.75	12.82						
130 M 9 FG/FGB		01.75	12.82						
130 M 9 FK/FL/FS		01.75	12.82						
	130 D 7 FAL		01.72	12.74	24.2538-0901.3	040056		Nz 38,10	
	130 D 8 FK/FL		01.72	12.74					
	130 D 9 FGB		01.72	12.75					
	130 D 9 FK		01.72	12.76					
	130 M 7 FAL		01.75	12.82	24.2538-0901.3	040056		Nz 38,10	
	130 M 8 FAL/FL		01.75	12.82					
	130 M 8 FK/FS		01.75	12.82					
	130 M 11 FG/FGB		01.75	12.82	24.2538-0901.3	040056		Nz 38,10	
130 M 11 FK/FL		01.75	12.82						
130 M 13 FK/FL		01.75	12.82						
130 M 9 FG/FGB		01.75	12.82						
130 M 9 FK/FL/FS		01.75	12.82						
	130 D 11 FL		01.72	12.72	83.6103-0550.3	330231		L=550	
	130 D 12 AK/K		01.72	12.72					
	130 D 13 AK		01.72	12.72					
	130 D 13 F		01.72	12.82					
	130 D 13 L/LH/LHD		01.72	12.72					
	130 D 14 FL		01.72	12.80					
	130 D 15 AK/K		01.72	12.72					
	130 D 16 FL		01.72	12.80					
	130 D 16 FLL		01.72	12.76					
	130 D 16 L		01.72	12.72					
	130 D 9 AL		01.72	12.72					
	130 D 9 FL		01.73	12.76					

1) + rear axle / + asse posteriore / + essieu arrière / + eje trasero
 2) + front axle / + asse anteriore / + essieu avant / + eje delantero
 3) + MC 31,75 / + PF 31,75 / + MC 31,75 / + CM 31,75
 4) + RA WC 44,45 / + P CR 44,45 / + ess. AR CR 44,45 / + ET CR 44,45
 5) + RA WC 28,57/31,75 / + P CR 28,57/31,75 / + ess. AR CR 28,57/31,75 / + ET CR 28,57/31,75





MAGIRUS LKW 130										
	130 M 13 L			01.72	12.72		83.6103-0550.3	330231		L=550
MAGIRUS LKW 135										
	135 D 12 FBP/L			01.66	12.70		03.0370-1131.2	051131		Hz Reparatursatz
	135 D 14 AK			01.71	12.72		03.3134-0300.3	010308		Hz 34,92 ATE
	135 D 14 F			01.71	12.72		24.3526-0110.3	340018	1	Bremslichtschalter
	135 D 11 FS			01.66	12.70		83.6103-0300.3	330223		L=300
	135 D 12 FBP			01.66	12.70		83.6103-0550.3	330231		L=550
	135 D 12 L			01.66	12.70		83.6103-0550.3	330231		L=550
	135 D 13 AK			01.66	12.70		83.6103-0300.3	330223		L=300
							83.6103-0550.3	330231		L=550
	135 D 14 AK			01.71	12.72		83.6103-0650.3	330235		L=650
	135 D 14 F			01.71	12.72		83.6103-0300.3	330223		L=300
							83.6103-0550.3	330231		L=550
	135 D 11 FS			01.66	12.70		83.6103-0500.3	330230		L=500
	135 D 12 FBP			01.66	12.70					
	135 D 12 L			01.66	12.70		83.6103-0550.3	330231		L=550
	135 D 13 AK			01.66	12.70		83.6103-0500.3	330230		L=500
	135 D 14 F			01.71	12.72					
	135 M 14 FL			01.77	12.82		24.2538-0901.3	040056		Nz 38,10
	135 D 11 FS			01.66	12.70		24.2538-0901.3	040056		Nz 38,10
	135 D 12 FBP			01.66	12.70					
	135 D 13 AK			01.66	12.70					
	135 D 14 AK/F			01.71	12.72					
	135 D 13 AK			01.66	12.70		83.6103-0550.3	330231		L=550
	135 D 14 AK			01.71	12.72		83.6103-0650.3	330235		L=650
MAGIRUS LKW 140/150										
	150 D 10 A						03.0370-1131.2	051131		Hz Reparatursatz
	150 D 11/AK/FA/L									
	150 D 12									
	150 D 14 AK/L			01.65	12.67		24.3526-0110.3	340018	1	Bremslichtschalter
	140 D 11 AL						83.6103-0650.3	330235		L=650
	150 D 10 A						83.6103-0550.3	330231		L=550
	150 D 11/AK/FA/L									
	150 D 12									
	150 D 14 AK/L			01.65	12.67					
	140 D 11 AL						83.6103-0550.3	330231		L=550
	150 D 10 A						83.6103-0550.3	330231		L=550
	150 D 11/AK/FA/L									
	150 D 12									
	150 D 14 AK/L			01.65	12.67					
MAGIRUS LKW 160/168										
	160 D 11 FL			01.72	12.76		03.0370-1131.2	051131		Hz Reparatursatz
	160 D 11 FS			01.72	12.76		03.3138-2001.3	010310		Hz 38,10 ATE
							03.0370-1038.2	051038		Hz Reparatursatz
							03.0370-9998.2	059998		Hz Rep. Satz,-Kolben ATE
	160 D 12 AK			01.72	12.82	+ 1-Kreis-Bremse ¹⁾	03.0370-1131.2	051131		Hz Reparatursatz
	160 D 12 AK			01.72	12.82	+ 2-Kreis-Bremse ²⁾	03.3134-0300.3	010308	2	Hz 34,92 ATE
							03.0370-1131.2	051131	+ Hz 31,75 ³⁾	Hz Reparatursatz
	160 D 12 K			01.72	12.82	+ 1-Kreis-Bremse ¹⁾	03.0370-1131.2	051131		Hz Reparatursatz
	160 D 12 K			01.72	12.80	+ 2-Kreis-Bremse ²⁾	03.3134-0300.3	010308		Hz 34,92 ATE
	160 D 13 L/S						03.0370-1131.2	051131		Hz Reparatursatz
	160 D 15 K			01.72	12.82					
	160 M 13 FL/FS			01.81	12.82		03.3134-0300.3	010308		Hz 34,92 ATE
	168 M 11 FAL 4x4			01.80	12.82					
	168 M 11 FL			01.80	12.82		03.3138-2001.3	010310	2	Hz 38,10 ATE
							03.0370-1038.2	051038		Hz Reparatursatz
							03.0370-9998.2	059998		Hz Rep. Satz,-Kolben ATE
	160 D 11 FL/FS			01.72	12.76		83.6103-0650.3	330235		L=650
	160 D 12 AK/K			01.72	12.82					
	160 D 13 L/S									
	160 D 15 K			01.72	12.82					
	160 M 11 FS			01.75	12.82					
	160 M 13 FGB/FS			01.75	12.82					
	168 M 11 FAL 4x4			01.80	12.82		83.6103-0700.3	330236		L=700
	168 M 11 FL			01.80	12.82		83.6103-0550.3	330231		L=550
							83.6103-0650.3	330235		L=650
	160 D 11 FL/FS			01.72	12.76		83.6103-0550.3	330231		L=550
							83.6103-0620.3	330234		L=620
	160 D 12 AK/K			01.72	12.82		83.6103-0550.3	330231		L=550
	160 D 13 L/S						83.6103-0550.3	330231		L=550
	160 D 15 K			01.72	12.82					
	160 M 8 FAL			01.75	12.82		83.6103-0450.3	330228		L=450

1) + single circuit brake / + impianto freni circuito singolo / + frein à 1 circuit / + freno de 1 circuito
 2) + two circuit brake / + impianto frenante doppio circuito / + frein à deux circuits / + freno de 2 circuitos
 3) + MC 31,75 / + PF 31,75 / + MC 31,75 / + CM 31,75



MAGIRUS LKW 160/168

	160 M 11 FK/FL		01.75	12.82	24.2423-0905.3	030070			Gz 23,81
	160 M 11 FLL/FS		01.75	12.82					
	160 M 13 FGB/FK/FL		01.75	12.82					
	160 M 13 FLL/FS		01.75	12.82					
	160 M 8 FAL/FL		01.75	12.82					
	168 M 11 FAL 4x4		01.80	12.82	24.2423-0905.3	030070			Gz 23,81
	168 M 11 FL		01.80	12.82					
	160 M 11 FK/FL		01.75	12.82	24.2538-0901.3	040056			Nz 38,10
	160 M 11 FLL/FS		01.75	12.82					
	160 M 13 FGB/FK/FL		01.75	12.82					
	160 M 13 FLL/FS		01.75	12.82					
	160 M 8 FAL/FL		01.75	12.82					
	168 M 11 FAL 4x4		01.80	12.82	24.2538-0901.3	040056			Nz 38,10
	168 M 11 FL		01.80	12.82					
	160 D 11 FL		01.72	12.72	83.6103-0550.3	330231			L=550
	160 D 11 FS		01.72	12.73					
	160 D 12 AK/FL/K		01.72	12.72					
	160 D 15 AK/K		01.72	12.72					
	160 D 15 FAK		01.72	12.72					
	160 D 16 FL/FLL		01.74	12.82					
	160 D 16 FLG		01.72	12.72					
	160 D 16 L		01.72	12.72					

MAGIRUS LKW 170

	170 D 10 AK/FA				03.0370-1131.2	051131			Hz Reparatursatz						
	170 D 11 A/FL		01.71	12.80											
	170 D 11 F/FA		01.71	12.80 + 1-Kreis-Bremse ¹⁾											
	170 D 11 FAL/FL		01.71	12.80											
	170 D 12 A/AL		01.69	12.82											
	170 D 12 AK		01.69	12.82 + 1-Kreis-Bremse ¹⁾											
	170 D 12 AK		01.69	12.82 + 2-Kreis-Bremse ²⁾											
	170 D 12 F		01.69	12.82 + 1-Kreis-Bremse ¹⁾											
	170 D 12 K		01.69	12.82											
	170 D 13 FA/FS		01.69	12.73											
	170 D 13 FK/FL		01.69	12.73											
	170 D 14 F/FL		01.73	12.80											
	170 D 14 FS		01.73	12.80											
	170 D 15 AK/FA/FAK		01.69	12.82											
	170 D 15 FK/FL/K		01.69	12.82											
170 D 16 FAK		01.70	12.82												
170 D 17 AK/K															
170 D 17 F/FK/FL															
170 D 19 F/FL															
	170 D 21 AK		01.69	12.72	03.3134-0300.3	010308	2		Hz 34,92						
	170 D 22 FL														
	170 M 14 FS				03.3134-0300.3	010308			Hz 34,92						
	170 D 10 AK/FA														
	170 D 11 A/FL/FAL		01.71	12.80											
	170 D 11 F/FA		01.71	12.80											
	170 D 12 A/AL		01.69	12.82											
	170 D 12 AK/F		01.69	12.82											
	170 D 12 K		01.69	12.82											
	170 D 13 FA/FK		01.69	12.73											
	170 D 13 FL/FS		01.69	12.73											
	170 D 14 F/FL/FS		01.73	12.80											
	170 D 15 AK/FA/FAK		01.69	12.82											
	170 D 15 FK/FL/K		01.69	12.82											
	170 D 16 FAK		01.70	12.82											
	170 D 17 AK/F/FK														
	170 D 17 FL/K														
170 D 19 F/FL															
	170 M 14 FS				83.6103-0650.3	330235			L=650						
	170 D 10 AK/FA														
	170 D 11 A/F/FA		01.71	12.80											
	170 D 11 FL/FAL		01.71	12.80											
	170 D 12 A/AK/AL/F		01.69	12.82											
	170 D 12 K		01.69	12.82											
	170 D 13 FA/FK/FL		01.69	12.73											
	170 D 14 F/FL		01.73	12.80											
	170 D 14 FS		01.73	12.80 + Hz 34,92 ⁴⁾											
	170 D 15 K		01.69	12.82											
	170 D 21 AK		01.69	12.72											
	170 D 22 FL														
		170 D 10 AK									83.6103-0550.3	330231			L=550
		170 D 11 A													
		170 D 11 F/FA		01.71						12.80					

1) + single circuit brake / + impianto freni circuito singolo / + frein à 1 circuit / + freno de 1 circuito
2) + two circuit brake / + impianto frenante doppio circuito / + frein à deux circuits / + freno de 2 circuitos
3) + MC 31,75 / + PF 31,75 / + MC 31,75 / + CM 31,75
4) + MC 34,92 / + PF 34,92 / + MC 34,92 / + CM 34,92





MAGIRUS LKW 170

	170 D 11 FL		01.77	12.80	83.6103-0550.3	330231		L=550	
	170 D 12 A/AL/K		01.69	12.82	83.6103-0650.3	330235		L=650	
	170 D 12 AK		01.69	12.72					
	170 D 12 F		01.69	12.82	83.6103-0550.3	330231		L=550	
	170 D 13 F		01.69	12.73					
	170 D 15 FK		05.73	12.82					
	170 D 15 AK/K		01.69	12.82	83.6103-0550.3	330231		L=550	
	170 D 15 FAK		01.77	12.80	83.6103-0650.3	330235		L=650	
170 D 17 AK/F/K									
170 D 19 AL/K/L									
170 D 19 F		01.77	12.82						+ Gz 19,05 ¹⁾
170 D 24 K/L									

MAGIRUS LKW 180/186

	180 D 15 A/FL		01.65	12.67	03.3138-2001.3	010310		Hz 38,10	ATE
					03.0370-1038.2	051038		Hz Reparatursatz	
	180 D 15 A/FL		01.65	12.67	83.6103-0300.3	330223		L=300	
					83.6103-0450.3	330228		L=450	
	180 D 15 A/FL		01.65	12.67	83.6103-0650.3	330235		L=650	
	186 M 11 FL				24.2423-0905.3	030070		Gz 23,81	
	186 M 11 FL				24.2538-0901.3	040056		Nz 38,10	

MAGIRUS LKW 192-210

	192 D 12 AL		01.70	12.82	03.3134-0300.3	010308		Hz 34,92	ATE
	192 D 14 F				03.0370-1131.2	051131		Hz Reparatursatz	
	200 D 16 A		01.64	12.66					
	209 D 14 FS		01.73	12.76					
	210 D 14 FS		01.73	12.76					
	210 D 16 AK/AL		01.65	12.68	03.3134-0300.3	010308		Hz 34,92	ATE
	192 D 11 F/FA		01.70	12.82	83.6103-0450.3	330228		L=450	
	192 D 14 F				83.6103-0650.3	330235		L=650	
	200 D 16 A		01.64	12.66	83.6103-0400.3	330226		L=400	
					83.6103-0550.3	330231		L=550	
	209 D 14 FS		01.73	12.76	83.6103-0650.3	330235		L=650	
	210 D 14 FS		01.73	12.76	83.6103-0650.3	330235		L=650	
	192 D 11 F/FA		01.70	12.82	83.6103-0550.3	330231		L=550	
	192 D 12 AL		01.70	12.82					
	192 D 14 F								
	192 D 11 AL		01.70	12.72	83.6103-0550.3	330231		L=550	
					83.6103-0650.3	330235		L=650	
	192 D 12 AL		01.70	12.72	83.6103-0550.3	330231		L=550	
	210 D 16 AK/AL		01.65	12.68	83.6103-0550.3	330231		L=550	
					83.6103-0650.3	330235		L=650	

MAGIRUS LKW 230

	230 D 19 K/L				03.0370-1131.2	051131		Hz Reparatursatz	
	230 D 22 FL				03.3134-0300.3	010308		Hz 34,92	ATE
	230 D 22 L				03.0370-1131.2	051131	+ Hz 31,75 ²⁾	Hz Reparatursatz	
	230 D 26 A		01.70	12.72	03.3134-0300.3	010308		Hz 34,92	ATE
	230 D 19 K/L				83.6103-0450.3	330228		L=450	
	230 D 22 B		01.70	12.72	83.6103-0650.3	330235		L=650	
	230 D 22 FSC		01.71	12.72	83.6103-0400.3	330226		L=400	
	230 D 22 L				83.6103-0450.3	330228	+ Hz 31,75 ²⁾	L=450	
	230 D 22 L				83.6103-0650.3	330235	+ Hz 38,10 ³⁾	L=650	
	230 D 22 B		01.70	12.72	83.6103-0650.3	330235		L=650	
	230 D 22 FL								
	230 D 22 FSC		01.71	12.72					
	230 D 22 L						+ Hz 38,10 ³⁾		
	230 D 16 FSC		01.68	12.69	83.6103-0500.3	330230		L=500	
	230 D 19 FS				83.6103-0550.3	330231		L=550	
	230 D 22 FSC								
	230 D 19 L				83.6103-0400.3	330226		L=400	
	230 D 22 L								

MAGIRUS LKW 232

	232 D 11 FAL		01.73	12.80	03.3134-0300.3	010308		Hz 34,92	ATE
	232 D 13 FL		01.73	12.80	03.0370-1131.2	051131		Hz Reparatursatz	
	232 D 14 FL		01.73	12.80					
	232 D 13 FS		01.73	12.80	03.0370-1131.2	051131		Hz Reparatursatz	
	232 D 14 FS		01.73	12.80					
	232 D 15 AK		01.70	12.82	03.3134-0300.3	010308		Hz 34,92	ATE
232 D 15 F/FLL		01.72	12.80						

1) + CC 19,05 / + CC 19,05 / + EE 19,05 / + CTR 19,05
 2) + MC 31,75 / + PF 31,75 / + MC 31,75 / + CM 31,75
 3) + MC 38,10 / + PF 38,10 / + MC 38,10 / + CM 38,10





MAGIRUS LKW 232

	232 D 15 FA/FAK	01.69	12.82	03.3134-0300.3	010308		Hz 34,92	ATE					
	232 D 15 FK/FL/FS	01.70	12.82										
	232 D 16 A/AK/AL	01.69	12.72										
	232 D 16 FAK	01.69	12.82										
	232 D 17 FA/FAK	01.69	12.80										
	232 D 17 FK/FS	01.69	12.80										
	232 D 19 AK/FAK	01.69	12.80 + 1-Kreis-Bremse ¹⁾										
	232 D 19 FAK	01.69	12.80 + 2-Kreis-Bremse ²⁾										
	232 D 19 FS	01.69	12.80										
	232 D 20 AL	01.69	12.80										
	232 D 20 FAL	01.69	12.80						03.3134-0300.3	010308	+ Hz 31,75 ³⁾	Hz 34,92	ATE
									03.0370-1131.2	051131			
	232 D 22 AK	01.69	12.76						03.3134-0300.3	010308		Hz 34,92	ATE
	232 D 22 FAK	01.69	12.77						03.3134-0300.3	010308	2	Hz 34,92	ATE
	232 D 22 FB	01.72	12.76						03.3134-0300.3	010308	2	Hz 34,92	ATE
	232 D 22 FK	01.69	12.77 + 1-Kreis-Bremse ¹⁾						03.3134-0300.3	010308		Hz 34,92	ATE
232 D 22 FK	01.69	12.77 + 2-Kreis-Bremse ²⁾	03.0370-1131.2	051131		Hz 34,92	ATE						
232 D 22 FL/FS	01.69	12.71	03.3134-0300.3	010308		Hz 34,92	ATE						
232 D 22 K	01.72	12.76											
232 D 26 AK/K	01.69	12.78											
	232 D 13 FL/FS	01.73	12.80	83.6103-0650.3	330235		L=650						
	232 D 14 FL/FS	01.73	12.80										
	232 D 15 FK/FL/FS	01.70	12.82										
	232 D 17 FS	01.69	12.80										
	232 D 19 FAK	01.69	12.80 + 2-Kreis-Bremse ²⁾										
	232 D 13 FL/FS	01.73	12.80	83.6103-0550.3	330231		L=550						
	232 D 14 FL/FS	01.73	12.80										
	232 D 15 FK	01.70	12.82										
	232 D 19 FS	01.69	12.80										
	232 D 20 FAL	01.69	12.80										
	232 D 22 AK/FAK/FK	01.69	12.77										
	232 D 22 FB/K	01.72	12.76										
	232 D 22 FL/FS	01.69	12.71										
232 D 26 K	01.69	12.78											
	232 D 15 FL	01.69	12.72	83.6103-0550.3	330231		L=550						
	232 D 16 A/AK/AL/K	01.69	12.72										
	232 D 16 FAK	01.69	12.72										
	232 D 19 AK/FAK/K	01.69	12.72										
	232 D 19 L	01.69	12.72										
	232 D 19 S	01.69	12.72										
	232 D 20 AL	01.70	12.72										
	232 D 22 AK	01.69	12.72										
	232 D 22 FAK/FK	01.69	12.77 + Gz 19,05 ⁶⁾										
	232 D 22 FB	01.72	12.76 + Gz 19,05 ⁶⁾										
	232 D 22 K	01.69	12.72										
	232 D 24 L	01.70	12.72										
	232 D 26 AK	01.73	12.78 + Gz 19,05 ⁶⁾										
	232 D 26 AK/FK	01.69	12.72										
	232 D 26 F/FK	01.73	12.80 + Gz 19,05 ⁶⁾										
	232 D 26 K/L/S	01.69	12.72										
232 D 32 AK/K	01.69	12.72											















MAGIRUS LKW 250/260

	256 D 19 L	01.77	12.82	03.3134-0300.3	010308		Hz 34,92	ATE		
	260 D 16 FAL								03.0370-1131.2	051131
	250 D 22 FL	01.66	12.72	83.6103-0400.3	330226		L=400	ATE		
									83.6103-0650.3	330235
	256 D 19 L	01.77	12.82	83.6103-0650.3	330235		L=650	ATE		
	250 D 22 FL	01.66	12.72							
	260 D 16 FAL			83.6103-0650.3	330235		L=650	ATE		
	250 D 22 FL	01.66	12.72	83.6103-0550.3	330231		L=550	ATE		
									83.6103-0650.3	330235
	256 D 16 FS	01.77	12.80 + Gz 19,05 ⁶⁾						83.6103-0400.3	330226
	256 D 19 L	01.75	12.78						83.6103-0550.3	330231
	256 D 22 FLL	01.77	12.80	83.6103-0550.3	330231		L=550	ATE		

MAGIRUS LKW 270





















	270 D 16 AK	01.72	12.79	03.3134-0300.3	010308		Hz 34,92	ATE
	270 D 22 FL/FLL	01.72	12.82					
	270 D 22 FS/FSL	01.76	12.82					
	270 D 22 FL/FS	01.72	12.82	83.6103-0650.3	330235		L=650	ATE
	270 D 22 FLL/FSL	01.72	12.82					
	270 D 22 FS		12.72	83.6103-0650.3	330235		L=650	ATE

¹⁾ + single circuit brake / + impianto freni circuito singolo / + frein à 1 circuit / + freno de 1 circuito
²⁾ + two circuit brake / + impianto frenante doppio circuito / + frein à deux circuits / + freno de 2 circuitos
³⁾ + MC 31,75 / + PF 31,75 / + MC 31,75 / + CM 31,75
⁴⁾ + front axle / + asse anteriore / + essieu avant / + eje delantero
⁵⁾ + rear axle / + asse posteriore / + essieu arrière / + eje trasero
⁶⁾ + CC 19,05 / + CC 19,05 / + EE 19,05 / + CTR 19,05

MAGIRUS LKW 290													
	290 D 15 FS			01.70	12.71			03.3134-0300.3	010308			Hz 34,92	ATE
	290 D 22 FK			01.69	12.72			03.0370-1131.2	051131			Hz Reparatursatz	
	290 D 15 FS			01.70	12.71			83.6103-0650.3	330235			L=650	
	290 D 22 FK			01.69	12.72			83.6103-0650.3	330235			L=650	
	290 D 15 FS			01.70	12.71			83.6103-0500.3	330230			L=500	
	290 D 22 FK			01.69	12.72			83.6103-0550.3	330231			L=550	
	290 D 26 K				12.72	+ Nz 34,92 ¹⁾		83.6103-0550.3	330231			L=550	
	290 D 26 S							83.6103-0650.3	330235			L=650	
	290 D 26 K					+ Nz 38,10 ²⁾		83.6103-0550.3	330231			L=550	
								83.6103-0620.3	330234			L=620	
MAGIRUS LKW 310													
	310 D 15 FL/FS			01.71	12.75			03.3134-0300.3	010308			Hz 34,92	ATE
	310 D 16 AK/FAK/FK			01.72	12.82								
	310 D 16 FSL			01.72	12.80			03.0370-1131.2	051131			Hz Reparatursatz	
	310 D 19 AK				12.82			03.3134-0300.3	010308			Hz 34,92	ATE
	310 D 19 FAK/FL												
	310 D 20 AL							03.0370-1131.2	051131			Hz Reparatursatz	
	310 D 22 AK/K/FK			01.71	12.76			03.3134-0300.3	010308			Hz 34,92	ATE
	310 D 22 FA/FAK			01.73	12.80								
	310 D 22 FL/FLL			01.71	12.82								
	310 D 22 FS/FSL			01.71	12.82								
	310 D 26 AK/FK			01.73	12.82								
	310 D 26 AS			01.72	12.82								
	310 D 26 K			01.76	12.82								
	310 D 31 AS			01.72	12.82			03.0370-1131.2	051131			Hz Reparatursatz	
	310 D 15 FL/FS			01.71	12.75			83.6103-0650.3	330235			L=650	
	310 D 16 FAK/FK			01.72	12.82			83.6103-0650.3	330235			L=650	
	310 D 16 FSL			01.72	12.80								
	310 D 31 AS			01.72	12.82			83.6103-0650.3	330235			L=650	
	310 D 16 FSL			01.72	12.80			83.6103-0550.3	330231			L=550	
	310 D 19 FL							83.6103-0650.3	330235			L=650	
	310 D 22 FL/FS			01.71	12.82								
	310 D 22 K/FK			01.71	12.76								
	310 D 22 FLL/FSL			01.71	12.82			83.6103-0400.3	330226			L=400	
	310 D 22 AK/FA/FAK			01.72	12.80			83.6103-0650.3	330235			L=650	
	310 D 26 FK			01.73	12.82								
	310 D 31 AS			01.72	12.82			83.6103-0550.3	330231			L=550	
	310 D 16 AK				12.72			83.6103-0550.3	330231			L=550	
								83.6103-0650.3	330235			L=650	
	310 D 16 FL			01.72	04.73			83.6103-0550.3	330231			L=550	
	310 D 16 FL			05.73	12.82			83.6103-0550.3	330231			L=550	
	310 D 19 AK				12.72			83.6103-0550.3	330231			L=550	
	310 D 22 FS/K				12.72			83.6103-0650.3	330235			L=650	
	310 D 26 AS				12.72								
	310 D 31 AS				12.72			83.6103-0550.3	330231			L=550	
MAGIRUS LKW 340													
	340 D 22 FL/FLL			01.70	12.76			03.3134-0300.3	010308			Hz 34,92	ATE
	340 D 22 FS/FSL			01.70	12.76								
	340 D 22 FL			01.70	12.76			83.6103-0650.3	330235			L=650	
	340 D 22 FLL			01.70	12.76			83.6103-0400.3	330226			L=400	
	340 D 22 FS/FSL			01.70	12.76								
MAGIRUS LKW 70/75													
	75 D 6 FL			01.67	12.69			03.3131-0102.3	010296			Hz 31,75	ATE
								24.3526-0110.3	340018	1		Bremslichtschalter	
	70 D 6 FL			01.67	12.69			83.6103-0550.3	330231			L=550	
	75 D 6 FL			01.67	12.69			83.6103-0550.3	330231			L=550	
	70 D 6 FL			01.67	12.69			83.6103-0550.3	330231			L=550	
	75 D 6 FL			01.67	12.69			83.6103-0550.3	330231			L=550	
MAGIRUS LKW 80													
	80 D 6 FL			01.68	12.75			03.3131-0102.3	010296			Hz 31,75	ATE
								24.3526-0110.3	340018	1		Bremslichtschalter	
	80 D 6 FK/FL			01.68	12.75			83.6103-0550.3	330231			L=550	
								83.6103-0650.3	330235			L=650	
	80 D 6 FLU			01.68	12.75			83.6103-0650.3	330235			L=650	
	80 D 7 FK/FL			01.68	12.75								
	80 D 7 FG/FGB			01.74	12.75			83.6103-0600.3	330233			L=600	
	80 D 7 FK/FL			01.68	12.75								

¹⁾ + SC 34,92 / + C Riv 34,92 / + RE 34,92 / + CRE 34,92

²⁾ + SC 38,10 / + C Riv 38,10 / + RE 38,10 / + CRE 38,10

								
MAGIRUS LKW 80								
	80 D 8 FK/FL		01.68	12.70	83.6103-0600.3	330233		L=600
	80 D 6 FK/FL		01.68	12.75	83.6103-0500.3	330230		L=500 L=550
	80 D 6 FLU		01.68	12.75	83.6103-0500.3	330230		L=500
	80 D 7 FK/FL		01.68	12.75				
	80 D 7 FG/FGB		01.74	12.75	83.6103-0600.3	330233		L=600
	80 D 7 FK/FL		01.68	12.75	83.6103-0500.3	330230		L=500
	80 D 8 FK/FL		01.68	12.70				
MAGIRUS LKW 90								
	90 D 6 FK		01.65	12.66	03.0370-1131.2	051131		Hz Reparatursatz
	90 D 7 FK/FL		01.65	12.66				
	90 D 7 L		01.64	12.66	24.3526-0110.3	340018	1	Bremslichtschalter
	90 M 6 FL		01.75	12.82	03.3138-2001.3	010310		Hz 38,10
					03.0370-1131.2	051131		Hz Reparatursatz
					03.0370-1038.2	051038		Hz Reparatursatz
					03.0370-9998.2	059998		Hz Rep. Satz, -Kolben
								ATE
	90 D 6 FK		01.65	12.66	83.6103-0650.3	330235		L=650
	90 D 7 FK/FL		01.65	12.66				
	90 D 7 L		01.64	12.66	83.6103-0500.3	330230		L=500
	90 M 6 FK/FL		01.75	12.82	83.6103-0650.3	330235		L=650
	90 M 7 FK/FL		01.75	12.82				
	90 M 8 FK/FL		01.75	12.82				
	90 M 9 FL		01.75	12.82				
	90 D 6 FK		01.65	12.66	83.6103-0550.3	330231		L=550
	90 D 7 FK/FL		01.65	12.66				
	90 D 7 L		01.64	12.66	83.6103-0500.3	330230		L=500
	90 M 6 FL		01.75	12.82	83.6103-0600.3	330233		L=600
					83.6103-0620.3	330234		L=620
	90 M 6 FK		01.75	12.82	83.6103-0620.3	330234		L=620
	90 M 7 FK/FL		01.75	12.82				
	90 M 8 FK/FL		01.75	12.82				
	90 M 9 FL		01.75	12.82				
	90 D 6 FK		01.65	12.66	24.2423-0905.3	030070		Gz 23,81
	90 D 7 FK/FL		01.65	12.66				
	90 M 6 FK/FL		01.75	12.82				
	90 M 7 FK/FL		01.75	12.82				
	90 M 8 FK/FL		01.75	12.82				
	90 M 9 FL		01.75	12.82				
	90 D 6 FK		01.65	12.66	24.2538-0901.3	040056		Nz 38,10
	90 D 7 FK/FL		01.65	12.66				
	90 M 6 FK/FL		01.75	12.82				
	90 M 7 FK/FL		01.75	12.82				
	90 M 8 FK/FL		01.75	12.82				
	90 M 9 FL		01.75	12.82				
MAN BUS 192-890								
	420 HOC 1/2		01.64	+ VA-Rz 41,27 ³⁾	03.3131-0601.3	010299		Hz 31,75
	535 HO							ATE
	750 HO							
	535 HO							
	750 H/SL/160 VÖV							
	750 HO 11 UE 192							
	750 HO 12 UE 192							
	750 HO-M 11/160							
	750 HO-V 11/160							
	750 HO-V 12/160							
	750 SUE 230							
	890 SG 192 VÖV							
	535 HO				03.3509-0600.3	310065		Behälter
	750 HO							
	750 HO-M 11/160							
	750 HO-V 11/160							
	750 HO-V 12/160							
	890 UG/UO/UOM 12 A							
	420 HOC 1/2				83.6103-0500.3	330230		L=500
	535 HO		01.64	+ VA-Rz 41,27 ³⁾	83.6103-0260.3	330221		L=260
	750 HO							
	445 HO				03.0450-2509.2	082509		Nz Reparatursatz
	535 HO							
	640 HO 1							
	640 HO-M 11							
	750 HO-M 11/160							
	750 HO-MI-VI-RI-U							
	750 HO-U 11/12-192							
	750 HO-V 11/160							
	750 HO-V 12/160							
	750 HO/SL 160							
	750 HO/SL 176							
	750 SL 160 VÖV							
	750 SÜ							
	890 SG 192							

1) + rear axle / + asse posteriore / + essieu arrière / + eje trasero

2) + front axle / + asse anteriore / + essieu avant / + eje delantero

3) + FA WC 41,27 / + A CR 41,27 / + ess. AV CR 41,27 / + ED CR 41,27

4) + FA WC 44,45 / + A CR 44,45 / + ess. AV CR 44,45 / + ED CR 44,45







5) + differential lock / + differenziale autobloccante / + blocage de différentiel / + bloqueo diferencial





MAN LKW 12.168-12.215

	12.215 H/HK/HS 12.215 HA/HKA/HSA			12.69 12.69		03.0450-2509.2	082509		Nz Reparatursatz
	12.215 H/HA/HK/HKA 12.215 HS/HSA			12.69 12.69		83.6203-0260.3	330300		L=260

MAN LKW 13.136-13.256

	13.136 H/HA 13.168 F/FR 13.168 F/H/HA 13.192 F/H 13.192 FR 13.192 U 13.212 BF/F 13.215 DHA 13.215 F/FK/FS 13.215 H/HA/HK/HKA 13.215 HS/HSA 13.230 BF/F/FK/FS 13.230 DHA 13.230 H/HA/HK/HKA 13.230 HS/HSA 13.250 F/FK/FS 13.256 H/HA			01.82 01.72 01.72 01.82 01.75	12.84 12.81 12.83 12.84 12.75	Typ 523 ¹⁾ Typ 232/233/234 ²⁾ Typ 232/233 ³⁾ Typ 523 ¹⁾ Typ 901 ⁴⁾	03.0370-1131.2	051131		Hz Reparatursatz
	13.136 H/HA 13.168 F/FR 13.168 F/H/HA 13.192 F/H 13.192 FR 13.192 U 13.212 BF/F 13.215 DHA 13.215 F/FK/FS 13.215 H/HA/HK/HKA 13.215 HS/HSA 13.230 BF/F/FK/FS 13.230 DHA 13.230 H/HA/HK/HKA 13.230 HS/HSA 13.250 F/FK/FS 13.256 H/HA			01.82 01.72 01.72 01.82 01.75	12.84 12.81 12.83 12.84 12.75	Typ 523 ¹⁾ Typ 232/233/234 ²⁾ Typ 232/233 ³⁾ Typ 523 ¹⁾ Typ 901 ⁴⁾	03.3508-0501.3	310017		Behälter
	13.136 H/HA 13.168 F/FR 13.168 F/H/HA 13.192 F/H 13.192 FR 13.192 U 13.212 BF/F 13.215 DHA/F/FK/FS 13.215 H/HA/HK/HKA 13.215 HS/HSA 13.230 BF/DHA 13.230 F/FK/FS 13.230 H/HA/HK/HKA 13.230 HS/HSA 13.250 F/FK/FS 13.256 H/HA			01.82 01.72 01.72 01.82 01.75	12.84 12.81 12.83 12.84 12.75	Typ 523 ¹⁾ Typ 232/233/234 ²⁾ Typ 232/233 ³⁾ Typ 523 ¹⁾ Typ 901 ⁴⁾	83.6103-0650.3	330235		L=650
	13.212 BF/F 13.230 BF/F						83.6103-0260.3	330221	■	L=260
	13.212 BF/F/H 13.215 H/HK/HS 13.215 HA/HKA/HSA			12.69 12.69			03.0450-2509.2	082509		Nz Reparatursatz
	13.230 BF 13.230 H/HK/HS 13.230 HA/HKA/HSA			12.69 12.69			03.0450-2509.2	082509		Nz Reparatursatz
	13.212 BF/F/H 13.215 H/HA/HK/HKA 13.215 HS/HSA			12.69 12.69			83.6203-0260.3	330300		L=260
	13.230 BF						83.6203-0260.3	330300		L=260
	13.230 H/HA/HK/HKA 13.230 HS/HSA			12.69 12.69			83.6203-0260.3	330300		L=260

MAN LKW 14.168-14.220

	14.168 F/FR 14.192 F/FR 14.192 U 14.220 F/FL			01.72 01.72 01.75 01.82	12.84 12.84 12.84 12.84	Typ 232/523 ⁵⁾ Typ 232/523 ⁵⁾ Typ 901/903 ⁶⁾ Typ 523 ¹⁾	03.0370-1131.2	051131		Hz Reparatursatz
	14.168 F/FR 14.192 F/FR 14.192 U 14.220 F/FL			01.72 01.72 01.75 01.82	12.84 12.84 12.84 12.84	Typ 232/523 ⁵⁾ Typ 232/523 ⁵⁾ Typ 901/903 ⁶⁾ Typ 523 ¹⁾	03.3508-0501.3	310017		Behälter

¹⁾ type 523 / tipo 523 / type 523 / tipo 523
²⁾ type 232/233/234 / tipo 232/233/234 / type 232/233/234 / tipo 232/233/234
³⁾ type 232/233 / tipo 232/233 / type 232/233 / tipo 232/233
⁴⁾ type 901 / tipo 901 / type 901 / tipo 901
⁵⁾ type 232/523 / tipo 232/523 / type 232/523 / tipo 232/523
⁶⁾ type 901/903 / tipo 910/903 / type 901/903 / tipo 901/903



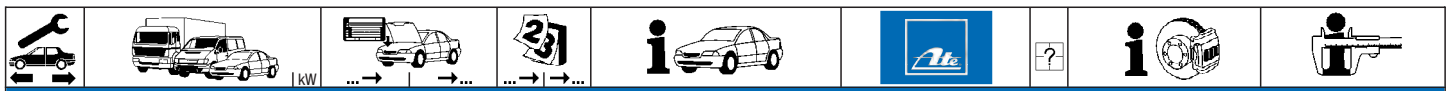

MAN LKW 14.168-14.220

	14.168 F/FR 14.192 F/FR 14.192 U 14.220 F/FL		01.72 01.72 01.75 01.82	12.84 Typ 232/523 ¹⁾ 12.84 Typ 232/523 ¹⁾ 12.84 Typ 901/903 ²⁾ Typ 523 ³⁾	83.6103-0650.3	330235		L=650
--	---	--	----------------------------------	--	----------------	--------	--	-------

MAN LKW 15.136-15.240

	15.136 F/H/HA 15.168 F/FL 15.168 H 15.168 HA/FM 15.192 F/FL 15.192 FT 15.192 H 15.192 HA 15.200 F/H 15.212 DH 15.216 F/H/HA 15.220 F/FL 15.240 F 15.240 F/FL 15.240 H 15.240 HA		01.72 01.72 01.72 01.78 01.80 01.73 01.82 01.73 01.82 01.73 01.79	12.83 Typ 237 ⁴⁾ 12.85 Typ 235/540 ⁵⁾ 12.83 Typ 237 ⁴⁾ Typ 459 ⁶⁾ Typ 540 ⁷⁾ 12.80 Typ 224/226 ⁸⁾ Typ 526 ⁹⁾ 12.83 Typ 224 ¹⁰⁾ Typ 526 ⁹⁾ Typ 226/524 ¹¹⁾ Typ 525 ¹²⁾	03.0370-1131.2	051131		Hz Reparatursatz
--	--	--	---	--	----------------	--------	--	------------------

	15.136 F/H/HA 15.168 F/FL 15.168 H 15.168 HA/FM 15.192 F/FL 15.192 FT 15.192 H 15.192 HA 15.200 F/H 15.212 DH 15.216 F/H/HA 15.220 F/FL 15.240 F 15.240 F/FL 15.240 H 15.240 HA		01.72 01.72 01.72 01.78 01.80 01.73 01.82 01.73 01.82 01.73 01.79	12.83 Typ 237 ⁴⁾ 12.85 Typ 235/540 ⁵⁾ 12.83 Typ 237 ⁴⁾ Typ 459 ⁶⁾ Typ 540 ⁷⁾ 12.80 Typ 224/226 ⁸⁾ Typ 526 ⁹⁾ 12.83 Typ 224 ¹⁰⁾ Typ 526 ⁹⁾ Typ 226/524 ¹¹⁾ Typ 525 ¹²⁾	03.3508-0501.3	310017		Behälter
--	--	--	---	--	----------------	--------	--	----------

	15.136 F/H/HA 15.168 F 15.168 F/FL 15.168 H 15.168 HA/FM 15.192 F 15.192 F/FL 15.192 FT 15.192 H 15.192 HA 15.200 F 15.212 DH 15.216 F/H/HA 15.220 F/FL 15.240 F 15.240 F/FL 15.240 H 15.240 HA		01.72 01.77 01.72 01.72 01.78 01.80 01.73	12.76 Typ 237 ⁴⁾ 12.83 Typ 237 ⁴⁾ 12.85 Typ 235/540 ⁵⁾ 12.76 Typ 237 ⁴⁾ 12.83 Typ 237 ⁴⁾ Typ 459 ⁶⁾ Typ 540 ⁷⁾ Typ 224 ¹⁰⁾ + HA-Rz 50,80 ¹³⁾ Typ 526 ⁹⁾ Typ 224 ¹⁰⁾ 12.83 Typ 224 ¹⁰⁾ Typ 526 ⁹⁾ Typ 524 ¹⁴⁾ Typ 525 ¹²⁾	83.6103-0650.3 83.6103-0800.3 83.6103-0650.3 83.6103-0800.3 83.6103-0650.3 83.6103-0500.3 83.6103-0650.3 83.6103-0800.3 83.6103-0700.3 83.6103-0650.3 83.6103-0800.3 83.6103-0650.3	330235 330237 330235 330237 330230 330235 330237 330236 330235 330237 330235		L=650 L=800 L=650 L=800 L=650 L=500 L=650 L=800 L=700 L=650 L=800 L=650
--	--	--	---	---	--	--	--	--

MAN LKW 16.168-16.361

	16.168 F 16.168 F/FL-FKO 16.168 FM-FKO 16.168 H 16.192 F 16.192 F/FL-FKO 16.192 FM-FKO 16.192 H 16.215 FN 16.230 FL/FN 16.240 F 16.240 F 16.240 F/FL 16.240 H 16.240 H 16.240 HA 16.250 FN 16.256 DH/DHA/FAE 16.280 H/HA 16.281 F/FA 16.281 H 16.281 HA 16.304 F/FVS 16.320 F 16.321 F/FA		01.73 01.82 01.72 01.73 01.73 01.82 01.72 01.73 01.73 01.73 01.74 01.81 01.73 01.79 01.79 01.77 01.79 01.80 01.77 01.72 01.79	12.83 Typ 255/410 ¹⁵⁾ Typ 543 ¹⁶⁾ Typ 174 ¹⁷⁾ 12.85 Typ 253/540 ¹⁸⁾ Typ 255/410 ¹⁵⁾ Typ 543 ¹⁶⁾ Typ 174 ¹⁷⁾ Typ 253/540 ¹⁸⁾ Typ 314 ¹⁹⁾ Typ 258 ²⁰⁾ Typ 527 ²¹⁾ Typ 313 ²²⁾ Typ 524 ¹⁴⁾ Typ 525 ¹²⁾ Typ 420/421 ²³⁾ Typ 503/505 ²⁴⁾ Typ 501 ²⁵⁾ Typ 502 ²⁶⁾ Typ 222 ²⁷⁾ Typ 503/505 ²⁴⁾	03.0370-1131.2	051131		Hz Reparatursatz
--	---	--	---	--	----------------	--------	--	------------------

¹⁾ type 232/523 / tipo 232/523 / type 232/523 / tipo 232/523
²⁾ type 901/903 / tipo 910/903 / type 901/903 / tipo 901/903
³⁾ type 523 / tipo 523 / type 523 / tipo 523
⁴⁾ type 237 / tipo 237 / type 237 / tipo 237
⁵⁾ type 235/540 / tipo 235/540 / type 235/540 / tipo 235/540
⁶⁾ type 459 / tipo 459 / type 459 / tipo 459
⁷⁾ type 540 / tipo 540 / type 540 / tipo 540
⁸⁾ type 224/226 / tipo 224/226 / type 224/226 / tipo 224/226
⁹⁾ type 526 / tipo 526 / type 526 / tipo 526
¹⁰⁾ type 224 / tipo 224 / type 224 / tipo 224
¹¹⁾ type 258 / tipo 258 / type 258 / tipo 258
¹²⁾ type 525 / tipo 525 / type 525 / tipo 525
¹³⁾ + RA WC 50,80 / + P CR 50,80 / + ess.AR CR 50,80 / + ET CR 50,80
¹⁴⁾ type 524 / tipo 524 / type 524 / tipo 524
¹⁵⁾ type 255/410 / tipo 255/410 / type 255/410 / tipo 255/410
¹⁶⁾ type 543 / tipo 543 / type 543 / tipo 543
¹⁷⁾ type 174 / tipo 174 / type 174 / tipo 174
¹⁸⁾ type 253/540 / tipo 253/540 / type 253/540 / tipo 253/540
¹⁹⁾ type 314 / tipo 314 / type 314 / tipo 314
²⁰⁾ type 226/524 / tipo 226/524 / type 226/524 / tipo 226/524
²¹⁾ type 527 / tipo 527 / type 527 / tipo 527
²²⁾ type 313 / tipo 313 / type 313 / tipo 313
²³⁾ type 420/421 / tipo 420/421 / type 420/421 / tipo 420/421
²⁴⁾ type 503/505 / tipo 503/505 / type 503/505 / tipo 503/505
²⁵⁾ type 501 / tipo 501 / type 501 / tipo 501
²⁶⁾ type 502 / tipo 502 / type 502 / tipo 502
²⁷⁾ type 222 / tipo 222 / type 222 / tipo 222



MAN LKW 16.168-16.361

	16.321 H/HA 16.361 F/FL		01.79 01.84	Typ 501/502 ¹⁾ Typ 503/504 ²⁾	03.0370-1131.2 051131		Hz Reparatursatz	
	16.168 F 16.168 F/FL-FKO 16.168 FM-FKO 16.168 H 16.192 F 16.192 F/FL-FKO 16.192 FM-FKO 16.192 H 16.215 FN 16.230 FL/FN 16.240 F 16.240 F 16.240 F/FL 16.240 H 16.240 H 16.240 HA 16.250 FN 16.256 DH/DHA/FAE 16.280 H/HA 16.281 F/FA 16.281 H 16.281 HA 16.304 F/FVS 16.320 F 16.321 F/FA 16.321 H/HA 16.361 F/FL		01.73 01.82 01.72 01.73 01.73 01.82 01.72 01.73 01.73 01.72 01.72 01.73 01.73 01.72 01.79 01.80 01.77 01.79 01.84	12.83 12.83 12.83 12.85 12.83 12.83 12.83 12.85 12.84 12.82 12.81 12.81 12.86 12.82 12.85 12.81 12.85 12.81	Typ 255/410 ³⁾ Typ 543 ⁴⁾ Typ 174 ⁵⁾ Typ 253/540 ⁶⁾ Typ 255/410 ³⁾ Typ 543 ⁴⁾ Typ 174 ⁵⁾ Typ 253/540 ⁶⁾ Typ 314 ⁷⁾ Typ 258 ⁸⁾ Typ 527 ⁹⁾ Typ 313 ¹⁰⁾ Typ 524 ¹¹⁾ Typ 525 ¹²⁾ Typ 420/421 ¹³⁾ Typ 503/505 ¹⁴⁾ Typ 501 ¹⁵⁾ Typ 502 ¹⁶⁾ Typ 222 ¹⁷⁾ Typ 503/505 ¹⁴⁾ Typ 501/502 ¹⁾ Typ 503/504 ²⁾	03.3508-0501.3 310017		Behälter
	16.168 F 16.168 F/FL-FKO 16.168 FM-FKO 16.168 H 16.192 F 16.192 F/FL-FKO 16.192 FM-FKO 16.192 H 16.215 FN 16.230 FL/FN		01.73 01.82 01.72 01.73 01.73 01.82 01.72 01.73	12.83 12.83 12.83 12.85 12.83 12.83 12.83 12.85	Typ 255/410 ³⁾ Typ 543 ⁴⁾ Typ 174 ⁵⁾ Typ 253/540 ⁶⁾ Typ 255/410 ³⁾ Typ 543 ⁴⁾ Typ 174 ⁵⁾ Typ 253/540 ⁶⁾	83.6103-0650.3 330235		L=650
	16.240 F		01.74	05.78 Typ 258/ - Luftfederung ¹⁸⁾	83.6103-0700.3 330236		L=700	
	16.240 F 16.240 F 16.240 F/FL 16.240 H 16.240 H 16.240 HA 16.250 FN 16.256 DH/DHA/FAE 16.280 H/HA 16.281 F/FA 16.281 H 16.281 HA 16.304 F/FVS 16.321 F/FA 16.321 H/HA 16.361 F		01.74 06.78 01.81 01.73 01.79 01.79 01.77 01.79 01.80 01.77 01.79 01.79 01.84	05.78 12.82 Typ 258 ⁸⁾ Typ 527 ⁹⁾ Typ 313 ¹⁰⁾ Typ 524 ¹¹⁾ Typ 525 ¹²⁾ 12.82 Typ 420/421 ¹³⁾ 12.85 Typ 503/505 ¹⁴⁾ Typ 501 ¹⁵⁾ Typ 502 ¹⁶⁾ 12.85 Typ 503/505 ¹⁴⁾ Typ 501/502 ¹⁾ Typ 503 ²⁰⁾	83.6103-0650.3 330235		L=650	

MAN LKW 19.168-19.361

	19.192 H/HA 19.215 DF/DFK/DFS 19.215 DH/DHK/DHKA 19.215 DHS/DHSA 19.215 H/HA 19.230 DF/DFK/DFS 19.230 DH/DHK/DHKA 19.230 DHS/DHSA 19.230 H/HA 19.250 DF/DFK/DFS 19.256 DH/DHA 19.280 H/HA 19.281 F/FA 19.281 H/HA 19.304 DF/DFR 19.320 F 19.321 F/FA 19.321 H/HA 19.361 F		01.77 01.79 01.79	12.82 12.85 Typ 523/624/505 ²¹⁾ Typ 501/502 ¹⁾	03.0370-1131.2 051131		Hz Reparatursatz
	19.192 H/HA 19.215 DF/DFK/DFS 19.215 DH/DHK/DHKA 19.215 DHS/DHSA 19.215 H/HA 19.230 DF/DFK/DFS 19.230 DH/DHK/DHKA 19.230 DHS/DHSA 19.230 H/HA				03.3508-0501.3 310017		Behälter

¹⁾ type 501/502 / tipo 501/502 / type 501/502 / tipo 501/502
²⁾ type 503/504 / tipo 503/504 / type 503/504 / tipo 503/504
³⁾ type 255/410 / tipo 255/410 / type 255/410 / tipo 255/410
⁴⁾ type 543 / tipo 543 / type 543 / tipo 543
⁵⁾ type 174 / tipo 174 / type 174 / tipo 174
⁶⁾ type 253/540 / tipo 253/540 / type 253/540 / tipo 253/540
⁷⁾ type 314 / tipo 314 / type 314 / tipo 314
⁸⁾ type 258 / tipo 258 / type 258 / tipo 258
⁹⁾ type 527 / tipo 527 / type 527 / tipo 527

¹⁰⁾ type 313 / tipo 313 / type 313 / tipo 313
¹¹⁾ type 524 / tipo 524 / type 524 / tipo 524
¹²⁾ type 525 / tipo 525 / type 525 / tipo 525
¹³⁾ type 420/421 / tipo 420/421 / type 420/421 / tipo 420/421
¹⁴⁾ type 503/505 / tipo 503/505 / type 503/505 / tipo 503/505
¹⁵⁾ type 501 / tipo 501 / type 501 / tipo 501
¹⁶⁾ type 502 / tipo 502 / type 502 / tipo 502
¹⁷⁾ type 222 / tipo 222 / type 222 / tipo 222
¹⁸⁾ type 258/ - pneumatic suspens. / tipo 258/ - sospens.pneumatica / type 258/ - susp.pneumatique / tipo 258/ - suspens.neumática





MAN LKW 19.168-19.361

	19.250 DF/DFK/DFS 19.256 DH/DHA 19.280 H/HA 19.281 F/FA 19.281 H/HA 19.304 DF/DFR 19.320 F 19.321 F/FA 19.321 H/HA 19.361 F						03.3508-0501.3	310017		Behälter
	19.192 H/HA 19.215 DF/DFK/DFS 19.215 DH/DHK/DHKA 19.215 DHS/DHSA 19.215 H/HA 19.230 DF/DFK/DFS 19.230 DH/DHK/DHKA 19.230 DHS/DHSA 19.230 H/HA 19.250 DF/DFK/DFS 19.256 DH/DHA 19.280 H/HA 19.281 F/FA 19.281 H/HA 19.304 DF/DFR 19.321 F/FA 19.321 H/HA 19.361 F									L=650
	19.215 DH/DHK/DHKA 19.215 DHS/DHSA/HA 19.230 DH/DHK/DHKA 19.230 DHS/DHSA/HA 19.304 DF/DFR									L=260
	19.215 DH/DHK/DHS 19.215 DHKA/DHSA 19.230 DH/DHK/DHS 19.230 DHKA/DHSA				12.69 12.69 12.69 12.69		03.0450-2509.2	082509		Nz Reparatursatz
	19.192 DH/DHA 19.215 DH 19.215 DHA 19.215 DHK/DHKA 19.215 DHS/DHSA				01.69 01.69 12.69 12.69		83.6203-0260.3	330300		L=260
	19.230 DH 19.230 DHA 19.230 DHK/DHKA 19.230 DHS/DHSA				01.69 12.69 12.69		83.6203-0260.3	330300		L=260

MAN LKW 20.192-20.321

	20.192 DH 20.280 DFAEG				01.75 01.78	12.80 Typ 213 ⁶⁾ Typ 433 ⁷⁾	03.0370-1131.2	051131		Hz Reparatursatz
	20.192 DH 20.280 DFAEG				01.75 01.78	12.80 Typ 213 ⁶⁾ Typ 433 ⁷⁾	03.3508-0501.3	310017		Behälter
	20.280 DFAEG				01.78	Typ 433 ⁷⁾	83.6103-0320.3	330224		L=320

MAN LKW 21.212

	21.212 DH/DHA						03.0370-1131.2	051131		Hz Reparatursatz
	21.212 DH/DHA						03.3508-0501.3	310017		Behälter
	21.212 DH/DHA						83.6103-0650.3	330235		L=650
	21.212 DH/DHA						03.0450-2509.2	082509		Nz Reparatursatz
	21.212 DH/DHA						83.6203-0260.3	330300		L=260

MAN LKW 22.192-22.321

	22.192 DF-KO 22.192 DH 22.192 FN 22.215 DH/DHA 22.215 DHK/DHKA 22.215 DHS/DHSA 22.230 DH/DHA 22.230 DHK/DHKA 22.230 DHS/DHSA				01.79 01.75	12.82 Typ 445 ⁸⁾ Typ 213 ⁶⁾	03.0370-1131.2	051131		Hz Reparatursatz
--	--	--	--	--	----------------	--	----------------	--------	--	------------------

1) type 420/421 / tipo 420/421 / type 420/421 / tipo 420/421
 2) type 523/624/505 / tipo 523/624/505 / type 523/624/505 / tipo 523/624/505
 3) type 501/502 / tipo 501/502 / type 501/502 / tipo 501/502
 4) type 222 / tipo 222 / type 222 / tipo 222
 5) type 523 / tipo 523 / type 523 / tipo 523
 6) type 213 / tipo 213 / type 213 / tipo 213
 7) type 433 / tipo 433 / type 433 / tipo 433
 8) type 445 / tipo 445 / type 445 / tipo 445





MAN LKW 22.192-22.321

	22.304 FN 22.320 F 22.320 FNL					03.0370-1131.2	051131		Hz Reparatursatz
			01.72	12.80	Typ 212 ¹⁾				
	22.192 DF-KO 22.192 DH 22.192 FN 22.215 DH/DHA 22.215 DHK/DHKA 22.215 DHS/DHSA 22.230 DH/DHA 22.230 DHK/DHKA 22.230 DHS/DHSA 22.304 FN 22.320 F 22.320 FNL		01.79 01.75	12.82	Typ 445 ²⁾ Typ 213 ³⁾	03.3508-0501.3	310017		Behälter
			01.72	12.80	Typ 212 ¹⁾				
	22.192 FN 22.215 DH/DHA 22.215 DHK/DHKA 22.215 DHS/DHSA 22.230 DH/DHA 22.230 DHK/DHKA 22.230 DHS/DHSA 22.304 FN 22.320 F					83.6103-0650.3	330235		L=650
	22.215 DH/DHA 22.215 DHK/DHKA 22.215 DHS/DHSA 22.230 DH/DHA 22.230 DHK/DHKA 22.230 DHS/DHSA					83.6103-0260.3	330221	■	L=260
	22.215 DH/DHK/DHS 22.215 DHKA/DHSA 22.230 DH/DHK/DHS 22.230 DHKA/DHSA			12.69 12.69 12.69 12.69		03.0450-2509.2	082509		Nz Reparatursatz
	22.215 DH 22.215 DHA 22.215 DHK/DHKA 22.215 DHS/DHSA		01.69			83.6203-0260.3	330300		L=260
				12.69 12.69					
	22.230 DH 22.230 DHA 22.230 DHK/DHKA 22.230 DHS/DHSA		01.69			83.6203-0260.3	330300		L=260
				12.69 12.69					

MAN LKW 26.162-26.365

	26.192 DH/DHA 26.215 DF/DH/DHA 26.230 DF/DH/DHA 26.240 DH/DHA 26.256 DF/DH 26.256 DHA 26.280 DH 26.281 DH/DHA 26.304 DF/DFA/DFL 26.320 DF 26.320 DHA 26.321 DH/DHA		01.79 01.72	12.78	Typ 532/533 ⁴⁾ Typ 274/278 ⁵⁾	03.0370-1131.2	051131		Hz Reparatursatz
			01.77 01.80	12.82	Typ 423 ⁶⁾ Typ 507/508 ⁷⁾				
			01.72	12.86	Typ 225 ⁸⁾				
			01.72	12.77	Typ 242 ⁹⁾				
			01.80		Typ 507/508 ⁷⁾				
	26.192 DH/DHA 26.215 DF/DH/DHA 26.230 DF/DH/DHA 26.240 DH/DHA 26.256 DF/DH 26.256 DHA 26.280 DH 26.281 DH/DHA 26.304 DF/DFA/DFL 26.320 DF 26.320 DHA 26.321 DH/DHA		01.79 01.72	12.78	Typ 532/533 ⁴⁾ Typ 274/278 ⁵⁾	03.3508-0501.3	310017		Behälter
			01.77 01.80	12.82	Typ 423 ⁶⁾ Typ 507/508 ⁷⁾				
			01.72	12.86	Typ 225 ⁸⁾				
			01.72	12.77	Typ 242 ⁹⁾				
			01.80		Typ 507/508 ⁷⁾				
	26.192 DH/DHA 26.215 DF/DH/DHA 26.230 DF/DH/DHA 26.240 DH/DHA 26.256 DHA 26.281 DH/DHA 26.304 DF/DFA/DFL 26.320 DF 26.321 DH/DHA		01.79 01.80	12.78	Typ 532/533 ⁴⁾ - Typ 279 ¹⁰⁾ Typ 507/508 ⁷⁾	83.6103-0650.3	330235		L=650
			01.72	12.86	Typ 225 ⁸⁾				
			01.80		Typ 507/508 ⁷⁾				

MAN LKW 30.192-30.321

	30.192 DHA 30.215 DH/DHA 30.230 DH/DHA 30.256 DH/DHA 30.281 VF 30.304 DFA 30.320 DF		01.80 01.72	12.85	Typ 512 ¹¹⁾ Typ 225 ⁸⁾	03.0370-1131.2	051131		Hz Reparatursatz

¹⁾ type 212 / tipo 212 / type 212 / tipo 212
²⁾ type 445 / tipo 445 / type 445 / tipo 445
³⁾ type 213 / tipo 213 / type 213 / tipo 213
⁴⁾ type 532/533 / tipo 532/533 / type 532/533 / tipo 532/533
⁵⁾ type 274/278 / tipo 274/278 / type 274/278 / tipo 274/278
⁶⁾ type 423 / tipo 423 / type 423 / tipo 423
⁷⁾ type 507/508 / tipo 507/508 / type 507/508 / tipo 507/508
⁸⁾ type 225 / tipo 225 / type 225 / tipo 225
⁹⁾ type 242 / tipo 242 / type 242 / tipo 242

¹⁰⁾ - type 279 / - tipo 279 / - type 279 / - tipo 279
¹¹⁾ type 512 / tipo 512 / type 512 / tipo 512





MAN LKW 30.192-30.321

	30.321 VF			01.80	12.85	Typ 512 ¹⁾	03.0370-1131.2	051131		Hz Reparatursatz
	30.192 DHA 30.215 DH/DHA 30.230 DH/DHA 30.256 DH/DHA 30.281 VF 30.304 DFA 30.320 DF 30.321 VF			01.80	12.85	Typ 512 ¹⁾	03.3508-0501.3	310017		Behälter
	30.192 DHA 30.215 DH/DHA 30.230 DH/DHA 30.256 DH/DHA 30.281 VF 30.304 DFA 30.320 DF 30.321 VF			01.80	12.85	Typ 512 ¹⁾	83.6103-0650.3	330235		L=650

MAN LKW 32.280-32.365

	32.280 DH 32.281 DH/DHA 32.320 DF 32.321 DH/DHA			01.77 01.80 01.72 01.80	12.82	Typ 423 ³⁾ Typ 507/508 ⁴⁾ Typ 225 ²⁾ Typ 507/508 ⁴⁾	03.0370-1131.2	051131		Hz Reparatursatz
	32.280 DH 32.281 DH/DHA 32.320 DF 32.321 DH/DHA			01.77 01.80 01.72 01.80	12.82	Typ 423 ³⁾ Typ 507/508 ⁴⁾ Typ 225 ²⁾ Typ 507/508 ⁴⁾	03.3508-0501.3	310017		Behälter
	32.281 DH/DHA 32.320 DF 32.321 DH/DHA			01.80 01.72 01.80	12.86	Typ 507/508 ⁴⁾ Typ 225 ²⁾ Typ 507/508 ⁴⁾	83.6103-0650.3	330235		L=650

MAN LKW 33.240-33.365

	33.320 DF			01.82	12.86	Typ 225 ²⁾	03.0370-1131.2	051131		Hz Reparatursatz
	33.320 DF			01.82	12.86	Typ 225 ²⁾	03.3508-0501.3	310017		Behälter
	33.320 DF			01.82	12.86	Typ 225 ²⁾	83.6103-0650.3	330235		L=650

MAN LKW 415-2180

	415 F/FS 415 H/HA/HK/HS/HSA 450 H/HA 520 F/H/HA/H-SKD 620 F/H/HA 626 635 F/H/HA 635 FMW 635 L1/L1F 635 L1A/L1FA 650 F/H/HA 770 L1/L1A/L1F			01.65	12.67 12.65 12.65		03.3131-0601.3	010299		Hz 31,75 ATE
	1070 L1 1080 F/H/HA 1570 H/HA/HK/HKA 1580 DF/DH 780 F/H/HA 850 H/HA			01.63			03.0370-1131.2	051131		Hz Reparatursatz
	1580 DAH						03.3131-0601.3	010299		Hz 31,75 ATE
	1580 FN 1580 FNMW			01.63			03.3131-0601.3 03.0370-1131.2	010299 051131	+ Vorderachse ⁵⁾ + Hinterachse ⁶⁾	Hz 31,75 Hz Reparatursatz ATE
	2170 H/HA/HK/HKA 2170 HS/HSA 2180 DHA						03.0370-1131.2	051131		Hz Reparatursatz
	1070 L1 1080 F/H/HA 1570 H/HA/HK/HKA 1580 DAH/DF/DH 415 F/FS 415 H/HA/HK/HS/HSA 450 H/HA 520 F/H/HA/H-SKD 620 F/H/HA 626 635 F/H/HA 635 FMW 635 L1/L1F 635 L1A/L1FA 650 F/H/HA 770 L1/L1A/L1F			01.65 01.63	12.67 12.65 12.65		03.3508-0501.3	310017		Behälter

¹⁾ type 512 / tipo 512 / type 512 / tipo 512
²⁾ type 225 / tipo 225 / type 225 / tipo 225
³⁾ type 423 / tipo 423 / type 423 / tipo 423
⁴⁾ type 507/508 / tipo 507/508 / type 507/508 / tipo 507/508
⁵⁾ + front axle / + asse anteriore / + essieu avant / + eje delantero
⁶⁾ + rear axle / + asse posteriore / + essieu arrière / + eje trasero



MAN LKW 415-2180

	780 F/H/HA 850 H/HA		01.63		03.3508-0501.3	310017		Behälter
	1580 FN 1580 FNMW		01.63		03.3508-0501.3 03.3508-0264.3	310017 310009	+ Vorderachse ¹⁾ + Hinterachse ²⁾	Behälter Behälter
	2170 H/HA/HK/HKA 2170 HS/HSA 2180 DHA				03.3508-0501.3	310017		Behälter
	415 F/FS 415 H/HA/HK/HS/HSA				83.6103-0550.3 83.6103-0260.3	330231 330221	<input type="checkbox"/>	L=550 L=260
	450 H/HA				83.6103-0650.3	330235		L=650
	520 F/H/HA				83.6103-0550.3 83.6103-0260.3	330231 330221	<input type="checkbox"/>	L=550 L=260
	520 H-SKD				83.6103-0550.3	330231		L=550
	620 F/H/HA 626				83.6103-0550.3 83.6103-0260.3	330231 330221	<input type="checkbox"/>	L=550 L=260
	635 F/HA				83.6103-0550.3	330231		L=550
	635 H				83.6103-0650.3	330235		L=650
	635 L1/L1F		12.65		83.6103-0550.3 83.6103-0260.3	330231 330221	<input type="checkbox"/>	L=550 L=260
	635 L1A/L1FA		12.65		83.6103-0650.3 83.6103-0260.3	330235 330221	<input type="checkbox"/>	L=650 L=260
	650 F		12.63		83.6103-0550.3	330231		L=550
	650 H		12.63		83.6103-0620.3	330234		L=620
	650 HA		12.63		83.6103-0650.3	330235		L=650
	770 L1/L1A/L1F				83.6103-0620.3	330234		L=620
	780 F/H/HA 850 H/HA		01.63		83.6103-0650.3	330235		L=650
	1070 L1 1080 H/HA				83.6103-0620.3 83.6103-0260.3	330234 330221	<input type="checkbox"/>	L=620 L=260
	1080 F				83.6103-0650.3	330235		L=650
	1570 H/HA/HK/HKA				83.6103-0650.3 83.6103-0260.3	330235 330221	<input type="checkbox"/>	L=650 L=260
	1580 DF				83.6103-0650.3	330235		L=650
	1580 DH/DHA				83.6103-0700.3	330236		L=700
	1580 FN		01.63		83.6103-0620.3	330234		L=620
	1580 FNMW				83.6103-0550.3	330231		L=550
	2170 H/HA/HK/HKA 2170 HS/HSA				83.6103-0650.3 83.6103-0260.3	330235 330221	<input type="checkbox"/>	L=650 L=260
	2180 DHA				83.6103-0650.3	330235		L=650
	1070 L1 1080 F/H/HA 1580 DF/DH/DHA/DN 1580 FN/FNWM 2180 DHA/H 635 F/L1/L1A/L1F 780 F/HA 850 H/HA				03.0450-2509.2	082509		Nz Reparatursatz
	635 F/L1/L1A/L1F				83.6103-0550.3	330231		L=550
	1070 L1 1080 F/H/HA 1580 DF/DH/DHA/DN 1580 FN/FNWM 2180 DHA/H 780 F/HA 850 H/HA				83.6203-0260.3	330300		L=260

MAN LKW 6.115

	6.115 H/HK/HKA/HS				03.3131-0601.3	010299		Hz 31,75	ATE
	6.115 H/HK/HKA/HS				03.3508-0501.3	310017		Behälter	
	6.115 H/HK/HKA/HS				83.6103-0550.3	330231		L=550	
	6.115 H/HK/HKA/HS				83.6103-0260.3	330221	<input type="checkbox"/>	L=260	

MAN LKW 7.126-7.136

	7.126 H/HK/HKA/HS				03.3131-0601.3	010299	L=177/ Hub=50 ³⁾	Hz 31,75	ATE
	7.126 H/HA				03.0370-1131.2	051131		Hz Reparatursatz	
	7.135 H/HK/HS 7.135 HA/HAK				03.3131-0601.3	010299		Hz 31,75	ATE
	7.136 H/HA				03.0370-1131.2	051131		Hz Reparatursatz	

¹⁾ + front axle / + asse anteriore / + essieu avant / + eje delantero

²⁾ + rear axle / + asse posteriore / + essieu arrière / + eje trasero

³⁾ L=177/stroke=50 / L=177/corsa=50 / L=177/course=50 / L=177/carrera=50

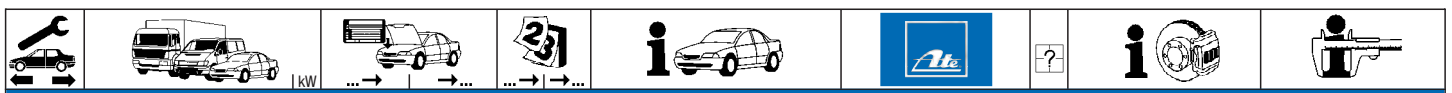

MAN LKW 7.126-7.136

	7.126 H/HK/HS 7.126 HA/HKA 7.135 H/HK/HS 7.135 HA/HAK 7.136 H/HA					03.3508-0501.3	310017		Behälter
	7.126 H/HA/HK/HKA 7.126 HS 7.135 H/HK/HS 7.135 HA/HAK 7.136 H/HA					83.6103-0550.3	330231		L=550
	7.126 H/HA/HK/HKA 7.126 HS 7.136 H/HA					83.6103-0650.3	330235		L=650
	7.135 HA/HAK 7.136 H/HA					83.6103-0550.3	330231		L=550
	7.126 H/HA/HK/HKA 7.126 HS 7.136 H/HA					83.6103-0260.3	330221	■	L=260
	7.135 H/HA					03.0450-2509.2	082509		Nz Reparatursatz
	7.126 H/HK/HS 7.126 HA/HKA/HSA 7.136 H/HA/HK 7.136 HKA/HS/HSA					83.6203-0260.3	330300		L=260

MAN LKW 8.156-8.168

	8.156 F/FK/FS 8.156 H/HK/HS 8.156 HA/HKA/HSA					03.3131-0601.3	010299		Hz 31,75	ATE
	8.156 F/FK/FS 8.156 H/HK/HS 8.156 HA/HKA/HSA					03.3508-0501.3	310017		Behälter	
	8.156 F/FK/FS 8.156 H/HK/HS 8.156 HA/HKA/HSA					83.6103-0550.3	330231		L=550	
	8.156 H/HK/HS 8.156 HA/HKA/HSA					83.6103-0650.3	330235		L=650	
	8.156 H/HK/HS 8.156 HA/HKA/HSA				12.69 12.69	03.0450-2509.2	082509		Nz Reparatursatz	
	8.126 H/HA 8.156 H/HK/HS 8.156 HA/HKA/HSA 8.160 H/HA 8.168 H/HA				01.69	83.6203-0260.3	330300		L=260	
	8.156 H/HK/HS 8.156 HA/HKA/HSA 8.160 H/HA 8.168 H/HA					83.6203-0260.3	330300		L=260	

MAN LKW 9.126-9.216

	9.136 H/HA 9.156 F/FK/FS 9.160 F/FK/FS/H 9.168 H 9.186 F/FK/FS 9.186 H/HA/HK/HKA 9.186 HS/HSA 9.192 H/HA 9.216 H/HAF					03.0370-1131.2	051131		Hz Reparatursatz
	9.136 H/HA 9.156 F/FK/FS 9.160 F/FK/FS/H 9.168 H 9.186 F/FK/FS 9.186 H/HA/HK/HKA 9.186 HS/HSA 9.192 H/HA 9.216 H/HAF					03.3508-0501.3	310017		Behälter
	9.136 H/HA 9.156 F/FK/FS 9.160 F/FK/FS/H 9.168 H 9.186 F/FK/FS 9.186 H/HA/HK/HKA 9.186 HS/HSA 9.192 H/HA 9.216 H/HAF					83.6103-0650.3	330235		L=650
	9.156 H/HA/HS 9.156 HK/HKA/HSA 9.156 HR 9.160 H/HA/HS 9.160 HK/HKA/HSA 9.186 H/HA/HS 9.186 HA/HKA/HSA 9.186 HR				12.69 12.69 12.69 12.69	03.0450-2509.2	082509		Nz Reparatursatz
	9.186 H/HA/HS 9.186 HA/HKA/HSA 9.186 HR				12.69 12.69	03.0450-2509.2	082509		Nz Reparatursatz
	9.215 HR					03.0450-2509.2	082509		Nz Reparatursatz
	9.126 H/HA 9.156 HR 9.156 H/HA/HS 9.156 HK/HKA/HSA 9.160 H/HA/HS				01.69	83.6203-0260.3	330300		L=260
	9.156 HR 9.156 H/HA/HS 9.156 HK/HKA/HSA 9.160 H/HA/HS				12.69 12.69 12.69	83.6103-0260.3 83.6203-0260.3	330221 330300	Innen- u. Außengewinde ¹⁾ 2x Innengewinde ²⁾	L=260 L=260
	9.156 H/HA/HS 9.156 HK/HKA/HSA 9.160 H/HA/HS				12.69 12.69 12.69	83.6203-0260.3	330300		L=260

¹⁾ inner and outer thread / filettatura interna + esterno / taraud. intérieur + extérieur / rosca interior + exterior

²⁾ 2x inner thread / 2x filettatura interna / 2x taraudage intérieur / 2x rosca interior

MAN LKW 9.126-9.216														
	9.160 HK/HKA/HSA				12.69			83.6203-0260.3	330300				L=260	
	9.186 HR							83.6103-0260.3	330221			Innen- u. Außengewinde ¹⁾	L=260	
								83.6203-0260.3	330300			2x Innengewinde ²⁾	L=260	
	9.186 H/HA/HK/HKA 9.186 HS/HSA 9.192 H/HA/HK/HKA 9.192 HS/HSA							83.6203-0260.3	330300				L=260	
	9.215 HR							83.6103-0260.3	330221			Innen- u. Außengewinde ¹⁾	L=260	
								83.6203-0260.3	330300			2x Innengewinde ²⁾	L=260	
MASERATI MASERATI														
	Biturbo 2000				01.82			13.0441-4018.2	250083				Dichtungssatz	ATE
	Biturbo 222				01.88	12.88		13.0441-4018.2	250083				Dichtungssatz	ATE
	Biturbo 420				01.85	12.87								
	Biturbo 425				01.85	12.87								
	228				01.89			11.0441-5702.2	250033				Dichtungssatz	ATE
	Biturbo 222				01.89			11.8116-0091.1	390502	2			Haltefeder	ATE
	Biturbo 430				01.89			11.0101-5407.2	260011				Hülsensatz	ATE
	Biturbo Karif Biturbo Spider				01.89			11.8171-0008.1	990049				Führungsbolzen	ATE
	Biturbo 2000				01.82			13.0441-3303.2	250043				Dichtungssatz	ATE
	228				01.89			13.0441-3303.2	250043				Dichtungssatz	ATE
	Biturbo 222				01.88									
	Biturbo 420				01.85	12.87								
	Biturbo 425				01.85	12.87								
	Biturbo 430				01.89									
	Biturbo Karif				01.89									
	Biturbo Spider				01.89									
MAZDA 121 (87-91)														
	1.1 (DA1)	42			11.87	03.91		13.0460-5970.2	605970				21355 13,5 +/WK	SUM
	1.3 (DA1)				11.87	03.91		13.0460-0451.2	610451				Belagsatz-Zubehör	SUM
	1.1 (DA1)	42			11.87	03.91		24.0113-0165.1	413165				219 13,0 11,0	
	1.3 (DA1)				11.87	03.91								
	1.1 (DA1)	42			11.87	03.91		03.0137-0204.2	650204				170 x 25	
	1.3 (DA1)				11.87	03.91		03.0137-9113.2	669113				Bremsbacken-Zubehör	
MAZDA 121 (91-96)														
	1.3 16V (DB1)				04.91	02.96		13.0460-5944.2	605944				21654 15,0 +/WK	SUM
								13.0460-0339.2	610339				Belagsatz-Zubehör	SUM
	1.3 16V (DB1)				04.91	02.96	+ Schaltgetriebe ³⁾	24.0112-0147.1	412147				235 12,0 10,0	
	1.3 16V (DB1)				04.91	02.96	+ Automatikgetriebe ⁴⁾	24.0118-0113.1	418113				235 18,0 16,0 V + B	
	1.3 16V (DB1)				04.91	02.96		03.0137-0263.2	650263				180 x 31	
								03.0137-9186.2	669186				Bremsbacken-Zubehör	
MAZDA 323 Limousine (85-89)														
	1.1 (BF)				07.85	08.87		24.0101-5102.2	260056				Bremssattel-Zubehör	SUM
	1.3 (BF)				07.85	08.89								
	1.5 (BF)				07.85	08.89								
	1.6 i (BF)				07.85	08.89								
	1.6 i Turbo (BF)				07.85	08.89								
	1.6 i Turbo 4WD (BF)				07.85	08.89								
	1.7 D (BF)				07.85	08.89								
	1.1 (BF)				07.85	08.87		24.0118-0101.1	418101				238 18,0 16,0 V	
	1.3 (BF)				07.85	08.89								
	1.5 (BF)				07.85	08.89								
	1.6 i (BF)				07.85	08.89								
	1.7 D (BF)				07.85	08.89								
	1.6 i (BF)				07.85	08.89		13.0460-5824.2	605824				20008 13,0	AKE
	1.6 i Turbo (BF)				07.85	08.89								
	1.6 i Turbo 4WD (BF)				07.85	08.89								
	1.1 (BF)				07.85	08.87		24.3217-1703.3	020380				Rz 17,46	
	1.3 (BF)				07.85	08.89								
	1.5 (BF)				07.85	08.89								
	1.6 i (BF)				07.85	08.89								
	1.1 (BF)				07.85	08.87		24.0220-0029.1	480120				200/201 x 32	
	1.3 (BF)				07.85	08.89								
	1.5 (BF)				07.85	08.89								
	1.6 i (BF)				07.85	08.89								
	1.1 (BF)				07.85	08.87								
	1.3 (BF)				07.85	08.89								
	1.5 (BF)				07.85	08.89								
	1.6 i (BF)				07.85	08.89								
	1.7 D (BF)				07.85	08.89								
MAZDA 323 Limousine/323 F (89-94)														
	1.3 i (BG)				09.89	12.94		13.0460-5944.2	605944				21654 15,0 +/WK	SUM
	1.6 i (BG)				09.89	12.94		13.0460-0339.2	610339				Belagsatz-Zubehör	SUM
	1.7 D (BG)				09.89	12.94								
	1.8 i 16V (BG)				09.89	12.94	+ OHC							
	1.8 i 16V 4WD (BG)				09.89	12.94								

1) inner and outer thread / filettatura interna + esterno / taraud, intérieur + extérieur / rosca interior + exterior

2) 2x inner thread / 2x filettatura interna / 2x taraudage intérieur / 2x rosca interior

3) + manual transmission / + scatola cambio velocità / + transmission mécanique / + cambio de velocidad

4) + autom.transmission / + scatola cambio automatico / + transmission automatique / + cambio automático





MAZDA 323 Limousine/323 F (89-94)

	1.8 i 16V (BG) 1.8 i Turbo 4WD (BG)	120	09.89 09.89	12.94 + DOHC 12.94	13.0460-5974.2	605974		21539 15,0 +WK	SUM
	1.3 i (BG) 1.6 i (BG) 1.7 D (BG) 1.8 i 16V (BG)		09.89 09.89 09.89 09.89	12.94 + Schaltgetriebe ¹⁾ 12.94 + HA-Trommelbr./+Schaltgetriebe ²⁾ 12.94 + Schaltgetriebe ¹⁾ 12.94 + OHC/+HA-Trommelbr./+Schaltg. ³⁾	24.0118-0113.1	418113		235 18,0 16,0 V +B	
	1.3 i (BG) 1.6 i (BG) 1.6 i (BG) 1.8 i 16V (BG) 1.8 i 16V (BG)		09.89 09.89 09.89 09.89 09.89	12.94 + Automatikgetriebe ⁴⁾ 12.94 + Automatikgetriebe ⁴⁾ 12.94 + HA-Scheibenbr./+Schaltgetr. ⁵⁾ 12.94 + Automatikgetriebe ⁴⁾ 12.94 + OHC/+HA-Scheibenbr./+Schaltg. ⁶⁾	24.0122-0166.1	422166		235 22,0 20,0 V +B	
	1.8 i 16V (BG) 1.8 i Turbo 4WD (BG)	120	09.89 09.89	12.94 + DOHC 12.94	24.0122-0165.1	422165		257 22,0 20,0 V	
	1.6 i (BG) 1.8 i 16V (BG) 1.8 i 16V 4WD (BG) 1.8 i Turbo 4WD (BG)	120	09.89 09.89 09.89 09.89	12.94 12.94 12.94 12.94	13.0460-5972.2	605972		21559 11,5	
	1.6 i (BG) 1.8 i 16V (BG) 1.8 i 16V 4WD (BG)		09.89 09.89 09.89	12.94 12.94 + OHC 12.94	24.0109-0127.1	409127		231 9,0 8,0	
	1.8 i 16V (BG) 1.8 i Turbo 4WD (BG)	120	09.89 09.89	12.94 + DOHC 12.94	24.0109-0131.1	409131		251 9,0 8,0 +B	
	1.3 i (BG) 1.6 i (BG) 1.7 D (BG) 1.8 i 16V (BG)		09.89 09.89 09.89 09.89	12.94 12.94 12.94 12.94	24.3217-1120.3	020360		Rz 17,46	
	1.3 i (BG) 1.6 i (BG) 1.7 D (BG) 1.8 i 16V (BG)		09.89 09.89 09.89 09.89	12.94 12.94 12.94 12.94	03.0137-0239.2	650239	04.91	200 x 26 Bremsbacken-Zubehör	
	1.3 i (BG) 1.6 i (BG) 1.7 D (BG) 1.8 i 16V (BG)		05.91 05.91 05.91 05.91	12.94 12.94 12.94 12.94	03.0137-0278.2	650278		200 x 36 Bremsbacken-Zubehör	
	1.3 i (BG) 1.6 i (BG) 1.7 D (BG) 1.8 i 16V (BG)		05.91 05.91 05.91 05.91	12.94 12.94 12.94 12.94	24.0220-0026.1	480104		200/201 x 42	
	1.3 i (BG) 1.3 i (BG) 1.6 i (BG) 1.6 i (BG) 1.7 D (BG) 1.7 D (BG) 1.8 i 16V (BG) 1.8 i 16V (BG)		09.89 09.89 09.89 09.89 09.89 09.89 09.89 09.89	12.94 + HA-Trommelbremse/ + 4 türig ⁷⁾ 12.94 + HA-Trommelbremse/ + 5 türig ⁸⁾ 12.94 + HA-Trommelbremse/ + 4 türig ⁷⁾ 12.94 + HA-Trommelbremse/ + 5 türig ⁸⁾ 12.94 + HA-Trommelbremse/ + 4 türig ⁷⁾ 12.94 + HA-Trommelbremse/ + 5 türig ⁸⁾ 12.94 + HA-Trommelbremse/ + 4 türig ⁷⁾ 12.94 + HA-Trommelbremse/ + 5 türig ⁸⁾	24.3727-1811.2 24.3727-1810.2	581811 581810	<input type="checkbox"/> <input checked="" type="checkbox"/>	L=1503 L=1466	

MAZDA 323 Kombi (86-94)























	1.5 (BW) 1.6 i (BW) 1.6 i 4x4 (BW) 1.7 D (BW)		05.86 05.86 09.89 05.86	12.94 12.94 12.94 12.94	24.0101-5102.2	260056		Bremsattel-Zubehör	SUM
	1.5 (BW) 1.6 i (BW) 1.6 i 4x4 (BW) 1.7 D (BW)		05.86 05.86 09.89 05.86	12.94 12.94 12.94 12.94	24.0118-0101.1	418101		238 18,0 16,0 V	
	1.6 i 4x4 (BW)		09.89	12.94	13.0460-5824.2	605824		20008 13,0	AKE
	1.5 (BW) 1.6 i (BW) 1.7 D (BW)		05.86 05.86 05.86	12.94 12.94 12.94	24.3217-1703.3	020380		Rz 17,46	
	1.5 (BW) 1.6 i (BW) 1.7 D (BW)		05.86 05.86 05.86	12.94 12.94 12.94	03.0137-0184.2 03.0137-9102.2	650184 669102		229 x 26 Bremsbacken-Zubehör	

MAZDA 626 Limousine/Coupe (87-91)



























	1.6 (GD1) 1.8 (GD1) 2.0 (GD1) 2.0 (GD7) 2.0 D (GD1) 2.2 12V (GD1) 2.2 12V (GD7) 2.2 12V 4WD (GD1)		09.87 09.87 09.87 09.87 09.87 09.87 09.87 09.87	08.91 08.91 08.91 08.91 08.91 08.91 08.91 08.91	13.0460-5932.2 13.0460-0313.2	605932 610313		21378 15,0 +WK Belagsatz-Zubehör	AKE AKE
	2.0 (GD1) 2.0 (GD7) 2.2 12V (GD1) 2.2 12V (GD7) 2.2 12V 4WD (GD1)		09.87 09.87 09.87 09.87 09.87	08.91 08.91 08.91 08.91 08.91	24.0124-0105.1	424105		264 24,0 22,0 V	

¹⁾ + manual transmission / + scatola cambio velocità / + transmission mécanique / + cambio de velocidad
²⁾ + RA drum brake/+ manual transm. / + P fra tamburo/+ scatola camb.velocità / + fr.à tambour ess.AR/ + transm.mécan. / + ET-tamb.de freno/ + camb.de velocidad
³⁾ + OHC/+RA drum br./+manual transm. / + OHC/+P fra tamb./+scatola camb.veloc. / + OHC/+fr.tamb.ess.AR/+transm.mécan. / + OHC/ + ET-tamb.fr./ + camb.velocidad
⁴⁾ + autom.transmission / + scatola cambio automatico / + transmission automatique / + cambio automático
⁵⁾ + RA disc brake/+ manual transm. / + P disco freno/+ scatola camb.velocità / + fr.à disque ess.AR/ + transm.mécanique / + ET disco de freno/ + camb.velocidad
⁶⁾ + OHC/+RA disc br./+manual transm. / + OHC/+P disco fr. /+ scat.camb.velocità / + OHC/+fr.disqu.ess.AR/ + transm.mécan. / + OHC/ + ET-disco fr./ + camb.velocidad
⁷⁾ + RA drum brake/ + 4 door / + P freno a tamburo/ + 4 porte / + fr.à tambour essieu AR/ + 4 portes / + ET tambores de freno/ + 4 puertas
⁸⁾ + RA drum brake/ + 5 door / + P freno a tamburo/ + 5 porte / + fr.à tambour essieu AR/ + 5 portes / + ET tambores de freno/ + 5 puertas



								
MAZDA 626 Limousine/Coupe (87-91)								
	2.0 (GD7) 2.2 12V (GD7)			09.87 09.87	08.91 08.91	13.0460-5995.2	605995	21558 13,0
	2.0 (GD7)			09.87	08.91	24.0110-0181.1	410181	259 10,0 8,0
	1.6 (GD1) 1.8 (GD1) 2.0 (GD1) 2.0 D (GD1) 2.2 12V (GD1)			09.87 09.87 09.87 09.87 09.87	08.91 08.91 08.91 08.91 08.91	24.3217-1120.3	020360	Rz 17,46
	1.6 (GD1) 1.8 (GD1) 2.0 (GD1) 2.0 D (GD1) 2.2 12V (GD1)			09.87 09.87 09.87 09.87 09.87	08.91 08.91 08.91 08.91 08.91	03.0137-0185.2 03.0137-9103.2	650185 669103	229 x 32 Bremsbacken-Zubehör
	2.0 (GD1) 2.2 12V (GD1)			09.87 09.87	08.91 08.91	24.0222-8028.1	480143	ohne Sensorring ¹⁾ 229/230 x 36,5
	1.6 (GD1) 1.8 (GD1) 2.0 (GD1) 2.0 (GD7) 2.0 D (GD1) 2.2 12V (GD1) 2.2 12V (GD7)			09.87 09.87 09.87 09.87 09.87 09.87 09.87	08.91 08.91 08.91 08.91 08.91 08.91 08.91	24.3727-1812.2	581812	↑ L=252
MAZDA 626 (GE) (91-97)								
	1.8 i 2.0 D GLX 2.0 i 2.0 i 4WD 2.5 i V6	77 55 85 85 121		08.91 01.92 08.91 04.92 09.91	04.94 04.94 04.94 04.94 04.94	24.3571-1703.5 24.3571-1704.5 24.0101-5701.2	240099 240100 260065	<input type="checkbox"/> <input type="checkbox"/> D=57, - Halter D=57, - Halter Bremsattel-Zubehör AKE AKE AKE
	1.8 i 1.8 i 1.8 i 2.0 D 2.0 D GLX 2.0 i 2.0 i 4WD 2.5 i V6	66 77 78 56 55 85 85 121		08.94 08.91 05.94 05.94 10.92 08.91 04.92 09.91	04.97 04.97 06.97 06.97 04.97 04.97 04.97 04.97	13.0460-5954.2 13.0460-0443.2	605954 610443	23845 15,8 +WK/Zub Belagsatz-Zubehör SUM SUM
	1.8 i 1.8 i 1.8 i 2.0 D 2.0 D GLX 2.0 i 2.0 i 4WD 2.5 i V6	66 77 78 56 55 85 85 121		08.94 08.91 05.94 05.94 10.92 08.91 04.92 01.92	04.97 04.97 06.97 06.97 04.97 04.97 04.97 04.97	24.0124-0129.1	424129	258 24,0 22,0 V +B
	1.8 i 2.0 D GLX 2.0 i 2.5 i V6	77 55 85 121		08.91 10.92 08.91 01.92	04.94 04.94 04.94 04.94	24.0101-3001.2	260039	Bremsattel-Zubehör AKE
	1.8 i 1.8 i 1.8 i 2.0 D 2.0 D GLX 2.0 i 2.5 i V6	66 77 78 56 55 85 121		08.94 08.91 05.94 05.94 10.92 08.91 01.92	04.97 04.97 06.97 06.97 04.97 04.97 04.97	13.0460-5973.2 13.0460-0245.2	605973 610245	21766 13,5 Belagsatz-Zubehör
	1.8 i 1.8 i 1.8 i 2.0 D 2.0 D GLX 2.0 i 2.0 i 4WD 2.5 i V6	66 77 78 56 55 85 85 121		08.94 08.91 05.94 05.94 10.92 08.91 04.92 01.92	04.97 04.97 06.97 06.97 04.97 04.97 04.97 04.97	24.0110-0234.1	410234	261 10,0 8,0 +B
	1.8 i 1.8 i 1.8 i 2.0 D 2.0 D GLX 2.0 i 2.5 i V6	66 77 78 56 55 85 121		08.94 08.91 05.94 05.94 10.92 08.91 01.92	04.97 04.97 06.97 06.97 04.97 04.97 04.97	24.3727-1812.2 24.3727-1809.2 24.3727-1808.2	581812 581809 581808	↑ <input type="checkbox"/> <input type="checkbox"/> L=252 L=1657 L=1657
MAZDA 626 Kombi (88-92)								
	1.8 (GV1) 2.0 (GV1) 2.0 D (GV1) 2.2 12V (GV1) 2.2 12V 4WD (GV8)	72 44 85 85		03.88 03.88 03.88 03.88 03.92	02.92 02.92 07.91 10.90 11.92	13.0460-5932.2 13.0460-0313.2	605932 610313	21378 15,0 +WK Belagsatz-Zubehör AKE AKE

¹⁾ without sensor ring / senza sensori / sans secours ABS / sin anillo sensor ABS

								
MAZDA 626 Kombi (88-92)								
	1.8 (GV1) 2.0 (GV1) 2.0 D (GV1) 2.2 12V (GV1) 2.2 12V 4WD (GV8)	72 44 85 85	03.88 03.88 03.88 03.88 03.92	02.92 02.92 07.91 10.90 11.92	24.0124-0105.1	424105		264 24,0 22,0 V
	1.8 (GV1) 2.0 (GV1) 2.0 D (GV1) 2.2 12V (GV1)	72 44 85	03.88 03.88 03.88 03.88	02.92 02.92 07.91 10.90	13.0460-5995.2	605995		21558 13,0
	1.8 (GV1) 2.0 (GV1) 2.0 D (GV1) 2.2 12V (GV1)	72 44 85	03.88 03.88 03.88 03.88	02.92 02.92 07.91 10.90	24.0110-0256.1	410256		259 10,0 8,0
	1.8 (GV1) 2.0 (GV1) 2.0 D (GV1) 2.2 12V (GV1)	72 44 85	03.88 03.88 03.88 03.88	02.92 02.92 07.91 10.90	24.3727-1812.2	581812	↑	L=252
MAZDA 929 (87-91)								
	2.0 i (HC1) 2.2 i (HC1) 3.0 i V6 (HC1)		05.87 05.87 05.87	12.88 06.91 11.91	13.0460-5625.2	605625		21319 14,9 +/-WK
MAZDA E1400/E1800/E2000/E2200 Bus (84-87)								
	1.4 1.8 2.0 2.0 4WD 2.2 D		01.84 01.84 01.84 01.84 01.84	11.87 11.87 11.87 11.87 11.87	13.0460-5806.2	605806		20002 15,0 +/-WK
MAZDA E1800/E2000/E2200 Kasten (84-87)								
	1.8 2.0 2.2 D		01.84 01.84 01.84	11.87 11.87 11.87	13.0460-5806.2	605806		20002 15,0 +/-WK
MAZDA E1800/E2000/E2200 Pritsche (84-87)								
	2.0 2.2 D		01.84 01.84	11.87 11.87	13.0460-5806.2	605806		20002 15,0 +/-WK
MAZDA E2000/E2200 Bus (87-97)								
	2.0 2.0 4WD 2.2 D 2.2 D 4WD		12.87 12.87 12.87 12.87	03.97 03.97 03.97 03.97	13.0460-5806.2	605806		20002 15,0 +/-WK
	2.0 2.0 4WD 2.2 D 2.2 D 4WD		12.87 12.87 12.87 12.87	03.97 03.97 03.97 03.97	03.0137-0486.2	650486		260 x 51
MAZDA E2000/E2200 Kasten (87-97)								
	2.0 2.2 D		12.87 12.87	03.97 03.97	13.0460-5806.2	605806		20002 15,0 +/-WK
	2.0 2.2 D		12.87 12.87	03.97 03.97	03.0137-0486.2	650486		260 x 51
MAZDA E2000/E2200 Pritsche (87-97)								
	2.0 2.2 D		12.87 12.87	03.97 03.97	13.0460-5806.2	605806		20002 15,0 +/-WK
	2.0 2.2 D		12.87 12.87	03.97 + Einfachbereifung ¹⁾ 03.97 + Einfachbereifung ¹⁾	03.0137-0486.2	650486		260 x 51
MAZDA MX-6 (91-97)								
	2.0 (GE1) 2.5 V6 (GE1/GE7) 2.5 V6 (GE1/GE7) 2.5 V6 (GE1/GE7)	85 120 121 123	07.91 08.94 07.91 02.93	08.97 08.97 08.97 08.97	24.3571-1703.5 24.3571-1704.5 24.0101-5701.2	240099 240100 260065	<input type="checkbox"/> <input type="checkbox"/>	D=57, - Halter AKE D=57, - Halter AKE Bremsattel-Zubehör AKE
	2.0 (GE1) 2.5 V6 (GE1/GE7) 2.5 V6 (GE1/GE7) 2.5 V6 (GE1/GE7)	85 120 121 123	07.91 08.94 07.91 02.93	08.97 08.97 08.97 08.97	13.0460-5954.2 13.0460-0443.2	605954 610443		23845 15,8 +/-WK/Zub SUM Belagsatz-Zubehör SUM
	2.0 (GE1) 2.5 V6 (GE1/GE7) 2.5 V6 (GE1/GE7) 2.5 V6 (GE1/GE7)	85 120 121 123	07.91 08.94 07.91 02.93	08.97 08.97 08.97 08.97	24.0124-0129.1	424129		258 24,0 22,0 V +B
	2.0 (GE1) 2.5 V6 (GE1/GE7) 2.5 V6 (GE1/GE7) 2.5 V6 (GE1/GE7)	85 120 121 123	07.91 08.94 07.91 02.93	08.97 08.97 08.97 08.97	24.0101-3001.2	260039		Bremsattel-Zubehör AKE

¹⁾ + single tyre / + ruota singola / + roue simple / + cubierta simple



MAZDA MX-6 (91-97)

	2.0 (GE1) 2.5 V6 (GE1/GE7) 2.5 V6 (GE1/GE7) 2.5 V6 (GE1/GE7)	85 120 121 123		07.91 08.94 07.91 02.93	08.86 08.97 08.97 08.97	13.0460-5973.2 13.0460-0245.2	605973 610245		21766 13,5 Belagsatz-Zubehör
	2.0 (GE1) 2.5 V6 (GE1/GE7) 2.5 V6 (GE1/GE7) 2.5 V6 (GE1/GE7)	85 120 121 123		07.91 08.94 07.91 02.93	08.97 08.97 08.97 08.97	24.0110-0234.1	410234		261 10,0 8,0 +B
	2.0 (GE1) 2.5 V6 (GE1/GE7) 2.5 V6 (GE1/GE7) 2.5 V6 (GE1/GE7)	85 120 121 123		07.91 08.94 07.91 02.93	08.97 08.97 08.97 08.97	24.3727-1812.2 24.3727-1809.2 24.3727-1808.2	581812 581809 581808		L=252 L=1657 L=1657

MERCEDES BENZ Ansteuerung für Druckluftbremsventil

	1013 1017 1017 LS 1019 1113 1213 1217 1219 1413 1417 1419 1424 1613 1617 1619 1624 1626 1628 1632 1719 1919 1926 1928 1932 2026 2028 2032 2219 2224 2226 6x2 2228 6x2 2232 6x2 2626 6x4 2628 6x4 2632 6x4			01.76 01.76 01.77 01.78 01.78 01.76 01.76 01.76 01.75 01.75 01.75 01.75 01.75 01.75 01.75 01.73 01.79 01.73 01.73 01.73 01.73 01.73 01.79 01.73 01.73 01.76 01.79 01.76 01.79 01.76 01.79 01.76 01.79 01.73 01.73 01.73 01.79 01.79 01.76 01.73 01.73 01.73 01.73 01.73 01.73 01.73	12.86 12.86 12.86 12.85 12.85 12.85 12.85 12.85 12.85 12.85 12.83 12.85 12.83 12.85 12.83 12.80 12.89 12.82 12.81 12.89 12.89 12.82 12.80 12.89 12.83 12.83 12.81 12.89 12.81 12.81 12.83 12.83 12.81 12.81 12.81 12.83 12.90 12.89	24.3526-1900.0	340038	2	Bremslichtschalter
	1626 1628 1632 1719 1919 1926 1928 1932 2026 2028 2032 2219 6x4 2224 6x4 2226 6x2 2228 6x2 2232 6x2 2626 6x4 2628 6x4 2632 6x4	4628862 4628862		01.73 01.79 01.73 01.73 01.73 01.73 01.73 01.73 01.76 01.79 01.76 01.79 01.73 01.73 01.73 01.73 01.79 01.79 01.76 01.73 01.73 01.73 01.73 01.73 01.73 01.73 01.73 01.73 01.73 01.73 01.73	12.80 12.89 12.82 12.81 12.80 12.80 12.89 12.82 12.81 12.89 12.83 12.83 12.81 12.89 12.81 12.83 12.83 12.90 12.89	03.2524-0400.3	040024		Nz 24,00
	1013 1017 1017 LS 1019 1113 1213 1217 1219 1413 1417 1419 1424 1613 1617 1619 1624 1626 1628 1632			01.76 01.76 01.77 01.78 01.78 01.76 01.76 01.76 01.75 01.75 01.75 01.75 01.75 01.75 01.75 01.75 01.73 01.79 01.73 01.73 01.73 01.73 01.73 01.73 01.73 01.73 01.73 01.73 01.73 01.73	12.86 12.86 12.86 12.85 12.85 12.85 12.85 12.85 12.85 12.85 12.83 12.83 12.85 12.85 12.83 12.83 12.80 12.89 12.82 12.81 12.81 12.81 12.83 12.83 12.81 12.81 12.83 12.83 12.81 12.81 12.81 12.83 12.83	24.5901-0517.3	330054		L=517

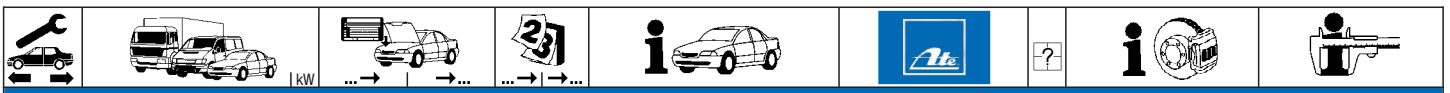

MERCEDES BENZ Ansteuerung für Druckluftbremsventil

	1719			01.73	12.81	24.5901-0517.3	330054			L=517
	1919			01.73	12.80					
	1926			01.73	12.80					
	1928			01.79	12.89					
	1932			01.73	12.82					
	2026			01.76	12.81					
	2028			01.79	12.89					
	2032			01.76	12.83					
	2219			01.76	12.83					
	2224			01.69	12.83					
	2226 6x2			01.73	12.81					
	2228 6x2			01.79	12.89					
	2232 6x2			01.73	12.81					
	2626 6x4			01.73	12.83					
	2628 6x4			01.79	12.90					
	2632 6x4			01.73	12.89					

MERCEDES BENZ BUS (BM 300/301) O 303

	9/10-Reiher	004126				03.3134-0300.3	010308	2		Hz 34,92	ATE						
	11-Reiher	002061	003138			03.3134-0300.3	010308		+ Hinterachse ¹⁾	Hz 34,92	ATE						
	11-Reiher	003139				03.3134-0300.3	010308	2	+ Vorderachse ²⁾	Hz Reparatursatz	ATE						
	10-Reiher		001078	01.75		83.6133-0500.3	330272			L=500							
	11-Reiher		001078	01.75													
	9-Reiher		001431	01.75													
	10-Reiher	001079										83.6103-0320.3	330224			L=320	
	9-Reiher	001432															
	11-Reiher	001079										83.6103-0320.3	330224			L=320	
	11-Reiher		001078	01.75		83.6103-0450.3	330228			L=450							
	9/10-Reiher			01.75													
	11-Reiher	001079	002060									83.6103-0450.3	330228		▣	L=450	
	11-Reiher											83.6133-0500.3	330272			L=500	
	11-Reiher	002061	003138									83.6103-0320.3	330224		▣	L=320	
	11-Reiher											83.6133-0500.3	330272			L=500	
	11-Reiher	003139										83.6103-0450.3	330228		▣	L=450	
	11-Reiher											83.6133-0500.3	330272			L=500	
	9-15 - Reiher			01.75		03.2538-0104.3	040035			Nz 38,10							
						03.0450-3801.2	083801			Nz Reparatursatz							

MERCEDES BENZ BUS (BM 302) O 302

	10/11-Reiher			01.65	12.75	83.6103-0450.3	330228			L=450	
	12-Reiher			01.65	12.75	83.6103-0400.3	330226		▣	L=400	
	10/11-Reiher			01.65	12.75	83.6103-0450.3	330228			L=450	
	12-Reiher			01.65	12.75						

MERCEDES BENZ BUS (BM 307) O 307

	0 307			04.73		03.2538-0104.3	040035			Nz 38,10	
						03.0450-3801.2	083801			Nz Reparatursatz	

MERCEDES BENZ BUS (BM 309/310) O 309

	2.2 - 60 PS	018154			12.74	03.2122-4902.3	010144			THz 22,20	ATE					
	2.2 - 85 PS	018154														
	2.3 - 90 PS			01.75												
	2.4 - 65 PS		530029	01.75								+ Radstand 4100mm ³⁾				
	3.8 - 85 PS	018154										- Radstand 4100mm ⁴⁾				
	3.8 - 85 PS	018154										+ Radstand 4100mm ³⁾				
5.7 - 130 PS	530030	352290	01.77		03.2125-1302.3	010203			THz 25,40	ATE						
	2.2 - 60 PS		018153	01.67		03.3508-0264.3	310009			Behälter						
	2.2 - 85 PS		018153	01.67												
	3.8 - 85 PS		018153	01.69								- Radstand 4100mm ⁴⁾				
	2.2 - 60 PS			01.67	12.74	83.6133-0500.3	330272			L=500						
	2.2 - 85 PS			01.67												
	2.3 - 90 PS			01.75												
	2.4 - 65 PS			01.75												
	3.8 - 85 PS			01.69												
	5.7 - 130 PS			01.77												
	2.2 - 60 PS	000901			12.74	03.3222-5804.3	020083			Rz 22,20						
	2.2 - 85 PS	000181														
	2.3 - 90 PS			01.75												
	2.4 - 65 PS			01.75												
	3.8 - 85 PS			01.69								- Radstand 4100mm ⁴⁾				
	3.8 - 85 PS			01.73								+ Radstand 4100mm ³⁾	03.3222-5804.3	020083	- VA 730.505/506 ⁵⁾	Rz 22,20
													24.3223-1705.3	020418	+ VA 730.505/506 ⁶⁾	Rz 23,81
	3.8 - 85 PS			01.78								+ breite Ausführung ⁷⁾	24.3238-0901.3	020298		Rz 38,10
5.7 - 130 PS			01.77		24.3223-1705.3	020418		Rz 23,81								

1) + rear axle / + asse posteriore / + essieu arrière / + eje trasero
 2) + front axle / + asse anteriore / + essieu avant / + eje delantero
 3) + wheel base 4100 mm / + passo 4100 mm / + empattement 4100 mm / + distancia entre ejes 4100 mm
 4) - wheel base 4100mm / - passo 4100mm / - empattement 4100mm / - distancia entre ejes 4100mm
 5) - FA 730.505/506 / - A 730.505/506 / - ess. AV 730.505/506 / - ED 730.505/506
 6) + FA 730.505/506 / + A 730.505/506 / + ess. AV 730.505/506 / + ED 730.505/506
 7) + wide design / + versione larga / + version large / + variante ancha



MERCEDES BENZ BUS (BM 309/310) O 309

	2.2 - 60 PS 2.2 - 85 PS 2.3 - 90 PS 2.4 - 65 PS 3.8 - 85 PS 5.7 - 130 PS			01.67 01.67 01.75 01.75 01.69 01.77	12.74		83.6103-0450.3	330228			L=450
	2.2 - 60 PS 2.2 - 85 PS 2.3 - 90 PS 2.4 - 65 PS 3.8 - 85 PS	000901 000181		01.75 01.75 01.69	12.74		03.3222-5804.3	020083			Rz 22,20
	3.8 - 85 PS			01.73	- Radstand 4100mm ¹⁾ + Radstand 4100mm ²⁾		03.3222-5804.3 24.3223-1705.3	020083 020418		- HA 741.203/302 ³⁾ + HA 741.203/302 ⁴⁾	Rz 22,20 Rz 23,81
	3.8 - 85 PS			01.78	+ breite Ausführung ⁵⁾		24.3238-0901.3	020298			Rz 38,10
	5.7 - 130 PS			01.77			24.3223-1705.3	020418			Rz 23,81

MERCEDES BENZ BUS (BM 319) O 319

	O 319			01.55	12.67		83.6103-0450.3	330228			L=450
	O 319			01.55	12.67		83.6103-0450.3	330228			L=450

MERCEDES BENZ BUS (BM 321) O 321

	O 321			01.54	12.58		03.0370-1131.2	051131			Hz Reparatursatz
	O 321			01.59	12.64	+ 1-Kreis-Bremse ⁶⁾	03.0370-1131.2	051131			Hz Reparatursatz
	O 321			01.62	12.64	+ 2-Kreis-Bremse ⁷⁾	03.3318-0800.2	390112	2	im Anschlußkopf ⁸⁾	Bodenventil
	O 321			01.59	12.64	+ 1-Kreis-Bremse ⁶⁾	03.3508-0501.3	310017		0,35 l	Behälter
	O 321			01.54	12.64		83.6123-0381.3	330262			L=380
	O 321			01.54	12.64		83.6103-0400.3 83.6103-0500.3	330226 330230		■	L=400 L=500

MERCEDES BENZ BUS (BM 322) O 322

	O 322			01.59	12.64		03.0370-1131.2	051131			Hz Reparatursatz	
	O 322			01.62	12.63		03.3134-0300.3 03.0370-1038.2 03.0370-9998.2	010308 051038 059998		Ersatz für Hz 38,10 ⁹⁾ + Hz 38,10 ¹⁰⁾ + Hz 38,10 ¹⁰⁾	Hz 34,92 Hz Reparatursatz Hz Rep. Satz, -Kolben	ATE ATE
	O 322			01.59	12.64		03.3508-0501.3	310017		+ Hz 31,75/ 0,35 l ¹¹⁾	Behälter	
	O 322			01.64			03.3508-0401.3	310014			Behälter	
	O 322			01.59			83.6103-0450.3	330228			L=450	
	O 322			01.59			83.6103-0550.3	330231			L=550	
	O 322			01.59			83.6123-0381.3 83.6103-0400.3	330262 330226		■	L=380 L=400	
	O 322			01.59			83.6103-0500.3	330230			L=500	

MERCEDES BENZ BUS (BM 352) OF 1313/1317/1413/1417

	OF 1313 OF 1317 OF 1413 OF 1417			01.68 01.68 01.68 01.68	12.69 12.69 12.69 12.69		03.3508-0264.3	310009			Behälter
	OF 1313 OF 1317 OF 1413 OF 1417			01.68 01.68 01.68 01.68	12.69 12.69 12.69 12.69		83.6133-0551.3	330273			L=550

MERCEDES BENZ BUS (BM 358) OF 1113 B

	OF 1113 B	4487194		01.68			03.3508-0264.3	310009			Behälter
	OF 1113 B	4487195			12.69		03.3509-0100.3	310057			Behälter
	OF 1113 B			01.68	12.69		83.6133-0551.3	330273			L=550
	OF 1113 B	4134171			12.69		83.6133-0651.3	330274			L=650

MERCEDES BENZ LKW (BM 314) 608/709

	LP 608	4282707		01.65			03.3508-0264.3	310009			Behälter
	LP 608 LP 709 LPL 608 LPL 709 LPO 608			01.65 01.78 01.76 01.78 01.65	12.78 12.78 12.78 12.78 12.78		83.6133-0551.3	330273			L=550

¹⁾ - wheel base 4100mm / - passo 4100mm / - empattement 4100mm / - distancia entre ejes 4100mm

²⁾ - wheel base 4100 mm / + passo 4100 mm / + empattement 4100 mm / + distancia entre ejes 4100 mm

³⁾ - RA 741.203/302 / - P 741.203/302 / - ess. AR 741.203/302 / - ET 741.203/302

⁴⁾ - RA 741.203/302 / + P 741.203/302 / + ess. AR 741.203/302 / + ET 741.203/302

⁵⁾ + wide design / + versione larga / + version large / + variante ancha

⁶⁾ + single circuit brake / + impianto freni circuito singolo / + frein à 1 circuit / + freno de 1 circuito

⁷⁾ + two circuit brake / + impianto frenante doppio circuito / + frein à deux circuits / + freno de 2 circuitos

⁸⁾ in connection head / nella testa di collegamento / dans tête de raccordement / en culata de conexión

⁹⁾ replacement for MC 38,10 / ricambio per PF 38,10 / remplacement pour MC 38,10

¹⁰⁾ + MC 38,10 / + PF 38,10 / + MC 38,10 / + CM 38,10

¹¹⁾ + MC 31,75/ 0,35 l / + PF 31,75/ 0,35 l / + MC 31,75/ 0,35 l / + CM 31,75/ 0,35 l





MERCEDES BENZ LKW (BM 314) 608/709

	LPO 709 LPS 608		01.78 01.65	12.78	BM 314.062	83.6133-0551.3	330273		L=550
	LP 608 LP 709 LPL 608 LPL 709 LPO 608 LPO 709 LPS 608		01.65 01.78 01.76 01.78 01.65 01.78 01.65	12.78 12.78 12.78 12.78	BM 314.062	83.6133-0500.3	330272		L=500
	LP 608 LP 709 LPL 608 LPL 709		01.65 01.78 01.76 01.78	12.78 12.78		24.2419-0937.3	030063		Gz 19,05 FTE
	LP 608 LP 709 LPL 608 LPL 709		01.65 01.78 01.76 01.78	12.78 12.78		03.0450-2805.2	082805		Nz Reparatursatz

MERCEDES BENZ LKW (BM 316) 808/809

	LP 808	4282707	01.67			03.3508-0264.3	310009	separater Behälter ¹⁾	Behälter
	LP 808 LP 809 LPL 808 LPL 809 LPO 808 LPO 809		01.67 01.78 01.76 01.78 01.67 01.78	12.78 12.78		83.6133-0551.3	330273		L=550
	LP 808 LP 809 LPL 808 LPL 809 LPO 808 LPO 809		01.67 01.78 01.76 01.78 01.67 01.78	12.78 12.78		03.3241-1801.3 03.0403-0341.2	020130 060031	+ Druckbolzen ²⁾ + Rz mit schrägem Anschluß ³⁾	Rz 41,27 Rz Reparatursatz
	LP 808 LP 809 LPL 808 LPL 809 LPO 808 LPO 809		01.67 01.78 01.76 01.78 01.67 01.78	12.78 12.78		83.6133-0500.3	330272		L=500
	LP 808 LP 809 LPL 808 LPL 809 LPO 808 LPO 809		01.67 01.78 01.76 01.78 01.67 01.78	12.78 12.78		03.3241-1801.3 03.0403-0341.2	020130 060031	+ Druckbolzen ²⁾ + Rz mit schrägem Anschluß ³⁾	Rz 41,27 Rz Reparatursatz
	LP 808 LP 809 LPL 808 LPL 809		01.67 01.78 01.76 01.78	12.78 12.78		24.2419-0937.3	030063		Gz 19,05 FTE
	LP 808 LP 809 LPL 808 LPL 809		01.67 01.78 01.76 01.78	12.78 12.78		03.0450-2805.2	082805		Nz Reparatursatz

MERCEDES BENZ LKW (BM 318) 811-1113















	LP 811 LP 813 LP 913	4282707 4282707 4282707	01.71 01.71 01.71			03.3508-0264.3	310009		Behälter
	LP 1013 LP 811 LP 813 LP 913 LPL 1013 LPL 813 LPL 913 LPO 811 LPO 813		01.76 01.71 01.71 01.71 01.77 01.76 01.77 01.71 01.71	12.78		83.6133-0551.3	330273		L=550
	LP 1013 LP 811 LP 813 LP 913 LPL 1013 LPL 813 LPL 913 LPO 811 LPO 813		01.76 01.71 01.71 01.71 01.77 01.76 01.77 01.71 01.71	12.78	- VA 730.705 ⁴⁾ - VA 730.705 ⁴⁾ - VA 730.705 ⁴⁾ - VA 730.705 ⁴⁾ - VA 730.705 ⁴⁾ - VA 730.705 ⁴⁾ - VA 730.705 ⁴⁾	03.3241-1801.3 03.0403-0341.2	020130 060031	+ Druckbolzen ²⁾ + Rz mit schrägem Anschluß ³⁾	Rz 41,27 Rz Reparatursatz
	LP 1013 LP 811 LP 813 LP 913 LPL 1013 LPL 813 LPL 913		01.76 01.71 01.71 01.71 01.77 01.76 01.77	12.78		83.6133-0500.3	330272		L=500

¹⁾ separate reservoir / serbatoio separato / réservoir séparé / depósito independiente

²⁾ + tappet / + punteria / + boulon de pression / + perno de presión

³⁾ + WC with vertical connection / + CR con attacco verticale / + CR avec raccord oblique / + CR con conexión oblicua

⁴⁾ - FA 730.705 / - A 730.705 / - ess. AV 730.705 / - ED 730.705

MERCEDES BENZ LKW (BM 318) 811-1113									
	LPO 811 LPO 813		01.71 01.71	12.78		83.6133-0500.3	330272		L=500
	LP 1113 LPL 1113		01.78 01.78			83.6103-0500.3	330230		L=500
	LP 1013 LP 811 LP 813 LP 913 LPL 1013 LPL 813 LPL 913 LPO 811 LPO 813		01.76 01.71 01.71 01.71 01.77 01.76 01.77 01.71 01.71	12.78	- HA 730.310/311 ¹⁾ - HA 730.310/311 ¹⁾ - HA 730.310/311 ¹⁾ - HA 730.310/311 ¹⁾ - HA 730.310/311 ¹⁾ - HA 730.310/311 ¹⁾	03.3241-1801.3 03.0403-0341.2	020130 060031	+ Druckbolzen ²⁾ + Rz mit schrägem Anschluß ³⁾	Rz 41,27 Rz Reparatursatz
	LP 1013 LP 1113 LP 811 LP 813 LP 913 LPL 1013 LPL 1113 LPL 813 LPL 913		01.76 01.78 01.71 01.71 01.71 01.77 01.78 01.76 01.77	12.78		24.2419-0937.3	030063		Gz 19,05 FTE
	LP 1013 LP 1113 LP 811 LP 813 LP 913 LPL 1013 LPL 1113 LPL 813 LPL 913		01.76 01.78 01.71 01.71 01.71 01.77 01.78 01.76 01.77	12.78		03.0450-2805.2	082805		Nz Reparatursatz
MERCEDES BENZ LKW (BM 323) 710									
	L 710 LA 710		01.63 01.63	12.69	+ 1-Kreis-Bremse ⁴⁾ + 1-Kreis-Bremse ⁴⁾	03.0370-1131.2	051131		Hz Reparatursatz
	L 710 LA 710		01.63 01.63	12.69	+ 2-Kreis-Bremse ⁵⁾ + 2-Kreis-Bremse ⁵⁾	03.3318-0800.2	390112	2	im Anschlußkopf ⁶⁾ Behälter
	L 710 LA 710		01.63 01.63	12.69		03.3508-0501.3	310017	0,35 l	Behälter
	L 710 LA 710	011912	01.63 01.63	12.69		83.6133-0551.3 83.6133-0651.3	330273 330274		L=550 L=650
	L 710 LA 710		01.63 01.63	12.69		83.6133-0500.3 83.6133-0651.3	330272 330274		L=500 L=650
MERCEDES BENZ LKW (BM 328) 911									
	L 911 LA 911	027672	01.63 01.63	12.68	+ 1-Kreis-Bremse / - 1-Kreis-Bremse ⁷⁾	03.0370-1131.2	051131		Hz Reparatursatz
	L 911 LA 911	027673	01.63 01.63	12.68	+ 1-Kreis-Bremse / - 1-Kreis-Bremse ⁷⁾	03.0370-1038.2 03.0370-9998.2	051038 059998		Hz Reparatursatz Hz Rep. Satz, -Kolben ATE
	L 911 LA 911	027672	01.63 01.63	12.68	+ 2-Kreis-Bremse ⁵⁾ + 2-Kreis-Bremse ⁵⁾	03.3318-0800.2	390112	2	im Anschlußkopf ⁶⁾ Behälter
	L 911 LA 911	027672	01.63 01.63	12.68	+ 1-Kreis-Bremse / - 1-Kreis-Bremse ⁷⁾	03.3508-0501.3	310017	0,35 l	Behälter
	L 911		01.63	12.68		83.6133-0551.3	330273		L=550
	L 911 LA 911		01.63 01.63	12.68		83.6133-0500.3 83.6133-0651.3	330272 330274		L=500 L=650
MERCEDES BENZ LKW (BM 338) 1418									
	1418 L 1418 LK 1418 LP 1418 LPS 1418 LS	002072 002072 000785 000785 002072	01.60 01.60 01.60 01.60 01.60			03.0370-1131.2	051131		Hz Reparatursatz
	1418 L 1418 LK 1418 LP 1418 LPS 1418 LS	002073 002073 000786 000786 002073		12.72 12.72 12.72 12.72 12.72		03.3134-0300.3	010308		Hz 34,92 ATE
	1418 L 1418 LK 1418 LP 1418 LPS 1418 LS		01.60 01.60 01.60 01.60 01.60	12.72 12.72 12.72 12.72 12.72		03.3508-0501.3	310017	0,35 l	Behälter

1) - RA 730.310/311 / - P 730.310/311 / - ess. AR 730.310/311 / - ET 730.310/311

2) + tappet / + punteria / + boulon de pression / + perno de presión

3) + WC with vertical connection / + CR con attacco verticale / + CR avec raccord oblique / + CR con conexión oblicua

4) + single circuit brake / + impianto freni circuito singolo / + frein à 1 circuit / + freno de 1 circuito

5) + two circuit brake / + impianto frenante doppio circuito / + frein à deux circuits / + freno de 2 circuitos

6) in connection head / nella testa di collegamento / dans tête de raccordement / en culata de conexión

7) + single circuit brake / - 1-Kreis-Bremse / - 1-Kreis-Bremse / + frein à 1 circuit / - 1-Kreis-Bremse / + freno de 1 circuito / - 1-Kreis-Bremse



MERCEDES BENZ LKW (BM 338) 1418

	1418 L		01.60	12.72	83.6133-0500.3	330272		L=500
	1418 LK		01.60	12.72				
	1418 LP		01.60	12.72	+ Radstand 3700mm ¹⁾	83.6133-0551.3	330273	L=550
	1418 LP	000785	01.60		+ Radstand 4200/5000mm ²⁾	83.6133-0500.3	330272	L=500
	1418 LP	000786	001207		+ Radstand 4200/5000mm ²⁾	83.6133-0551.3	330273	L=550
	1418 LP	001208		12.72	+ Radstand 4200/5000mm ²⁾	83.6133-0500.3	330272	L=500
	1418 LPS		001235	01.60		83.6133-0551.3	330273	L=550
	1418 LS	003366		12.72		83.6133-0551.3	330273	L=550

MERCEDES BENZ LKW (BM 352) 1213/1216/1313/1317/1319/1813

	1813 L 6x2		01.68	12.71	03.3138-2001.3	010310	+ Vorderachse + 2. HA ³⁾	Hz 38,10	ATE
	1813 L 6x4		01.68	12.71	03.0370-1038.2	051038	+ Vorderachse + 2. HA ³⁾	Hz Reparatursatz	ATE
	1213 LP		01.65	12.67	03.3508-0401.3	310014	0,13 l im Fahrerhaus ⁴⁾	Behälter	Behälter
	1216 LP		01.66	12.67	03.3508-0264.3	310009			
	1216 LPS		01.66	12.67					
	1313 L		01.67						
	1313 LA		01.67						
	1313 LAKO		01.67						
	1313 LP		01.67	12.76					
	1317 LP		01.67	12.70					
	1317 LPS		01.67	12.70					
	1319 LP		01.70	12.76					
	1319 LPS		01.70	12.76					
		1813 L 6x2		01.68	12.71	03.3508-0401.3	310014	+ 1. Hinterachse ⁵⁾	Behälter
1813 L 6x4			01.68	12.71	03.3508-0801.3	310023	+ Vorderachse + 2. HA ³⁾		
	1213 LP		01.65	12.67	83.6133-0551.3	330273		L=550	
	1216 LP		01.66	12.67					
	1216 LPS		01.66	12.67					
	1313 L		01.67						
	1313 LP		01.67	12.76					
	1317 LP		01.67	12.70					
	1317 LPS		01.67	12.70					
	1319 LP		01.70	12.76					
	1319 LPS		01.70	12.76					
	1313 LA		01.67		83.6103-0600.3	330233		L=600	
	1313 LAKO		01.67						
	1813 L 6x2		01.68	12.71	83.6133-0551.3	330273		L=550	
	1813 L 6x4		01.68	12.71					
	1317 LPS		01.67	12.70	+ BM 352.086	83.6103-0600.3	330233	L=600	
	1319 LPS		01.70	12.76	+ BM 352.086				
	1313 LA		01.67		83.6133-0651.3	330274		L=650	
	1313 LAKO		01.67						
	1813 L 6x2		01.68	12.71					
	1813 L 6x4		01.68	12.71					

MERCEDES BENZ LKW (BM 353) 810/911 B

	L 911 B		01.68		03.3138-2001.3	010310		Hz 38,10	ATE
	LA 911 B		01.68		03.0370-1038.2	051038		Hz Reparatursatz	
	LP 810	601116		12.68	03.0370-9998.2	059998		Hz Rep. Satz, -Kolben	ATE
	LP 911 B	601116		12.75					
	LT 911 B		01.68		03.3134-0300.3	010308		Hz 34,92	ATE
	LP 810		01.65		03.3508-0264.3	310009		Behälter	
	LP 911 B		601115	01.68				Behälter	
	L 911 B		01.68		03.3508-0801.3	310023		Behälter	
	LA 911 B		01.68						
	LP 810	601116		12.68					
	LP 911 B	601116		12.75					
	LT 911 B		01.68						
	L 911 B		01.68		83.6133-0551.3	330273		L=550	
	LP 810		01.65	12.68					
	LP 911 B		01.68	12.75					
	LA 911 B		01.68		83.6133-0651.3	330274		L=650	
	LT 911 B		01.68						
	LA 911 B		01.68		83.6133-0651.3	330274		L=650	

MERCEDES BENZ LKW (BM 354) 1418/1424

	1418 LP		01.64	12.72	03.0370-1131.2	051131		Hz Reparatursatz
	1418 LPS		01.64	12.72				
	1424 LP		01.73	12.83				
	1424 LPS		01.73	12.83				
	1418 LP		01.64	12.72	03.3508-0501.3	310017	2	Behälter
	1418 LPS		01.64	12.72				
	1424 LP		01.73	12.83				
	1424 LPS		01.73	12.83				
	1418 LP		01.64	12.72	83.6133-0551.3	330273		L=550
	1418 LPS		01.64	12.72				
	1424 LP		01.73	12.83				
	1424 LPS		01.73	12.83				

¹⁾ + wheel base 3700 mm / + passo 3700 mm / + empattement 3700 mm / + distancia entre ejes 3700 mm
²⁾ + wheel base 4200/5000 mm / + passo 4200/5000 mm / + empattement 4200/5000 mm / + dist.entre ejes 4200/5000 mm
³⁾ + front axle + 2. rear axle / + ass.anterior.+ 2.ass.posterior. / + ess.avant et 2. ess.arrière / + eje delante + 2.eje trasero
⁴⁾ in cab / in cabina / dans la cabine du conducteur / en cabina
⁵⁾ + 1. rear axle / + 1. asse posteriore / + 1. essieu arrière / + 1. eje trasero



MERCEDES BENZ LKW (BM 355) 2219

	LP 2219 6x4		01.72	12.75		03.3138-2001.3 03.3134-0300.3 03.0370-1038.2 03.0370-9998.2	010310 010308 051038 059998	+ Vorderachse ¹⁾ + Hinterachse ²⁾ + Vorderachse ¹⁾ + Vorderachse ¹⁾	Hz 38,10 Hz 34,92 Hz Reparatursatz Hz Rep. Satz, -Kolben	ATE ATE
	LP 2219 6x4		01.72	12.75		03.3508-0801.3	310023	+ Hinterachse ²⁾	Behälter	
	LP 2219 6x4		01.72	12.75		83.6133-0551.3	330273			L=550
	LP 2219 6x4		01.72	12.75		83.6133-0651.3	330274			L=650

MERCEDES BENZ LKW (BM 358) 1013/1113 B

	L 1113 B LA 1113 B LF 1113 B LK0 1113 B LP 1013 LP 1113 B	603469 603469	01.68 01.68 01.68 01.68	12.68		03.3134-0300.3	010308			Hz 34,92	ATE
	LP 1013 LP 1113 B	603468 603468	01.65 01.68			03.3508-0401.3 03.3508-0264.3	310014 310009		im Fahrerhaus ³⁾	Behälter Behälter	
	L 1113 B LA 1113 B LF 1113 B LK0 1113 B LP 1013 LP 1113 B	603469 603469	01.68 01.68 01.68 01.68	12.68		03.3508-0801.3 03.3508-0264.3 03.3508-4903.3	310023 310009 310032		0,2 l, im Fahrerhaus ⁴⁾ 0,5 l, im Fahrerhaus ⁵⁾	Behälter Behälter Behälter	
	L 1113 B LF 1113 B LK0 1113 B LP 1013 LP 1113 B		01.68 01.68 01.68	12.68		83.6133-0551.3	330273			L=550	
	LA 1113 B		01.68			83.6133-0651.3	330274			L=650	
	LA 1113 B		01.68			83.6133-0651.3	330274			L=650	

MERCEDES BENZ LKW (BM 360) 1513/1517/1519/1817/1819/2219

	1817 L 6x4 1819 L 6x4		01.69 01.69	12.71 12.71		03.3138-2001.3 03.0370-1038.2 03.0370-9998.2	010310 051038 059998	+ Vorderachse + 2. HA ⁶⁾ + Vorderachse + 2. HA ⁶⁾ + Vorderachse + 2. HA ⁶⁾	Hz 38,10 Hz Reparatursatz Hz Rep. Satz, -Kolben	ATE ATE	
	1513 L 1513 LA 1513 LP 1517 L 1517 LA 1517 LP 1519 L 1519 LA 1519 LP 2219 LP 6x2		01.67 01.67 01.67 01.67 01.67 01.67 01.71 01.71 01.71 01.72	12.75 12.70 12.70 12.70 12.70 12.78 12.78 12.78 12.75		03.3508-0401.3 03.3508-0264.3	310014 310009		0,13 l separater Behälter ⁷⁾	Behälter Behälter	
	1817 L 6x4 1819 L 6x4		01.69 01.69	12.71 12.71		03.3508-0401.3 03.3508-0801.3	310014 310023	+ 1. Hinterachse ⁸⁾ + Vorderachse + 2. HA ⁶⁾	Behälter Behälter		
	1513 L 1513 LP 1517 L 1517 LP 1519 L 1519 LP 1817 L 6x4 1819 L 6x4 2219 LP 6x2		01.67 01.67 01.67 01.67 01.71 01.71 01.69 01.69 01.72	12.75 12.70 12.70 12.70 12.78 12.78 12.71 12.71 12.75		83.6133-0551.3	330273			L=550	
	1513 LA 1517 LA 1519 LA		01.67 01.67 01.71	12.70 12.70 12.78		83.6133-0651.3	330274			L=650	
	1513 LA 1517 LA 1519 LA 2219 LP 6x2		01.67 01.67 01.71 01.72	12.70 12.78 12.78 12.75		83.6133-0651.3	330274			L=650	

MERCEDES BENZ LKW (BM 380) 1013/1017/1019

	1013 1017 1017 F 1017 K 1017 LS 1017 S 1019 F		01.76 01.76 01.76 01.76 01.77 01.76 01.76			83.6133-0651.3	330274			L=650	
	1013 1013 A 1017 1017 A		01.76 01.76 01.76 01.76			24.3244-0904.3	020301		Druckbolzen kurz ⁹⁾	Rz 44,45	
					- VA 731.404/600/632-635 ¹⁰⁾						

¹⁾ + front axle / + asse anteriore / + essieu avant / + eje delantero

²⁾ + rear axle / + asse posteriore / + essieu arrière / + eje trasero

³⁾ in cab / in cabina / dans la cabine du conducteur / en cabina

⁴⁾ 0,2 l, in cab / 0,2 l, in cabina / 0,2l,dans cabine du conducteur / 0,2 l, en cabina

⁵⁾ 0,5 l, in cab / 0,5 l, in cabina / 0,5l,dans cabine du conducteur / 0,5 l, en cabina

⁶⁾ + front axle + 2. rear axle / + ass.anterior.+ 2.ass.posterior. / + ess.avant et 2. ess.arrière / + eje delant.+ 2.eje trasero

⁷⁾ separate reservoir / serbatoio separato / réservoir séparé / depósito independiente

⁸⁾ + 1. rear axle / + 1. asse posteriore / + 1. essieu arrière / + 1. eje trasero





⁹⁾ tappet short / punteria corta / boulon de pression court / perno de presión (corto)

¹⁰⁾ - FA 731.404/600/632-635 / - A 731.404/600/632-635 / - ess. AV 731.404/600/632-635 / - ED 731.404/600/632-635













MERCEDES BENZ LKW (BM 380) 1013/1017/1019

	1017 AF 1017 AK 1017 AS 1017 F 1017 K 1017 LS 1017 S 1019 AF 1019 F		01.76 01.76 01.76 01.76 01.76 01.76 01.76 01.76 01.76	- VA 731.404/600/632-635 ²⁾ - VA 731.404/600/632-635 ²⁾ - VA 731.635 ³⁾	24.3244-0904.3	020301	Druckbolzen kurz ¹⁾	Rz 44,45
	1013 1017 1017 LS 1019 AF 1019 F		01.76 01.76 01.77 01.78 01.78		03.2423-0603.3	030036		Gz 23,81
	1019 AF 1019 F		01.78 01.78		03.2538-0104.3 03.0450-3801.2	040035 083801		Nz 38,10 Nz Reparatursatz
	1013 1017 1017 LS 1019 AF 1019 F		01.76 01.76 01.77 01.78 01.78		24.5901-0517.3	330054		L=517

MERCEDES BENZ LKW (BM 381) 1213/1217/1219

	1213 1217 1217 L 1217 LS 1219 1219 AF 1219 F 1219 S	4393715	01.76 01.76 01.76 01.76 01.76 01.76 01.76 01.76		83.6133-0651.3	330274		L=650
	1213 1213 A 1217 1217 A 1217 A 1217 L 1217 LS 1219 S		01.76 01.76 01.76 01.76 01.76 01.76 01.76 01.76	- VA 731.404/633/635 ⁴⁾ - VA 731.404/406/600 ⁵⁾ - VA 731.632/634/635 ⁶⁾ + VA 730.009 ⁷⁾	24.3244-0904.3	020301	Druckbolzen kurz ¹⁾	Rz 44,45
	1213 1217 1217 L 1217 LS 1219		01.76 01.76 01.76 01.76 01.76		03.2423-0603.3	030036		Gz 23,81
	1219		01.76		03.2538-0104.3 03.0450-3801.2	040035 083801		Nz 38,10 Nz Reparatursatz
	1213 1217 1217 L 1217 LS 1219		01.76 01.76 01.76 01.76 01.76		24.5901-0517.3	330054		L=517

MERCEDES BENZ LKW (BM 383) 1413/1417/1419/1424

	1413 1417 1419 1419 F 1419 L 1419 LS 1424 1424 F		01.75 01.75 01.75 12.83 01.75 12.83 01.75 12.83 01.75 12.83 01.73 12.83 01.73 12.83		83.6133-0651.3	330274		L=650
	1413 1417 1419 1419 L 1424 1424 F		01.75 12.85 01.75 12.85 01.75 12.83 01.75 12.83 01.75 12.83 01.75 12.83		03.2423-0603.3	030036		Gz 23,81
	1419 1419 L 1424 1424 F		01.75 12.83 01.75 12.83 01.75 12.83 01.75 12.83		03.2538-0104.3 03.0450-3801.2	040035 083801		Nz 38,10 Nz Reparatursatz
	1413 1417 1419 1419 L 1424 1424 F		01.75 12.85 01.75 12.85 01.75 12.83 01.75 12.83 01.75 12.83 01.75 12.83		24.5901-0517.3	330054		L=517

MERCEDES BENZ LKW (BM 385) 1613/1617/1619/1624/2219/2224

	2219 6x2 2219 L 6x2 2224 6x2		01.76 12.83 01.76 12.83 01.69 12.83		03.3134-0300.3 03.0370-1131.2	010308 051131	+ Vorderachse ⁸⁾ + Hinterachse ⁹⁾	Hz 34,92 Hz Reparatursatz	ATE
	2219 6x4 2224 6x4	4270668 4270668	01.75 01.69		03.3134-0300.3	010308	+ Vorderachse ⁸⁾	Hz 34,92	ATE

¹⁾ tappet short / punteria corta / boulon de pression court / perno de presión (corto)

²⁾ - FA 731.404/600/632-635 / - A 731.404/600/632-635 / - ess. AV 731.404/600/632-635 / - ED 731.404/600/632-635

³⁾ - FA 731.635 / - A 731.635 / - ess. AV 731.635 / - ED 731.635

⁴⁾ - FA 731.404/633/635 / - A 731.404/633/635 / - ess. AV 731.404/633/635 / - ED 731.404/633/635

⁵⁾ - FA 731.404/406/600 / - A 731.404/406/600 / - ess. AV 731.404/406/600 / - ED 731.404/406/600

⁶⁾ - FA 731.632/634/635 / - A 731.632/634/635 / - ess. AV 731.632/634/635 / - ED 731.632/634/635

⁷⁾ + FA 730.009 / + A 730.009 / + ess. AV 730.009 / + ED 730.009

⁸⁾ + front axle / + asse anteriore / + essieu avant / + eje delantero

⁹⁾ + rear axle / + asse posteriore / + essieu arrière / + eje trasero



MERCEDES BENZ LKW (BM 385) 1613/1617/1619/1624/2219/2224























	2224 B 6x4		4270668	01.69		03.3134-0300.3	010308	+ Vorderachse ¹⁾	Hz 34,92	ATE
	2219 6x4	4270669			12.83	03.0370-1131.2	051131	+ Vorderachse ¹⁾	Hz Reparatursatz	
	2224 6x4	4270669			12.75					
	2224 B 6x4	4270669			12.78					
	1613			01.75	12.85	83.6133-0651.3	330274		L=650	
	1613 K			01.75	12.85					
	1613 L			01.75	12.85					
	1617			01.75	12.85					
	1617 K			01.75	12.83					
	1617 L			01.75	12.83					
	1619			01.75	12.83					
	1619 L			01.75	12.83					
	1624			01.75	12.83					
	1624 L			01.75	12.83					
	2219 6x2			01.76	12.83					
	2219 6x4			01.75	12.83					
	2219 L 6x2			01.76	12.83					
	2224 6x2			01.69	12.83					
	2224 6x4			01.69	12.75					
					12.78					
	2219 6x2			01.76	12.83	83.6133-0651.3	330274		L=650	
	2219 6x4			01.75	12.83					
	2224 6x2			01.69	12.83					
	2224 6x4			01.69	12.75					
	2224 B 6x4			01.69	12.78					
	1613			01.75	12.85	03.2423-0603.3	030036		Gz 23,81	
	1613 K			01.75	12.85					
	1613 L			01.75	12.85					
	1617 AK			01.75	12.85					
	1617 K			01.75	12.85					
	1617 L			01.75	12.85					
	1617 S			01.75	12.85					
	1619			01.75	12.83					
	1619 L			01.75	12.83					
	1624			01.75	12.83					
	1624 L			01.75	12.83					
	2219 6x2			01.76	12.83					
	2219 6x4			01.76	12.83					
	2219 L 6x2			01.76	12.83					
	2224 6x2			01.69	12.83					
	2224 6x4			01.69	12.83					
	1619			01.75	12.83	03.2538-0104.3	040035		Nz 38,10	
	1619 L			01.75	12.83	03.0450-3801.2	083801		Nz Reparatursatz	
	1624			01.75	12.83					
	1624 L			01.75	12.83					
	2219 6x2			01.76	12.83					
	2219 6x4			01.76	12.83					
	2219 L 6x2			01.76	12.83					
	2224 6x2			01.69	12.83					
	2224 6x4			01.69	12.83					
	1613			01.75	12.85	24.5901-0517.3	330054		L=517	
	1613 K			01.75	12.85					
	1613 L			01.75	12.85					
	1617 AK			01.75	12.85					
	1617 K			01.75	12.85					
	1617 L			01.75	12.85					
	1617 S			01.75	12.85					
	1619			01.75	12.83					
	1619 L			01.75	12.83					
	1624			01.75	12.83					
	1624 L			01.75	12.83					
	2219 6x2			01.76	12.83					
	2219 6x4			01.76	12.83					
	2219 L 6x2			01.76	12.83					
	2224 6x2			01.69	12.83					
	2224 6x4			01.69	12.83					

























MERCEDES BENZ LKW (BM 387) 1626/1632/1719

	1626			01.73	12.80	03.2423-0603.3	030036		Gz 23,81	
	1626 L			01.76	12.80					
	1632			01.73	12.82					
	1632 L			01.76	12.82					
	1719			01.73	12.81					
	1719 AK			01.73	12.81					
	1719 K			01.73	12.81					
	1719 S			01.73	12.81					
	1626			01.73	12.80	03.2538-0104.3	040035		Nz 38,10	
	1626 L			01.76	12.80	03.0450-3801.2	083801		Nz Reparatursatz	
	1632			01.73	12.82					
	1632 L			01.76	12.82					
	1719			01.73	12.81					
	1719 AK			01.73	12.81					
	1719 K			01.73	12.81					
	1719 S			01.73	12.81					

¹⁾ + front axle / + asse anteriore / + essieu avant / + eje delantero



        	
MERCEDES BENZ LKW (BM 387) 1626/1632/1719	
	1626 01.73 12.80 24.5901-0517.3 330054 L=517 1626 L 01.76 12.80 1632 01.73 12.82 1632 L 01.76 12.82 1719 01.73 12.81 24.5901-0517.3 330054 L=517 1719 AK 01.73 12.81 1719 K 01.73 12.81 1719 S 01.73 12.81
MERCEDES BENZ LKW (BM 389) 1919/1926/1932	
	1919 01.73 03.2423-0603.3 030036 Gz 23,81 1919 AK 01.73 1919 K 01.73 1919 S 01.73 1926 01.73 1932 01.73 1932 L 01.73
	1919 01.73 03.2538-0104.3 040035 Nz 38,10 1919 AK 01.73 03.0450-3801.2 083801 Nz Reparatursatz 1919 K 01.73 1919 S 01.73 1926 01.73 1932 01.73 1932 L 01.73
	1919 01.73 24.5901-0517.3 330054 L=517 1919 K 01.73 1919 S 01.73 1919 AK 01.73 24.5901-0517.3 330054 L=517 1926 01.73 1932 01.73 1932 L 01.73
MERCEDES BENZ LKW (BM 391) 2026/2032	
	2026 01.76 12.81 03.2423-0603.3 030036 Gz 23,81 2032 01.76 2032 S 01.76
	2026 01.76 12.81 03.2538-0104.3 040035 Nz 38,10 2032 01.76 03.0450-3801.2 083801 Nz Reparatursatz 2032 S 01.76
	2026 01.76 12.81 24.5901-0517.3 330054 L=517 2032 01.76 2032 S 01.76
MERCEDES BENZ LKW (BM 393) 2226/2232	
	2226 6x2 01.73 12.81 03.2423-0603.3 030036 Gz 23,81 2226 6x4 01.73 12.81 2226 L 6x2 01.73 12.81 2226 L 6x4 01.73 12.81 2232 6x2 01.73 12.83 2232 6x4 01.73 12.83
	2226 6x2 01.73 12.81 03.2538-0104.3 040035 Nz 38,10 2226 6x4 01.73 12.81 03.0450-3801.2 083801 Nz Reparatursatz 2226 L 6x2 01.73 12.81 2226 L 6x4 01.73 12.81 2232 6x2 01.73 12.83 2232 6x4 01.73 12.83
	2226 6x2 01.73 12.81 24.5901-0517.3 330054 L=517 2226 6x4 01.73 12.81 2226 L 6x2 01.73 12.81 2226 L 6x4 01.73 12.81 2232 6x2 01.73 12.83 2232 6x4 01.73 12.83
MERCEDES BENZ LKW (BM 395) 2626/2632	
	2626 6x4 01.73 12.83 03.2423-0603.3 030036 Gz 23,81 2626 6x6 01.73 12.83 2632 6x4 01.73 12.83 2632 6x6 01.73 12.83
	2626 6x4 01.73 12.83 03.2538-0104.3 040035 Nz 38,10 2626 6x6 01.73 12.83 03.0450-3801.2 083801 Nz Reparatursatz 2632 6x4 01.73 12.83 2632 6x6 01.73 12.83
	2626 6x4 01.73 12.83 24.5901-0517.3 330054 L=517 2626 6x6 01.73 12.83 2632 6x4 01.73 12.83 2632 6x6 01.73 12.83
MERCEDES BENZ LKW (BM 615) 1222	
	1222 01.82 03.2423-0603.3 030036 Gz 23,81 1222 A 01.82 1222 AF 01.82 1222 F 01.82 1222 S 01.82

								
MERCEDES BENZ LKW (BM 615) 1222								
	1222 1222 A 1222 AF 1222 F 1222 S		01.82 01.82 01.82 01.82 01.82		03.2538-0104.3 03.0450-3801.2	040035 083801		Nz 38,10 Nz Reparatursatz
	1222 A 1222 AF		01.82 01.82		24.5901-0517.3	330054		L=517
MERCEDES BENZ LKW (BM 616) 1414/1417/1419/1422/1425								
	1414 1417 C 1419 C 1419 CL 1422 1422 F 1422 L 1422 LS 1422 S 1425 LS 1425 S		01.84 01.83 01.83 01.83 01.82 01.82 01.82 01.82 01.82 01.83 01.83		03.2423-0603.3	030036		Gz 23,81
	1417 C 1419 C 1419 CL		01.83 01.83 01.83		24.2528-0907.3	040054		Nz 28,57
	1414		01.84		24.5901-0517.3	330054		L=517
MERCEDES BENZ LKW (BM 617) 1614/1617/1619/1622/1625								
	1614 1617 C 1619 C 1622 1622 AK 1625		01.84 01.83 01.83 01.82 01.82 01.79		03.2423-0603.3	030036		Gz 23,81
	1617 C 1619 C		01.83 01.83		24.2528-0907.3	040054		Nz 28,57
	1622 1622 AK 1625		01.82 01.82 01.79		03.2538-0104.3 03.0450-3801.2	040035 083801		Nz 38,10 Nz Reparatursatz
	1614 1622 AK		01.84 01.82		24.5901-0517.3	330054		L=517
MERCEDES BENZ LKW (BM 619) 2025/2219/2222/2225								
	2025 S 6x2/4 2219 C 6x2 2219 C 6x2/4 2219 CL 6x2 2222 6x2 2222 6x2/4 2222 6x4 2222 B 6x4 2222 K 6x4 2222 L 6x2 2225 B 6x4		01.83 01.83 01.83 01.83 01.82 01.84 01.82 01.82 01.82 01.83 01.82		03.2423-0603.3	030036		Gz 23,81
	2025 S 6x2/4 2219 C 6x2 2219 C 6x2/4 2219 CL 6x2		01.83 01.83 01.83 01.83		03.2538-0104.3 03.0450-3801.2 24.2528-0907.3	040035 083801 040054		Nz 38,10 Nz Reparatursatz Nz 28,57
	2222 6x4 2222 B 6x4 2222 K 6x4		01.82 01.82 01.82		03.2538-0104.3 03.0450-3801.2	040035 083801		Nz 38,10 Nz Reparatursatz
MERCEDES BENZ LKW (BM 620) 1628/1633/1636/1638								
	1628 1628 L 1628 LS 1628 S 1633 1633 L 1633 LS 1633 S 1636 LS		01.79 01.79 01.79 01.79 01.81 01.81 01.81 01.81 01.83		03.2423-0603.3	030036		Gz 23,81
	1638 1638 LS 1638 S		01.79 01.81 01.79	12.86 12.86 12.86	24.2426-0902.3	030073		Gz 26,99
	1628 1628 L 1628 LS 1628 S		01.79 01.79 01.79 01.79		03.2538-0104.3 03.0450-3801.2	040035 083801		Nz 38,10 Nz Reparatursatz



MERCEDES BENZ LKW (BM 620) 1628/1633/1636/1638









	1628		4921176	01.79		24.5901-0517.3	330054		L=517
	1628 L		4921176	01.79					
	1628 LS		4921176	01.79	- BM 620.562/563				
	1628 S		4921176	01.79					
	1628	4921177				24.5901-0517.3	330054		L=517
	1628 L	4921177							
	1628 LS	4921177			- BM 620.562/563				
	1628 S	4921177							
	1633			01.81	+ BM 620.046	24.5901-0517.3	330054		L=517
	1633 L			01.83	+ BM 620.446				
	1633 LS			01.81	+ BM 620.543				
	1633 S			01.81	+ BM 620.142/143				
	1636 LS			01.83					

MERCEDES BENZ LKW (BM 621) 1922/1928/1933/1936/1938

	1922			01.80		03.2423-0603.3	030036		Gz 23,81
	1922 AK			01.82					
	1922 K			01.80					
	1922 S			01.80					
	1928			01.79					
	1928 A			01.80					
	1928 AK			01.80					
	1928 AS			01.80					
	1928 K			01.79					
	1928 L			01.80					
	1928 LS			01.80					
	1928 S			01.79					
	1933			01.80					
	1933 LS			01.80					
	1936			01.81					
1936 AK			01.81						
1936 AS			01.83						
1936 K			01.81						
1936 S			01.81						
	1938			01.80	12.84	24.2426-0902.3	030073		Gz 26,99
	1938 S			01.80	12.84				
	1922			01.80		03.2538-0104.3	040035		Nz 38,10
	1922 AK			01.82		03.0450-3801.2	083801		Nz Reparatursatz
	1922 K			01.80					
	1922 S			01.80					
	1928			01.79					
	1928 A			01.80					
	1928 AK			01.80					
	1928 AS			01.80					
	1928 K			01.79					
	1928 L			01.80					
	1928 LS			01.80					
	1928 S			01.79					
		1922			01.80		24.5901-0517.3	330054	
1922 AK				01.82					
1922 K				01.80					
1922 S				01.80					
1928			4921176	01.79		- BM 621.066	24.5901-0517.3	330054	L=517
1928 A		4921176	01.80						
1928 AK		4921176	01.80						
1928 AS		4921176	01.80						
1928 K		4921176	01.79						
1928 L		4921176	01.80		- BM 621.466				
1928 LS		4921176	01.80		- BM 621.562				
1928 S		4921176	01.79		- BM 621.162/163				
	1928	4921177				- BM 621.066	24.5901-0517.3	330054	L=517
	1928 A	4921177							
	1928 AK	4921177							
	1928 AS	4921177							
	1928 K	4921177							
	1928 L	4921177				- BM 621.466			
	1928 LS	4921177				- BM 621.562			
	1928 S	4921177				- BM 621.162/163			
	1933			01.80		- BM 621.096/097	24.5901-0517.3	330054	L=517
	1933 LS			01.80					
	1933 S			01.80					
	1936			01.81					
	1936 AK			01.81					
	1936 AS			01.83					
	1936 K			01.81					
	1936 S			01.81					

MERCEDES BENZ LKW (BM 622) 2028/2033

	2028			01.79		03.2423-0603.3	030036		Gz 23,81
	2033 LS 6x2/4			01.81					
	2028			01.79		03.2538-0104.3	040035		Nz 38,10
						03.0450-3801.2	083801		Nz Reparatursatz

MERCEDES BENZ LKW (BM 622) 2028/2033									
	2028			01.79	- BM 622.555	24.5901-0517.3	330054		L=517
MERCEDES BENZ LKW (BM 623) 2228/2233/2236/2238									
	2228 6x2 2228 6x4 2228 L 6x2 2233 6x2 2233 6x4 2233 L 6x2 2233 S 6x4 2236 6x2			01.79 01.81 01.80 01.81 01.81 01.81 01.81 01.83	BM 623.023 BM 623.423 BM 623.423 BM 623.145	03.2423-0603.3	030036		Gz 23,81
	2238 6x2 2238 S 6x4			01.79 01.79	12.86 12.86	24.2426-0902.3	030073		Gz 26,99
	2228 6x2 2228 6x4 2228 L 6x2			01.79 01.81 01.80		03.2538-0104.3 03.0450-3801.2	040035 083801		Nz 38,10 Nz Reparatursatz
	2228 6x2 2228 6x4 2228 L 6x2	4921176 4921176 4921176		01.79 01.81 01.80	- BM 623.058 - BM 623.180 - BM 623.458	24.5901-0517.3	330054		L=517
	2228 6x2 2228 6x4 2228 L 6x2	4921177 4921177 4921177			- BM 623.058 - BM 623.180 - BM 623.458	24.5901-0517.3	330054		L=517
	2233 6x2 2233 6x4 2233 L 6x2 2233 S 6x4 2236 6x2			01.81 01.81 01.81 01.81 01.83	BM 623.023 BM 623.423 BM 623.423 BM 623.145	24.5901-0517.3	330054		L=517
MERCEDES BENZ LKW (BM 624) 2628/2633/2636/2638									
	2628 6x4 2628 A 6x6 2628 AK 6x6 2628 AS 6x6 2628 B 6x4 2628 K 6x4 2628 S 6x4 2633 6x4 2633 S 6x4 2636 A 6x6 2636 AK 6x6 2636 AS 6x6 2636 K 6x4 2636 S 6x4			01.80 01.80 01.80 01.80 01.80 01.80 01.80 01.81 01.81 01.81 01.81 01.81 01.81 01.81		03.2423-0603.3	030036		Gz 23,81
	2638 S 6x4			01.81	12.86	24.2426-0902.3	030073		Gz 26,99
	2628 6x4 2628 A 6x6 2628 AK 6x6 2628 AS 6x6 2628 B 6x4 2628 K 6x4 2628 S 6x4			01.80 01.80 01.80 01.80 01.80 01.80 01.80		03.2538-0104.3 03.0450-3801.2	040035 083801		Nz 38,10 Nz Reparatursatz
	2628 6x4 2628 A 6x6 2628 B 6x4 2628 K 6x4 2628 S 6x4	4921176 4921176 4921176 4921176 4921176		01.80 01.80 01.80 01.80 01.80		24.5901-0517.3	330054		L=517
	2628 6x4 2628 A 6x6 2628 AK 6x6 2628 AS 6x6 2628 B 6x4 2628 K 6x4 2628 S 6x4 2633 6x4 2633 S 6x4 2636 A 6x6 2636 AK 6x6 2636 AS 6x6 2636 K 6x4 2636 S 6x4	4921177 4921177 4921177 4921177 4921177		01.80 01.80 01.80 01.81 01.81 01.81 01.81 01.81 01.81 01.81 01.81 01.81 01.81	- BM 624.196	24.5901-0517.3	330054		L=517
MERCEDES BENZ LKW (BM 625) 3025/3028/3250/3328/3850									
	3025 B 8x4 3025 K 8x4 3028 B 8x4 3028 K 8x4 3250 A 6x6 3328 B 8x4 3328 K 8x4 3850 A 6x6			01.86 01.86 01.86 01.86 01.86 01.86 01.86 01.85	12.89 12.89	03.2423-0603.3	030036		Gz 23,81





MERCEDES BENZ LKW (BM 625) 3025/3028/3250/3328/3850

	3025 B 8x4		01.86		24.5901-0517.3	330054		L=517	
	3025 K 8x4		01.86						
	3028 B 8x4		01.86		24.5901-0517.3	330054		L=517	
	3028 K 8x4		01.86						
	3328 B 8x4		01.86						
	3328 K 8x4		01.86						

MERCEDES BENZ LKW 1413/1513

	1413 L		01.63	12.69	03.3134-0300.3	010308	+ 1-Kreis-Bremse ¹⁾	Hz 34,92	ATE
	1413 LA		01.63	12.69					
	1413 LP		01.63	12.67					
	1513 LB		01.67	12.69					
	1413 L		01.63	12.69	03.3508-0401.3	310014	+ 2-Kreis-Bremse ²⁾	Behälter	
	1413 LA		01.63	12.69					
	1413 LP		01.63	12.67					
	1513 LB		01.67	12.69					
	1413 L		01.63	12.69	83.6103-0550.3	330231		L=550	
	1413 LA		01.63	12.69					
	1413 LP		01.63	12.67					
	1513 LB		01.67	12.69					

MERCEDES BENZ Transporter (BM 309) L405-L410/L508

	alle Typen	162734		12.82	- Druckluftverstärker ³⁾	03.2122-4902.3	010144	Sekundärmanschette umdreher	THz 22,20	ATE
	alle Typen				+ Druckluftverstärker ⁴⁾	03.2122-4902.3	010144		THz 22,20	ATE
	alle Typen		002798	01.67		03.3508-0264.3	310009		Behälter	
	L 405 D L 406 DG L 407 D L 408 DG L 408 G L 409 L 410 L 508 D L 508 DG L 508 DG Kastenw.			01.72 01.67 01.75 01.68 01.67 01.75 01.82 01.75 01.68 01.77	12.75		83.6133-0500.3	330272	2	L=500
	L 405 D	018261		12.80		03.3222-5804.3	020083		Rz 22,20	
	L 406 DG	018261		12.75						
	L 407 D			01.75						
	L 408 DG			01.68	12.75					
	L 408 G	001330		12.75						
	L 409			01.75	12.82					
	L 410			01.82						
	L 508 D			01.75						
	L 508 DG			01.68	12.75					
	L 508 DG Kastenw.			01.77	BM 309.429/ Radstand 4100mm ⁵⁾	03.3222-7802.3	020088		Rz 22,20	
	L 405 D			01.72	12.80	83.6103-0450.3	330228	2	L=450	
	L 406 DG			01.67	12.75					
	L 407 D			01.75						
	L 408 DG			01.68	12.75					
	L 408 G			01.67	12.75					
	L 409			01.75	12.82					
	L 410			01.82						
	L 508 D			01.75						
	L 508 DG			01.68	12.75					
	L 508 DG Kastenw.			01.77	BM 309.429/ Radstand 4100mm ⁵⁾	03.3222-7802.3	020088		Rz 22,20	
	L 405 D	018261		12.80		03.3222-5804.3	020083		Rz 22,20	
	L 406 DG	018261		12.75						
	L 407 D			01.75						
	L 408 DG			01.68	12.75					
	L 408 G	001330		12.75						
	L 409			01.75	12.82					
L 410			01.82							
L 508 D			01.75							
L 508 DG			01.68	12.75						
L 508 DG Kastenw.			01.77	BM 309.429/ Radstand 4100mm ⁵⁾	03.3222-7802.3	020088		Rz 22,20		
	L 405 D		285631	01.72		24.2419-0937.3	030063		Gz 19,05	FTE
	L 406 DG		285631	01.67						
	L 408 DG		285631	01.68						
	L 408 G		285631	01.67						
	L 508 DG		285631	01.68						
	L 405 D	285632			12.80		24.2419-0901.3	030041		Gz 19,05
L 406 DG	285632			12.75						
L 407 D			01.75							
L 408 DG	285632			12.75						
L 408 G	285632			12.75						
L 409			01.75	12.82						
L 410			01.82							
L 508 D			01.75							
L 508 DG	285632			12.75						

¹⁾ + single circuit brake / + impianto freni circuito singolo / + frein à 1 circuit / + freno de 1 circuito
²⁾ + two circuit brake / + impianto frenante doppio circuito / + frein à deux circuits / + freno de 2 circuitos
³⁾ - air brake booster / - servofreno pneumatico / - amplificateur pneumatique / - servo de aire a presión
⁴⁾ + air brake booster / + servofreno pneumatico / + amplificateur pneumatique / + servo de aire a presión
⁵⁾ BM 309.429/wheel base 4100mm / BM 309.429/passo 4100mm / BM 309.429/empattem. 4100mm / BM 309.429/dist.ejes 4100mm





MERCEDES BENZ Transporter (BM 309) L405-L410/L508

	L 405 D			01.72	12.80		03.2523-0812.3	040020		Nz 23,81 Nz Reparatursatz
	L 406 DG			01.67	12.75		03.0450-2311.2	082311		
	L 407 D			01.75						
	L 408 G			01.67	12.75					
	L 409			01.75	12.82					
	L 410			01.82						
	L 408 DG			01.68	12.75		03.0450-2805.2	082805		Nz Reparatursatz
	L 508 D			01.75						
	L 508 DG			01.68	12.75					

MERCEDES BENZ Transporter (BM 310) L508 D/L608 D

	LF 508 D		530029	01.78			03.2122-4902.3	010144		THz 22,20	ATE
	LF 608 D		530029	01.82							
	LF 508 D	530030					03.2125-1302.3	010203		THz 25,40	ATE
	LF 608 D	530030									
	L 608 D	162734	530029			5,6 t	03.2122-4902.3	010144		THz 22,20	ATE
	L 608 D	530030				5,6 t	03.2125-1302.3	010203		THz 25,40	ATE
	L 608 D		145736	01.72		6,5 t	03.2125-1102.3	010202		THz 25,40	ATE
	L 608 D	145737				6,5 t	03.2125-1302.3	010203		THz 25,40	ATE
	L 608 D		145736	01.72		6,5 t	03.3508-3600.3	310030		Behälter	
	L 608 D			01.68	5,6 t		83.6133-0500.3	330272	2	L=500	
	L 608 D			01.72	6,5 t						
	L 608 D			01.79	6,7 t						
	LF 508 D			01.78							
	LF 608 D			01.82							
	LT 608 D				BM 310.100						
	LF 508 D			01.78			03.3222-7802.3	020088		Rz 22,20	
	LF 608 D			01.82							
	L 608 D			01.68	5,6 t / - VA 730.506/600 ¹⁾		03.3222-5804.3	020083		Rz 22,20	
	L 608 D	145737		01.68	5,6 t / + VA 730.506 ²⁾		24.3223-1705.3	020418		Rz 23,81	
	L 608 D			01.79	6,5 t / - VA 730.530/600 ³⁾						
	L 608 D			01.79	6,7 t / - VA 730.600 ⁴⁾						
	L 608 D			01.68	5,6 t		83.6103-0450.3	330228	2	L=450	
	L 608 D			01.72	6,5 t						
	L 608 D			01.79	6,7 t						
	LF 508 D			01.78			03.3222-7802.3	020088		Rz 22,20	
	LF 608 D			01.82							
	L 608 D			01.68	5,6 t / - HA 741.334/.335 ⁵⁾		03.3222-5804.3	020083		Rz 22,20	
	L 608 D			01.68	5,6 t / + HA 741.334/.335 ⁶⁾		24.3238-0901.3	020298		Rz 38,10	
	L 608 D	145737		01.68	6,5 t / - HA 741.201 ⁷⁾		24.3223-1705.3	020418		Rz 23,81	
	L 608 D	145737		01.79	6,5 t / - HA 741.300/.335 ⁸⁾						
	L 608 D			01.79	6,7 t / - HA 741.335 ⁹⁾						
	L 608 D	145737		01.79	6,5 t / + HA 741.335 ¹⁰⁾		24.3238-0901.3	020298		Rz 38,10	
	L 608 D			01.79	6,7 t / + HA 741.335 ¹¹⁾						
		L 608 D		285631	01.68	5,6 t		24.2419-0937.3	030063		Gz 19,05
L 608 D			285631	01.72	6,5 t						
L 608 D		285632			5,6 t		24.2419-0901.3	030041		Gz 19,05	
L 608 D		285632			6,5 t						
L 608 D				01.79	6,7 t						
LT 608 D					01.82						
	L 608 D			01.68	5,6 t		03.0450-2805.2	082805		Nz Reparatursatz	
	L 608 D			01.72	6,5 t						
	L 608 D			01.79	6,7 t						
	LF 508 D			01.78							
	LF 608 D			01.82							
	LT 608 D					BM 310.100					





























MERCEDES BENZ Transporter (BM 313) L613 D/L614 D

	L 613 D		352290	01.77	- 6,8 t		03.2125-1302.3	010203		THz 25,40	ATE
	L 614 D		352290	01.77							
	L 613 D			01.77	- 6,8 t		83.6133-0500.3	330272	2	L=500	
	L 614 D			01.77							
	L 613 D			01.80	+ 6,8 t		83.6133-0551.3	330273	2	L=550	
	L 613 D			01.77	- 6,8 t		24.3223-1705.3	020418		Rz 23,81	
	L 614 D			01.77							
	L 613 D			01.80	+ 6,8 t		24.3238-0901.3	020298		- Druckbolzen ¹²⁾	Rz 38,10
	L 614 D			01.77			83.6103-0450.3	330228	2	L=450	
	L 613 D			01.77	- 6,8 t		24.3223-1705.3	020418		Rz 23,81	
	L 614 D			01.77							
	L 613 D			01.80	+ 6,8 t		24.3238-0901.3	020298		- Druckbolzen ¹²⁾	Rz 38,10

¹⁾ 5,6 t / - FA 730.506/600 / 5,6 t / - A 730.506/600 / 5,6 t / - ess. AV 730.506/600 / 5,6 t / - ED 730.506/600
²⁾ 5,6 t / + FA 730.506 / 5,6 t / + A 730.506 / 5,6 t / + ess. AV 730.506 / 5,6 t / + ED 730.506
³⁾ 6,5 t / - FA 730.530/600 / 6,5 t / - A 730.530/600 / 6,5 t / - ess. AV 730.530/600 / 6,5 t / - ED 730.530/600
⁴⁾ 6,7 t / - FA 730.600 / 6,7 t / - A 730.600 / 6,7 t / - ess. AV 730.600 / 6,7 t / - ED 730.600
⁵⁾ 5,6 t / - RA 741.334/.335 / 5,6 t / - P 741.334/.335 / 5,6 t / - ess. AR 741.334/.335 / 5,6 t / - ET 741.334/.335
⁶⁾ 5,6 t / + RA 741.334/.335 / 5,6 t / + P 741.334/.335 / 5,6 t / + ess. AR 741.334/.335 / 5,6 t / + ET 741.334/.335
⁷⁾ 6,5 t / - RA 741.201 / 6,5 t / - P 741.201 / 6,5 t / - ess. AR 741.201 / 6,5 t / - ET 741.201
⁸⁾ 6,5 t / - RA 741.300/.335 / 6,5 t / - P 741.300/.335 / 6,5 t / - ess. AR 741.300/.335 / 6,5 t / - ET 741.300/.335
⁹⁾ 6,7 t / - RA 741.335 / 6,7 t / - P 741.335 / 6,7 t / - ess. AR 741.335 / 6,7 t / - ET 741.335

¹⁰⁾ 6,5 t / + RA 741.335 / 6,5 t / + P 741.335 / 6,5 t / + ess. AR 741.335 / 6,5 t / + ET 741.335
¹¹⁾ 6,7 t / + RA 741.335 / 6,7 t / + P 741.335 / 6,7 t / + ess. AR 741.335 / 6,7 t / + ET 741.335
¹²⁾ - tappet / - punteria / - boulon de pression / - perno de presión



								
MERCEDES BENZ Transporter (BM 313) L613 D/L614 D								
	L 613 D L 614 D		01.77 01.77		24.2419-0901.3	030041		Gz 19,05
	L 613 D L 614 D		01.77 01.77		03.0450-2805.2	082805		Nz Reparatursatz
MERCEDES BENZ Transporter L319/L405-L408								
	L 319 B/D L 405/406/407/408		01.55 01.55	12.67 12.67	83.6103-0450.3	330228	2	L=450
	L 319 B/D L 405/406/407/408		01.55 01.55	12.67 12.67	83.6103-0450.3	330228	2	L=450
MERCEDES BENZ Transporter 311/312								
	311 L/LA/LP/LAP 312 L/LA		01.55 01.55	12.61 12.61	03.0370-1131.2	051131		Hz Reparatursatz
	311 L/LA/LP/LAP 312 L/LA		01.55 01.55	12.61 12.61	03.0370-1038.2 03.0370-9998.2	051038 059998		Hz Reparatursatz Hz Rep. Satz, -Kolben ATE
	311 L/LA/LP/LAP 312 L/LA		01.55 01.55	12.61 12.61	03.3508-0501.3	310017	0,35 l	Behälter
	311 L/LA/LP/LAP 312 L/LA		01.55 01.55	12.61 12.61	83.6103-0450.3	330228	2	L=450
	311 L/LA/LP/LAP 312 L/LA		01.55 01.55	12.61 12.61	83.6103-0500.3	330230	2	L=500
MERCEDES BENZ MB-TRAC (BM 440) 65/70/700/800/900								
	MB-Trac 65/70 MB-Trac 700	011581	01.73 01.76	12.76	03.2320-0201.3 24.3526-0810.3	010234 340037	1	Einlaß mit Gummistopfen ²⁾ Bremslichtschalter
	MB-Trac 65/70 MB-Trac 700	011581	01.73 01.76	12.76	24.3526-0810.3 03.3508-0401.3	340037 310014	1	Bremslichtschalter Aufschraubbehälter ³⁾
	MB-Trac 800 MB-Trac 900		01.75 01.81		13.2601-8037.2 13.2601-8038.2 13.0441-6012.2 13.0441-6001.2 13.0441-6010.2 03.3518-6100.2 03.3518-8000.2	210169 210170 250133 250126 250132 390364 390373	<input checked="" type="checkbox"/> <input checked="" type="checkbox"/> <input type="checkbox"/> <input type="checkbox"/> <input type="checkbox"/> <input type="checkbox"/> <input type="checkbox"/>	D=60 D=60 Dichtungssatz Dichtungssatz Dichtungssatz Entlüfterventil Entlüfterventil
	MB-Trac 800 MB-Trac 900		01.75 01.81		13.0460-6031.2 24.8190-0403.2	606031 620403	2	29581 15,0 /WE Warnkontakt L=315mm
	MB-Trac 65/70 MB-Trac 700 MB-Trac 800 MB-Trac 900		01.73 01.76 01.75 01.81	12.76	24.5201-0220.3	331272		L=220
	MB-Trac 800 MB-Trac 900		01.75 01.81		13.9544-0022.2 13.9544-0021.2 13.0441-5417.2 13.0471-5407.2 13.0471-5409.2 13.8158-0021.1 13.8158-0020.1 13.0471-5405.2 13.0471-5408.2	210258 210257 250118 250137 250139 990114 990113 250136 250138	<input checked="" type="checkbox"/> <input checked="" type="checkbox"/> <input type="checkbox"/> <input type="checkbox"/> <input type="checkbox"/> <input type="checkbox"/> <input type="checkbox"/> <input type="checkbox"/> <input type="checkbox"/> <input type="checkbox"/>	D=54 D=54 Dichtungssatz Verbindungsschrauben Rep.Satz Bremshebel Handbremshebel Handbremshebel Rep.Satz Nachstellung Rep.Satz Rückstellwelle
	MB-Trac 800 MB-Trac 900		01.75 01.81		13.0460-6031.2 24.8190-0403.2	606031 620403	2	29581 15,0 /WE Warnkontakt L=315mm
	MB-Trac 65/70 MB-Trac 700 MB-Trac 800 MB-Trac 900		01.73 01.76 01.75 01.81	12.76	83.6203-0250.3	330299		L=250
	MB-Trac 65/70 MB-Trac 700		01.73 01.76	12.76	03.3222-4007.3	020074		Rz 22,20
	MB-Trac 700 MB-Trac 800 MB-Trac 900		01.76 01.75 01.81		24.2419-0934.3	030060		Gz 19,05
MERCEDES BENZ MB-TRAC (BM 441) 1000								

¹⁾ + single chamber air brake / + fr.pneum.a camera singola / + fr. pneumatique à 1 chambre / + freno de aire de 1 cámara

²⁾ inlet with rubber plug / mandata con tappo in gomma / admiss.avec bouch.caoutchouc / admission con tapón de goma

³⁾ screw on reservoir / serbatoio da avvitare / réservoir à visser / depósito de enroscamiento

⁴⁾ + predecessor/ + deflector cap / + preceden./+ calotta protez. / + précesseur/ + déflecteur / + predecisor/ + tapa deflector

⁵⁾ + predecessor/ - deflector cap / + preceden./- calotta protez. / + précesseur/ - déflecteur / + predecisor/ - tapa deflector

⁶⁾ RA: 000192- / P: 000192- / ess. AR: 000192- / ET: 000192-



MERCEDES BENZ MB-TRAC (BM 441) 1000

	MB-Trac 1000			01.82				13.2601-8035.2 210167 13.2601-8037.2 210169 13.2601-8036.2 210168 13.2601-8038.2 210170 13.2601-7015.2 210230 13.2601-7016.2 210231 13.0441-6012.2 250133 13.0441-6001.2 250126 13.0441-6010.2 250132 03.3518-6100.2 390364 03.3518-8000.2 390373			<input type="checkbox"/> - aktive Lüftspieleinstellung 1) <input type="checkbox"/> - aktive Lüftspieleinstellung 1) <input type="checkbox"/> + aktive Lüftspieleinstellung 2) <input type="checkbox"/> + aktive Lüftspieleinstellung 2) + Vorgänger/ + Abschirmkappe 3) + Vorgänger/ - Abschirmkappe 4) L= 52 mm L= 90 mm	D=60 D=60 D=60 D=60 D=60 D=60 Dichtungssatz Dichtungssatz Dichtungssatz Entlüfterventil Entlüfterventil	ATE ATE ATE ATE ATE ATE ATE ATE ATE ATE
	MB-Trac 1000			01.82				13.0460-6031.2 606031 13.0460-0214.2 610214 24.8190-0403.2 620403	2 4		29581 15,0 /WE Belagsatz-Zubehör Warnkontakt L=315mm	ATE ATE	
	MB-Trac 1000			01.82				13.9544-0022.2 210258 13.9544-0021.2 210257 13.0441-5417.2 250118 13.0471-5407.2 250137 13.0471-5409.2 250139 13.8158-0020.1 990113 13.8158-0021.1 990114 13.0471-5405.2 250136 13.0471-5408.2 250138			D=54 D=54 Dichtungssatz Verbindungsschrauben Rep.Satz Bremshebel Handbremshebel Handbremshebel Rep.Satz Nachstellung Rep.Satz Rückstellwelle	ATE ATE ATE ATE ATE ATE ATE ATE	
	MB-Trac 1000			01.82				13.0460-6031.2 606031 24.8190-0403.2 620403	2		29581 15,0 /WE Warnkontakt L=315mm	ATE	

MERCEDES BENZ MB-TRAC (BM 442/443) 1100/1300/1500

	MB-Trac 1100 MB-Trac 1300 MB-Trac 1500			01.76 01.76 01.80				83.6203-0250.3 330299 83.6203-0250.3 330299 24.5201-0220.3 331272 83.6103-0400.3 330226			am Hauptzylinder 5) am Hauptzylinder 5) am Hauptzylinder 5) am Hauptzylinder 5)	L=250 L=250 L=220 L=400	
	MB-Trac 1100 MB-Trac 1300	005702 005702		01.76 01.76				24.5901-0517.3 330054				L=517	

MERCEDES BENZ UNIMOG (BM 401) 2010

	U 2010			01.50	12.60			24.3526-0110.3 340018	1			Bremslichtschalter	
	U 2010			01.50	12.60			83.6123-0381.3 330262				L=380	
	U 2010			01.50	12.60			83.6103-0320.3 330224				L=320	

MERCEDES BENZ UNIMOG (BM 403) 54/66/72/800

	U 54 U 66 U 72			001945 001945 001945	01.64 01.64 01.64			24.3526-0810.3 340037	1		+ Trommelbremse 6) + Trommelbremse 6) + Trommelbremse 6)	Bremslichtschalter	
	U 54 U 66 U 72 U 800	001946 001946 001946			12.77 12.77 12.77 01.77			24.3526-0810.3 340037	1		+ Trommelbremse 6) + Trommelbremse 6) + Trommelbremse 6) + Trommelbremse 6)	Bremslichtschalter	
	U 54 U 66 U 72 U 800			06.73 06.73 06.73 01.77	12.77 12.77 12.77 12.77			13.2601-8035.2 210167 13.2601-8037.2 210169 13.2601-8036.2 210168 13.2601-8038.2 210170 13.2601-7015.2 210230 13.2601-7016.2 210231 13.0441-6012.2 250133 13.0441-6001.2 250126 13.0441-6010.2 250132 03.3518-6100.2 390364 03.3518-8000.2 390373			<input type="checkbox"/> - aktive Lüftspieleinstellung 1) <input type="checkbox"/> - aktive Lüftspieleinstellung 1) <input type="checkbox"/> + aktive Lüftspieleinstellung 2) <input type="checkbox"/> + aktive Lüftspieleinstellung 2) + Vorgänger/ + Abschirmkappe 3) + Vorgänger/ - Abschirmkappe 4) L= 52 mm L= 90 mm	D=60 D=60 D=60 D=60 D=60 D=60 Dichtungssatz Dichtungssatz Dichtungssatz Dichtungssatz Entlüfterventil Entlüfterventil	ATE ATE ATE ATE ATE ATE ATE ATE ATE ATE
	U 54 U 66 U 72 U 800			06.73 06.73 06.73 01.77	12.77 12.77 12.77 12.77			13.0460-6031.2 606031 13.0460-0214.2 610214 24.8190-0403.2 620403	2 4			29581 15,0 /WE Belagsatz-Zubehör Warnkontakt L=315mm	ATE ATE
	U 54 U 66 U 72 U 800			01.64 01.64 01.64 01.77	12.77 12.77 12.77 12.77			24.5201-0220.3 331272				L=220	
	U 54 U 66 U 72 U 800			06.73 06.73 06.73 01.77	12.77 12.77 12.77 12.77			13.9544-0022.2 210258 13.9544-0021.2 210257 13.0441-5417.2 250118 13.0471-5407.2 250137 13.0471-5409.2 250139 13.8158-0021.1 990114 13.8158-0020.1 990113 13.0471-5405.2 250136 13.0471-5408.2 250138			HA: 030614- 7)	D=54 D=54 Dichtungssatz Verbindungsschrauben Rep.Satz Bremshebel Handbremshebel Handbremshebel Rep.Satz Nachstellung Rep.Satz Rückstellwelle	ATE ATE ATE ATE ATE ATE ATE ATE

1) - active clearance adjustment / - recupero autom. del gioco / - réglage act.d.jeu fonctionnel / - ajust.activ.jueg.ventilación
 2) + active clearance adjustment / + recupero autom. del juego / + réglage act.d.jeu fonctionnel / + ajust.activ.jueg.ventilación
 3) + predecessor/ + deflector cap / + preceden./+ calotta protez. / + prédecesseur/ + déflecteur / + predecesor/ + tapa deflector
 4) + predecessor/ - deflector cap / + preceden./- calotta protez. / + prédecesseur/ - déflecteur / + predecesor/ - tapa deflector
 5) on the master cylinder / sulla pompa freno / sur le maître-cylindre / a la bomba principal de freno
 6) + drum brake / + freno a tamburo / + freins à tambour / + tambores de freno
 7) RA: 030614- / P: 030614- / ess. AR: 030614- / ET: 030614-





MERCEDES BENZ UNIMOG (BM 403) 54/66/72/800

	U 54 U 66 U 72 U 800			06.73 06.73 06.73 01.77	12.77 12.77 12.77 12.77			13.0460-6031.2 24.8190-0403.2	606031 620403	2		29581 15,0 /WE Warnkontakt L=315mm	ATE
	U 54 U 66 U 72 U 800			01.64 01.64 01.64 01.77	12.77 12.77 12.77 12.77	+ Trommelbremse ¹⁾ + Trommelbremse ¹⁾ + Trommelbremse ¹⁾ + Trommelbremse ¹⁾		83.6203-0300.3 83.6192-0250.3	330386 330726	■		L=300 L=250	
	U 54 U 66 U 72 U 800			06.73 06.73 06.73 01.77	12.77 12.77 12.77 12.77	+ Scheibenbremse ²⁾ + Scheibenbremse ²⁾ + Scheibenbremse ²⁾ + Scheibenbremse ²⁾		83.6203-0300.3 83.6203-0250.3	330386 330299	■		L=300 L=250	
	U 54 U 66 U 72		001945 001945 001945	01.64 01.64 01.64				03.3220-0905.3	020059			Rz 20,64	
	U 54 U 66 U 72 U 800	001946 001946 001946			12.77 12.77 12.77 01.77			03.3222-4007.3	020074			Rz 22,20	
	U 54 U 66 U 72 U 800			01.64 01.64 01.64 01.77	12.77 12.77 12.77 12.77			24.2419-0934.3	030060			Gz 19,05	
	U 54 U 66 U 72 U 800			01.64 01.64 01.64 01.77	12.77 12.77 12.77 12.77			83.6103-0240.3	330220			L=240	

















MERCEDES BENZ UNIMOG (BM 404) 82/110/404 S

	U 110 U 404 S U 82			01.71 01.55 01.71	12.77 12.70 12.77			24.7718-7301.2	990024			Rückschlagventil	
	U 404 S			01.55	12.65	- BM 404.117		24.3526-0100.3	340017	1		Bremslichtschalter	
	U 404 S			01.55	12.65	- BM 404.117		03.3508-3600.3	310030			Behälter	
	U 404 S			01.55	12.65	- BM 404.117		83.6103-0400.3	330226			L=400	
	U 110 U 404 S U 82			01.71 01.65 01.71	12.77 12.70 12.77			83.6203-0300.3 83.6103-0400.3	330386 330226		am Hauptzylinder ³⁾	L=300 L=400	
	U 110 U 404 S U 82			01.71 01.55 01.71	12.77 12.70 12.77			83.6203-0250.3 83.6192-0250.3	330299 330726	■		L=250 L=250	
	U 110 U 404 S U 82			01.71 01.55 01.71	12.77 12.70 12.77			03.3228-0502.3	020109			Rz 28,57	
	U 110 U 404 S U 82			01.71 01.65 01.71	12.77 12.70 12.77			24.2419-0934.3	030060			Gz 19,05	
	U 404 S			01.65	12.70			83.6103-0240.3 83.6203-0300.3	330220 330386			L=240 L=300	
	U 110 U 82			01.71 01.71	12.77 12.77			83.6203-0300.3	330386			L=300	

MERCEDES BENZ UNIMOG (BM 406) 65/70/80/84/900

	U 65 U 70 U 80 U 84		005735 005735 005735 005735	01.64 01.64 01.64 01.64		+ Trommelbremse ¹⁾ + Trommelbremse ¹⁾ + Trommelbremse ¹⁾ + Trommelbremse ¹⁾		24.3526-0100.3	340017	1		Bremslichtschalter	
	U 65 U 70 U 80 U 84	005736 005736 005736 005736	013569 013569 013569 013569			+ Trommelbremse ¹⁾ + Trommelbremse ¹⁾ + Trommelbremse ¹⁾ + Trommelbremse ¹⁾		24.3526-0810.3	340037	1		Bremslichtschalter	
	U 65 U 70 U 80 U 84 U 900	013570 013570 013570 013570 013570				+ Trommelbremse ¹⁾ + Trommelbremse ¹⁾ + Trommelbremse ¹⁾ + Trommelbremse ¹⁾ + Trommelbremse ¹⁾		24.3526-0810.3	340037	1		Bremslichtschalter	
	U 65 U 70 U 80 U 84		005735 005735 005735 005735	01.64 01.64 01.64 01.64		+ Trommelbremse ¹⁾ + Trommelbremse ¹⁾ + Trommelbremse ¹⁾ + Trommelbremse ¹⁾		03.3508-0801.3	310023			Behälter	

¹⁾ + drum brake / + freno a tamburo / + freins à tambour / + tambores de freno
²⁾ + disc brake / + disco freno / + disques de frein / + disco de freno
³⁾ on the master cylinder / sulla pompa freno / sur le maître-cylindre / a la bomba principal de freno

MERCEDES BENZ UNIMOG (BM 406) 65/70/80/84/900										
	U 65 U 70 U 80 U 84 U 900			06.73 06.73 06.73 06.73 06.73	12.77 12.77 12.77 12.77 12.77	13.2601-8035.2 13.2601-8037.2 13.2601-8036.2 13.2601-8038.2 13.2601-7015.2 13.2601-7016.2 13.0441-6012.2 13.0441-6001.2 13.0441-6010.2 03.3518-6100.2 03.3518-8000.2	210167 210169 210168 210170 210230 210231 250133 250126 250132 390364 390373	<input type="checkbox"/> - aktive Lüftspieleinstellung ¹⁾ <input type="checkbox"/> - aktive Lüftspieleinstellung ¹⁾ <input type="checkbox"/> + aktive Lüftspieleinstellung ²⁾ <input type="checkbox"/> + aktive Lüftspieleinstellung ²⁾	D=60 D=60 D=60 D=60 D=60 D=60 Dichtungssatz Dichtungssatz Dichtungssatz Entlüfterventil Entlüfterventil	ATE ATE ATE ATE ATE ATE ATE ATE ATE ATE
	U 65 U 70 U 80 U 84 U 900			06.73 06.73 06.73 06.73 06.73	12.77 12.77 12.77 12.77 12.77	13.0460-6031.2 13.0460-0214.2 24.8190-0403.2	606031 610214 620403	2 4	29581 15,0 AWE Belagsatz-Zubehör Warnkontakt L=315mm	ATE ATE
	U 65 U 70 U 80 U 84 U 900		005735 005735 005735 005735	01.64 01.64 01.64 01.64	12.77 12.77 12.77 12.77	83.6203-0300.3 24.5201-0220.3 83.6103-0400.3	330386 331272 330226	am Hauptzylinder ⁵⁾ <input type="checkbox"/> + Triebkopf ⁶⁾	L=300 L=220 L=400	
	U 65 U 70 U 80 U 84 U 900	005736 005736 005736 005736 013570		12.77 12.77 12.77 12.77 12.77	12.77 12.77 12.77 12.77 12.77	24.5201-0220.3 83.6103-0400.3	331272 330226	<input type="checkbox"/> + Triebkopf ⁶⁾	L=220 L=400	
	U 65 U 70 U 80 U 84 U 900			06.73 06.73 06.73 06.73 06.73	12.77 12.77 12.77 12.77 12.77	13.9544-0022.2 13.9544-0021.2 13.0441-5417.2 13.0471-5407.2 13.0471-5409.2 13.8158-0021.1 13.8158-0020.1 13.0471-5405.2 13.0471-5408.2	210258 210257 250118 250137 250139 990114 990113 250136 250138	<input type="checkbox"/> <input type="checkbox"/> HA: 030614- ⁷⁾ <input type="checkbox"/> <input type="checkbox"/>	D=54 D=54 Dichtungssatz Verbindungsschrauben Rep.Satz Bremshebel Handbremshebel Handbremshebel Rep.Satz Nachstellung Rep.Satz Rückstellwelle	ATE ATE ATE
	U 65 U 70 U 80 U 84 U 900			06.73 06.73 06.73 06.73 06.73	12.77 12.77 12.77 12.77 12.77	13.0460-6031.2 24.8190-0403.2	606031 620403	2	29581 15,0 AWE Warnkontakt L=315mm	ATE
	U 65 U 70 U 80 U 84 U 900			01.64 01.64 01.64 01.64	12.77 12.77 12.77 12.77	83.6203-0300.3 83.6192-0250.3	330386 330726	<input type="checkbox"/>	L=300 L=250	
	U 65 U 70 U 80 U 84 U 900	013570		06.73 06.73 06.73 06.73 06.73	12.77 12.77 12.77 12.77 12.77	83.6203-0300.3 83.6192-0250.3	330386 330726	<input type="checkbox"/>	L=300 L=250	
	U 65 U 70 U 80 U 84 U 900		013569 013569 013569 013569	01.64 01.64 01.64 01.64	12.77 12.77 12.77 12.77	03.3220-0905.3	020059		Rz 20,64	
	U 65 U 70 U 80 U 84 U 900	013570 013570 013570 013570 013570				03.3222-4007.3	020074		Rz 22,20	
	U 65 U 70 U 80 U 900	005736 005736 005736 005736		12.77 12.77 12.77 12.77	12.77 12.77 12.77 12.77	24.2419-0934.3	030060		Gz 19,05	
	U 65 U 70 U 80 U 84		005735 005735 005735 005735	01.64 01.64 01.64 01.64	12.77 12.77 12.77 12.77	83.6203-0200.3	330298		L=200	
	U 65 U 70 U 80 U 900	005736 005736 005736 005736		12.77 12.77 12.77 12.77	12.77 12.77 12.77 12.77	83.6103-0240.3	330220		L=240	
MERCEDES BENZ UNIMOG (BM 407) 600/650/650 L										
	600 650 650 L			01.88 01.88 01.88	12.77 12.77 12.77	24.2419-0934.3	030060		Gz 19,05	
MERCEDES BENZ UNIMOG (BM 411) 411										
	U 411 U 411 U 411 A U 411 A	22 23 22 23		01.56 01.56 01.56 01.56	12.65 12.65 12.65 12.65	03.3125-0401.3	010290		Hz 25,40	ATE
	U 411 U 411 A			01.56 01.56	12.65 12.74	03.3508-3600.3	310030		Behälter	

¹⁾ - active clearance adjustment / - recupero autom. del gioco / - réglage act.d.jeu fonctionnel / - ajust.act.v.jueg.

²⁾ + active clearance adjustment / + recupero autom. del gioco / + réglage act.d.jeu fonctionnel / + ajust.act.v.jueg.

³⁾ + predecessor/ + deflector cap / + preceden./+ calotta protez. / + prédeceseur/ + déflecteur / + predecisor/ +

tapa deflector

⁴⁾ + predecessor/ - deflector cap / + preceden./- calotta protez. / + prédeceseur/ - déflecteur / + predecisor/ - tapa deflector





























⁵⁾ on the master cylinder / sulla pompa freno / sur le maître-cylindre / a la bomba principal de freno

⁶⁾ + drive head / + motrice con sola cabina / + tête de propulsion / + grupo motriz























⁷⁾ RA: 030614- / P: 030614- / ess. AR: 030614- / ET: 030614-

⁸⁾ + drum brake / + freno a tamburo / + freins à tambour / + tambores de freno

⁹⁾ + disc brake / + disco freno / + disques de frein / + disco de freno

MERCEDES BENZ UNIMOG (BM 411) 411										
										
	U 411 A	25 029950		12.74		24.5201-0220.3	331272		L=220	
	U 411 U 411 A			01.56 12.65 01.56 12.74		24.5201-0220.3 83.6103-0190.3	331272 330218	■	L=220 L=190	
	U 411 U 411 A U 411 A U 411 A	22 23 22 23		01.56 12.65 01.56 12.65 01.56 12.65		03.3222-0902.3	020068		Rz 22,20	
	U 411 A	25		01.65 12.74		03.3222-4007.3	020074		Rz 22,20	
MERCEDES BENZ UNIMOG (BM 413) 72/80/800 L										
	U 72 U 80		000014 000014	01.73 01.73	+ Trommelbremse ¹⁾ + Trommelbremse ¹⁾	24.3526-0810.3	340037	1	Bremslichtschalter	
	U 72 U 80 U 800 L	000015 000015		12.77 12.77 01.77	+ Trommelbremse ¹⁾ + Trommelbremse ¹⁾ + Trommelbremse ¹⁾	24.3526-0810.3	340037	1	Bremslichtschalter	
	U 72 U 80 U 800 L			06.73 06.73 01.77	12.77 12.77	13.2601-8035.2 13.2601-8037.2 13.2601-8036.2 13.2601-8038.2 13.2601-7015.2 13.2601-7016.2 13.0441-6012.2 13.0441-6001.2 13.0441-6010.2 03.3518-6100.2 03.3518-8000.2	210167 210169 210168 210170 210230 210231 250133 250126 250132 390364 390373	■ - aktive Lüftspieleinstellung ²⁾ ■ - aktive Lüftspieleinstellung ²⁾ ■ + aktive Lüftspieleinstellung ³⁾ ■ + aktive Lüftspieleinstellung ³⁾	D=60 D=60 D=60 D=60 D=60 Dichtungssatz Dichtungssatz Dichtungssatz Entlüfterventil Entlüfterventil	ATE ATE ATE ATE ATE ATE ATE ATE
	U 72 U 80 U 800 L			06.73 06.73 01.77	12.77 12.77	13.0460-6031.2 13.0460-0214.2 24.8190-0403.2	606031 610214 620403	2 4	29581 15,0 /WE Belagsatz-Zubehör Warnkontakt L=315mm	ATE ATE
	U 72 U 80 U 800 L			01.73 01.73 01.77	12.77 12.77	24.5201-0220.3	331272		L=220	
	U 72 U 80 U 800 L			06.73 06.73 01.77	12.77 12.77	13.9544-0022.2 13.9544-0021.2 13.0441-5417.2 13.0471-5407.2 13.0471-5409.2 13.8158-0021.1 13.8158-0020.1 13.0471-5405.2 13.0471-5408.2	210258 210257 250118 250137 250139 990114 990113 250136 250138	■ ■ HA: 017945- ⁶⁾ ■ ■	D=54 D=54 Dichtungssatz Verbindungsschrauben Rep.Satz Bremshebel Handbremshebel Handbremshebel Rep.Satz Nachstellung Rep.Satz Rückstellwelle	ATE ATE ATE ATE ATE ATE ATE ATE
	U 72 U 80 U 800 L			06.73 06.73 01.77	12.77 12.77	13.0460-6031.2 24.8190-0403.2	606031 620403	2	29581 15,0 /WE Warnkontakt L=315mm	ATE
	U 72 U 80 U 800 L			01.73 01.73 01.77	12.77 + Trommelbremse ¹⁾ 12.77 + Trommelbremse ¹⁾ 12.77 + Trommelbremse ¹⁾	83.6203-0300.3 83.6192-0250.3	330386 330726	■	L=300 L=250	
	U 72 U 80 U 800 L			06.73 06.73 01.77	12.77 + Scheibenbremse ⁷⁾ 12.77 + Scheibenbremse ⁷⁾ 12.77 + Scheibenbremse ⁷⁾	83.6203-0300.3 83.6192-0250.3	330386 330726	■	L=300 L=250	
	U 72 U 80 U 800 L			01.73 01.73 01.77	12.77 12.77	24.2419-0934.3	030060		Gz 19,05	
	U 72 U 80 U 800 L			01.73 01.73 01.77	12.77 12.77	83.6103-0240.3	330220		L=240	
MERCEDES BENZ UNIMOG (BM 416) 80/90/100/110/1100/1100 L										
	U 80 U 90		000078 000078	01.64 01.64		24.3526-0100.3	340017	1	Bremslichtschalter	
	U 100 U 110 U 80 U 90	000079 000079 000079 000079	004813 004813 004813 004813		+ Trommelbremse ¹⁾ + Trommelbremse ¹⁾ + Trommelbremse ¹⁾ + Trommelbremse ¹⁾	24.3526-0810.3	340037	1	Bremslichtschalter	
	U 100 U 110 U 1100 U 1100 L U 80 U 90	004814 004814 004814 004814 004814 004814		01.77 01.77 01.77 01.77 12.77 12.77	+ Trommelbremse ¹⁾ + Trommelbremse ¹⁾ + Trommelbremse ¹⁾ + Trommelbremse ¹⁾ + Trommelbremse ¹⁾ + Trommelbremse ¹⁾	24.3526-0810.3	340037	1	Bremslichtschalter	
	U 80 U 90		000078 000078	01.64 01.64		03.3508-0801.3	310023		Behälter	

¹⁾ + drum brake / + freno a tamburo / + freins à tambour / + tambores de freno
²⁾ - active clearance adjustment / - recupero autom. del gioco / - réglage act.d.jeu fonctionnel / - ajust.activ.jueg.ventilación
³⁾ + active clearance adjustment / + recupero autom. del gioco / + réglage act.d.jeu fonctionnel / + ajust.activ.jueg.ventilación
⁴⁾ + predecessor / + deflector cap / + preceden./+ calotta protez. / + prédecesseur / + déflecteur / + predecesor / + tapa deflector
⁵⁾ + predecessor / - deflector cap / + preceden./- calotta protez. / + prédecesseur / - déflecteur / + predecesor / - tapa deflector
⁶⁾ RA: 017945- / P: 017945- / ess. AR: 017945- / ET: 017945-
⁷⁾ + disc brake / + disco freno / + disques de frein / + disco de freno

MERCEDES BENZ UNIMOG (BM 416) 80/90/100/110/1100/1100 L												
												
	U 100 U 110 U 1100 U 1100 L U 125 U 80 U 90			06.73 06.73 01.77 01.77 06.73 06.73 06.73	12.77 12.77 12.77 12.77 12.77 12.77 12.77	13.2601-8035.2 13.2601-8037.2 13.2601-8036.2 13.2601-8038.2 13.2601-7015.2 13.2601-7016.2 13.0441-6012.2 13.0441-6001.2 13.0441-6010.2 03.3518-6100.2 03.3518-8000.2	210167 210169 210168 210170 210230 210231 250133 250126 250132 390364 390373	<input type="checkbox"/> - aktive Lüftspieleinstellung ¹⁾ <input type="checkbox"/> - aktive Lüftspieleinstellung ¹⁾ <input type="checkbox"/> + aktive Lüftspieleinstellung ²⁾ <input type="checkbox"/> + aktive Lüftspieleinstellung ²⁾ + Vorgänger/ + Abschirmkappe ³⁾ + Vorgänger/ - Abschirmkappe ⁴⁾ L= 52 mm L= 90 mm	D=60 D=60 D=60 D=60 D=60 D=60 Dichtungssatz Dichtungssatz Dichtungssatz Entlüfterventil Entlüfterventil	ATE ATE ATE ATE ATE ATE ATE ATE ATE ATE ATE		
	U 100 U 110 U 1100 U 1100 L U 125 U 80 U 90			06.73 06.73 01.77 01.77 06.73 06.73 06.73	12.77 12.77 12.77 12.77 12.77 12.77 12.77	13.0460-6031.2 13.0460-0214.2 24.8190-0403.2	606031 610214 620403	2 4		29581 15,0 /WE Belagsatz-Zubehör Warnkontakt L=315mm	ATE ATE	
	U 80 U 90		000078 000078	01.64 01.64		83.6203-0300.3 24.5201-0220.3	330386 331272		am Hauptzylinder ⁵⁾	L=300 L=220		
	U 100 U 110 U 1100 U 1100 L U 125 U 80 U 90	000079 000079		12.77 12.77 01.77 01.77 06.73 12.77 12.77		24.5201-0220.3 83.6192-0250.3	331272 330726		<input type="checkbox"/> + Triebkopf ⁶⁾	L=220 L=250		
	U 100 U 110 U 1100 U 1100 L U 125 U 80 U 90			06.73 06.73 01.77 01.77 06.73 06.73 06.73	12.77 12.77 12.77 12.77 12.77 12.77 12.77	13.9544-0022.2 13.9544-0021.2 13.0441-5417.2 13.0471-5407.2 13.0471-5409.2 13.8158-0021.1 13.8158-0020.1 13.0471-5405.2 13.0471-5408.2	210258 210257 250118 250137 250139 990114 990113 250136 250138	<input type="checkbox"/> <input type="checkbox"/> HA: 017945- ⁷⁾ <input type="checkbox"/> <input type="checkbox"/>	D=54 D=54 Dichtungssatz Verbindungsschrauben Rep.Satz Bremshebel Handbremshebel Handbremshebel Rep.Satz Nachstellung Rep.Satz Rückstellwelle	ATE ATE ATE		
	U 100 U 110 U 1100 U 1100 L U 125 U 80 U 90			06.73 06.73 01.77 01.77 06.73 06.73 06.73	12.77 12.77 12.77 12.77 12.77 12.77 12.77	13.0460-6031.2 24.8190-0403.2	606031 620403	2		29581 15,0 /WE Warnkontakt L=315mm	ATE	
	U 80 U 90		000078 000078	01.64 01.64		83.6103-0190.3 83.6203-0300.3	330218 330386		<input type="checkbox"/>	L=190 L=300		
	U 100 U 110 U 1100 U 1100 L U 125 U 80 U 90	000079 000079		12.77 12.77 01.77 01.77 06.73 12.77 12.77		83.6203-0300.3 83.6192-0250.3	330386 330726		<input type="checkbox"/>	L=300 L=250		
	U 100 U 110 U 80 U 90	000079 000079	007388 007388 007388 007388	01.64 01.64		03.3220-0905.3	020059			Rz 20,64		
	U 100 U 110 U 1100 U 1100 L U 80 U 90	007389 007389		12.77 12.77 01.77 01.77 12.77 12.77		03.3222-4007.3	020074			Rz 22,20		
	U 100 U 110 U 1100 U 1100 L U 125 U 80 U 90	000079 000079		12.77 12.77 01.77 01.77 12.77 12.77 12.77		24.2419-0934.3	030060			Gz 19,05		
	U 80 U 90		000078 000078	01.64 01.64		83.6203-0200.3	330298			L=200		
	U 100 U 110 U 1100 U 1100 L U 125 U 80 U 90	000079 000079		12.77 12.77 01.77 01.77 12.77 12.77 12.77		83.6103-0240.3	330220			L=240		

¹⁾ - active clearance adjustment / - recupero autom. del juego / - réglage act.d.jeu fonctionnel / - ajust.activ.jueg.ventilación
²⁾ + active clearance adjustment / + recupero autom. del juego / + réglage act.d.jeu fonctionnel / + ajust.activ.jueg.ventilación
³⁾ + predecessor/ + deflector cap / + preceden./+ calotta protez. / + prédecesseur/ + déflecteur / + predecesor/ + tapa deflector
⁴⁾ + predecessor/ - deflector cap / + preceden./- calotta protez. / + prédecesseur/ - déflecteur / + predecesor/ - tapa deflector
⁵⁾ on the master cylinder / sulla pompa freno / sur le maître-cylindre / a la bomba principal de freno
⁶⁾ + drive head / + motrice con sola cabina / + tête de propulsion / + grupo motriz
⁷⁾ RA: 017945- / P: 017945- / ess. AR: 017945- / ET: 017945-





MERCEDES BENZ UNIMOG (BM 417) 800-1150

	U 1100 U 1150 U 800 U 900								13.2601-8035.2 210167 13.2601-8037.2 210169 13.2601-8036.2 210168 13.2601-8038.2 210170 13.2601-7015.2 210230 13.2601-7016.2 210231 13.0441-6012.2 250133 03.3518-6100.2 390364 03.3518-8000.2 390373				<input type="checkbox"/> - aktive Lüftspieleinstellung ¹⁾ <input type="checkbox"/> - aktive Lüftspieleinstellung ¹⁾ <input type="checkbox"/> + aktive Lüftspieleinstellung ²⁾ <input type="checkbox"/> + aktive Lüftspieleinstellung ²⁾ L= 52 mm L= 90 mm	D=60 D=60 D=60 D=60 D=60 D=60 Dichtungssatz Entlüfterventil Entlüfterventil	ATE ATE ATE ATE ATE ATE
	U 1100 U 1150 U 800 U 900								13.0460-6031.2 606031 13.0460-0214.2 610214 24.8190-0403.2 620403	2 4				29581 15,0 /WE Belagsatz-Zubehör Warnkontakt L=315mm	ATE ATE
	U 1100 U 1150 U 800 U 900								13.9544-0022.2 210258 13.9544-0021.2 210257 13.0441-5417.2 250118 13.0471-5407.2 250137 13.0471-5409.2 250139 13.8158-0021.1 990114 13.8158-0020.1 990113 13.0471-5405.2 250136 13.0471-5408.2 250138					D=54 D=54 Dichtungssatz Verbindungsschrauben Rep.Satz Bremshebel Handbremshebel Handbremshebel Rep.Satz Nachstellung Rep.Satz Rückstellwelle	ATE ATE ATE
	U 1100 U 1150 U 800 U 900								13.0460-6031.2 606031 24.8190-0403.2 620403	2				29581 15,0 /WE Warnkontakt L=315mm	ATE

MERCEDES BENZ UNIMOG (BM 421) 40/45/52/60/600/600 L

	U 40 U 45 U 52 U 60 U 600 U 600 L			01.66 12.77 01.66 12.77 01.66 12.77 01.66 12.77 01.77 01.77					03.2320-0201.3 010234 24.3526-0810.3 340037	1				Hz 28,57/20,64 Bremslichtschalter	ATE
	U 40 U 45 U 52 U 60 U 600 U 600 L			01.66 12.77 01.66 12.77 01.66 12.77 01.66 12.77 01.77 01.77					83.6203-0250.3 330299 24.5201-0220.3 331272 83.6203-0300.3 330386		<input type="checkbox"/>	am Hauptzylinder ³⁾	L=250 L=220 L=300		
	U 40 U 45 U 52 U 60 U 600 U 600 L			01.66 12.77 01.66 12.77 01.66 12.77 01.66 12.77 01.77 01.77					24.5201-0220.3 331272					L=220	
	U 40 U 45 U 52 U 60 U 600 U 600 L			01.66 12.77 01.66 12.77 01.66 12.77 01.66 12.77 01.77 01.77					03.3220-0905.3 020059					Rz 20,64	
	U 40 U 45 U 52 U 60 U 600 U 600 L			01.66 12.77 01.66 12.77 01.66 12.77 01.66 12.77 01.77 01.77					24.2419-0934.3 030060					Gz 19,05	
	U 40 U 45 U 52 U 60 U 600 U 600 L			01.66 12.77 01.66 12.77 01.66 12.77 01.66 12.77 01.77 01.77					83.6203-0250.3 330299 83.6103-0400.3 330226					L=250 L=400	

MERCEDES BENZ UNIMOG (BM 424) 1000/1200

	U 1000 U 1200			01.77 01.82					13.2601-8035.2 210167 13.2601-8037.2 210169 13.2601-8036.2 210168 13.2601-8038.2 210170 13.2601-7015.2 210230 13.2601-7016.2 210231 13.0441-6012.2 250133 13.0441-6001.2 250126 13.0441-6010.2 250132 03.3518-6100.2 390364 03.3518-8000.2 390373				<input type="checkbox"/> - aktive Lüftspieleinstellung ¹⁾ <input type="checkbox"/> - aktive Lüftspieleinstellung ¹⁾ <input type="checkbox"/> + aktive Lüftspieleinstellung ²⁾ <input type="checkbox"/> + aktive Lüftspieleinstellung ²⁾ + Vorgänger/ + Abschirmkappe ⁴⁾ + Vorgänger/ - Abschirmkappe ⁵⁾ L= 52 mm L= 90 mm	D=60 D=60 D=60 D=60 D=60 D=60 Dichtungssatz Dichtungssatz Dichtungssatz Entlüfterventil Entlüfterventil	ATE ATE ATE ATE ATE ATE ATE ATE ATE
	U 1000 U 1200			01.77 01.82					13.0460-6031.2 606031 13.0460-0214.2 610214 24.8190-0403.2 620403	2 4				29581 15,0 /WE Belagsatz-Zubehör Warnkontakt L=315mm	ATE ATE
	U 1000 U 1200			01.77 01.82					24.5201-0220.3 331272 83.6203-0300.3 330386		<input type="checkbox"/>			L=220 L=300	

1) - active clearance adjustment / - recupero autom. del juego / - réglage act.d.jeu fonctionnel / - ajust.activ.jueg.ventilación
 2) + active clearance adjustment / + recupero autom. del juego / + réglage act.d.jeu fonctionnel / + ajust.activ.jueg.ventilación
 3) on the master cylinder / sulla pompa freno / sur le maître-cylindre / a la bomba principal de freno
 4) + predecessor/ + deflector cap / + preceden./+ calotta protez. / + prédecesseur/ + déflecteur / + predecesor/ + tapa deflector
 5) + predecessor/ - deflector cap / + preceden./- calotta protez. / + prédecesseur/ - déflecteur / + predecesor/ - tapa deflector



MERCEDES BENZ UNIMOG (BM 424) 1000/1200

	U 1000 U 1200			01.77 01.82		13.9544-0021.2 210257 13.9544-0022.2 210258 13.0441-5417.2 250118 13.0471-5407.2 250137 13.0471-5409.2 250139 13.8158-0020.1 990113 13.8158-0021.1 990114 13.0471-5405.2 250136 13.0471-5408.2 250138	<input type="checkbox"/> <input type="checkbox"/>	D=54 D=54 Dichtungssatz Verbindungsschrauben Rep.Satz Bremshebel Handbremshebel Rep.Satz Nachstellung Rep.Satz Rückstellwelle	ATE ATE ATE
	U 1000 U 1200			01.77 01.82		13.0460-6031.2 606031 24.8190-0403.2 620403	2	29581 15,0 /WE Warnkontakt L=315mm	ATE
	U 1000 U 1200	VA:001925 VA:001925		01.77 01.82		83.6103-0240.3 330220		L=240	

MERCEDES BENZ UNIMOG (BM 425) 120/150/1300/1500

	U 120 U 1300 U 150 U 1500			01.74 01.77 01.74 01.77	12.77	03.3508-0503.3 310018		Behälter	
	U 120 U 1300 U 150 U 1500			01.74 01.77 01.74 01.77	12.77	13.4571-8005.3 210205 13.4571-8006.3 210206 13.9571-0003.2 210277 13.9571-0004.2 210278 13.0441-5721.2 250123	2 <input type="checkbox"/> li. vor + re. hinter der Achse ¹⁾ 2 <input type="checkbox"/> re. vor + li. hinter der Achse ²⁾ 2 <input type="checkbox"/> li. vor + re. hinter der Achse ¹⁾ 2 <input type="checkbox"/> re. vor + li. hinter der Achse ²⁾	D=57/48 D=57/48 D=57/48 D=57/48 Dichtungssatz	ATE ATE ATE ATE ATE
	U 120 U 1300 U 150 U 1500			01.74 01.77 01.74 01.77	12.77	24.5201-0220.3 331272 83.6203-0200.3 330298	<input type="checkbox"/>	L=220 L=200	
	U 120 U 1300 U 150 U 1500			01.74 01.77 01.74 01.77	12.77	13.9574-7005.2 210275 13.9574-7006.2 210276 24.8190-0029.2 990156 24.8190-0030.2 990157 13.0441-5721.2 250123	<input type="checkbox"/> <input type="checkbox"/> <input type="checkbox"/> <input type="checkbox"/>	D=57/48 D=57/48 Handbremsbetätigung Handbremsbetätigung Dichtungssatz	ATE ATE ATE ATE ATE
	U 120 U 1300 U 150 U 1500			01.74 01.77 01.74 01.77	12.77	83.6103-0300.3 330223		L=300	

MERCEDES BENZ UNIMOG (BM 426) 426

	U 426			01.66 12.77		24.3526-0810.3 340037	1	Bremsichtschalter	
	U 426			01.66 12.77		24.5201-0220.3 331272		L=220	
	U 426			01.66 12.77		83.6203-0300.3 330386 83.6192-0250.3 330726	<input type="checkbox"/>	L=300 L=250	
	U 426			01.66 12.77		03.3220-0905.3 020059		Rz 20,64	



















































MERCEDES BENZ UNIMOG (BM 427) 1000-1650

	U 1000 U 1200 U 1250 U 1400 U 1450					13.2601-8035.2 210167 13.2601-8037.2 210169 13.2601-8036.2 210168 13.2601-8038.2 210170 13.2601-7015.2 210230 13.2601-7016.2 210231 13.0441-6012.2 250133 03.3518-6100.2 390364 03.3518-8000.2 390373	<input type="checkbox"/> - aktive Lüftspieleinstellung ³⁾ <input type="checkbox"/> <input type="checkbox"/> - aktive Lüftspieleinstellung ³⁾ <input type="checkbox"/> <input type="checkbox"/> + aktive Lüftspieleinstellung ⁴⁾ <input type="checkbox"/> + aktive Lüftspieleinstellung ⁴⁾	D=60 D=60 D=60 D=60 D=60 D=60 Dichtungssatz Entlüfterventil Entlüfterventil	ATE ATE ATE ATE ATE ATE ATE ATE ATE
	U 1200 T U 1250 U 1400 U 1450					13.2601-0145.2 210247 13.2601-0146.2 210248	2 <input type="checkbox"/> li. vor + re. hinter der Achse ¹⁾ 2 <input type="checkbox"/> re. vor + li. hinter der Achse ²⁾	D=60 D=60	ATE ATE
	U 1600 U 1650					13.9571-0003.2 210277 13.9571-0004.2 210278 13.0441-5721.2 250123	2 <input type="checkbox"/> li. vor + li. hinter der Achse ⁸⁾ 2 <input type="checkbox"/> re. vor + re. hinter der Achse ⁹⁾	D=57/48 D=57/48 Dichtungssatz	ATE ATE ATE
	U 1000 U 1200 U 1250 U 1400 U 1450					13.0460-6031.2 606031 13.0460-0214.2 610214 24.8190-0403.2 620403	2 4	29581 15,0 /WE Belagsatz-Zubehör Warnkontakt L=315mm	ATE ATE
	U 1000 U 1200 U 1250 U 1400 U 1450					13.9544-0022.2 210258 13.9544-0021.2 210257 13.0441-5417.2 250118 13.0471-5407.2 250137 13.0471-5409.2 250139 13.8158-0020.1 990113 13.8158-0021.1 990114 13.0471-5405.2 250136 13.0471-5408.2 250138	<input type="checkbox"/> <input type="checkbox"/> <input type="checkbox"/> <input type="checkbox"/> <input type="checkbox"/> <input type="checkbox"/> <input type="checkbox"/>	D=54 D=54 Dichtungssatz Verbindungsschrauben Rep.Satz Bremshebel Handbremshebel Handbremshebel Rep.Satz Nachstellung Rep.Satz Rückstellwelle	ATE ATE ATE ATE ATE ATE ATE ATE
	U 1250 U 1400					13.2544-0019.2 210251 13.2544-0020.2 210252	2 <input type="checkbox"/> li. vor + re. hinter der Achse ¹⁾ 2 <input type="checkbox"/> re. vor + li. hinter der Achse ²⁾	D=54 D=54	ATE ATE

¹⁾ left i. front + right beh.axle / sinist.davant.+destr.diet.ass. / gauche dev. + droite derr.ess. / izqu.adel.+ derech.detrás eje
²⁾ right in front+left beh.axle / destr.davant.+sinist.diet.ass. / droite dev. + gauche derr.ess. / derech.adel.+ izqu.detrás eje
³⁾ - active clearance adjustment / - recupero autom. del juego / - réglage act.d.jeu fonctionnel / - ajust.activ.jueg. ventilación
⁴⁾ + active clearance adjustment / + recupero autom. del juego / + réglage act.d.jeu fonctionnel / + ajust.activ.jueg. ventilación

⁵⁾ - FA 737.360 / - A 737.360 / - ess. AV 737.360 / - ED 737.360
⁶⁾ + FA 737.360 / + A 737.360 / + ess. AV 737.360 / + ED 737.360
⁷⁾ without bleed screw / senza vite di spurgo / sans vis de purge / sin tornillo de purga
⁸⁾ left in front + left behind axle / davanti a sinistra+dietro a sinistra dell'assale / avant gauche + arrière gauche essieu / izquierda adelante+izquierda atrás eje
⁹⁾ right in front + right behind axle / davanti a destra+dietro a destra dell'assale / avant droite + arrière droite essieu / derecha adelante+derecha atrás eje
¹⁰⁾ - RA 747.361 / - P 747.361 / - ess. AR 747.361 / - ET 747.361
¹¹⁾ - RA 747.360 / - P 747.360 / - ess. AR 747.360 / - ET 747.360



									
MERCEDES BENZ UNIMOG (BM 427) 1000-1650									
	U 1450				+ HA 747.361 ¹⁾	13.2544-0019.2 210251 13.2544-0020.2 210252	2  li. vor + re. hinter der Achse ²⁾ 2  re. vor + li. hinter der Achse ³⁾	D=54 D=54	ATE ATE
	U 1600 U 1650				- HA 747.430 ⁴⁾ - HA 747.431 ⁵⁾	13.9574-7005.2 210275 13.9574-7006.2 210276 24.8190-0029.2 990156 24.8190-0030.2 990157 13.0441-5721.2 250123	   	D=57/48 D=57/48 Handbremsbetätigung Handbremsbetätigung Dichtungssatz	ATE ATE ATE ATE ATE
	U 1600 U 1650				+ HA 747.430 ⁶⁾ + HA 747.431 ⁷⁾	13.9574-7005.2 210275 13.9574-7006.2 210276 13.0441-5721.2 250123	 	D=57/48 D=57/48 Dichtungssatz	ATE ATE ATE
	U 1000 U 1200 U 1250 U 1400 U 1450				- HA 747.361 ⁸⁾ - HA 747.360 ⁹⁾ - HA 747.361 ⁸⁾	13.0460-6031.2 606031 24.8190-0403.2 620403	2	29581 15,0 /WE Warnkontakt L=315mm	ATE
MERCEDES BENZ UNIMOG (BM 431) 431.2									
	U 431.2			01.60		24.5201-0220.3 331272		L=220	
	U 431.2			01.60		83.6203-0300.3 330386 83.6192-0250.3 330726		L=300 L=250	
	U 431.2			01.60		03.3220-0905.3 020059		Rz 20,64	
MERCEDES BENZ UNIMOG (BM 435) 435/1300 L/1700/1700 L									
	U 1300 L U 1700 U 1700 L U 435			01.78 01.77 01.77 01.74 12.77		03.3508-0503.3 310018		Behälter	
	U 1700 U 1700 L U 435			01.77 01.77 01.74 12.77		13.4571-8005.3 210205 13.4571-8006.3 210206 13.9571-0003.2 210277 13.9571-0004.2 210278 13.0441-5721.2 250123	2  li. vor + re. hinter der Achse ²⁾ 2  re. vor + li. hinter der Achse ³⁾ 2  li. vor + re. hinter der Achse ²⁾ 2  re. vor + li. hinter der Achse ³⁾	D=57/48 D=57/48 D=57/48 D=57/48	ATE ATE ATE ATE
	U 1300 L			01.78		13.2601-8035.2 210167 13.2601-8037.2 210169 13.2601-8036.2 210168 13.2601-8038.2 210170 13.2601-7015.2 210230 13.2601-7016.2 210231 13.0441-6012.2 250133 13.0441-6001.2 250126 13.0441-6010.2 250132 03.3518-6100.2 390364 03.3518-8000.2 390373	 - aktive Lüftspieleinstellung ¹⁰⁾  - aktive Lüftspieleinstellung ¹⁰⁾  - aktive Lüftspieleinstellung ¹⁰⁾  + aktive Lüftspieleinstellung ¹¹⁾  + aktive Lüftspieleinstellung ¹¹⁾	D=60 D=60 D=60 D=60 D=60 D=60	ATE ATE ATE ATE ATE ATE
	U 1300 L			01.78		13.0460-6031.2 606031 13.0460-0214.2 610214 24.8190-0403.2 620403	2 4	29581 15,0 /WE Belagsatz-Zubehör Warnkontakt L=315mm	ATE ATE
	U 1700 U 1700 L U 435 U 1300 L			01.77 01.77 01.74 12.77 01.77		24.5201-0220.3 331272 83.6203-0200.3 330298 83.6203-0200.3 330298		L=220 L=200 L=200	
	U 1700 U 1700 L U 435			01.77 01.77 01.74 12.77		13.9574-7005.2 210275 13.9574-7006.2 210276 24.8190-0029.2 990156 24.8190-0030.2 990157 13.0441-5721.2 250123	   	D=57/48 D=57/48 Handbremsbetätigung Handbremsbetätigung Dichtungssatz	ATE ATE ATE ATE ATE
	U 1300 L			01.78		13.9544-0021.2 210257 13.9544-0022.2 210258 13.0441-5417.2 250118 13.0471-5407.2 250137 13.0471-5409.2 250139 13.8158-0020.1 990113 13.8158-0021.1 990114 13.0471-5405.2 250136 13.0471-5408.2 250138	     	D=54 D=54 Dichtungssatz Verbindungsschrauben Rep.Satz Bremshebel Handbremshebel Handbremshebel Rep.Satz Nachstellung Rep.Satz Rückstellwelle	ATE ATE ATE ATE ATE ATE ATE
	U 1300 L			01.78		13.0460-6031.2 606031		29581 15,0 /WE	ATE
	U 1700 U 1700 L U 435 U 1300 L			01.77 01.77 01.74 12.77 01.77		83.6103-0300.3 330223 83.6103-0240.3 330220		L=300 L=240	

1) + RA 747.361 / + P 747.361 / + ess. AR 747.361 / + ET 747.361
2) left i. front + right beh.axle / sinist.davant.+destr.diet.ass. / gauche dev. + droite derr.ess. / izqu.adel.+ derech.detrás eje
3) right in front+left beh.axle / destr.davant.+sinist.diet.ass. / droite dev. + gauche derr.ess. / derech.adel.+ izqu.detrás eje
4) - RA 747.430 / - P 747.430 / - ess. AR 747.430 / - ET 747.430
5) - RA 747.431 / - P 747.431 / - ess. AR 747.431 / - ET 747.431
6) + RA 747.430 / + P 747.430 / + ess. AR 747.430 / + ET 747.430

7) + RA 747.431 / + P 747.431 / + ess. AR 747.431 / + ET 747.431
8) - RA 747.361 / - P 747.361 / - ess. AR 747.361 / - ET 747.361
9) - RA 747.360 / - P 747.360 / - ess. AR 747.360 / - ET 747.360
10) - active clearance adjustment / - recupero autom. del gioco / - réglage act.d.jeu fonctionel / - ajust.activ.jueg. ventilación
11) + active clearance adjustment / + recupero autom. del juego / + réglage act.d.jeu fonctionel / + ajust.activ.jueg. ventilación
12) + predecessor / + deflector cap / + preceden./+ calotta protez. / + prédeceseur / + déflecteur / + predecesor / + tapa deflector

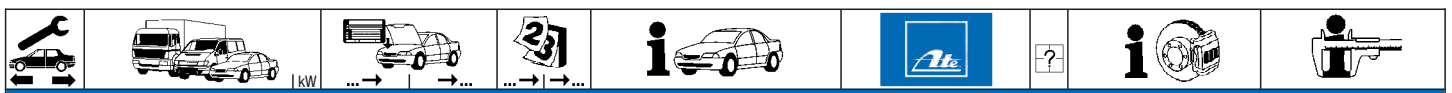

MERCEDES BENZ UNIMOG (BM 436) 1300/1700

	U 1300					13.2601-8035.2 210167 13.2601-8037.2 210169 13.2601-8036.2 210168 13.2601-8038.2 210170 13.2601-7015.2 210230 13.2601-7016.2 210231 13.0441-6012.2 250133 03.3518-6100.2 390364 03.3518-8000.2 390373	<input type="checkbox"/> - aktive Lüftspieleinstellung ¹⁾ <input type="checkbox"/> - aktive Lüftspieleinstellung ¹⁾ <input type="checkbox"/> + aktive Lüftspieleinstellung ²⁾ <input type="checkbox"/> + aktive Lüftspieleinstellung ²⁾ L= 52 mm L= 90 mm	D=60 D=60 D=60 D=60 D=60 D=60 Dichtungssatz Entlüfterventil Entlüfterventil	ATE ATE ATE ATE ATE ATE
	U 1700				ohne Entlüfterschraube ³⁾	13.9571-0003.2 210277 13.9571-0004.2 210278 13.0441-5721.2 250123	2 <input type="checkbox"/> li. vor + li. hinter der Achse ⁴⁾ 2 <input type="checkbox"/> re. vor + re. hinter der Achse ⁵⁾	D=57/48 D=57/48 Dichtungssatz	ATE ATE ATE
	U 1300					13.0460-6031.2 606031 13.0460-0214.2 610214 24.8190-0403.2 620403	2 4	29581 15,0 /WE Belagsatz-Zubehör Warnkontakt L=315mm	ATE ATE
	U 1300					13.9544-0022.2 210258 13.9544-0021.2 210257 13.0441-5417.2 250118 13.0471-5407.2 250137 13.0471-5409.2 250139 13.8158-0021.1 990114 13.8158-0020.1 990113 13.0471-5405.2 250136 13.0471-5408.2 250138	<input type="checkbox"/> <input type="checkbox"/> <input type="checkbox"/> <input type="checkbox"/> <input type="checkbox"/> <input type="checkbox"/> <input type="checkbox"/> <input type="checkbox"/>	D=54 D=54 Dichtungssatz Verbindungsschrauben Rep.Satz Bremshebel Handbremshebel Handbremshebel Rep.Satz Nachstellung Rep.Satz Rückstellwelle	ATE ATE ATE ATE ATE ATE ATE ATE
	U 1700					13.9574-7005.2 210275 13.9574-7006.2 210276 24.8190-0029.2 990156 24.8190-0030.2 990157 13.0441-5721.2 250123	<input type="checkbox"/> <input type="checkbox"/> <input type="checkbox"/> <input type="checkbox"/>	D=57/48 D=57/48 Handbremsbetätigung Handbremsbetätigung Dichtungssatz	ATE ATE ATE ATE ATE
	U 1300					13.0460-6031.2 606031 24.8190-0403.2 620403	2	29581 15,0 /WE Warnkontakt L=315mm	ATE

MERCEDES BENZ UNIMOG (BM 437.1) 1350-2450

	U 1350 U 1550 L				- VA 737.361/362 ⁶⁾	13.2601-8035.2 210167 13.2601-8037.2 210169 13.2601-8036.2 210168 13.2601-8038.2 210170 13.2601-7015.2 210230 13.2601-7016.2 210231 13.0441-6012.2 250133 03.3518-6100.2 390364 03.3518-8000.2 390373	<input type="checkbox"/> - aktive Lüftspieleinstellung ¹⁾ <input type="checkbox"/> - aktive Lüftspieleinstellung ¹⁾ <input type="checkbox"/> + aktive Lüftspieleinstellung ²⁾ <input type="checkbox"/> + aktive Lüftspieleinstellung ²⁾ L= 52 mm L= 90 mm	D=60 D=60 D=60 D=60 D=60 D=60 Dichtungssatz Entlüfterventil Entlüfterventil	ATE ATE ATE ATE ATE ATE
	U 1550 L				+ VA 737.361/362 ⁷⁾	13.2601-0145.2 210247 13.2601-0146.2 210248	2 <input type="checkbox"/> li. vor + re. hinter der Achse ⁸⁾ 2 <input type="checkbox"/> re. vor + li. hinter der Achse ⁹⁾	D=60 D=60	ATE ATE
	U 1550 L/38 U 1700 U 1750 U 1800 U 1850 U 2100 U 2150 U 2400 U 2450				ohne Entlüfterschraube ³⁾ ohne Entlüfterschraube ³⁾ ohne Entlüfterschraube ³⁾ ohne Entlüfterschraube ³⁾ ohne Entlüfterschraube ³⁾ ohne Entlüfterschraube ³⁾ ohne Entlüfterschraube ³⁾ ohne Entlüfterschraube ³⁾	13.9571-0003.2 210277 13.9571-0004.2 210278 13.0441-5721.2 250123	2 <input type="checkbox"/> li. vor + li. hinter der Achse ⁴⁾ 2 <input type="checkbox"/> re. vor + re. hinter der Achse ⁵⁾	D=57/48 D=57/48 Dichtungssatz	ATE ATE ATE ATE ATE ATE ATE ATE ATE
	U 1350 U 1550 L				- VA 737.361/362 ⁶⁾	13.0460-6031.2 606031 13.0460-0214.2 610214 24.8190-0403.2 620403	2 4	29581 15,0 /WE Belagsatz-Zubehör Warnkontakt L=315mm	ATE ATE
	U 1350 U 1550 L				- HA 747.362/364 ¹⁰⁾	13.9544-0021.2 210257 13.9544-0022.2 210258 13.0441-5417.2 250118 13.0471-5407.2 250137 13.0471-5409.2 250139 13.8158-0020.1 990113 13.8158-0021.1 990114 13.0471-5405.2 250136 13.0471-5408.2 250138	<input type="checkbox"/> <input type="checkbox"/> <input type="checkbox"/> <input type="checkbox"/> <input type="checkbox"/> <input type="checkbox"/> <input type="checkbox"/> <input type="checkbox"/>	D=54 D=54 Dichtungssatz Verbindungsschrauben Rep.Satz Bremshebel Handbremshebel Handbremshebel Rep.Satz Nachstellung Rep.Satz Rückstellwelle	ATE ATE ATE ATE ATE ATE ATE ATE ATE
	U 1550 L				+ HA 747.362/364 ¹¹⁾	13.2544-0019.2 210251 13.2544-0020.2 210252	2 <input type="checkbox"/> li. vor + re. hinter der Achse ⁸⁾ 2 <input type="checkbox"/> re. vor + li. hinter der Achse ⁹⁾	D=54 D=54	ATE ATE
	U 1550 L/38 U 1700 U 1750 U 1800 U 1850 U 2100 U 2150 U 2400 U 2450				- HA 747.800 ¹²⁾	13.9574-7005.2 210275 13.9574-7006.2 210276 24.8190-0029.2 990156 24.8190-0030.2 990157 13.0441-5721.2 250123	<input type="checkbox"/> <input type="checkbox"/> <input type="checkbox"/> <input type="checkbox"/>	D=57/48 D=57/48 Handbremsbetätigung Handbremsbetätigung Dichtungssatz	ATE ATE ATE ATE ATE ATE ATE ATE ATE
	U 1350 U 1550 L				- HA 747.362/364 ¹⁰⁾	13.0460-6031.2 606031 24.8190-0403.2 620403	2	29581 15,0 /WE Warnkontakt L=315mm	ATE

MERCEDES BENZ (R107) 280 SL-560 SL (71-89)

	280 SL				09.74 07.85	03.6855-1202.4 300056		9" Tandem	ATE
	280 SLC				09.74 03.80				
	350 SL				02.71 02.80				
	350 SLC				09.71 02.80				
	380 SL				03.80 08.85				

¹⁾ - active clearance adjustment / - recupero autom. del gioco / - réglage act.d.ieu fonctionnel / - ajust.activ.jueg. ventilación

²⁾ + active clearance adjustment / + recupero autom. del gioco / + réglage act.d.ieu fonctionnel / + ajust.activ.jueg. ventilación

³⁾ without bleed screw / senza vite di spurgo / sans vis de purge / sin tornillo de purga

⁴⁾ left in front + left behind axle / davanti a sinistra+dietro a sinistra dell'assale / avant gauche + arrière gauche essieu / izquierda adelante+izquierda atrás eje

⁵⁾ right in front + right behind axle / davanti a destra+dietro a destra dell'assale / avant droite + arrière droite essieu / derecha adelante+derecha atrás eje

⁶⁾ - FA 737.361/362 / - A 737.361/362 / - ess. AV 737.361/362 / - ED 737.361/362

⁷⁾ + FA 737.361/362 / + A 737.361/362 / + ess. AV 737.361/362 / + ED 737.361/362

⁸⁾ left i.front + right beh.axle / sinist.davant.+detr.diet.ass. / gauche dev. + droite derr.ess. / izqu.adel.+ derech.detrás eje

⁹⁾ right in front+left beh.axle / destr.davant.+sinist.diet.ass. / droite dev. + gauche derr.ess. / derech.adel.+ izqu.detrás eje

¹⁰⁾ - RA 747.362/364 / - P 747.362/364 / - ess. AR 747.362/364 / - ET 747.362/364

¹¹⁾ + RA 747.362/364 / + P 747.362/364 / + ess. AR 747.362/364 / + ET 747.362/364

¹²⁾ - RA 747.800 / - P 747.800 / - ess. AR 747.800 / - ET 747.800



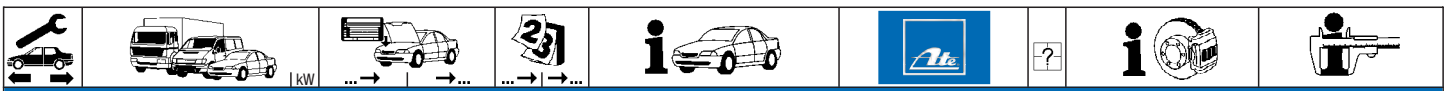

MERCEDES BENZ (R107) 280 SL-560 SL (71-89)

	380 SLC 450 SL 450 SLC 450 SLC 5.0 500 SL 500 SLC			03.80 03.73 03.73 04.78 05.80 05.78	08.81 09.80 09.80 02.80 08.85 07.81		03.6855-1202.4	300056			9" Tandem	ATE
	350 SL 350 SLC 450 SL 450 SLC		011507 009849 021171 007849	02.71 09.71 03.73 03.73			03.2123-1003.3 24.3526-0810.3	010175 340037	1		THz 23,81 Bremslichtschalter	ATE
	280 SL 280 SLC 350 SL 350 SLC 450 SL 450 SLC	011508 009850 021172 007850	000988 001211 012083 010576 028344 011205	09.74 09.74			03.2123-3402.3	010181			THz 23,81	ATE
	280 SL 280 SLC 350 SL 350 SLC 380 SL 380 SLC 450 SL 450 SLC 450 SLC 5.0 500 SL	000989 001212 012084 010577 028345 011206	017463 028725 003462	 03.80 03.80 03.80 04.78 05.80	03.80 02.80 02.80 08.81 09.80 09.80 02.80		03.2023-0166.3	010015			THz 23,81/19,05	ATE
	280 SL 380 SL 500 SL	017464 028726 003463			07.85 08.85 08.85		03.2025-0111.3	010033			THz 25,40/19,05	ATE
	300 SL 420 SL 500 SL 560 SL			09.85 09.85 09.85 08.85	08.89 08.89 08.89 07.89	+ USA J AUS	03.2025-0211.3	010034			THz 25,40/19,05	ATE
	280 SL 280 SLC 350 SL 350 SLC 450 SL 450 SLC			09.74 09.74 02.71 09.71 03.73 03.73	07.75 07.75 07.75 07.75 07.75 07.75		03.3508-8753.3	310049			Behälter + WE	
	350 SL 350 SLC		009599 005715	02.71 09.71			13.2571-8013.2 13.2571-8014.2 13.0441-5718.2	210123 210124 250120	<input type="checkbox"/> <input type="checkbox"/>		D=57 D=57 Dichtungssatz	ATE ATE ATE
	280 SL 280 SLC 350 SL 350 SLC 450 SL 450 SLC 450 SLC 5.0 500 SLC	009600 005716	007869 008365 062584 030280 001627 001627	09.74 09.74 03.73 03.73 04.78 05.78	02.80 02.80		13.2601-8027.2 13.2601-8028.2 24.9440-8027.5 24.9440-8028.5 13.0441-6001.2	210159 210160 230051 230052 250126	<input type="checkbox"/> <input type="checkbox"/> <input type="checkbox"/> <input type="checkbox"/> <input type="checkbox"/>		D=60 D=60 D=40 D=40 Dichtungssatz	ATE ATE ATE ATE ATE
	280 SL 280 SLC 380 SL 380 SLC 450 SL 450 SLC 450 SLC 5.0 500 SL 500 SLC	007870 008366		07.85 03.80 03.80 03.80 09.80 09.80 02.80 05.80 08.85 07.81	03.80 08.85 08.81 09.80 09.80 02.80 08.85 07.81		13.2601-8034.2 13.2601-8033.2 13.0441-6003.2	210166 210165 250128	<input type="checkbox"/> <input type="checkbox"/>		D=60 D=60 Dichtungssatz	ATE ATE ATE
	300 SL 420 SL 500 SL 560 SL			09.85 09.85 09.85 08.85	08.89 08.89 08.89 07.89	+ USA J AUS	13.0441-4016.2	250081			Dichtungssatz	ATE
	350 SL 350 SLC		009599 005715	02.71 09.71			13.0460-6027.2	606027			20011 15,0	ATE
	280 SL 280 SLC 350 SL 350 SLC 450 SL 450 SLC 450 SLC 5.0 500 SLC	009600 005716	007869 008365 062584 030280 001627 001627	09.74 09.74 03.73 03.73 04.78 05.78	02.80 02.80		13.0460-9028.2 24.8190-0401.2	609028 620401	4		20392 15,0 /WE Warnkontakt L=95mm	ATE
	280 SL 280 SLC 380 SL 380 SLC 450 SL 450 SLC 450 SLC 5.0 500 SL 500 SLC	007870 008366		07.85 03.80 03.80 03.80 09.80 09.80 02.80 05.80 08.85 07.81	03.80 08.85 08.81 09.80 09.80 02.80 08.85 07.81		13.0460-9029.2 13.0460-0132.2 24.8190-0401.2	609029 610132 620401	4		20341 16,7 /WE Belagsatz-Zubehör Warnkontakt L=95mm	ATE ATE
	300 SL 420 SL 500 SL			09.85 09.85 09.85	08.89 08.89 08.89		13.0460-4037.2 24.8190-0401.2	604037 620401	4		21024 17,5 /WE Warnkontakt L=95mm	ATE



MERCEDES BENZ (R107) 280 SL-560 SL (71-89)

	560 SL			08.85	07.89	+ USA J AUS	13.0460-4037.2 24.8190-0401.2	604037 620401	4		21024 17,5 /WE Warnkontakt L=95mm	ATE
	280 SL 280 SLC 350 SL 350 SLC 450 SL 450 SLC 450 SLC 5.0 500 SLC	009600 005716	007869 008365	09.74 09.74			24.0122-0106.1	422106			278 22,0 20,0 V L	
	280 SL 280 SLC 380 SL 380 SLC 450 SL 450 SLC 450 SLC 5.0 500 SL 500 SLC	007870 008366		07.85 03.80 03.80	08.85 08.85		24.0122-0116.1	422116			278 22,0 19,4 V	
	300 SL 420 SL 500 SL 560 SL	062585 030281 001628 001628	062584 030280 001627 001627	03.73 03.73 04.78 05.78	02.80 02.80							
	280 SL 280 SLC 380 SL 380 SLC 450 SL 450 SLC 450 SLC 5.0 500 SL 500 SLC			09.85 09.85 09.85 08.85	08.89 08.89	+ USA J AUS	24.0122-0123.1	422123			284 22,0 19,4 V L +S +B	
	280 SL 280 SLC 350 SL 350 SLC 380 SL 380 SLC 450 SL 450 SLC 450 SLC 5.0 500 SL 500 SLC			09.74 09.74 02.71 09.71 03.80 03.80 03.73 03.73 04.78 05.80 05.78	07.85 03.80 02.80 02.80 08.85 08.81 09.80 09.80 02.80 08.85 07.81		24.5170-0426.3	331452	2		L=426	
	300 SL 420 SL 500 SL 560 SL			09.85 09.85 09.85 08.85	08.89 08.89	+ USA J AUS	24.5101-0346.3	331406	2		L=346	
	280 SL 280 SLC 300 SL 350 SL 350 SLC 380 SLC 450 SL			09.74 09.74 09.85 02.71 09.71 03.80 03.73	07.85 03.80 08.89 02.80 02.80 08.81 09.80	+ USA	13.2381-8027.2 13.2381-8028.2 13.0441-3811.2	210033 210034 250067	<input type="checkbox"/> <input type="checkbox"/>		D=38 D=38 Dichtungssatz	ATE ATE ATE
	380 SL 420 SL 450 SL 450 SLC 450 SLC 5.0 500 SL 500 SLC 560 SL			03.80 09.85 03.73 03.73 04.78 05.80 05.78 08.85	08.85 08.89 09.80 09.80 02.80 08.89 07.81	- USA	13.2381-8029.2 13.2381-8030.2 13.0441-3811.2	210035 210036 250067	<input type="checkbox"/> <input type="checkbox"/>		D=38 D=38 Dichtungssatz	ATE ATE ATE
	280 SL 280 SLC 350 SL 350 SLC 450 SL 450 SLC 450 SLC 5.0 500 SLC		006644 007435 014752 013627 058150 028254 001199 001199	09.74 09.74 02.71 09.71 03.73 03.73 04.78 05.78			13.0460-4036.2 13.0460-3804.2 13.0460-0029.2 13.0460-0912.2	604036 603804 610029 610912		+ Anti-Noise-Blech 1)	21035 15,0 21035 15,0 Belagsatz-Zubehör Belagsatz-Zubehör	ATE ATE ATE BDX
	280 SL 280 SLC 300 SL 350 SL 350 SLC 380 SL 380 SLC 420 SL 450 SL 450 SLC 450 SLC 5.0 500 SL 500 SLC 560 SL	006645 007436		07.85 03.80 09.85	08.89 08.89		13.0460-3804.2 13.0460-0029.2 13.0460-0912.2	603804 610029 610912			21035 15,0 Belagsatz-Zubehör Belagsatz-Zubehör	ATE ATE BDX
	350 SL 350 SLC 380 SL 420 SL 450 SL 450 SLC 450 SLC 5.0 500 SL 500 SLC 560 SL	014753 013628		02.80 02.80 03.80 03.80 09.85	02.80 02.80 08.85 08.81 08.89							
	280 SL 280 SLC 300 SL 350 SL 350 SLC 380 SLC	058151 028255 001200		09.80 09.80 02.80	09.80 09.80							
	500 SL 500 SLC 560 SL	001200		05.80 07.81 08.85	08.89 07.81	+ USA J AUS						
	280 SL 280 SLC 300 SL 350 SL 350 SLC 380 SLC			09.74 09.74 09.85 02.71 09.71 03.80	07.85 03.80 08.89 02.80 02.80 08.81		24.0110-0185.1	410185			279 10,0 8,3 +S +B	
	380 SL 420 SL 450 SL 450 SLC			03.80 09.85 03.73 03.73	08.85 08.89 09.80 09.80		24.0110-0185.1	410185			279 10,0 8,3 +S +B	

1) + shim / + lamierino antirumore / + tôle anti-bruit / + placa anti-ruidos



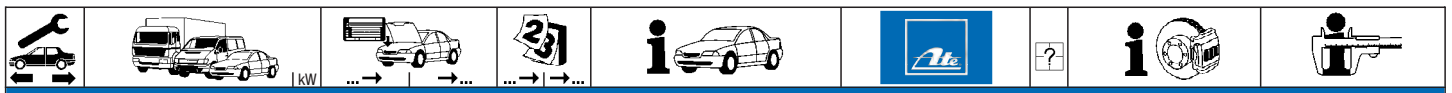

MERCEDES BENZ (R107) 280 SL-560 SL (71-89)



























	450 SLC 5.0 500 SL 500 SLC 560 SL			04.78 05.80 05.78 08.85	02.80 08.89 07.81 07.89		24.0110-0185.1	410185			279 10,0 8,3 +S +B
	350 SL 350 SLC 280 SL 280 SLC 300 SL 350 SL 350 SLC			02.71 09.71 09.74 09.74 09.85 04.73 04.73	03.73 03.73 07.85 03.80 08.89 02.80 02.80	+ USA J AUS	83.6204-0282.3	330309	2		L=280
	380 SL 380 SLC 420 SL 450 SL 450 SLC 450 SLC 5.0 500 SL 500 SLC 560 SL			03.80 03.80 09.85 03.73 03.73 04.78 05.80 05.78 08.85	08.85 08.81 08.89 09.80 09.80 02.80 08.89 07.81 07.89	+ USA J AUS	83.6204-0280.3	330732	2		L=280
	280 SL 280 SLC 300 SL 350 SL 350 SLC 380 SL 380 SLC 420 SL 450 SL 450 SLC 450 SLC 5.0 500 SL 500 SLC 560 SL			09.74 09.74 09.85 02.71 09.71 03.80 03.80 09.85 03.73 03.73 04.78 05.80 05.78 08.85	07.85 03.80 08.89 02.80 02.80 08.85 08.81 08.89 09.80 09.80 02.80 08.89 07.81 07.89	+ USA J AUS	03.0137-0171.2 03.0137-9002.2	650171 669002			160 x 25 /Zub Bremsbacken-Zubehör
	280 SL 280 SLC 350 SL 350 SLC		011427	09.74 09.74 02.71 09.71	03.80 02.80 02.80 02.80		24.2419-0937.3	030063			Gz 19,05 FTE
	280 SL 300 SL	011428		07.85 09.85	08.89		24.2419-0921.3	030050			Gz 19,05
	280 SL 280 SLC		011568	09.74 09.74	03.80		03.2523-0811.3 03.0450-2311.2	040019 082311			Nz 23,81 Nz Reparatursatz
	280 SL 300 SL	011569		07.85 09.85	08.89		24.2523-1210.3 03.0450-2311.2	040105 082311		+ Kolbenstange L=99 mm ¹⁾	Nz 23,81 Nz Reparatursatz
	280 SL 280 SLC 350 SL 350 SLC		011568	09.74 09.74 02.71 09.71	03.80 03.80 02.80 02.80		24.5901-0225.3	331288			L=225

MERCEDES BENZ (R113) 230 SL-280 SL (63-71)

	250 SL 280 SL	006619		11.67	01.68 03.71		03.6855-1202.4	300056			9" Tandem ATE
	230 SL 250 SL 280 SL		002979	11.66	01.68 03.71		03.2123-0609.3 03.2123-0614.3	010171 010172			THz 23,81 20/12 ATE THz 23,81 19/13 ATE
	250 SL 280 SL	002980		11.67	01.68 03.71		03.2123-1003.3 24.3526-0810.3	010175 340037	1		THz 23,81 Bremslichtschalter ATE
	230 SL 250 SL 280 SL		002979	11.66	12.65		03.0101-3501.2	390001			Behälter Rep. Satz
	250 SL 280 SL	002980		11.67	01.68 03.71		03.3508-8753.3	310049			Behälter + WE
	230 SL 250 SL 280 SL			11.66 11.67	12.65 01.68 03.71		13.2571-9998.2 13.2571-9999.2 13.0441-5718.2	210133 210134 250120	<input checked="" type="checkbox"/> <input checked="" type="checkbox"/>		D=57 ATE D=57 ATE Dichtungssatz ATE
	230 SL 250 SL 280 SL			11.66 11.67	12.65 01.68 03.71		13.0460-6027.2 13.0460-0026.2 13.0460-0910.2	606027 610026 610910			20011 15,0 ATE Belagsatz-Zubehör ATE Belagsatz-Zubehör BDX
	230 SL 250 SL 280 SL			11.66 11.67	12.65 01.68 03.71		24.0113-0111.1 24.0113-0112.1	413111 413112			253 12,7 11,1 273 12,6 11,0
	230 SL 250 SL 280 SL			11.66 11.67	12.65 01.68 03.71		24.5170-0426.3	331452	2		L=426
	250 SL 280 SL			11.66 11.67	01.68 03.71		13.2423-8009.2 13.2423-8010.2 13.0441-4206.2	210063 210064 250087	<input checked="" type="checkbox"/> <input checked="" type="checkbox"/>		D=42 ATE D=42 ATE Dichtungssatz ATE
	250 SL 280 SL			11.66 11.67	01.68 03.71		13.0460-4036.2 13.0460-3804.2 13.0460-0029.2	604036 603804 610029		+ Anti-Noise-Blech ²⁾	21035 15,0 ATE 21035 15,0 ATE Belagsatz-Zubehör ATE
	250 SL 280 SL			11.66 11.67	01.68 03.71		24.0110-0185.1	410185			279 10,0 8,3 +S +B

¹⁾ + piston rod L=99mm / + puntalino L=99mm / + tige de commande L=99mm / + vástago del émbolo L=99mm

²⁾ + shim / + lamierino antirumore / + tôle anti-bruit / + placa anti-ruidos

											
MERCEDES BENZ (R113) 230 SL-280 SL (63-71)											
	230 SL			01.63	12.65		83.6104-0210.3 83.6204-0220.3	330473 330308	<input type="checkbox"/> <input type="checkbox"/>		L=210 L=220
	250 SL 280 SL			11.66 11.67	01.68 03.71		83.6104-0220.3 83.6204-0220.3	330474 330308	<input type="checkbox"/> <input type="checkbox"/>		L=220 L=220
	230 SL			01.63	12.65		03.3219-3401.3	020049			Rz 19,05
	250 SL 280 SL			11.66 11.67	01.68 03.71		03.0137-0171.2 03.0137-9002.2	650171 669002			160 x 25 /Zub Bremsbacken-Zubehör
MERCEDES BENZ (R129) SL-Klasse (89-93)											
	300 SL 300 SL 24 500 SL			06.89 06.89 06.89	07.93 07.93 07.93		03.2025-0211.3	010034			THz 25,40/19,05 ATE
	300 SL 300 SL 24 500 SL 600 SL V12			06.89 06.89 06.89 06.92	07.93 07.93 07.93 07.93		24.9442-8003.5 24.9442-8004.5 13.0441-4214.2	230053 230054 250091	<input type="checkbox"/> <input type="checkbox"/>		D=42/38 D=42/38 Dichtungssatz Dichtungssatz ATE
	300 SL 300 SL 24 500 SL 600 SL V12			06.89 06.89 06.89 06.92	07.93 07.93 07.93 07.93		13.0460-4201.2 13.0460-0219.2 24.8190-0401.2	604201 610219 620401	4		21153 17,5 /WE Belagsatz-Zubehör Warnkontakt L=95mm ATE
	300 SL 300 SL 24 500 SL 600 SL V12			06.89 06.89 06.89 06.92	07.93 07.93 07.93 07.93		24.0128-0103.1 13.8190-0242.1	428103 990124	4		300 28,0 25,4 V L +B Halterschraube
	300 SL 300 SL 24 500 SL 600 SL V12			06.89 06.89 06.89 06.92	07.93 07.93 07.93 07.93		24.0130-0121.1 24.0130-0122.1 13.8190-0242.1	430121 430122 990124	<input type="checkbox"/> <input type="checkbox"/> 4		320 30,0 28,0 V L +B 320 30,0 28,0 V L +B Halterschraube
	300 SL 300 SL 24 500 SL 600 SL V12			06.89 06.89 06.89 06.92	07.93 07.93 07.93 07.93		24.5101-0346.3	331406	2		L=346
	300 SL 300 SL 24 500 SL 600 SL V12			06.89 06.89 06.89 06.92	07.93 07.93 07.93 07.93		24.9238-8035.5 24.9238-8036.5 13.0441-3817.2	230025 230026 250071	<input type="checkbox"/> <input type="checkbox"/>		D=38 D=38 Dichtungssatz ATE
	300 SL 300 SL 24 500 SL 600 SL V12			06.89 06.89 06.89 06.92	07.93 07.93 07.93 07.93		13.2421-8025.2 13.2421-8026.2 13.0441-4216.2	210061 210062 250093	<input type="checkbox"/> <input type="checkbox"/>		D=42 D=42 Dichtungssatz ATE
	300 SL 300 SL 24 500 SL 600 SL V12			06.89 06.89 06.89 06.92	07.93 07.93 07.93 07.93		13.0460-3805.2 13.0470-3805.2 13.0460-0215.2 24.8190-0401.2	603805 LD3805 610215 620401	4	+ ASR	21197 15,0 /WE 21197 15,0 /WE Belagsatz-Zubehör Warnkontakt L=95mm ATE
	300 SL 300 SL 24 500 SL 600 SL V12			06.89 06.89 06.89 06.92	07.93 07.93 07.93 07.93		13.0460-4047.2 13.0470-4047.2 13.0460-0236.2 24.8190-0401.2	604047 LD4047 610236 620401	4	+ ASR	21305 15,7 /WE 21305 15,7 /WE Belagsatz-Zubehör Warnkontakt L=95mm ATE
	300 SL 300 SL 24 500 SL 600 SL V12			06.89 06.89 06.89 06.92	07.93 07.93 07.93 07.93		24.0109-0103.1	409103			278 9,0 7,3 +B
	300 SL 300 SL 24 500 SL 600 SL V12			06.89 06.89 06.89 06.92	07.93 07.93 07.93 07.93		24.0122-0218.1	422218			300 22,0 19,4 V L +B
	300 SL 300 SL 24 500 SL 600 SL V12			06.89 06.89 06.89 06.92	07.93 07.93 07.93 07.93		83.7704-0281.3	330804	2		L=280
	300 SL 300 SL 24 500 SL 600 SL V12			06.89 06.89 06.89 06.92	07.93 07.93 07.93 07.93		03.0137-0170.2	650170			164 x 20 /Zub
	300 SL 300 SL 24 500 SL 600 SL V12	◀		06.89 06.89 06.89 06.92	07.93 07.93 07.93 07.93		24.3727-0464.2 24.3727-0468.2 24.3727-0469.2	580464 580468 580469	1	<input type="checkbox"/> <input type="checkbox"/> <input type="checkbox"/>	L=2297 L=1044 L=1014
	300 SL 300 SL 24 500 SL 600 SL V12	▶		06.89 06.89 06.89 06.92	07.93 07.93 07.93 07.93		24.3727-0468.2 24.3727-0469.2	580468 580469		<input type="checkbox"/> <input type="checkbox"/>	L=1044 L=1014
	300 SL 300 SL 24	◀		06.89 06.89	07.93 07.93		24.2419-0915.3 24.2419-1703.3	030045 030097		+ GG ¹⁾ + ALU ²⁾	Gz 19,05 Gz 19,05
	300 SL 300 SL 24	◀		06.89 06.89	07.93 07.93		24.2523-1310.3	040106			Nz 23,81
MERCEDES BENZ (R198) 300 SL (55-60)											
	300 SL		002953	01.55			03.3508-3600.3	310030			Behälter
	300 SL	002954			12.60		03.3509-0600.3	310065			Behälter

¹⁾ + cast iron / + ghisa / + fonte grise / + fundición de gris





²⁾ + aluminium / + alluminio / + aluminium / + aluminio











MERCEDES BENZ (W100) 600 (64-81)

	600				01.64	05.81			24.5170-0426.3	331452	2		L=426	
--	-----	--	--	--	-------	-------	--	--	----------------	--------	---	--	-------	--

MERCEDES BENZ (W105) 219 (56-59)

	219				01.56	12.59			03.3126-0505.3	010294			Hz 26,99	ATE
	219				01.56	12.59			83.7704-0320.3	330851	2		L=320	
	219				01.56	12.59			03.2728-2101.3	020008			Rz 28,57	
									03.2728-2201.3	020009			Rz 28,57	
									03.0402-1128.2	060027			Rz Reparatursatz	
	219				01.56	12.59			83.6104-0210.3	330473			L=210	
									83.6204-0220.3	330308			L=220	
	219				01.56	12.59			03.3223-0102.3	020090			Rz 23,81	

MERCEDES BENZ (W108) 250 S-300 SEb (65-72)

	280 S 280 SE 280 SE/SEL 3.5 280 SEL	015700 014781			09.72 09.72 03.71 01.68	09.72 08.72 03.71			03.6855-1202.4	300056			9" Tandem	ATE
	250 S 250 SE 300 SEb		058443 045293 002589		07.65 08.65 08.65				03.2123-0614.3	010172			THz 23,81 19/13	ATE
	250 S 250 SE 280 S/SE 280 SE/SEL 3.5 280 SEL 300 SEb	058444 045294			03.69 01.68 11.67 09.72 03.71 01.68				03.2123-1003.3	010175	1		THz 23,81 Bremslichtschalter	ATE
			002590		03.71 12.67				24.3526-0810.3	340037				
	250 S 250 SE 300 SEb		058443 045293 002589		07.65 08.65 08.65				03.0101-3501.2	390001			Behälter Rep. Satz	
	250 S 250 SE 280 S/SE 280 SE/SEL 3.5 280 SEL 300 SEb	058444 045294			03.69 01.68 11.67 09.72 03.71 01.68				03.3508-8753.3	310049			Behälter + WE	
			002590		12.67									
	250 S 250 SE 280 S 280 SE 280 SEL 300 SEb		075175 081818 081818		07.65 08.65 11.67 11.67 01.68 08.65	03.69 01.68 11.67 09.72 03.71 12.67			13.2571-9998.2	210133			D=57 D=57 Dichtungssatz	ATE ATE ATE
	280 S 280 SE 280 SE/SEL 3.5 280 SEL	075176 081819 081819			09.72 09.72 03.71 03.71				13.2571-8011.2	210121			D=57 D=57 Dichtungssatz	ATE ATE ATE
									13.2571-8012.2	210122				
									13.0441-5718.2	250120				
	250 S 250 SE 280 S 280 SE 280 SE/SEL 3.5 280 SEL 300 SEb				07.65 08.65 11.67 11.67 03.71 01.68 08.65	03.69 01.68 09.72 09.72 08.72 03.71 12.67			13.0460-6027.2	606027			20011 15,0 Belagsatz-Zubehör Belagsatz-Zubehör	ATE ATE BDX
									13.0460-0026.2	610026				
									13.0460-0910.2	610910				
	250 S 250 SE 280 S 280 SE 280 SEL		075175 081818 081818		07.65 08.65 11.67 11.67 01.68	03.69 01.68 11.67 09.72 12.67			24.0113-0112.1	413112			273 12,6 11,0	
	300 SEb		081818		08.65	12.67			24.0113-0111.1	413111			253 12,7 11,1	
	250 S 250 SE 280 S 280 SE 280 SE/SEL 3.5 280 SEL 300 SEb				07.65 08.65 11.67 11.67 03.71 01.68 08.65	03.69 01.68 09.72 09.72 08.72 03.71 12.67			24.5170-0426.3	331452	2		L=426	
	250 S 250 SE 280 S 280 SE 280 SEL 300 SEb		0034763 0035762 0035738		07.65 08.65 11.67 11.67 01.68 08.65	03.69 01.68 11.67 09.72 03.71 12.67			13.2423-8009.2	210063			D=42 D=42 Dichtungssatz	ATE ATE ATE
									13.2423-8010.2	210064				
									13.0441-4206.2	250087				
	280 S 280 SE 280 SE/SEL 3.5 280 SEL	0034764 0035763 0035739			09.72 09.72 03.71 03.71				13.2353-8003.2	210016			D=35 D=35 Dichtungssatz	ATE ATE ATE
									13.2353-8004.2	210017				
									13.0441-3504.2	250050				





MERCEDES BENZ (W108) 250 S-300 Seb (65-72)





























	250 S 250 SE 280 S 280 SE 280 SE/SEL 3.5 280 SEL 300 Seb			07.65 08.65 11.67 11.67 03.71 01.68 08.65	03.69 01.68 09.72 09.72 08.72 03.71 12.67		13.0460-4036.2 13.0460-3804.2 13.0460-0029.2	604036 603804 610029		+ Anti-Noise-Blech 1)	21035 15,0 21035 15,0 Belagsatz-Zubehör	ATE ATE ATE
	250 S 250 SE 280 S 280 SE 280 SE/SEL 3.5 280 SEL 300 Seb			07.65 08.65 11.67 11.67 03.71 01.68 08.65	03.69 01.68 09.72 09.72 08.72 03.71 12.67		24.0110-0185.1	410185			279 10,0 8,3 +S +B	
	250 S 250 SE 280 S 280 SE 280 SEL 300 Seb			07.65 08.65 11.67 11.67 01.68 08.65	03.69 01.68 09.72 09.72 03.71 12.67		83.6104-0241.3 83.6204-0220.3	330731 330308			L=240 L=220	
	280 S 280 SE 280 SE/SEL 3.5 280 SEL	0034764 0035763 0035739	0034763 0035762 0035738	09.72 09.72 03.71 03.71	09.72 09.72 08.72 03.71		83.7704-0320.3 83.6204-0220.3	330851 330308			L=320 L=220	
	250 S 250 SE 280 S 280 SE 280 SE/SEL 3.5 280 SEL 300 Seb			07.65 08.65 11.67 11.67 03.71 01.68 08.65	03.69 01.68 09.72 09.72 08.72 03.71 12.67		03.0137-0171.2 03.0137-9002.2	650171 669002			160 x 25 /Zub Bremsbacken-Zubehör	
	280 S 280 SE 280 SEL	027623 028986 029326		09.72 09.72 03.71	09.72 09.72 03.71		24.2419-0937.3	030063			Gz 19,05	FTE
	280 S 280 SE 280 SEL	027623 028986 029326		09.72 09.72 03.71	09.72 09.72 03.71		03.2523-0811.3 03.0450-2311.2	040019 082311			Nz 23,81 Nz Reparatursatz	
	280 S 280 SE 280 SEL	027623 028986 029326		09.72 09.72 03.71	09.72 09.72 03.71		24.5901-0225.3	331288			L=225	

MERCEDES BENZ (W109) 300 SEL (65-72)

	300 SEL 2.8 300 SEL 3.5 300 SEL 6.3	000979		01.70 09.69 12.67	09.72 09.72 09.72		03.6855-1202.4	300056			9" Tandem	ATE
	300 SEL		002130	08.65			03.2123-0614.3	010172			THz 23,81 19/13	ATE
	300 SEL 300 SEL 2.8 300 SEL 3.5 300 SEL 6.3	002131		11.67 12.67 09.69 12.67	01.70 01.70 09.72 09.72		03.2123-1003.3 24.3526-0810.3	010175 340037	1		THz 23,81 Bremslichtschalter	ATE
	300 SEL 300 SEL 2.8 300 SEL 3.5 300 SEL 6.3	002131	002130	08.65			03.0101-3501.2 03.3508-8753.3	390001 310049			Behälter Rep. Satz Behälter + WE	
	300 SEL 300 SEL 2.8			08.65 12.67	11.67 01.70		13.2571-9998.2 13.2571-9999.2 13.0441-5718.2	210133 210134 250120			D=57 D=57 Dichtungssatz	ATE ATE ATE
	300 SEL 3.5 300 SEL 6.3			09.69 12.67	09.72 09.72		13.2571-8011.2 13.2571-8012.2 13.0441-5718.2	210121 210122 250120			D=57 D=57 Dichtungssatz	ATE ATE ATE
	300 SEL 300 SEL 2.8 300 SEL 3.5 300 SEL 6.3			08.65 12.67 09.69 12.67	11.67 01.70 09.72 09.72		13.0460-6027.2 13.0460-0026.2 13.0460-0910.2	606027 610026 610910			20011 15,0 Belagsatz-Zubehör Belagsatz-Zubehör	ATE ATE BDX
	300 SEL 300 SEL 2.8			08.65 12.67	11.67 01.70		24.0113-0112.1	413112			273 12,6 11,0	
	300 SEL 300 SEL 2.8 300 SEL 3.5 300 SEL 6.3			08.65 12.67 09.69 12.67	11.67 01.70 09.72 09.72		24.5170-0426.3	331452	2		L=426	
	300 SEL 300 SEL 2.8		002210	08.65 12.67	11.67 01.70		83.6104-0470.3 13.2423-8009.2 13.2423-8010.2 13.0441-4206.2	330253 210063 210064 250087	2		L=470 D=42 D=42 Dichtungssatz	ATE ATE ATE
	300 SEL 2.8 300 SEL 3.5 300 SEL 6.3	002211 003549		01.70 09.69 09.72	01.70 09.72 09.72		13.2353-8003.2 13.2353-8004.2 13.0441-3504.2	210016 210017 250050			D=35 D=35 Dichtungssatz	ATE ATE ATE
	300 SEL 6.3		003548	12.67			13.0441-4206.2	250087			Dichtungssatz	ATE
	300 SEL 300 SEL 2.8 300 SEL 3.5 300 SEL 6.3			08.65 12.67 09.69 12.67	11.67 01.70 09.72 09.72		13.0460-4036.2 13.0460-3804.2 13.0460-0029.2	604036 603804 610029		+ Anti-Noise-Blech 1)	21035 15,0 21035 15,0 Belagsatz-Zubehör	ATE ATE ATE

1) + shim / + lamierino antirumore / + tôle anti-bruit / + placa anti-ruidos





















								
MERCEDES BENZ (W109) 300 SEL (65-72)								
	300 SEL 300 SEL 2.8 300 SEL 3.5 300 SEL 6.3			08.65 12.67 09.69 12.67	11.67 01.70 09.72 09.72	24.0110-0185.1	410185	279 10,0 8,3 +S +B
	300 SEL 300 SEL 2.8 300 SEL 3.5 300 SEL 6.3			08.65 12.67 09.69 12.67	11.67 01.70 09.72 09.72	83.6204-0350.3	330382	L=350
	300 SEL 300 SEL 2.8 300 SEL 3.5 300 SEL 6.3			08.65 12.67 09.69 12.67	11.67 01.70 09.72 09.72	03.0137-0171.2 03.0137-9002.2	650171 669002	160 x 25 /Zub Bremsbacken-Zubehör
	300 SEL 2.8	001859		01.70		24.2419-0937.3	030063	Gz 19,05 FTE
	300 SEL 2.8	001859		01.70		03.2523-0811.3 03.0450-2311.2	040019 082311	Nz 23,81 Nz Reparatursatz
	300 SEL 2.8	001859		01.70		24.5901-0225.3	331288	L=225
MERCEDES BENZ (W110) 190 c-230 (61-68)								
	190 c Dc 200/ D 230			07.65 07.65	08.65 02.68 02.67	03.2123-0609.3	010171	+ Bremsgerät (2-Kreis) ¹⁾ Thz 23,81 20/12 ATE
	190 c 190 Dc 200/ D 230	064106 099642		07.65 07.65	08.65 02.68 02.67	13.2571-9998.2 13.2571-9999.2 13.0441-5718.2	210133 210134 250120	D=57 D=57 Dichtungssatz ATE ATE ATE
	190 c 190 Dc 200/ D 230	064106 099642		07.65 07.65	08.65 02.68 02.67	13.0460-6027.2 13.0460-0026.2	606027 610026	20011 15,0 Belagsatz-Zubehör ATE ATE
	190 c 190 Dc 200/ D 230	064106 099642		07.65 07.65	08.65 02.68 02.67	24.0113-0111.1	413111	253 12,7 11,1
	190 c 190 Dc		064105 099641	04.61 04.61		83.6104-0440.3	330714	L=440
	190 c 190 Dc 200/ D 230	064106 099642		07.65 07.65	08.65 02.68 02.67	24.5170-0426.3	331452	L=426
	190 c 190 Dc		064105 099641	04.61 04.61		03.2728-2101.3 03.2728-2201.3 03.0402-1128.2	020008 020009 060027	Rz 28,57 Rz 28,57 Rz Reparatursatz
	190 c Dc 200/ D 230			04.61 07.65 07.65	08.65 02.68 02.67	83.6104-0210.3 83.6204-0220.3	330473 330308	L=210 L=220
	190 c 190 Dc		064105 099641	04.61 04.61		03.3223-0102.3	020090	Rz 23,81
	190 c 190 Dc 200/ D 230	064106 099642		07.65 07.65	08.65 02.68 02.67	03.3219-3401.3	020049	Rz 19,05
MERCEDES BENZ (W111) 220-280 (59-71)								
	280 SE/C 280 SE/C 3.5	001504		08.69	05.71 06.71	03.6855-1202.4	300056	9" Tandem ATE
	220 b 220 Sb 220 SEb Cabrio 220 SEb Coupe 220 SEb Lim. 230 S	048977 108750 049723 049449 049462		07.65	08.65 07.65 10.65 10.65 08.65 01.68	03.2123-0609.3	010171	Thz 23,81 20/12 ATE
	250 SE/C		088724	08.65		03.2123-0614.3	010172	Thz 23,81 19/13 ATE
	250 SE/C 280 SE/C 280 SE/C 3.5	088725		11.67 08.69	12.67 05.71 06.71	03.2123-1003.3 24.3526-0810.3	010175 340037	1 Thz 23,81 Bremslichtschalter ATE
	220 b 220 Sb 220 SEb Cabrio 220 SEb Coupe 220 SEb Lim.		048976	05.59		03.3508-0401.3	310014	- Bremsgerät ²⁾ Behälter
	220 b 220 Sb 220 SEb Cabrio 220 SEb Coupe 220 SEb Lim.		048976 108749 049722 049448 049461	05.59 05.59 09.60 09.60 08.59		03.3508-0801.3	310023	+ Bremsgerät ³⁾ Behälter
	220 b 220 Sb 220 SEb Cabrio 220 SEb Coupe 220 SEb Lim. 230 S	048977 108750 049723 049449 049462		07.65	08.65 07.65 10.65 10.65 08.65 01.68	03.0101-3501.2	390001	Behälter Rep. Satz

1) + booster unit (2 circuit) / + servofreno (doppio circuito) / + servo-frein (deux circuits) / + servofreno (2 circuitos)

2) - booster unit / - servofreno / - servo-frein / - servofreno

3) + booster unit / + servofreno / + servo-frein / + servofreno

								
MERCEDES BENZ (W111) 220-280 (59-71)								
	250 SE/C		088724	08.65		03.0101-3501.2	390001	Behälter Rep. Satz
	250 SE/C	088725		12.67		03.3508-8753.3	310049	Behälter + WE
	280 SE/C			11.67	05.71			
	280 SE/C 3.5			08.69	06.71			
	220 b	048977		08.65	07.65	13.2571-9998.2	210133	D=57
	220 Sb	070638		09.60	10.65	13.2571-9999.2	210134	D=57
	220 SEb Cabrio			09.60	10.65	13.0441-5718.2	250120	Dichtungssatz
	220 SEb Coupe	026841		07.65	01.68			
	220 SEb Lim.			08.65	12.67			
	230 S		005157	11.67				
	250 SE/C			05.71		13.2571-8011.2	210121	D=57
	280 SE/C	005158		08.69	06.71	13.2571-8012.2	210122	D=57
	280 SE/C 3.5					13.0441-5718.2	250120	Dichtungssatz
	220 b	048977		08.65	07.65	13.0460-6027.2	606027	20011 15,0
	220 Sb	070638		09.60	10.65	13.0460-0026.2	610026	Belagsatz-Zubehör
	220 SEb Cabrio			09.60	10.65	13.0460-0910.2	610910	Belagsatz-Zubehör
	220 SEb Coupe	026841		07.65	01.68			
	220 SEb Lim.			08.65	12.67			
	230 S			11.67	05.71			
	250 SE/C		005157	08.69	06.71			
	280 SE/C					24.0113-0111.1	413111	253 12,7 11,1
	280 SE/C 3.5					24.0113-0112.1	413112	273 12,6 11,0
	220 b	023661	048976			83.6104-0440.3	330714	L=440
	220 Sb	049856	070637					
	220 SEb Lim.	016976	026840					
	220 SEb Coupe		026650	09.60		83.7704-0320.3	330851	L=320
	220 b	048977		08.65	07.65	24.5170-0426.3	331452	L=426
	220 Sb	070638		09.60	10.65			
	220 SEb Cabrio			10.65				
	220 SEb Coupe	026651		08.65	10.65			
	220 SEb Lim.	026841		07.65	01.68			
	230 S			08.65	12.67			
	250 SE/C			11.67	05.71			
	280 SE/C			08.69	06.71			
	220 b	048976	05.59			03.2728-2101.3	020008	Rz 28,57
	220 Sb	070637	05.59			03.2728-2201.3	020009	Rz 28,57
	220 SEb Lim.	026840	08.59			03.0402-1128.2	060027	Rz Reparatursatz
	250 SE/C		003467	08.65	12.67	13.2423-8009.2	210063	D=42
	280 SE/C			11.67		13.2423-8010.2	210064	D=42
	280 SE/C 3.5	003468		05.71		13.0441-4206.2	250087	Dichtungssatz
	280 SE/C			08.69	06.71	13.2353-8003.2	210016	D=35
	280 SE/C 3.5					13.2353-8004.2	210017	D=35
						13.0441-3504.2	250050	Dichtungssatz
	250 SE/C			08.65	12.67	13.0460-4036.2	604036	21035 15,0
	280 SE/C			11.67	05.71	13.0460-3804.2	603804	21035 15,0
	280 SE/C 3.5			08.69	06.71	13.0460-0029.2	610029	Belagsatz-Zubehör
	250 SE/C			08.65	12.67	24.0110-0185.1	410185	279 10,0 8,3 +S +B
	280 SE/C			11.67	05.71			
	280 SE/C 3.5			08.69	06.71			
	220 b			05.59	08.65	83.6104-0210.3	330473	L=210
	220 Sb			05.59	07.65	83.6204-0220.3	330308	L=220
	220 SEb Cabrio			09.60	10.65			
	220 SEb Coupe			09.60	10.65			
	220 SEb Lim.			08.59	08.65			
	230 S			07.65	01.68			
	250 SE/C		003467	08.65	12.67	83.6104-0241.3	330731	L=240
	280 SE/C			11.67		83.6204-0220.3	330308	L=220
	280 SE/C	003468		05.71		83.7704-0320.3	330851	L=320
	280 SE/C 3.5			08.69	06.71	83.6204-0220.3	330308	L=220
	220 b	048976	05.59			03.3223-0102.3	020090	Rz 23,81
	220 Sb	070637	05.59					
	220 SEb Lim.	026840	08.59					
	220 b	048977		08.65	07.65	03.3219-3401.3	020049	Rz 19,05
	220 Sb	070638		09.60	10.65			
	220 SEb Cabrio			09.60	10.65			
	220 SEb Coupe	026841		09.60	10.65			
	220 SEb Lim.			07.65	01.68			
	230 S			05.59	08.65	03.0137-0171.2	650171	160 x 25 /Zub
	250 SE/C			05.59	07.65	03.0137-9002.2	669002	Bremsbacken-Zubehör
	280 SE/C			09.60	10.65			
	280 SE/C 3.5			09.60	10.65			
	280 SEb Lim.			08.59	08.65			

1) + shim / + lamierino antirumore / + tôle anti-bruit / + placa anti-ruidos



MERCEDES BENZ (W111) 220-280 (59-71)

	230 S 250 SE/C 280 SE/C 280 SE/C 3.5			07.65 08.65 11.67 08.69	01.68 12.67 05.71 06.71		03.0137-0171.2 03.0137-9002.2	650171 669002		160 x 25 /Zub Bremsbacken-Zubehör
	280 SE/C	002864			05.71		24.2419-0937.3	030063		Gz 19,05 FTE
	280 SE/C	002864			05.71		03.2523-0811.3 03.0450-2311.2	040019 082311		Nz 23,81 Nz Reparatursatz
	280 SE/C	002864			05.71		24.5901-0225.3	331288		L=225

MERCEDES BENZ (W112) 300 SE (61-67)

	300 SE	005867			12.67		13.2571-9998.2 13.2571-9999.2 13.0441-5718.2	210133 210134 250120	<input type="checkbox"/> <input type="checkbox"/>	D=57 D=57 Dichtungssatz	ATE ATE ATE
	300 SE	005867			12.67		13.0460-6027.2	606027		20011 15,0	ATE
	300 SE	005867			12.67		24.0113-0111.1	413111		253 12,7 11,1	
	300 SE			02.61	12.67		83.6204-0350.3	330382	2	L=350	

MERCEDES BENZ (W114) 230.6-280 CE (67-76)

	230.6 250 250 C 250 CE 280 280 C 280 CE 280 E			09.67 07.67 10.68 10.68 04.72 06.72 04.72 04.72	10.76 06.76 06.76 04.72 09.76 07.76 07.76 09.76		03.6850-0202.4	300043		9"	ATE
	230.6 250 250 C 250 CE			09.67 07.67 10.68 10.68	10.76 06.76 06.76 04.72		03.2123-1003.3 24.3526-0810.3	010175 340037	1	THz 23,81 Bremslichtschalter	ATE
	280 280 C 280 CE 280 E			04.72 06.72 04.72 04.72	09.76 07.76 07.76 09.76		03.2123-3402.3	010181		THz 23,81	ATE
	230.6 250 250 C 250 CE 280 280 C 280 CE 280 E			09.67 07.67 10.68 10.68 04.72 06.72 04.72 04.72	10.76 06.76 06.76 04.72 09.76 07.76 07.76 09.76		03.3508-8753.3	310049		Behälter + WE	
	230.6 250 250 C 250 CE		203606 008133 020272	09.67 07.67 10.68 10.68	10.76 06.76 10.68 10.68		13.2571-9998.2 13.2571-9999.2 13.0441-5718.2	210133 210134 250120	<input type="checkbox"/> <input type="checkbox"/>	D=57 D=57 Dichtungssatz	ATE ATE ATE
	230.6 250 C 250 CE 280 280 C 280 CE 280 E	203607 008134 020273		10.76 06.76 04.72 04.72 06.72 04.72 04.72	10.76 06.76 07.76 07.76 07.76 07.76 09.76		13.2601-9996.2 13.2601-9997.2 13.0441-6001.2	210176 210177 250126	<input type="checkbox"/> <input type="checkbox"/>	D=60 D=60 Dichtungssatz	ATE ATE ATE
	230.6 250 250 C 250 CE		203606 008133 020272	09.67 07.67 10.68 10.68	10.76 06.76 10.68 10.68		13.0460-6027.2 13.0460-0026.2 13.0460-0910.2	606027 610026 610910		20011 15,0 Belagsatz-Zubehör Belagsatz-Zubehör	ATE ATE BDX
	230.6 250 C 250 CE 280 280 C 280 CE 280 E	203607 008134 020273		10.76 06.76 04.72 04.72 06.72 04.72 04.72	10.76 06.76 09.76 09.76 07.76 07.76 09.76		13.0460-9028.2 13.0460-0027.2 13.0460-0911.2	609028 610027 610911		20392 15,0 /WE Belagsatz-Zubehör Belagsatz-Zubehör	ATE ATE BDX
	230.6 250 250 C 250 CE		089801 068407 007085 017599	09.67 07.67 10.68 10.68			24.0113-0112.1	413112		273 12,6 11,0	
	230.6 250 250 C 250 CE	089802 068408 007086 017600	203606		05.72 05.72 04.72		24.0113-0113.1	413113		274 12,6 11,0	
	230.6	203607			10.76		24.0113-0137.1	413137		278 12,6 10,6 +B	





MERCEDES BENZ (W114) 230.6-280 CE (67-76)

	250 250 C 280 280 C 280 CE 280 E			06.72 06.72 04.72 06.72 04.72 04.72	06.76 06.76 09.76 07.76 07.76 09.76			24.0113-0137.1	413137				278 12,6 10,6 +B	
	230.6 250 250 C 250 CE 280 280 C 280 CE 280 E			09.67 07.67 10.68 10.68 04.72 06.72 04.72 04.72	10.76 06.76 06.76 04.72 09.76 07.76 07.76 09.76			24.5170-0426.3	331452	2			L=426	
	230.6 250 250 C 250 CE			09.67 07.67 10.68 10.68	12.70 12.70 12.70 12.70			13.2381-8030.2 13.2381-8029.2 13.0441-3811.2	210036 210035 250067		<input type="checkbox"/> Achtung: Kolbenstellung ändern ¹⁾ <input type="checkbox"/> Achtung: Kolbenstellung ändern ¹⁾	D=38 D=38 Dichtungssatz	ATE ATE ATE	
	230.6 250 250 C 250 CE 280 280 C 280 CE 280 E			01.71 01.71 01.71 01.71 04.72 06.72 04.72 04.72	10.76 06.76 06.76 04.72 09.76 07.76 07.76 09.76			13.2381-8027.2 13.2381-8028.2 13.0441-3811.2	210033 210034 250067		<input type="checkbox"/> <input type="checkbox"/>	D=38 D=38 Dichtungssatz	ATE ATE ATE	
	230.6 250 250 C 250 CE 280 280 C 280 CE 280 E			09.67 07.67 10.68 10.68 04.72 06.72 04.72 04.72	10.76 06.76 06.76 04.72 09.76 07.76 07.76 09.76			13.0460-4036.2 13.0460-3804.2 13.0460-0029.2 13.0460-0912.2	604036 603804 610029 610912		+ Anti-Noise-Blech ²⁾	21035 15,0 21035 15,0 Belagsatz-Zubehör Belagsatz-Zubehör	ATE ATE ATE BDX	
	230.6 250 250 C 250 CE 280 280 C 280 CE 280 E			09.67 07.67 10.68 10.68 04.72 06.72 04.72 04.72	10.76 06.76 06.76 04.72 09.76 07.76 07.76 09.76			24.0110-0185.1	410185				279 10,0 8,3 +S +B	
	230.6 250 250 C 250 CE		065606 055234 005143 012571	09.67 07.67 10.68 10.68				83.6204-0240.3	330718	2			L=240	
	230.6 250 250 C 250 CE 280 280 C 280 CE 280 E	065607 055235 005144 012572			03.73 03.73 03.73 04.72 03.73 06.72 03.73 04.72 03.73 04.72 03.73			83.6204-0280.3	330732	2			L=280	
	230.6 250 250 C 280 280 C 280 CE 280 E			04.73 04.73 04.73 04.73 04.73 04.73 04.73	10.76 06.76 06.76 09.76 07.76 07.76 09.76			83.7704-0281.3	330804	2			L=280	
	230.6 250 250 C 250 CE 280 280 C 280 CE 280 E			09.67 07.67 10.68 10.68 04.72 06.72 04.72 04.72	10.76 06.76 06.76 04.72 09.76 07.76 07.76 09.76			03.0137-0171.2 03.0137-9002.2	650171 669002				160 x 25 /Zub Bremsbacken-Zubehör	
	230.6 250 250 C 250 CE 280 280 C 280 CE 280 E		101229 021787 108227	09.67 07.67 10.68 10.68 04.72 06.72 04.72 04.72	10.76 06.76 06.76 06.76 09.76 07.76 07.76 09.76			24.3727-0406.2 24.3727-0407.2	580406 580407	1 2	+ Linkslenker ³⁾	L=1696 L=1488		
	230.6 250 250 C 250 CE 280 280 C 280 CE 280 E	◀ ◀ ◀ ◀ ◀ ◀ ◀ ◀		09.67 07.67 10.68 10.68 04.72 06.72 04.72 04.72	10.76 06.76 06.76 04.72 09.76 07.76 07.76 09.76			24.2419-0937.3 03.3508-1706.3	030063 310024				Gz 19,05 Behälter	FTE

¹⁾ attn.:change piston position / att.cambiare posizione pistone / montage devant l'essieu / instalación delante del eje

²⁾ + shim / + lamierino antirumore / + tôle anti-bruit / + placa anti-ruídos

³⁾ + left hand drive / + guida a sinistra / + conduite à gauche / + volante a la izquierda





MERCEDES BENZ (W114) 230.6-280 CE (67-76)

	230.6 250 250 C 250 CE 280 280 C 280 CE 280 E			09.67 07.67 10.68 10.68 04.72 06.72 04.72 04.72	10.76 06.76 06.76 04.72 09.76 07.76 07.76 09.76		03.2523-0811.3 03.0450-2311.2	040019 082311		Nz 23,81 Nz Reparatursatz
	230.6 250 250 C 250 CE 280 280 C 280 CE 280 E			09.67 07.67 10.68 10.68 04.72 06.72 04.72 04.72	10.76 06.76 06.76 04.72 09.76 07.76 07.76 09.76		24.5901-0225.3	331288		L=225

MERCEDES BENZ (W115) 200-240 D 3,0 (67-76)

	200 200 D 220 220 D 230.4 240 D 240 D 3.0			10.67 10.67 10.67 07.67 08.73 08.73 09.74	12.76 12.76 07.73 11.76 11.76 11.76 10.76		03.6850-0202.4	300043		9"	ATE	
	200 200 D 220 220 D 230.4 240 D 240 D 3.0			10.67 10.67 10.67 07.67 08.73 08.73 09.74	12.76 12.76 07.73 11.76 11.76 11.76 10.76		03.2123-1003.3 24.3526-0810.3	010175 340037	1	THz 23,81 Bremslichtschalter	ATE	
	200 200 D 220 220 D 230.4 240 D 240 D 3.0			10.67 10.67 10.67 07.67 08.73 08.73 09.74	12.76 12.76 07.73 11.76 11.76 11.76 10.76		03.3508-8753.3	310049		Behälter + WE		
	200 200 D 220 220 D 230.4 240 D 240 D 3.0			10.67 10.67 10.67 07.67 08.73 08.73 09.74	12.76 12.76 07.73 11.76 11.76 11.76 10.76		13.2571-9998.2 13.2571-9999.2 13.0441-5718.2	210133 210134 250120	<input type="checkbox"/> <input type="checkbox"/>	D=57 D=57 Dichtungssatz	ATE ATE ATE	
	200 200 D 220 220 D 230.4 240 D 240 D 3.0			10.67 10.67 10.67 07.67 08.73 08.73 09.74	12.76 12.76 07.73 11.76 11.76 11.76 10.76		13.2601-9996.2 13.2601-9997.2 13.0441-6001.2	210176 210177 250126	<input type="checkbox"/> <input type="checkbox"/> <input type="checkbox"/>	D=60 D=60 Dichtungssatz	ATE ATE ATE	
	200 200 D 220 220 D 230.4 240 D 240 D 3.0			10.67 10.67 10.67 07.67 08.73 08.73 09.74	12.76 12.76 07.73 11.76 11.76 11.76 10.76		13.0460-6027.2 13.0460-0026.2 13.0460-0910.2	606027 610026 610910		20011 15,0 Belagsatz-Zubehör Belagsatz-Zubehör	ATE ATE BDX	
	200 200 D 220 220 D 230.4 240 D 240 D 3.0			10.67 10.67 10.67 07.67 08.73 08.73 09.74	12.76 12.76 07.73 11.76 11.76 11.76 10.76		13.0460-9028.2 13.0460-0027.2 13.0460-0911.2	609028 610027 610911		20392 15,0 /WE Belagsatz-Zubehör Belagsatz-Zubehör	ATE ATE BDX	
	200 200 D 220 220 D		097998 105289 083871 213511	10.67 10.67 10.67 07.67			24.0113-0112.1	413112			273 12,6 11,0	
	200 200 D 220 220 D 230.4 240 D 240 D 3.0	097999 105290 083872 213512		12.76 12.76 07.73 11.76 11.76 08.73 08.73			24.0113-0113.1	413113			274 12,6 11,0	
	200 200 D 220 220 D 230.4 240 D 240 D 3.0			10.67 10.67 10.67 07.67 08.73 08.73 09.74	12.76 12.76 07.73 11.76 11.76 11.76 10.76		24.0113-0137.1	413137			278 12,6 10,6 +B	
	200 200 D 220 220 D 230.4 240 D 240 D 3.0			10.67 10.67 10.67 07.67 08.73 08.73 09.74	12.76 12.76 07.73 11.76 11.76 11.76 10.76		24.5170-0426.3	331452	2		L=426	
	200 200 D 220 220 D			10.67 10.67 10.67 07.67	12.70 12.70 12.70 12.70		13.2381-8030.2 13.2381-8029.2 13.0441-3811.2	210036 210035 250067	<input type="checkbox"/> <input type="checkbox"/>	Achtung: Kolbenstellung ändern ¹⁾ Achtung: Kolbenstellung ändern ¹⁾	D=38 D=38 Dichtungssatz	ATE ATE ATE
	200 200 D 220 220 D 230.4 240 D 240 D 3.0			01.71 01.71 01.71 01.71 08.73 08.73 09.74	12.76 12.76 07.73 11.76 11.76 11.76 10.76		13.2381-8027.2 13.2381-8028.2 13.0441-3811.2	210033 210034 250067	<input type="checkbox"/> <input type="checkbox"/>	D=38 D=38 Dichtungssatz	ATE ATE ATE	

¹⁾ attn.:change piston position / att.cambiare posizione pistone / montage devant l'essieu / instalación delante del eje

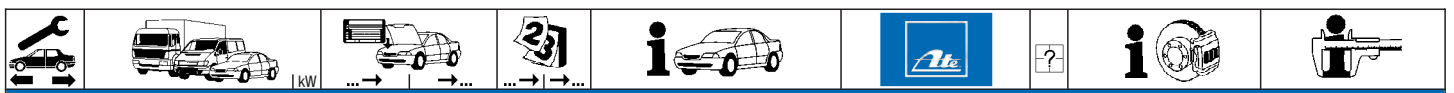

MERCEDES BENZ (W115) 200-240 D 3,0 (67-76)

	200 200 D 220 220 D 230.4 240 D 240 D 3.0			10.67 10.67 10.67 07.67 08.73 08.73 09.74	12.76 12.76 07.73 11.76 11.76 11.76 10.76		13.0460-4036.2 13.0460-3804.2 13.0460-0029.2 13.0460-0912.2	604036 603804 610029 610912		+ Anti-Noise-Blech 1)	21035 15,0 21035 15,0 Belagsatz-Zubehör Belagsatz-Zubehör	ATE ATE ATE BDX
	200 200 D 220 220 D 230.4 240 D 240 D 3.0			10.67 10.67 10.67 07.67 08.73 08.73 09.74	12.76 12.76 07.73 11.76 11.76 11.76 10.76		24.0110-0185.1	410185			279 10,0 8,3 +S +B	
	200 200 D 220 220 D		070415 076568 064094 161007	10.67 10.67 10.67 07.67			83.6204-0240.3	330718	2		L=240	
	200 200 D 220 220 D	070416 076569 064095 161008		03.73 03.73 03.73 03.73			83.6204-0280.3	330732	2		L=280	
	200 200 D 220 220 D 230.4 240 D 240 D 3.0			04.73 04.73 04.73 04.73 08.73 08.73 09.74	12.76 12.76 07.73 11.76 11.76 11.76 10.76		83.7704-0281.3	330804	2		L=280	
	200 200 D 220 220 D 230.4 240 D 240 D 3.0			10.67 10.67 10.67 07.67 08.73 08.73 09.74	12.76 12.76 07.73 11.76 11.76 11.76 10.76		03.0137-0171.2 03.0137-9002.2	650171 669002			160 x 25 /Zub Bremsbacken-Zubehör	
	200 200 D 220 220 D 230.4 240 D 240 D 3.0		313548 352054 128734 467453 087765 130095 053690	04.73 04.73 04.73 04.73 08.73 08.73 09.74			24.3727-0406.2 24.3727-0407.2	580406 580407	1 2		L=1696 L=1488	
	200 200 D 220 220 D 230.4 240 D 240 D 3.0			10.67 10.67 10.67 07.67 08.73 08.73 09.74	12.76 12.76 07.73 11.76 11.76 11.76 10.76		24.2419-0937.3 03.3508-1706.3	030063 310024			Gz 19,05 Behälter	FTE
	200 200 D 220 220 D 230.4 240 D 240 D 3.0			10.67 10.67 10.67 07.67 08.73 08.73 09.74	12.76 12.76 07.73 11.76 11.76 11.76 10.76		03.2523-0811.3 03.0450-2311.2	040019 082311			Nz 23,81 Nz Reparatursatz	
	200 200 D 220 220 D 230.4 240 D 240 D 3.0			10.67 10.67 10.67 07.67 08.73 08.73 09.74	12.76 12.76 07.73 11.76 11.76 11.76 10.76		24.5901-0225.3	331288			L=225	

MERCEDES BENZ (W116) 280 S-450 SEL 6,9 (72-80)

	280 S 280 SE 280 SEL 350 SE 350 SEL 450 SE 450 SEL 450 SEL 6.9			09.72 08.72 01.74 09.72 11.73 11.72 03.73 05.75	07.80 07.80 04.80 03.80 01.80 04.80 09.80 09.80		03.6855-1202.4	300056			9" Tandem	ATE
	280 S 280 SE 280 SEL 350 SE 350 SEL 450 SE 450 SEL		053429 052606 052606 029951 029951 043630 043630	09.72 08.72 01.74 09.72 11.73 11.72 03.73			03.2123-1003.3 24.3526-0810.3	010175 340037	1		THz 23,81 Bremslichtschalter	ATE
	280 S 280 SE 280 SEL 350 SE 350 SEL	053430 052607 052607 029952 029952		07.80 07.80 04.80 03.80 01.80			03.2023-0166.3	010015			THz 23,81/19,05	ATE

1) + shim / + lamierino antirumore / + tôle anti-bruit / + placa anti-ruidos



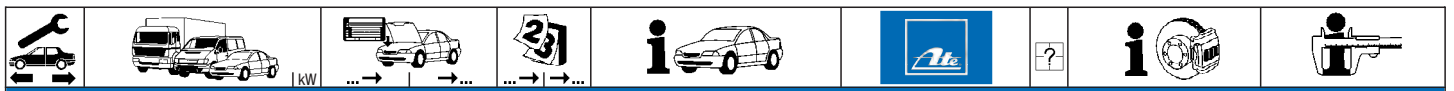



































MERCEDES BENZ (W116) 280 S-450 SEL 6,9 (72-80)

	450 SE 450 SEL 450 SEL 6.9	043631 043631		04.80 09.80 05.75 09.80		03.2023-0166.3	010015			THz 23,81/19,05	ATE
	280 S 280 SE 280 SEL 350 SE 350 SEL 450 SE 450 SEL 450 SEL 6.9			09.72 07.75 08.72 07.75 01.74 07.75 09.72 07.75 11.73 07.75 11.72 07.75 03.73 07.75 05.75 07.75		03.3508-8753.3	310049			Behälter + WE	
	280 S 280 SE 280 SEL 350 SE 350 SEL 450 SE 450 SEL 450 SEL 6.9			09.72 07.80 08.72 07.80 01.74 04.80 09.72 03.80 11.73 01.80 11.72 04.80 03.73 09.80 05.75 09.80		24.9260-8025.5 24.9260-8026.5 13.0441-6001.2	230041 230042 250126	<input type="checkbox"/> <input type="checkbox"/>		D=60 D=60 Dichtungssatz	ATE ATE ATE
	280 S 280 SE 280 SEL 350 SE 350 SEL 450 SE 450 SEL 450 SEL 6.9			09.72 07.80 08.72 07.80 01.74 04.80 09.72 03.80 11.73 01.80 11.72 04.80 03.73 09.80 05.75 09.80		13.0460-9028.2 24.8190-0401.2	609028 620401	4		20392 15,0 /WE Warnkontakt L=95mm	ATE
	280 S 280 SE 280 SEL 350 SE 350 SEL 450 SE 450 SEL 450 SEL 6.9			09.72 07.80 08.72 07.80 01.74 04.80 09.72 03.80 11.73 01.80 11.72 04.80 03.73 09.80 05.75 09.80		24.0122-0106.1	422106			278 22,0 20,0 V L	
	280 S 280 SE 280 SEL 350 SE 350 SEL 450 SE 450 SEL 450 SEL 6.9			09.72 07.80 08.72 07.80 01.74 04.80 09.72 03.80 11.73 01.80 11.72 04.80 03.73 09.80 05.75 09.80		24.5170-0426.3	331452	2		L=426	
	280 S 280 SE 280 SEL 350 SE 350 SEL 450 SE 450 SEL 450 SEL 6.9			09.72 07.80 08.72 07.80 01.74 04.80 09.72 03.80 11.73 01.80 11.72 04.80 03.73 09.80 05.75 09.80		13.2381-8027.2 13.2381-8028.2 13.0441-3811.2	210033 210034 250067	<input type="checkbox"/> <input type="checkbox"/>		D=38 D=38 Dichtungssatz	ATE ATE ATE
	450 SE 450 SEL 450 SEL 6.9			11.72 04.80 03.73 09.80 05.75 09.80		13.2381-8029.2 13.2381-8030.2 13.0441-3811.2	210035 210036 250067	<input type="checkbox"/> <input type="checkbox"/>		D=38 D=38 Dichtungssatz	ATE ATE ATE
	280 S 280 SE 280 SEL 350 SE 350 SEL 450 SE 450 SEL 450 SEL 6.9			09.72 07.80 08.72 07.80 01.74 04.80 09.72 03.80 11.73 01.80 11.72 04.80 03.73 09.80 05.75 09.80		13.0460-4036.2 13.0460-3804.2 13.0460-0029.2 13.0460-0912.2	604036 603804 610029 610912		+ Anti-Noise-Blech ¹⁾	21035 15,0 21035 15,0 Belagsatz-Zubehör Belagsatz-Zubehör	ATE ATE ATE BDX
	280 S 280 SE 280 SEL 350 SE 350 SEL 450 SE 450 SEL 450 SEL 6.9			09.72 07.80 08.72 07.80 01.74 04.80 09.72 03.80 11.73 01.80 11.72 04.80 03.73 09.80 05.75 09.80		24.0110-0185.1	410185			279 10,0 8,3 +S +B	
	280 S 280 SE 350 SE 450 SE			09.72 03.73 08.72 03.73 09.72 03.73 11.72 03.73		83.6204-0282.3	330309	2		L=280	
	280 S 280 SE 280 SEL 350 SE 350 SEL 450 SE 450 SEL 450 SEL 6.9			04.73 07.80 04.73 07.80 01.74 04.80 04.73 03.80 11.73 01.80 04.73 04.80 03.73 09.80 05.75 09.80		83.7704-0281.3	330804	2		L=280	
	280 S 280 SE 280 SEL 350 SE 350 SEL 450 SE			09.72 07.80 08.72 07.80 01.74 04.80 09.72 03.80 11.73 01.80 11.72 04.80		03.0137-0171.2 03.0137-9002.2	650171 669002			160 x 25 /Zub Bremsbacken-Zubehör	

¹⁾ + shim / + lamierino antirumore / + tôle anti-bruit / + placa anti-ruídos

								
MERCEDES BENZ (W116) 280 S-450 SEL 6,9 (72-80)								
	450 SEL 450 SEL 6.9		03.73 05.75	09.80 09.80	03.0137-0171.2 03.0137-9002.2	650171 669002		160 x 25 /Zub Bremsbacken-Zubehör
	280 S 280 SE 280 SEL 350 SE 350 SEL	◀ ◀ ◀ ◀ ◀		09.72 08.72 01.74 09.72 11.73	07.80 07.80 04.80 03.80 01.80	24.2419-0937.3 030063		Gz 19,05 FTE
	280 S 280 SE 280 SEL			09.72 08.72 01.74	07.80 07.80 04.80	03.2523-0811.3 03.0450-2311.2	040019 082311	Nz 23,81 Nz Reparatursatz
	350 SE 350 SEL			09.72 11.73	03.80 01.80	24.5901-0225.3	331288	L=225
MERCEDES BENZ (W120) 180 b,c,Db,Dc (59-62)								
	180 b. c. Db. Dc		01.59	12.62	03.3126-0505.3	010294	+ Bremsgerät ¹⁾	Hz 26,99 ATE
	180 b. c. Db. Dc		01.59	12.62	03.3508-3600.3	310030		Behälter
	180 b. c. Db. Dc		01.59	12.62	83.7704-0320.3	330851	2 (83.5104-0320.3)	L=320
	180 b. c. Db. Dc		01.59	12.62	03.2728-2101.3 03.2728-2201.3 03.0402-1128.2	020008 020009 060027	<input type="checkbox"/> <input type="checkbox"/> <input type="checkbox"/>	Rz 28,57 Rz 28,57 Rz Reparatursatz
	180 b. c. Db. Dc		01.59	12.62	83.6104-0210.3 83.6204-0220.3	330473 330308	<input type="checkbox"/> <input type="checkbox"/>	L=210 L=220
	180 b. c. Db. Dc		01.59	12.62	03.3223-0102.3	020090		Rz 23,81
MERCEDES BENZ (W121) 190 b,Db (59-61)								
	190 b. Db		01.59	12.61	03.3126-0505.3	010294	+ Bremsgerät ¹⁾	Hz 26,99 ATE
	190 b. Db		01.59	12.61	03.3508-3600.3	310030		Behälter
	190 b. Db		01.59	12.61	83.7704-0320.3	330851	2 (83.5104-0320.3)	L=320
	190 b. Db		01.59	12.61	03.2728-2101.3 03.2728-2201.3 03.0402-1128.2	020008 020009 060027	<input type="checkbox"/> <input type="checkbox"/> <input type="checkbox"/>	Rz 28,57 Rz 28,57 Rz Reparatursatz
	190 b. Db		01.59	12.61	83.6104-0210.3 83.6204-0220.3	330473 330308	<input type="checkbox"/> <input type="checkbox"/>	L=210 L=220
	190 b. Db		01.59	12.61	03.3223-0102.3	020090		Rz 23,81
MERCEDES BENZ (W121) 190 SL (55-60)								
	190 SL		01.55	12.60	03.3126-0505.3	010294		Hz 26,99 ATE
	190 SL		01.55	12.60	83.7704-0320.3	330851	2 <input type="checkbox"/>	L=320
	190 SL		01.55	12.60	03.2728-2101.3 03.2728-2201.3 03.0402-1128.2	020008 020009 060027	<input type="checkbox"/> <input type="checkbox"/> <input type="checkbox"/>	Rz 28,57 Rz 28,57 Rz Reparatursatz
	190 SL		01.55	12.60	83.6104-0210.3 83.6204-0220.3	330473 330308	<input type="checkbox"/> <input type="checkbox"/>	L=210 L=220
	190 SL		01.55	12.60	03.3223-0102.3	020090		Rz 23,81
MERCEDES BENZ (W123) 200-300 TD Turbo (76-85)								
	200 200 D 220 D 230 230 C 230 T 240 D 240 TD 250 250 T		093032 164440 112975 008670 001048 092734 001423 057387 000765	01.76 01.76 01.76 01.76 03.77 04.78 01.76 02.78 01.76 04.78	01.79	03.6850-0202.4	300043	9" ATE

1) + booster unit / + servofreno / + servo-frein / + servofreno

MERCEDES BENZ (W123) 200-300 TD Turbo (76-85)										
	280 280 C 280 CE 280 E 280 TE 300 D 300 TD		024581 002609 011831 046827 000620 116225 001361	01.76 03.77 03.77 01.76 02.78 01.76 04.78		03.6850-0202.4	300043		9"	ATE
	230 230 E 240 D 240 D 250 280 E 300 D			12.85 + Spezialaufbau ¹⁾ 12.85 + Spezialaufbau ¹⁾ 12.85 + Spezialaufbau ¹⁾ 12.85 + langer Radstand ²⁾ 12.85 + langer Radstand ²⁾ 12.85 + langer Radstand ²⁾ 12.85 + langer Radstand ²⁾		03.6855-1202.4	300056		9" Tandem	ATE
	200 200 D 200 T 220 D 230 230 C 230 CE 230 E 230 T 230 TE 240 D 240 TD 250 250 T 280 280 C 280 CE 280 E 280 TE 300 D 300 TD 300 TD Turbo			01.76 09.85 01.76 03.85 11.80 12.85 01.76 01.79 01.76 02.81 03.77 04.80 06.80 07.85 06.80 09.85 04.78 04.80 06.80 12.85 01.76 07.85 02.78 12.85 01.76 07.85 04.78 08.82 01.76 07.81 03.77 03.80 03.77 07.85 01.76 09.85 04.78 12.85 01.76 07.85 04.78 12.85 08.80 12.85		03.2023-0166.3	010015		THz 23,81/19,05	ATE
	230 230 E 240 D 240 D 250 280 E 300 D		173999 414568 414568 118041 115175 310479	01.76 12.85 + Spezialaufbau ¹⁾ 06.80 + Spezialaufbau ¹⁾ 01.76 + Spezialaufbau ¹⁾ 01.76 + langer Radstand ²⁾ 01.76 + langer Radstand ²⁾ 01.76 + langer Radstand ²⁾ 01.76 + langer Radstand ²⁾		03.2023-0166.3	010015		THz 23,81/19,05	ATE
	230 E 240 D 240 D 250 280 E 300 D	174000 414569 414569 118042 115176 310480		12.85 + Spezialaufbau ¹⁾ 12.85 + Spezialaufbau ¹⁾ 12.85 + langer Radstand ²⁾ 12.85 + langer Radstand ²⁾ 12.85 + langer Radstand ²⁾ 12.85 + langer Radstand ²⁾		03.2025-0111.3	010033		THz 25,40/19,05	ATE
	200 200 200 D 200 T 220 D 230 230 C 230 CE 230 E 230 T 230 TE 240 D 240 TD 250 250 T 280 280 C 280 CE 280 E 280 TE 300 D 300 TD 300 TD Turbo	69		01.76 09.85 01.76 09.85 01.76 03.85 11.80 12.85 01.76 01.79 01.76 02.81 03.77 04.80 06.80 07.85 06.80 09.85 04.78 04.80 06.80 12.85 01.76 07.85 02.78 12.85 01.76 07.85 04.78 08.82 01.76 07.81 03.77 03.80 03.77 07.85 01.76 09.85 04.78 12.85 01.76 07.85 04.78 12.85 08.80 12.85		24.9260-8029.5 24.9260-8030.5 13.0441-6003.2	230043 230044 250128	<input type="checkbox"/> <input type="checkbox"/>	D=60 D=60 Dichtungssatz	ATE ATE ATE
	200 200 200 D 220 D 230 230 C 230 T 240 D 240 TD 250 250 T 280 280 C 280 CE 280 E	69		01.76 07.79 01.76 07.79 01.76 07.79 01.76 01.79 01.76 07.79 03.77 07.79 04.78 07.79 01.76 07.79 02.78 07.79 01.76 07.79 04.78 07.79 01.76 07.79 03.77 07.79 03.77 07.79 01.76 07.79		13.0460-9028.2 13.0460-0027.2 13.0460-0911.2 24.8190-0401.2	609028 610027 610911 620401	4	20392 15,0 /WE Belagsatz-Zubehör Belagsatz-Zubehör Warnkontakt L=95mm	ATE ATE BDX





















¹⁾ + special body / + carrozzeria speciale / + carrosserie spéciale / + construcc.carrocería especial
²⁾ + long wheel base / + passo lungo / + empattement long / + distancia larga entre ejes



MERCEDES BENZ (W123) 200-300 TD Turbo (76-85)

	280 TE		04.78	07.79	13.0460-9028.2	609028		20392 15,0 /WE Belagsatz-Zubehör Belagsatz-Zubehör Warnkontakt L=95mm	ATE	
	300 D		01.76	07.79	13.0460-0027.2	610027			ATE	
	300 TD		04.78	07.79	13.0460-0911.2	610911		20341 16,7 /WE Belagsatz-Zubehör Warnkontakt L=95mm	ATE	
					24.8190-0401.2	620401	4		ATE	
	200	69	08.79	09.85	13.0460-9029.2	609029				
	200		08.79	09.85	13.0460-0131.2	610131				
	200 D		08.79	03.85	24.8190-0401.2	620401	4			
	200 T		11.80	12.85						
	230		08.79	02.81						
	230 C		08.79	04.80						
	230 CE		06.80	07.85						
	230 E		06.80	09.85						
	230 T		08.79	04.80						
	230 TE		06.80	12.85						
	240 D		08.79	07.85						
	240 TD		08.79	12.85						
	250		08.79	07.85						
	250 T		08.79	08.82						
	280		08.79	07.81						
	280 C		08.79	03.80						
	280 CE		08.79	07.85						
	280 E		08.79	09.85						
	280 TE		08.79	12.85						
	300 D		08.79	07.85						
	300 TD		08.79	12.85						
	300 TD Turbo		08.80	12.85						
	200	69	01.76	09.85	24.0113-0137.1	413137		278 12,6 10,6 +B		
	200		01.76	09.85						
	200 D		01.76	03.85						
	200 T		11.80	12.85						
	220 D		01.76	01.79						
	230		01.76	02.81						
	230 C		03.77	04.80						
	230 CE		06.80	07.85						
	230 E		06.80	09.85						
	230 T		04.78	04.80						
	230 TE		06.80	12.85						
	240 D		01.76	07.85						
	240 TD		02.78	12.85						
	250		01.76	07.85						
	250 T		04.78	08.82						
	280		01.76	07.81						
	280 C		03.77	03.80						
	280 CE		03.77	07.85						
	280 E		01.76	09.85						
	280 TE		04.78	12.85						
	300 D		01.76	07.85						
	300 TD		04.78	12.85						
	300 TD Turbo		08.80	12.85						
	200	69	126115	01.76	83.6104-0360.3	330475	2	L=360		
	200		126115	01.76						
	200 D		179856	01.76						
	220 D			01.76						
	230		158355	01.76						
	230 C		015330	03.77						
	230 T		004326	04.78						
	240 D		150314	01.76						
	240 TD		007370	02.78						
	250		079228	01.76						
	250 T		003285	04.78						
	280		027813	01.76						
	280 C		003416	03.77						
	280 CE		017058	03.77						
	280 E		064176	01.76						
	280 TE		004195	04.78						
	300 D		165147	01.76						
	300 TD		011092	04.78						
	200	69	126116	09.85	24.5101-0346.3	331406	2		L=346	
	200		126116	09.85						
	200 D		179857	03.85						
	200 T			11.80						
	230		158356	02.81						
	230 C		015331	02.81						
	230 CE			06.80						
	230 E			06.80						
	230 T			04.80						
	230 TE	004327		06.80						
	240 D		150315	07.85						
	240 TD		007371	12.85						
	250		079229	07.85						
	250 T		003286	08.82						
	280		027814	07.81						
	280 C		003417	03.80						
	280 CE		017059	07.85						
	280 E		064177	09.85						
	280 TE		004196	12.85						
	300 D		165148	07.85						



MERCEDES BENZ (W123) 200-300 TD Turbo (76-85)										
										
	300 TD 300 TD Turbo	011093		12.85 12.85		24.5101-0346.3	331406	2	L=346	
	200 200 200 D 220 D 230 230 C 230 CE 230 E 240 D 250 280 280 C 280 CE 280 E 300 D	69		01.76 09.85 01.76 09.85 01.76 03.85 01.76 01.79 01.76 02.81 03.77 04.80 06.80 07.85 06.80 09.85 01.76 07.85 01.76 07.85 01.76 07.81 03.77 03.80 03.77 07.85 01.76 09.85 01.76 07.85		13.2381-8027.2 13.2381-8028.2 13.0441-3811.2	210033 210034 250067	 	D=38 D=38 Dichtungssatz	ATE ATE ATE
	200 T 230 T 230 TE 240 TD 250 T 280 TE 300 TD 300 TD Turbo			11.80 12.85 04.78 04.80 06.80 12.85 02.78 12.85 04.78 08.82 04.78 12.85 04.78 12.85 08.80 12.85		13.2421-8021.2 24.9242-8021.5 24.9242-8022.5 13.0441-4206.2	210057 230031 230032 250087	  	D=42 D=42 D=42 Dichtungssatz	ATE ATE ATE ATE
	200 200 200 D 220 D 230 230 C 230 CE 230 E 240 D 250 280 280 C 280 CE 280 E 300 D	69		01.76 09.85 01.76 09.85 01.76 03.85 01.76 01.79 01.76 02.81 03.77 04.80 06.80 07.85 06.80 09.85 01.76 07.85 01.76 07.85 01.76 07.81 03.77 03.80 03.77 07.85 01.76 09.85 01.76 07.85		13.0460-4036.2 13.0460-3804.2 13.0460-0029.2 13.0460-0912.2	604036 603804 610029 610912	+ Anti-Noise-Blech ¹⁾	21035 15,0 21035 15,0 Belagsatz-Zubehör Belagsatz-Zubehör	ATE ATE ATE BDX
	200 T 230 T 230 TE 240 TD 250 T 280 TE 300 TD 300 TD Turbo			11.80 12.85 04.78 04.80 06.80 12.85 02.78 12.85 04.78 08.82 04.78 12.85 04.78 12.85 08.80 12.85		13.0460-3804.2 13.0460-0029.2 13.0460-0912.2	603804 610029 610912		21035 15,0 Belagsatz-Zubehör Belagsatz-Zubehör	ATE ATE BDX
	200 200 200 D 200 T 220 D 230 230 C 230 CE 230 E 230 T 230 TE 240 D 240 TD 250 250 T 280 280 C 280 CE 280 E 280 TE 300 D 300 TD 300 TD Turbo	69		01.76 09.85 01.76 09.85 01.76 03.85 11.80 12.85 01.76 01.79 01.76 02.81 03.77 04.80 06.80 07.85 06.80 09.85 04.78 04.80 06.80 12.85 01.76 07.85 02.78 12.85 01.76 07.85 04.78 08.82 01.76 07.81 03.77 03.80 03.77 07.85 01.76 09.85 04.78 12.85 01.76 07.85 04.78 12.85 08.80 12.85		24.0110-0185.1	410185		279 10,0 8,3 +S +B	
	200 200 200 D 200 T 220 D 230 230 C 230 CE 230 E 230 T 230 TE 240 D 240 TD 250	69		01.76 09.85 01.76 07.95 01.76 03.85 11.80 12.85 01.76 01.79 01.76 02.81 03.77 04.80 06.80 07.85 06.80 09.85 04.78 04.80 06.80 12.85 01.76 07.85 02.78 12.85 01.76 07.85		83.7704-0281.3	330804	2	L=280	

¹⁾ + shim / + lamierino antirumore / + tôle anti-bruit / + placa anti-ruídos



MERCEDES BENZ (W123) 200-300 TD Turbo (76-85)

	250 T 280 280 C 280 CE 280 E 280 TE 300 D 300 TD 300 TD Turbo			04.78 08.82 01.76 07.81 03.77 03.80 03.77 07.85 01.76 09.85 04.78 12.85 01.76 07.85 04.78 12.85 08.80 12.85	83.7704-0281.3	330804	2		L=280
	200 200 200 D 200 T 220 D 230 230 C 230 CE 230 E 230 T 230 TE 240 D 240 TD 250 250 T 280 280 C 280 CE 280 E 280 TE 300 D 300 TD 300 TD Turbo	69		01.76 09.85 01.76 09.85 01.76 03.85 11.80 12.85 01.76 01.79 01.76 02.81 03.77 04.80 06.80 07.85 06.80 09.85 04.78 04.80 06.80 12.85 01.76 07.85 02.78 12.85 01.76 07.85 04.78 08.82 01.76 07.81 03.77 03.80 03.77 07.85 01.76 09.85 04.78 12.85 01.76 07.85 04.78 12.85 01.76 07.85 04.78 12.85 08.80 12.85	03.0137-0171.2 03.0137-0402.2	650171 669002			160 x 25 /Zub Bremsbacken-Zubehör
	200 200 200 D 200 T 220 D 230 230 E 230 T 230 TE 240 D 240 TD 250 250 T 280 280 E 280 TE 300 D 300 TD 300 TD Turbo	69		01.76 09.85 01.76 07.85 01.76 03.85 11.80 12.85 01.76 01.79 01.76 02.81 06.80 09.85 04.78 04.80 06.80 12.85 01.76 07.85 02.78 12.85 01.76 07.85 04.78 08.82 01.76 07.81 01.76 09.85 04.78 12.85 01.76 07.85 04.78 12.85 08.80 12.85	24.3727-0403.2 24.3727-0401.2 24.3727-0402.2	580403 580401 580402	1 + Linkstenker 1) <input type="checkbox"/> <input type="checkbox"/>		L=1738 L=1640 L=1616
	230 C 230 CE 280 C 280 CE			03.77 04.80 06.80 07.85 03.77 03.80 03.77 07.85	24.3727-0401.2 24.3727-0402.2	580401 580402	<input type="checkbox"/> <input type="checkbox"/>		L=1640 L=1616
	200 200 200 D 200 T 220 D 230 230 C 230 CE 230 E 230 T 230 TE 240 D 240 TD 250 250 T 280 280 C 280 CE 280 E 280 TE 300 D 300 TD 300 TD Turbo	69	091118 091118 091118 015866 091118 091118 091118 091118 091118 015866 015866 091118 015866 091118 015866 091118 091118 091118 015866 091118 015866 015866	01.76 01.76 01.76 11.80 01.76 01.76 03.77 06.80 06.80 04.78 06.80 01.76 02.78 01.76 04.78 01.76 03.77 03.77 01.76 04.78 01.76 04.78 08.80	24.2419-0901.3	030041			Gz 19,05
	200 200 200 D 200 T 220 D 230 230 C 230 CE 230 E	69	091119 091119 091119 015867 091119 091119 091119 091119 091119	09.85 09.85 03.85 12.85 01.79 02.81 04.80 07.85 09.85	24.2419-0936.3	030062			Gz 19,05

1) + left hand drive / + guida a sinistra / + conduite à gauche / + volante a la izquierda





MERCEDES BENZ (W123) 200-300 TD Turbo (76-85)

	230 T 230 TE 240 D 240 TD 250 250 T 280 280 C 280 CE 280 E 280 TE 300 D 300 TD 300 TD Turbo	015867 015867 091119 015867 091119 015867 091119 091119 091119 091119 015867 091119 015867 015867		04.80 12.85 07.85 12.85 07.85 08.82 07.81 03.80 07.85 09.85 12.85 07.85 12.85		24.2419-0936.3 030062		Gz 19,05
	200 200 D 220 D 230 230 C 230 T 240 D 240 TD 280 280 C 300 D 300 TD	69	238053 219674 014172	01.76 01.76 01.76 01.76 03.77 04.78 01.76 02.78 01.76 03.77 01.76 04.78	08.80 01.79 02.81 04.80 04.80 07.81 03.80 07.85 12.85	03.2523-0811.3 03.0450-2311.2	040019 082311	Nz 23,81 Nz Reparatursatz
	200 200 D 200 T 230 CE 230 E 230 TE 240 D 240 TD	80	238054	03.80 11.80 06.80 06.80 06.80	09.85 03.85 12.85 07.85 09.85 12.85 07.85 12.85	24.2523-1210.3	040105	Nz 23,81
	200 200 D 200 T 220 D 230 230 C 230 CE 230 E 230 T 230 TE 240 D 240 TD 250 250 T 280 280 C 280 CE 280 E 280 TE 300 D 300 TD 300 TD Turbo	69		01.76 01.76 01.76 11.80 01.76 01.76 03.77 04.78 06.80 06.80 01.76 02.78 01.76 04.78 01.76 03.77 01.76 04.78 01.76 04.78 08.80	09.85 09.85 03.85 12.85 01.79 02.81 04.80 07.85 09.85 12.85 07.85 12.85 07.85 08.82 07.81 03.80 07.85 09.85 12.85 07.85 12.85 12.85	24.5901-0225.3	331288	L=225

MERCEDES BENZ (W124) E-Klasse (85-93)















	230 E Kombi 230 E Kombi 250 D Kombi 250 D Kombi 260 E Kombi 300 CE 24 Cabrio alle Typen Coupe alle Typen Kombi alle Typen Lim.		F163537 F161233 F163537 F161233 F161233	10.85 10.85 10.85 10.85 10.85	+ Spezialaufbau/Radstand 2800mm ¹⁾ + Spezialaufbau/Radstand 3450mm ²⁾ + Spezialaufbau/Radstand 2800mm ¹⁾ + Spezialaufbau/Radstand 3450mm ²⁾ + Spezialaufbau/Radstand 3450mm ²⁾	03.7760-2702.4	300090	10"	ATE
	250 D 260 E 280 E 300 CE 24 Cabrio alle Typen Coupe alle Typen Kombi alle Typen Lim.	◀ ◀ ◀		01.90 01.90 10.92 01.92 05.87 10.85 01.85	06.93 06.93 06.93 06.93 06.93 06.93 06.93 + 4 türig/ - 400 E/ - 500 E ³⁾	03.2023-0825.3	010028	Thz 23,81/19,05	ATE
	250 D 260 E 280 E	▶ ▶ ▶		01.90 01.90 10.92	06.93 06.93 06.93 + 6 türig ⁴⁾	03.2023-0230.3	010019	Thz 23,81/19,05	ATE
	400 E 500 E		B927760	10.92 01.91	06.93	03.2025-0211.3	010034	Thz 25,40/19,05	ATE
	200 200 CE 200 D 200 E 200 T 200 TD			01.85 04.90 01.85 01.85 10.85 10.85	02.90 09.92 06.93 09.92 02.90 08.91	24.3541-1725.5 24.3541-1726.5 11.0441-5404.2 11.0101-5403.2	240003 240004 250029 260010	D=54, - Halter D=54, - Halter Dichtungssatz Fallenbalgsatz	TRW TRW TRW TRW

1) + special body/wheel base 2800mm / + carrozz. spec./ passo 2800mm / + carross.spéc./ empatt. 2800mm / + con.carr.esp./ dist.ejes 2800mm
 2) + special body/wheel base 3450mm / + carrozz. spec./ passo 3450mm / + carross.spéc./ empatt. 3450mm / + con.carr.esp./ dist.ejes 3450mm
 3) + 4 door/ - 400 E/ - 500 E / + 4 porte/ - 400 E/ - 500 E / + 4 portes/ - 400 E/ - 500 E / + 4 puertas/ - 400 E/ - 500 E
 4) + 6 door / + 6 porte / + 6 portes / + 6 puertas





MERCEDES BENZ (W124) E-Klasse (85-93)

	200 TE 230 CE 230 E 230 E 230 E Kombi 230 TE 250 D 250 D Kombi 250 TD 300 D 300 TD	A323451	A797178 A805931 A279007 F081909 F081909	10.88 05.87 01.85 01.85 10.85 01.85 10.85 10.85 01.85 04.86	09.92 06.93 06.93 06.93 06.93 06.93 06.93 06.93 06.93 06.93	+ 4 türig ²⁾ + Spezialaufbau ¹⁾	24.3541-1725.5 24.3541-1726.5 11.0441-5404.2 11.0101-5403.2	240003 240004 250029 260010	 	D=54, - Halter D=54, - Halter Dichtungssatz Faltenbalgsatz	TRW TRW TRW TRW
	200 CE 200 E 200 TE 220 CE 220 E 220 TE 230 CE 230 E 230 E 230 E Kombi 230 TE 250 D 250 D Turbo 250 TD Turbo 260 E 260 E 260 E Kombi 280 E 280 TE 300 CE 300 D Turbo 300 E 300 TD Turbo 300 TE	A797179 A279008 A805932 F081910 F081910	A323450	10.92 10.92 10.92 10.92 10.92 10.92 09.92 09.92 09.92 09.92 09.92 01.90 09.88 04.90 01.85 01.90 10.85 10.92 10.92 05.87 09.87 01.85 10.85 10.85	06.93 06.93 06.93 06.93 06.93 06.93 06.93 09.92 09.92 09.92 09.92 06.93 06.93 06.93 09.92 09.92 09.92 09.92 06.93 06.93 09.92 06.93 09.92 09.92	+ 6 türig ³⁾ + 4 türig ²⁾ + 6 türig ³⁾ + Spezialaufbau ¹⁾ + Radstand 2800mm ⁴⁾	24.3541-1603.5 24.3541-1604.5 24.0101-3601.2	240037 240038 260044	  	D=54, - Halter D=54, - Halter Bremsattel-Zubehör	TRW TRW TRW
	280 E 280 E Kombi 300 CE 24 Cabrio 300 CE 24 Coupe 300 E 24 300 TE 24 320 CE 320 E 320 TE	B884946 F242721	B884946 F242721	10.92 10.92 01.92 09.89 09.89 09.89 10.92 10.92 10.92	06.93 06.93 06.93 09.92 09.92 09.92 09.92 09.92	+ Radstand 3600mm ⁵⁾ + Spezialaufbau ¹⁾	13.0441-4214.2	250091		Dichtungssatz	ATE
	280 E 280 E Kombi 320 CE 320 E 320 TE 400 E	B884947 F242722 B862122 B864308 F242722	B884947 F242722 B862122 B864308 F242722	06.93 06.93 06.93 06.93 06.93 10.92	06.93 06.93 06.93 06.93 06.93 10.92	+ Radstand 3600mm ⁵⁾ + Spezialaufbau ¹⁾	13.0441-4214.2	250091		Dichtungssatz	ATE
	500 E	B938568	B938568	10.92	06.93		13.0441-4214.2	250091	 	D=42/38 D=42/38	ATE ATE
	400 E 500 E	B938569 B927761	B938569 B927761	06.93 06.93	06.93 06.93		13.0441-4214.2	250091	 	Dichtungssatz	ATE
	200 200 CE 200 D 200 E 220 CE 220 E 230 CE 230 E 250 D 250 D Turbo 260 E 260 E 4-Matic 280 E 300 CE 300 D 300 D 4-Matic 300 D Turbo 300 D Turbo 4-Matic 300 E 300 E 4-Matic			01.85 04.90 01.85 01.85 10.92 10.92 05.87 01.85 01.85 09.88 01.85 05.85 10.92 05.87 01.85 12.86 09.87 09.87 01.85 11.86	02.90 06.93 06.93 06.93 06.93 06.93 09.92 09.92 06.93 06.93 09.92 08.91 06.93 09.92 06.93 08.91 06.93 06.93 09.92 06.93	+ Radstand 2800mm ⁴⁾	13.0460-2927.2 13.0470-2927.2 24.8190-0402.2	602927 LD2927 620402	  2	20941 19,3 /WE/S 20941 19,3 /WE/S Warnkontakt L=68(150)mm	TRW TRW TRW
	200 T 200 TD 200 TE 220 TE 230 E Kombi 230 TE 250 D Kombi 250 TD 250 TD Turbo 260 E Kombi 280 TE 300 TD			10.85 10.85 10.88 10.92 01.85 10.85 10.85 10.85 04.90 10.85 10.92 04.86	02.90 08.91 06.93 06.93 09.92 09.92 06.93 06.93 06.93 09.92 06.93 06.93	+ Spezialaufbau ¹⁾ + Spezialaufbau ¹⁾ + 4 türig ²⁾ + Spezialaufbau ¹⁾	13.0460-2927.2 13.0470-2927.2 24.8190-0402.2	602927 LD2927 620402	  2	20941 19,3 /WE/S 20941 19,3 /WE/S Warnkontakt L=68(150)mm	TRW TRW TRW

¹⁾ + special body / + carrozzeria speciale / + carrosserie spéciale / + construcc.carrocería especial

²⁾ + 4 door / + 4 porte / + 4 portes / + 4 puertas

³⁾ + 6 door / + 6 porte / + 6 portes / + 6 puertas

⁴⁾ + wheel base 2800 mm / + passo 2800 mm / + empattement 2800 mm / + distancia entre ejes 2800 mm

⁵⁾ + wheel base 3600 mm / + passo 3600 mm / + empattement 3600 mm / + distancia entre ejes 3600 mm





MERCEDES BENZ (W124) E-Klasse (85-93)

	300 TD Turbo			10.85	06.93	13.0460-2927.2	602927	2	20941 19,3 /WE/S 20941 19,3 /WE/S Warnkontakt L=68(150)mm	TRW TRW			
	300 TD Turbo 4-Matic			03.87	06.93	13.0470-2927.2	LD2927						
	300 TE			10.85	09.92	24.8190-0402.2	620402						
	300 TE 4-Matic			11.86	06.93								
	280 E		B884946	10.92		13.0460-4201.2	604201				4	21153 17,5 /WE Belagsatz-Zubehör Warnkontakt L=95mm	ATE ATE
	280 E Kombi		F242721	10.92		13.0460-0219.2	610219						
	300 CE 24 Cabrio			01.92	06.93	24.8190-0401.2	620401						
	300 CE 24 Coupe			09.89	09.92								
	300 E 24			09.89	09.92								
	300 TE 24			09.89	09.92								
320 CE		B862121	10.92										
320 E		B864307	10.92										
320 TE		F242721	10.92										
400 E	B938569			06.93									
500 E			01.91	06.93									
280 E	B884947			06.93	+ Radstand 3600mm ¹⁾	13.0460-4202.2	604202	4	21153 16,0 /WE Belagsatz-Zubehör Warnkontakt L=95mm	ATE			
280 E Kombi	F242722			06.93	+ Spezialaufbau ²⁾	13.0460-0268.2	610268						
320 CE	B862122			06.93		24.8190-0401.2	620401						
320 E	B864308			06.93									
320 TE	F242722			06.93									
400 E	B938568		10.92										
	200			01.85	02.90	24.0112-0117.1	412117	4	284 12,0 10,0 +S +B Halterschraube				
	200 CE			04.90	09.92	13.8190-0242.1	990124						
	200 D			01.85	06.93								
	200 E			01.85	09.92								
	200 T			10.85	02.90								
	200 TD			10.85	08.91								
	200 TE			10.88	09.92								
	230 CE		A797178	05.87									
	230 E	A323451	A805931										
	230 E		A279007	01.85									
	230 E Kombi		F081909	01.85		+ Spezialaufbau ²⁾							
	230 TE		F081909	10.85									
	250 D			01.85	06.93								
	250 D Kombi			10.85	06.93	+ Spezialaufbau ²⁾							
	250 TD			10.85	06.93								
	300 D			01.85	06.93								
	300 TD			04.86	06.93								
	200 CE			10.92	06.93	24.0122-0123.1	422123				4	284 22,0 19,4 V L +S +B Halterschraube	
	200 E			10.92	06.93	13.8190-0242.1	990124						
	200 TE			10.92	06.93								
	220 CE			10.92	06.93								
	220 E			10.92	06.93								
	220 TE			10.92	06.93								
	230 CE		A797179		09.92								
	230 E		A279008										
	230 E		A805932		09.92								
	230 E Kombi		F081910		09.92	+ Spezialaufbau ²⁾							
	230 TE		F081910		09.92								
	250 D			01.90	06.93	+ 6 türig ³⁾							
	250 D Turbo			09.88	06.93								
250 TD Turbo			04.90	06.93	+ ①								
260 E			01.85	09.92	+ 4 türig ⁴⁾								
260 E			01.90	09.92	+ 6 türig ³⁾								
260 E Kombi			10.85	09.92	+ Spezialaufbau ²⁾								
280 E			10.92	06.93	+ Radstand 2800mm ⁵⁾								
280 TE			10.92	06.93									
300 CE			05.87	09.92									
300 D Turbo			09.87	06.93									
300 E			01.85	09.92									
300 TD Turbo			10.85	06.93									
300 TE			10.85	09.92									
260 E 4-Matic			05.85	08.91	24.0122-0134.1	422134	4	284 22,0 19,4 V L +B Halterschraube					
300 D 4-Matic			12.86	08.91	13.8190-0330.1	990134							
300 D Turbo 4-Matic			09.87	06.93									
300 E 4-Matic			11.86	06.93									
300 TD Turbo 4-Matic			03.87	06.93									
300 TE 4-Matic			11.86	06.93									
280 E	B884946		10.92		24.0122-0136.1	422136	4	295 22,0 19,4 V L +B Halterschraube					
280 E Kombi	F242721		10.92		13.8190-0242.1	990124							
300 CE 24 Cabrio			01.92	06.93									
300 CE 24 Coupe			09.89	09.92									
300 E 24			09.89	09.92									
300 TE 24			09.89	09.92									
320 CE		B862121	10.92										
320 E		B864307	10.92										
320 TE		F242721	10.92										
280 E	B884947			06.93	+ Radstand 3600mm ¹⁾	24.0125-0107.1				425107			
280 E Kombi	F242722			06.93	+ Spezialaufbau ²⁾	13.8190-0242.1	990124						
320 CE	B862122			06.93			4	294 25,0 22,4 V L +B Halterschraube					
320 E	B864308			06.93									
320 TE	F242722			06.93									
400 E	B938568		10.92										
500 E	B927760		01.91		24.0128-0103.1	428103							



¹⁾ + wheel base 3600 mm / + passo 3600 mm / + empattement 3600 mm / + distancia entre ejes 3600 mm

²⁾ + special body / + carrozzeria speciale / + carrosserie spéciale / + construcc.carrocería especial





















³⁾ + 6 door / + 6 porte / + 6 portes / + 6 puertas

⁴⁾ + 4 door / + 4 porte / + 4 portes / + 4 puertas

⁵⁾ + wheel base 2800 mm / + passo 2800 mm / + empattement 2800 mm / + distancia entre ejes 2800 mm

MERCEDES BENZ (W124) E-Klasse (85-93)												
	200 T			10.85	02.90		13.0460-3805.2	603805		21197 15,0 /WE	ATE	
	200 TD			10.85	08.91		13.0470-3805.2	LD3805		21197 15,0 /WE	ATE	
	200 TE			10.88	06.93		13.0460-0215.2	610215		Belagsatz-Zubehör	ATE	
	220 TE			10.92	06.93		24.8190-0401.2	620401	4	+ ASR	Warnkontakt L=95mm	
	230 E Kombi			01.85	09.92	+ Spezialaufbau 1)						
	230 TE			10.85	09.92							
	250 D			01.90	06.93	+ Radstand 3600mm 2)						
	250 D Kombi			10.85	06.93	+ Spezialaufbau 1)						
	250 TD			10.85	06.93							
	250 TD Turbo			04.90	06.93	+ ⊕						
	260 E			01.90	09.92	+ Radstand 3600mm 2)						
	260 E Kombi			10.85	09.92	+ Spezialaufbau 1)						
	280 TE			10.92	06.93							
	300 CE 24 Cabrio			01.92	06.93							
	300 CE 24 Coupe			09.89	09.92							
	300 E 24			09.89	09.92							
	300 TD			04.86	06.93							
	300 TD Turbo			10.85	06.93							
	300 TD Turbo 4-Matic			03.87	06.93							
	300 TE			10.85	09.92							
	300 TE 4-Matic			11.86	06.93							
	320 CE			10.92	06.93							
	320 E			10.92	06.93							
	260 E			09.89	09.92	+ ASR/ + Radstand 2800mm 3)		13.0460-3504.2	603504		21301 15,5 /WE	ATE
	280 E			10.92	06.93	+ ASR/ + Radstand 2800mm 3)		24.8190-0401.2	620401	4	Warnkontakt L=95mm	ATE
300 CE			09.89	09.92	+ ASR		13.0460-0171.2	610171		Belagsatz-Zubehör	ATE	
300 D Turbo 4-Matic			09.87	06.93	+ ASR							
300 E			09.89	09.92	+ ASR							
280 E			10.92	06.93	+ Radstand 3600mm 2)		13.0460-3805.2	603805		21197 15,0 /WE	ATE	
280 E Kombi			10.92	06.93	+ Spezialaufbau 1)		13.0470-3805.2	LD3805		21197 15,0 /WE	ATE	
300 TE 24			09.89	09.92			24.8190-0401.2	620401	4	Warnkontakt L=95mm		
320 TE			10.92	06.93								
400 E			10.92	06.93			13.0460-3805.2	603805		21197 15,0 /WE	ATE	
500 E		B927760	01.91				13.0470-3805.2	LD3805		21197 15,0 /WE	ATE	
							24.8190-0401.2	620401	4	Warnkontakt L=95mm		
500 E		B927761		06.93			13.0460-4047.2	604047		21305 15,7 /WE	ATE	
							13.0470-4047.2	LD4047		21305 15,7 /WE	ATE	
							13.0460-0236.2	610236		Belagsatz-Zubehör	ATE	
							24.8190-0401.2	620401	4	Warnkontakt L=95mm		
	200			01.85	02.90		24.0109-0120.1	409120		258 9,0 7,3 +S +B		
	200 CE			04.90	06.93							
	200 D			01.85	06.93							
	200 E			01.85	06.93							
	220 CE			10.92	06.93							
	220 E			10.92	06.93							
	230 CE			05.87	09.92							
	230 E			01.85	09.92							
	250 D			01.85	06.93	+ Radstand 2800mm 4)						
	250 D Turbo			09.88	06.93							
	260 E			01.85	09.92	+ Radstand 2800mm 4)						
	260 E 4-Matic			05.85	08.91							
	280 E			10.92	06.93	+ Radstand 2800mm 4)						
	300 CE			05.87	09.92							
	300 D			01.85	06.93							
	300 D 4-Matic			12.86	08.91							
	300 D Turbo			09.87	06.93							
	300 D Turbo 4-Matic			09.87	06.93							
	300 E			01.85	09.92							
	300 E 4-Matic			11.86	06.93							
200 T			10.85	02.90		24.0109-0114.1	409114			278 9,0 7,3 +S +B		
200 TD			10.85	08.91		24.0309-0114.1	509114			278 9,0 7,3 +S +B PD		
200 TE			10.88	06.93								
220 TE			10.92	06.93								
230 E Kombi			01.85	06.93	+ Spezialaufbau 1)							
230 TE			10.85	09.92								
250 D			01.90	06.93	+ Radstand 3600mm 2)							
250 D Kombi			10.85	06.93	+ Spezialaufbau 1)							
250 TD			10.85	06.93								
250 TD Turbo			04.90	06.93	+ ⊕							
260 E			01.90	09.92	+ Radstand 3600mm 2)							
260 E Kombi			10.85	06.93	+ Spezialaufbau 1)							
280 TE			10.92	06.93								
300 CE 24 Cabrio			01.92	06.93								
300 CE 24 Coupe			09.89	09.92								
300 E 24			09.89	09.92								
300 TD			04.86	06.93								
300 TD Turbo			10.85	06.93								
300 TD Turbo 4-Matic			03.87	06.93								
300 TE			10.85	09.92								
300 TE 4-Matic			11.86	06.93								
320 CE			10.92	06.93								
320 E			10.92	06.93								
280 E			10.92	06.93	+ Radstand 3600mm 2)		24.0120-0199.1	420199		278 19,9 17,4 V L		
280 E Kombi			10.92	06.93	+ Spezialaufbau 1)							
300 TE 24			09.89	09.92								
320 TE			10.92	06.93								

1) + special body / + carrozzeria speciale / + carrosserie spéciale / + construcc.carrocería especial
2) + wheel base 3600 mm / + passo 3600 mm / + empattement 3600 mm / + distancia entre ejes 3600 mm
3) + ASR/ + wheel base 2800mm / + ASR/ + passo 2800mm / + ASR/ + empattement 2800mm / + ASR/ + dist.entre ejes 2800 mm
4) + wheel base 2800 mm / + passo 2800 mm / + empattement 2800 mm / + distancia entre ejes 2800 mm

MERCEDES BENZ (W124) E-Klasse (85-93)																																																																																																																																																																																																																																	
	<table border="1"> <tr> <td>400 E</td> <td></td> <td>10.92</td> <td>06.93</td> <td>24.0124-0188.1</td> <td>424188</td> <td></td> <td>278 24,0 21,4 V L +B</td> </tr> <tr> <td>500 E</td> <td>B927761</td> <td></td> <td>06.93</td> <td>24.0122-0218.1</td> <td>422218</td> <td></td> <td>300 22,0 19,4 V L +B</td> </tr> </table>	400 E		10.92	06.93	24.0124-0188.1	424188		278 24,0 21,4 V L +B	500 E	B927761		06.93	24.0122-0218.1	422218		300 22,0 19,4 V L +B																																																																																																																																																																																																																
400 E		10.92	06.93	24.0124-0188.1	424188		278 24,0 21,4 V L +B																																																																																																																																																																																																																										
500 E	B927761		06.93	24.0122-0218.1	422218		300 22,0 19,4 V L +B																																																																																																																																																																																																																										
	<table border="1"> <tr> <td>200 CE</td> <td></td> <td>04.90</td> <td>06.93</td> <td>83.7704-0281.3</td> <td>330804</td> <td>2</td> <td>L=280</td> </tr> <tr> <td>200 TE</td> <td></td> <td>10.88</td> <td>06.93</td> <td></td> <td></td> <td></td> <td></td> </tr> <tr> <td>220 CE</td> <td></td> <td>10.92</td> <td>06.93</td> <td></td> <td></td> <td></td> <td></td> </tr> <tr> <td>230 CE</td> <td></td> <td>05.87</td> <td>06.93</td> <td></td> <td></td> <td></td> <td></td> </tr> <tr> <td>250 TD Turbo</td> <td></td> <td>04.90</td> <td>06.93</td> <td></td> <td></td> <td></td> <td></td> </tr> <tr> <td>280 TE</td> <td></td> <td>10.92</td> <td>06.93</td> <td></td> <td></td> <td></td> <td></td> </tr> <tr> <td>300 D Turbo</td> <td></td> <td>09.87</td> <td>06.93</td> <td></td> <td></td> <td></td> <td></td> </tr> <tr> <td>320 CE</td> <td></td> <td>10.92</td> <td>06.93</td> <td></td> <td></td> <td></td> <td></td> </tr> <tr> <td>320 E</td> <td></td> <td>10.92</td> <td>06.93</td> <td></td> <td></td> <td></td> <td></td> </tr> <tr> <td>320 TE</td> <td></td> <td>10.92</td> <td>06.93</td> <td></td> <td></td> <td></td> <td></td> </tr> <tr> <td>400 E</td> <td></td> <td>10.92</td> <td>06.93</td> <td></td> <td></td> <td></td> <td></td> </tr> <tr> <td>500 E</td> <td></td> <td>01.91</td> <td>06.93</td> <td></td> <td></td> <td></td> <td></td> </tr> <tr> <td>alle Typen</td> <td></td> <td>01.85</td> <td>06.93</td> <td></td> <td></td> <td></td> <td></td> </tr> </table>	200 CE		04.90	06.93	83.7704-0281.3	330804	2	L=280	200 TE		10.88	06.93					220 CE		10.92	06.93					230 CE		05.87	06.93					250 TD Turbo		04.90	06.93					280 TE		10.92	06.93					300 D Turbo		09.87	06.93					320 CE		10.92	06.93					320 E		10.92	06.93					320 TE		10.92	06.93					400 E		10.92	06.93					500 E		01.91	06.93					alle Typen		01.85	06.93																																																																																																																												
200 CE		04.90	06.93	83.7704-0281.3	330804	2	L=280																																																																																																																																																																																																																										
200 TE		10.88	06.93																																																																																																																																																																																																																														
220 CE		10.92	06.93																																																																																																																																																																																																																														
230 CE		05.87	06.93																																																																																																																																																																																																																														
250 TD Turbo		04.90	06.93																																																																																																																																																																																																																														
280 TE		10.92	06.93																																																																																																																																																																																																																														
300 D Turbo		09.87	06.93																																																																																																																																																																																																																														
320 CE		10.92	06.93																																																																																																																																																																																																																														
320 E		10.92	06.93																																																																																																																																																																																																																														
320 TE		10.92	06.93																																																																																																																																																																																																																														
400 E		10.92	06.93																																																																																																																																																																																																																														
500 E		01.91	06.93																																																																																																																																																																																																																														
alle Typen		01.85	06.93																																																																																																																																																																																																																														
	<table border="1"> <tr> <td>alle Typen</td> <td></td> <td>01.85</td> <td>06.93</td> <td>03.0137-0170.2</td> <td>650170</td> <td></td> <td>164 x 20 /Zub</td> </tr> </table>	alle Typen		01.85	06.93	03.0137-0170.2	650170		164 x 20 /Zub																																																																																																																																																																																																																								
alle Typen		01.85	06.93	03.0137-0170.2	650170		164 x 20 /Zub																																																																																																																																																																																																																										
	<table border="1"> <tr> <td>alle Typen Kombi</td> <td></td> <td>10.85</td> <td>06.93</td> <td>24.3727-0411.2</td> <td>580411</td> <td>1  + Linkslenker ²⁾</td> <td>L=2496</td> </tr> <tr> <td>alle Typen Lim.</td> <td></td> <td>01.85</td> <td>06.93</td> <td>24.3727-0409.2</td> <td>580409</td> <td>2  - Radstand 3600mm ³⁾</td> <td>L=1060</td> </tr> <tr> <td>alle Typen Coupe</td> <td></td> <td>05.87</td> <td>06.93</td> <td>24.3727-0409.2</td> <td>580409</td> <td>2 </td> <td>L=1060</td> </tr> </table>	alle Typen Kombi		10.85	06.93	24.3727-0411.2	580411	1  + Linkslenker ²⁾	L=2496	alle Typen Lim.		01.85	06.93	24.3727-0409.2	580409	2  - Radstand 3600mm ³⁾	L=1060	alle Typen Coupe		05.87	06.93	24.3727-0409.2	580409	2 	L=1060																																																																																																																																																																																																								
alle Typen Kombi		10.85	06.93	24.3727-0411.2	580411	1  + Linkslenker ²⁾	L=2496																																																																																																																																																																																																																										
alle Typen Lim.		01.85	06.93	24.3727-0409.2	580409	2  - Radstand 3600mm ³⁾	L=1060																																																																																																																																																																																																																										
alle Typen Coupe		05.87	06.93	24.3727-0409.2	580409	2 	L=1060																																																																																																																																																																																																																										
	<table border="1"> <tr> <td>alle Typen</td> <td></td> <td>01.85</td> <td>06.93</td> <td>24.2419-0915.3</td> <td>030045</td> <td>+ GG ⁴⁾</td> <td>Gz 19,05</td> </tr> <tr> <td></td> <td></td> <td></td> <td></td> <td>24.2419-1703.3</td> <td>030097</td> <td>+ ALU ⁵⁾</td> <td>Gz 19,05</td> </tr> </table>	alle Typen		01.85	06.93	24.2419-0915.3	030045	+ GG ⁴⁾	Gz 19,05					24.2419-1703.3	030097	+ ALU ⁵⁾	Gz 19,05																																																																																																																																																																																																																
alle Typen		01.85	06.93	24.2419-0915.3	030045	+ GG ⁴⁾	Gz 19,05																																																																																																																																																																																																																										
				24.2419-1703.3	030097	+ ALU ⁵⁾	Gz 19,05																																																																																																																																																																																																																										
	<table border="1"> <tr> <td>200</td> <td></td> <td>01.85</td> <td>02.90</td> <td>24.2523-1210.3</td> <td>040105</td> <td></td> <td>Nz 23,81</td> </tr> <tr> <td>200 CE</td> <td></td> <td>04.90</td> <td>06.93</td> <td></td> <td></td> <td></td> <td></td> </tr> <tr> <td>200 D</td> <td></td> <td>01.85</td> <td>06.93</td> <td></td> <td></td> <td></td> <td></td> </tr> <tr> <td>200 E</td> <td></td> <td>01.85</td> <td>06.93</td> <td></td> <td></td> <td></td> <td></td> </tr> <tr> <td>200 T</td> <td></td> <td>10.85</td> <td>02.90</td> <td></td> <td></td> <td></td> <td></td> </tr> <tr> <td>200 TD</td> <td></td> <td>10.85</td> <td>08.91</td> <td></td> <td></td> <td></td> <td></td> </tr> <tr> <td>200 TE</td> <td></td> <td>10.88</td> <td>06.93</td> <td></td> <td></td> <td></td> <td></td> </tr> <tr> <td>230 CE</td> <td></td> <td>05.87</td> <td>08.89</td> <td></td> <td></td> <td></td> <td></td> </tr> <tr> <td>230 E</td> <td></td> <td>01.85</td> <td>08.89</td> <td></td> <td></td> <td></td> <td></td> </tr> <tr> <td>230 TE</td> <td></td> <td>10.85</td> <td>08.89</td> <td></td> <td></td> <td></td> <td></td> </tr> <tr> <td>250 D</td> <td></td> <td>01.85</td> <td>08.89</td> <td></td> <td></td> <td></td> <td></td> </tr> <tr> <td>250 TD</td> <td></td> <td>10.85</td> <td>08.89</td> <td></td> <td></td> <td></td> <td></td> </tr> <tr> <td>260 E</td> <td></td> <td>01.85</td> <td>08.89</td> <td></td> <td></td> <td></td> <td></td> </tr> <tr> <td>260 E 4-Matic</td> <td></td> <td>05.85</td> <td>08.89</td> <td></td> <td></td> <td></td> <td></td> </tr> <tr> <td>300 CE</td> <td></td> <td>05.87</td> <td>08.89</td> <td></td> <td></td> <td></td> <td></td> </tr> <tr> <td>300 D</td> <td></td> <td>01.85</td> <td>08.89</td> <td></td> <td></td> <td></td> <td></td> </tr> <tr> <td>300 E</td> <td></td> <td>01.85</td> <td>08.89</td> <td></td> <td></td> <td></td> <td></td> </tr> <tr> <td>300 E 4-Matic</td> <td></td> <td>11.86</td> <td>08.89</td> <td></td> <td></td> <td></td> <td></td> </tr> <tr> <td>300 TD</td> <td></td> <td>04.86</td> <td>08.89</td> <td></td> <td></td> <td></td> <td></td> </tr> <tr> <td>300 TE</td> <td></td> <td>10.85</td> <td>08.89</td> <td></td> <td></td> <td></td> <td></td> </tr> <tr> <td>300 TE 4-Matic</td> <td></td> <td>11.86</td> <td>08.89</td> <td></td> <td></td> <td></td> <td></td> </tr> </table>	200		01.85	02.90	24.2523-1210.3	040105		Nz 23,81	200 CE		04.90	06.93					200 D		01.85	06.93					200 E		01.85	06.93					200 T		10.85	02.90					200 TD		10.85	08.91					200 TE		10.88	06.93					230 CE		05.87	08.89					230 E		01.85	08.89					230 TE		10.85	08.89					250 D		01.85	08.89					250 TD		10.85	08.89					260 E		01.85	08.89					260 E 4-Matic		05.85	08.89					300 CE		05.87	08.89					300 D		01.85	08.89					300 E		01.85	08.89					300 E 4-Matic		11.86	08.89					300 TD		04.86	08.89					300 TE		10.85	08.89					300 TE 4-Matic		11.86	08.89																																																												
200		01.85	02.90	24.2523-1210.3	040105		Nz 23,81																																																																																																																																																																																																																										
200 CE		04.90	06.93																																																																																																																																																																																																																														
200 D		01.85	06.93																																																																																																																																																																																																																														
200 E		01.85	06.93																																																																																																																																																																																																																														
200 T		10.85	02.90																																																																																																																																																																																																																														
200 TD		10.85	08.91																																																																																																																																																																																																																														
200 TE		10.88	06.93																																																																																																																																																																																																																														
230 CE		05.87	08.89																																																																																																																																																																																																																														
230 E		01.85	08.89																																																																																																																																																																																																																														
230 TE		10.85	08.89																																																																																																																																																																																																																														
250 D		01.85	08.89																																																																																																																																																																																																																														
250 TD		10.85	08.89																																																																																																																																																																																																																														
260 E		01.85	08.89																																																																																																																																																																																																																														
260 E 4-Matic		05.85	08.89																																																																																																																																																																																																																														
300 CE		05.87	08.89																																																																																																																																																																																																																														
300 D		01.85	08.89																																																																																																																																																																																																																														
300 E		01.85	08.89																																																																																																																																																																																																																														
300 E 4-Matic		11.86	08.89																																																																																																																																																																																																																														
300 TD		04.86	08.89																																																																																																																																																																																																																														
300 TE		10.85	08.89																																																																																																																																																																																																																														
300 TE 4-Matic		11.86	08.89																																																																																																																																																																																																																														
	<table border="1"> <tr> <td>220 CE</td> <td></td> <td>10.92</td> <td>06.93</td> <td>24.2523-1310.3</td> <td>040106</td> <td></td> <td>Nz 23,81</td> </tr> <tr> <td>220 E</td> <td></td> <td>10.92</td> <td>06.93</td> <td></td> <td></td> <td></td> <td></td> </tr> <tr> <td>220 TE</td> <td></td> <td>10.92</td> <td>06.93</td> <td></td> <td></td> <td></td> <td></td> </tr> <tr> <td>230 CE</td> <td></td> <td>09.89</td> <td>09.92</td> <td></td> <td></td> <td></td> <td></td> </tr> <tr> <td>230 E</td> <td></td> <td>09.89</td> <td>09.92</td> <td></td> <td></td> <td></td> <td></td> </tr> <tr> <td>230 TE</td> <td></td> <td>09.89</td> <td>09.92</td> <td></td> <td></td> <td></td> <td></td> </tr> <tr> <td>250 D</td> <td></td> <td>09.89</td> <td>06.93</td> <td></td> <td></td> <td></td> <td></td> </tr> <tr> <td>250 D Turbo</td> <td></td> <td>09.88</td> <td>06.93</td> <td></td> <td></td> <td></td> <td></td> </tr> <tr> <td>250 TD</td> <td></td> <td>09.89</td> <td>06.93</td> <td></td> <td></td> <td></td> <td></td> </tr> <tr> <td>250 TD Turbo</td> <td></td> <td>04.90</td> <td>06.93</td> <td>+ </td> <td></td> <td></td> <td></td> </tr> <tr> <td>260 E</td> <td></td> <td>09.89</td> <td>09.92</td> <td></td> <td></td> <td></td> <td></td> </tr> <tr> <td>260 E 4-Matic</td> <td></td> <td>09.89</td> <td>08.91</td> <td></td> <td></td> <td></td> <td></td> </tr> <tr> <td>280 TE</td> <td></td> <td>10.92</td> <td>06.93</td> <td></td> <td></td> <td></td> <td></td> </tr> <tr> <td>300 CE</td> <td></td> <td>09.89</td> <td>09.92</td> <td></td> <td></td> <td></td> <td></td> </tr> <tr> <td>300 CE 24 Cabrio</td> <td></td> <td>01.92</td> <td>06.93</td> <td></td> <td></td> <td></td> <td></td> </tr> <tr> <td>300 CE 24 Coupe</td> <td></td> <td>09.89</td> <td>09.92</td> <td></td> <td></td> <td></td> <td></td> </tr> <tr> <td>300 D</td> <td></td> <td>09.89</td> <td>06.93</td> <td></td> <td></td> <td></td> <td></td> </tr> <tr> <td>300 D 4-Matic</td> <td></td> <td>09.89</td> <td>08.91</td> <td></td> <td></td> <td></td> <td></td> </tr> <tr> <td>300 E</td> <td></td> <td>09.89</td> <td>09.92</td> <td></td> <td></td> <td></td> <td></td> </tr> <tr> <td>300 E 24</td> <td></td> <td>09.89</td> <td>09.92</td> <td></td> <td></td> <td></td> <td></td> </tr> <tr> <td>300 E 4-Matic</td> <td></td> <td>09.89</td> <td>06.93</td> <td></td> <td></td> <td></td> <td></td> </tr> <tr> <td>300 TD</td> <td></td> <td>09.89</td> <td>06.93</td> <td></td> <td></td> <td></td> <td></td> </tr> <tr> <td>300 TE</td> <td></td> <td>09.89</td> <td>09.92</td> <td></td> <td></td> <td></td> <td></td> </tr> <tr> <td>300 TE 24</td> <td></td> <td>09.89</td> <td>09.92</td> <td></td> <td></td> <td></td> <td></td> </tr> <tr> <td>300 TE 4-Matic</td> <td></td> <td>09.89</td> <td>06.93</td> <td></td> <td></td> <td></td> <td></td> </tr> <tr> <td>320 CE</td> <td></td> <td>10.92</td> <td>06.93</td> <td></td> <td></td> <td></td> <td></td> </tr> <tr> <td>320 E</td> <td></td> <td>10.92</td> <td>06.93</td> <td></td> <td></td> <td></td> <td></td> </tr> <tr> <td>320 TE</td> <td></td> <td>10.92</td> <td>06.93</td> <td></td> <td></td> <td></td> <td></td> </tr> </table>	220 CE		10.92	06.93	24.2523-1310.3	040106		Nz 23,81	220 E		10.92	06.93					220 TE		10.92	06.93					230 CE		09.89	09.92					230 E		09.89	09.92					230 TE		09.89	09.92					250 D		09.89	06.93					250 D Turbo		09.88	06.93					250 TD		09.89	06.93					250 TD Turbo		04.90	06.93	+ 				260 E		09.89	09.92					260 E 4-Matic		09.89	08.91					280 TE		10.92	06.93					300 CE		09.89	09.92					300 CE 24 Cabrio		01.92	06.93					300 CE 24 Coupe		09.89	09.92					300 D		09.89	06.93					300 D 4-Matic		09.89	08.91					300 E		09.89	09.92					300 E 24		09.89	09.92					300 E 4-Matic		09.89	06.93					300 TD		09.89	06.93					300 TE		09.89	09.92					300 TE 24		09.89	09.92					300 TE 4-Matic		09.89	06.93					320 CE		10.92	06.93					320 E		10.92	06.93					320 TE		10.92	06.93				
220 CE		10.92	06.93	24.2523-1310.3	040106		Nz 23,81																																																																																																																																																																																																																										
220 E		10.92	06.93																																																																																																																																																																																																																														
220 TE		10.92	06.93																																																																																																																																																																																																																														
230 CE		09.89	09.92																																																																																																																																																																																																																														
230 E		09.89	09.92																																																																																																																																																																																																																														
230 TE		09.89	09.92																																																																																																																																																																																																																														
250 D		09.89	06.93																																																																																																																																																																																																																														
250 D Turbo		09.88	06.93																																																																																																																																																																																																																														
250 TD		09.89	06.93																																																																																																																																																																																																																														
250 TD Turbo		04.90	06.93	+ 																																																																																																																																																																																																																													
260 E		09.89	09.92																																																																																																																																																																																																																														
260 E 4-Matic		09.89	08.91																																																																																																																																																																																																																														
280 TE		10.92	06.93																																																																																																																																																																																																																														
300 CE		09.89	09.92																																																																																																																																																																																																																														
300 CE 24 Cabrio		01.92	06.93																																																																																																																																																																																																																														
300 CE 24 Coupe		09.89	09.92																																																																																																																																																																																																																														
300 D		09.89	06.93																																																																																																																																																																																																																														
300 D 4-Matic		09.89	08.91																																																																																																																																																																																																																														
300 E		09.89	09.92																																																																																																																																																																																																																														
300 E 24		09.89	09.92																																																																																																																																																																																																																														
300 E 4-Matic		09.89	06.93																																																																																																																																																																																																																														
300 TD		09.89	06.93																																																																																																																																																																																																																														
300 TE		09.89	09.92																																																																																																																																																																																																																														
300 TE 24		09.89	09.92																																																																																																																																																																																																																														
300 TE 4-Matic		09.89	06.93																																																																																																																																																																																																																														
320 CE		10.92	06.93																																																																																																																																																																																																																														
320 E		10.92	06.93																																																																																																																																																																																																																														
320 TE		10.92	06.93																																																																																																																																																																																																																														
MERCEDES BENZ E-Klasse (W124) Limousine (93-95)																																																																																																																																																																																																																																	
	<table border="1"> <tr> <td>E 200</td> <td>100</td> <td>06.93</td> <td>06.95</td> <td>03.7760-2702.4</td> <td>300090</td> <td></td> <td>10"</td> <td>ATE</td> </tr> <tr> <td>E 200 D</td> <td>55</td> <td>06.93</td> <td>06.95</td> <td></td> <td></td> <td></td> <td></td> <td></td> </tr> <tr> <td>E 220</td> <td>110</td> <td>06.93</td> <td>06.95</td> <td></td> <td></td> <td></td> <td></td> <td></td> </tr> <tr> <td>E 250 D</td> <td>83</td> <td>07.93</td> <td>06.95</td> <td></td> <td></td> <td></td> <td></td> <td></td> </tr> <tr> <td>E 250 Turbo-D</td> <td>93</td> <td>06.93</td> <td>06.95</td> <td></td> <td></td> <td></td> <td></td> <td></td> </tr> <tr> <td>E 280</td> <td>145</td> <td>06.93</td> <td>06.95</td> <td></td> <td></td> <td></td> <td></td> <td></td> </tr> <tr> <td>E 300 4-matic</td> <td>132</td> <td>06.93</td> <td>06.95</td> <td></td> <td></td> <td></td> <td></td> <td></td> </tr> <tr> <td>E 300 D</td> <td>100</td> <td>07.93</td> <td>06.95</td> <td></td> <td></td> <td></td> <td></td> <td></td> </tr> <tr> <td>E 300 Turbo-D</td> <td>108</td> <td>06.93</td> <td>06.95</td> <td></td> <td></td> <td></td> <td></td> <td></td> </tr> <tr> <td>E 300 Turbo-D 4-matic</td> <td>108</td> <td>06.93</td> <td>06.95</td> <td></td> <td></td> <td></td> <td></td> <td></td> </tr> </table>	E 200	100	06.93	06.95	03.7760-2702.4	300090		10"	ATE	E 200 D	55	06.93	06.95						E 220	110	06.93	06.95						E 250 D	83	07.93	06.95						E 250 Turbo-D	93	06.93	06.95						E 280	145	06.93	06.95						E 300 4-matic	132	06.93	06.95						E 300 D	100	07.93	06.95						E 300 Turbo-D	108	06.93	06.95						E 300 Turbo-D 4-matic	108	06.93	06.95																																																																																																																																											
E 200	100	06.93	06.95	03.7760-2702.4	300090		10"	ATE																																																																																																																																																																																																																									
E 200 D	55	06.93	06.95																																																																																																																																																																																																																														
E 220	110	06.93	06.95																																																																																																																																																																																																																														
E 250 D	83	07.93	06.95																																																																																																																																																																																																																														
E 250 Turbo-D	93	06.93	06.95																																																																																																																																																																																																																														
E 280	145	06.93	06.95																																																																																																																																																																																																																														
E 300 4-matic	132	06.93	06.95																																																																																																																																																																																																																														
E 300 D	100	07.93	06.95																																																																																																																																																																																																																														
E 300 Turbo-D	108	06.93	06.95																																																																																																																																																																																																																														
E 300 Turbo-D 4-matic	108	06.93	06.95																																																																																																																																																																																																																														

¹⁾ - wheel base 3450mm / - passo 3450mm / - empattement 3450mm / - distancia entre ejes 3450mm

²⁾ - left hand drive / + guida a sinistra / + conduite à gauche / + volante a la izquierda

³⁾ - wheel base 3600mm / - passo 3600mm / - empattement 3600mm / - distancia entre ejes 3600mm

⁴⁾ - cast iron / + ghisa / + fonte grise / + fundición de gris

⁵⁾ - aluminium / + alluminio / + aluminium / + aluminio



MERCEDES BENZ E-Klasse (W124) Limousine (93-95)

	E 320 E 36 AMG	162 200		06.93 05.94	06.95 06.95		03.7760-2702.4	300090			10"	ATE
	E 200 E 200 D E 220 E 250 D E 250 Turbo-D E 280 E 280 E 300 4-matic E 300 D E 300 Turbo-D E 300 Turbo-D 4-matic E 320 E 36 AMG	100 55 110 83 93 142 145 132 100 108 108 162 200	C 164263 C 164263 C 164263 C 164263 C 164263 C 164263 C 164263 C 164263 C 164263 C 164263 C 164263 C 164263 C 164263	06.93 06.93 06.93 07.93 06.93 06.93 06.93 06.93 07.93 06.93 06.93 06.93 07.94	06.95		03.2023-0825.3	010028			Thz 23,81/19,05	ATE
	E 320 E 420 E 500 E 60 AMG	162 205 235 280	C 164263 C 164263 B 927760 B 927760	06.93 06.93 06.93 05.94	06.95		03.2025-0211.3	010034			Thz 25,40/19,05	ATE
	E 200 E 220 E 250 Turbo-D E 280 E 300 D E 300 Turbo-D	100 110 93 145 100 108		06.93 06.93 06.93 06.93 07.93 06.93	06.95 06.95 06.95 06.95 06.95 06.95		24.3541-1603.5 24.3541-1604.5 24.0101-3601.2 11.0101-5403.2	240037 240038 260044 260010			D=54, - Halter D=54, - Halter Bremsattel-Zubehör Faltenbalgsatz	TRW TRW TRW TRW
	E 200 D E 250 D	55 83		06.93 07.93	06.95 06.95		24.3541-1725.5 24.3541-1726.5 11.0441-5404.2 11.0101-5403.2	240003 240004 250029 260010			D=54, - Halter D=54, - Halter Dichtungssatz Faltenbalgsatz	TRW TRW TRW TRW
	E 280 E 320	142 162	B 864307 B 864307	06.93 06.93			13.0441-4214.2	250091			Dichtungssatz	ATE
	E 280 E 320 E 420	142 B 864308 162 B 864308 205	B 864307 B 938568	06.93 06.93	06.95 06.95		13.0441-4214.2	250091			Dichtungssatz	ATE
	E 300 4-matic E 300 Turbo-D 4-matic	132 108		06.93 06.93	06.95 06.95		11.0441-5404.2 11.0101-5403.2	250029 260010			Dichtungssatz Faltenbalgsatz	TRW TRW
	E 36 AMG E 420 E 500 E 60 AMG	200 205 B 938569 235 B 927761 280		07.94 06.95 06.95 05.94	06.95 06.95 06.95 06.95		13.0441-4214.2	250091			Dichtungssatz	ATE
	E 500	235	B 927760	06.93			24.9442-8003.5 24.9442-8004.5	230053 230054			D=42/38 D=42/38	ATE ATE
	E 200 E 200 D E 220 E 250 D E 250 Turbo-D E 280 E 280 E 300 4-matic E 300 D E 300 Turbo-D E 300 Turbo-D 4-matic	100 55 110 83 93 145 132 100 108 108		06.93 06.93 06.93 07.93 06.93 06.93 06.93 07.93 06.93 06.93 06.93	06.95 06.95 06.95 06.95 06.95 06.95 06.95 06.95 06.95 06.95 06.95		13.0460-2927.2 13.0470-2927.2 24.8190-0402.2	602927 LD2927 620402	2		20941 19,3 /WE/S 20941 19,3 /WE/S Warnkontakt L=68(150)mm	TRW TRW
	E 280 E 320 E 36 AMG E 420 E 500 E 60 AMG	142 162 200 205 B 938569 235 280	B 864307 B 864307	06.93 06.93 07.94	06.95 06.95 06.95		13.0460-4201.2 24.8190-0401.2 13.0460-0219.2	604201 620401 610219	2		21153 17,5 /WE Warnkontakt L=95mm Belagsatz-Zubehör	ATE ATE
	E 280 E 320 E 420	142 B 864308 162 B 864308 205	B 938568	06.93	06.95 06.95		13.0460-4202.2 24.8190-0401.2 13.0460-0268.2	604202 620401 610268	2		21153 16,0 /WE Warnkontakt L=95mm Belagsatz-Zubehör	ATE
	E 200 E 220 E 250 Turbo-D E 280 E 300 D E 300 Turbo-D	100 110 93 145 100 108		06.93 06.93 06.93 06.93 07.93 06.93	06.95 06.95 06.95 06.95 06.95 06.95		24.0122-0123.1 13.8190-0242.1	422123 990124	4		284 22,0 19,4 V L +S +B Halterschraube	
	E 200 D E 250 D	55 83		06.93 07.93	06.95 06.95		24.0112-0117.1	412117			284 12,0 10,0 +S +B	
	E 300 4-matic E 300 Turbo-D 4-matic	132 108		06.93 06.93	06.95 06.95		24.0122-0134.1 13.8190-0330.1	422134 990134	4		284 22,0 19,4 V L +B Halterschraube	
	E 280 E 320	142 162	B 864307 B 864307	06.93 06.93			24.0122-0136.1 13.8190-0242.1	422136 990124	4		295 22,0 19,4 V L +B Halterschraube	
	E 280 E 320 E 420	142 B 864308 162 B 864308 205	B 938568	06.93	06.95 06.95		24.0125-0107.1 13.8190-0242.1	425107 990124	4		294 25,0 22,4 V L +B Halterschraube	
	E 36 AMG E 420 E 500 E 60 AMG	200 205 B 938569 235 B 927761 280		07.94 06.95 06.95 05.94	06.95 06.95 06.95 06.95		24.0130-0121.1 24.0130-0122.1	430121 430122			320 30,0 28,0 V L +B 320 30,0 28,0 V L +B	
	E 500	235	B 927760	06.93			24.0128-0103.1	428103			300 28,0 25,4 V L +B	

MERCEDES BENZ E-Klasse (W124) Limousine (93-95)																	
	E 200	100		06.93	06.95	24.5101-0346.3	331406	2		L=346							
	E 200 D	55		06.93	06.95												
	E 220	110		06.93	06.95												
	E 250 D	83		07.93	06.95												
	E 250 Turbo-D	93		06.93	06.95												
	E 280	142		06.93	06.95												
	E 280	145		06.93	06.95												
	E 300 D	100		07.93	06.95												
	E 300 Turbo-D	108		06.93	06.95												
	E 320	162		06.93	06.95												
	E 36 AMG	200		07.94	06.95												
E 420	205		06.93	06.95													
E 500	235		06.93	06.95													
E 60 AMG	280		05.94	06.95													
E 300 4-matic	132		06.93	06.95	83.6154-0526.3	330285	2		L=525								
E 300 Turbo-D 4-matic	108		06.93	06.95													
	E 200	100		06.93	06.95	24.9235-8005.5	230023			D=35	ATE						
	E 200 D	55		06.93	06.95												
	E 220	110		06.93	06.95												
	E 250 D	83		07.93	06.95												
	E 250 Turbo-D	93		06.93	06.95												
	E 280	145		06.93	06.95												
	E 300 4-matic	132		06.93	06.95												
	E 300 D	100		07.93	06.95												
	E 300 Turbo-D	108		06.93	06.95												
	E 300 Turbo-D 4-matic	108		06.93	06.95												
	E 280	145		06.93	06.95							+ ASR	13.0441-3505.2	250051		Dichtungssatz	ATE
	E 320	162		06.93	06.95							24.9238-8035.5	230025			D=38	ATE
	E 36 AMG	200		07.94	06.95							24.9238-8036.5	230026			D=38	ATE
												13.0441-3817.2	250071			Dichtungssatz	ATE
	E 420	205		06.93	06.95							13.2381-8034.2	210223			D=38	ATE
E 500	235	B 927760	06.93	06.95	24.9238-8033.5	230015			D=38	ATE							
E 60 AMG	280	B 927760	05.94	06.95	24.9238-8034.5	230016			D=38	ATE							
					13.0441-3817.2	250071			Dichtungssatz	ATE							
E 500	235	B 927761	06.95	06.95	13.2421-8025.2	210061			D=42	ATE							
E 60 AMG	280	B 927761	06.95	06.95	13.2421-8026.2	210062			D=42	ATE							
					13.0441-4216.2	250093			Dichtungssatz	ATE							
	E 200	100		06.93	06.95	13.0460-4034.2	604034			20687 15,5	ATE						
	E 200 D	55		06.93	06.95												
	E 220	110		06.93	06.95												
	E 250 D	83		07.93	06.95												
	E 250 Turbo-D	93		06.93	06.95												
	E 280	145		06.93	06.95												
	E 300 4-matic	132		06.93	06.95												
	E 300 D	100		07.93	06.95												
	E 300 Turbo-D	108		06.93	06.95												
	E 300 Turbo-D 4-matic	108		06.93	06.95												
	E 280	145		06.93	06.95							+ ASR	13.0460-3504.2	603504		21301 15,5 /WE	ATE
												24.8190-0401.2	620401	4		Warnkontakt L=95mm	ATE
	E 280	142		06.93	06.95							13.0460-3805.2	603805			21197 15,0 /WE	ATE
	E 320	162		06.93	06.95							13.0470-3805.2	LD3805			21197 15,0 /WE	ATE
	E 36 AMG	200		07.94	06.95							24.8190-0401.2	620401	2		Warnkontakt L=95mm	ATE
E 420	205		06.93	06.95													
E 500	235	B 927760	06.93	06.95													
E 60 AMG	280	B 927760	05.94	06.95													
E 500	235	B 927761	06.95	06.95	13.0460-4047.2	604047			21305 15,7 /WE	ATE							
E 60 AMG	280	B 927761	06.95	06.95	13.0470-4047.2	LD4047			21305 15,7 /WE	ATE							
					13.0460-0236.2	610236			Belagsatz-Zubehör	ATE							
					24.8190-0401.2	620401	4		Warnkontakt L=95mm	ATE							
	E 200	100		06.93	06.95	24.0109-0120.1	409120			258 9,0 7,3 +S +B	PD						
	E 200 D	55		06.93	06.95												
	E 220	110		06.93	06.95												
	E 250 D	83		07.93	06.95												
	E 250 Turbo-D	93		06.93	06.95												
	E 280	145		06.93	06.95												
	E 300 4-matic	132		06.93	06.95												
	E 300 D	100		07.93	06.95												
	E 300 Turbo-D	108		06.93	06.95												
	E 300 Turbo-D 4-matic	108		06.93	06.95												
	E 280	142		06.93	06.95							24.0120-0199.1	420199			278 19,9 17,4 V L	
	E 320	162		06.93	06.95							24.0109-0114.1	409114			278 9,0 7,3 +S +B	
	E 36 AMG	200		07.94	06.95							24.0309-0114.1	509114			278 9,0 7,3 +S +B PD	
	E 420	205		06.93	06.95							24.0124-0188.1	424188			278 24,0 21,4 V L +B	
	E 500	235	B 927761	06.95	06.95							24.0122-0218.1	422218			300 22,0 19,4 V L +B	
E 60 AMG	280	B 927761	06.95	06.95													
	E 200	100		06.93	06.95	83.7704-0281.3	330804	2		L=280							
	E 200 D	55		06.93	06.95												
	E 220	110		06.93	06.95												
	E 250 D	83		07.93	06.95												
	E 250 Turbo-D	93		06.93	06.95												
	E 280	142		06.93	06.95												
	E 280	145		06.93	06.95												
	E 300 4-matic	132		06.93	06.95												
	E 300 D	100		07.93	06.95												
	E 300 Turbo-D	108		06.93	06.95												



MERCEDES BENZ E-Klasse (W124) Limousine (93-95)

	E 300 Turbo-D 4-matic E 320 E 36 AMG E 420 E 500 E 60 AMG	108 162 200 205 235 280		06.93 06.93 07.94 06.93 06.93 05.94	06.95 06.95 06.95 06.95 06.95 06.95	83.7704-0281.3	330804	2		L=280
	E 200 E 200 D E 220 E 250 D E 250 Turbo-D E 280 E 280 E 300 4-matic E 300 D E 300 Turbo-D E 300 Turbo-D 4-matic E 320 E 36 AMG E 420 E 500 E 60 AMG	100 55 110 83 93 142 145 132 100 108 108 162 200 205 235 280		06.93 06.93 06.93 07.93 06.93 06.93 06.93 06.93 07.93 06.93 06.93 06.93 07.94 06.93 06.93 05.94	06.95 06.95 06.95 06.95 06.95 06.95 06.95 06.95 06.95 06.95 06.95 06.95 06.95 06.95 06.95 06.95	03.0137-0170.2	650170			164 x 20 /Zub
	E 200 E 200 D E 220 E 250 D E 250 Turbo-D E 280 E 280 E 300 4-matic E 300 D E 300 Turbo-D E 300 Turbo-D 4-matic E 320 E 36 AMG E 420 E 500 E 60 AMG	◀100 ◀ 55 ◀110 ◀ 83 ◀ 93 ◀142 ◀145 ◀132 ◀100 ◀108 ◀108 ◀162 ◀200 ◀205 ◀235 ◀280		06.93 06.93 06.93 07.93 06.93 06.93 06.93 06.93 07.93 06.93 06.93 06.93 06.93 07.94 06.93 06.93 05.94	06.95 06.95 06.95 06.95 06.95 06.95 06.95 06.95 06.95 06.95 06.95 06.95 06.95 06.95 06.95 06.95 06.95	24.3727-0411.2 24.3727-0409.2	580411 580409	1 ⬆ 2 ⬇		L=2496 L=1060
	E 200 E 200 D E 220 E 250 D E 250 Turbo-D E 280 E 280 E 300 D E 320 E 36 AMG	100 55 110 83 93 142 145 100 162 200		06.93 06.93 06.93 07.93 06.93 06.93 06.93 07.93 06.93 07.94	06.95 06.95 06.95 06.95 06.95 06.95 06.95 06.95 06.95 06.95	24.2419-0915.3 24.2419-1703.3	030045 030097		+ GG ¹⁾ + ALU ²⁾	Gz 19,05 Gz 19,05
	E 200 E 200 D E 220 E 250 D E 250 Turbo-D E 280 E 280 E 300 D E 320 E 36 AMG	100 55 110 83 93 142 145 100 162 200		06.93 06.93 06.93 07.93 06.93 06.93 06.93 07.93 06.93 07.94	06.95 06.95 06.95 06.95 06.95 06.95 06.95 06.95 06.95 06.95	24.2523-1210.3 24.2523-1310.3 24.2523-1310.3	040105 040106 040106			Nz 23,81 Nz 23,81 Nz 23,81

MERCEDES BENZ E-Klasse (S124) Kombi (93-96)

	E 200 E 220 E 250 D E 250 Turbo D E 280 E 300 4-matic E 300 D E 300 TE-24 E 300 Turbo D E 300 Turbo D 4-matic E 320 E 36 AMG	100 110 83 93 145 132 100 162 108 108 162 200		06.93 06.93 06.93 06.93 06.93 06.93 06.93 06.93 06.93 06.93 06.93 05.94	06.96 06.96 06.96 06.96 06.96 06.96 06.96 06.96 06.96 06.96 06.96 06.96	03.7760-2702.4	300090			10" ATE
	E 200 E 220 E 250 D E 250 Turbo D E 280 E 300 4-matic E 300 D E 300 TE-24 E 300 Turbo D E 300 Turbo D 4-matic E 320 E 36 AMG	100 110 83 93 145 132 100 162 108 108 162 200	F 298225 F 298225 F 298225 F 298225 F 298225 F 298225 C 164263 C 164263 C 164263 F 298225 F 298225 F 298225	06.93 06.93 06.93 06.93 06.93 06.93 06.93 06.93 06.93 06.93 06.93 05.94	06.96 06.96 06.96 06.96 06.96 06.96 06.96 06.96 06.96 06.96 06.96 06.96	03.2023-0825.3	010028			THz 23,81/19,05 ATE

¹⁾ + cast iron / + ghisa / + fonte grise / + fundición de gris

²⁾ + aluminium / + alluminio / + aluminium / + aluminio

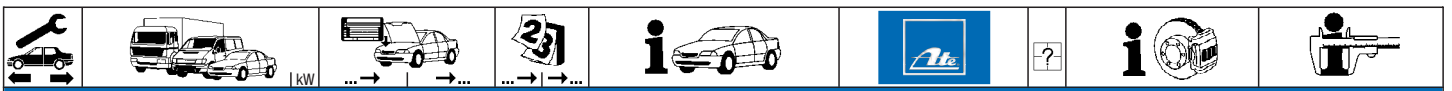

MERCEDES BENZ E-Klasse (S124) Kombi (93-96)

	E 200	100		06.93	06.96	24.3541-1603.5	240037		D=54, - Halter D=54, - Halter Bremsattel-Zubehör	TRW		
	E 220	110		06.93	06.96	24.3541-1604.5	240038			TRW		
	E 250 Turbo D	93		06.93	06.96	24.0101-3601.2	260044			TRW		
	E 280	145		06.93	06.96							
	E 300 D	100		06.93	06.96							
	E 300 Turbo D	108		06.93	06.96							
	E 250 D	83		06.93	06.96	24.3541-1725.5	240003				D=54, - Halter D=54, - Halter Dichtungssatz Faltenbalgssatz	TRW
					24.3541-1726.5	240004	TRW					
					11.0441-5404.2	250029	TRW					
					11.0101-5403.2	260010	TRW					
E 300 TE-24	162		06.93	06.96	13.0441-4214.2	250091		Dichtungssatz	ATE			
E 320	162	F 242721	06.93									
E 320	162	F 242722		06.96	13.0441-4214.2	250091			ATE			
	E 200	100		06.93	06.96	13.0460-2927.2	602927	2	20941 19,3 /WE/S 20941 19,3 /WE/S Warnkontakt L=68(150)mm	TRW		
	E 220	110		06.93	06.96	13.0470-2927.2	LD2927			TRW		
	E 250 D	83		06.93	06.96	24.8190-0402.2	620402					
	E 250 Turbo D	93		06.93	06.96							
	E 280	145		06.93	06.96							
	E 300 4-matic	132		06.93	06.96							
	E 300 D	100		06.93	06.96							
	E 300 Turbo D	108		06.93	06.96							
	E 300 Turbo D 4-matic	108		06.93	06.96							
	E 300 TE-24	162		06.93	06.96	13.0460-4201.2	604201			2	21153 17,5 /WE Warnkontakt L=95mm	ATE
E 320	162	F 242721	06.93		24.8190-0401.2	620401						
E 36 AMG	200		05.94	06.96								
E 320	162	F 242722		06.96	13.0460-4202.2	604202	2	21153 16,0 /WE Belagsatz-Zubehör Warnkontakt L=95mm	ATE			
					13.0460-0268.2	610268						
					24.8190-0401.2	620401						
	E 200	100		06.93	06.96	24.0122-0123.1	422123	4	284 22,0 19,4 V L +S +B Halterschraube			
	E 220	110		06.93	06.96	13.8190-0242.1	990124					
	E 250 Turbo D	93		06.93	06.96							
	E 280	145		06.93	06.96							
	E 300 D	100		06.93	06.96							
	E 300 Turbo D	108		06.93	06.96							
	E 250 D	83		06.93	06.96	24.0112-0117.1	412117			4	284 12,0 10,0 +S +B Halterschraube	
						13.8190-0242.1	990124					
	E 300 4-matic	132		06.93	06.96	24.0122-0134.1	422134			4	284 22,0 19,4 V L +B Halterschraube	
	E 300 Turbo D 4-matic	108		06.93	06.96	13.8190-0330.1	990134					
E 300 TE-24	162		06.93	06.96	24.0122-0136.1	422136	4	295 22,0 19,4 V L +B				
E 320	162	F 242721	06.93									
E 320	162	F 242722		06.96	24.0125-0107.1	425107			4	294 25,0 22,4 V L +B Halterschraube		
					13.8190-0242.1	990124						
E 36 AMG	200		05.94	06.96	24.0130-0121.1	430121	4	320 30,0 28,0 V L +B 320 30,0 28,0 V L +B Halterschraube				
					24.0130-0122.1	430122						
					13.8190-0242.1	990124						
	E 200	100		06.93	06.96	24.5101-0346.3	331406	2	L=346			
	E 220	110		06.93	06.96							
	E 250 D	83		06.93	06.96							
	E 250 Turbo D	93		06.93	06.96							
	E 280	145		06.93	06.96							
	E 300 D	100		06.93	06.96							
	E 300 TE-24	162		06.93	06.96							
	E 300 Turbo D	108		06.93	06.96							
	E 320	162		06.93	06.96							
	E 36 AMG	200		05.94	06.96							
	E 300 4-matic	132		06.93	06.96	83.6154-0526.3	330285			2	L=525	
E 300 Turbo D 4-matic	108		06.93	06.96								
	E 200	100		06.93	06.96	24.9238-8035.5	230025		D=38 D=38 Dichtungssatz	ATE		
	E 220	110		06.93	06.96	24.9238-8036.5	230026			ATE		
	E 250 D	83		06.93	06.96	13.0441-3817.2	250071			ATE		
	E 250 Turbo D	93		06.93	06.96							
	E 280	145		06.93	06.96							
	E 300 4-matic	132		06.93	06.96							
	E 300 D	100		06.93	06.96							
	E 300 Turbo D	108		06.93	06.96							
	E 300 Turbo D 4-matic	108		06.93	06.96							
	E 320	162	F 323056		06.96	13.0441-3606.2	250147				Dichtungssatz	ATE
E 36 AMG	200	F 323056		06.96								
	E 200	100		06.93	06.96	13.0460-3805.2	603805	2	21197 15,0 /WE 21197 15,0 /WE Belagsatz-Zubehör Warnkontakt L=95mm	ATE		
	E 220	110		06.93	06.96	13.0470-3805.2	LD3805			ATE		
	E 250 D	83		06.93	06.96	13.0460-0186.2	610186			ATE		
	E 250 Turbo D	93		06.93	06.96	24.8190-0401.2	620401					
	E 280	145		06.93	06.96							
	E 300 4-matic	132		06.93	06.96							
	E 300 D	100		06.93	06.96							
	E 300 TE-24	162		06.93	06.96							
	E 300 Turbo D	108		06.93	06.96							
	E 300 Turbo D 4-matic	108		06.93	06.96							
	E 320	162	F 323055	06.93								
	E 36 AMG	200	F 323055	05.94								
	E 320	162	F 323056		06.96	13.0460-4047.2	604047			2	21305 15,7 /WE 21305 15,7 /WE Warnkontakt L=95mm Belagsatz-Zubehör	ATE
E 36 AMG	200	F 323056		06.96	13.0470-4047.2	LD4047	ATE					
					24.8190-0401.2	620401	ATE					
					13.0460-0236.2	610236		ATE				





MERCEDES BENZ E-Klasse (S124) Kombi (93-96)

	E 200	100		06.93	06.96	24.0109-0114.1	409114			278 9,0 7,3 +S +B 278 9,0 7,3 +S +B PD
	E 220	110		06.93	06.96	24.0309-0114.1	509114			
	E 250 D	83		06.93	06.96					
	E 250 Turbo D	93		06.93	06.96					
	E 280	145		06.93	06.96					
	E 300 4-matic	132		06.93	06.96					
	E 300 D	100		06.93	06.96					
	E 300 Turbo D	108		06.93	06.96					
	E 300 Turbo D 4-matic	108		06.93	06.96					
	E 300 TE-24	162		06.93	06.96	24.0120-0199.1	420199			
E 320	162	F 323055	06.93	06.93						
E 36 AMG	200	F 323055	05.94							
	E 200	100		06.93	06.96	83.7704-0281.3	330804	2		L=280
	E 220	110		06.93	06.96					
	E 250 D	83		06.93	06.96					
	E 250 Turbo D	93		06.93	06.96					
	E 280	145		06.93	06.96					
	E 300 4-matic	132		06.93	06.96					
	E 300 D	100		06.93	06.96					
	E 300 TE-24	162		06.93	06.96					
	E 300 Turbo D	108		06.93	06.96					
	E 300 Turbo D 4-matic	108		06.93	06.96					
E 320	162		06.93	06.96						
E 36 AMG	200		05.94	06.96						
	E 200	100		06.93	06.96	03.0137-0170.2	650170			164 x 20 /Zub
	E 220	110		06.93	06.96					
	E 250 D	83		06.93	06.96					
	E 250 Turbo D	93		06.93	06.96					
	E 280	145		06.93	06.96					
	E 300 4-matic	132		06.93	06.96					
	E 300 D	100		06.93	06.96					
	E 300 TE-24	162		06.93	06.96					
	E 300 Turbo D	108		06.93	06.96					
	E 300 Turbo D 4-matic	108		06.93	06.96					
E 320	162		06.93	06.96						
E 36 AMG	200		05.94	06.96						
	E 200	100		06.93	06.96	24.3727-0411.2	580411	1 ↑		L=2496
	E 220	110		06.93	06.96	24.3727-0409.2	580409	2 ↓		L=1060
	E 250 D	83		06.93	06.96					
	E 250 Turbo D	93		06.93	06.96					
	E 280	145		06.93	06.96					
	E 300 4-matic	132		06.93	06.96					
	E 300 D	100		06.93	06.96					
	E 300 TE-24	162		06.93	06.96					
	E 300 Turbo D	108		06.93	06.96					
	E 300 Turbo D 4-matic	108		06.93	06.96					
E 320	162		06.93	06.96						
E 36 AMG	200		05.94	06.96						
	E 200	100		06.93	06.96	24.2419-0915.3	030045		+ GG ¹⁾	Gz 19,05
	E 220	110		06.93	06.96	24.2419-1703.3	030097		+ ALU ²⁾	Gz 19,05
	E 250 D	83		06.93	06.96					
	E 250 Turbo D	93		06.93	06.96					
	E 280	145		06.93	06.96					
	E 300 D	100		06.93	06.96					
	E 300 TE-24	162		06.93	06.96					
	E 320	162		06.93	06.96					
	E 36 AMG	200		05.94	06.96					
		E 200	100		06.93	06.96	24.2523-1310.3	040106		
E 220		110		06.93	06.96					
E 250 D		83		06.93	06.96					
E 250 Turbo D		93		06.93	06.96					
E 280		145		06.93	06.96					
E 300 D		100		06.93	06.96					
E 300 TE-24		162		06.93	06.96					
E 320		162		06.93	06.96					
E 36 AMG		200		05.94	06.96					

MERCEDES BENZ E-Klasse (C124) Coupe (93-97)

	E 200	100		06.93	06.97	03.7760-2702.4	300090			10"	ATE
	E 220	110		06.93	06.97						
	E 320	162		06.93	06.97						
	E 36 AMG	195		06.93	04.95						
	E 36 AMG	200		05.94	06.97						
	E 200	100	C 164263	06.93		03.2023-0825.3	010028			Thz 23,81/19,05	ATE
	E 220	110	C 164263	06.93							
	E 320	162	C 164263	06.93							
	E 36 AMG	195	C 164263	06.93							
	E 36 AMG	200	C 164263	05.94							
	E 200	100		06.93	06.97	24.3541-1603.5	240037	☐		D=54, - Halter	TRW
	E 220	110		06.93	06.97	24.3541-1604.5	240038	☐		D=54, - Halter	TRW
						24.0101-3601.2	260044			Bremssattel-Zubehör	TRW
	E 320	162	B 862121	06.93		13.0441-4214.2	250091			Dichtungssatz	ATE
	E 320	162	B 862122		06.97	13.0441-4214.2	250091			Dichtungssatz	ATE

¹⁾ + cast iron / + ghisa / + fonte grise / + fundición de gris

²⁾ + aluminium / + alluminio / + aluminium / + aluminio



MERCEDES BENZ E-Klasse (C124) Coupe (93-97)

	E 200	100		06.93	06.97	13.0460-2927.2	602927		20941 19,3 /WE/S	TRW
	E 220	110		06.93	06.97	13.0470-2927.2	LD2927		20941 19,3 /WE/S	TRW
	E 320	162	B 862121	06.93		13.0460-4201.2	604201	2	Warnkontakt L=68(150)mm	
	E 36 AMG	195		06.93	04.95	24.8190-0401.2	620401	2	Warnkontakt L=95mm	ATE
	E 36 AMG	200		05.94	06.97					
	E 320	162	B 862122		06.97	13.0460-4202.2	604202		21153 16,0 /WE	ATE
	E 200	100		06.93	06.97	24.0122-0123.1	422123		Warnkontakt L=95mm	
	E 220	110		06.93	06.97				284 22,0 19,4 V L +S +B	
	E 320	162	B 862121	06.93		24.0122-0136.1	422136		295 22,0 19,4 V L +B	
	E 320	162	B 862122		06.97	24.0125-0107.1	425107		294 25,0 22,4 V L +B	
	E 36 AMG	195		06.93	04.95	24.0130-0121.1	430121	☐	320 30,0 28,0 V L +B	
	E 36 AMG	200		05.94	06.97	24.0130-0122.1	430122	☐	320 30,0 28,0 V L +B	
	E 36 AMG	200		05.94	06.97	13.8190-0242.1	990124	4	Halterschraube	
	E 200	100		06.93	06.97	24.5101-0346.3	331406	2	L=346	
	E 220	110		06.93	06.97					
	E 320	162		06.93	06.97					
	E 36 AMG	195		06.93	04.95					
	E 36 AMG	200		05.94	06.97					
	E 200	100		06.93	06.97	24.9235-8005.5	230023	☐	D=35	ATE
	E 220	110		06.93	06.97	24.9235-8006.5	230024	☐	D=35	ATE
	E 220	110		06.93	06.97	13.0441-3505.2	250051		Dichtungssatz	ATE
	E 320	162		06.93	06.97	24.9238-8035.5	230025	☐	D=38	ATE
	E 36 AMG	195		06.93	04.95	24.9238-8036.5	230026	☐	D=38	ATE
	E 36 AMG	200		05.94	06.97	13.0441-3817.2	250071		Dichtungssatz	ATE
	E 200	100		06.93	06.97	13.0460-4034.2	604034		20687 15,5	ATE
	E 220	110		06.93	06.97	13.0460-0186.2	610186		Belagsatz-Zubehör	ATE
	E 320	162		06.93	06.97	13.0460-3805.2	603805		21197 15,0 /WE	ATE
	E 36 AMG	195		06.93	04.95	13.0470-3805.2	LD3805		21197 15,0 /WE	ATE
	E 36 AMG	200		05.94	06.97	24.8190-0401.2	620401	2	Warnkontakt L=95mm	
	E 200	100		06.93	06.97	13.0460-0186.2	610186		Belagsatz-Zubehör	ATE
	E 200	100		06.93	06.97	24.0109-0120.1	409120		258 9,0 7,3 +S +B	
	E 220	110		06.93	06.97	24.0309-0120.1	509120		258 9,0 7,3 +S +B PD	
	E 320	162		06.93	06.97	24.0109-0114.1	409114		278 9,0 7,3 +S +B	
	E 36 AMG	195		06.93	04.95	24.0309-0114.1	509114		278 9,0 7,3 +S +B PD	
	E 36 AMG	200		05.94	06.97					
	E 200	100		06.93	06.97	83.7704-0281.3	330804	2	L=280	
	E 220	110		06.93	06.97					
	E 320	162		06.93	06.97					
	E 36 AMG	195		06.93	04.95					
	E 36 AMG	200		05.94	06.97					
	E 200	100		06.93	06.97	03.0137-0170.2	650170		164 x 20 /Zub	
	E 220	110		06.93	06.97					
	E 320	162		06.93	06.97					
	E 36 AMG	195		06.93	04.95					
	E 36 AMG	200		05.94	06.97					
	E 200	100		06.93	06.97	24.3727-0409.2	580409	2	L=1060	
	E 220	110		06.93	06.97					
	E 320	162		06.93	06.97					
	E 36 AMG	195		06.93	04.95					
	E 36 AMG	200		05.94	06.97					
	E 200	100		06.93	06.97	24.2419-0915.3	030045	+ GG ¹⁾	Gz 19,05	
	E 220	110		06.93	06.97	24.2419-1703.3	030097	+ ALU ²⁾	Gz 19,05	
	E 320	162		06.93	06.97					
	E 36 AMG	195		06.93	04.95					
	E 36 AMG	200		05.94	06.97					
	E 200	100		06.93	06.97	24.2523-1210.3	040105		Nz 23,81	
	E 220	110		06.93	06.97	24.2523-1310.3	040106		Nz 23,81	
	E 320	162		06.93	06.97					
	E 36 AMG	195		06.93	04.95					
	E 36 AMG	200		05.94	06.97					

MERCEDES BENZ (W126) 260 SE-560 SEC (80-91)

	280 S			01.80	07.85	03.6855-1202.4	300056		9" Tandem	ATE
	280 SE			01.80	07.85					
	280 SEL			05.80	07.85					
	380 SE			01.80	08.85					
	380 SEC			06.81	07.85					
	380 SEL			05.80	07.85					
	500 SE			01.80	08.85					
	500 SEC			06.81	08.85					
	500 SEL			05.80	08.85					
	280 S		027696	01.80		03.2023-0166.3	010015		Thz 23,81/19,05	ATE
	280 SE		095332	01.80						
	280 SEL		095332	05.80						
	380 SE		048641	01.80						
	380 SEC		007911	06.81						
	380 SEL		048641	05.80						
	500 SE		036885	01.80						
	500 SEC		007817	06.81						
	500 SEL		036885	05.80						
	280 S	027697		07.85		03.2025-0111.3	010033		Thz 25,40/19,05	ATE

























¹⁾ + cast iron / + ghisa / + fonte grise / + fundición de gris

²⁾ + aluminium / + alluminio / + aluminium / + aluminio



MERCEDES BENZ (W126) 260 SE-560 SEC (80-91)

	280 SE 280 SEL 380 SE 380 SEC 380 SEL 500 SE 500 SEC 500 SEL	095333 095333 048642 007912 048642 036886 007818 036886		07.85 07.85 08.85 07.85 07.85 08.85 08.85 08.85		03.2025-0111.3	010033		THz 25,40/19,05	ATE
	260 SE 300 SE 300 SEL 420 SE 420 SEC 420 SEL 500 SE 500 SEC 500 SEL 560 SE 560 SEC 560 SEL			09.85 09.85 09.85 09.85 09.85 09.85 09.85 09.85 09.85 07.88 09.85 09.85	03.91 03.91 03.91 03.91 08.91 03.91 03.91 08.91 03.91 03.91 08.91 03.91	03.2025-0211.3	010034		THz 25,40/19,05	ATE
	280 S 280 SE 280 SEL 380 SE 380 SEL 500 SE 500 SEL			01.80 01.80 05.80 01.80 05.80 01.80 05.80	07.85 07.85 07.85 08.85 07.85 08.85 08.85	24.9260-8031.5 24.9260-8032.5 13.0441-6003.2	230045 230046 250128	<input type="checkbox"/> <input type="checkbox"/>	D=60 D=60 Dichtungssatz	ATE ATE ATE
	260 SE 300 SE 300 SEL 420 SE 420 SEC 420 SEL 500 SE 500 SEC 500 SEL 560 SE 560 SEC 560 SEL			09.85 09.85 09.85 09.85 09.85 09.85 09.85 09.85 09.85 07.88 09.85 09.85	03.91 03.91 03.91 03.91 08.91 03.91 03.91 08.91 03.91 03.91 08.91 03.91	13.2571-8023.2 13.2571-8024.2 13.0441-5724.2	210127 210128 250125	<input type="checkbox"/> <input type="checkbox"/>	D=57 D=57 Dichtungssatz	ATE ATE ATE
	280 S 280 SE 280 SEL 380 SE 380 SEL 500 SE 500 SEL			01.80 01.80 05.80 01.80 05.80 01.80 05.80	07.85 07.85 07.85 08.85 07.85 08.85 08.85	13.0460-9029.2 13.0460-0132.2 24.8190-0401.2	609029 610132 620401	4	20341 16,7 /WE Belagsatz-Zubehör Warnkontakt L=95mm	ATE ATE
	260 SE 300 SE 300 SEL 420 SE 420 SEC 420 SEL 500 SE 500 SEC 500 SEL 560 SE 560 SEC 560 SEL			09.85 09.85 09.85 09.85 09.85 09.85 09.85 09.85 09.85 07.88 09.85 09.85	03.91 03.91 03.91 03.91 08.91 03.91 03.91 08.91 03.91 03.91 08.91 03.91	13.0460-9029.2 13.0460-0197.2 24.8190-0401.2	609029 610197 620401	4	20341 16,7 /WE Belagsatz-Zubehör Warnkontakt L=95mm	ATE ATE
	280 S 280 SE 280 SEL 380 SE 380 SEL 500 SE 500 SEL			01.80 01.80 05.80 01.80 05.80 01.80 05.80	07.85 07.85 07.85 08.85 07.85 08.85 08.85	24.0122-0116.1	422116		278 22,0 19,4 V	
	260 SE 300 SE 300 SEL 420 SE 420 SEC 420 SEL 500 SE 500 SEC 500 SEL 560 SE 560 SEC 560 SEL			09.85 09.85 09.85 09.85 09.85 09.85 09.85 09.85 09.85 07.88 09.85 09.85	03.91 03.91 03.91 03.91 08.91 03.91 03.91 08.91 03.91 03.91 08.91 03.91	24.0128-0102.1	428102		300 28,0 25,4 V L +B	
	260 SE 280 S 280 SE 280 SEL 300 SE 300 SEL 380 SE 380 SEC 380 SEL			09.85 01.80 01.80 05.80 09.85 09.85 01.80 06.81 05.80	03.91 07.85 07.85 07.85 03.91 03.91 08.85 07.85 07.85	24.5101-0346.3	331406	2	L=346	

										
MERCEDES BENZ (W126) 260 SE-560 SEC (80-91)										
	420 SE 420 SEC 420 SEL 500 SE 500 SEC 500 SEL 560 SE 560 SEC 560 SEL			09.85 03.91 09.85 08.91 09.85 03.91 01.80 03.91 06.81 08.91 05.80 03.91 07.88 03.91 09.85 08.91 09.85 03.91		24.5101-0346.3	331406	2	L=346	
	260 SE 280 S 280 SE 280 SEL 300 SE 300 SEL 380 SE 380 SEC 380 SEL 420 SE 420 SEC 420 SEL			09.85 03.91 01.80 07.85 01.80 07.85 05.80 07.85 09.85 03.91 09.85 03.91 01.80 08.85 06.81 07.85 05.80 07.85 09.85 03.91 09.85 08.91 09.85 03.91		13.2381-8027.2 13.2381-8028.2 13.0441-3811.2	210033 210034 250067	 	D=38 D=38 Dichtungssatz	ATE ATE ATE
	500 SE 500 SEC 500 SEL 560 SE 560 SEC 560 SEL			01.80 03.91 06.81 08.91 05.80 03.91 07.88 03.91 09.85 08.91 09.85 03.91		13.2381-8029.2 13.2381-8030.2 13.0441-3811.2	210035 210036 250067	 	D=38 D=38 Dichtungssatz	ATE ATE ATE
	260 SE 280 S 280 SE 280 SEL 300 SE 300 SEL 380 SE 380 SEC 380 SEL 420 SE 420 SEC 420 SEL 500 SE 500 SEC 500 SEL 560 SE 560 SEC 560 SEL			09.85 03.91 01.80 07.85 01.80 07.85 05.80 07.85 09.85 03.91 09.85 03.91 01.80 08.85 06.81 07.85 05.80 07.85 09.85 03.91 09.85 08.91 09.85 03.91 01.80 03.91 06.81 08.91 05.80 03.91 07.88 03.91 09.85 08.91 09.85 03.91		13.0460-3804.2 13.0460-0029.2 13.0460-0912.2 24.8190-0401.2	603804 610029 610912 620401	- ASR 4 + ASR	21035 15,0 Belagsatz-Zubehör Belagsatz-Zubehör Warnkontakt L=95mm	ATE ATE BDX
	260 SE 280 S 280 SE 280 SEL 300 SE 300 SEL 380 SE 380 SEC 380 SEL 420 SE 420 SEC 420 SEL			09.85 03.91 01.80 07.85 01.80 07.85 05.80 07.85 09.85 03.91 09.85 03.91 01.80 08.85 06.81 07.85 05.80 07.85 09.85 03.91 09.85 08.91 09.85 03.91		24.0110-0185.1	410185		279 10,0 8,3 +S +B	
	500 SE 500 SEC 500 SEL 560 SE 560 SEC 560 SEL			01.80 03.91 06.81 08.91 05.80 03.91 07.88 03.91 09.85 08.91 09.85 03.91		24.0110-0185.1	410185		279 10,0 8,3 +S +B	
	260 SE 280 S 280 SE 280 SEL 300 SE 300 SEL 380 SE 380 SEC 380 SEL 420 SE 420 SEC 420 SEL			09.85 03.91 01.80 07.85 01.80 07.85 05.80 07.85 09.85 03.91 09.85 03.91 01.80 08.85 06.81 07.85 05.80 07.85 09.85 03.91 09.85 08.91 09.85 03.91		83.7704-0281.3	330804	2	L=280	
	500 SE 500 SEC 500 SEL 560 SE 560 SEC 560 SEL			01.80 03.91 06.81 08.91 05.80 03.91 07.88 03.91 09.85 08.91 09.85 03.91		83.6204-0280.3	330732	2	L=280	
	260 SE 280 S 280 SE 280 SEL 300 SE			09.85 03.91 01.80 07.85 01.80 07.85 05.80 07.85 09.85 03.91		03.0137-0171.2 03.0137-9002.2	650171 669002		160 x 25 /Zub Bremsbacken-Zubehör	
										



MERCEDES BENZ (W126) 260 SE-560 SEC (80-91)

	300 SEL 380 SE 380 SEC 380 SEL 420 SE 420 SEC 420 SEL 500 SE 500 SEC 500 SEL 560 SE 560 SEC 560 SEL				09.85 03.91 01.80 08.85 06.81 07.85 05.80 07.85 09.85 03.91 09.85 08.91 09.85 03.91 01.80 03.91 06.81 08.91 05.80 03.91 07.88 03.91 09.85 08.91 09.85 03.91		03.0137-0171.2 650171 03.0137-9002.2 669002			160 x 25 /Zub Bremsbacken-Zubehör
	260 SE 280 S 280 SE 280 SEL 300 SE 300 SEL 380 SE 380 SEC 380 SEL 420 SE 420 SEC 420 SEL				09.85 03.91 01.80 07.85 01.80 07.85 05.80 07.85 09.85 03.91 09.85 03.91 01.80 08.85 06.81 07.85 05.80 07.85 09.85 03.91 09.85 08.91 09.85 03.91		24.3727-0416.2 580416 24.3727-0417.2 580417	<input type="checkbox"/> <input type="checkbox"/>		L=1088 L=1108
	280 S 280 SE 280 SEL		049604 049604 049604		01.80 01.80 05.80		24.2419-0901.3 030041			Gz 19,05
	260 SE 280 S 280 SE 280 SEL 300 SE 300 SEL	049605 049605 049605			09.85 03.91 07.85 07.85 07.85 09.85 03.91 09.85 03.91		24.2419-0935.3 030061			Gz 19,05
	280 S 280 SE 280 SEL				01.80 07.85 01.80 07.85 05.80 07.85		03.2523-0811.3 040019 03.0450-2311.2 082311			Nz 23,81 Nz Reparatursatz
	260 SE 300 SE 300 SEL				09.85 03.91 09.85 03.91 09.85 03.91		24.2523-1210.3 040105			Nz 23,81

MERCEDES BENZ (W128) 220 SE (58-60)

	220 SE				01.58 12.60		03.3126-0505.3 010294			Hz 26,99	ATE
	220 SE				01.58 12.60		03.3508-3600.3 310030			Behälter	

MERCEDES BENZ (W180) 220 S/SE (56-59)

	220 S/SE				01.56 12.59		03.3126-0505.3 010294			Hz 26,99	ATE
	220 S/SE				01.56 12.59		03.3508-3600.3 310030			Behälter	
	220 S/SE				01.56 12.59		83.7704-0320.3 330851	2 <input type="checkbox"/>		L=320	
	220 S/SE				01.56 12.59		03.2728-2101.3 020008 03.2728-2201.3 020009 03.0402-1128.2 060027	<input type="checkbox"/> <input type="checkbox"/> <input type="checkbox"/>		Rz 28,57 Rz 28,57 Rz Reparatursatz	
	220 S/SE				01.56 12.59		83.6104-0210.3 330473 83.6204-0220.3 330308	<input type="checkbox"/> <input type="checkbox"/>		L=210 L=220	
	220 S/SE				01.56 12.59		03.3223-0102.3 020090			Rz 23,81	

MERCEDES BENZ (W201) 190-190 E 2,6 (82-93)

	190 E 2.3 16V ▶ 190 E 2.5 16V ▶ 190 E 2.6 ▶				07.84 08.88 09.88 05.93 04.86 05.93		03.7760-2702.4 300090			10"	ATE
	190 190 D 190 D 2.5 190 D 2.5 Turbo 190 E 1.8 190 E 2.0 190 E 2.3				04.82 02.90 09.83 05.93 05.85 05.93 11.87 05.93 03.90 05.93 04.82 05.93 09.83 05.93		24.2022-1601.3 010340			Thz 22,20/17,46	
	190 E 2.3 16V ◀ 190 E 2.5 16V ◀ 190 E 2.6 ◀				07.84 08.88 09.88 05.93 04.86 05.93		03.2023-0230.3 010019			Thz 23,81/19,05	ATE
	190 E 2.3 16V ▶ 190 E 2.5 16V ▶				07.84 08.88 09.88 05.93		03.2023-0825.3 010028			Thz 23,81/19,05	ATE

MERCEDES BENZ (W201) 190-190 E 2,6 (82-93)										
	190 E 2.6		04.86	05.93		03.2023-0825.3	010028		THz 23,81/19,05	ATE
	190 E 2.5 16V Evolut.	173	03.89	05.93		03.2025-0211.3	010034		THz 25,40/19,05	ATE
	190		04.82	02.90		24.3541-1631.5	240413		D=54, - Halter	TRW
	190 D		09.83	05.93		24.3541-1632.5	240414		D=54, - Halter	TRW
	190 D 2.2		09.83	09.85	+ USA	11.0441-5404.2	250029		Dichtungssatz	TRW
	190 D 2.5		05.85	05.93		11.0101-5403.2	260010		Faltenbalgssatz	TRW
	190 E 1.8		03.90	05.93						
	190 E 2.0		04.82	05.93						
	190 E 2.3 16V		07.84	08.88		24.3541-1603.5	240037		D=54, - Halter	TRW
	190 E 2.5 16V		09.88	05.93		24.3541-1604.5	240038		D=54, - Halter	TRW
						24.0101-3601.2	260044		Bremssattel-Zubehör	TRW
	190 E 2.5 16V Evolut.	173	F 723281	03.89		24.9442-8003.5	230053		D=42/38	ATE
						24.9442-8004.5	230054		D=42/38	ATE
						13.0441-4214.2	250091		Dichtungssatz	ATE
	190 E 2.5 16V Evolut.	173	F 723282	05.93		24.9442-8003.5	230053		D=42/38	ATE
						24.9442-8004.5	230054		D=42/38	ATE
	190		04.82	02.90		13.0460-2923.2	602923		21055 17,0 /WE/S	TRW
	190 D		09.83	05.93		24.8190-0402.2	620402	2	Warnkontakt L=68(150)mm	TRW
	190 D 2.2		09.83	09.85	+ USA					
	190 D 2.5		05.85	05.93						
	190 D 2.5 Turbo		11.87	05.93						
	190 E 1.8		03.90	05.93						
	190 E 2.0		04.82	05.93						
	190 E 2.3		09.83	05.93						
	190 E 2.6		04.86	05.93						
	190 E 2.3 16V		07.84	08.88		13.0460-2927.2	602927		20941 19,3 /WE/S	TRW
	190 E 2.5 16V		09.88	05.93		13.0470-2927.2	LD2927		20941 19,3 /WE/S	TRW
						24.8190-0402.2	620402	2	Warnkontakt L=68(150)mm	TRW
	190 E 2.5 16V Evolut.	173	03.89	05.93		13.0460-4201.2	604201		21153 17,5 /WE	ATE
						13.0460-0219.2	610219		Belagsatz-Zubehör	ATE
						24.8190-0401.2	620401	4	Warnkontakt L=95mm	ATE
	190		04.82	02.90		24.0111-0137.1	411137		262 11,0 9,0 +S +B	
	190 D		09.83	05.93		13.8190-0242.1	990124	4	Halterschraube	
	190 D 2.2		09.83	09.85	+ USA					
	190 D 2.5		05.85	05.93						
	190 E 1.8		03.90	05.93						
	190 E 2.0		04.82	05.93						
	190 D 2.5 Turbo		11.87	05.93		24.0122-0124.1	422124		262 22,0 19,4 V L +B	
	190 E 2.3		09.83	05.93		13.8190-0242.1	990124	4	Halterschraube	
	190 E 2.6		04.86	05.93						
	190 E 2.3 16V		07.84	08.88		24.0122-0123.1	422123		284 22,0 19,4 V L +S +B	
	190 E 2.5 16V		09.88	05.93		13.8190-0242.1	990124	4	Halterschraube	
	190 E 2.5 16V Evolut.	173	03.89	05.93		24.0128-0103.1	428103		300 28,0 25,4 V L +B	
						13.8190-0242.1	990124	4	Halterschraube	
						24.5101-0346.3	331406	2	- Ch. F723281	
	190		04.82	02.90					L=346	
	190 D		09.83	05.93						
	190 D 2.2		09.83	09.85	+ USA					
	190 D 2.5		05.85	05.93						
	190 D 2.5 Turbo		11.87	05.93						
	190 E 1.8		03.90	05.93						
	190 E 2.0		04.82	05.93						
	190 E 2.3		09.83	05.93						
	190 E 2.3 16V		07.84	08.88						
	190 E 2.5 16V		09.88	05.93						
	190 E 2.5 16V Evolut.	173	03.89	05.93						
	190 E 2.6		04.86	05.93						
	190		04.82	02.90		24.9235-8005.5	230023		D=35	ATE
	190 D		09.83	05.93		24.9235-8006.5	230024		D=35	ATE
	190 D 2.2		09.83	09.85	+ USA	13.0441-3505.2	250051		Dichtungssatz	ATE
	190 D 2.5		05.85	05.93						
	190 D 2.5 Turbo		11.87	05.93						
	190 E 1.8		03.90	05.93						
	190 E 2.0		04.82	05.93						
	190 E 2.3		09.83	05.93						
	190 E 2.3 16V		07.84	08.88						
	190 E 2.5 16V		09.88	05.93						
	190 E 2.6		04.86	05.93						
	190 E 2.5 16V Evolut.	173	03.89	05.93		24.9238-8035.5	230025		D=38	ATE
						24.9238-8036.5	230026		D=38	ATE
						13.0441-3817.2	250071		Dichtungssatz	ATE
	190		04.82	02.90		13.0460-4030.2	604030		20687 13,5	ATE
	190 D		09.83	05.93		13.0460-3504.2	603504	- ASR	21301 15,5 /WE	ATE
	190 D 2.2		09.83	09.85	+ USA	13.0460-0171.2	610171	+ ASR	Belagsatz-Zubehör	ATE
	190 D 2.5		05.85	05.93		24.8190-0401.2	620401	4 + ASR	Warnkontakt L=95mm	ATE
	190 D 2.5 Turbo		11.87	05.93						
	190 E 1.8		03.90	05.93						
	190 E 2.0		04.82	05.93						
	190 E 2.3		09.83	05.93						
	190 E 2.6		04.86	05.93						
	190 E 2.3 16V		07.84	08.88		13.0460-4034.2	604034		20687 15,5	ATE
	190 E 2.5 16V		09.88	05.93		13.0460-0186.2	610186		Belagsatz-Zubehör	ATE
	190 E 2.5 16V Evolut.	173	03.89	05.93		13.0460-3805.2	603805		21197 15,0 /WE	ATE
						13.0470-3805.2	LD3805		21197 15,0 /WE	ATE
						13.0460-0215.2	610215		Belagsatz-Zubehör	ATE



MERCEDES BENZ (W201) 190-190 E 2,6 (82-93)									
	190 190 D 190 D 2.2 190 D 2.5 190 D 2.5 Turbo 190 E 1.8 190 E 2.0 190 E 2.3 190 E 2.3 16V 190 E 2.5 16V 190 E 2.6			04.82 09.83 09.83 05.85 11.87 03.90 04.82 09.83 07.84 09.88 04.86	02.90 05.93 09.85 + USA 05.93 05.93 05.93 05.93 08.88 05.93 05.93	24.0109-0120.1	409120		258 9,0 7,3 +S +B
	190 E 2.5 16V Evolut.	173		03.89	05.93	24.0109-0103.1	409103		278 9,0 7,3 +B
	190 190 D 190 D 2.2 190 D 2.5 190 D 2.5 Turbo 190 E 1.8 190 E 2.0 190 E 2.3 190 E 2.3 16V 190 E 2.5 16V 190 E 2.5 16V Evolut. 190 E 2.6			04.82 09.83 09.83 05.85 11.87 03.90 04.82 09.83 07.84 09.88 03.89 04.86	02.90 05.93 09.85 + USA 05.93 05.93 05.93 05.93 08.88 05.93 05.93	83.7704-0281.3	330804	2	L=280
	190 190 D 190 D 2.2 190 D 2.5 190 D 2.5 Turbo 190 E 1.8 190 E 2.0 190 E 2.3 190 E 2.3 16V 190 E 2.5 16V 190 E 2.5 16V Evolut. 190 E 2.6			04.82 09.83 09.83 05.85 11.87 03.90 04.82 09.83 07.84 09.88 03.89 04.86	02.90 05.93 09.85 + USA 05.93 05.93 05.93 05.93 08.88 05.93 05.93	03.0137-0170.2	650170		164 x 20 /Zub
	190 190 D 190 D 2.2 190 D 2.5 190 D 2.5 Turbo 190 E 1.8 190 E 2.0 190 E 2.3 190 E 2.3 16V 190 E 2.5 16V 190 E 2.5 16V Evolut. 190 E 2.6			04.82 09.83 09.83 05.85 11.87 03.90 04.82 09.83 07.84 09.88 03.89 04.86	02.90 05.93 09.85 + USA 05.93 05.93 05.93 05.93 08.88 05.93 05.93	24.3727-0410.2 24.3727-0409.2	580410 580409	1 2	L=538 L=1060
	190 190 D 190 D 2.2 190 D 2.5 190 D 2.5 Turbo 190 E 1.8 190 E 2.0 190 E 2.3 190 E 2.3 16V 190 E 2.5 16V 190 E 2.5 16V Evolut. 190 E 2.6			04.82 09.83 09.83 05.85 11.87 03.90 04.82 09.83 07.84 09.88 03.89 04.86	02.90 05.93 09.85 + USA 05.93 05.93 05.93 05.93 08.88 05.93 05.93	24.2419-0915.3 24.2419-1703.3	030045 030097	+ GG ¹⁾ + ALU ²⁾	Gz 19,05 Gz 19,05
	190 190 D 190 D 2.2 190 D 2.5 190 D 2.5 Turbo 190 E 1.8 190 E 2.0 190 E 2.3 190 E 2.3 16V 190 E 2.5 16V 190 E 2.5 16V Evolut. 190 E 2.6			04.82 09.83 09.83 05.85 11.87 03.90 04.82 09.83 07.84 09.88 03.89 04.86	02.90 05.93 09.85 + USA 05.93 05.93 05.93 05.93 08.88 05.93 05.93	24.2523-1210.3	040105		Nz 23,81
	190 E 2.6	A508036	F640356	04.86	05.93				
	190 E 2.6	F640357	A508035	04.86	05.93				
	190 D 2.5 Turbo 190 E 2.6 190 E 2.6	A508036 F640357		11.87	05.93 05.93 05.93	24.2523-1310.3	040106		Nz 23,81
MERCEDES BENZ G-Klasse (W460) (79-93)									
	200 GE 230 G 230 GE 240 GD 250 GD 280 GE 300 GD	◀ ◀ 031805 ◀ 031805 ◀ 031805 ◀ ◀ 031805 ◀ 031805		05.86 08.85 07.93 07.93 08.87 07.93 07.93	+ - BM 460.299	03.6855-1402.4	300057		9" Tandem ATE
	230 G 230 GE	▶ 040098 ▶ 040098		08.85 07.93		03.6855-1902.4	300059		9" Tandem ATE

¹⁾ + cast iron / + ghisa / + fonte grise / + fundición de gris

²⁾ + aluminium / + alluminio / + aluminium / + aluminio



MERCEDES BENZ G-Klasse (W460) (79-93)

	240 GD 250 GD 280 GE 300 GD alle Typen	▶ ▶ ▶ ▶ ▶	040098 040098 040098 040098 035693		07.93 07.93 07.93 07.93 07.93 + GB		03.6855-1902.4	300059			9" Tandem	ATE	
	230 G 230 GE 240 GD 250 GD 280 GE 300 GD	◀ ◀ ◀ ◀ ◀ ◀		031804 031804 031804 031804 031804 031804	02.79 04.82 02.79 08.87 02.79 02.79			24.2123-0901.3	010382		Thz 23,81		
	200 GE 230 G 230 GE 240 GD 250 GD 280 GE 300 GD	◀ ◀ ◀ ◀ ◀ ◀ ◀		031805 031805 031805 031805 031805 031805	05.86 08.85 07.93 07.93 08.87 07.93 07.93			03.2125-1902.3	010206		Thz 25,40	ATE	
	230 G 230 GE 240 GD 250 GD 280 GE 300 GD alle Typen	▶ ▶ ▶ ▶ ▶ ▶ ▶	040098 040098 040098 040098 040098 040098 035693		07.93 08.85 07.93 07.93 07.93 07.93 07.93 + GB			03.2125-2102.3	010207		- ABS Thz 25,40	ATE	
	200 GE 230 G 230 GE 240 GD 250 GD 280 GE 300 GD				05.86 02.79 04.82 02.79 08.87 02.79 02.79	07.93 + I 08.85 07.93 07.93 07.93 07.93		13.4441-8015.2 13.4441-8016.2 13.9441-0041.2 13.9441-0042.2 13.0441-4408.2	210263 210264 210279 210280 250096	<input type="checkbox"/> + 2-Kreis-Bremse 1) <input type="checkbox"/> + 2-Kreis-Bremse 1) <input type="checkbox"/> + 1-Kreis-Bremse 2) <input type="checkbox"/> + 1-Kreis-Bremse 2)	D=44 D=44 D=44 D=44 Dichtungssatz	ATE ATE ATE ATE ATE	
	200 GE 230 G 230 GE 240 GD 250 GD 280 GE 300 GD				05.86 02.79 04.82 02.79 08.87 02.79 02.79	07.93 + I 08.85 07.93 07.93 07.93 07.93		13.0460-4401.2 13.0460-0158.2 24.8190-0401.2 24.8190-0406.2	604401 610158 620401 620406	4 2	VA: -H000247 3) VA: H000248- 4)	20784 18,0 / WE Belagsatz-Zubehör Warnkontakt L=95mm Warnkontakt L=261mm	ATE ATE
	200 GE 230 G 230 GE 240 GD 250 GD 280 GE 300 GD				05.86 02.79 04.82 02.79 08.87 02.79 02.79	07.93 + I 08.85 07.93 07.93 07.93 07.93		24.0116-0133.1	416133		303 16,0 13,0 +S +B		
	200 GE 230 G 230 GE 240 GD 250 GD 280 GE 300 GD			055306 055306 055306 055306 055306 055306	05.86 02.79 04.82 02.79 08.87 02.79 02.79	+ I		24.5224-0460.3	331264	4	L=460		
	200 GE 230 G 230 GE 240 GD 250 GD 280 GE 300 GD				05.86 02.79 04.82 02.79 08.87 02.79 02.79	07.93 + I 08.85 07.93 07.93 07.93 07.93			24.5165-0450.3	331259	2	L=450	
	200 GE 230 G 230 GE 240 GD 250 GD 280 GE 300 GD				05.86 02.79 04.82 02.79 08.87 02.79 02.79	07.93 + I 08.85 07.93 07.93 07.93 07.93			24.3217-1109.3	020173		Rz 17,46	
	200 GE 230 G 230 GE 240 GD 250 GD 280 GE 300 GD				05.86 02.79 04.82 02.79 08.87 02.79 02.79	07.93 + I 08.85 07.93 07.93 07.93 07.93			24.0226-0001.1	480050		260/261,5 x 64	
	200 GE 230 G 230 GE 240 GD 250 GD 280 GE 300 GD				05.86 02.79 04.82 02.79 08.87 02.79 02.79	07.93 + I 08.85 07.93 07.93 07.93 07.93			03.6513-0340.3	320084		BRL 1/3 (2)	ATE
	200 GE 230 G 230 GE 240 GD	◀ ◀ ◀ ◀			05.86 02.79 04.82 02.79	07.93 + I 08.85 07.93 07.93			24.2419-0942.3	030068		Gz 19,05	

1) + two circuit brake / + impianto frenante doppio circuito / + frein à deux circuits / + freno de 2 circuitos

2) + single circuit brake / + impianto freni circuito singolo / + frein à 1 circuit / + freno de 1 circuito

3) FA: -H000247 / A: -H000247 / ess. AV: -H000247 / ED: -H000247

4) FA: H000248- / A: H000248- / ess. AV: H000248- / ED: H000248-





MERCEDES BENZ G-Klasse (W460) (79-93)

	250 GD 280 GE 300 GD	◀ ◀ ◀	08.87 02.79 02.79	07.93 07.93 07.93	24.2419-0942.3	030068		Gz 19,05
	230 G 240 GD 300 GD		02.79 02.79 02.79	08.85 07.93 07.93	03.2523-0812.3 03.0450-2311.2	040020 082311		Nz 23,81 Nz Reparatursatz
	230 GE 250 GD		04.82 08.87	07.93 07.93	24.2523-1210.3	040105		Nz 23,81
	280 GE		02.79	07.93	24.5901-0225.3	331288		L=225

MERCEDES BENZ G-Klasse (W461) (90-)

	230 GE 250 GD 290 GD G 270 CDI G 290 TD G 320 CDI G 350 CDI	◀ ◀ ◀ ◀115 ◀ ◀135 ◀135	02.93 02.90 04.92 01.03 07.97 02.09 04.10		03.6855-1402.4	300057		9" Tandem	ATE
	230 GE 250 GD 290 GD G 270 CDI G 290 TD	▶ ▶ ▶ ▶115 ▶	02.93 02.90 04.92 01.03 07.97		03.6855-1902.4	300059		9" Tandem	ATE
	230 GE 250 GD 290 GD G 270 CDI G 290 TD		02.93 02.90 04.92 01.03 07.97		03.2125-2102.3	010207		THz 25,40	ATE
	230 GE 250 GD 290 GD G 270 CDI G 290 TD		02.93 02.90 04.92 01.03 07.97		13.9441-0041.2 13.9441-0042.2 13.0441-4408.2	210279 210280 250096	<input type="checkbox"/> <input type="checkbox"/>	D=44 D=44 Dichtungssatz	ATE ATE ATE
	230 GE 250 GD 290 GD G 270 CDI G 290 TD		02.93 02.90 04.92 01.03 07.97		13.0460-4401.2 13.0460-0158.2 24.8190-0406.2	604401 610158 620406	2	20784 18,0 /WE Belagsatz-Zubehör Warnkontakt L=261mm	ATE ATE
	G 320 CDI G 350 CDI	135 135	02.09 04.10		13.0460-4401.2 24.8190-0406.2	604401 620406	2	20784 18,0 /WE Warnkontakt L=261mm	ATE
	230 GE 250 GD 290 GD G 270 CDI G 290 TD		02.93 02.90 04.92 01.03 07.97		24.0116-0133.1	416133		303 16,0 13,0 +S +B	
	G 320 CDI G 350 CDI	135 135	02.09 04.10		24.0116-0133.1 24.0130-0217.1	416133 430217		303 16,0 13,0 +S +B 315 30,0 27,4 V L +S +B	
	230 GE 250 GD 290 GD G 290 TD		02.93 02.90 04.92 07.97		24.5224-0460.3	331264	2	L=460	
	G 270 CDI G 290 TD G 320 CDI	115 135	01.03 07.97 02.09		13.0460-3990.2 24.8190-0407.2	603990 620407	2	23021 18,9 /WE Warnkontakt L=84(185)mm	BOS
	G 270 CDI G 290 TD G 320 CDI	115 135	01.03 07.97 02.09		24.0116-0110.1	416110		272 16,0 14,0 L +S +B	
	230 GE 250 GD 290 GD G 270 CDI G 290 TD G 320 CDI G 350 CDI		02.93 02.90 04.92 01.03 07.97 02.09 04.10		83.6104-0220.3	330474	2	L=220	
	230 GE 250 GD 290 GD G 290 TD		02.93 02.90 04.92 07.97		24.3217-1109.3	020173		Rz 17,46	
	G 350 CDI	135	04.10		24.3217-1109.3 24.3222-1732.3	020173 020537		D=17,46 D=22,2	Rz 17,46 Rz 22,20
	230 GE 250 GD 290 GD G 290 TD		02.93 02.90 04.92 07.97		24.0226-0001.1	480050		260/261,5 x 64	
	G 270 CDI G 320 CDI	115 135	01.03 02.09		03.0137-4001.2	654001		160 x 40 /Zub	
	G 270 CDI	115	01.03		24.3727-0476.2 24.3727-0477.2	580476 580477	<input type="checkbox"/> <input type="checkbox"/>	L=2230 L=2374	



MERCEDES BENZ G-Klasse (W461) (90-)

















	G 320 CDI G 350 CDI	135 135		02.09 04.10		24.3727-0477.2 24.3727-0476.2	580477 580476	<input type="checkbox"/> - erhöhte Zuladung ¹⁾ <input type="checkbox"/> - erhöhte Zuladung ¹⁾	L=2374 L=2230	
	230 GE 250 GD 290 GD G 290 TD			02.93 02.90 04.92 07.97		03.6513-0340.3	320084		BRL 1/3 (2)	ATE
	G 270 CDI G 320 CDI	115 135		01.03 02.09		03.6515-0305.3	320087		BRL 1/5 (2)	ATE
	230 GE 250 GD 290 GD G 290 TD			02.93 02.90 04.92 07.97		24.2419-0942.3	030068		Gz 19,05	
	230 GE			02.93		03.2523-0812.3 03.0450-2311.2	040020 082311		Nz 23,81 Nz Reparatursatz	
	250 GD 290 GD G 290 TD			02.90 04.92 07.97		24.2523-1210.3	040105		Nz 23,81	

MERCEDES BENZ S-Klasse (W140) (91-93)

	300 SE 2.8 / S 280 300 SE 3.2 300 SEL 3.2 350 SD Turbo			08.92 04.91 04.91 03.93	06.93 06.93 06.93 06.93	03.2025-0211.3	010034		Thz 25,40/19,05	ATE
	400 SE 400 SEL 500 SE 500 SEC 500 SEL 600 SE V12 600 SEC V12 600 SEL V12	◀ A110607 ◀ A110607 ◀ A110607 ◀ A110607 ◀ A110607 ◀ A110607 ◀ A110607 ◀ A110607		06.93 06.93 06.93 06.93 06.93 06.93 06.93 06.93		03.2026-0462.3	010728		Thz 26,99/25,40	ATE
	400 SE 400 SEL 500 SE 500 SEC 500 SEL 600 SE V12 600 SEC V12 600 SEL V12	▶ A110607 ▶ A110607 ▶ A110607 ▶ A110607 ▶ A110607 ▶ A110607 ▶ A110607 ▶ A110607		06.93 06.93 06.93 06.93 06.93 06.93 06.93 06.93		03.2026-0512.3	010038		Thz 26,99/25,40	ATE
	300 SE 3.2 300 SE 3.2 300 SEL 3.2 300 SEL 3.2		A050547 A023718 A050547 A023718	04.91 04.91 04.91 04.91	+ Leichtmetallfelgen ²⁾ - Leichtmetallfelgen ³⁾ + Leichtmetallfelgen ²⁾ - Leichtmetallfelgen ³⁾	24.9571-7005.5 24.9571-7006.5	230061 230062	<input type="checkbox"/> <input type="checkbox"/>	D=57 D=57	ATE ATE
	300 SE 3.2 300 SE 3.2 300 SEL 3.2 300 SEL 3.2		A050547 A023718 A050547 A023718	04.91 04.91 04.91 04.91	+ Leichtmetallfelgen ²⁾ - Leichtmetallfelgen ³⁾ + Leichtmetallfelgen ²⁾ - Leichtmetallfelgen ³⁾	13.0460-6036.2 24.8190-0401.2	606036 620401	4	21304 18,5 /WE Warnkontakt L=95mm	ATE
	300 SE 2.8 / S 280 300 SE 3.2 300 SE 3.2 300 SEL 3.2 300 SEL 3.2 350 SD Turbo 400 SE 400 SEL 500 SE 500 SEC 500 SEL 600 SE V12 600 SEC V12 600 SEL V12	A023719 A050548 A023719 A050548		08.92 06.93 06.93 06.93 06.93 03.93 04.91 04.91 04.91 06.92 04.91 04.91 06.92 04.91 06.93	06.93 - Leichtmetallfelgen ³⁾ + Leichtmetallfelgen ²⁾ - Leichtmetallfelgen ³⁾ + Leichtmetallfelgen ²⁾ 06.93 06.93 06.93 06.93 06.92 06.93 06.93 06.92 06.93 06.93	13.0460-9033.2 13.0460-0263.2 24.8190-0401.2	609033 610263 620401	4	21303 18,9 /WE Belagsatz-Zubehör Warnkontakt L=95mm	ATE
	300 SE 3.2 300 SE 3.2 300 SEL 3.2 300 SEL 3.2		A050547 A023718 A050547 A023718	04.91 04.91 04.91 04.91	+ Leichtmetallfelgen ²⁾ - Leichtmetallfelgen ³⁾ + Leichtmetallfelgen ²⁾ - Leichtmetallfelgen ³⁾	24.0128-0127.1	428127		310 28,0 25,4 V L +B	
	300 SE 2.8 / S 280 300 SE 3.2 300 SE 3.2 300 SEL 3.2 300 SEL 3.2 350 SD Turbo 400 SE 400 SEL 500 SE 500 SEC 500 SEL 600 SE V12 600 SEC V12 600 SEL V12	A023719 A050548 A023719 A050548		08.92 06.93 06.93 06.93 06.93 03.93 04.91 04.91 04.91 06.92 04.91 04.91 06.92 04.91 06.93	06.93 - Leichtmetallfelgen ³⁾ + Leichtmetallfelgen ²⁾ - Leichtmetallfelgen ³⁾ + Leichtmetallfelgen ²⁾ 06.93 06.93 06.93 06.93 06.92 06.93 06.93 06.92 06.93 06.93	24.0130-0100.1	430100		320 30,0 27,4 V L +B	
	300 SE 2.8 / S 280 300 SE 3.2 300 SEL 3.2 350 SD Turbo 400 SE			08.92 04.91 04.91 03.93 04.91	06.93 06.93 06.93 06.93 06.93	24.5113-0540.3	331301	2	L=540	

1) - increased payload / - carico utile maggiorato / - charge utile augmentée / - incremento de carga
 2) + light alloy rims / + cerchi in lega / + jantes en alliage léger / + Llantas de aleación ligera
 3) - light alloy rims / - cerchi in lega / - jantes en alliage léger / - Llantas de aleación ligera



											
MERCEDES BENZ S-Klasse (W140) (91-93)											
	400 SEL 500 SE 500 SEC 500 SEL 600 SE V12 600 SEC V12 600 SEL V12			04.91 06.93 04.91 06.93 06.92 06.93 04.91 06.93 04.91 06.93 06.92 06.93 04.91 06.93		24.5113-0540.3	331301	2	L=540		
	300 SE 2.8 / S 280 300 SE 3.2 300 SEL 3.2 350 SD Turbo			08.92 06.93 04.91 06.93 04.91 06.93 03.93 06.93		13.2401-8013.2 13.2401-8014.2 24.9240-8013.5 24.9240-8014.5 13.0441-4020.2	210051 210052 230019 230020 250084	<input type="checkbox"/> <input type="checkbox"/> <input type="checkbox"/> <input type="checkbox"/>	D=40 D=40 D=40 D=40 Dichtungssatz	ATE ATE ATE ATE ATE	
	400 SE 400 SEL 500 SE 500 SEC 500 SEL 600 SE V12 600 SEC V12 600 SEL V12			04.91 06.93 04.91 06.93 04.91 06.93 06.92 06.93 04.91 06.93 04.91 06.93 06.92 06.93 04.91 06.93		24.9246-8001.5 24.9246-8002.5 13.0441-4601.2	230021 230022 250099	<input type="checkbox"/> <input type="checkbox"/>	D=46 D=46 Dichtungssatz	ATE ATE ATE	
	300 SE 2.8 / S 280 300 SE 3.2 300 SEL 3.2 350 SD Turbo			08.92 06.93 04.91 06.93 04.91 06.93 03.93 06.93		13.0460-4047.2 13.0470-4047.2 13.0460-0239.2 24.8190-0401.2	604047 LD4047 610239 620401	4 4	+ ASR + ASR	21305 15,7 /WE 21305 15,7 /WE Belagsatz-Zubehör Warnkontakt L=95mm 21305 15,7 /WE 21305 15,7 /WE Belagsatz-Zubehör Warnkontakt L=95mm	ATE ATE ATE ATE ATE ATE ATE
	400 SE 400 SEL 500 SE 500 SEC 500 SEL 600 SE V12 600 SEC V12 600 SEL V12			04.91 06.93 04.91 06.93 04.91 06.93 06.92 06.93 04.91 06.93 06.92 06.93 04.91 06.93		13.0460-4047.2 13.0470-4047.2 13.0460-0236.2 24.8190-0401.2	604047 LD4047 610236 620401	4	+ ASR		
	300 SE 2.8 / S 280 300 SE 3.2 300 SEL 3.2 350 SD Turbo			08.92 06.93 04.91 06.93 04.91 06.93 03.93 06.93		24.0112-0129.1	412129			290 12,0 9,8 L +B	
	400 SE 400 SEL 500 SE 500 SEC 500 SEL 600 SE V12 600 SEC V12 600 SEL V12			04.91 06.93 04.91 06.93 04.91 06.93 06.92 06.93 04.91 06.93 06.92 06.93 04.91 06.93		24.0122-0133.1	422133			300 22,0 19,4 V L +B	
	300 SE 2.8 / S 280 300 SE 3.2 300 SEL 3.2 350 SD Turbo 400 SE 400 SEL 500 SE 500 SEC 500 SEL 600 SE V12 600 SEC V12 600 SEL V12			08.92 06.93 04.91 06.93 04.91 06.93 03.93 06.93 04.91 06.93 04.91 06.93 04.91 06.93 06.92 06.93 04.91 06.93 04.91 06.93 06.92 06.93 04.91 06.93		83.7704-0281.3	330804	2		L=280	
	300 SE 2.8 / S 280 300 SE 3.2 300 SEL 3.2 350 SD Turbo 400 SE 400 SEL 500 SE 500 SEC 500 SEL 600 SE V12 600 SEC V12 600 SEL V12			08.92 06.93 04.91 06.93 04.91 06.93 03.93 06.93 04.91 06.93 04.91 06.93 04.91 06.93 06.92 06.93 04.91 06.93 04.91 06.93 06.92 06.93 04.91 06.93		03.0137-0244.2	650244			164 x 25 /Zub	
	300 SE 2.8 / S 280 300 SE 3.2 350 SD Turbo 400 SE 500 SE 500 SEC 600 SE V12 600 SEC V12	◀		08.92 06.93 04.91 06.93 03.93 06.93 04.91 06.93 04.91 06.93 06.92 06.93 04.91 06.93 06.92 06.93		24.3727-0462.2 24.3727-0456.2 24.3727-0455.2	580462 580456 580455	1	<input type="checkbox"/> <input type="checkbox"/> <input type="checkbox"/>	L=2622 L=1134 L=1109	
	300 SEL 3.2 400 SEL 500 SEL 600 SEL V12	◀		04.91 06.93 04.91 06.93 04.91 06.93 04.91 06.93		24.3727-0456.2 24.3727-0455.2	580456 580455		<input type="checkbox"/> <input type="checkbox"/>	L=1134 L=1109	
	300 SE 2.8 / S 280 300 SE 3.2 350 SD Turbo 400 SE 500 SE 500 SEC	▶		08.92 06.93 04.91 06.93 03.93 06.93 04.91 06.93 04.91 06.93 06.92 06.93		24.3727-0456.2 24.3727-0455.2	580456 580455		<input type="checkbox"/> <input type="checkbox"/>	L=1134 L=1109	

MERCEDES BENZ S-Klasse (W140) (91-93)									
	600 SE V12 600 SEC V12		04.91 06.92	06.93 06.93		24.3727-0456.2 24.3727-0455.2	580456 580455	<input type="checkbox"/> <input checked="" type="checkbox"/>	L=1134 L=1109
	300 SEL 3.2 400 SEL 500 SEL 600 SEL V12		04.91 04.91 04.91 04.91	06.93 06.93 06.93 06.93		24.3727-0456.2 24.3727-0455.2	580456 580455	<input type="checkbox"/> <input type="checkbox"/> <input type="checkbox"/> <input type="checkbox"/>	L=1134 L=1109
	300 SE 2.8 / S 280 300 SE 3.2 300 SEL 3.2		08.92 04.91 04.91	06.93 06.93 06.93		24.2419-0915.3 24.2419-1703.3	030045 030097	+ GG ¹⁾ + ALU ²⁾	Gz 19,05 Gz 19,05
	300 SE 2.8 / S 280 300 SE 3.2 300 SEL 3.2		08.92 04.91 04.91	06.93 06.93 06.93		24.2523-1310.3	040106		Nz 23,81
MERCEDES BENZ Transporter (BM 601) 207 D-210 D									
	207 D 207 D 208 208 208 D 208 D 209 D 209 D 210 210 210 D 210 D		649390 614796 649390 614796 649390 614796 649390 614796 649390 614796 649390 614796	05.77 05.77 05.77 05.77 09.88 09.88 05.77 05.77 05.77 05.77 09.88 09.88	- Kombiwagen ³⁾ + Kombiwagen ⁴⁾ - Kombiwagen ³⁾ + Kombiwagen ⁴⁾ - Kombiwagen ³⁾ + Kombiwagen ⁴⁾ - Kombiwagen ³⁾ + Kombiwagen ⁴⁾ - Kombiwagen ³⁾ + Kombiwagen ⁴⁾ - Kombiwagen ³⁾ + Kombiwagen ⁴⁾ - Kombiwagen ³⁾ + Kombiwagen ⁴⁾	03.6850-2602.4	300049		9" ATE
	207 D 207 D 208 208 208 D 208 D 209 D 209 D 210 210 210 D 210 D	649391 614797 649391 614797 649391 614797 649391 614797 649391 614797 649391 614797			- Kombiwagen ³⁾ + Kombiwagen ⁴⁾ - Kombiwagen ³⁾ + Kombiwagen ⁴⁾ - Kombiwagen ³⁾ + Kombiwagen ⁴⁾ - Kombiwagen ³⁾ + Kombiwagen ⁴⁾ - Kombiwagen ³⁾ + Kombiwagen ⁴⁾ - Kombiwagen ³⁾ + Kombiwagen ⁴⁾ - Kombiwagen ³⁾ + Kombiwagen ⁴⁾	03.6855-1402.4	300057		9" Tandem ATE
	207 D 207 D 208 208 208 D 208 D 209 D 209 D 210 210 210 D 210 D	649390 / P000000 614796 / P000000 649390 / P000000 614796 / P000000 649390 / P000000 614796 / P000000 649390 / P000000 614796 / P000000 649390 / P000000 614796 / P000000 649390 / P000000 614796 / P000000	05.77 05.77 05.77 05.77 09.88 09.88 05.77 05.77 05.77 05.77 09.88 09.88	- Kombiwagen ³⁾ + Kombiwagen ⁴⁾ - Kombiwagen ³⁾ + Kombiwagen ⁴⁾ - Kombiwagen ³⁾ + Kombiwagen ⁴⁾ - Kombiwagen ³⁾ + Kombiwagen ⁴⁾ - Kombiwagen ³⁾ + Kombiwagen ⁴⁾ - Kombiwagen ³⁾ + Kombiwagen ⁴⁾	03.2123-6002.3	010184		Thz 23,81 ATE	
	207 D 207 D 208 208 208 D 208 D 209 D 209 D 210 210 210 D 210 D	649391 / P000001 614797 / P000001 649391 / P000001 614797 / P000001 649391 / P000001 614797 / P000001 649391 / P000001 614797 / P000001 649391 / P000001 614797 / P000001 649391 / P000001 614797 / P000001			- Kombiwagen ³⁾ + Kombiwagen ⁴⁾ - Kombiwagen ³⁾ + Kombiwagen ⁴⁾ - Kombiwagen ³⁾ + Kombiwagen ⁴⁾ - Kombiwagen ³⁾ + Kombiwagen ⁴⁾ - Kombiwagen ³⁾ + Kombiwagen ⁴⁾ - Kombiwagen ³⁾ + Kombiwagen ⁴⁾	03.2125-1902.3	010206	- ABS	Thz 25,40 ATE
	207 D 208 208 D 209 D 210 210 D		05.77 05.77 09.88 05.77 05.77 09.88	+ 1-Kreis-Sättel ⁵⁾ + 1-Kreis-Sättel ⁵⁾ + 1-Kreis-Sättel ⁵⁾ + 1-Kreis-Sättel ⁵⁾ + 1-Kreis-Sättel ⁵⁾ + 1-Kreis-Sättel ⁵⁾	13.4441-8013.2 13.4441-8014.2 13.0441-4408.2	210261 210262 250096	<input type="checkbox"/> <input type="checkbox"/> <input type="checkbox"/>	D=44 D=44 Dichtungssatz ATE ATE ATE	
	207 D 208 208 D 209 D 210 210 D		05.77 05.77 09.88 05.77 05.77 09.88	+ 2-Kreis-Sättel ⁶⁾ + 2-Kreis-Sättel ⁶⁾ + 2-Kreis-Sättel ⁶⁾ + 2-Kreis-Sättel ⁶⁾ + 2-Kreis-Sättel ⁶⁾ + 2-Kreis-Sättel ⁶⁾	13.4441-8015.2 13.4441-8016.2 13.0441-4408.2	210263 210264 250096	<input type="checkbox"/> <input type="checkbox"/> <input type="checkbox"/>	D=44 D=44 Dichtungssatz ATE ATE ATE	
	207 D 208 208 D 209 D 210 210 D		05.77 05.77 09.88 05.77 05.77 09.88			13.0460-4401.2 13.0460-0158.2 24.8190-0401.2	604401 610158 620401	4	20784 18,0 / WE Belagsatz-Zubehör Warnkontakt L=95mm ATE ATE
	207 D 208 208 D 209 D 210 210 D		05.77 05.77 09.88 05.77 05.77 09.88			24.0116-0100.1	416100		280 16,0 13,0 +B

¹⁾ + cast iron / + ghisa / + fonte grise / + fundición de gris

²⁾ + aluminium / + alluminio / + aluminium / + aluminio

³⁾ - estate / - Station Wagon / - break / - break

⁴⁾ + Estate / + Station Wagon / + Break / + Break

⁵⁾ + single circuit caliper / + pinza a circuito singolo / + étriers frein à 1 circuit / + pinza de 1 circuito

⁶⁾ + two circuit caliper / + pinza freno a 2 circuiti / + étriers frein à 2 circuits / + pinza de 2 circuitos



MERCEDES BENZ Transporter (BM 601) 207 D-210 D

	207 D 208 208 D 209 D 210 210 D			05.77 05.77 09.88 05.77 05.77 09.88			24.5201-0474.3	331434	2		L=474	
	207 D 208 208 D 209 D 210 210 D			05.77 05.77 09.88 05.77 05.77 09.88			24.5170-0426.3	331452	2		L=426	
	207 D 208 208 D 209 D 210 210 D			05.77 05.77 09.88 05.77 05.77 09.88			24.3215-0902.3	020153			Rz 15,87	
	207 D 208 208 D 209 D 210 210 D			05.77 05.77 09.88 05.77 05.77 09.88			24.0223-0009.1	480039			230/231 x 43	
	207 D 208 208 D 209 D 210 210 D			05.77 05.77 09.88 05.77 05.77 09.88			24.3727-0420.2 24.3727-0459.2 24.3727-0460.2	580420 580459 580460	2 □ □		L=1798 L=1845 L=1845	
	208 210		649390 649390	05.77 05.77	- Kombiwagen ¹⁾ - Kombiwagen ¹⁾		03.6511-0030.3	320076			BRL 1/1 (2)	ATE
	208 210	649391 649391			- Kombiwagen ¹⁾ - Kombiwagen ¹⁾		03.6515-0305.3	320087			BRL 1/5 (2)	ATE
	208 208 210 210	500000 240106 500000 240106	556499 240106 556499 240106	05.77 05.77	+ Kombiwagen BM 601.071/.072 ²⁾ + Kombiwagen BM 601.071/.072 ²⁾ + Kombiwagen BM 601.071/.072 ²⁾ + Kombiwagen BM 601.071/.072 ²⁾		03.6511-0030.3	320076			BRL 1/1 (2)	ATE
	208 210	649391 649391			+ Kombiwagen BM 601.071/.072 ²⁾ + Kombiwagen BM 601.071/.072 ²⁾		03.6515-0305.3	320087			BRL 1/5 (2)	ATE
	208 208 210 210		249411 248950 249411 248950	05.77 05.77 05.77 05.77	+ Kombiwagen BM 601.077 ³⁾ + Kombiwagen BM 601.076 ⁴⁾ + Kombiwagen BM 601.077 ³⁾ + Kombiwagen BM 601.076 ⁴⁾		03.6511-0030.3	320076			BRL 1/1 (2)	ATE
	208 210	649391 649391			+ Kombiwagen BM 601.076/.077 ⁵⁾ + Kombiwagen BM 601.076/.077 ⁵⁾		03.6515-0305.3	320087			BRL 1/5 (2)	ATE
	207 D 208 D		649390 649390	05.77 09.88	- Kombiwagen ¹⁾ - Kombiwagen ¹⁾		03.6511-0030.3	320076			BRL 1/1 (2)	ATE
	207 D 208 D	649391 649391			- Kombiwagen ¹⁾ - Kombiwagen ¹⁾		03.6515-0305.3	320087			BRL 1/5 (2)	ATE
	207 D 207 D 208 D 208 D	500000 240106 500000 240106	556499 240106 556499 240106	05.77 05.77 09.88	+ Kombiwagen BM 601.371/.372 ⁶⁾ + Kombiwagen BM 601.371/.372 ⁶⁾ + Kombiwagen BM 601.371/.372 ⁶⁾ + Kombiwagen BM 601.371/.372 ⁶⁾		03.6511-0030.3	320076			BRL 1/1 (2)	ATE
	207 D 208 D	649391 649391			+ Kombiwagen BM 601.371/.372 ⁶⁾ + Kombiwagen BM 601.371/.372 ⁶⁾		03.6515-0305.3	320087			BRL 1/5 (2)	ATE
	207 D 207 D 208 D 208 D		249719 249588 249719 249588	05.77 05.77 09.88 09.88	+ Kombiwagen BM 601.377 ⁷⁾ + Kombiwagen BM 601.376 ⁸⁾ + Kombiwagen BM 601.377 ⁷⁾ + Kombiwagen BM 601.376 ⁸⁾		03.6511-0030.3	320076			BRL 1/1 (2)	ATE
	207 D 208 D	649391 649391			+ Kombiwagen BM 601.376/.377 ⁹⁾ + Kombiwagen BM 601.376/.377 ⁹⁾		03.6515-0305.3	320087			BRL 1/5 (2)	ATE
	209 D 210 D		649390 649390	05.77 09.88	- Kombiwagen ¹⁾ - Kombiwagen ¹⁾		03.6511-0030.3	320076			BRL 1/1 (2)	ATE
	209 D 210 D	649391 649391			- Kombiwagen ¹⁾ - Kombiwagen ¹⁾		03.6515-0305.3	320087			BRL 1/5 (2)	ATE
	209 D 210 D	614797 614797			+ Kombiwagen BM 601.476/.477 ¹⁰⁾ + Kombiwagen BM 601.476/.477 ¹⁰⁾		03.6515-0305.3	320087			BRL 1/5 (2)	ATE
	207 D 208 208 D 210		232362 232362 232362 232362	05.77 05.77 09.88 05.77			24.2419-0911.3	030043			Gz 19,05	
	207 D 208 208 D 210	232363 232363 232363 232363	499999 499999 499999 499999				24.2419-0917.3	030047			Gz 19,05	
	207 D 208 208 D 210	500000 500000 500000 500000	547854 547854 547854 547854				24.2419-0911.3	030043			Gz 19,05	
	207 D 208 208 D	547855 547855 547855					24.2419-0917.3	030047			Gz 19,05	

1) - estate / - Station Wagon / - break / - break
 2) + Estate BM 601.071/072 / + Station Wagon BM 601.071/072 / + Break BM 601.071/072 / + Break BM 601.071/072
 3) + Estate BM 601.077 / + Station Wagon BM 601.077 / + Break BM 601.077 / + Break BM 601.077
 4) + Estate BM 601.076 / + Station Wagon BM 601.076 / + Break BM 601.076 / + Break BM 601.076
 5) + Estate BM 601.076/077 / + Station Wagon BM 601.076/077 / + Break BM 601.076/077 / + Break BM 601.076/077
 6) + Estate BM 601.371/372 / + Station Wagon BM 601.371/372 / + Break BM 601.371/372 / + Break BM 601.371/372

7) + Estate BM 601.377 / + Station Wagon BM 601.377 / + Break BM 601.377 / + Break BM 601.377
 8) + Estate BM 601.376 / + Station Wagon BM 601.376 / + Break BM 601.376 / + Break BM 601.376
 9) + Estate BM 601.376/377 / + Station Wagon BM 601.376/377 / + Break BM 601.376/377 / + Break BM 601.376/377
 10) + Estate BM 601.476/477 / + Station Wagon BM 601.476/477 / + Break BM 601.476/477 / + Break BM 601.476/477





MERCEDES BENZ Transporter (BM 601) 207 D-210 D

	210	547855				24.2419-0917.3	030047		Gz 19,05	
	209 D			05.77		24.2419-0917.3	030047		Gz 19,05	
	210 D			09.88						
	207 D			05.77		03.2523-0812.3	040020		Nz 23,81	
	208			05.77		03.0450-2311.2	082311		Nz Reparatursatz	
	208 D			09.88						
	209 D			05.77						
	210			05.77						
	210 D			09.88						

MERCEDES BENZ Transporter (BM 602) 307 D-310 D

	307 D		649390	05.77	- Bus 1)	03.6850-2602.4	300049		9"	ATE
	307 D		625656	05.77	+ Bus 2)					
	308		649390	05.77	- Bus 1)					
	308		625656	05.77	+ Bus 2)					
	308 D		649390	09.88	- Bus 1)					
	308 D		625656	09.88	+ Bus 2)					
	309 D		649390	05.77	- Bus 1)					
	310		649390	05.77	+ Bus 2)					
	310		625656	05.77	- Bus 1)					
	310 D		649390	09.88	+ Bus 2)					
	307 D	649391			- Bus 1)	03.6855-1402.4	300057		9" Tandem	ATE
	307 D	625657			+ Bus 2)					
	308	649391			- Bus 1)					
	308	625657			+ Bus 2)					
	308 D	649391			- Bus 1)					
	308 D	625657			+ Bus 2)					
	309 D	649391			- Bus 1)					
	310	649391			+ Bus 2)					
	310	625657			- Bus 1)					
	310 D	649391			+ Bus 2)					
	307 D		649390	05.77	- Bus 1)	03.2123-6002.3	010184		THz 23,81	ATE
	307 D		625656	05.77	+ Bus 2)					
	308		649390	05.77	- Bus 1)					
	308		625656	05.77	+ Bus 2)					
	308 D		649390	09.88	- Bus 1)					
	308 D		625656	09.88	+ Bus 2)					
	309 D		649390	05.77	- Bus 1)					
	310		649390	05.77	+ Bus 2)					
	310		625656	05.77	- Bus 1)					
	310 D		649390	09.88	+ Bus 2)					
	307 D	649391			- Bus 1)	03.2125-1902.3	010206	- ABS	THz 25,40	ATE
	307 D	625657			+ Bus 2)					
	308	649391			- Bus 1)					
	308	625657			+ Bus 2)					
	308 D	649391			- Bus 1)					
	308 D	625657			+ Bus 2)					
	309 D	649391			- Bus 1)					
	310	649391			+ Bus 2)					
	310	625657			- Bus 1)					
	310 D	649391			+ Bus 2)					
	307 D		VA:A025460	05.77	+ 1-Kreis-Sättel 3)	13.4441-8013.2	210261	<input type="checkbox"/>	D=44	ATE
	308		VA:A025460	05.77	+ 1-Kreis-Sättel 3)	13.4441-8014.2	210262	<input type="checkbox"/>	D=44	ATE
	308 D		VA:A025460	09.88	+ 1-Kreis-Sättel 3)	13.0441-4408.2	250096		Dichtungssatz	ATE
	309 D		VA:A025460	05.77	+ 1-Kreis-Sättel 3)					
	310		VA:A025460	05.77	+ 1-Kreis-Sättel 3)					
	310 D		VA:A025460	09.88	+ 1-Kreis-Sättel 3)					
	307 D		VA:A025460	05.77	+ 2-Kreis-Sättel 4)	13.4441-8015.2	210263	<input type="checkbox"/>	D=44	ATE
	308		VA:A025460	05.77	+ 2-Kreis-Sättel 4)	13.4441-8016.2	210264	<input type="checkbox"/>	D=44	ATE
	308 D		VA:A025460	09.88	+ 2-Kreis-Sättel 4)	13.0441-4408.2	250096		Dichtungssatz	ATE
	309 D		VA:A025460	05.77	+ 2-Kreis-Sättel 4)					
	310		VA:A025460	05.77	+ 2-Kreis-Sättel 4)					
	310 D		VA:A025460	09.88	+ 2-Kreis-Sättel 4)					
	307 D	VA:A025461				13.4441-8017.2	210265	<input type="checkbox"/>	D=44	ATE
	308	VA:A025461				13.4441-8018.2	210266	<input type="checkbox"/>	D=44	ATE
	308 D	VA:A025461				13.0441-4408.2	250096		Dichtungssatz	ATE
	309 D	VA:A025461								
	310	VA:A025461								
	310 D	VA:A025461								
	307 D			05.77		13.0460-4401.2	604401		20784 18,0 /WE	ATE
	308			05.77		13.0460-0158.2	610158	VA: -A025460 5) VA: A025461 - 6)	Belagsatz-Zubehör	ATE
	308 D			09.88		13.0460-0160.2	610160	4	Belagsatz-Zubehör	ATE
	309 D			05.77		24.8190-0401.2	620401		Warmkontakt L=95mm	ATE
	310			05.77						
	310 D			09.88						
	307 D		VA:A025460	05.77		24.0116-0100.1	416100		280 16,0 13,0 +B	
	308		VA:A025460	05.77						
	308 D		VA:A025460	09.88						
	309 D		VA:A025460	05.77						
	310		VA:A025460	05.77						
	310 D		VA:A025460	09.88						
	307 D	VA:A025461				24.0122-0140.1	422140		280 22,0 19,0 L	
	308	VA:A025461								
	308 D	VA:A025461								
	309 D	VA:A025461								
	310	VA:A025461								
	310 D	VA:A025461								

1) - bus / - autobus / - autobus/car / - autobús
 2) + bus / + autobus / + autobus/car / + autobús
 3) + single circuit caliper / + pinza a circuito singolo / + étriers frein à 1 circuit / + pinza de 1 circuito
 4) + two circuit caliper / + pinza freno a 2 circuiti / + étriers frein à 2 circuits / + pinza de 2 circuitos
 5) FA: -A025460 / A: -A025460 / ess.AV: -A025460 / ED: -A025460
 6) FA: A025461 - / A: A025461 - / ess.AV: A025461 - / ED: A025461 -



















MERCEDES BENZ Transporter (BM 602) 307 D-310 D

	310 D	VA:A025461				24.0122-0140.1	422140			280 22,0 19,0 L
	307 D 308 308 D 309 D 310 310 D			05.77 05.77 09.88 05.77 05.77 09.88		24.5201-0474.3	331434	2		L=474
	307 D 308 308 D 309 D 310 310 D			05.77 05.77 09.88 05.77 05.77 09.88		24.5170-0426.3	331452	2		L=426
	307 D 308 308 D 309 D 310 310 D			05.77 05.77 09.88 05.77 05.77 09.88		24.3215-0902.3	020153			Rz 15,87
	307 D 308 308 D 309 D 310 310 D			05.77 05.77 09.88 05.77 05.77 09.88		24.0226-0001.1	480050			260/261,5 x 64
	307 D 308 308 D 309 D 310 310 D			05.77 05.77 09.88 05.77 05.77 09.88		24.3727-0420.2 24.3727-0459.2 24.3727-0460.2	580420 580459 580460	2 ☐ ☐		L=1798 L=1845 L=1845
	308 310		649390 649390	05.77 05.77	- Bus 1) - Bus 1)	03.6511-0030.3	320076			BRL 1/1 (2) ATE
	308 310	649391 649391			- Bus 1) - Bus 1)	03.6513-0340.3	320084			BRL 1/3 (2) ATE
	308 310		625656 625656	05.77 05.77	+ Bus 2) + Bus 2)	03.6511-0030.3	320076			BRL 1/1 (2) ATE
	308 310	649391 649391			+ Bus 2) + Bus 2)	03.6513-0340.3	320084			BRL 1/3 (2) ATE
	307 D 308 D		649390 649390	05.77 09.88	- Bus 1) - Bus 1)	03.6511-0030.3	320076			BRL 1/1 (2) ATE
	307 D 308 D	649391 649391			- Bus 1) - Bus 1)	03.6513-0340.3	320084			BRL 1/3 (2) ATE
	307 D 308 D		625656 625656	05.77 09.88	+ Bus 2) + Bus 2)	03.6511-0030.3	320076			BRL 1/1 (2) ATE
	307 D 308 D	649391 649391			+ Bus 2) + Bus 2)	03.6513-0340.3	320084			BRL 1/3 (2) ATE
	309 D 310 D		649390 649390	05.77 09.88		03.6511-0030.3	320076			BRL 1/1 (2) ATE
	309 D 310 D	649391 649391				03.6513-0340.3	320084			BRL 1/3 (2) ATE
	307 D 308 308 D 310		232362 232362 232362 232362	05.77 05.77 09.88 05.77		24.2419-0911.3	030043			Gz 19,05
	307 D 308 308 D 310	232363 232363 232363 232363	499999 499999 499999 499999			24.2419-0917.3	030047			Gz 19,05
	307 D 308 308 D 310	500000 500000 500000 500000	547854 547854 547854 547854			24.2419-0911.3	030043			Gz 19,05
	307 D 308 308 D 310	547855 547855 547855 547855				24.2419-0917.3	030047			Gz 19,05
	309 D 310 D			05.77 09.88		24.2419-0917.3	030047			Gz 19,05
	307 D 308 308 D 309 D 310 310 D			05.77 05.77 09.88 05.77 05.77 09.88		03.2523-0812.3 03.0450-2311.2	040020 082311			Nz 23,81 Nz Reparatursatz

MERCEDES BENZ Transporter (BM 605) 206/207

	L 206 DG L 207			01.73 01.73	04.77 04.77	83.6123-0465.3	330379	2		L=465
--	-------------------	--	--	----------------	----------------	----------------	--------	---	--	-------

1) - bus / - autobus / - autobus/car / - autobús
2) + bus / + autobus / + autobus/car / + autobús

								
MERCEDES BENZ Transporter (BM 605) 206/207								
	L 206 DG L 207		01.73 01.73	04.77 04.77	24.3222-1733.3	020538		Rz 22,20
	L 206 DG L 207		01.73 01.73	04.77 04.77	03.3222-4401.3	020076		Rz 22,20
	L 206 DG L 207		01.73 01.73	04.77 04.77	03.6521-0012.3	320094		BRL 2/1 (3) ATE
	L 206 DG L 207		01.73 01.73	04.77 04.77	03.2525-2602.3 03.0450-2510.2	040029 082510		Nz 25,40 Nz Reparatursatz
	L 206 DG L 207		01.73 01.73	04.77 04.77	83.6103-0200.3	330219		L=200
MERCEDES BENZ Transporter (BM 606) 306 DG/307								
	L 306 DG L 306 DG Zugkopf L 307 L 307 Zugkopf		01.73 01.73 01.73 01.73	04.77 04.77 04.77 04.77	83.6123-0465.3	330379	2	L=465
	L 306 DG L 306 DG Zugkopf L 307 L 307 Zugkopf		01.73 01.73 01.73 01.73	04.77 04.77 04.77 04.77	24.3222-1733.3	020538		Rz 22,20
	L 306 DG L 307		01.73 01.73	04.77 04.77	03.3222-4401.3	020076		Rz 22,20
	L 306 DG L 307		01.73 01.73	04.77 04.77	03.6521-0012.3	320094		BRL 2/1 (3) ATE
	L 306 DG L 307		01.73 01.73	04.77 04.77	03.2525-2602.3 03.0450-2510.2	040029 082510		Nz 25,40 Nz Reparatursatz
	L 306 DG L 307		01.73 01.73	04.77 04.77	83.6103-0200.3	330219		L=200
MERCEDES BENZ Transporter (BM 607) 206 D								
	L 206 D		01.72	12.73 + 2,4 t	24.3526-0810.3	340037	1	Bremslichtschalter
	L 206 D		01.72	12.73 + 2,7 t	24.3526-0810.3	340037	1	Bremslichtschalter
	L 206 D		01.72	12.73	83.6203-0200.3	330298	2	L=200
	L 206 D		01.72	12.73 + 2,7 t	03.3222-4401.3	020076		Rz 22,20
	L 206 D		01.72	12.73	03.0450-2509.2	082509		Nz Reparatursatz
	L 206 D		01.72	12.73	83.6103-0200.3	330219		L=200
MERCEDES BENZ Transporter (BM 608) 306 D								
	L 306 D		01.72	12.73 + 3,0/ 3,3 t	24.3526-0810.3	340037	1	Bremslichtschalter
	L 306 D L 306 D Zugkopf	01646 01646	01.72 01.72	+ 4,0 t	24.3526-0810.3	340037	1	Bremslichtschalter
	L 306 D		01.72	12.73	83.6203-0200.3	330298	2	L=200
	L 306 D		01.72	12.73 + 3,0/ 3,3 t	03.3222-4401.3	020076		Rz 22,20
	L 306 D		01.72	12.73	03.0450-2509.2	082509		Nz Reparatursatz
	L 306 D		01.72	12.73	83.6103-0200.3	330219		L=200
MERCEDES BENZ Transporter (BM 611) 407 D-410 D								
	407 D 408 D 409 D 410 410 D	598435 598435 598435 598435 598435			03.6855-1402.4	300057		9" Tandem ATE
	407 D 408 D 409 D 410 410 D	598435 598435 598435 598435 598435			03.2126-0512.3	010217	- ABS	THz 26,99 ATE

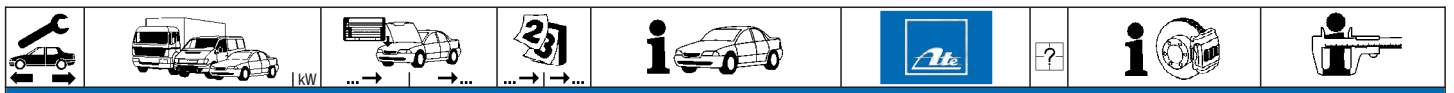

MERCEDES BENZ Transporter (BM 611) 407 D-410 D

	407 D 408 D 409 D 410 410 D		VA:A025460 VA:A025460 VA:A025460 VA:A025460 VA:A025460	06.81 10.88 06.81 06.81 11.88	+ 1-Kreis-Sättel ¹⁾ + 1-Kreis-Sättel ¹⁾ + 1-Kreis-Sättel ¹⁾ + 1-Kreis-Sättel ¹⁾ + 1-Kreis-Sättel ¹⁾	13.4441-8013.2 13.4441-8014.2 13.0441-4408.2	210261 210262 250096		D=44 D=44 Dichtungssatz	ATE ATE ATE
	407 D 408 D 409 D 410 410 D		VA:A025460 VA:A025460 VA:A025460 VA:A025460 VA:A025460	06.81 10.88 06.81 06.81 11.88	+ 2-Kreis-Sättel ²⁾ + 2-Kreis-Sättel ²⁾ + 2-Kreis-Sättel ²⁾ + 2-Kreis-Sättel ²⁾ + 2-Kreis-Sättel ²⁾	13.4441-8015.2 13.4441-8016.2 13.0441-4408.2	210263 210264 250096		D=44 D=44 Dichtungssatz	ATE ATE ATE
	407 D 408 D 409 D 410 410 D	VA:A025461 VA:A025461 VA:A025461 VA:A025461 VA:A025461				13.4441-8017.2 13.4441-8018.2 13.0441-4408.2	210265 210266 250096		D=44 D=44 Dichtungssatz	ATE ATE ATE
	407 D 408 D 409 D 410 410 D			06.81 10.88 06.81 06.81 11.88		13.0460-4401.2 13.0460-0158.2 13.0460-0160.2 24.8190-0401.2	604401 610158 610160 620401	VA: -A025460 ³⁾ VA: A025461 - ⁴⁾	20784 18,0 /WE Belagsatz-Zubehör Belagsatz-Zubehör Warnkontakt L=95mm	ATE ATE ATE
	407 D 408 D 409 D 410 410 D		VA:A025460 VA:A025460 VA:A025460 VA:A025460 VA:A025460	06.81 10.88 06.81 06.81 11.88		24.0116-0100.1	416100		280 16,0 13,0 +B	
	407 D 408 D 409 D 410 410 D	VA:A025461 VA:A025461 VA:A025461 VA:A025461 VA:A025461				24.0122-0140.1	422140		280 22,0 19,0 L	
	407 D 408 D 409 D 410 410 D			06.81 10.88 06.81 06.81 11.88		24.5201-0474.3	331434	2	L=474	
	407 D 408 D 409 D 410 410 D			06.81 10.88 06.81 06.81 11.88		24.5170-0426.3	331452	2	L=426	
	407 D 408 D 409 D 410 410 D			06.81 10.88 06.81 06.81 11.88		24.3222-1732.3	020537		Rz 22,20	
	407 D 408 D 409 D 410 410 D			06.81 10.88 06.81 06.81 11.88		03.6513-0340.3	320084		BRL 1/3 (2)	ATE
	407 D 408 D 409 D 410 410 D		547854 547854 547854 556499 547854	06.81 10.88 06.81 06.81 11.88		24.2419-0911.3	030043		Gz 19,05	
	407 D 408 D 409 D 410 410 D	547855 547855 547855 556500 547855				24.2419-0917.3	030047		Gz 19,05	
	407 D 408 D 409 D 410 410 D			06.81 10.88 06.81 06.81 11.88		03.2523-0812.3 03.0450-2311.2	040020 082311		Nz 23,81 Nz Reparatursatz	
	410		556499	06.81		83.6104-0470.3	330253		L=470	

MERCEDES BENZ Transporter (BM 667) 507 D-510

	507 D 508 D 508 DK 510			03.86 05.90 05.90 03.86		03.6855-2202.4	300061		9" Tandem	ATE
	507 D 508 D 508 DK 510		VA:A025460 VA:A025460 VA:A025460 VA:A025460	03.86 05.90 05.90 03.86		13.4441-8013.2 13.4441-8014.2 13.0441-4408.2	210261 210262 250096		D=44 D=44 Dichtungssatz	ATE ATE ATE
	507 D 508 D 508 DK 510	VA:A025461 VA:A025461 VA:A025461 VA:A025461			VA 730.407 ⁵⁾	13.4441-8017.2 13.4441-8018.2 13.0441-4408.2	210265 210266 250096		D=44 D=44 Dichtungssatz	ATE ATE ATE
	507 D 510			03.86 03.86	VA 730.602 ⁶⁾ VA 730.602 ⁶⁾	11.0441-6002.2	250036		Dichtungssatz	ATE

¹⁾ + single circuit caliper / + pinza a circuito singolo / + étriers frein à 1 circuit / + pinza de 1 circuito

²⁾ + two circuit caliper / + pinza freno a 2 circuiti / + étriers frein à 2 circuits / + pinza de 2 circuitos

³⁾ FA: -A025460 / A: -A025460 / ess.AV: -A025460 / ED: -A025460

⁴⁾ FA: A025461 - / A: A025461 - / ess.AV: A025461 - / ED: A025461 -

⁵⁾ FA 730.407 / A 730.407 / essieu AV 730.407 / ED 730.407

⁶⁾ FA 730.602 / A 730.602 / essieu AV 730.602 / ED 730.602



MERCEDES BENZ Transporter (BM 667) 507 D-510

	507 D 508 D 508 DK 510		03.86 05.90 05.90 03.86		13.0460-4401.2 13.0460-0158.2 13.0460-0160.2 24.8190-0401.2	604401 610158 610160 620401	4	VA: -A025460 1) VA: A025461- 2)	20784 18,0 /WE Belagsatz-Zubehör Belagsatz-Zubehör Warnkontakt L=95mm	ATE ATE ATE
	507 D 508 D 508 DK 510	VA:A025460 VA:A025460 VA:A025460 VA:A025460	03.86 05.90 05.90 03.86		24.0116-0100.1	416100			280 16,0 13,0 +B	
	507 D 508 D 508 DK 510	VA:A025461 VA:A025461 VA:A025461 VA:A025461	03.86 05.90 05.90 03.86		24.0122-0140.1	422140			280 22,0 19,0 L	
	507 D 508 D 508 DK 510		03.86 05.90 05.90 03.86		24.5201-0474.3	331434	2		L=474	
	507 D 508 D 508 DK 510		03.86 05.90 05.90 03.86		83.6104-0470.3	330253	2		L=470	
	507 D 508 D 508 DK 510	P012599 P012599 P012599 P012599	03.86 05.90 05.90 03.86		24.2419-0932.3	030058			Gz 19,05	
	507 D 508 D 508 DK 510	P012600 P012600 P012600 P012600	03.86 05.90 05.90 03.86		24.2419-0933.3	030059			Gz 19,05	
	507 D 508 D 508 DK 510		03.86 05.90 05.90 03.86		03.2523-0812.3 03.0450-2311.2	040020 082311			Nz 23,81 Nz Reparatursatz	

MERCEDES BENZ Transporter (BM 668) 609 D

































	609 D 611 D		03.86 06.94		03.6855-2202.4	300061			9" Tandem	ATE
	609 D 611 D		03.86 06.94	- ABS - ABS	03.2130-0102.3	010221			Thz 30,00	ATE
	609 D 611 D		03.86 06.94	+ 16" Rad 3) + 16" Rad 3)	11.0441-6002.2	250036			Dichtungssatz	ATE
	609 D 611 D		03.86 06.94		13.0460-6015.2 24.8190-0415.2	606015 620415	2		29835 21,7 /WE WK Satz L=238/148mm	ATE
	609 D 611 D		03.86 06.94		24.0130-0198.1	430198			304 30,0 26,0 V L	
	609 D 611 D		03.86 06.94		24.5201-0474.3	331434	2		L=474	
	609 D 611 D		03.86 06.94		83.6104-0470.3	330253	2		L=470	
	609 D 611 D		03.86 06.94		03.3230-0401.3	020115			Rz 30,16	
	609 D 611 D	P012599 P012599	03.86 06.94		24.2419-0932.3	030058			Gz 19,05	
	609 D 611 D	P012600 P012600	03.86 06.94		24.2419-0933.3	030059			Gz 19,05	
	609 D 611 D		03.86 06.94		24.2528-0907.3	040054			Nz 28,57	

MERCEDES BENZ Transporter (BM 669) 709 D/711 D

	709 D 711 D		03.86 03.86	- ABS - ABS	24.2133-0901.3	010387			Thz 33,34	
	709 D 711 D		03.86 03.86	+ 16" Rad 3) + 16" Rad 3)	11.0441-6002.2	250036			Dichtungssatz	ATE
	709 D 711 D		03.86 03.86	+ 17,5" Rad 4) + 17,5" Rad 4)	11.0441-6002.2	250036			Dichtungssatz	ATE
	709 D 711 D		03.86 03.86		13.0460-6015.2 24.8190-0415.2	606015 620415	2		29835 21,7 /WE WK Satz L=238/148mm	ATE
	709 D 711 D		03.86 03.86		24.0130-0198.1	430198			304 30,0 26,0 V L	
	709 D 711 D		03.86 03.86		24.5201-0474.3	331434	2		L=474	





















1) FA: -A025460 / A: -A025460 / ess.AV: -A025460 / ED: -A025460
 2) FA: A025461- / A: A025461- / ess.AV: A025461- / ED: A025461-
 3) + 16" wheel / + ruota 16" / + roue 16" / + rueda 16"
 4) + 17,5" wheel / + ruota 17,5" / + roue 17,5" / + rueda 17,5"



																	
MERCEDES BENZ Transporter (BM 669) 709 D/711 D																	
	709 D 711 D				03.86 03.86					83.6104-0470.3	330253	2					L=470
	709 D 711 D				03.86 03.86					03.3231-3401.3 03.0401-2031.2	020120 052031						Rz 31,75 Rz Reparatursatz
	709 D 711 D			P012599 P012599	03.86 03.86					24.2419-0932.3	030058						Gz 19,05
	709 D 711 D	P012600 P012600								24.2419-0933.3	030059						Gz 19,05
	709 D 711 D				03.86 03.86					24.2528-0907.3	040054						Nz 28,57
MERCEDES BENZ Transporter (BM 670) 809 D-814 D																	
	809 D 811 D 811 DK 814 D				03.86 03.86 06.90 03.86			- ABS - ABS - ABS - ABS		24.2133-0901.3	010387						Thz 33,34
	809 D 811 D 811 DK 814 D				03.86 03.86 06.90 03.86			+ 17,5" Rad ¹⁾ + 17,5" Rad ¹⁾ + 17,5" Rad ¹⁾ + 17,5" Rad ¹⁾		11.0441-6002.2	250036						Dichtungssatz ATE
	809 D 811 D 811 DK 814 D				03.86 03.86 06.90 03.86					13.0460-6015.2 24.8190-0415.2	606015 620415	2					29835 21,7 /WE ATE WK Satz L=238/148mm
	809 D 811 D 811 DK 814 D				03.86 03.86 06.90 03.86					24.0130-0103.1	430103						324 30,0 26,0 V L
	809 D 811 D 811 DK 814 D				03.86 03.86 06.90 03.86					24.5201-0474.3	331434	2					L=474
	809 D 811 D 811 DK 814 D				03.86 03.86 06.90 03.86					83.6104-0470.3	330253	2					L=470
	809 D 811 D 811 DK 814 D				03.86 03.86 06.90 03.86					03.3231-3401.3 03.0401-2031.2	020120 052031						Rz 31,75 Rz Reparatursatz
	809 D 809 DT 811 D 811 DK 814 D 814 DA			P012599 P012599 P012599 P012599 P012599 P012599	03.86 03.86 03.86 06.90 03.86 06.90					24.2419-0932.3	030058						Gz 19,05
	809 D 809 DT 811 D 811 DK 814 D 814 DA	P012600 P012600 P012600 P012600 P012600 P012600								24.2419-0933.3	030059						Gz 19,05
	809 D 809 DT 811 D 811 DK 814 D 814 DA				03.86 03.86 03.86 06.90 03.86 06.90					24.2528-0907.3	040054						Nz 28,57
MERCEDES BENZ Transporter (BM 631) MB 100 D (87-96)																	
	MB 100 D	021972			02.96					24.2125-1719.3	010666						Thz 25,40
	MB 100 D				09.87 02.96			- Triebkopf (BM 631.349) ²⁾		24.3481-1759.5	240339	2					D=48/48, - Halter BDX
	MB 100 D				09.87 02.96			- Triebkopf (BM 631.349) ²⁾		13.0460-3945.2 13.0460-0918.2	603945 610918						20932 14,0 + Belagsatz-Zubehör BDX BDX
	Triebkopf				09.87 02.96			BM 631.349		13.0460-0918.2	610918						Belagsatz-Zubehör BDX
	MB 100 D				09.87 02.96			- Triebkopf (BM 631.349) ²⁾		24.0116-0107.2	416107						239 16,0 14,5 +B
	MB 100 D				09.87 02.96					24.5232-0388.3	330580	4					L=360
	MB 100 D				09.87 02.96					24.3225-1102.3	020318						Rz 25,40
	MB 100 D				09.87 02.96					03.0137-0245.2 03.0137-9145.2	650245 669145						254 x 57 Bremsbacken-Zubehör

¹⁾ + 17,5" wheel / + ruota 17,5" / + roue 17,5" / + rueda 17,5"

²⁾ - drive head (BM 631.349) / - motrice sola cabina (BM 631.349) / - tête propulsion (BM 631.349) / - grupo motriz (BM 631.349)

							
MERCEDES BENZ Transporter (BM 631) MB 100 D (87-96)							
	MB 100 D		09.87	02.96	24.0225-4003.1	480049	254/255 x 65
	MB 100 D		09.87	02.96	03.0420-1025.3	681025	25,40/254x57 Kit TRW
	MB 100 D		09.87	02.96 + Radstand 2450mm /- Triebkopf ¹⁾	24.3727-0413.2	580413	L=1416
	MB 100 D Triebkopf		09.87	02.96 + Radstand 2675mm ²⁾	24.3727-0415.2	580415	L=1438
	MB 100 D	099541		02.96	24.3727-0414.2	580414	L=1647
				BM 631.349	24.3727-0415.2	580415	L=1438
	MB 100 D	099541		02.96	24.2419-1729.3	030118	Gz 19,05
	MB 100 D	099541		02.96	03.2525-2602.3	040029	Druckstange mit Gabelkopf ³⁾ Nz 25,40
MITSUBISHI COLT/LANCER (78-84)							
	1.4 T Colt (A152A)		03.82	01.84	24.0118-0109.1	418109	242 18,0 16,4 V
	1.2 Colt (A151/155A)		09.78	01.84	24.3219-1716.3	020071	Rz 19,05
	1.2 Lancer F (A155A)		09.78	01.84			
	1.4 Colt (A152/156A)		09.78	01.84			
	1.4 Lancer F (A156A)		09.78	01.84			
	1.4 T Colt (A152A)		03.82	01.84			
MITSUBISHI COLT/LANCER Limousine (84-88)							
	1.2 (C15A)		01.84	06.88	24.0113-0159.1	413159	243 12,7 11,4
	1.3 (C11A)		01.84	06.88			
	1.5 (C12A)		01.84	02.89			
	1.6 i Turbo (C13A)		01.84	06.88	24.0118-0109.1	418109	242 18,0 16,4 V
	1.8 D (C14A)		01.84	06.88			
	1.2 (C15A)		01.84	06.88	24.3219-1716.3	020071	Rz 19,05
	1.3 (C11A)		01.84	06.88			
	1.5 (C12A)		01.84	02.89			
	1.6 i Turbo (C13A)		01.84	06.88			
	1.8 D (C14A)		01.84	06.88			
	1.2 (C15A)		01.84	06.88	03.0137-0216.2	650216	180 x 37 HEB
	1.3 (C11A)		01.84	06.88	03.0137-9107.2	669107	Bremsbacken-Zubehör
	1.5 (C12A)		01.84	02.89			
	1.6 i Turbo (C13A)		01.84	06.88			
	1.8 D (C14A)		01.84	06.88			
MITSUBISHI COLT/LANCER Limousine (88-92)							
	1.2 (C65A)		06.90	05.92	13.0460-5953.2	605953	21650 15,0
	1.3 (C51A/V)		06.90	05.92	13.0460-0233.2	610233	Belagsatz-Zubehör
	1.3 (C61A)		06.90	10.92			
	1.5 (C52A) KAT		06.90	05.92			
	1.5 (C62A)		06.90	10.92			
	1.5 GLXi (C52A)		06.90	05.92			
	1.6 16V (C66A)		06.92	10.92 - ABS			
	1.6 4x4 (C76A)		06.92	10.92			
	1.8 4x4 (C77A)		06.90	05.92			
	1.8 D (C54A)		06.90	05.92			
	1.8 D (C64A)		06.90	05.92			
	2.0 D (C67A)		06.92	10.92			
	1.6 16V (C66A)		06.92	10.92 + ABS	13.0460-5952.2	605952	21647 16,0 +/WK
	1.8 GTi 16V (C58A)		11.89	05.92	13.0460-0442.2	610442	Belagsatz-Zubehör
	1.8 GTi 16V (C68A)		11.89	05.92			
	1.8 GTi 16V (C69A)		06.92	10.92			
	1.2 (C65A)		04.88	05.90	24.0113-0159.1	413159	243 12,7 11,4
	1.3 (C51A/V)		04.88	05.90 - elektr. Vergaser ⁴⁾			
	1.3 EL (C61A)		04.88	05.90			
	1.3 GL (C61A)		04.88	05.90 - elektr. Vergaser ⁴⁾			
	1.5 (C62A)		04.88	05.90 + 4 türrig ⁵⁾			
	1.5 GLXi (C52A)		04.88	05.90			
	1.3 (C51A/V)		04.88	05.90 + elektr. Vergaser ⁶⁾	24.0118-0109.1	418109	242 18,0 16,4 V
	1.3 GL (C61A)		04.88	05.90 + elektr. Vergaser ⁶⁾			
	1.3 GL (C61A)		04.88	05.90 - elektr. Vergaser ⁴⁾			
	1.5 (C62A)		04.88	05.90 + 5 türrig ⁷⁾			
	1.5 GLXi (C52A)		04.88	05.90			
	1.8 4x4 (C77A)		05.89	05.90			
	1.8 D (C54A)		04.88	05.90			
	1.8 D (C64A)		04.88	05.90			
	1.2 (C65A)		06.90	05.92	24.0113-0183.1	413183	234 13,0 11,4
	1.3 (C51A/V)		06.90	05.92 - elektr. Vergaser ⁴⁾			
	1.3 EL (C61A)		06.90	05.92 + Getriebe F5M21 ⁸⁾			
	1.3 GL (C61A)		06.90	05.92 - elektr. Vergaser ⁴⁾			
	1.3 GLX (C61A)		06.90	05.92			
	1.5 (C52A) KAT		06.90	05.92			
	1.5 (C62A)		06.90	05.92 + 4 türrig ⁵⁾			
	1.3 (C51A/V)		06.90	05.92 + elektr. Vergaser ⁶⁾	24.0118-0112.1	418112	236 18,0 16,4 V
	1.3 (C61A)		06.92	10.92			
	1.3 GL (C61A)		06.90	05.92 + elektr. Vergaser ⁶⁾			

¹⁾ + wheel base 2450 mm/ - drivehead / + passo 2450 mm/ - motr.sola cab. / + empatt.2450 mm/ - tête propuls. / + dist.ejes 2450 mm/ - grupo dif.

²⁾ + wheel base 2675 mm / + passo 2675 mm / + empattement 2675 mm / + distancia entre ejes 2675mm

³⁾ push rod with yoke / asta spinta +testa a forcella / tige poussée avec fourchette / barra de presión con horquilla

⁴⁾ - electric carburetor / - carburatore elettronico / - carburateur électrique / - carburador eléctrico

⁵⁾ + 4 door / + 4 porte / + 4 portes / + 4 puertas

⁶⁾ + electric carburetor / + carburatore elettronico / + carburateur électrique / + carburador eléctrico

⁷⁾ + 5 door / + 5 porte / + 5 portes / + 5 puertas

⁸⁾ + transmission F5M21 / + scatola cambio F5M21 / + boîte de vitesse F5M21 / + cambio F5M21



MITSUBISHI COLT/LANCER Limousine (88-92)

	1.5 (C52A) KAT 1.5 (C62A) 1.5 GLXi (C52A) 1.6 16V (C66A) 1.6 4x4 (C76A) 1.8 4x4 (C77A) 1.8 D (C54A) 1.8 D (C64A) 2.0 D (C67A)		06.90 06.90 06.90 06.92 06.92 06.90 06.90 06.90 06.92	05.92 10.92 05.92 10.92 10.92 05.92 05.92 05.92 10.92	+ 5 türg 1) - ABS	24.0118-0112.1	418112		236 18,0 16,4 V
	1.6 16V (C66A) 1.6 GTi 16V (C53/63A) 1.8 GTi 16V (C58A) 1.8 GTi 16V (C68A) 1.8 GTi 16V (C69A)		06.92 04.88 11.89 11.89 06.92	10.92 05.90 05.92 05.92 10.92	+ ABS	24.0110-0238.1	410238		265 10,0 8,4
	1.2 (C65A) 1.3 (C51A/V) 1.3 (C61A) 1.5 (C52A) KAT 1.5 (C62A) 1.8 D (C54A) 1.8 D (C64A)		04.88 04.88 04.88 04.88 04.88 04.88 04.88	05.90 05.90 05.90 05.90 05.90 05.90 05.90		24.3219-1716.3	020071		Rz 19,05
	1.2 (C65A) 1.3 (C51A/V) 1.3 (C61A) 1.5 (C52A) KAT 1.5 (C62A) 1.6 16V (C66A) 1.6 4x4 (C76A) 1.8 4x4 (C77A) 1.8 D (C54A) 1.8 D (C64A) 2.0 D (C67A)		06.90 06.90 06.90 06.90 06.90 06.92 06.92 05.89 06.90 06.90 06.92	05.92 05.92 10.92 05.92 05.92 10.92 10.92 05.92 05.92 05.92 10.92	- ABS	24.3219-1752.3	020505		Rz 19,05
	1.2 (C65A) 1.3 (C51A/V) 1.3 (C61A) 1.5 (C52A) KAT 1.5 (C62A) 1.8 D (C54A) 1.8 D (C64A)		04.88 04.88 04.88 04.88 04.88 04.88 04.88	05.90 05.90 05.90 05.90 05.90 05.90 05.90		03.0137-0216.2	650216		180 x 37 HEB Bremsbacken-Zubehör
	1.2 (C65A) 1.3 (C51A/V) 1.3 (C61A) 1.5 (C52A) KAT 1.5 (C62A) 1.6 16V (C66A) 1.8 D (C54A) 1.8 D (C64A) 2.0 D (C67A)		06.90 06.90 06.90 06.90 06.90 06.92 06.90 06.90 06.92	05.92 05.92 10.92 05.92 05.92 10.92 05.92 05.92 10.92	- ABS	03.0137-0255.2	650255		180 x 37 Bremsbacken-Zubehör
	1.6 4x4 (C76A) 1.8 4x4 (C77A)		06.92 05.89	10.92 05.92		03.0137-0289.2	650289		203 x 37 Bremsbacken-Zubehör
	1.6 4x4 (C76A) 1.8 4x4 (C77A)		06.92 05.89	10.92 05.92		03.0137-9192.2	669192		203 x 37 Bremsbacken-Zubehör





























MITSUBISHI COLT/LANCER Limousine (92-96)

	1.3 (CA1A) 1.3 (CB1A) 1.6 (CA4A) 1.6 (CB4A) 1.6 4WD (CC4A) 1.6 4WD (CD4A) 2.0 D (CB8A) 1.8 16V GTi (CA5A) 1.8 16V GTi (CB5A) 2.0 EVO III (CE9A)		12.91 05.92 12.91 05.92 12.91 05.92 05.92 12.91 05.92 08.95	04.96 04.96 04.96 04.96 04.96 04.96 04.96 04.96 04.96 07.96		13.0460-5953.2	605953		21650 15,0 Belagsatz-Zubehör	SUM
	1.3 (CA1A) 1.3 (CB1A) 1.3 (CA1A) 1.3 (CB1A) 1.6 (CA4A) 1.6 (CB4A) 1.6 4WD (CC4A) 1.6 4WD (CD4A) 2.0 D (CB8A)		12.91 05.92 12.91 05.92 12.91 05.92 05.92 05.92 05.92	04.96 04.96 11.93 04.96 04.96 04.96 04.96 04.96 04.96	+ Option Mod. MNDEQL6 2) + Option Mod. SNDEQL6 3)	13.0460-0233.2	610233		21647 16,0 +/WK Belagsatz-Zubehör	SUM
	1.6 (CA4A) 1.6 (CB4A) 1.6 4WD (CC4A) 1.6 4WD (CD4A) 1.8 16V GTi (CA5A) 1.8 16V GTi (CB5A) 2.0 D (CB8A)	198	08.95 07.96			13.0460-5958.2	605958		21363 15,8 +/WK	AKE
	1.3 (CA1A) 1.3 (CB1A) 1.3 (CA1A) 1.3 (CB1A) 1.6 (CA4A) 1.6 (CB4A) 1.6 4WD (CC4A) 1.6 4WD (CD4A) 2.0 D (CB8A)		12.91 05.92 12.91 05.92 12.91 05.92 05.92 05.92 05.92	04.96 04.96 11.93 04.96 04.96 04.96 04.96 04.96 04.96		24.0113-0186.1	413186		234 13,0 11,4	
	1.6 (CA4A) 1.6 (CB4A) 1.6 4WD (CC4A) 1.6 4WD (CD4A) 1.8 16V GTi (CA5A) 1.8 16V GTi (CB5A) 2.0 D (CB8A)		12.91 05.92 12.91 05.92 12.91 05.92 05.92	04.96 04.96 04.96 11.93 04.96 04.96 04.96		13.0460-5826.2	605826		21872 14,5 +/WK	AKE
	1.6 (CA4A) 1.6 (CB4A) 1.6 4WD (CC4A) 1.6 4WD (CD4A) 2.0 D (CB8A)		12.91 05.92 12.91 05.92 05.92	04.96 04.96 04.96 11.93 04.96		24.0110-0266.1	410266		236 10,0 8,4	

1) + 5 door / + 5 porte / + 5 portes / + 5 puertas

2) + option mod. MNDEQL6 / + opzione mod. MNDEQL6 / + option mod. MNDEQL6 / + opción mod. MNDEQL6

3) + option mod. SNDEQL6 / + opzione mod. SNDEQL6 / + option mod. SNDEQL6 / + opción mod. SNDEQL6

								
MITSUBISHI COLT/LANCER Limousine (92-96)								
	1.3 (CA1A) 1.3 (CB1A)		12.91 05.92	04.96 04.96	24.3219-1752.3	020505		Rz 19,05
	1.3 (CA1A) 1.3 (CB1A) 1.6 (CA4A) 1.6 (CB4A) 2.0 D (CB8A)		12.91 05.92 12.91 05.92 05.92	04.96 04.96 04.96 04.96 04.96	03.0137-0255.2 03.0137-9107.2 03.0137-0289.2 03.0137-9192.2	650255 669107 650289 669192		180 x 37 Bremsbacken-Zubehör 203 x 37 Bremsbacken-Zubehör
	1.6 (CA4A) 1.6 (CB4A) 2.0 D (CB8A)		12.91 05.92 05.92	04.96 04.96 04.96	24.0220-3017.1	480108		229 x 42 203/205 x 42
MITSUBISHI ECLIPSE I (91-95)								
	2.0 16V (D22A) 110		04.91	11.95	13.0460-5952.2 13.0460-0442.2	605952 610442		21647 16,0 +WK Belagsatz-Zubehör
	2.0 16V 4x4 (D27A) 110		04.91	11.95	13.0460-0235.2	610235		Belagsatz-Zubehör
	2.0 16V (D22A) 110		04.91	11.95	24.0124-0142.1	424142		256 24,0 22,4 V
	2.0 16V 4x4 (D27A) 110		04.91	11.95	24.0124-0144.1	424144		276 24,0 22,4 V
	2.0 16V (D22A) 110 2.0 16V 4x4 (D27A) 110		04.91 04.91	11.95 11.95	24.0110-0243.1	410243		265 10,0 8,4
MITSUBISHI GALANT (84-87)								
	1.6 (E11A) 1.6 (E11A) 1.8 TD (E14A) 2.0 (E15A) 2.0 Turbo (E15A) 2.4 GLS (E16A)		05.84 05.84 05.84 05.84 05.84	11.87 11.87 11.87 11.87 11.87	24.0118-0109.1 24.0124-0114.1	418109 424114		242 18,0 16,4 V 266 24,0 22,4 V
	1.6 (E11A) 1.8 TD (E14A)		05.84 05.84	11.87 11.87	24.0220-3018.2	480121	ohne Sensorring ¹⁾	203/205 x 42,5
MITSUBISHI GALANT (4-tuerig) (87-92)								
	1.8 (E32A) 1.8 TD (E34A)		06.90 06.90	10.92 10.92	24.3541-1815.5 24.3541-1816.5	240383 240384	<input type="checkbox"/> <input type="checkbox"/>	D=54, - Halter D=54, - Halter
	1.6 (E31A) 1.8 (E32A) 1.8 TD (E34A) 2.0 (E33A) 2.0 4x4 (E38A) 2.0 4x4 (E39A) 2.0 4x4 (E39A) 2.0 4x4 (E39A)		06.90 06.90 06.90 06.90 06.90 12.89 06.91	10.92 10.92 10.92 10.92 10.92 05.91 + SOHC 10.92 + DOHC	13.0460-5953.2 13.0460-0233.2 13.0460-5952.2 13.0460-0442.2 13.0460-0235.2	605953 610233 605952 610442 610235		21650 15,0 Belagsatz-Zubehör 21647 16,0 +WK Belagsatz-Zubehör Belagsatz-Zubehör
	1.6 (E31A) 1.6 (E31A) 1.8 (E32A) 1.8 TD (E34A) 2.0 (E33A) 2.0 4x4 (E38A) 2.0 4x4 (E39A) 2.0 4x4 (E39A)		12.87 06.90 12.87 12.87 12.87 12.88 06.88 11.89	05.90 10.92 05.90 05.90 05.90 05.90 11.89 05.90 + SOHC	24.0118-0109.1 24.0118-0112.1 24.0124-0114.1	418109 418112 424114	+ 13" Rad ²⁾ + 13" Rad ²⁾ + 14" Rad ³⁾	242 18,0 16,4 V 236 18,0 16,4 V 266 24,0 22,4 V
	1.8 (E32A) 1.8 (E32A) 1.8 TD (E34A) 2.0 (E33A) 2.0 4x4 (E38A) 2.0 4x4 (E39A)		10.89 06.90 06.90 06.90 06.90 06.90	05.90 10.92 - ABS 10.92 10.92 - ABS 10.92 - ABS 05.91 + SOHC	24.0124-0136.1	424136	+ 14" Rad ³⁾	256 24,0 21,5 V +B
	1.8 (E32A) 2.0 (E33A) 2.0 4x4 (E38A) 2.0 4x4 (E39A)		10.89 12.87 12.88 06.88	10.92 + ABS 10.92 10.92 10.92	24.0110-0238.1	410238		265 10,0 8,4
	1.6 (E31A) 1.8 (E32A) 1.8 TD (E34A)		12.88 12.88 12.88	10.92 10.92 - ABS 10.92	03.0137-0289.2 03.0137-9192.2	650289 669192		203 x 37 Bremsbacken-Zubehör
	1.6 (E31A) 1.8 (E32A) 1.8 TD (E34A)		12.87 12.87 12.87	10.92 10.92 - ABS 10.92	24.0220-3018.2	480121	ohne Sensorring ¹⁾	203/205 x 42,5
MITSUBISHI GALANT (5-tuerig) (88-92)								
	1.8 (E32A) 1.8 TD (E34A)		06.90 06.90	10.92 - ABS 10.92	24.3541-1815.5 24.3541-1816.5	240383 240384	<input type="checkbox"/> <input type="checkbox"/>	D=54, - Halter D=54, - Halter
	1.8 (E32A) 1.8 TD (E34A) 2.0 (E33A) 2.0 4x4 (E38A) 2.0 4x4 (E39A)		06.90 06.90 06.90 06.90 06.90	10.92 10.92 10.92 10.92 05.91 + SOHC	13.0460-5952.2 13.0460-0442.2	605952 610442		21647 16,0 +WK Belagsatz-Zubehör

¹⁾ without sensor ring / senza sensori / sans secours ABS / sin anillo sensor ABS

²⁾ + 13" wheel / + ruota 13" / + roue 13" / + rueda 13"

³⁾ + 14" wheel / + ruota 14" / + roue 14" / + rueda 14"



MITSUBISHI GALANT (5-tuerig) (88-92)

	2.0 4x4 (E39A) 2.0 4x4 (E39A)		12.89 06.91	05.91 10.92	+ DOHC	13.0460-0235.2	610235			Belagsatz-Zubehör
	1.8 (E32A) 1.8 TD (E34A) 2.0 (E33A) 2.0 4x4 (E38A) 2.0 4x4 (E39A) 2.0 4x4 (E39A)		11.88 11.88 11.88 04.89 04.89 12.89	05.90 05.90 05.90 05.90 11.89 05.90		24.0124-0114.1	424114			266 24,0 22,4 V
	1.8 (E32A) 1.8 (E32A) 1.8 TD (E34A) 2.0 (E33A) 2.0 4x4 (E38A) 2.0 4x4 (E39A)		10.89 06.90 06.90 06.90 06.90 06.90	05.90 10.92 10.92 10.92 10.92 05.91	- ABS - ABS - ABS - ABS + SOHC	24.0124-0136.1	424136			256 24,0 21,5 V +B
	1.8 (E32A) 2.0 (E33A) 2.0 4x4 (E38A) 2.0 4x4 (E39A)		05.90 11.88 04.89 04.89	10.92 10.92 10.92 10.92	+ ABS	24.0110-0238.1	410238			265 10,0 8,4
	1.8 (E32A) 1.8 TD (E34A)		11.88 11.88	10.92 10.92	- ABS	03.0137-0289.2 03.0137-9192.2	650289 669192			203 x 37 Bremsbacken-Zubehör
	1.8 (E32A) 1.8 TD (E34A)		11.88 11.88	10.92 10.92	- ABS	24.0220-3018.2	480121		ohne Sensorring ¹⁾	203/205 x 42,5

MITSUBISHI GALANT (92-96)

	2.5 i V6 4x4 (E88A)		11.92	09.96		24.3431-1701.5 24.3431-1702.5	240437 240438	<input type="checkbox"/> <input type="checkbox"/>		D=43/43, - Halter D=43/43, - Halter
	1.8 (E52A) 2.0 (E55A) 2.0 4x4 (E75A) 2.0 i V6 (E54A) 2.0 i V6-24 (E64A) 2.0 TD (E57A) 2.5 i V6 4x4 (E88A)	110	11.92 11.92 11.92 11.92 11.92 11.92 11.92	09.96 09.96 09.96 09.96 09.96 09.96 09.96		13.0460-5952.2 13.0460-0442.2	605952 610442			21647 16,0 +WK Belagsatz-Zubehör
	1.8 (E52A) 2.0 (E55A) 2.0 4x4 (E75A) 2.0 i V6 (E54A) 2.0 i V6-24 (E64A) 2.0 TD (E57A)	110	11.92 11.92 11.92 11.92 11.92 11.92	09.96 09.96 09.96 09.96 09.96 09.96		24.0124-0136.1	424136			256 24,0 21,5 V +B
	1.8 (E52A) 2.0 (E55A) 2.0 4x4 (E75A) 2.0 i V6 (E54A) 2.0 i V6-24 (E64A) 2.0 TD (E57A)	110	11.92 11.92 11.92 11.92 11.92 11.92	09.96 09.96 09.96 09.96 09.96 09.96	+ ABS	13.0460-5980.2 13.0460-0150.2	605980 610150		+ 14" Rad/ + 2WD ²⁾	21706 15,5 +WK Belagsatz-Zubehör
	1.8 (E52A) 2.0 (E55A) 2.0 4x4 (E75A) 2.0 i V6 (E54A) 2.0 i V6-24 (E64A) 2.0 TD (E57A)	110	11.92 11.92 11.92 11.92 11.92 11.92	09.96 09.96 09.96 09.96 09.96 09.96	+ ABS	24.0110-0240.1	410240			262 10,0 8,4 +B
	1.8 (E52A) 2.0 TD (E57A)		11.92 11.92	09.96 09.96	- ABS	03.0137-0289.2 03.0137-9192.2	650289 669192			203 x 37 Bremsbacken-Zubehör
	1.8 (E52A) 2.0 (E55A) 2.0 i V6 (E54A) 2.0 i V6-24 (E64A) 2.0 TD (E57A)	110	11.92 11.92 11.92 11.92 11.92	09.96 09.96 09.96 09.96 09.96	+ ABS	03.0137-0452.2	650452			167 x 32

MITSUBISHI L 200 (86-96)























	1.6 (K11T) 2.0 (K12T) 2.5 D (K14T) 2.5 TD 4WD (K34T)	60 75 51 64	04.87 11.86 11.86 05.93	05.92 08.96 08.96 08.96		24.3571-1737.5 24.3571-1738.5	240387 240388	<input type="checkbox"/> <input type="checkbox"/>		D=57, - Halter D=57, - Halter
	1.6 (K11T) 2.0 (K12T) 2.0 4WD (K32T) 2.5 D (K14T) 2.5 D 4WD (K24T) 2.5 TD 4WD (K34T) 2.5 TD 4WD (K34T) 2.5 TD 4WD (K34T)	60 75 75 51 51 64 64 64	04.87 11.86 11.86 11.86 12.87 11.92 05.93 05.93	05.92 08.96 05.92 08.96 05.93 04.93 08.96 08.96		13.0460-5940.2 13.0460-0335.2	605940 610335			21373 16,0 +WK Belagsatz-Zubehör
	2.5 TD 4WD (K34T)	64	05.93	08.96	+ Servolenkung ³⁾	24.3431-1705.2 24.3431-1706.5	240365 240366	<input type="checkbox"/> <input type="checkbox"/>		D=43/43, - Halter D=43/43, - Halter
	2.5 TD 4WD (K34T)	64	05.93	08.96	+ Servolenkung ³⁾	24.0124-0140.1	424140			276 24,0 22,4 V +B
	1.6 (K11T) 2.0 (K12T) 2.5 D (K14T)	60 75 51	04.87 11.86 11.86	05.92 08.96 08.96		24.3223-1712.3 24.3223-1713.3	020571 020572	<input type="checkbox"/> <input type="checkbox"/>		Rz 23,81 Rz 23,81

¹⁾ without sensor ring / senza sensori / sans secours ABS / sin anillo sensor ABS



























²⁾ + 14" wheel/ + 2WD / + ruota 14"/ + 2WD / + roue 14"/ + 2WD / + rueda 14"/ + 2WD

³⁾ + power steering / + servosterzo / + direction assistée / + dirección asistida

⁴⁾ - power steering / - servosterzo / - direction assistée / - dirección asistida































        										
MITSUBISHI L 200 (86-96)										
	1.6 (K11T)	60		04.87	05.92		03.0137-0188.2	650188		254 x 50 Bremsbacken-Zubehör
	2.0 (K12T)	75		11.86	08.96		03.0137-9105.2	669105		
	2.0 4WD (K32T)	75		11.86	05.92					
	2.5 D (K14T)	51		11.86	08.96					
	2.5 D 4WD (K24T)	51		12.87	05.93					
	2.5 TD 4WD (K34T)	64		11.92	08.96					
	2.6 4WD (K33T)	76		11.89	05.95					
MITSUBISHI L 300 (80-86)										
	1.6 (L032P)			09.81	10.86		24.0120-0139.1	420139		256 20,0 18,4 V
	1.6 (L062P)			09.81	10.86					
	2.3 D (L038/068P)			09.81	10.86					
	1.8 4x4 (L035G)			04.83	10.86		24.0120-0130.1	420130		255 20,0 18,4 V
	2.0 4x4 (L037G)			04.83	10.86					
	1.6 (L032P)			04.83	10.86		03.0137-0188.2	650188		254 x 50 Bremsbacken-Zubehör
	1.6 (L062P)			09.81	10.86		03.0137-9105.2	669105		
	1.8 4x4 (L035G)			04.83	10.86					
	2.0 4x4 (L037G)			04.83	10.86					
	2.3 D (L038/068P)			09.81	10.86					
MITSUBISHI L 300 (86-94)										
	1.6 (P02V)			11.88	05.94		24.3571-1737.5	240387	<input type="checkbox"/> <input type="checkbox"/>	D=57, - Halter D=57, - Halter
	1.6 (P12V)			11.88	05.94		24.3571-1738.5	240388		
	2.0 (P03V)			11.86	05.94					
	2.0 (P03W)			11.86	05.94					
	2.0 (P13V)			11.86	05.94					
	2.4 (P04V/W/P14V)			11.90	05.94					
	2.5 D (P05V/W)			11.86	05.94					
2.5 D (P15V)			11.86	05.94						
	1.6 (L032P)			11.88	05.94		13.0460-5940.2	605940	<input type="checkbox"/> <input type="checkbox"/>	21373 16,0 +/-WK Belagsatz-Zubehör
	1.6 (P02V)			11.88	05.94		13.0460-0335.2	610335		
	1.6 (P12V)			11.88	05.94					
	2.0 (P03V)			11.86	05.94					
	2.0 (P03W)			11.86	05.94					
	2.0 (P13V)			11.86	05.94					
	2.0 4WD (P23V)			07.88	10.92					
	2.0 4WD (P23W)			11.86	10.92					
	2.4 (P04V/W/P14V)			11.90	05.94					
	2.4 4WD (P24V)			07.88	05.94					
	2.4 4WD (P24W)			11.86	05.94					
	2.5 D (L039P)			11.88	05.94					
	2.5 D (P05V/W)			11.86	05.94					
	2.5 D (P15V)			11.86	05.94					
2.5 D 4WD(P25W/P25V)			12.87	05.94						
	1.6 (L032P)			11.86	05.94		24.0120-0139.1	420139		256 20,0 18,4 V
	2.5 D (L039P)			11.86	05.94					
	1.6 (P02V)			11.88	05.94		24.0122-0155.1	422155		258 22,0 20,4 V
	1.6 (P12V)			11.88	05.94					
	2.0 (P03V)			11.86	05.94					
	2.0 (P03W)			11.86	05.94					
	2.0 (P13V)			11.86	05.94					
	2.4 (P04V/W/P14V)			11.90	05.94					
	2.5 D (P05V/W)			11.86	05.94					
2.5 D (P15V)			11.86	05.94						
	1.6 (L032P)			11.86	05.94		03.0137-0188.2	650188		254 x 50 Bremsbacken-Zubehör
	1.6 (P02V)			11.88	05.94		03.0137-9105.2	669105		
	1.6 (P12V)			11.88	05.94					
	2.0 (P03V)			11.86	05.94					
	2.0 (P03W)			11.86	05.94					
	2.0 (P13V)			11.86	05.94					
	2.4 (P04V/W/P14V)			11.90	05.94					
	2.5 D (L039P)			11.86	05.94					
	2.5 D (P05V/W)			11.86	05.94					
2.5 D (P15V)			11.86	05.94						
MITSUBISHI LANCER Kombi (85-92)										
	1.5 (C12V)			06.90	05.92	- Option Mod. LKJL6/ LNDL6 ¹⁾	13.0460-5953.2	605953		21650 15,0
	1.8 4x4 (C37V)			06.90	05.92					
	1.8 D (C14V)			06.90	05.92					
	1.5 (C12V)			07.85	05.90	- Option Mod. LKJL6/ LNDL6 ¹⁾	24.0113-0159.1	413159		243 12,7 11,4
	1.5 (C12V)			03.88	05.90	+ Option Mod. LKJL6/ LNDL6 ²⁾	24.0118-0109.1	418109		
	1.8 4x4 (C37V)			11.86	05.90					
	1.8 D (C14V)			07.85	05.90					
	1.5 (C12V)			06.90	05.92	- Option Mod. LKJL6/ LNDL6 ¹⁾	24.0113-0183.1	413183		
	1.5 (C12V)			06.90	05.92	+ Option Mod. LKJL6/ LNDL6 ²⁾	24.0118-0112.1	418112		236 18,0 16,4 V
	1.8 4x4 (C37V)			06.90	05.92					
	1.8 D (C14V)			06.90	05.92					
	1.5 (C12V)			06.90	05.92		03.0137-0289.2	650289		203 x 37 Bremsbacken-Zubehör
	1.8 4x4 (C37V)			06.90	05.92		03.0137-9192.2	669192		
	1.8 D (C14V)			06.90	05.92					
	1.5 (C12V)			07.85	05.92		24.0220-3018.2	480121	ohne Sensorring ³⁾	203/205 x 42,5
	1.8 D (C14V)			07.85	05.92					

1) - option mod. LKJL6/ LNDL6 / - opzione mod. LKJL6/ LNDL6 / - option mod. LKJL6/ LNDL6 / - opción mod. LKJL6/ LNDL6
2) + option mod. LKJL6/ LNDL6 / + opzione mod. LKJL6/ LNDL6 / + option mod. LKJL6/ LNDL6 / + opción mod. LKJL6/ LNDL6
3) without sensor ring / senza sensori / sans secours ABS / sin anillo sensor ABS

										
MITSUBISHI LANCER Kombi (92-96)										
	1.6 16V (CB4W) 2.0 D (CB8W)	83 50	06.92 06.92	09.96 09.96	13.0460-5953.2 13.0460-0233.2	605953 610233		21650 15,0 Belagsatz-Zubehör	SUM SUM	
	1.6 16V 4WD (CD4W)	83	06.92	02.95	13.0460-5952.2 13.0460-0442.2	605952 610442		21647 16,0 +/WK Belagsatz-Zubehör	SUM SUM	
	1.6 16V (CB4W) 2.0 D (CB8W)	83 50	06.92 06.92	09.96 09.96				24.0118-0120.1 418120	236 18,0 16,4 V +B	
	1.6 16V 4WD (CD4W)	83	06.92	02.95				24.0124-0136.1 424136	256 24,0 21,5 V +B	
	1.6 16V (CB4W) 2.0 D (CB8W)	83 50	06.92 06.92	09.96 + ABS 09.96 + ABS	13.0460-5826.2	605826			21872 14,5 +/WK	AKE
	1.6 16V (CB4W) 2.0 D (CB8W)	83 50	06.92 06.92	09.96 + ABS 09.96 + ABS	24.0110-0266.1	410266			236 10,0 8,4	
	1.6 16V (CB4W) 2.0 D (CB8W)	83 50	06.92 06.92	09.96 - ABS 09.96 - ABS	24.3219-1752.3	020505			Rz 19,05	
	1.6 16V 4WD (CD4W)	83	06.92	02.95	24.3219-1716.3	020071			Rz 19,05	
	1.6 16V (CB4W) 2.0 D (CB8W)	83 50	06.92 06.92	09.96 - ABS 09.96 - ABS	03.0137-0289.2 03.0137-9192.2	650289 669192			203 x 37 Bremsbacken-Zubehör	
	1.6 16V 4WD (CD4W)	83	06.92	11.92	03.0137-0288.2	650288			229 x 42	
	1.6 16V (CB4W) 2.0 D (CB8W)	83 50	06.92 06.92	09.96 - ABS 09.96 - ABS	24.0220-3017.1	480108			203/205 x 42	
MITSUBISHI PAJERO (83-91)										
	2.5 TD (L044G) 2.5 TD (L049G) 2.5 TD (L144G) 2.5 TD (L149G) 2.6 (L042G) 2.6 (L047G) 3.0 V6 (L141G) 3.0 V6 (L146G)		05.86 05.86 11.88 11.88 01.83 09.84 11.88 11.88	10.88 05.91 05.91 05.91 10.89 + Option Mod. NJL6/ VNJL6/ VNJR6 1) 10.89 05.91 05.91	13.0460-5940.2 13.0460-0335.2	605940 610335		21373 16,0 +/WK Belagsatz-Zubehör	SUM SUM	
	2.3 TD (L043G) 2.5 TD (L044G) 2.6 (L042G)		01.83 05.86 01.83	04.86 05.87 05.87	24.0120-0130.1	420130			255 20,0 18,4 V	
	2.3 TD (L043G) 2.3 TD (L048G) 2.5 TD (L044G) 2.5 TD (L049G) 2.5 TD (L144G) 2.5 TD (L149G) 2.6 (L042G) 2.6 (L047G) 3.0 V6 (L141G) 3.0 V6 (L146G)		01.83 09.84 05.86 05.86 11.89 11.89 01.83 09.84 11.88 11.88	04.86 04.86 10.89 05.91 05.91 05.91 05.91 05.91 05.91	03.0137-0188.2 03.0137-9105.2	650188 669105			254 x 50 Bremsbacken-Zubehör	
MITSUBISHI SAPPORO (87-90)										
	2.4 (E16A)	91	06.87	06.90	24.0124-0136.1	424136			256 24,0 21,5 V +B	
	2.4 (E16A)	91	06.87	06.90	13.0460-5980.2	605980			21706 15,5 +/WK	AKE
MITSUBISHI SIGMA (90-96)										
	3.0 V6 (F07W) 3.0 V6 (F16A) 3.0 V6 (F16A)	125 130 151	01.93 12.90 12.90	07.96 07.96 07.96	13.0460-0235.2	610235			Belagsatz-Zubehör	
	3.0 V6 (F16A) 3.0 V6 (F16A)	130 151	12.90 12.90	07.91 07.91	24.0124-0144.1	424144			276 24,0 22,4 V	
	3.0 V6 (F07W) 3.0 V6 (F16A) 3.0 V6 (F16A)	125 130 151	01.93 12.90 12.90	07.96 07.96 07.96	13.0460-5980.2	605980			21706 15,5 +/WK	AKE
MITSUBISHI SPACE WAGON/VAN (83-91)										
	1.8 (D05V/W) 1.8 TD (D09V/W) 2.0 (D04W)		10.83 06.86 06.86	04.91 04.91 04.91	24.0118-0109.1	418109			242 18,0 16,4 V	
	2.0 4x4 (D08W)		02.85	04.91	24.0124-0114.1	424114			266 24,0 22,4 V	
	1.8 (D05V/W) 1.8 TD (D09V/W) 2.0 (D04W)		10.83 06.86 06.86	04.91 04.91 04.91	24.0220-3018.2	480121		ohne Sensorring 2)	203/205 x 42,5	
MITSUBISHI TREDIA/CORDIA (82-86)										
	1.4 (A211A) 1.5 (A214A) 1.6 (A212A) 1.8 (A215A)		06.82 06.82 06.82 09.84	08.84 08.84 09.86 09.86	24.0113-0159.1	413159			243 12,7 11,4	
	1.6 Turbo (A212A)		06.82	08.84	24.0118-0109.1	418109			242 18,0 16,4 V	
	1.8 4WD (A215G) 2.0 4WD (A217G)		03.85 03.85	09.86 09.86	24.0124-0114.1	424114			266 24,0 22,4 V	

1) + option mod. NJL6/ VNJL6/ VNJR6 / + opzione mod. NJL6/ VNJL6/ VNJR6 / + option mod. NJL6/ VNJL6/ VNJR6 / + opción mod. NJL6/ VNJL6/ VNJR6

2) without sensor ring / senza sensori / sans secours ABS / sin anillo sensor ABS

										
NISSAN 100 NX (B13) (90-94)										
	1.6			10.90	10.94	24.3481-1726.5	240188	<input type="checkbox"/>	D=48, - Halter	SUM
	1.6			10.90	10.94	13.0460-5941.2 13.0460-0336.2	605941 610336		21659 16,4 +/WK Belagsatz-Zubehör	SUM SUM
	1.6			10.90	10.94	24.0118-0107.1	418107		240 18,0 16,0 V +B	
	2.0 GTI	105		10.90	10.94	24.0126-0112.1	426112		257 26,0 24,0 V	
	2.0 GTI	105		10.90	10.94	13.0460-5983.2	605983		21713 16,5	
	1.6			10.90	10.94 + ABS	24.0107-0108.1	407108		234 7,0 6,0	
	1.6			10.90	10.94 - ABS	24.3215-1107.3	020352		Rz 15,87	
	1.6			10.90	10.94 - ABS	03.0137-0265.2 03.0137-9165.2	650265 669165		180 x 31 Bremsbacken-Zubehör	
	1.6			10.90	10.94 - ABS	24.0218-0025.1	480082		180/181 x 37,5	
	1.6 2.0 GTI	105		10.90 10.90	10.94 + ABS 10.94	24.3727-1711.2	581711	<input type="checkbox"/>	L=1312	
	1.6			10.90	10.94	24.3728-1703.2	591703		L=728	
NISSAN 200 SX/SILVIA (S12) (83-88)										
	1.8 i Turbo 2.0 i	68 107		10.83 10.83	05.88 05.88 + Europa 1)	13.0460-5937.2 13.0460-0322.2	605937 610322		21119 17,0 +/WK Belagsatz-Zubehör	AKE AKE
NISSAN 200 SX (S13) (88-94)										
	1.8 i Turbo	124		09.88	09.91	13.0460-5933.2	605933		21725 16,8 +/WK	AKE
	1.8 i Turbo	124		09.88	09.91	24.0122-0146.1	422146		257 22,0 20,0 V +B	
	1.8 i Turbo	124		10.91	03.94	24.0122-0179.1	422179		280 22,0 20,0 V +B	
NISSAN 240 SX (S13) (USA) (88-93)										
	2.4 i 2.4 i			07.88 09.91	08.91 + ABS 11.93	24.0122-0146.1	422146		257 22,0 20,0 V +B	
NISSAN 300 ZX (Z31) (84-89)										
	3.0 i V6 3.0 i V6 Turbo	125		01.84 01.84	02.87 02.87	13.0460-5937.2 13.0460-0322.2	605937 610322		21119 17,0 +/WK Belagsatz-Zubehör	AKE AKE
NISSAN AXCESS (M11) (USA) (89-94)										
	2.4 i 2.4 i 4WD			01.89 01.89	07.94 07.94	24.0122-0146.1	422146		257 22,0 20,0 V +B	
	2.4 i			01.89	07.94 - Fzg. 7 Sitzplätze 2)	03.0137-0210.2 03.0137-9112.2	650210 669112		229 x 41 Bremsbacken-Zubehör	
NISSAN BLUEBIRD (U11/WU11) (83-90)										
	1.8 1.8 Turbo 2.0 2.0 D 2.0 TD			11.83 11.83 11.83 11.83 11.83	09.89 09.89 09.89 09.89 09.89	13.0460-5937.2 13.0460-0322.2	605937 610322		21119 17,0 +/WK Belagsatz-Zubehör	AKE AKE
	1.8 1.8 Turbo 2.0 2.0 D 2.0 TD			11.83 11.83 11.83 11.83 11.83	05.90 05.90 05.90 05.90 05.90	24.0122-0129.1	422129		250 22,0 20,0 V	
	2.0 2.0 D 2.0 TD			11.83 11.83 11.83	05.90 05.90 05.90	24.3220-1703.3	020391		Rz 20,64	
	1.8 2.0 2.0 D 2.0 TD			02.86 02.86 02.86 02.86	05.90 05.90 05.90 05.90	03.0137-0210.2 03.0137-9112.2	650210 669112		229 x 41 Bremsbacken-Zubehör	

1) + Europe / + Europa / + Europe / + Europa

2) - vehicles with 7 seats / - veicoli con 7 posti a sedere / - vehicules à 7 sièges / - vehiculo con 7 plazas

NISSAN BLUEBIRD (U11/WU11) (83-90)																	
	1.8 2.0 2.0 D 2.0 TD			11.83 11.83 11.83 11.83	05.90 05.90 05.90 05.90			24.0222-8025.2	480109			ohne Sensorring ¹⁾		229/230 x 47			
NISSAN BLUEBIRD (T12) (85-90)																	
	1.6 1.8 i 1.8 i Turbo 2.0 D 2.0 i			12.85 02.88 12.85 12.85 12.85	02.90 11.88 01.89 02.90 02.90	+ Europa ²⁾ + Europa ²⁾ + Europa ²⁾ + Europa ²⁾ + Europa/ + Golf-Staaten ³⁾		13.0460-5937.2 13.0460-0322.2	605937 610322				21119 17,0 +WK Belagsatz-Zubehör			AKE AKE	
	1.6 1.8 i 1.8 i Turbo 2.0 D 2.0 i			12.85 02.88 12.85 12.85 12.85	02.90 02.90 02.90 02.90 02.90	+ Europa ²⁾ + Europa ²⁾ + Europa ²⁾ + Europa ²⁾ + Europa/ + Golf-Staaten ³⁾		24.0122-0129.1	422129				250 22,0 20,0 V				
	1.8 i 2.0 D 2.0 i			02.88 12.85 12.85	02.90 02.90 02.90	+ Europa ²⁾ + Europa ²⁾ + Europa/ + Golf-Staaten ³⁾		24.3220-1703.3	020391				Rz 20,64				
	1.6 1.8 i 2.0 D 2.0 i			12.85 02.88 12.85 12.85	02.90 02.90 02.90 02.90	+ Europa ²⁾ + Europa ²⁾ + Europa ²⁾ + Europa/ + Golf-Staaten ³⁾		03.0137-0210.2 03.0137-9112.2	650210 669112				229 x 41 Bremsbacken-Zubehör				
	1.6 1.8 i 2.0 D 2.0 i			12.85 02.88 12.85 12.85	02.90 02.90 02.90 02.90	+ Europa ²⁾ + Europa ²⁾ + Europa ²⁾ + Europa/ + Golf-Staaten ³⁾		24.0222-8025.2	480109			ohne Sensorring ¹⁾	229/230 x 47				
NISSAN BLUEBIRD (T72) (88-90)																	
	1.6 1.8 i Turbo 2.0 D 2.0 i			09.88 09.88 09.88 09.88	04.90 04.90 04.90 04.90			13.0460-5937.2 13.0460-0322.2	605937 610322				21119 17,0 +WK Belagsatz-Zubehör			AKE AKE	
	1.6 1.8 i 16V 1.8 i Turbo 2.0 D 2.0 i			09.88 02.89 09.88 09.88 09.88	04.90 04.90 04.90 04.90 04.90			24.0122-0129.1	422129				250 22,0 20,0 V				
	1.6 2.0 D 2.0 i			07.89 07.89 07.89	04.90 04.90 04.90			24.3220-1703.3	020391				Rz 20,64				
	1.6 2.0 D 2.0 i			09.88 09.88 09.88	04.90 04.90 04.90			03.0137-0210.2 03.0137-9112.2	650210 669112				229 x 41 Bremsbacken-Zubehör				
	1.6 2.0 D 2.0 i			09.88 09.88 09.88	04.90 04.90 04.90			24.0222-8025.2	480109			ohne Sensorring ¹⁾	229/230 x 47				
NISSAN CHERRY (N12) (82-86)																	
	1.0 1.3 1.5 1.5 Turbo 1.6	37 44 55 77		04.82 04.82 04.82 04.82 06.85	07.86 07.86 07.86 05.84 07.86			13.0460-5963.2	605963				20958 16,0			AKE	
	1.0 1.3 1.5 1.5 Turbo 1.6	37 44 55 77		04.82 04.82 04.82 04.82 06.85	07.86 07.86 07.86 05.84 07.86			24.0112-0115.1	412115				240 12,0 11,0				
NISSAN BLUEBIRD (810) (77-79)																	
	1.8 1.8			10.77 10.77	12.79 12.79	- Europa/ + Limousine ⁴⁾ + Europa/ + Kombiwagen ⁵⁾		24.3220-1703.3	020391				Rz 20,64				
NISSAN LAUREL (C32) (84-90)																	
	2.0 2.4 i 2.8 D 3.0 i V6			11.84 11.84 11.84 03.86	06.90 06.90 06.90 06.90			13.0460-5937.2 13.0460-0322.2	605937 610322				21119 17,0 +WK Belagsatz-Zubehör			AKE AKE	
	2.0 2.4 i 2.8 D			11.84 11.84 11.84	06.90 06.90 06.90			03.0137-0210.2 03.0137-9112.2	650210 669112				229 x 41 Bremsbacken-Zubehör				
NISSAN MAXIMA (J30) (88-94)																	
	3.0 i V6	125		12.88	09.91			24.0122-0174.1	422174				280 22,0 20,0 V				
	3.0 i V6	125		12.88	09.91			24.0110-0244.1	410244				258 10,0 9,0				

































¹⁾ without sensor ring / senza sensori / sans secours ABS / sin anillo sensor ABS





















²⁾ + Europa/ + Europa/ + Europe/ + Europa

³⁾ + Europe/ + Gulf States / + Europa/ + Stati del Golfo / + Europe/ + Etats Golfe Persique / + Europa/ + estad.Golfo Pérsico



























⁴⁾ - Europe/ + Saloon / - Europa/ + Berlina / - Europe/ + Berline / - Europa/ + Berlina





















⁵⁾ + Europe/ + Estate / + Europa/ + Station Wagon / + Europe/ + Break / + Europa/ + Break

											
NISSAN MICRA/MARCH (K10) (82-92)											
	1.0 1.2			12.82 12.82	11.92 11.92		13.0460-5962.2 13.0460-0319.2	605962 610319		20957 16,0 Belagsatz-Zubehör	AKE AKE
	1.0 1.2			12.82 12.82	06.87 06.87		24.0112-0121.1	412121		214 12,0 10,0	
	1.0 1.2			12.88 12.88	11.92 11.92		24.0112-0139.1 24.0115-0106.1	412139 415106		214 12,0 10,0 214 15,0 13,0 V	
	1.0 1.2			12.82 12.82	11.92 11.92		24.3215-1107.3	020352		Rz 15,87	
	1.0 1.2			12.82 12.82	11.92 11.92		03.0137-9111.2	669111		Bremsbacken-Zubehör	
	1.0 1.2			12.82 12.82	11.88 11.88		24.0218-0021.1	480067		180/181 x 31,5	
	1.0 1.2			12.88 12.88	11.92 11.92		24.0218-0022.1	480076		180/181 x 32,5	
NISSAN PATROL (160) (79-88)											
	2.8 3.2 D 3.2 TD 4.0			09.83 09.83 09.83 09.83	08.88 08.88 08.88 08.88		13.0460-5960.2 13.0460-0448.2	605960 610448		20863 16,5 Belagsatz-Zubehör	SUM SUM
	2.8 3.2 D 3.2 TD 4.0			11.79 11.79 11.79 11.79	08.88 08.88 08.88 08.88		24.0120-0119.1	420119		295 20,0 18,0 V	
NISSAN PATROL GR I (Y60) (88-97)											
	2.8 TD 4.2 i	85 121		09.88 10.91	06.97 06.97		13.0460-5960.2 13.0460-0448.2	605960 610448		20863 16,5 Belagsatz-Zubehör	SUM SUM
	2.8 TD 4.2 i	85 121		09.88 10.91	06.97 06.97		24.0120-0119.1	420119		295 20,0 18,0 V	
	2.8 TD 4.2 i	85 121		10.91 10.91	06.97 06.97		24.0118-0136.1	418136		316 18,0 16,0 V	
	2.8 TD	85		09.88	09.91		03.0137-0297.2	650297		270 x 52	
NISSAN PATROL (260) (89-95)											
	2.8 D 2.8 TD 3.0			04.89 04.89 04.89	11.95 11.95 11.95		13.0460-5960.2 13.0460-0448.2	605960 610448		20863 16,5 Belagsatz-Zubehör	SUM SUM
	2.8 D 2.8 TD 3.0			04.89 04.89 04.89	11.95 11.95 11.95		24.0120-0119.1	420119		295 20,0 18,0 V	
NISSAN PICK-UP (720) (79-85)											
	1.6 1.8 2.2 4WD 2.3 D 2.5 D 4WD			01.83 01.83 04.83 01.83 04.83	09.85 09.85 09.85 09.85 09.85		13.0460-5937.2 13.0460-0322.2	605937 610322		21119 17,0 +/WK Belagsatz-Zubehör	AKE AKE
	2.2 4WD 2.5 D 4WD			04.83 04.83	09.85 09.85		24.0122-0180.1	422180		267 22,0 20,0 V	
NISSAN PICK-UP (D21) (85-97)											
	2.0 2.3 D 2.4 i 4WD 2.5 D 2.5 D 4WD			09.85 09.85 03.86 09.87 09.85	08.91 08.88 02.98 02.98 02.98		13.0460-5937.2 13.0460-0322.2	605937 610322		21119 17,0 +/WK Belagsatz-Zubehör	AKE AKE
	2.4 i 4WD 2.5 D 4WD			03.86 09.85	02.98 02.98		24.0122-0180.1	422180		267 22,0 20,0 V	
	2.0 2.4 i 4WD			10.88 10.88	08.91 02.98		03.0137-0310.2 03.0137-9273.2	650310 669273		260 x 52 Bremsbacken-Zubehör	
	2.4 i 4WD			10.88	02.98		03.0137-0319.2 03.0137-9290.2	650319 669290		295 x 52 Bremsbacken-Zubehör	
NISSAN PRAIRIE (M10) (82-88)											
	2.0 i 4x4			01.86	10.88		13.0460-5937.2 13.0460-0322.2	605937 610322		21119 17,0 +/WK Belagsatz-Zubehör	AKE AKE
	2.0 i 4x4			01.86	10.88		24.0122-0129.1	422129		250 22,0 20,0 V	
	2.0 i 4x4			01.86	10.88		03.0137-0210.2 03.0137-9112.2	650210 669112		229 x 41 Bremsbacken-Zubehör	











NISSAN PRAIRIE (M11) (EUROPA) (88-94)										
	2.0 2.0 4x4 2.4 i 2.4 i 4x4	72 72 98 98		10.88 10.88 04.92 04.92	03.92 03.92 07.94 07.94		13.0460-5933.2 605933		21725 16,8 +WK	AKE
	2.0 2.0 4x4	72 72		10.88 10.88	03.92 03.92		24.0122-0146.1 422146		257 22,0 20,0 V +B	
	2.0	72		10.88	03.92		24.3220-1703.3 020391		Rz 20,64	
	2.0 2.0 4x4	72 72		10.88 10.88	03.92 03.92		03.0137-0210.2 650210 03.0137-9112.2 669112		229 x 41 Bremsbacken-Zubehör	
NISSAN PRIMERA (P10E) Limousine (90-96)										
	1.6 1.6 i 2.0 D			06.90 05.93 06.90	01.96 - ABS 01.96 - ABS 04.93		13.0460-5949.2 605949 13.0460-0440.2 610440		21280 16,0 Belagsatz-Zubehör	AKE AKE
	1.6 1.6 i 2.0 D 2.0 i 16V 2.0 i 16V 4x4			05.93 05.93 05.93 06.90 06.90	01.96 + ABS 01.96 + ABS 01.96 01.96 06.96		13.0460-5950.2 605950		21546 16,7	TRW
	1.6 1.6 i 2.0 D			06.90 05.93 06.90	01.96 - ABS 01.96 - ABS 04.93		24.0120-0152.1 420152		242 20,0 18,0 V	
	1.6 1.6 i 2.0 D 2.0 i 16V 2.0 i 16V 4x4			05.93 05.93 05.93 06.90 06.90	01.96 + ABS 01.96 + ABS 01.96 01.96 06.96		24.0122-0146.1 422146		257 22,0 20,0 V +B	
	1.6 1.6 i 2.0 D 2.0 i 16V 2.0 i 16V 4x4			05.93 05.93 05.93 06.90 09.94	01.96 + ABS 01.96 + ABS 01.96 01.96 06.96		24.3344-1701.5 240087 24.3344-1702.5 240088 24.0101-3401.2 260043	<input type="checkbox"/> <input type="checkbox"/>	D=34, - Halter D=34, - Halter Bremsattel-Zubehör	TRW TRW TRW
	1.6 1.6 i 2.0 D 2.0 i 16V 2.0 i 16V 4x4			05.93 05.93 05.93 06.90 06.90	01.96 + ABS 01.96 + ABS 01.96 01.96 06.96		13.0460-5986.2 605986		21545 14,9	TRW
	1.6 1.6 i 2.0 D 2.0 i 16V 2.0 i 16V 4x4			05.93 05.93 05.93 06.90 06.90	01.96 + ABS 01.96 + ABS 01.96 01.96 06.96		24.0110-0215.1 410215		258 10,0 9,0 +B	
	1.6 1.6 i			06.90 05.93	08.94 - ABS 08.94 - ABS		24.3220-1625.3 020377	<input type="checkbox"/>	RzR 20,64	
	1.6 1.6 i 2.0 D			06.90 05.93 06.90	01.96 - ABS 01.96 - ABS 04.93		03.0137-0276.2 650276 03.0137-9181.2 669181		203 x 39 Bremsbacken-Zubehör	
	1.6 1.6 i 2.0 D 2.0 i 16V			05.93 05.93 05.93 06.90	01.96 + ABS 01.96 + ABS 01.96 01.96		24.3727-1709.2 581709 24.3727-1708.2 581708	<input type="checkbox"/> <input type="checkbox"/>	L=1516 L=1491	
	2.0 i 16V			06.90	01.96		24.3728-1706.2 591706		L=717	
NISSAN PULSAR (USA) (83-86)										
	1.6			01.83	12.86		24.0112-0115.1 412115		240 12,0 11,0	
NISSAN SENTRA (USA) (82-86)										
	1.5 1.6			01.82 01.82	12.86 12.86		24.0112-0115.1 412115		240 12,0 11,0	
NISSAN STANZA (T12) (84-86)										
	2.0			12.84	12.86 + Europa ¹⁾		13.0460-5937.2 605937 13.0460-0322.2 610322		21119 17,0 +WK Belagsatz-Zubehör	AKE AKE
	2.0			12.84	12.86 + Europa ¹⁾		24.0122-0129.1 422129		250 22,0 20,0 V	
	2.0			12.84	12.86 + Europa ¹⁾		03.0137-0210.2 650210 03.0137-9112.2 669112		229 x 41 Bremsbacken-Zubehör	

¹⁾ + Europe / + Europa / + Europe / + Europa

								
NISSAN SUNNY (B11) (82-88)								
	1.3 1.5 1.6		03.82 03.82 03.82	05.88 05.88 05.88	13.0460-5963.2	605963		20958 16,0 AKE
	1.3 1.5 1.6		03.82 03.82 03.82	05.88 05.88 05.88	24.0112-0115.1	412115		240 12,0 11,0
NISSAN SUNNY (B12) Coupe (86-90)								
	1.5 1.6		06.86 06.86	09.88 12.90	13.0460-5963.2	605963		20958 16,0 AKE
	1.5 1.6 1.6 i 1.7 D		06.86 06.86 02.87 06.86	09.88 12.90 - DOHC 12.90	24.0112-0123.1	412123		240 12,0 11,0
	1.6 i		02.87	09.88 + DOHC	24.0118-0107.1	418107		240 18,0 16,0 V +B
NISSAN SUNNY (B12) Kombi (86-90)								
	1.5 1.6 i 1.6 i 4x4 1.7 D		06.86 06.86 06.86 06.86	09.88 12.90 12.90 12.90	24.0118-0107.1	418107		240 18,0 16,0 V +B
	1.6 i 4x4		06.86	12.90	03.0137-0210.2 03.0137-9112.2	650210 669112		229 x 41 Bremsbacken-Zubehör
NISSAN SUNNY (B310) (78-82)								
	1.2 1.4 1.5		09.78 09.78 09.78	05.82 05.82 05.82	24.3220-1703.3	020391		Rz 20,64
NISSAN SUNNY (N13) (86-90)								
	1.0 1.3 1.4 1.5 1.6 i		06.86 06.86 10.88 06.86 06.86	12.90 12.90 12.90 09.88 12.90 - DOHC	13.0460-5963.2	605963		20958 16,0 AKE
	1.0 1.3 1.4 1.5 1.6 i		06.86 06.86 10.88 06.86 06.86	12.90 12.90 12.90 09.88 12.90 - DOHC	24.0112-0123.1	412123		240 12,0 11,0
	1.6 i 1.6 i 4x4 1.7 D		02.87 06.86 06.86	09.88 + DOHC 12.90 12.90	24.0118-0107.1	418107		240 18,0 16,0 V +B
	1.4		10.88	12.90	24.0107-0108.1	407108		234 7,0 6,0
	1.6 i 4x4		06.86	12.90	03.0137-0210.2 03.0137-9112.2	650210 669112		229 x 41 Bremsbacken-Zubehör
NISSAN SUNNY (N14) Limousine (90-95)								
	1.4 1.6 16V 1.6 16V 4x4 2.0 D		10.90 10.90 10.90 10.90	05.95 05.95 05.95 05.95	24.3481-1726.5	240188	<input type="checkbox"/>	D=48, - Halter SUM
	1.4 1.6 16V 1.6 16V 4x4 2.0 D		10.90 10.90 10.90 10.90	05.95 05.95 05.95 05.95	13.0460-5941.2 13.0460-0336.2	605941 610336		21659 16,4 +/WK Belagsatz-Zubehör SUM
	1.4 1.6 16V 1.6 16V 4x4 2.0 D		10.90 10.90 10.90 10.90	05.95 05.95 05.95 05.95	24.0118-0107.1	418107		240 18,0 16,0 V +B
	2.0 16V GTI 2.0 GTI R 4x4		10.90 10.90	05.95 05.95	24.0126-0112.1	426112		257 26,0 24,0 V
	1.4 1.6 16V 1.6 16V 4x4 2.0 D		10.90 10.90 10.90 10.90	05.95 + ABS 05.95 + ABS 05.95 + ABS 05.95 + ABS	13.0460-0295.2	610295		Belagsatz-Zubehör
	2.0 16V GTI 2.0 GTI R 4x4		10.90 10.90	05.95 05.95	13.0460-5983.2 13.0460-0295.2	605983 610295		21713 16,5 Belagsatz-Zubehör
	1.4 1.6 16V 1.6 16V 4x4 2.0 D		10.90 10.90 10.90 10.90	05.95 + ABS 05.95 + ABS 05.95 + ABS 05.95 + ABS	24.0107-0108.1	407108		234 7,0 6,0
	1.4 1.6 16V 2.0 D		10.90 10.90 10.90	05.95 - ABS 05.95 - ABS 05.95 - ABS	24.3215-1107.3	020352		Rz 15,87

NISSAN SUNNY (N14) Limousine (90-95)										
	1.4 1.6 16V 2.0 D 1.6 16V 4x4			10.90 10.90 10.90 10.90	05.95 05.95 05.95 05.95	- ABS - ABS - ABS - ABS	03.0137-0265.2 03.0137-9165.2	650265 669165		180 x 31 Bremsbacken-Zubehör
	1.4 1.6 16V 2.0 D			10.90 10.90 10.90	05.95 05.95 05.95	- ABS - ABS - ABS	24.0218-0025.1	480082		229 x 41 Bremsbacken-Zubehör
	1.4 1.6 16V 2.0 D			10.90 10.90 10.90	05.95 05.95 05.95	- ABS - ABS - ABS	24.3727-1701.2	581701	↑	L=250
	1.4 1.6 16V 2.0 16V GTI 2.0 D			10.90 10.90 10.90 10.90	05.95 05.95 05.95 05.95	+ ABS + ABS + ABS + ABS	24.3727-1701.2 24.3727-1711.2	581701 581711	↑ ☐	L=250 L=1312
	1.6 16V 4x4 1.6 16V 4x4 2.0 GTI R 4x4			10.90 10.90 10.90	05.95 05.95 05.95	- ABS + ABS	24.3727-1701.2 24.3727-1701.2	581701 581701	↑ ↑	L=250 L=250
	1.4 1.6 16V 1.6 16V 4x4			10.90 10.90 10.90	04.92 05.95 05.95		24.3728-1703.2	591703		L=728
NISSAN TERRANO I (WD21) (87-97)										
	2.4 i 4WD 2.7 TD 4WD 3.0 i V6 4WD	76 73 109		08.87 08.87 01.90	10.93 10.93 09.97		13.0460-5957.2 13.0460-0289.2	605957 610289		21347 17,0 +/WK Belagsatz-Zubehör
	2.4 i 4WD 2.7 TD 4WD 3.0 i V6 4WD	76 73 109		08.87 08.87 01.90	10.93 10.93 09.97		24.0126-0109.1	426109		277 26,0 24,0 V + B
	2.4 i 4WD 2.7 TD 4WD	76 73		08.87 08.87	10.93 10.93		03.0137-0310.2 03.0137-9273.2	650310 669273		260 x 52 Bremsbacken-Zubehör
NISSAN URVAN (E24) (87-97)										
	2.0 2.3 TD 2.4 2.5 TD			02.87 02.87 05.89 01.89	05.97 12.88 05.97 05.97		13.0460-5957.2	605957		21347 17,0 +/WK AKE
	2.0 2.3 TD 2.4 2.5 TD			02.87 02.87 05.89 01.89	05.97 12.88 05.97 05.97		03.0137-0310.2 03.0137-9273.2	650310 669273		260 x 52 Bremsbacken-Zubehör
NISSAN VANETTE (C220) (87-95)										
	1.5 2.0 D			04.87 04.87	01.95 01.95		13.0460-5937.2 13.0460-0322.2	605937 610322		21119 17,0 +/WK Belagsatz-Zubehör AKE AKE
	1.5 2.0 D			04.87 04.87	01.95 01.95		24.0122-0167.1	422167		250 22,0 20,0 V
	1.5 2.0 D			04.87 04.87	01.95 01.95		24.3220-1703.3	020391		Rz 20,64
NISSAN VANETTE Bus (GC22) (86-95)										
	2.0 2.0 D 2.4 i			10.86 10.86 10.86	05.87 05.87 05.87		13.0460-5957.2	605957		21347 17,0 +/WK AKE
	2.0 2.0 D 2.4 i			10.86 10.86 10.86	12.95 12.95 12.95		03.0137-0310.2 03.0137-9273.2	650310 669273		260 x 52 Bremsbacken-Zubehör
NISSAN VANETTE Kasten (GC22) (87-95)										
	1.5 2.0 D			07.87 07.87	01.95 01.95		13.0460-5937.2 13.0460-0322.2	605937 610322		21119 17,0 +/WK Belagsatz-Zubehör AKE AKE
	1.5 2.0 D			07.87 07.87	01.95 01.95		24.0122-0167.1	422167		250 22,0 20,0 V
	1.5 2.0 D			07.87 07.87	01.95 01.95	- Fenster ¹⁾ - Fenster ¹⁾	03.0137-0210.2 03.0137-9112.2	650210 669112		229 x 41 Bremsbacken-Zubehör
	1.5 2.0 D			07.87 07.87	01.95 01.95	+ Fenster ²⁾ + Fenster ²⁾	03.0137-0310.2 03.0137-9273.2	650310 669273		260 x 52 Bremsbacken-Zubehör
NISSAN VIOLET/140J/160J (A10) (77-81)										
	1.4 1.6			06.77 06.77	05.81 05.81		24.3220-1703.3	020391		Rz 20,64

1) - window / - finestrino / - fenêtre / - ventana
2) + window / + finestrino / + fenêtre / + ventana

											
NSU PRINZ 4 (61-71)											
	600			01.66	11.71	+ VA-Scheibenbremse ¹⁾	03.3115-2651.3	010250	Hz 15,87	ATE	
	600			01.66	11.71		13.0441-3801.2	250058	Dichtungssatz	ATE	
	600			01.66	11.71		13.0460-3010.2	603010	20009 15,0	ATE	
							13.0460-0014.2	610014	Belagsatz-Zubehör	ATE	
	600			08.61	11.71		03.3219-0203.3	020037	Rz 19,05		
	600			01.66	11.71	+ VA-Scheibenbremse ¹⁾	03.3215-0221.3	020013	Rz 15,87		
NSU RO 80 (67-77)											
	1.0			10.67	07.77		13.0441-4005.2	250075	Dichtungssatz	ATE	
	1.0			10.67	07.77		83.7704-0320.3	330851	2	L=320	
	1.0			10.67	07.77		13.0441-3801.2	250058	Dichtungssatz	ATE	
NSU TT/TTS (65-71)											
	1000 TTS 1200 TT			01.70 07.65	11.71 11.71		13.0441-3801.2	250058	Dichtungssatz	ATE	
	1000 TTS 1200 TT			01.70 07.65	11.71 11.71		03.3215-0221.3	020013	Rz 15,87		
NSU 1000/1200 (63-72)											
	1000			01.68	12.72		03.3115-2651.3	010250	Hz 15,87	ATE	
	1000 1200			01.66 09.67	12.72 11.71		13.0441-3801.2	250058	Dichtungssatz	ATE	
	1000 1200			01.66 09.67	12.72 11.71		13.0460-3010.2	603010	20009 15,0	ATE	
							13.0460-0014.2	610014	Belagsatz-Zubehör	ATE	
	1000			08.63	12.67		03.3217-0401.3	020023	Rz 17,46		
	1000 1200			08.63 09.67	12.72 11.71		03.3215-0221.3	020013	Rz 15,87		
							03.3219-0203.3	020037	Rz 19,05		
OPEL ADMIRAL (64-78)											
	Admiral A 2.6 / 2.8 Admiral A 4.6 V8 Admiral B	140		04.64 04.65 01.69	03.69 03.69 01.78		13.0460-6027.2	606027	20011 15,0	ATE	
	Admiral B Admiral A 4.6 V8 Admiral B	140		01.69 04.65 01.69	01.78 03.69 01.78		24.0122-0109.1	422109	271 22,0 19,0 V		
							24.0113-0126.1	413126	271 12,7 9,7		
	Admiral B			01.69	01.78		13.0460-4033.2	604033	20034 15,0	ATE	
OPEL ASCONA 16 (70-75)											
	1.2 1.2 1.6 1.6 1.6 N 1.6 N 1.6 S 1.6 S 1.9 1.9	◀ ◀ ◀ ◀ ◀ ◀ ◀ ◀ ◀ ◀	2761365 9662825 2761365 9662825 2761365 9662825 2761365 9662825 2761365 9662825		09.75 09.75 09.75 09.75 09.75 09.75 09.75 09.75 09.75 09.75		03.2120-1981.3	010105	+ Behälter ²⁾	Thz 20,64	DEL
	1.2 1.6 1.6 N 1.6 S 1.9			01.70 01.70 01.70 01.70 01.70	09.75 09.75 09.75 09.75 09.75		13.0460-4035.2	604035	20173 15,0	ATE	
							13.0460-0038.2	610038	Belagsatz-Zubehör	ATE	
	1.2 1.6 1.6 N 1.6 S		52512050 52512050 52512050 52512050	01.70 01.70 01.70 01.70			24.0111-0116.1	411116	238 11,0 8,0		
	↓										

¹⁾ + FA disc brake / + A disco freno / + frein à disque essieu AV / + ED disco de freno

²⁾ + reservoir / + serbatoio / + réservoir / + recipiente

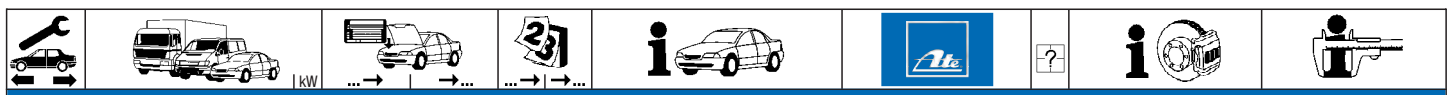

OPEL ASCONA 16 (70-75)

	1.9		52512051	52512050	01.70			24.0111-0116.1	411116		238 11,0 8,0
	1.2		52512051			09.75		24.0113-0125.1	413125		246 12,7 9,7
	1.6		52512051			09.75					
	1.6 N		52512051			09.75					
	1.6 S		52512051			09.75					
	1.9		52512051			09.75					
	1.6 N			9483907	01.70			03.3215-1701.3	020015		Rz 15,87
	1.6 N			2453080	01.70						
	1.6 S			9662824	01.70			03.3215-1701.3	020015		Rz 15,87
	1.6 S			2761436	01.70						
	1.9			9662824	01.70						
	1.9			2761436	01.70						
	1.6 S		2761437			09.75		03.3219-4202.3	020050		Rz 19,05
	1.6 S		9662825			09.75					
	1.9		2761437			09.75					
	1.9		9662825			09.75					
	1.6 N			2453080	01.70			03.0137-0108.2	650108		230 x 51 HEB
	1.6 S		2560700			09.75		03.0137-9014.2	669014		Bremsbacken-Zubehör
	1.9				01.70						
	1.2				01.70	09.75		24.0220-0001.2	480013		200/201 x 53,5
	1.6 N			2453080	01.70			24.0223-0008.2	480038		230/231 x 60
	1.6 S				01.70	09.75					
	1.9				01.70	09.75					
	1.6 N		2453081			09.75		24.0220-0001.2	480013		200/201 x 53,5

OPEL ASCONA B / Vauxhall Cavalier (75-81)











	1.2	◀			10.74	02.79		03.2120-1981.3	010105	+ Behälter ¹⁾	Thz 20,64	DEL
	1.3	◀			10.74	07.81						
	1.6	◀			10.74	07.81						
	1.9	◀			10.74	12.77						
	2.0	◀			10.74	07.81						
	2.0 D	◀			10.74	07.81						
	1.2	▶	81000438		02.79			03.2120-0538.3	010077		Thz 20,64	ATE
	1.2	▶	85000001		02.79							
	1.3	▶	81000438		07.81							
	1.3	▶	85000001		07.81							
	1.6	▶	81000438		07.81							
	1.6	▶	85000001		07.81							
	2.0	▶	81000438		07.81							
	2.0	▶	85000001		07.81							
	2.0 D	▶	81000438		07.81							
	2.0 D	▶	85000001		07.81							
	1.2	◀			10.76	12.77		03.3508-7504.3	310045		Behälter	ATE
	1.3	◀			10.76	12.77						
	1.6	◀			10.76	12.77						
	1.9	◀			10.76	12.77						
	1.2				10.74	02.79	+ Festsättel ²⁾	13.0441-4825.2	250107		Dichtungssatz	ATE
	1.3				10.74	07.81	+ Festsättel ²⁾					
	1.6				10.74	07.81	+ Festsättel ²⁾					
	1.9				10.74	12.77	+ Festsättel ²⁾					
	2.0				01.78	07.81						
	2.0 D				09.78	07.81						
	1.3				03.79	07.81	+ Faustsättel ³⁾	24.0101-4801.2	990131		Bremssattel-Zubehör	DEL
	1.6				03.79	07.81	+ Faustsättel ³⁾					
	2.0				03.79	07.81	+ Faustsättel ³⁾					
	2.0 D				03.79	07.81	+ Faustsättel ³⁾					
	1.2				10.74	02.79	+ Festsättel ²⁾	13.0460-5030.2	605030		20323 16,5	ATE
	1.3				10.74	07.81	+ Festsättel ²⁾					
	1.6				10.74	07.81	+ Festsättel ²⁾					
	1.9				10.74	12.77	+ Festsättel ²⁾					
	2.0				01.78	07.81	+ Festsättel ²⁾					
	2.0 D				09.78	07.81	+ Festsättel ²⁾					
	1.3				03.79	07.81	+ Faustsättel ³⁾	13.0460-7048.2	607048		20939 15,8 /WE	DEL
	1.6				03.79	07.81	+ Faustsättel ³⁾	13.0460-0127.2	610127		Belagsatz-Zubehör	DEL
	2.0				03.79	07.81	+ Faustsättel ³⁾					
	2.0 D				03.79	07.81	+ Faustsättel ³⁾					
	1.2				10.74	02.79		24.0113-0125.1	413125		246 12,7 9,7	
	1.3				10.74	07.81						
	1.6				10.74	07.81						
	1.9				10.74	12.77						
	2.0				01.78	07.81						
	2.0 D				09.78	07.81						
	1.3 S				03.79	07.81		03.3219-4202.3	020050		Rz 19,05	
	1.6 N				10.74	07.81	+ Automatikgetriebe ⁴⁾					
	1.6 S				10.74	07.81						
	1.9				10.74	12.77						
	2.0				01.78	07.81						
	2.0 D				09.78	07.81						
	1.3 S				03.79	07.81		03.0137-0108.2	650108		230 x 51 HEB	
	1.6 N				10.74	07.81	+ Automatikgetriebe ⁴⁾	03.0137-9014.2	669014		Bremsbacken-Zubehör	
	1.6 S				10.74	07.81						
	1.9				10.74	12.77						
	2.0				01.78	07.81						
	2.0 D				09.78	07.81						

1) + reservoir / + serbatoio / + réservoir / + recipiente

2) + fixed calipers / + pinza freno fissa / + étriers fixes / + pinza de fija

3) + fist type calipers / + pinza freno flottante / + étriers à griffe / + pinza de puno

4) + autom.transmission / + scatola cambio automatico / + transmission automatique / + cambio automático

OPEL ASCONA B / Vauxhall Cavalier (75-81)											
	1.2			10.74	02.79	24.0220-0001.2	480013		200/201 x 53,5		
	1.3 N			10.74	07.81						
	1.6 N			10.74	07.81						
	1.3 S			03.79	07.81	24.0223-0008.2	480038		230/231 x 60		
	1.6 N			10.74	07.81						
	1.6 S			10.74	07.81						
	1.9			10.74	12.77						
2.0			01.78	07.81							
2.0 D			09.78	07.81							
OPEL ASCONA C / Vauxhall Cavalier (82-88)											
	1.3		G1000071	08.81		03.2120-2598.3	010116		Thz 20,64	ATE	
	1.3		F5000000	08.81							
	1.6		G1000071	08.81							
	1.6		F5000000	08.81							
	1.6 D		G1000071	01.82							
	1.6 D		F5000000	01.82							
	1.3		G1000072	08.88		03.2120-2597.3	010115		Thz 20,64	ATE	
	1.6		G1000072	08.88							
	1.6 D		G1000072	08.88							
	1.8		G1000072	08.88							
	2.0		G1000072	08.88							
	2.0		G1000072	08.88							
	1.3		G6000000	08.81		03.2120-2598.3	010116		Thz 20,64	ATE	
	1.3		F6000000	08.81							
	1.6		G6000000	08.81							
	1.6		F6000000	08.81							
	1.6 D		G6000000	01.82							
	1.6 D		F6000000	01.82							
	1.3		G6000001	08.88		03.2120-2597.3	010115		Thz 20,64	ATE	
	1.6		G6000001	08.88							
	1.6 D		G6000001	08.88							
	1.8		G6000001	08.88							
	2.0		G6000001	08.88							
	2.0		G6000001	08.88							
	1.3			08.81	08.88	03.2120-2381.3	010111		2 links M10/ 2 unten links M15 ³⁾	Thz 20,64 + Behälter	DEL
	1.6			08.81	08.88						
	1.6 D			01.82	08.88						
	1.8 i			09.82	08.88						
	1.8			08.81	08.88						
	1.6			08.81	08.88						
	1.3			08.81	08.88	24.3481-0707.5	240023		D=48, - Halter	DEL	
	1.6			08.81	08.88	24.3481-0708.5	240024		D=48, - Halter	DEL	
	1.6 D			01.82	08.88	11.0441-4803.2	250018		Dichtungssatz	ATE	
	1.8			09.82	08.88	11.0101-4802.2	260007		Hülzensatz	ATE	
	1.8 i NE			09.82	08.88	24.0101-4801.2	990131		Bremssattel-Zubehör	DEL	
	1.8 i			09.82	08.88						
	1.8 i NE			09.82	08.88						
	2.0 i N			10.87	08.88						
	2.0 i S			10.87	08.88	24.3521-1701.5	240001		D=52, - Halter	ATE	
	2.0 i S			10.87	08.88	24.3521-1702.5	240002		D=52, - Halter	ATE	
	1.3			08.81	08.88	13.0460-7048.2	607048		20939 15,8 /WE	DEL	
	1.6			08.81	08.88	13.0460-0127.2	610127		Belagsatz-Zubehör	DEL	
	1.6 D			01.82	08.88						
	1.8			09.82	08.88						
	1.8 i			09.82	08.88						
	2.0 i N			09.82	08.88	13.0460-7048.2	607048		20939 15,8 /WE	DEL	
	2.0 i N			10.87	08.88	13.0460-0205.2	610205		Belagsatz-Zubehör	DEL	
	2.0 i S			10.87	08.88	13.0460-7052.2	607052		21190 17,5 +/WE	ATE	
	2.0 i S			10.87	08.88	13.0460-7048.2	607048		20939 15,8 /WE	DEL	
	2.0 i S			10.87	08.88	13.0460-0205.2	610205		Belagsatz-Zubehör	DEL	
	1.3			08.81	08.88	24.0113-0161.1	413161		236 12,7 9,7 +S +B		
	1.6			08.81	08.88	24.0313-0161.1	513161		236 12,7 9,7 +S +B PD		
	1.6 D			01.82	08.88						
	1.8			09.82	08.88						
	1.8 i			09.82	08.88						
	2.0 i N			08.81	08.88	24.0120-0115.1	420115		236 20,0 17,0 V L +S +B		
	1.3		FV199999	08.81		83.6288-0314.3	330338	2	Bördel E ⁶⁾	L=310	
	1.6		FV199999	08.81							
	1.6 D		FV199999	01.82							
	1.8		FV199999	09.82							
	1.8 i		FV199999	08.88							
	2.0		FV199999	08.81							
	1.3		G6000001	08.88		24.5298-0322.3	331314	2	Bördel F ⁷⁾	L=322	
	1.6		G6000001	08.88							
	1.6 D		G6000001	08.88							
	1.8		G6000001	08.88							
	1.8 i		G6000001	08.88							
	2.0		G6000001	08.88							
	1.3		G1000071	08.81		83.6267-0195.3	330737	2	Bördel E ⁶⁾	L=195	
	1.6		G1000071	08.81							
	1.6 D		G1000071	01.82							
	1.8		G1000071	09.82							
	2.0		G1000071	08.81							
	2.0		G1000071	08.81							

1) + manual transmission / + scatola cambio velocità / + transmission mécanique / + cambio de velocidad
2) + autom.transmission / + scatola cambio automatico / + transmission automatique / + cambio automático
3) 2 left M10/ 2 lower left M15 / 2 sinist.M10/2 sinis.basso M15 / 2 gauch.M10/2 gauche.,e.bas M15 / 2 izqui.M10/2 izquie.abajo M15
4) - ventilated discs / - dischi ventilati / - disques ventilés / - disco ventilado
5) + ventilated discs / + dischi ventilati / + disques ventilés / + disco ventilado
6) flare type E / bordatura tipo E / colet E / reborde E
7) flare type F / bordatura tipo F / colet F / reborde F





OPEL ASCONA C / Vauxhall Cavalier (82-88)

	1.3	◀	G1000072		08.88	24.5233-0200.3	330425	2	Bördel F ¹⁾	L=198
	1.6	◀	G1000072		08.88					
	1.6 D	◀	G1000072		08.88					
	1.8	◀	G1000072		08.88					
	2.0	◀	G1000072		08.88					
	1.3	◀	G6000000	08.81		83.6267-0195.3	330737	2	Bördel E ²⁾	L=195
	1.6	◀	G6000000	08.81						
	1.6 D	◀	G6000000	01.82						
	1.8	◀	G6000000	09.82						
	2.0	◀	G6000000	08.81						
	1.3	◀	G6000001		08.88	24.5233-0200.3	330425	2	Bördel F ¹⁾	L=198
	1.6	◀	G6000001		08.88					
	1.6 D	◀	G6000001		08.88					
	1.8	◀	G6000001		08.88					
	2.0	◀	G6000001		08.88					
	1.3	◀	G1001771	08.81		24.3217-1102.3	020168			Rz 17,46 TRW
	1.6	◀	G1001771	08.81						
	1.6 D	◀	G1001771	01.82						
	1.8	◀	G1001771	01.82						
	2.0 i N	◀	G1001771	08.81						
	1.3	◀	G1001772		08.88	03.3217-3512.3	020032			Rz 17,46 TRW
	1.6	◀	G1001772		08.88					
	1.6 D	◀	G1001772		08.88					
	1.8	◀	G1001772		08.88					
	2.0 i N	◀	G1001772		08.88					
	1.3	◀	G6000000	08.81		24.3217-1102.3	020168			Rz 17,46 TRW
	1.6	◀	G6000000	08.81						
	1.6 D	◀	G6000000	01.82						
	1.8	◀	G6000000	01.82						
	2.0 i N	◀	G6000000	08.81						
	1.3	◀	G6000001		08.88	03.3217-3512.3	020032			Rz 17,46 TRW
	1.6	◀	G6000001		08.88					
	1.6 D	◀	G6000001		08.88					
	1.8	◀	G6000001		08.88					
	2.0 i N	◀	G6000001		08.88					
	2.0 i S	◀		10.87	08.88	24.3219-1767.3	020552		+ GG ³⁾	Rz 19,05
						24.3219-1715.3	020122		+ ALU ⁴⁾	Rz 19,05 (ALU)
	1.3	◀	E6005529	08.81		03.0137-9034.2	669034			Bremsbacken-Zubehör
	1.3	◀	E5008740	08.81						
	1.3	◀	D1288027	08.81						
	1.6	◀	E6005529	08.81						
	1.6	◀	E5008740	08.81						
	1.6	◀	D1288027	08.81						
	1.6 D	◀	E6005529	01.82						
	1.6 D	◀	E5008740	01.82						
	1.6 D	◀	D1288027	01.82						
	1.8	◀	E6005529	09.82						
	1.8	◀	E5008740	09.82						
	1.8	◀	D1288027	09.82						
	2.0	◀	E6005529	08.81						
	2.0	◀	E5008740	08.81						
	2.0	◀	D1288027	08.81						
	1.3	◀	D1288028		08.88	03.0137-0166.2	650166			200 x 46 HEB TRW
	1.3	◀	E5008741		08.88	03.0137-9060.2	669060			Bremsbacken-Zubehör TRW
	1.3	◀	E6005530		08.88					
	1.6	◀	D1288028		08.88					
1.6	◀	E5008741		08.88						
1.6	◀	E6005530		08.88						
1.6 D	◀	D1288028		08.88						
1.6 D	◀	E5008741		08.88						
1.6 D	◀	E6005530		08.88						
1.8	◀	D1288028		08.88						
1.8	◀	E5008741		08.88						
1.8	◀	E6005530		08.88						
2.0	◀	D1288028		08.88						
2.0	◀	E5008741		08.88						
2.0	◀	E6005530		08.88						
	1.3	◀		08.81	08.88	24.0220-0001.2	480013			200/201 x 53,5
	1.6	◀		08.81	08.88					
	1.6 D	◀		01.82	08.88					
	1.8	◀		09.82	08.88					
	2.0	◀		08.81	08.88					
	1.3	◀	EV111690	08.81		24.3727-0711.2	580711		<input type="checkbox"/>	L=862, + Zub
	1.3	◀	E6005529	08.81		24.3727-0712.2	580712		<input type="checkbox"/>	L=2022, + Zub
	1.3	◀	E5008740	08.81						
	1.3	◀	D1288027	08.81						
	1.6	◀	EV111690	08.81						
	1.6	◀	E6005529	08.81						
	1.6	◀	E5008740	08.81						
	1.6	◀	D1288027	08.81						
	1.6 D	◀	EV111690	01.82						
	1.6 D	◀	E6005529	01.82						
	1.6 D	◀	E5008740	01.82						
1.6 D	◀	D1288027	01.82							

1) flare type F / bordatura tipo F / colet F / reborde F
 2) flare type E / bordatura tipo E / colet E / reborde E
 3) + cast iron / + ghisa / + fonte grise / + fundición de gris
 4) + aluminium / + alluminio / + aluminium / + aluminio

OPEL ASCONA C / Vauxhall Cavalier (82-88)										
	2.0			EV111690	08.81		24.3727-0711.2	580711	<input type="checkbox"/>	L=862, + Zub
	2.0			E6005529	08.81		24.3727-0712.2	580712	<input type="checkbox"/>	L=2022, + Zub
	2.0			E5008740	08.81					
	2.0			D1288027	08.81					
	1.3		E6005530	G6000000			24.3727-0723.2	580723	<input type="checkbox"/>	L=850, + Zub
	1.3		D1288028	G1000071						
	1.3		E5008741		08.88					
	1.3		EV111691		08.88					
	1.6		E6005530	G6000000						
	1.6		D1288028	G1000071						
	1.6		E5008741		08.88					
	1.6		EV111691		08.88					
	1.6 D		E6005530	G6000000						
	1.6 D		D1288028	G1000071						
	1.6 D		E5008741		08.88					
	1.6 D		EV111691		08.88					
	1.8			G6000000	09.82					
1.8			G1000071	09.82						
2.0		E6005530	G6000000							
2.0		D1288028	G1000071							
2.0		E5008741		08.88						
2.0		EV111691		08.88						
1.3			G1000072		08.88	24.3727-0734.2	580734	<input type="checkbox"/>	L=750, + Zub	
1.3			G6000001		08.88	24.3727-0727.2	580727	<input type="checkbox"/>	L=2023, + Zub	
1.6			G1000072		08.88					
1.6			G6000001		08.88					
1.6 D			G1000072		08.88					
1.6 D			G6000001		08.88					
1.8			G1000072		08.88					
1.8			G6000001		08.88					
2.0			G1000072		08.88					
2.0			G6000001		08.88					
1.3				08.81	08.88	24.3728-0708.2	590708		L=795	
1.6				08.81	08.88					
1.6 D				01.82	08.88					
1.8				09.82	08.88					
2.0				08.81	08.88					

OPEL CALIBRA / Vauxhall Calibra (89-97)											
	2.0				09.89	07.97	03.2122-0282.3	010130		Thz 22,20	ATE
	2.0 16V				09.89	07.97					
	2.0 16V 4x4				09.89	07.97					
	2.0 4x4				09.89	07.97					
	2.0 Turbo				03.92	07.97	03.2123-1121.3	010176		Thz 23,81	ATE
	2.5				02.93	07.97					
	2.0				09.89	07.97	24.3521-1701.5	240001	<input type="checkbox"/>	D=52, - Halter	ATE
	2.0 16V				09.89	07.97	24.3521-1702.5	240002	<input type="checkbox"/>	D=52, - Halter	ATE
							11.0441-5202.2	250026		Dichtungssatz	ATE
							11.0101-5407.2	260011		Hülssensatz	ATE
							11.8171-0008.1	990049		Führungsbolzen	ATE
	2.0 16V 4x4				09.89	07.97	11.0441-5402.2	250028		Dichtungssatz	ATE
	2.0 4x4				09.89	07.97	11.0101-5407.2	260011		Hülssensatz	ATE
							11.8171-0008.1	990049		Führungsbolzen	ATE
							11.8116-0097.1	390590	2	Haltefeder	ATE
	2.0 Turbo			S9999999	03.92		24.3541-8086.5	240526	<input type="checkbox"/>	D=54, - Halter	ATE
	2.5			S9999999	02.93		24.3541-8085.5	240525	<input type="checkbox"/>	D=54, - Halter	ATE
						11.0101-5407.2	260011		Hülssensatz	ATE	
						11.8171-0008.1	990049		Führungsbolzen	ATE	
						11.8116-0292.1	390521	2	Haltefeder	ATE	
2.0 Turbo		T1000001			07.97	24.3571-1761.5	240461	<input type="checkbox"/>	D=57, - Halter	ATE	
2.5		T1000001			07.97	24.3571-1762.5	240462	<input type="checkbox"/>	D=57, - Halter	ATE	
						11.0101-5407.2	260011		Hülssensatz	ATE	
						11.8171-0008.1	990049		Führungsbolzen	ATE	
						11.8116-0292.1	390521	2	Haltefeder	ATE	
	2.0				09.89	07.97	13.0460-7052.2	607052		21190 17,5 +/WE	ATE
	2.0 16V				09.89	07.97	24.8190-0705.2	620705	2	Warnkontakt L=670mm	
	2.0 16V 4x4				09.89	07.97					
	2.0 4x4				09.89	07.97					
	2.0 Turbo			S9999999	03.92		13.0460-7080.2	607080		21411 17,5 +	ATE
	2.5			S9999999	02.93		24.8190-0707.2	620707	2	Warnkontakt L=685mm	
	2.0 Turbo			T1000001		07.97	13.0460-7091.2	607091		21829 20,3 +/WE	ATE
	2.5			T1000001		07.97	24.8190-0713.2	620713	2	Warnkontakt L=685mm	
	2.0				09.89	07.97	24.0124-0115.1	424115		256 24,0 21,0 V L +S +B	
	2.0 16V				09.89	07.97	24.0324-0115.1	524115		256 24,0 21,0 V L +S +B PD	
	2.0 16V 4x4				09.89	07.97					
	2.0 4x4				09.89	07.97					
	2.0 Turbo			S9999999	03.92		24.0124-0133.1	424133		284 24,0 21,0 V L	
	2.5			S9999999	02.93						
	2.0 Turbo			T1000001		07.97	24.0125-0119.1	425119		288 25,0 22,0 V L +S +B	
	2.5			T1000001		07.97	24.0325-0119.1	525119		288 25,0 22,0 V L +S +B PD	
	2.0				09.89	07.97	24.5298-0322.3	331314	2	L=322	
	2.0 16V				09.89	07.97					
	2.0 16V 4x4				09.89	07.97					
	2.0 4x4				09.89	07.97					
	2.0 Turbo				03.92	07.97					
2.5				02.93	07.97						





OPEL CALIBRA / Vauxhall Calibra (89-97)

	2.0			09.89	07.97	13.2351-0013.2	210010		D=35	ATE	
	2.0 16V			09.89	07.97	13.2351-0014.2	210011		D=35	ATE	
	2.5		S9999999	02.93		24.9235-0013.5	230001		D=35	ATE	
						24.9235-0014.5	230002		D=35	ATE	
						13.0441-3506.2	250052		Dichtungssatz	ATE	
	2.5	T1000001		07.97		13.0441-3506.2	250052		Dichtungssatz	ATE	
	2.0 16V 4x4	T1000001		07.97		13.2351-0013.2	210010		D=35	ATE	
	2.0 4x4	T1000001		07.97		13.2351-0014.2	210011		D=35	ATE	
	2.0 Turbo	T1000001		07.97		24.9235-0013.5	230001		D=35	ATE	
						24.9235-0014.5	230002		D=35	ATE	
						13.0441-3506.2	250052		Dichtungssatz	ATE	
	2.0			09.89	07.97	13.0460-4043.2	604043		21140 15,0	ATE	
	2.0 16V			09.89	07.97	13.0460-0217.2	610217		Belagsatz-Zubehör	ATE	
	2.0 16V 4x4			09.89	07.97						
	2.0 4x4			09.89	07.97						
	2.0 Turbo			03.92	07.97						
	2.5		S9999999	02.93							
	2.5	T1000001		07.97		13.0460-4040.2	604040		21050 15,8	ATE	
						13.0460-0347.2	610347		Belagsatz-Zubehör		
	2.0			09.89	07.97						
	2.0 16V			09.89	07.97						
	2.0 16V 4x4			09.89	07.97						
	2.0 4x4			09.89	07.97						
	2.0 Turbo			03.92	07.97						
	2.5			02.93	07.97	24.0110-0205.1	410205		270 9,9 8,0 +B		
	2.0		N1999999	09.89							
	2.0 16V		N1999999	09.89		24.5233-0200.3	330425	2	L=198		
	2.0 16V 4x4		N1999999	09.89							
	2.0 4x4		N1999999	09.89							
	2.0 Turbo		N1999999	03.92							
	2.0	P1000001		07.97		24.5117-0195.3	330565	2	L=198		
	2.0 16V	P1000001		07.97							
	2.0 16V 4x4	P1000001		07.97							
	2.0 4x4	P1000001		07.97							
	2.0 Turbo	P1000001		07.97							
	2.5			02.93	07.97						
	2.0			09.89	07.97	03.0137-0172.2	650172		160 x 25		
	2.0 16V			09.89	07.97	03.0137-9092.2	669092		Bremsbacken-Zubehör		
	2.0 16V 4x4			09.89	07.97						
	2.0 4x4			09.89	07.97						
	2.0 Turbo			03.92	07.97						
	2.5			02.93	07.97	03.0137-0172.2	650172		160 x 25		
						03.0137-9243.2	669243		Bremsbacken-Zubehör		
	2.0			09.89	07.97						
	2.0 16V			09.89	07.97	24.3727-0736.2	580736	1	L=1365/1498, + Zub		
	2.0 16V 4x4			09.89	07.97						
	2.0 4x4			09.89	07.97						
	2.0 Turbo			03.92	07.97						
	2.5			02.93	07.97						
	2.0	P1000001		07.97		03.0101-0038.2	320245		BRES 4/5	ATE	
	2.0 16V	P1000001		07.97							
	2.0 16V 4x4	P1000001		07.97							
	2.0 4x4	P1000001		07.97							
	2.5	T1000001		07.97		03.0101-0038.2	320245		BRES 4/5	ATE	
	2.0		S9999999	09.89		24.3728-0715.2	590715		L=835		
	2.0 16V		S9999999	09.89							
	2.0 16V 4x4		S9999999	09.89							
	2.0 4x4		S9999999	09.89							
	2.5		S9999999	02.93							
DIV	2.0 16V 4x4			09.89	07.97	10.0515-0515.3	340024		+ Verteilergetriebe ¹⁾	Hydraulikspeicher	ATE
	2.0 4x4			09.89	07.97						
	2.0 Turbo			03.92	07.97						

OPEL CAMPO (91-96)

	2.2 D			01.92	09.92	03.2120-1981.3	010105		THz 20,64	DEL
	2.2 D 4x4			09.90	09.92					
	2.3			01.92	09.92					
	2.3 4x4			06.90	09.92					
	2.5 D			01.92	09.92					
	2.5 D 4x4			06.90	09.92					
	2.5 TD			07.94	08.96					
	3.1 TD			01.92	09.92					
	2.2 D			01.92	08.96	13.0460-5942.2	605942		21544 16,5 +/WK	AKE
	2.2 D 4x4			09.90	08.96	13.0460-0337.2	610337		Belagsatz-Zubehör	AKE
	2.3			01.92	08.96					
	2.3 4x4			06.90	08.96					
	2.5 D			01.92	08.96					
	2.5 D 4x4			06.90	08.96					
	2.5 TD			07.94	08.96					
	3.1 TD			01.92	08.96					
	2.2 D			01.92	08.96	24.0122-0156.1	422156		257 22,0 20,6 V	
	2.2 D 4x4			09.90	08.96					
	2.3			01.92	08.96					
	2.3 4x4			06.90	08.96					
	2.5 D			01.92	08.96					

¹⁾ + distribution transmission / + differenziale centrale / + transmission 4x4 / + engranaje de distribución



OPEL CAMPO (91-96)

	2.5 D 4x4 2.5 TD 3.1 TD			06.90 07.94 01.92	08.96 08.96 08.96		24.0122-0156.1	422156			257 22,0 20,6 V
	2.2 D 2.2 D 4x4 2.3 2.3 4x4 2.5 D 2.5 D 4x4 2.5 TD 3.1 TD			01.92 09.90 01.92 06.90 01.92 06.90 07.94 01.92	08.96 08.96 08.96 08.96 08.96 08.96 08.96 08.96		24.3225-1702.3	020425			Rz 25,40

OPEL COMMODORE A / Vauxhall Viceroy (67-71)

	2.5 GS 2.5 GS/E 2.5 S 2.8 GS	96 110 107		08.67 08.69 08.67 05.70	12.71 12.71 12.71 12.71		03.0101-3501.2	390001			Behälter Rep. Satz
	2.5 GS 2.5 GS/E 2.5 S 2.8 GS	96 110 107		08.67 08.69 08.67 05.70	12.71 12.71 12.71 12.71		13.0460-6027.2	606027			20011 15,0 ATE
	2.5 GS 2.5 GS/E 2.5 S 2.8 GS	96 110 107		08.67 08.69 08.67 05.70	12.71 12.71 12.71 12.71		24.0113-0126.1	413126			271 12,7 9,7

OPEL COMMODORE B / Vauxhall Viceroy (72-78)

	2.5 2.8 GS/E 2.8 GS/E	◀ ◀ ◀	51000104 51000105	01.72 01.72	12.77 12.77	+ HA-Trommelbremse ¹⁾ + HA-Scheibenbremse ²⁾	03.2123-6207.3 03.2123-4911.3	010185 010182			Thz 23,81 Thz 23,81	ATE ATE
	2.5 2.8 GS/E	◀ ◀	51000104	01.72 01.72	12.77	+ HA-Trommelbremse ¹⁾	03.3508-7504.3 03.3304-1400.1	310045 390088			Behälter Behälterstopfen	ATE
	2.5 2.8 GS/E			01.72 01.72	12.77 12.77		13.0441-5411.2 13.0441-5411.2	250114 250114			Dichtungssatz Dichtungssatz	ATE ATE
	2.5 2.5 S 2.8 GS/E			01.72 01.72 01.72	07.78 07.78 07.78		13.0460-6027.2	606027			20011 15,0	ATE
	2.5 2.8 GS/E			01.72 01.72	12.77 12.77		24.0113-0126.1 24.0122-0109.1	413126 422109			271 12,7 9,7 271 22,0 19,0 V	
	2.8 GS/E		51000105		12.77		13.0460-4035.2	604035			20173 15,0	ATE
	2.5 2.8 GS/E		51000104	01.72 01.72	12.77		03.3222-6903.3	020084			Rz 22,20	
	2.5 2.8 GS/E		5161205 51000104	01.72 01.72	12.77		03.0137-0108.2 03.0137-9014.2	650108 669014			230 x 51 HEB Bremsbacken-Zubehör	

OPEL COMMODORE C / Vauxhall Viceroy (78-83)

	2.5 E 2.5 S	◀ ◀		04.82 01.78	12.83 12.83	- verstärkte Bremse ³⁾ - verstärkte Bremse ³⁾	03.2123-6207.3	010185			Thz 23,81	ATE
	2.5 S Limousine 2.5 E Limousine		11001886	01.78			13.0441-5411.2	250114			Dichtungssatz Dichtungssatz	ATE ATE
	2.5 S Limousine 2.5 E Limousine 2.5 S Caravan			01.78 04.82 01.81	12.83 12.83 12.83		13.0460-4048.2 13.0460-4048.2 13.0460-0165.2	604048 604048 610165			20011 15,0 /WE 20011 15,0 /WE Belagsatz-Zubehör	ATE ATE ATE
	2.5 S Limousine 2.5 E Limousine 2.5 S Caravan			01.78 04.82 01.81	12.83 12.83 12.83		24.0113-0126.1 24.0122-0109.1	413126 422109			271 12,7 9,7 271 22,0 19,0 V	
	2.5 E 2.5 S			01.78 01.78	12.83 12.83		83.6267-0285.3	330332	2		L=285	
	2.5 E 2.5 S			04.82 01.78	12.83 12.83		03.3222-6903.3	020084			Rz 22,20	
	2.5 E Limousine 2.5 S Limousine			04.82 01.78	12.83 12.83		03.0137-0108.2 03.0137-9014.2	650108 669014			230 x 51 HEB Bremsbacken-Zubehör	

OPEL CORSA A / Vauxhall Nova (83-92)

	1.0 S 1.2 1.3 1.4 1.4 N		M4999999 M4999999 M4999999 M4999999 M4999999	09.82 09.82 09.82 08.89 08.89			24.3481-0705.5 24.3481-0706.5 24.0101-4801.2	240021 240022 990131	<input type="checkbox"/> <input type="checkbox"/>		D=48, - Halter D=48, - Halter Bremsattel-Zubehör	DEL DEL DEL
--	-------------------------------------	--	--	---	--	--	--	----------------------------	--	--	--	-------------------

¹⁾ + RA drum brake / + P freno a tamburo / + frein à tambour essieu AR / + ET-tambores de freno
²⁾ + RA disc brake / + P disco freno / + frein à disque essieu AR / + ET-disco de freno
³⁾ - heavy duty brake / - freno rinforzato / - frein renforcé / - freno reforzado





OPEL CORSA A / Vauxhall Nova (83-92)

	1.5 D		M4999999	09.87		24.3481-0707.5	240023	☐	D=48, - Halter	DEL	
	1.5 TD		M4999999	03.88		24.3481-0708.5	240024			DEL	
	1.6 i N		M4999999	03.88		24.0101-4801.2	990131			DEL	
	1.6 i SE		M4999999	01.88		24.0101-4801.2	990131		Bremssattel-Zubehör	DEL	
	1.0 S	N4000001			10.92	24.3481-1733.5	240213	☐	D=48, - Halter	ATE	
	1.2	N4000001			10.92	24.3481-1734.5	240214			ATE	
	1.4	N4000001			10.92	11.0441-4811.2	250024			ATE	
	1.4 N	N4000001			10.92	11.0101-5407.2	260011			ATE	
	1.5 D	N4000001			10.92	11.8171-0008.1	990049			ATE	
	1.5 TD	N4000001			10.92	11.8116-0129.1	390591			ATE	
1.4 i SE	N4000001			10.92	11.9481-9871.2	220681	☐	D=48, - Halter	ATE		
1.6 i N	N4000001			10.92	11.9481-9872.2	220682			ATE		
1.6 i SE	N4000001			10.92	11.0441-4811.2	250024			ATE		
									Hülssensatz	ATE	
									Führungsbolzen	ATE	
									Haltefeder	ATE	
	1.0 S		M4999999	09.82		13.0460-7048.2	607048		20939 15,8 /WE	DEL	
	1.2		M4999999	09.82		13.0460-0127.2	610127			DEL	
	1.3		M4999999	09.82							
	1.4		M4999999	08.89							
	1.4 N		M4999999	08.89							
	1.5 D		M4999999	09.87							
	1.5 TD		M4999999	03.88							
	1.6 i N		M4999999	03.88							
	1.6 i SE		M4999999	01.88		13.0460-7048.2	607048			20939 15,8 /WE	DEL
						13.0460-0205.2	610205			Belagsatz-Zubehör	DEL
1.0 S	N4000001			10.92	13.0460-7051.2	607051		20547 16,5 +/WE	ATE		
1.2	N4000001			10.92							
1.4	N4000001			10.92							
1.4 i SE	N4000001			10.92							
1.4 N	N4000001			10.92							
1.5 D	N4000001			10.92							
1.5 TD	N4000001			10.92							
1.6 i N	N4000001			10.92							
1.6 i SE	N4000001			10.92							
	1.0 S		M4999999	09.82		24.0110-0152.1	410152		236 10,0 7,0 +S +B		
	1.2		M4999999	09.82							
	1.3		M4999999	09.82							
	1.4		M4999999	08.89							
	1.4 N		M4999999	08.89							
	1.0 S	N4000001			10.92	24.0113-0161.1	413161		236 12,7 9,7 +S +B		
	1.2	N4000001			10.92	24.0313-0161.1	513161		236 12,7 9,7 +S +B PD		
	1.4	N4000001			10.92						
	1.4 N	N4000001			10.92						
	1.5 D			09.87	10.92						
1.5 TD			03.88	10.92							
1.6 i N		M4999999	03.88	10.92							
1.4 i SE	N4000001			10.92	24.0120-0115.1	420115		236 20,0 17,0 V L +S +B			
1.6 i N	N4000001			10.92	24.0320-0115.1	520115		236 20,0 17,0 V L +S +B PD			
1.6 i SE			01.88	10.92							
	1.0		F4999999	09.82		24.5232-0283.3	331323	2	L=283		
	1.2		F4999999	09.82							
	1.3		F4999999	09.82							
	1.4 i SE		F4999999	09.91							
	1.4 N		F4999999	08.89							
	1.6 i SE		F4999999	01.88							
1.0	G4000001			10.92	24.5232-0283.3	331323	2	L=283			
1.2	G4000001			10.92							
1.3	G4000001			10.92							
1.4			08.89	10.92							
1.4 i SE	G4000001			10.92							
1.4 N	G4000001			10.92							
1.5 D			09.87	10.92							
1.5 TD			03.88	10.92							
1.6			03.88	10.92							
1.6 i SE	G4000001			10.92							
	1.0		F4999999	09.82		83.6267-0195.3	330737	2	L=195		
	1.2		F4999999	09.82							
	1.3		F4999999	09.82							
	1.4 i SE		F4999999	09.91							
	1.4 N		F4999999	08.89							
	1.6 i SE		F4999999	01.88							
1.0	G4000001			10.92	24.5233-0200.3	330425	2	L=198			
1.2	G4000001			10.92							
1.3	G4000001			10.92							
1.4			08.89	10.92							
1.4 i SE	G4000001			10.92							
1.4 N	G4000001			10.92							
1.5 D			09.87	10.92							
1.5 TD			03.88	10.92							
1.6			03.88	10.92							
1.6 i SE	G4000001			10.92							

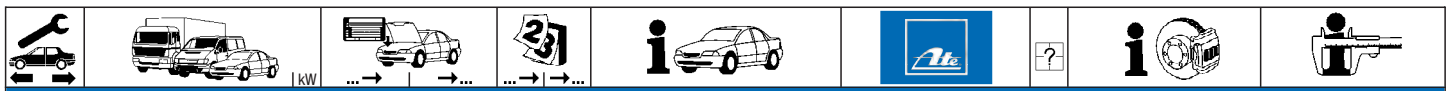

OPEL CORSA A / Vauxhall Nova (83-92)

	1.0 S		F4999999	09.82	- verstärkte Bremse ¹⁾	24.3214-1101.3	020148		Rz 14,29	TRW
	1.0 S		F4999999	09.82	+ verstärkte Bremse ²⁾	24.3217-1102.3	020168		Rz 17,46	TRW
	1.2		F4999999	09.82						
	1.3		F4999999	09.82						
	1.0 S	G4000001			10.92 + verstärkte Bremse ²⁾	03.3217-3512.3	020032		Rz 17,46	TRW
	1.0 S	M4000001			10.92 - EG Vorschrift ³⁾					
	1.2	G4000001			10.92					
	1.3	G4000001	N4000000							
	1.4 N			08.89	10.92					
	1.5 D			09.87	10.92					
	1.5 TD			03.88	10.92					
	1.6 i N			03.88	10.92					
	1.6 i SE			01.88	10.92					
	1.0	E4008341	M4999999			03.0137-0165.2	650165		200 x 29 HEB	TRW
	1.2	E4008341	M4999999			03.0137-9054.2	669054		Bremsbacken-Zubehör	TRW
	1.3	E4008341	M4999999							
	1.4		M4999999	08.89						
	1.5 D		M4999999	09.87						
	1.5 TD		M4999999	03.88						
	1.6		M4999999	03.88						
	1.0	N4000001			10.92	03.0137-0266.2	650266		200 x 29 HEB	
	1.2	N4000001			10.92	03.0137-9166.2	669166		Bremsbacken-Zubehör	
	1.3	N4000001			10.92					
	1.4	N4000001			10.92					
	1.5 D	N4000001			10.92					
	1.5 TD	N4000001			10.92					
	1.6	N4000001			10.92					
	1.0			09.82	10.92	24.0220-0012.1	480017		200/201 x 35 - Lager	
	1.2			09.82	10.92	24.0220-0712.2	480208		200/201 x 35 + Lager	
	1.3			09.82	10.92					
	1.4			08.89	10.92					
	1.5 D			09.87	10.92					
	1.5 TD			03.88	10.92					
	1.6			03.88	10.92					
	1.0 S	G4000001	N4000000		+ verstärkte Bremse ²⁾	03.0520-0817.3	690817		17,46/200x29 TopKit	TRW
	1.0 S	M4000001	N4000000		- EG Vorschrift ³⁾					
	1.2	G4000001	N4000000							
	1.3	G4000001	N4000000							
	1.4 N		N4000000	08.89						
	1.5 D		N4000000	09.87						
	1.5 TD		N4000000	03.88						
	1.6 i N		N4000000	03.88						
	1.6 i SE		N4000000	03.88						
	1.0	N4000001			10.92	03.0520-1917.3	691917		17,46/200x29 TopKit	TRW
	1.2	N4000001			10.92					
	1.3	N4000001			10.92					
	1.4	N4000001			10.92					
	1.5 D	N4000001			10.92					
	1.5 TD	N4000001			10.92					
	1.6	N4000001			10.92					
	1.0		F4999999	09.82		24.3727-0721.2	580721	<input type="checkbox"/>	L=816, + Zub	
	1.2		F4999999	09.82		24.3727-0722.2	580722	<input type="checkbox"/>	L=1429, + Zub	
	1.3		F4999999	09.82						
	1.0	G4000001	N4052760			24.3727-0728.2	580728	<input type="checkbox"/>	L=960, + Zub	
	1.2	G4000001	N4052760			24.3727-0729.2	580729	<input type="checkbox"/>	L=1400, + Zub	
	1.3	G4000001	N4052760							
	1.4		N4052760	08.89						
	1.4 i SE		N4052760	09.91						
	1.4 N		N4052760	08.89						
	1.5 D		N4052760	09.87						
	1.5 TD		N4052760	03.88						
	1.6		N4052760	03.88						
	1.6 i SE		N4052760	01.88						
	1.0	N4052761			10.92	24.3727-0737.2	580737	<input type="checkbox"/>	L=1241, + Zub	
	1.2	N4052761			10.92	24.3727-0738.2	580738	<input type="checkbox"/>	L=1035, + Zub	
	1.3	N4052761			10.92					
	1.4	N4052761			10.92					
	1.4 i SE	N4052761			10.92					
	1.4 N	N4052761			10.92					
	1.5 D	N4052761			10.92					
	1.5 TD	N4052761			10.92					
	1.6	N4052761			10.92					
	1.6 i SE	N4052761			10.92					
	1.0 S			09.82	10.92	24.3728-0710.2	590710		L=693	
	1.2			09.82	10.92					
	1.3			09.82	10.92					
	1.4 i SE			09.91	10.92					
	1.4 N			08.89	10.92					
	1.5 D			09.87	10.92					
	1.5 TD			03.88	10.92					
	1.6 i N			03.88	10.92					
	1.6 i SE			01.88	10.92					

1) - heavy duty brake / - freno rinforzato / - frein renforcé / - freno reforzado
 2) + heavy duty brake / + freno rinforzato / + frein renforcé / + freno reforzado
 3) - EC regulation / - normativa CEE / - prescription CEE / - según normativa CEE



OPEL DIPLOMAT A (64-69)									
	4.6 V8 5.4	140 169		10.64 03.65	03.69 03.69	13.0460-6027.2	606027		20011 15,0 ATE
	4.6 V8 5.4	140 169		10.64 03.65	03.69 03.69	24.0113-0126.1	413126		271 12,7 9,7
OPEL DIPLOMAT B (69-78)									
	2.8 2.8 E 5.4	103 121 169		09.72 03.69 03.69		13.0460-6027.2	606027		20011 15,0 ATE
	2.8 2.8 E 5.4	103 121 169		09.72 03.69 03.69		24.0122-0109.1	422109		271 22,0 19,0 V
	2.8 2.8 E 5.4	103 121 169		09.72 03.69 03.69		13.0460-4033.2	604033		20034 15,0 ATE
OPEL GT (68-73)									
	1.1 1.9	44 66		09.68 09.68	12.70 08.73	24.0111-0116.1	411116		238 11,0 8,0
	1.9	66		09.68	08.73	03.3215-1701.3	020015		Rz 15,87
OPEL KADETT B (65-73)									
	1.1 1.2 1.7 1.9	◀ ◀ ◀ ◀		01.66 01.66 01.66 01.66	12.73 + Bremsgerät ¹⁾ 12.73 + Bremsgerät ¹⁾ 12.73 + Bremsgerät ¹⁾ 12.73 + Bremsgerät ¹⁾	03.3508-8302.3	310046		Behälter ATE
	1.1 1.2			01.67 01.67	12.73 12.73	13.0460-3010.2	603010		20009 15,0 ATE
	1.7 1.9 1.9 S Rallye			01.67 01.67 01.71	12.71 12.71 12.73	13.0460-4035.2	604035		20173 15,0 ATE
	1.1 1.2 1.7 1.9 1.9 S Rallye			01.67 01.67 01.67 01.67 01.71	12.73 12.73 12.73 12.73 12.73	24.0111-0116.1	411116		238 11,0 8,0
	1.1 1.2			01.65 01.65	12.73 + VA-Trommelbremse ²⁾ 12.73 + VA-Trommelbremse ²⁾	24.3223-1103.3 24.3223-1104.3	020290 020291	<input type="checkbox"/> <input type="checkbox"/>	Rz 23,81 Rz 23,81
	1.1 1.2			01.66 01.66	12.73 12.73 - Skandinavien ³⁾	24.3215-1101.3	020155		Rz 15,87
	1.7 1.9 1.9 S Rallye			01.67 01.67 01.71	12.71 12.71 12.73 - Skandinavien ³⁾	03.3215-1701.3	020015		Rz 15,87
	1.9 S Rallye	2624371		12.73	+ Skandinavien ⁴⁾	03.3219-4202.3	020050		Rz 19,05
	1.1 1.2			01.65 01.65	12.73 12.73	03.0137-9015.2	669015		Bremsbacken-Zubehör
	1.9 1.9 S Rallye	2560670		12.73 01.71	12.73 12.73	03.0137-0108.2 03.0137-9014.2	650108 669014		230 x 51 HEB Bremsbacken-Zubehör
	1.1 1.2	2624371		01.65 01.65	12.73 - Ⓟ 12.73 + Skandinavien ⁴⁾ 12.73 - Ⓟ	24.0220-0001.2	480013		200/201 x 53,5
	1.7 1.9			01.65 01.65	12.73 12.73	24.0223-0008.2	480038		230/231 x 60
OPEL KADETT C / Vauxhall Chevette (73-79)									
	1.0 1.2 1.6 1.9 2.0			08.77 08.77 08.77 08.77 08.77	07.79 + VA-Scheibenbremse/+Bremsgerät ⁵⁾ 07.79 + VA-Scheibenbremse/+Bremsgerät ⁵⁾ 07.79 + VA-Scheibenbremse/+Bremsgerät ⁵⁾ 07.79 + VA-Scheibenbremse/+Bremsgerät ⁵⁾ 07.79 + VA-Scheibenbremse/+Bremsgerät ⁵⁾	03.2120-0538.3 03.2120-1981.3	010077 010105	+ Behälter ⁶⁾	THz 20,64 THz 20,64 ATE DEL
	1.0 1.2			01.73 01.73	12.75 + Bremsgerät ¹⁾ 12.75 + Bremsgerät ¹⁾	03.3508-8302.3	310046		Behälter ATE
	1.0 1.2			01.73 01.73	07.79 07.79	13.0441-4825.2	250107		Dichtungssatz ATE
	1.6 1.9 2.0			01.75 01.75 01.75	07.79 07.79 07.79	13.0441-4825.2	250107		Dichtungssatz ATE
	1.0 1.2			01.75 01.75	07.79 07.79	13.0460-4035.2 13.0460-0038.2	604035 610038		20173 15,0 ATE Belagsatz-Zubehör ATE
	1.6 1.9 2.0			01.75 01.75 01.75	07.79 07.79 07.79	13.0460-5030.2	605030		20323 16,5 ATE
	1.0 1.2			01.73 01.73	07.79 07.79	24.0111-0116.1	411116		238 11,0 8,0
	1.6 1.9			01.75 01.75	07.79 07.79	24.0113-0125.1	413125		246 12,7 9,7

¹⁾ + booster unit / + servofreno / + servo-frein / + servofreno

²⁾ + FA drum brake / + A freno a tamburo / + frein à tambour ess.AV / + ED tambores de freno

³⁾ - Scandinavia / - Scandinavia / - Scandinavie / - Escandinavia

⁴⁾ + Scandinavia / + Scandinavia / + Scandinavie / + Escandinavia

⁵⁾ + FA disc brake / + booster unit / + A disco freno / + servofreno / + fr.à disque ess.AV / + servofr. / + ED-disco de freno / + servofreno

⁶⁾ + reservoir / + serbatoio / + réservoir / + recipiente



OPEL KADETT C / Vauxhall Chevette (73-79)										
	2.0			01.75	07.79		24.0113-0125.1	413125		246 12,7 9,7
	1.0			01.77	07.79		83.6267-0330.3	330333	2	L=330
	1.2			01.77	07.79					
	1.6			01.78	07.79		83.6267-0330.3	330333	2	L=330
	1.9			01.78	07.79					
	1.0			01.73	07.79		24.3223-1103.3	020290	<input type="checkbox"/>	Rz 23,81
	1.2			01.73	07.79		24.3223-1104.3	020291	<input type="checkbox"/>	Rz 23,81
	1.0			01.73	07.79	- (S)	24.3215-1101.3	020155		Rz 15,87
	1.2			01.73	07.79	- (S)				
	1.6			01.75	07.79		03.3219-4202.3	020050		Rz 19,05
	1.9			01.75	07.79					
	1.0			01.73	07.79	- EG Vorschrift/ - (S) ¹⁾	03.0137-9015.2	669015		Bremsbacken-Zubehör
	1.2			01.73	07.79	- EG Vorschrift/ - (S) ¹⁾				
	1.6			01.75	07.79		03.0137-0108.2	650108		230 x 51 HEB
	1.9			01.75	07.79		03.0137-9014.2	669014		Bremsbacken-Zubehör
	1.0			01.73	07.79		24.0220-0001.2	480013		200/201 x 53,5
	1.2			01.73	07.79					
	1.6			01.75	07.79		24.0223-0008.2	480038		230/231 x 60
	2.0			01.75	07.79					

OPEL KADETT D / Vauxhall Astra D (79-84)												
	1.0			08.79	07.84	+ Bremsgerät/ + Schaltgetriebe ²⁾	03.2120-2598.3	010116		Thz 20,64	ATE	
	1.2 Limousine			08.79	07.84	+ Bremsgerät/ + Schaltgetriebe ²⁾						
	1.3 Limousine			08.79	07.84	+ Bremsgerät/ + Schaltgetriebe ²⁾						
	1.6 D Limousine			01.82	07.84	+ Bremsgerät/ + Schaltgetriebe ²⁾						
	1.6 Limousine			01.82	07.84	+ Bremsgerät/ + Schaltgetriebe ²⁾						
	1.8 i Limousine			01.82	07.84	+ Bremsgerät/ + Schaltgetriebe ²⁾						
	1.0			05.81	07.84	+ Bremsgerät ³⁾	03.2120-2421.3	010112		Thz 20,64 + Behälter	DEL	
	1.2			05.81	07.84	+ Bremsgerät ³⁾						
	1.3			05.81	07.84	+ Bremsgerät ³⁾						
	1.6			01.82	07.84							
	1.0			08.79	07.84	+ Bremsgerät ³⁾	03.2120-2381.3	010111		Thz 20,64 + Behälter	DEL	
	1.2 Limousine			08.79	07.84	+ Bremsgerät ³⁾						
	1.3 Limousine			08.79	07.84	+ Bremsgerät ³⁾						
	1.6 D Limousine			01.82	07.84							
	1.6 Limousine			08.79	07.84							
	1.8 i			08.82	07.84							
	1.0			08.79	09.81		24.0101-4801.2	990131		Bremssattel-Zubehör	DEL	
	1.2			08.79	09.81							
	1.3			08.79	09.81	- verstärkte Br./+ Schaltgetr. ⁴⁾						
	1.0			10.81	07.84		24.3481-0705.5	240021	<input type="checkbox"/>	D=48, - Halter	DEL	
	1.2			10.81	07.84		24.3481-0706.5	240022	<input type="checkbox"/>	D=48, - Halter	DEL	
	1.3			10.81	07.84	- verstärkte Br./+ Schaltgetr. ⁴⁾	11.0441-4803.2	250018		Dichtungssatz	ATE	
	1.3			08.79	07.84	+ verstärkte Bremse/+ Schaltgetr. ⁵⁾	24.3481-0707.5	240023	<input type="checkbox"/>	Hülzensatz	ATE	
	1.3			08.79	07.84	+ Automatikgetriebe ⁶⁾	24.3481-0708.5	240024	<input type="checkbox"/>	Bremssattel-Zubehör	DEL	
	1.6			01.82	07.84		11.0441-4803.2	250018		Dichtungssatz	ATE	
	1.6 D			01.82	07.84		11.0101-4802.2	260007		Hülzensatz	ATE	
							24.0101-4801.2	990131		Bremssattel-Zubehör	DEL	
	1.0			08.79	07.84		13.0460-7048.2	607048		- belüftete Scheiben ⁷⁾	20939 15,8 /WE	DEL
	1.2			08.79	07.84		13.0460-0127.2	610127		+ belüftete Scheiben ⁸⁾	Belagsatz-Zubehör	DEL
	1.3			08.79	07.84		13.0460-0205.2	610205			Belagsatz-Zubehör	DEL
	1.6			01.82	07.84							
	1.6 D			01.82	07.84							
	1.8			01.82	07.84							
	1.0			08.79	07.84		24.0110-0152.1	410152		236 10,0 7,0 +S +B		
	1.2			08.79	07.84							
	1.3			08.79	07.84	- verstärkte Br./+ Schaltgetr. ⁴⁾						
	1.3			08.79	07.84	+ verstärkte Bremse/+ Schaltgetr. ⁵⁾	24.0113-0161.1	413161		236 12,7 9,7 +S +B		
	1.6			01.82	07.84	+ Automatikgetriebe ⁶⁾	24.0313-0161.1	513161		236 12,7 9,7 +S +B PD		
	1.6 D			01.82	07.84							
	1.8 i			01.82	07.84		24.0120-0115.1	420115		236 20,0 17,0 V L +S +B		
							24.0320-0115.1	520115		236 20,0 17,0 V L +S +B PD		
	1.0		D2500064		07.84		83.6288-0314.3	330338	2	L=310		
	1.0		D5000001		07.84							
	1.2		D2500064		07.84							
	1.2		D5000001		07.84							
	1.3		D2500064		07.84							
	1.3		D5000001		07.84							
1.6 D Limousine			01.82	07.84								
1.6 Limousine			01.82	07.84								
1.8 i			01.82	07.84								

¹⁾ - EG regulation/ - (S) / - normativa CEE/ - (S) / - prescription CEE/ - (S) / - según normativa CEE/ - (S)
²⁾ + booster unit/ + manual transm./ + servofreno/+ scatola camb.velocità / + servo-frein/ + transm.mécanique / + servofreno/ + camb.de velocidad
³⁾ + booster unit/ + servofreno / + servo-frein / + servofreno
⁴⁾ - heavy duty br./+ manual transm. / - fr.rinforzato/+ scatola camb.velocità / - frein renforcé/ + transm.mécanique / - freno reforzado/ + camb.velocidad
⁵⁾ + heavy duty br./+ manual transm. / + fr.rinforzato/+ scatola camb.velocità / + frein renforcé/ + transm.mécanique / + freno reforzado/ + camb.de velocidad
⁶⁾ + autom.transmission / + scatola cambio automatico / + transmission automatique / + cambio automático
⁷⁾ - ventilated discs / - dischi ventilati / - disques ventilés / - disco ventilado
⁸⁾ + ventilated discs / + dischi ventilati / + disques ventilés / + disco ventilado





OPEL KADETT E / Vau. Astra E/Belmont (84-93)

	1.6 D			08.84	12.88	- ABS	03.2120-2598.3	010116	mit Adapter für Bördel E ¹⁾	THz 20,64	ATE					
	1.7 D			01.89	09.91	- ABS	03.2120-2597.3	010115		Bördel F ²⁾	THz 20,64	ATE				
	1.6			08.84	09.91	- ABS	03.2122-0264.3	010129	Kompakt-THz ³⁾	THz 22,20	ATE					
	1.6 D			08.84	12.88	- ABS										
	1.7 D			01.89	09.91	- ABS										
	1.8		L4000000	08.84		- ABS	03.2120-2598.3	010116		mit Adapter für Bördel E ¹⁾ Bördel F ²⁾	THz 20,64	ATE				
	1.8		J5273427	08.84		- ABS	03.2120-2597.3	010115			THz 20,64	ATE				
	1.8		J2791967	08.84		- ABS										
	2.0 i		L4000000	08.84		- ABS										
	2.0 i		J5273427	08.84		- ABS										
	2.0 i		J2791967	08.84		- ABS										
	1.8 i		J2791968		09.91	- ABS	03.2122-0264.3	010129		Kompakt-THz ³⁾	THz 22,20	ATE				
	1.8 i		J5273428		09.91	- ABS										
	1.8 i		L4000001		09.91	- ABS										
	2.0 i		J2791968		09.91	- ABS										
	2.0 i		J5273428		09.91	- ABS										
	2.0 i		L4000001		09.91	- ABS										
	1.2			08.84	09.91	+ ABS	03.2122-0282.3	010130		THz 22,20	ATE					
	1.3			08.84	09.91	+ ABS										
	1.4			08.89	09.91	+ ABS										
	1.5 TD			07.88	09.91	+ ABS										
	1.6			08.84	09.91	+ ABS										
	1.6 D			08.84	09.91	+ ABS										
	1.7 D			08.88	09.91	+ ABS										
	1.8			08.84	09.91	+ ABS										
	2.0			08.85	09.91	+ ABS										
	1.2			08.84	09.91	+ 10,0 mm Bremsscheiben ⁴⁾						24.3481-0705.5	240021	☐	D=48, - Halter	DEL
1.3			08.84	09.91	+ 10,0 mm Bremsscheiben ⁴⁾	24.3481-0706.5	240022	D=48, - Halter	DEL							
1.4			08.89	09.91	+ 10,0 mm Bremsscheiben ⁴⁾	11.0441-4803.2	250018	Dichtungssatz	ATE							
1.4 Limousine			08.89	09.91	+ 10,0 mm Bremsscheiben ⁴⁾	11.0101-4802.2	260007	☐	Hülssensatz	ATE						
			08.89	09.91	+ 10,0 mm Bremsscheiben ⁴⁾	24.0101-4801.2	990131		Bremssattel-Zubehör	DEL						
1.2			08.84	09.91	+ 12,7 mm Bremsscheiben ⁵⁾	24.3481-0707.5	240023	☐	D=48, - Halter	DEL						
1.3			08.84	09.91	+ 12,7 mm Bremsscheiben ⁵⁾	24.3481-0708.5	240024		D=48, - Halter	DEL						
1.4			08.89	09.91	+ 12,7 mm Bremsscheiben ⁵⁾	11.0441-4803.2	250018		Dichtungssatz	ATE						
1.4 Limousine			08.89	09.91	+ 12,7 mm Bremsscheiben ⁵⁾	11.0101-4802.2	260007		☐	Hülssensatz	ATE					
1.5 TD			07.88	09.91	+ 12,7 mm Bremsscheiben ⁵⁾	24.0101-4801.2	990131			Bremssattel-Zubehör	DEL					
1.6			08.84	09.91	+ 12,7 mm Bremsscheiben ⁵⁾											
1.6 D			08.84	09.91	+ 12,7 mm Bremsscheiben ⁵⁾											
1.7 D			08.88	09.91	+ 12,7 mm Bremsscheiben ⁵⁾											
1.8			08.84	09.91	+ 12,7 mm Bremsscheiben ⁵⁾											
Combo			08.84	09.91	+ 12,7 mm Bremsscheiben ⁵⁾											
1.6			08.84	09.91	+ 20,0 mm Bremsscheiben ⁶⁾	24.0101-4801.2	990131	☐	Bremssattel-Zubehör	DEL						
1.6 D			08.84	09.91	+ 20,0 mm Bremsscheiben ⁶⁾											
1.7 D			08.88	09.91	+ 20,0 mm Bremsscheiben ⁶⁾											
1.8 i			08.84	09.91	+ 20,0 mm Bremsscheiben ⁶⁾											
1.8 i			08.84	09.91	+ 24,0 mm Bremsscheiben ⁷⁾	24.3521-1701.5	240001	☐	D=52, - Halter	ATE						
2.0 i			08.85	09.91	+ 24,0 mm Bremsscheiben ⁷⁾	24.3521-1702.5	240002		D=52, - Halter	ATE						
2.0 i 16V			08.87	09.91	+ 24,0 mm Bremsscheiben ⁷⁾	11.0441-5202.2	250026		Dichtungssatz	ATE						
						11.0101-5407.2	260011		☐	Hülssensatz	ATE					
						11.8171-0008.1	990049			Führungsbolzen	ATE					
						11.8116-0097.1	390590	Haltefeder	ATE							
	1.2			08.84	09.91		13.0460-7048.2	607048	2	20939 15,8 /WE	DEL					
	1.3			08.84	09.91		13.0460-0127.2	610127				Belagsatz-Zubehör	DEL			
	1.4			08.89	09.91											
	1.5 TD			07.88	09.91											
	1.6			08.84	09.91											
	1.6 D			08.84	09.91											
	1.7 D			08.88	09.91											
	1.8		L5000000	08.84			13.0460-7048.2	607048				☐	20939 15,8 /WE	DEL		
	1.8 Caravan		K5025260	08.84			13.0460-0127.2	610127							Belagsatz-Zubehör	DEL
	1.8 Caravan		K2500077	08.84			24.8190-0701.2	620701							Warnkontakt L=950mm	DEL
	1.8 Limousine		L5000000	08.84								☐	21190 17,5 +/WE	ATE		
	1.8 Limousine		L2500000	08.84											Belagsatz-Zubehör	DEL
	1.8 Limousine		L5000001		09.91							☐	20939 15,8 /WE	DEL		
	1.8 Caravan		L5000001		09.91							☐	21190 17,5 +/WE	ATE		
	1.8 Caravan		K2500078		09.91										Belagsatz-Zubehör	DEL
1.8 Caravan		K5025261		09.91				☐	20939 15,8 /WE	DEL						
1.8 Limousine		L2500001		09.91							Belagsatz-Zubehör	DEL				
1.8 Limousine		L5000001		09.91							Warnkontakt L=950mm	ATE				
2.0 i			08.85	09.91				☐	20939 15,8 /WE	DEL						
2.0 i 16V			08.87	09.91							Warnkontakt L=950mm	DEL				
	1.2			08.84	09.91		24.0110-0152.1	410152	2	236 10,0 7,0 +S +B						
	1.3			08.84	09.91											
	1.4			08.89	09.91											
	1.2			08.84	09.91		24.0113-0161.1	413161				☐	236 12,7 9,7 +S +B			
	1.3			08.84	09.91		24.0313-0161.1	513161							236 12,7 9,7 +S +B PD	
	1.4			08.89	09.91											
	1.5 TD			07.88	09.91											
	1.6			08.84	09.91											
	1.6 D			08.84	09.91											
	1.7 D			08.88	09.91											
	1.8			08.84	09.91											
	Combo			08.84	09.91											
	1.6			08.84	09.91		24.0120-0115.1	420115				☐	236 20,0 17,0 V L +S +B			
	1.6 D			08.84	09.91		24.0320-0115.1	520115							236 20,0 17,0 V L +S +B PD	
	1.7 D			08.88	09.91											

¹⁾ with adapter for bead type E / con adattatore per bordatura E / avec adaptateur pour colet E / con adaptador para rebordes E

²⁾ flare type F / bordatura tipo F / colet F / reborde F

³⁾ compact TMC / PFT compatta / MCT compact / CMT compacto

⁴⁾ + 10,0 mm brake discs / + 10,0 mm dischi freno / + 10,0 mm disques de frein / + 10,0 mm discos de freno

⁵⁾ + 12,7 mm brake discs / + 12,7 mm dischi freno / + 12,7 mm disques de frein / + 12,7 mm discos de freno

⁶⁾ + 20,0 mm brake discs / + 20,0 mm dischi freno / + 20,0 mm disques de frein / + 20,0 mm disco de freno

⁷⁾ + 24,0 mm brake discs / + 24,0 mm dischi freno / + 24,0 mm disques de frein / + 24,0 mm disco de freno



OPEL KADETT E / Vau. Astra E/Belmont (84-93)

	1.8 i			08.84	09.91		24.0120-0115.1	420115		236 20,0 17,0 V L +S +B	
	1.8 i			08.84	09.91		24.0320-0115.1	520115		236 20,0 17,0 V L +S +B PD	
	2.0 i			08.85	09.91		24.0124-0115.1	424115		256 24,0 21,0 V L +S +B	
	2.0 i 16V			08.87	09.91		24.0324-0115.1	524115		256 24,0 21,0 V L +S +B PD	
	1.2		G2502696	08.84			83.6294-0315.3	330738	☐	L=315	
	1.3		G2502696	08.84			83.6288-0314.3	330338	☐	L=310	
	1.6		G2502696	08.84							
	1.6 D		G2502696	08.84							
	1.8		G2502696	08.84							
	2.0		G2502696	08.84							
	1.2	G2502697			09.91		24.5299-0309.3	331315	☐	L=309	
	1.3	G2502697			09.91		24.5298-0322.3	331314	☐	L=322	
	1.6	G2502697			09.91						
	1.6 D	G2502697			09.91						
	1.8	G2502697			09.91						
	2.0	G2502697			09.91						
	Combo			08.84	07.94						
	1.2		G5000000	08.84			83.6294-0315.3	330738	☐	L=315	
	1.3		G5000000	08.84			83.6288-0314.3	330338	☐	L=310	
	1.6		G5000000	08.84							
	1.6 D		G5000000	08.84							
	1.8		G5000000	08.84							
	1.8 Caravan		G5000000	08.84							
	2.0		G5000000	08.84							
	2.0 Limousine		G5000000	08.84							
	1.2	G5000001			09.91		24.5299-0309.3	331315	☐	L=309	
	1.3	G5000001			09.91		24.5298-0322.3	331314	☐	L=322	
	1.4			08.89	09.91						
	1.4 Limousine			08.89	09.91						
	1.5 TD			07.88	09.91						
	1.6	G5000001			09.91						
	1.6 D	G5000001			09.91						
	1.7 D			08.88	09.91						
	1.8	G5000001			09.91						
	1.8 Caravan	G5000001			09.91						
	2.0	G5000001			09.91						
	2.0 i 16V			08.87	09.91						
	2.0 Limousine	G5000001			09.91						
	2.0 i 16V Limousine			08.87	09.91		13.2351-0013.2	210010	☐	D=35	ATE
							13.2351-0014.2	210011	☐	D=35	ATE
							24.9235-0013.5	230001	☐	D=35	ATE
							24.9235-0014.5	230002	☐	D=35	ATE
							13.0441-3506.2	250052		Dichtungssatz	ATE
	2.0 i 16V Limousine			08.87	09.91		13.0460-4043.2	604043		21140 15,0	ATE
							13.0460-0217.2	610217		Belagsatz-Zubehör	ATE
	2.0 i 16V Limousine			08.87	09.91		24.0110-0144.1	410144		261 9,9 8,0	
	1.2		G2502696	08.84			83.6267-0195.3	330737	2	L=195	
	1.3		G2502696	08.84							
	1.4		G2502696	08.89							
	1.5 TD		G2502696	07.88							
	1.6		G2502696	08.84							
	1.6 D		G2502696	08.84							
	1.7 D		G2502696	08.88							
	1.8		G2502696	08.84							
	1.8 Caravan		G2502696	08.84							
	1.8 i		G2502696	08.84							
	2.0		G2502696	08.84							
	2.0 i 16V		G2502696	08.87							
	1.2 Limousine	G2502697			09.91		24.5233-0200.3	330425	2	L=198	
	1.3 Limousine	G2502697			09.91						
	1.4	G2502697			09.91						
	1.5 TD	G2502697			09.91						
	1.6 D Limousine	G2502697			09.91						
	1.6 Limousine	G2502697			09.91						
	1.7 D	G2502697			09.91						
	1.8 Caravan	G2502697			09.91						
	1.8 i	G2502697			09.91						
	1.8 Limousine	G2502697			09.91						
	2.0 i 16V	G2502697			09.91						
	2.0 Limousine	G2502697			09.91						
	1.2		G5000000	08.84			83.6267-0195.3	330737	2	L=195	
	1.3		G5000000	08.84							
	1.6		G5000000	08.84							
	1.6 D		G5000000	08.84							
	1.8		G5000000	08.84							
	2.0		G5000000	08.84							
	1.2 Limousine	G5000001			09.91		24.5233-0200.3	330425	2	L=198	
	1.3 Limousine	G5000001			09.91						
	1.4 Limousine			08.89	09.91						
	1.5 TD Limousine			07.88	09.91						
	1.6 D Limousine	G5000001			09.91						
	1.6 Limousine	G5000001			09.91						



OPEL KADETT E / Vau. Astra E/Belmont (84-93)

	1.7 D Limousine 1.8 Limousine 2.0 Limousine	G5000001 G5000001	08.88 09.91 09.91	09.91	24.5233-0200.3	330425	2		L=198	
	diverse Typen Lim. diverse Typen Lim.	G5000000 G2502696	08.84 08.84		24.3214-1101.3 24.3217-1102.3	020148 020168		Bördel E 1) Bördel E 1)	Rz 14,29 Rz 17,46	TRW TRW
	diverse Typen Lim. diverse Typen Lim.	G2502697 G5000001	09.91 09.91	09.91	03.3217-3512.3 24.3219-1767.3	020032 020552		Bördel F 2) + GG/ Bördel F 3) + ALU/ Bördel F 4)	Rz 17,46 Rz 19,05 Rz 19,05 (ALU)	TRW
	diverse Typen Caravan diverse Typen Caravan	G5000000 G2502696	08.84 08.84		03.3219-6301.3	020056		Bördel E/ - Druckbolzen 5)	Rz 19,05	
	diverse Typen Caravan diverse Typen Caravan	G2502697 G5000001	09.91 09.91	09.91	24.3219-1767.3 24.3219-1715.3	020552 020122		+ GG/ Bördel F/ - Druckbolzen 6) + ALU/ Bördel F, - Druckbolzen 7)	Rz 19,05 Rz 19,05 (ALU)	
	diverse Typen Caravan		08.84	09.91	24.3219-1111.3	020194		Bördel E 1)	Rz 19,05	TRW
	1.2 1.3 Limousine 1.4 Limousine 1.5 TD Limousine 1.6 D Limousine 1.6 Limousine 1.7 D Limousine		08.84 08.84 08.89 08.88 08.84 08.84 08.88	09.91 09.91 09.91 09.91 09.91 09.91 09.91	03.0137-0165.2 03.0137-9054.2	650165 669054		für Rz 14,29(E,F),Rz 17,46(E)	200 x 29 HEB Bremsbacken-Zubehör	TRW TRW
	1.2 Limousine 1.3 Limousine 1.4 Limousine 1.5 TD Limousine 1.6 D Limousine 1.6 Limousine 1.7 D Limousine 1.8 Limousine 2.0 Limousine		08.84 08.84 08.89 08.88 08.84 08.84 08.88 08.84 08.85	09.91 09.91 09.91 09.91 09.91 09.91 09.91 09.91 09.91	03.0137-0166.2 03.0137-9060.2	650166 669060		für Rz 17,46(E),Rz 19,05(F)	Ø00 x 46 HEB Bremsbacken-Zubehör	TRW TRW
	1.2 Caravan 1.3 Caravan 1.4 Caravan 1.5 TD Caravan 1.6 Caravan 1.6 D Caravan 1.7 D Caravan		08.84 08.84 08.89 08.88 08.84 08.84 08.88	09.91 09.91 09.91 09.91 09.91 09.91 09.91	03.0137-0166.2 03.0137-9060.2	650166 669060		für Rz 17,46(E),Rz 19,05(F)	Ø00 x 46 HEB Bremsbacken-Zubehör	TRW TRW
	1.2 Caravan 1.3 Caravan 1.4 Caravan 1.5 TD Caravan 1.6 Caravan 1.6 D Caravan 1.7 D Caravan 1.8 Caravan 2.0 Caravan		08.84 08.84 08.89 08.88 08.84 08.84 08.88 08.84 08.85	09.91 09.91 09.91 09.91 09.91 09.91 09.91 09.91 09.91	03.0137-0167.2 03.0137-9053.2	650167 669053			230 x 51 HEB Bremsbacken-Zubehör	TRW TRW
	1.2 1.3 1.4 Limousine 1.5 TD Limousine 1.6 D Limousine 1.6 Limousine 1.7 D Limousine 1.8 Limousine 2.0 Limousine		08.84 08.84 08.89 08.88 08.84 08.84 08.88 08.84 08.85	09.91 09.91 09.91 09.91 09.91 09.91 09.91 09.91 09.91	24.0220-0011.2 24.0220-0001.2	480016 480013			200/201 x 37,4 200/201 x 53,5	
	1.2 Caravan 1.3 Caravan 1.4 Caravan 1.5 TD Caravan 1.6 Caravan 1.6 D Caravan 1.7 D Caravan 1.8 Caravan 2.0 Caravan		08.84 08.84 08.89 08.88 08.84 08.84 08.88 08.84 08.85	09.91 09.91 09.91 09.91 09.91 09.91 09.91 09.91 09.91	24.0220-0001.2 24.0223-0008.2	480013 480038			200/201 x 53,5 230/231 x 60	
	1.2 1.3 1.4 Limousine 1.5 TD Limousine 1.6 D Limousine 1.6 Limousine 1.7 D Limousine		08.84 08.84 08.89 08.88 08.84 08.84 08.88	09.91 09.91 09.91 09.91 09.91 09.91 09.91	03.0520-0817.3	690817		Bördel F 2)	17,46/200x29 TopKit	TRW
	2.0 i 16V Limousine		08.87	09.91	03.0137-0172.2 03.0137-9092.2	650172 669092			160 x 25 Bremsbacken-Zubehör	
	1.2 Limousine 1.3 Limousine 1.6 D Limousine 1.6 Limousine 1.8 Limousine 2.0 N Limousine 2.0 S Limousine	G2502696 G2502696 G2502696 G2502696 G2502696 G2502696 G2502696	08.84 08.84 08.84 08.84 08.84 08.85		24.3727-0720.2	580720	1		L=2825, + Zub	
	1.2 Limousine 1.3 Limousine 1.6 D Limousine 1.6 Limousine 1.8 Limousine	G2502697 G2502697 G2502697 G2502697 G2502697	09.91 09.91 09.91 09.91 09.91		24.3727-0730.2	580730	1		L=1272/1676, + Zub	

1) flare type E / bordatura tipo E / colet E / reborde E
 2) flare type F / bordatura tipo F / colet F / reborde F
 3) + Cl/ flare type F / + ghisal/ bordatura tipo F / + fonte grise/ colet F / + FG/ reborde F
 4) + aluminium/ flare type F / + aluminium/ bordatura tipo F / + aluminium/ colet F / + aluminium/ reborde F
 5) flare type E/ - tappet / bordat.tipo E/ - punteria / colet E/ - boulon de pression / reborde E/ - perno de presión
 6) + Cl/ flare type F/ - tappet / + ghisal/bordat.tipo F/-punter. / + fonte gr./colet F/-boul.pres. / + FG/ reborde F/-perno presión
 7) + alu/ flare type F, - tappet / + alu/ borda.tip.F,-punteria / + alu/ colet F,- boul.press. / + alum./rebor.F,-perno presión
 8) f.WC14,29(E,F),WC17,46(E) / per CR 14,29(E,F),CR 17,46(E) / pour CR 14,29(E,F),CR 17,46(E) / para CR14,29 (E,F),CR17,46(E)
 9) f.WC17,46(E)
 10) f.WC17,46(E),WC19,05(E) / p.CR 17,46(E),CR 19,05(E) / p.CR17,46(E),CR19,05(E) / p.CR17,46(E),CR19,05(E)





OPEL KADETT E / Vau. Astra E/Belmont (84-93)

	2.0 N Limousine	G2502697		09.91		24.3727-0730.2	580730	1		L=1272/1676, + Zub
	2.0 S Limousine	G2502697		09.91						
	1.2 Limousine		G5000000	08.84		24.3727-0720.2	580720	1		L=2825, + Zub
	1.3 Limousine		G5000000	08.84						
	1.6 D Limousine		G5000000	08.84						
	1.6 Limousine		G5000000	08.84						
	1.8 Limousine		G5000000	08.84						
	2.0 N Limousine		G5000000	08.85						
	2.0 S Limousine		G5000000	08.85						
	1.2 Limousine	G5000001			09.91		24.3727-0730.2	580730	1	
1.3 Limousine	G5000001			09.91						
1.4 Limousine				08.89						
1.5 TD Limousine				07.88						
1.6 D Limousine	G5000001			09.91						
1.6 Limousine	G5000001			09.91						
1.7 D Limousine				08.88						
1.8 Limousine	G5000001			09.91						
2.0 N Limousine	G5000001			09.91						
2.0 S Limousine	G5000001			09.91						
1.2 Caravan				08.84	09.91 + Schaltgetriebe 1)	24.3727-0732.2	580732	1		L=1288/1398, + Zub
1.3 Caravan				08.84	09.91 + Schaltgetriebe 1)					
1.5 TD Caravan				07.88	09.91 + Schaltgetriebe 1)					
1.7 D Caravan				08.89	09.91 + Schaltgetriebe 1)					
2.0 Caravan				09.87	09.91 + Schaltgetriebe 1)					
1.2 Caravan				08.84	09.91 + Automatikgetriebe 2)	24.3727-0741.2	580741	1		L=1285/1395, + Zub
1.3 Caravan				08.84	09.91 + Automatikgetriebe 2)					
1.4 Caravan				08.84	09.91					
1.5 TD Caravan				07.88	09.91 + Automatikgetriebe 2)					
1.6 Caravan				08.84	09.91					
1.6 D Caravan				08.84	09.91					
1.7 D Caravan				08.89	09.91 + Automatikgetriebe 2)					
1.8 Caravan				08.84	09.91					
2.0 Caravan				09.87	09.91 + Automatikgetriebe 2)					
	1.2 Caravan	G2502697			09.91	03.6565-0130.3	320098			BRL 6/5 (4) ATE
	1.2 Caravan	G5000001			09.91					
	1.3 Caravan	G2502697			09.91					
	1.3 Caravan	G5000001			09.91					
	1.4 Caravan				08.89	09.91				
	1.5 TD Caravan				07.88	09.91				
	1.6 Caravan	G2502697			09.91					
	1.6 Caravan	G5000001			09.91					
	1.6 Caravan	G5000001			09.91					
	1.6 D Caravan	G2502697			09.91					
1.7 D Caravan				08.88	09.91					
1.8 Caravan	G2502697			09.91	Ch. G5000001 -					
1.8 Caravan	G5000001			09.91						
2.0 Caravan	G2502697			09.91	Ch. G5000001 -					
2.0 Caravan	G5000001			09.91						
	1.2			08.84	09.91	24.3728-0711.2	590711			L=815
	1.3			08.84	09.91					
	1.4			08.89	09.91					
	1.5 TD			07.88	09.91					
	1.6			08.84	09.91					
	1.6 D			08.84	09.91					
	1.7 D			08.88	09.91					
	1.8			08.84	09.91					
	2.0			08.84	09.91					

OPEL KAPITÄN (55-63)

	2.5	55		05.55	12.58	13.0460-6027.2	606027			20011 15,0 ATE
	P 2.6	66		05.58	12.63					

OPEL KAPITÄN A (64-69)

	4.6 V8	140		04.65	03.69	24.0113-0126.1	413126			271 12,7 9,7

OPEL MANTA A (70-75)

	1.2	◀ 2761365		08.75		03.2120-1981.3	010105		+ Behälter 3)	THz 20,64 DEL
	1.2	◀ 9662825		08.75						
	1.6	◀ 2761365		08.75						
	1.6	◀ 9662825		08.75						
	1.9	◀ 2761365		08.75						
	1.2			01.70	08.75	13.0460-4035.2	604035			20173 15,0 ATE
	1.6			01.70	08.75	13.0460-0038.2	610038			Belagsatz-Zubehör ATE
	1.6 N			01.70	08.75					
	1.9			01.70	08.75					
	1.2		51019912	01.70		24.0111-0116.1	411116			238 11,0 8,0
	1.6		51019912	01.70						
	1.6 N		51019912	01.70						
	1.9		51019912	01.70						
	1.2		51019913	08.75		24.0113-0125.1	413125			246 12,7 9,7
	1.6		51019913	08.75						
	1.6 N		51019913	08.75						

1) + manual transmission / + scatola cambio velocità / + transmission mécanique / + cambio de velocidad
 2) + autom.transmission / + scatola cambio automatico / + transmission automatique / + cambio automático
 3) + reservoir / + serbatoio / + réservoir / + recipiente





OPEL MANTA A (70-75)

	1.9	51019913		08.75		24.0113-0125.1	413125		246 12,7 9,7
	1.6 S 1.6 S 1.9 1.9		9662824 2761436 9662824 2761436	01.70 01.70 01.70 01.70		03.3215-1701.3	020015		Rz 15,87
	1.6 N 1.6 S 1.6 S 1.9 1.9	2724058 2761437 9662825 2761437 9662825		08.75 08.75 08.75 08.75 08.75	+ (N)	03.3219-4202.3	020050		Rz 19,05
	1.6 N 1.6 S 1.9	2560700		01.70 08.75 08.75 01.70	+ Automatikgetriebe ¹⁾	03.0137-0108.2 03.0137-9014.2	650108 669014		230 x 51 HEB Bremsbacken-Zubehör
	1.2 1.6 N 1.6 S 1.9		2453080	01.70 01.70 08.75 01.70		24.0220-0001.2 24.0223-0008.2	480013 480038		200/201 x 53,5 230/231 x 60
	1.6 N	2453081		08.75		24.0220-0001.2	480013		200/201 x 53,5

OPEL MANTA B / Vauxhall Cavalier Coupe (76-88)

	1.2 1.3 1.6 1.8 1.9 2.0	◀ ◀ ◀ ◀ ◀ ◀		09.75 01.80 09.75 01.82 09.75 12.77	07.85 07.85 12.82 07.85 11.77 07.85	03.2120-1981.3	010105	+ Behälter ²⁾	THz 20,64	DEL
	1.2 1.3 1.6 1.8 1.9 2.0	▶ ▶ ▶ ▶ ▶ ▶		09.77 01.80 09.77 01.82 09.77 12.77	08.81 07.85 12.82 07.85 11.77 07.85	03.2120-0538.3	010077		THz 20,64	ATE
	1.2 1.6 1.9	◀ ◀ ◀		10.76 10.76 10.76	12.77 12.77 11.77	03.3508-7504.3	310045		Behälter	ATE
	1.2 1.3 1.6 1.9 2.0			09.75 01.80 09.75 09.75 12.77	07.81 07.81 07.81 11.77 07.81	13.0441-4825.2	250107		Dichtungssatz	ATE
	1.2 1.3 1.6 1.8 2.0			09.78 01.80 09.78 01.82 09.78	08.81 12.86 12.82 12.88 12.88	24.0101-4801.2	990131		Bremssattel-Zubehör	DEL
	1.2 1.3 1.6 1.9 2.0			09.75 01.80 09.75 09.75 12.77	07.81 07.81 07.81 11.77 07.81	13.0460-5030.2	605030		20323 16,5	ATE
	1.2 1.3 1.6 1.8 2.0			09.78 01.80 09.78 01.82 09.78	12.88 12.86 12.82 12.88 12.88	13.0460-7048.2 13.0460-0127.2	607048 610127		20939 15,8 /WE Belagsatz-Zubehör	DEL DEL
	Manta 400 i			08.81	07.86	13.0460-7048.2	607048		20939 15,8 /WE	DEL
	1.2 1.3 1.6 1.8 1.9 2.0			09.75 01.80 09.75 01.82 09.75 12.77	08.81 12.86 12.82 12.88 11.77 12.88	24.0113-0125.1	413125		246 12,7 9,7	
	Manta 400 i			08.81	07.86	24.0122-0109.1	422109		271 22,0 19,0 V	
	1.6 S 1.8 1.9 2.0			09.75 01.82 09.75 12.77	12.82 12.88 11.77 12.88	03.3219-4202.3	020050		Rz 19,05	
	Manta 400 i			08.81	07.86					
	1.3 S 1.6 N 1.6 S 1.8 1.9 2.0			01.80 09.75 09.75 01.82 09.75 12.77	06.83 12.82 12.82 06.83 11.77 06.83	03.0137-0108.2 03.0137-9014.2	650108 669014		230 x 51 HEB Bremsbacken-Zubehör	
	1.3 S 1.8 2.0			07.83 07.83 07.83	12.86 12.88 12.88	03.0137-0167.2 03.0137-9053.2	650167 669053		230 x 51 HEB Bremsbacken-Zubehör	TRW TRW
	Manta 400 i			08.81	07.86					

¹⁾ + autom.transmission / + scatola cambio automatico / + transmission automatique / + cambio automático

²⁾ + reservoir / + serbatoio / + réservoir / + recipiente

³⁾ + fixed calipers / + pinze freno fisse / + étriers fixes / + pinza de fija

⁴⁾ + fist type calipers / + pinza freno flottante / + étriers à griffe / + pinza de puno





OPEL MANTA B / Vauxhall Cavalier Coupe (76-88)

	1.2			09.75	08.81		24.0220-0001.2	480013		200/201 x 53,5
	1.3 N			01.80	08.81	+ Schaltgetriebe ¹⁾				
	1.6 N			09.75	08.81	+ Schaltgetriebe ¹⁾				
	1.3 S			01.80	12.86		24.0223-0008.2	480038		230/231 x 60
	1.6 N			09.75	12.82	+ Automatikgetriebe ²⁾				
	1.6 S			09.75	12.82					
	1.8			01.82	12.88					
1.9			09.75	11.77						
2.0			12.77	12.88						

OPEL OLYMPIA A (67-71)











	1.0	44		08.67	08.71		24.0111-0116.1	411116		238 11,0 8,0
	1.7	55		08.67	08.71					
	1.9	66		08.67	08.71					

OPEL OMEGA A / Vauxhall Carlton (87-93)

	1.8 Limousine	◀		08.86	08.93	- ABS	03.2022-0602.3	010006		Thz 22,20/19,05	ATE	
	2.3 D Limousine	◀		08.86	08.93	- ABS						
	2.3 TD Limousine	◀		08.86	08.93	- ABS						
	1.8 Caravan	◀		08.86	08.93	- ABS	03.2022-0702.3	010007		Thz 22,20/19,05	ATE	
	2.0	◀		08.86	08.93	- ABS						
	2.3 D Caravan	◀		08.86	08.93	- ABS						
	2.3 TD Caravan	◀		08.86	08.93	- ABS						
	2.4	◀		08.88	08.93	- ABS						
	1.8	◀		08.86	08.93	+ ABS	03.2022-1402.3	010010		Thz 22,20/19,05	ATE	
	2.0	◀		08.86	08.93	+ ABS						
	2.3 D	◀		08.86	08.93	+ ABS						
	2.3 TD	◀		08.86	08.93	+ ABS						
	2.4	◀		08.88	08.93	+ ABS						
	2.6	◀		09.90	08.93		03.2023-0642.3	010026		Thz 23,81/20,64	ATE	
	3.0	◀		08.86	08.93							
	3.0 24V	◀		08.89	08.93							
	1.8	▶		08.86	08.93	+ ABS	03.2022-1602.3	010011		Thz 22,20/19,05	ATE	
	2.0	▶		08.86	08.93	+ ABS						
	2.3 D	▶		08.86	08.93	+ ABS						
	2.3 TD	▶		08.86	08.93	+ ABS						
	2.4	▶		08.88	08.93	+ ABS						
		1.8		L1019854	08.86			24.0101-4801.2	990131		Bremssattel-Zubehör	DEL
		2.3 D		L1019854	08.86							
2.3 TD			L1019854	08.86								
2.0			K1000098	08.86			24.0101-4801.2	990131		Bremssattel-Zubehör	DEL	
							11.0101-5407.2	260011		HülSENSatz	ATE	
							11.8171-0008.1	990049		Führungsbolzen	ATE	
							11.8116-0097.1	390590	2	Haltefeder	ATE	
	1.8		L1019855		08.93		11.0441-5402.2	250028		Dichtungssatz	ATE	
	2.0		K1000099		08.93		11.0101-5407.2	260011		HülSENSatz	ATE	
	2.3 D		L1019855		08.93		11.8171-0008.1	990049		Führungsbolzen	ATE	
	2.3 TD		L1019855		08.93		11.8116-0097.1	390590	2	Haltefeder	ATE	
	2.4		K1000099		08.93							
	3.0		M1000000	08.86			11.0441-6003.2	250037		Dichtungssatz	ATE	
							11.0101-5407.2	260011		HülSENSatz	ATE	
							11.8171-0008.1	990049		Führungsbolzen	ATE	
	2.6			09.90	08.93		24.3571-1705.5	240069	☐	D=57, - Halter	TRW	
	3.0		M1000001		08.93		24.3571-1706.5	240070	☐	D=57, - Halter	TRW	
	3.0 24V			08.89	08.93		24.0101-3401.2	260043		Bremssattel-Zubehör	TRW	
	1.8		L1019854	08.86			13.0460-7048.2	607048		20939 15,8 /WE	DEL	
	2.3 D		L1019854	08.86			13.0460-0127.2	610127		Belagsatz-Zubehör	DEL	
	2.3 TD		L1019854	08.86			13.0460-0205.2	610205		Belagsatz-Zubehör	DEL	
							24.8190-0712.2	620712	2	+ belüftete Scheiben/ + ABS ⁴⁾	DEL	
	2.0		K1000098	08.86			13.0460-7052.2	607052		Warnkontakt L=660mm		
							24.8190-0947.2	620947	2	Nur bei Umbau von DELCO in ATE	ATE	
							13.0460-7048.2	607048		20939 15,8 /WE	DEL	
							13.0460-0205.2	610205		Belagsatz-Zubehör	DEL	
	2.4		K1000099				24.8190-0702.2	620702	2	Warnkontakt L=860mm	DEL	
	1.8		L1019855		08.93		13.0460-7052.2	607052		21190 17,5 +/WE	ATE	
	2.0		K1000099		08.93		24.8190-0706.2	620706	2	Warnkontakt L=660mm	ATE	
	2.3 D		L1019855		08.93							
	2.3 TD		L1019855		08.93							
	2.4		K1000099		08.93							
	3.0		M1000000	08.86			24.8190-0703.2	620703	2	Warnkontakt L=860mm		
	2.6			09.90	08.93		13.0460-2815.2	602815		21368 18,3 /WE/S	TRW	
	3.0		M1000001		08.93		24.8190-0716.2	620716	2	Warnkontakt L=680mm		
	3.0 24V			08.89	08.93							
	1.8		L1019854	08.86		- ABS	24.0113-0174.1	413174		258 12,6 9,7		
	2.3 D		L1019854	08.86		- ABS						
	2.3 TD		L1019854	08.86		- ABS						
	1.8		L1019854	08.86		+ ABS	24.0124-0111.1	424111		258 24,0 21,0 V +B		
	1.8		L1019855		08.93							
	2.0			08.86	08.93							
	2.3 D		L1019854	08.86		+ ABS						
	2.3 TD		L1019855		08.93							
	2.3 TD		L1019854	08.86		+ ABS						
2.4			08.88	08.93								

1) + manual transmission / + scatola cambio velocità / + transmission mécanique / + cambio de velocidad
 2) + autom.transmission / + scatola cambio automatico / + transmission automatique / + cambio automatico
 3) - ventilated discs/ - ABS / - dischi ventilati, - ABS / - disques ventilés, - ABS / - disco ventilado, - ABS
 4) + ventilated discs/ + ABS / + dischi ventilati/ + ABS / + disques ventilés/ + ABS / + disco ventilado/ + ABS



OPEL OMEGA A / Vauxhall Carlton (87-93)									
	3.0		M1000000	08.86		24.0124-0110.1	424110		280 24,0 21,0 V
	2.6			09.90	08.93	24.0128-0104.1	428104		296 28,0 25,0 V L+S +B
	3.0	M1000001		08.89	08.93				
	3.0 24V			08.89	08.93				
	1.8 Limousine		K1000098	08.86		13.0441-3506.2	250052		Dichtungssatz ATE
	2.0 Limousine		K1000098	08.86					
	2.3 D Limousine		K1000098	08.86					
	2.3 TD Limousine		K1000098	08.86					
	1.8 Limousine	K1000099		08.93		13.0441-3506.2	250052		Dichtungssatz ATE
	2.0 Limousine	K1000099		08.93					
	2.3 D Limousine	K1000099		08.93					
	2.3 TD Limousine	K1000099		08.93					
	2.4 Limousine	K1000099		08.93					
	1.8 Limousine		K1000098	08.86		13.0460-0436.2	610436		Belagsatz-Zubehör ATE
	2.0 Limousine		K1000098	08.86					
	2.3 D Limousine		K1000098	08.86					
	2.3 TD Limousine		K1000098	08.86					
	1.8 Caravan	K1000099		08.86	08.93	13.0460-4040.2	604040		21050 15,8 ATE
	1.8 Limousine			08.93		13.0460-0198.2	610198		Belagsatz-Zubehör ATE
	2.0 Caravan	K1000099		08.86	08.93				
	2.0 Limousine	K1000099		08.86	08.93				
	2.3 D Caravan			08.86	08.93				
	2.3 D Limousine	K1000099		08.86	08.93				
	2.3 TD Caravan			08.86	08.93				
	2.3 TD Limousine	K1000099		08.86	08.93				
	2.4			08.88	08.93				
	2.6			09.90	08.93				
	3.0			08.86	08.93				
	3.0 24V			08.89	08.93				
	1.8			08.86	08.93	24.0110-0191.1	410191		270 10,0 8,0 +B
	2.0			08.86	08.93				
	2.3 D			08.86	08.93				
	2.3 TD			08.86	08.93				
	2.4			08.88	08.93				
	2.6			09.90	08.93				
	3.0			08.86	08.93				
	3.0 24V			08.89	08.93				
	1.8			08.86	08.93	24.5233-0200.3	330425	2	L=198
	2.0			08.86	08.93				
	2.3 D			08.86	08.93				
	2.3 TD			08.86	08.93				
	2.4			08.88	08.93				
	2.6			09.90	08.93				
	3.0			08.86	08.93				
	3.0 24V			08.89	08.93				
	1.8			08.86	08.93	03.0137-0172.2	650172		160 x 25
	2.0			08.86	08.93	03.0137-9092.2	669092		Bremsbacken-Zubehör
	2.3 D			08.86	08.93				
	2.3 TD			08.86	08.93				
	2.4			08.88	08.93				
	2.6			09.90	08.93				
	3.0			08.86	08.93				
	3.0 24V			08.89	08.93				
	1.8			08.86	08.93	24.3727-0725.2	580725	1	L=1550/1550, + Zub
	2.0			08.86	08.93				
	2.3 D			08.86	08.93				
	2.3 TD			08.86	08.93				
	2.4			08.88	08.93				
	2.6			09.90	08.93				
	3.0			08.86	08.93				
	3.0 24V			08.89	08.93				
	2.6	◀		09.90	08.93	24.2419-0938.3	030064		Gz 19,05
	3.0	◀	M1000001		08.93				
	3.0 24V	◀		08.89	08.93				
	2.6			09.90	08.93	24.2520-0904.3	040037		Nz 20,64
	3.0		M1000001		08.93				
	3.0 24V			08.89	08.93				
	1.8	◀		08.86		24.3728-0714.2	590714		L=1190
	2.0	◀		08.86					
	1.8	◀		08.93		24.3728-0719.2	590719		L=1226
	2.0	◀		08.93					
	2.3 D	◀	H1085389	08.93		24.3728-0717.2	590717		L=1248
	2.3 TD	◀	H1085389	08.93					
	2.4	◀		08.88	08.93				
	3.0	◀	K1000099						
			L1999999						
OPEL REKORD A (63-65)									
	1500	40		02.63	12.65	13.0460-4033.2	604033		20034 15,0 ATE
	1700	44		02.63	12.65				
	1700	49		02.63	12.65				
	1700	55		04.64	12.65				
	1700 Coupe	49		01.63	12.65				
	2600 Coupe	74		05.64	12.65				

1) - long wheel base / - passo lungo / - empattement long / - distancia larga entre ejes

2) transm.no. - 187545-87 / scatola cambio n. - 187545-87 / no.boîte vitesse - 187545-87 / no.de cambio - 187545-87

3) transm.no. 187546-87 - / scatola cambio n. 187546-87 - / no.boîte vitesse 187546-87 - / no.de cambio 187546-87 -



OPEL REKORD A (63-65)										
	1500	40		02.63	12.65		24.0111-0116.1	411116		238 11,0 8,0
	1700	44		02.63	12.65					
	1700	49		02.63	12.65					
	1700	55		04.64	12.65					
	1700 Coupe	49		01.63	12.65					
	2600 Coupe	74		05.64	12.65					
OPEL REKORD B (65-67)										
	1.9	66		08.65	12.66		13.0460-6027.2	606027		20011 15,0 ATE
	1.9 Coupe	66		08.65	02.67					
	1.5	44		08.65	12.66		13.0460-4033.2	604033		20034 15,0 ATE
	1.5 Caravan	44		08.65	12.66					
	1.7	55		08.65	12.66					
	1.7 Caravan	55		08.65	12.66					
	1.7 Coupe	55		08.65	12.66					
	1.9	55		09.65	12.66					
	1.5	44		08.65	12.66		24.0111-0116.1	411116		238 11,0 8,0
	1.5 Caravan	44		08.65	12.66					
	1.7	55		08.65	12.66					
	1.7 Caravan	55		08.65	12.66					
	1.7 Coupe	55		08.65	12.66					
	1.9	55		09.65	12.66					
	1.9	66		08.65	12.66					
	1.9 Coupe	66		08.65	02.67					
OPEL REKORD C (66-71)										
	1.5	43		08.66	12.71		13.0460-4033.2	604033		20034 15,0 ATE
	1.5 Caravan	43		08.66	12.71					
	1.5 Caravan	44		02.68	12.71					
	1.7	44		08.66	12.71					
	1.7	49		02.68	12.71					
	1.7 Caravan	44		08.66	12.71					
	1.7 Caravan	49		02.68	12.71					
	1.7 S	55		08.66	12.71					
	1.7 S Caravan	55		08.66	12.71					
	1.7 S Coupe	55		08.66	12.71					
	1.9	66		08.66	12.71					
	1.9 Caravan	66		08.66	12.71					
	1.9 Coupe	66		08.66	12.71					
	1.9 Sprint	78		08.67	12.71		13.0460-6027.2	606027		20011 15,0 ATE
	2.2	70		08.66	12.71					
	1.5	43		08.66	12.71		24.0111-0116.1	411116		238 11,0 8,0
	1.5 Caravan	43		08.66	12.71					
	1.5 Caravan	44		02.68	12.71					
	1.7	44		08.66	12.71					
	1.7	49		02.68	12.71					
	1.7 Caravan	44		08.66	12.71					
	1.7 Caravan	49		02.68	12.71					
	1.7 S	55		08.66	12.71					
	1.7 S Caravan	55		08.66	12.71					
	1.7 S Coupe	55		08.66	12.71					
	1.9	66		08.66	12.71					
	1.9 Caravan	66		08.66	12.71					
	1.9 Coupe	66		08.66	12.71					
	2.2	70		08.66	12.71					
	1.9 Sprint	78		08.67	12.71		24.0113-0126.1	413126		271 12,7 9,7
OPEL REKORD D / Vauxhall Carlton (72-77)										
	1.7 S			01.74	12.77 + (OK)		03.2120-1981.3	010105	+ Behälter 1)	THz 20,64 DEL
	1.9			01.74	12.77					
	2.0			01.75	12.77					
	2.0 D			08.74	12.77					
	1.7			01.72	12.77		03.3508-7504.3	310045		Behälter ATE
	1.9			01.72	12.77					
	2.0			01.75	12.77					
	2.1 D			01.72	12.77					
	1.7			01.72	12.77		13.0441-4825.2	250107		Dichtungssatz ATE
	1.9			01.72	12.77					
	2.0			01.75	12.77					
	2.1 D			01.72	12.77					
	1.7			01.72	09.73		13.0460-4035.2	604035		20173 15,0 ATE
	1.9			01.72	09.73		13.0460-0038.2	610038		Belagsatz-Zubehör ATE
	2.1 D			01.72	09.73					
	1.7			10.73	12.77		13.0460-5030.2	605030		20323 16,5 ATE
	1.9			10.73	12.77					
	2.0			01.75	12.77					
	2.1 D			10.73	12.77					
	1.7 Caravan		51041820	01.72			24.0111-0116.1	411116		238 11,0 8,0
	1.7 Limousine		51041820	01.72						
	1.9 Caravan		51041820	01.72						
	1.9 Limousine		51041820	01.72						
	2.1 D Caravan		5860629	01.72						
	2.1 D Limousine		5861688	01.72						
	1.7 Caravan	51041821		12.77			24.0113-0125.1	413125		246 12,7 9,7
	1.7 Limousine	51041821		12.77						
	1.9 Caravan	51041821		12.77						

1) + reservoir / + serbatoio / + réservoir / + recipiente

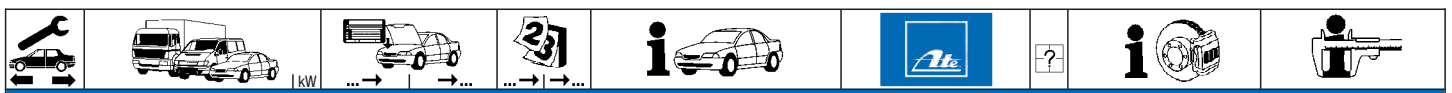

OPEL REKORD D / Vauxhall Carlton (72-77)

	1.9 Limousine 2.0 Limousine 2.1 D Caravan 2.1 D Limousine	51041821 5860630 5861689		01.75 12.77 12.77 12.77	12.77 12.77 12.77 12.77		24.0113-0125.1	413125		246 12,7 9,7
	1.7 2.1 D			01.72 01.72	12.77 09.73	- (S)	03.3215-1701.3	020015		Rz 15,87
	1.7 1.9 2.0 2.1 D			01.72 01.72 01.75 10.73	12.77 12.77 12.77 12.77	+ (S)	03.3219-4202.3	020050		Rz 19,05
	1.7 1.9 2.0 2.1 D			01.72 01.72 01.75 01.72	12.77 12.77 12.77 12.77		03.0137-0108.2 03.0137-9014.2	650108 669014		230 x 51 HEB Bremsbacken-Zubehör
	1.7 1.9 2.0 2.1 D			01.72 01.72 01.75 01.72	12.77 12.77 12.77 12.77		24.0223-0008.2	480038		230/231 x 60

OPEL REKORD E / Vauxhall Carlton (77-86)

	1.7 1.9 2.0 D 2.1 D 2.3 D			01.77 01.77 01.81 01.77 01.79	09.82 09.82 09.82 12.80 09.82		03.2120-0538.3	010077		THz 20,64	ATE
	1.7 1.8 1.9 2.0 2.0 D 2.3 D			10.82 10.82 10.82 10.82 10.82 10.82	08.84 08.84 08.84 08.84 08.83 08.84		03.2122-8806.3 03.3510-0059.1	010157 390270	bis 08.83 mitverwenden 1)	THz 22,20 Schraubstutzen	ATE ATE
	1.7 1.9 2.0 2.0 D Limousine 2.1 D Limousine 2.3 D Limousine			01.77 01.77 01.77 01.81 01.77 01.79	10.82 10.82 10.82 12.82 12.80 10.82	+ verstärkte Bremse 2) + verstärkte Bremse 2) + Automatikgetriebe 4) + Automatikgetriebe 4) + Automatikgetriebe 4)	03.2120-1981.3	010105	Kennzeichen: H/ + Behälter 3)	THz 20,64	DEL
	1.7 1.9 2.0 2.0 D 2.1 D 2.3 D			01.77 01.77 01.77 01.81 01.77 01.79	09.82 09.82 09.82 09.82 12.80 09.82	+ Festsättel 5) + Festsättel 5) + Festsättel 5) + Festsättel 5) + Festsättel 5) + Festsättel 5)	13.0441-4825.2	250107		Dichtungssatz	ATE
	1.7 1.9 2.0 2.0 D 2.1 D 2.3 D		D1000028 D1000028 D1000028 D1000028 D1000028	01.79 01.79 01.79 01.81 01.79	+ Faustsättel 6) + Faustsättel 6) + Faustsättel 6) + Faustsättel 6) + Faustsättel 6)		11.0441-4803.2 11.0101-4802.2	250018 260007		Dichtungssatz Hülssensatz	ATE ATE
	2.0 E 2.2 E	F1000189	F1076856	09.85 12.86	- ABS/ - verstärkte Bremse 7)		11.0101-4802.2	260007		Hülssensatz	ATE
	alle Typen alle Typen alle Typen			01.84 01.77 01.77	12.86 12.86 12.86	+ ABS + verstärkte Bremse 2) - ABS/ + verstärkte Bremse 8)	11.0101-4802.2	260007		Hülssensatz	ATE
	alle Typen alle Typen			01.77 01.79	12.82 12.86	+ Festsättel 5) + Faustsättel 6)	24.0101-4801.2	990131		Bremssattel-Zubehör	DEL
	alle Typen			01.79	12.86	+ Faustsättel 6)	13.0460-5030.2	605030		20323 16,5	ATE
	1.7 1.8 1.9 2.0 2.0 D 2.0 E 2.1 D 2.3 D 2.3 TD	D1000029	F1000188	01.77 10.82 01.77 01.77 01.81 01.77 01.79 01.84	12.86 12.86 12.86 12.86 12.83 12.80 12.86 12.86	- ABS/ - verstärkte Bremse 7) - ABS/ - verstärkte Bremse 7) - ABS/ - verstärkte Bremse 7) - ABS/ - verstärkte Bremse 7) - ABS - ABS - ABS - ABS/ - verstärkte Bremse 7) - ABS/ - verstärkte Bremse 7)	24.0113-0125.1	413125		246 12,7 9,7	
	2.0 E 2.2 E	F1000189	F1076856	09.85 12.86	- ABS - ABS		24.0123-0100.1	423100		246 23,0 21,0 V	ATE
	2.0 E	F1076857			12.86	- ABS	24.0113-0125.1	413125		246 12,7 9,7	
	1.7 1.8 1.9 2.0 2.0 D 2.1 D 2.2 E 2.3 D 2.3 TD			01.77 10.82 01.77 01.77 01.81 01.77 09.85 01.79 01.84	09.82 12.86 09.82 09.82 09.82 12.80 12.86 09.82 12.86	+ Festsättel 5) + Festsättel 5) + Festsättel 5) + Festsättel 5) + Festsättel 5) + Festsättel 5) + Festsättel 5) + Festsättel 5) + Festsättel 5)	83.6267-0285.3	330332	2	L=285	
	1.7 Limousine 1.8 N Limousine 1.9 Limousine			01.77 10.82 01.77	09.82 12.86 09.82	- verstärkte Bremse 11) - verstärkte Bremse 11) - verstärkte Bremse 11)	03.3215-1701.3	020015		Rz 15,87	
	1.7 Limousine 1.8 N Limousine	F1000188		01.77 10.82	09.82 12.86	+ verstärkte Bremse 2) + verstärkte Bremse 2)	03.3219-4202.3	020050		Rz 19,05	

1) reuse up to 08.83 / riutilizzare fino a 08.83 / utiliser jusqu'au 08.83 / hasta 08.83 emplear

2) + heavy duty brake / + freno reforzado / + frein renforcé / + freno reforzado

3) registration no.: H/ + reservoir / targa: H/ + serbatoio / indice: H/ + réservoir / distintivo: H/ + recipiente

4) + autom. transmission / + scatola cambio automatico / + transmission automatique / + cambio automático

5) + fixed calipers / + pinze freno fisse / + étriers fixes / + pinza de fija

6) + fist type calipers / + pinza freno flottante / + étriers à griffe / + pinza de puno

7) - ABS/ - heavy duty brake / - ABS/ - freno reforzado / - ABS/ - frein renforcé / - ABS/ - freno reforzado

8) - ABS/ + heavy duty brake / - ABS/ + freno reforzado / - ABS/ + frein renforcé / - ABS/ + freno reforzado

9) - ventilated discs / - dischi ventilati / - disques ventilés / - disco ventilado

10) + ventilated discs / + dischi ventilati / + disques ventilés / + disco ventilado

11) - heavy duty brake / - freno reforzado / - frein renforcé / - freno reforzado





OPEL REKORD E / Vauxhall Carlton (77-86)

	1.9 Limousine		F1000188	01.77	01.81	+ verstärkte Bremse ¹⁾	03.3219-4202.3	020050		Rz 19,05	
	2.0 D Limousine				09.82						
	2.0 Limousine		F1000188	01.77		- s					
	2.1 D Limousine			01.77	12.80						
2.3 D Limousine			01.79	09.82							
	1.7 Limousine	F1000189		12.86			24.3219-1111.3	020194		Rz 19,05	TRW
	1.8 Limousine	F1000189		12.86							
	1.9 Limousine	F1000189		12.86							
	2.0 D Limousine			10.82	12.83						
	2.0 Limousine	F1000189		12.86							
	2.2 E		F1000128	09.85							
	2.3 D Limousine			10.82	12.86						
	2.3 TD Limousine			09.84	12.86						
	1.7 Caravan		F1000188	01.77			03.3222-6903.3	020084		Rz 22,20	
	1.8 Caravan		F1000188	10.82							
	1.9 Caravan		F1000188	01.77							
	2.0 Caravan		F1000188	01.77							
	2.0 D Caravan			01.81	12.83						
	2.0 E			01.77	12.86	+ s					
	2.1 D Caravan			01.77	12.80						
	2.3 D Caravan		F1000188	01.79							
	1.7			01.77	07.82		03.0137-0108.2	650108		230 x 51 HEB	
	1.9			01.77	07.82		03.0137-9014.2	669014	- autom. Nachstellung ²⁾	Bremsbacken-Zubehör	
	2.0			01.77	07.82						
	2.0 D			01.81	07.82						
	2.1 D			01.77	12.80						
	2.3 D			01.79	07.82						
	2.3 TD			09.84	12.86						
	1.7			08.82	12.86		03.0137-0167.2	650167	+ autom. Nachstellung ³⁾	230 x 51 HEB	TRW
	1.8			10.82	12.86		03.0137-9053.2	669053		Bremsbacken-Zubehör	TRW
	1.9			08.82	12.86						
	2.0			08.82	12.86						
	2.0 D			08.82	12.83						
	2.2 E			09.85	12.86						
	2.3 D			08.82	12.86						
	2.3 TD			09.84	12.86						
	1.7			01.77	12.86		24.0223-0008.2	480038		230/231 x 60	
	1.8			10.82	12.86						
	1.9			01.77	12.86						
	2.0			01.77	12.86						
	2.0 D			01.81	12.83						
	2.1 D			01.77	12.80						
	2.2 E			09.85	12.86						
	2.3 D			01.79	12.86						
	2.3 TD			09.84	12.86						
		diverse Typen Caravan			01.77	12.86		03.0101-0014.2	320004		BRES 3/25
	1.7	◀	D1000029		12.86		24.3728-0706.2	590706		L=1005	
	2.0	◀		09.85	12.86						
	2.2 E	◀	22E0028062	09.85							
	1.8	◀		10.82	12.86		24.3728-0709.2	590709		L=1020	

OPEL SENATOR A / MONZA / Vaux. Royal (78-87)

	2.0	◀		E1000072	12.82		03.2123-4911.3	010182		Thz 23,81	ATE	
	2.5	◀		E1000072	06.78							
	2.8	◀			06.78	04.81						
	3.0	◀		E1000072	06.78							
	2.5			11110928	06.78		13.0441-5411.2	250114		Dichtungssatz	ATE	
	2.8				06.78	04.81						
	3.0			11110928	06.78							
	2.0			E1019586		12.84	- Klimaanlage ⁴⁾	11.0441-4803.2	250018		Dichtungssatz	ATE
							11.0101-4802.2	260007		Hülsensatz	ATE	
	2.0			E1019586		10.84	+ Klimaanlage ⁵⁾	11.0441-6003.2	250037		Dichtungssatz	ATE
	2.2				11.84	08.87		11.0101-5407.2	260011		Hülsensatz	ATE
	2.3 TD				11.84	08.87		11.8171-0008.1	990049		Führungsbolzen	ATE
	2.5			E1019586	08.87							
	3.0			E1019586	08.87							
		2.0			E1019585	12.82	+ Festsättel ⁶⁾	13.0460-4048.2	604048		20011 15,0 / WE	ATE
		2.5			E1019585	06.78	+ Festsättel ⁶⁾	13.0460-0165.2	610165	+ belüftete Scheiben ⁷⁾	Belagsatz-Zubehör	ATE
2.8					06.78	04.81						
3.0				E1019585	06.78	+ Festsättel ⁶⁾						
	2.0			E1019585	12.82	+ Klimaanlage ⁵⁾	24.0122-0109.1	422109		271 22,0 19,0 V		
	2.5			E1019585	06.78							
	2.8				06.78	04.81						
	3.0			E1019585	06.78							
	2.0			E1019586		10.84		24.0122-0126.1	422126		271 22,0 19,0 V	
	2.2				11.84	08.87						
	2.3 TD				11.84	08.87						
	2.5			E1019586	08.87							
	3.0			E1019586	08.87							
	2.0			E1019585	06.78		83.6267-0285.3	330332	2		L=285	
	2.2			E1019585	06.78							
	2.3 TD			E1019585	11.84							
	2.5			E1019585	06.78							
	2.8				06.78	04.81						
	2.8				06.78	04.81						

1) + heavy duty brake / + freno rinforzato / + frein renforcé / + freno reforzado
 2) - automatic adjustment / - correzione automatica / - ajustage automatique / - reajuste automatico
 3) + automatic adjustment / + correzione automatica / + ajustage automatique / + reajuste automatico
 4) - air conditioning / - aria condizionata / - air conditionné / - aire acondicionado
 5) + air conditioning / + aria condizionata / + air conditionné / + aire acondicionado
 6) + fixed calipers / + pinze freno fisse / + étriers fixes / + pinza de fija
 7) + ventilated discs / + dischi ventilati / + disques ventilés / + disco ventilado



OPEL SENATOR A / MONZA / Vaux. Royal (78-87)

	3.0		E1019585	06.78		83.6267-0285.3	330332	2		L=285
	2.0 2.2 2.3 TD 2.5 2.8 3.0			12.82 11.84 11.84 06.78 06.78 06.78	10.84 08.87 08.87 08.87 04.81 08.87	24.0111-0127.1	411127			279 10,5 8,5 +B
	2.0 2.2 2.3 TD 2.5 2.8 3.0			12.82 11.84 11.84 06.78 06.78 06.78	10.84 08.87 08.87 08.87 04.81 08.87	03.0137-0172.2 03.0137-9092.2	650172 669092			160 x 25 Bremsbacken-Zubehör

OPEL SENATOR B / Vauxhall Royal (88-93)

	2.5 2.6 3.0 3.0 24V			09.90 08.90 09.87 08.89	09.93 + ABS 09.93 + ABS 09.93 + ABS 09.93 + ABS	03.2023-0642.3	010026			THz 23,81/20,64	ATE
	2.5 2.6 3.0 3.0 24V		L1999999 L1999999 L1999999	09.90 08.90 09.87		11.0441-6003.2 11.0101-5407.2 11.8171-0008.1	250037 260011 990049			Dichtungssatz Hülzensatz Führungsbolzen	ATE ATE
	2.5 2.6 3.0 3.0 24V	M1000001 M1000001 M1000001		09.93 09.93 09.93 08.89		24.3571-1705.5 24.3571-1706.5 24.0101-3401.2	240069 240070 260043	<input type="checkbox"/> <input type="checkbox"/>		D=57, - Halter D=57, - Halter Bremsattel-Zubehör	TRW TRW TRW
	2.5 2.6 3.0 3.0 24V		K1000098 K1000098 K1000098	09.90 08.90 09.87		24.8190-0703.2	620703	2		Warnkontakt L=860mm	
	2.5 2.6 3.0 3.0 24V	K1000099 K1000099 K1000099	M1000000 M1000000 M1000000			24.8190-0709.2	620709	2		Warnkontakt L=660mm	
	2.5 2.6 3.0 3.0 24V	M1000001 M1000001 M1000001		09.93 09.93 09.93 08.89		13.0460-2815.2 24.8190-0716.2	602815 620716	2		21368 18,3 /WE/S Warnkontakt L=680mm	TRW
	2.5 2.6 3.0 3.0 24V		L1999999 L1999999 L1999999	09.90 08.90 09.87		24.0124-0110.1	424110			280 24,0 21,0 V	
	2.5 2.6 3.0 3.0 24V	M1000001 M1000001 M1000001		09.93 09.93 09.93 08.89		24.0128-0104.1	428104			296 28,0 25,0 V L +S +B	
	2.5 2.6 3.0 3.0 24V			09.90 08.90 09.87 08.89	09.93 09.93 09.93 09.93	13.0460-4040.2 13.0460-0347.2 13.0460-0198.2	604040 610347 610198			21050 15,8 Belagsatz-Zubehör Belagsatz-Zubehör	ATE ATE
	2.5 2.6 3.0 3.0 24V			09.90 08.90 09.87 08.89	09.93 09.93 09.93 09.93	24.0110-0191.1	410191			270 10,0 8,0 +B	
	2.5 2.6 3.0 3.0 24V			09.90 08.90 09.87 08.89	09.93 09.93 09.93 09.93	24.5233-0200.3	330425	2		L=198	
	2.5 2.6 3.0 3.0 24V			09.90 08.90 09.87 08.89	09.93 09.93 09.93 09.93	03.0137-0172.2 03.0137-9092.2	650172 669092			160 x 25 Bremsbacken-Zubehör	
	2.5 2.6 3.0 3.0 24V			09.90 08.90 09.87 08.89	09.93 09.93 09.93 09.93	24.3727-0725.2	580725	1	<input type="checkbox"/>	L=1550/1550, + Zub	
	2.6 3.0 3.0 24V			08.90 09.87 08.89	09.93 09.93 09.93	24.2419-0938.3	030064			Gz 19,05	
	2.6 3.0 3.0 24V			08.90 09.87 08.89	09.93 09.93 09.93	24.2520-0904.3	040037			Nz 20,64	
	2.5		K1000099		09.93	24.3728-0717.2	590717			L=1248	

OPEL VECTRA A / Vauxhall Cavalier (89-95)

	1.4 1.6 1.7 D 1.7 TD 1.8 1.8 4x4		N5299999 N5299999 N5299999 N5299999 N5299999	09.88 09.88 09.88 09.88 09.88 09.88	- ABS - ABS - ABS - ABS - ABS - ABS	24.2120-0913.3	010392		Kennzeichen: EA ¹⁾	THz 20,64	DEL
	1.4 1.6	P1000001 P1000001		08.95 08.95	- ABS - ABS	24.2120-0702.3	010361		Kennzeichen: EB/nicht für Delco BKV ²⁾	THz 20,64	

¹⁾ registration number: EA / targa: EA / indice: EA / distiutivo: EA

²⁾ registration no.: EB/not for Delco BKV / targa: EB/non per Delco BKV / indice: EB/sans pour Delco BKV / distiutivo: EB/no para Delco BKV





OPEL VECTRA A / Vauxhall Cavalier (89-95)

	1.7 D 1.7 TD 1.8	P1000001 P1000001 P1000001		08.95 - ABS 08.95 - ABS 08.95 - ABS	24.2120-0702.3	010361	Kennzeichen: EB/nicht für Delco BKV ¹⁾	Thz 20,64	
	2.0 2.0 2.0 2.0 16V 2.0 16V 2.0 16V		NV129999 N5299999 N1299999 NV129999 N5299999 N1299999	09.88 09.88 09.88 09.88 09.88 09.88	- ABS - ABS - ABS - ABS - ABS - ABS	03.2122-0264.3	010129	Thz 22,20	ATE
	2.0 2.0 2.0 2.0 16V 2.0 16V 2.0 16V	P1000001 P5000001 P7000001 P1000001 P5000001 P7000001		08.95 - ABS 08.95 - ABS 08.95 - ABS 08.95 - ABS 08.95 - ABS 08.95 - ABS	03.2122-0264.3	010129		Thz 22,20	ATE
	1.4 1.6 1.7 D 1.7 TD 1.8 1.8 4x4 2.0 2.0 16V			09.88 09.88 09.88 09.88 09.88 09.88 09.88 09.88	08.95 + ABS 08.95 + ABS 08.95 + ABS 08.95 + ABS 08.89 + ABS 08.95 + ABS 08.95 + ABS	03.2122-0282.3	010130	Thz 22,20	ATE
	2.0 Turbo 2.5 i			03.92 02.93	08.95 08.95	03.2123-1121.3	010176	Thz 23,81	ATE
	1.4 1.4 1.6 1.6 1.7 D 1.7 D 1.7 TD 1.7 TD 1.8 1.8		N1038529 M5999999 N1038529 M5999999 N1038529 M5999999 N1038529 M5999999 N1038529 M5999999	09.88 09.88 09.88 09.88 09.88 09.88 09.88 09.88 09.88 09.88		11.0441-4803.2 11.0101-4802.2	250018 260007	Dichtungssatz Hülensatz	ATE ATE
	1.4 1.4 1.6 1.6 1.7 D 1.7 D 1.7 TD 1.7 TD 1.8 1.8	N1038530 N5000001 N1038530 N5000001		08.95 08.95 08.95 08.95		11.9481-9871.2 11.9481-9872.2 11.0441-4811.2 11.0101-5407.2	220681 220682 250024 260011	D=48, - Halter D=48, - Halter Dichtungssatz Hülensatz	ATE ATE ATE ATE
	1.7 D 1.7 D 1.7 D 1.7 TD 1.8 1.8 2.0 2.0 16V	S1000001 S5000001 S5000001 S1000001 S1000001 S5000001	R5999999 R1999999 R5999999	08.95 08.95 08.95 08.95 08.95 08.95		24.3521-1701.5 24.3521-1702.5 11.0441-5202.2 11.0101-5407.2 11.8171-0008.1 11.8116-0097.1	240001 240002 250026 260011 990049 390590	D=52, - Halter D=52, - Halter Dichtungssatz Hülensatz Führungsbolzen Haltefeder	ATE ATE ATE ATE ATE ATE
	1.8 4x4 2.0 16V 4x4 2.0 4x4			09.88 09.88 09.88	08.89 08.95 08.95	11.0441-5402.2 11.0101-5407.2 11.8171-0008.1 11.8116-0097.1	250028 260011 990049 390590	Dichtungssatz Hülensatz Führungsbolzen Haltefeder	ATE ATE ATE ATE
	2.0 Turbo 2.5 i			03.92 02.93	08.95 08.95	24.3541-8086.5 24.3541-8085.5 11.0101-5407.2 11.8171-0008.1 11.8116-0129.1	240526 240525 260011 990049 390591	D=54, - Halter D=54, - Halter Hülensatz Führungsbolzen Haltefeder	ATE ATE ATE ATE ATE
	1.4 1.4 1.6 1.6 1.7 D 1.7 D 1.7 TD 1.7 TD 1.8 1.8		N1038529 M5999999 N1038529 M5999999 N1038529 M5999999 N1038529 M5999999 N1038529 M5999999	09.88 09.88 09.88 09.88 09.88 09.88 09.88 09.88 09.88 09.88		13.0460-7048.2 13.0460-0127.2 24.8190-0704.2	607048 610127 620704	20939 15,8 /WE Belagsatz-Zubehör Warnkontakt L=660mm	DEL DEL
	1.4 1.4 1.6 1.6 1.7 D 1.7 D 1.7 TD 1.7 TD 1.8 1.8	N1038530 N5000001 N1038530 N5000001	R5999999 R1999999 R5999999	08.95 08.95 08.95		13.0460-7051.2 24.8190-0707.2	607051 620707	20547 16,5 +/WE Warnkontakt L=685mm	ATE
	1.7 D 1.7 D 1.7 TD 1.7 TD	S1000001 S5000001 S1000001 S5000001		08.95 08.95 08.95 08.95		13.0460-7052.2 24.8190-0705.2	607052 620705	21190 17,5 +/WE Warnkontakt L=670mm	ATE

¹⁾ registration no.: EB/not for Delco BKV / targa: EB/non per Delco BKV / indice: EB/sans pour Delco BKV / distiutivo: EB/no para Delco BKV

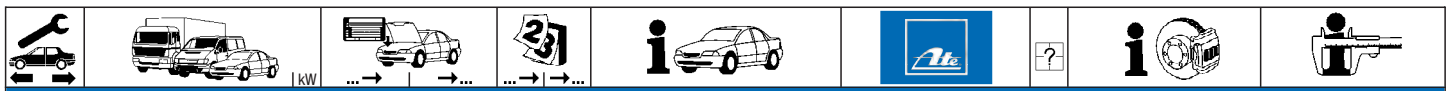

OPEL VECTRA A / Vauxhall Cavalier (89-95)

	1.8	S1000001		08.95		13.0460-7052.2	607052		21190 17,5 +WE Warnkontakt L=670mm	ATE		
	1.8	S5000001		08.95		24.8190-0705.2	620705	2				
	1.8 4x4			09.88	08.89							
	2.0			09.88	08.95							
	2.0 16V			09.88	08.95							
	2.0 16V 4x4			09.88	08.95							
2.0 4x4			09.88	08.95								
2.0 Turbo			03.92	08.95		13.0460-7080.2	607080		21411 17,5 + Warnkontakt L=685mm	ATE		
2.5 i			02.93	08.95		24.8190-0707.2	620707	2				
	1.4		N1038529	09.88		24.0113-0161.1	413161		236 12,7 9,7 +S +B 236 12,7 9,7 +S +B PD			
	1.4		M5999999	09.88		24.0313-0161.1	513161					
	1.6		N1038529	09.88								
	1.6		M5999999	09.88								
	1.7 D		N1038529	09.88								
	1.7 D		M5999999	09.88								
	1.7 TD		N1038529	09.88								
	1.7 TD		M5999999	09.88								
	1.8		N1038529	09.88								
	1.8		M5999999	09.88								
	1.4		N1038530		08.95		24.0120-0115.1	420115			236 20,0 17,0 V L +S +B 236 20,0 17,0 V L +S +B PD	
	1.4		N5000001		08.95		24.0320-0115.1	520115				
	1.6		N1038530		08.95							
	1.6		N5000001		08.95							
1.7 D		N5000001	R5999999			24.0120-0140.1	420140		256 20,0 17,0 V L +S +B			
1.7 D		N1038530	R1999999									
1.7 TD		N5000001	R5999999									
1.7 TD		N1038530	R1999999									
1.8		N5000001	R5999999									
1.8		N1038530	R1999999									
1.7 D		S1000001		08.95		24.0124-0115.1	424115		256 24,0 21,0 V L +S +B 256 24,0 21,0 V L +S +B PD			
1.7 D		S5000001		08.95		24.0324-0115.1	524115					
1.7 TD		S1000001		08.95								
1.7 TD		S5000001		08.95								
1.8		S1000001		08.95								
1.8		S5000001		08.95								
1.8 4x4			09.88	08.89								
2.0			09.88	08.95								
2.0 16V			09.88	08.95								
2.0 16V 4x4			09.88	08.95								
2.0 4x4			09.88	08.95								
2.0 Turbo			03.92	08.95		24.0124-0133.1	424133					
2.5 i			02.93	08.95								
	1.4			09.88	08.95	24.5298-0322.3	331314	2		L=322		
	1.6			09.88	08.95							
	1.7 D			09.88	08.95							
	1.7 TD			09.88	08.95							
	1.8			09.88	08.95							
	1.8 4x4			09.88	08.89							
	2.0			09.88	08.95							
	2.0 16V			09.88	08.95							
	2.0 16V 4x4			09.88	08.95							
	2.0 4x4			09.88	08.95							
	2.0 Turbo			03.92	08.95							
	2.5 i			02.93	08.95							
		2.0			09.88	08.95	13.2351-0013.2	210010	<input type="checkbox"/>		D=35 D=35 D=35 D=35 Dichtungssatz	ATE ATE ATE ATE ATE
		2.0 16V			09.88	08.95	13.2351-0014.2	210011	<input type="checkbox"/>			
2.5 i				02.93	08.95	24.9235-0013.5	230001	<input type="checkbox"/>				
						24.9235-0014.5	230002	<input type="checkbox"/>				
					13.0441-3506.2	250052	<input type="checkbox"/>					
	1.8 4x4			09.88	08.89	13.0460-4043.2	604043		21140 15,0 Belagsatz-Zubehör	ATE ATE		
	2.0			09.88	08.95	13.0460-0217.2	610217					
	2.0 16V			09.88	08.95							
	2.0 16V 4x4			09.88	08.95							
	2.0 4x4			09.88	08.95							
	2.0 Turbo			03.92	08.95							
	2.5 i			02.93	08.95							
	1.8 4x4		NV299999	09.88	08.89	24.0110-0205.1	410205		270 9,9 8,0 +B			
	2.0 16V		N5299999	09.88								
	2.0 16V		N1299999	09.88								
	2.0 16V 4x4			09.88	08.95							
	2.0 4x4			09.88	08.95							
	2.0		NV299999	09.88		24.0110-0144.1	410144			261 9,9 8,0		
	2.0		N5299999	09.88								
	2.0		N1299999	09.88								
	2.0		P1000001		08.95		24.0110-0204.1	410204			260 10,0 8,0 +B	
	2.0 16V		P1000001		08.95							
2.0 Turbo			03.92	08.95		24.0110-0253.1	410253		270 10,0 8,0			
2.5 i			02.93	08.95		24.0110-0249.1	410249		260 10,0 8,0			
	1.4		N5999999	09.88		24.5233-0200.3	330425	2	L=198			
	1.6		N5999999	09.88								
	1.7 D		N5999999	09.88								
	1.7 TD		N5999999	09.88								
	1.8		N5999999	09.88								
	1.8 4x4			09.88	08.89							





OPEL VECTRA A / Vauxhall Cavalier (89-95)

	2.0		N5999999	09.88		24.5233-0200.3	330425	2		L=198
	2.0 16V		N5999999	09.88						
	2.0 16V 4x4		N5999999	09.88						
	2.0 4x4		N5999999	09.88						
	2.0 Turbo		N5999999	03.92						
	2.5 i		N5999999	02.93						
	1.4	P1000001		08.95		24.5117-0195.3	330565	2		L=198
	1.6	P1000001		08.95						
	1.7 D	P1000001		08.95						
	1.7 TD	P1000001		08.95						
	1.8	P1000001		08.95						
	2.0	P1000001		08.95						
	2.0 16V	P1000001		08.95						
	2.0 16V 4x4	P1000001		08.95						
	2.0 4x4	P1000001		08.95						
	2.0 Turbo	P1000001		08.95						
	2.5 i	P1000001		08.95						
	1.4			09.88	08.95	24.3219-1767.2	020552		+ GG ¹⁾	Rz 19,05
	1.6			09.88	08.95	24.3219-1715.3	020122		+ ALU ²⁾	Rz 19,05 (ALU)
	1.7 D			09.88	08.95					
	1.7 TD			09.88	08.95					
	1.8			09.88	08.95					
	1.4		N5999999	09.88		03.0137-0166.2	650166			200 x 46 HEB
	1.6		N5999999	09.88		03.0137-9060.2	669060			Bremsbacken-Zubehör
	1.7 D		N5999999	09.88						
	1.7 TD		N5999999	09.88						
	1.8		N5999999	09.88						
	1.8		N5999999	09.88						
	1.4	P1000001		08.95		03.0137-0267.2	650267			200 x 46 HEB
	1.6	P1000001		08.95		03.0137-9167.2	669167			Bremsbacken-Zubehör
	1.7 D	P1000001		08.95						
	1.7 TD	P1000001		08.95						
	1.8	P1000001		08.95						
	1.4			09.88	08.95	24.0220-0001.2	480013			200/201 x 53,5
	1.6			09.88	08.95					
	1.7 D			09.88	08.95					
	1.7 TD			09.88	08.95					
	1.8			09.88	08.95					
	1.4	P1000001		08.95		03.0420-4019.3	684019			19,05/200x46 Kit
	1.6	P1000001		08.95		03.0520-4019.3	694019			19,05/200x46 TopKit
	1.7 D	P1000001		08.95						
	1.7 TD	P1000001		08.95						
	1.8	P1000001		08.95						
	1.8 4x4		NV299999	09.88	08.89	03.0137-0172.2	650172			160 x 25
	2.0		NV299999	09.88		03.0137-9092.2	669092			Bremsbacken-Zubehör
	2.0 16V		NV299999	09.88						
	2.0 Turbo		NV299999	03.92						
	2.5 i		NV299999	02.93						
	2.0	P1000001		08.95		03.0137-0172.2	650172			160 x 25
	2.0 16V	P1000001		08.95		03.0137-9242.2	669242			Bremsbacken-Zubehör
	2.0 Turbo	P1000001		08.95						
	2.5 i	P1000001		08.95						
	2.5 i	P1000001		08.95						
	1.4			09.88	08.95	24.3727-0734.2	580734		<input type="checkbox"/>	L=750, + Zub
	1.6			09.88	08.95	24.3727-0733.2	580733		<input type="checkbox"/>	L=2120, + Zub
	1.7 D			09.88	08.95					
	1.7 TD			09.88	08.95					
	1.8			09.88	08.95					
	1.8 4x4		NV299999	09.88	08.89	24.3727-0736.2	580736	1	<input checked="" type="checkbox"/>	L=1365/1498, + Zub
	2.0 16V		NV299999	09.88						
	2.0 4x4		NV299999	09.88	08.95					
	2.0 Turbo		NV299999	03.92	08.95					
	2.0	P1000001		09.88	08.95	24.3727-0739.2	580739		<input type="checkbox"/>	L=665, + Zub
	2.0 16V	P1000001		08.95		24.3727-0740.2	580740		<input type="checkbox"/>	L=2022, + Zub
	2.5 i	P1000001		02.93	08.95					
	1.4	P1000001		08.95		03.0101-0027.2	320022			BRES 3/45
	1.6	P1000001		08.95						
	1.7 D	P1000001		08.95						
	1.7 TD	P1000001		08.95						
	1.8	P1000001		08.95						
	2.5 i			02.93	08.95	03.0101-0025.2	320014			BRES 3/35
	1.4			09.88	08.95	24.3728-0712.2	590712			L=835
	1.6			09.88	08.95					
	1.7 D			09.88	08.95					
	1.7 TD			09.88	08.95					
	1.8			09.88	08.95	24.3728-0715.2	590715			L=835
	2.0			09.88	08.95					
	2.0 16V			09.88	08.95					
	2.5 i			02.93	08.95					
	1.8 4x4			09.88	08.89	10.0515-0515.3	340024		+ Verteilergetriebe ³⁾	Hydraulikspeicher
	2.0 4x4			09.88	08.95					
2.0 Turbo 4x4			03.92	08.95						

¹⁾ + cast iron / + ghisa / + fonte grise / + fundición de gris

²⁾ + aluminium / + alluminio / + aluminium / + aluminio

³⁾ + distribution transmission / + differenziale centrale / + transmission 4x4 / + engranaje de distribución



PEUGEOT J7 (65-80)

	1.6 1.8 2.1 D 2.3 D			09.73 09.73 09.73 03.77	09.80 09.80 10.78 09.80	24.0114-0107.1	414107			280 14,0 12,6
	1.6 1.8 2.1 D 2.3 D			09.73 09.73 09.73 03.77	09.80 09.80 10.78 09.80	24.5122-0460.3	330493	4		L=460
	1.6 1.8 2.1 D 2.3 D			09.73 09.73 09.73 03.77	09.80 09.80 10.78 09.80	24.3225-0903.3	020327			Rz 25,40

PEUGEOT J5 (81-94)

	1.8 1.9 D 2.0 2.0 2.5 D 2.5 TD	51 55 58 54 70		11.81 10.87 11.81 11.81 11.81 10.87	06.94 06.94 06.94 06.94 06.94 06.94	24.2122-0801.3	010373		1 Anschluß verschließen ²⁾	THz 22,20
	1.8 1.9 D 2.0 2.0 2.5 D 2.5 TD	51 0154462 55 0154462 58 0154462 54 0154462 70		10.87 10.87	06.94 06.94 06.94 06.94 06.94 - 1,8 t 06.94 - 1,8 t	24.0101-3801.2	260045			Bremssattel-Zubehör TRW
	1.8 1.9 D 2.0 2.0 2.5 D 2.5 TD	51 55 58 54 70		11.81 10.87 11.81 11.81 10.87	06.94 06.94 06.94 06.94 06.94 - 1,8 t 06.94 - 1,8 t	13.0460-2901.2	602901			20741 19,0 +WK/S TRW
	1.8 1.9 D 2.0 2.0 2.5 D 2.5 TD	51 55 58 54 70		11.81 10.87 11.81 11.81 10.87	06.94 06.94 06.94 06.94 06.94 + 1,8 t 06.94 + 1,8 t	13.0460-2902.2	602902			21205 19,0 +WK/S TRW
	1.8 2.0 2.0 2.5 D 2.5 TD	51 55 58 54	0154461 0154461 0154461 0154461	11.81 11.81 11.81 11.81	 - 1,8 t	24.0113-0168.1	413168			256 13,0 11,0
	1.8 1.9 D 2.0 2.0 2.5 D 2.5 TD	51 0154462 55 0154462 58 0154462 54 0154462 70		10.87 10.87	06.94 06.94 06.94 06.94 - 1,8 t 06.94 - 1,8 t	24.0116-0105.1	416105			256 16,1 13,5 +B
	2.5 D 2.5 TD	54 70		11.81 10.87	06.94 + 1,8 t 06.94 + 1,8 t	24.0116-0106.1	416106			290 16,0 14,8
	1.8 2.0 2.0 2.5 D 2.5 TD	51 55 58 54		11.81 11.81 11.81 11.81	08.84 08.84 08.84 08.84	24.5112-0362.3	330512	4		L=362
	1.8 1.9 D 2.0 2.0 2.5 D 2.5 TD	51 55 58 54 70		09.84 10.87 09.84 09.84 10.87	06.94 06.94 06.94 06.94 06.94	24.5112-0435.3 24.5112-0436.3	330524 330574	2 2		L=435, + Clip L=435, - Clip
	1.8 2.0 2.0 2.5 D 2.5 TD	51 55 58 54 70		11.81 11.81 11.81 10.87	06.94 06.94 06.94 06.94 - 1,8 t	24.5112-0260.3	330577	1	▣	L=260
	1.9 D 2.5 D	54		10.87 11.81	06.94 06.94 - 1,8 t	24.5112-0285.3	330604	1	▣	L=285
	2.5 D 2.5 TD	54 70		11.81 10.87	06.94 + 1,8 t 06.94 + 1,8 t	24.5112-0285.3	330604	1	▣	L=285
	1.9 D 2.0 2.0 2.5 D 2.5 TD	55 0077160 58 0077160 54 0077160 70		10.87 10.87	06.94 - 0,8 t 06.94 06.94 06.94 - 1,8 t 06.94 - 1,8 t	24.3225-1101.3	020294			Rz 25,40 TRW
	2.5 D 2.5 TD	54 0077160 70		10.87 10.87	06.94 + 1,8 t 06.94 + 1,8 t	24.3226-1101.3	020296			Rz 26,99
	1.8 1.9 D 2.0 2.0 2.5 D 2.5 TD	51 55 58 54 70		11.81 10.87 11.81 11.81 11.81 10.87	06.94 06.94 06.94 06.94 06.94 - 1,8 t 06.94 - 1,8 t	03.0137-0330.2 03.0137-9216.2	650330 669216			254 x 57 HEB Bremsbacken-Zubehör TRW
	2.5 D 2.5 TD	54 70		11.81 10.87	06.94 + 1,8 t 06.94 + 1,8 t	03.0137-0269.2 03.0137-9169.2	650269 669169			254 x 57 HEB Bremsbacken-Zubehör
	1.8 1.9 D 2.0 2.0 2.5 D	51 55 58 54		11.81 10.87 11.81 11.81 11.81	06.94 06.94 06.94 06.94 06.94	24.0225-4002.1	480048			254/255,6 x 64,4

1) - bus / - autobus / - autobus/car / - autobús

2) 1 close (plug) connection / tappare 1 raccordo / fermer 1 raccord / cerrar 1 conexión



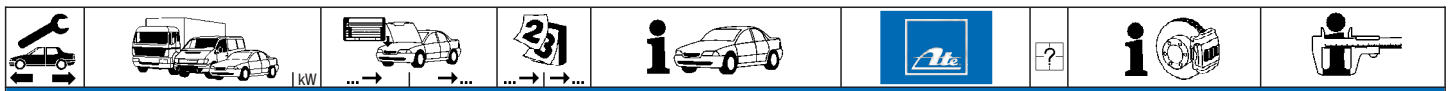

PEUGEOT J5 (81-94)

	2.5 TD	70		10.87	06.94		24.0225-4002.1	480048		254/255,6 x 64,4
	1.9 D			10.87	06.94	-0,8 t	03.0520-0125.3	690125		25,40/254x57 TopKit TRW
	2.0	55	0077160		06.94					
	2.0	58	0077160		06.94					
	2.5 D	54	0077160		06.94	-1,8 t				
	2.5 TD	70		10.87	06.94	-1,8 t				
	1.8	51		11.81	07.90		24.3727-0527.2	580527	1	L=2566
	1.9 D			10.87	07.90	-0,8 t				
	2.0	55		11.81	07.90					
	2.5 D	54		11.81	07.90					
	2.5 TD	70		10.87	07.90					
	1.8	51		11.81	07.90		24.6513-1701.3	320160		BRL 3/10 (4)
	2.0	58	0077159	11.81						
	2.5 D	54	0077159	11.81						
	1.8	51		11.81	07.90		24.3728-0515.2	590515		L=1200
	1.9 D	55		10.87	07.90					
	2.0	58		11.81	07.90					
	2.5 D	54		11.81	07.90					
	2.5 TD	70		10.87	07.90					

PEUGEOT J9 (80-92)

	1.6			01.80	12.92		24.0114-0107.1	414107		280 14,0 12,6
	2.0			01.80	12.92					
	2.1 D			01.80	12.92					
	2.3 D			01.80	09.82					
	2.5 D			10.82	12.92					
	1.6			01.80	12.92		24.5122-0460.3	330493	4	L=460
	2.0			01.80	12.92					
	2.1 D			01.80	12.92					
	2.3 D			01.80	09.82					
	2.5 D			10.82	12.92					
	1.6			01.80	10.85		24.3225-0903.3	020327		Rz 25,40
	2.0			01.80	10.85					
	2.1 D			01.80	10.85					
	2.3 D			01.80	09.82					
	2.5 D			10.82	10.85					

PEUGEOT 104 (72-87)

	1.1 GL6/SL	42	7.236.001	7.241.000			24.2117-1501.3	010398		THz 17,46
	1.0		5.937.571				24.2119-1503.3	010404		THz 19,05
	1.0		7.252.260		09.83					
	1.1	37	5.937.571		09.87					
	1.1	37	7.252.260		09.87					
	1.1	42	5.937.571		09.84					
	1.1	42	7.252.260		09.84					
	1.2		5.937.571		09.83					
	1.2		7.252.260		09.83					
	1.4		5.937.571		09.83					
	1.4		7.252.260		09.83					
	1.0				10.72	09.83	13.0460-3928.2	603928		20140 14,0 +/-WE BDX
	1.1	37			10.78	09.83				
	1.1	48			09.73	09.79				
	1.1 GR/SR	42			09.79	09.83				
	1.2				09.80	09.83				
	1.4				09.80	09.83				
	1.1	37			10.83	09.87	13.0460-3928.2	603928		20140 14,0 +/-WE BDX
	1.1 GR/SR	42			10.83	09.84				
	1.4				10.83	09.85				
	1.0		5.567.080			09.83	24.3222-1102.3	020257		Rz 22,20 BDX
	1.0		7.101.910			09.83				
	1.1	37	5.567.080			09.87				
	1.1	37	7.101.910			09.87				
	1.1 GR/SR	42	5.567.080			09.84				
	1.1 GR/SR	42	7.101.910			09.84				
	1.2		5.567.080			09.83				
	1.2		7.101.910			09.83				
	1.4		5.567.080			09.85				
	1.4		7.101.910			09.85				
	1.1 GL6/SL	42	7.236.001	7.241.000			24.3220-1105.3	020216		Rz 20,64 BDX
	1.0		7.000.001	7.101.099			03.0137-9032.2	669032		Bremsbacken-Zubehör BDX
	1.0			5.670.079	10.72					
	1.1	37	7.000.001	7.101.099						
	1.1	37		5.670.079	10.78					
	1.1	48	7.000.001	7.101.099						
	1.1	48		5.670.079	09.73					
	1.1 GR/SR	42	7.000.001	7.101.099						
	1.1 GR/SR	42		5.670.079	09.79					
	1.2		7.000.001	7.101.099						
	1.2			5.670.079	09.80					
	1.4		7.000.001	7.101.099						
	1.4			5.670.079	09.80					
	1.0		5.567.080			09.83	03.0137-9032.2	669032		Bremsbacken-Zubehör BDX
	1.0		7.101.910			09.83				

PEUGEOT 106 (91-96)										
	1.0			08.91	04.96	- ABS/ + 3 türig ¹⁾	24.5111-0290.3	330108	2	L=290
	1.1	44		08.91	04.96	- ABS/ + 3 türig ¹⁾				
	1.0			08.91	04.96	- ABS/ + 5 türig ²⁾	24.5111-0330.3	330160	2	L=330
	1.1	44		08.91	04.96	- ABS/ + 5 türig ²⁾				
	1.0			08.91	03.95	+ ABS	24.5111-0290.3	330108	2	L=290
	1.1	44		08.91	03.95	+ ABS				
	1.0			04.95	04.96	+ ABS	24.5111-0301.3	330499	2	L=300
	1.1	44		04.95	04.96	+ ABS				
	1.3 Rallye	72		10.93	03.95		24.5111-0290.3	330108	2	L=290
	1.4	51		08.91	03.96	- ABS				
	1.4	55		08.91	04.96	- ABS				
	1.4	69		08.91	04.96	- ABS				
	1.4	72		08.91	03.96	- ABS				
	1.4 D	37		08.92	04.96	- ABS				
	1.5 D			06.94	04.96	- ABS				
	1.6	65		06.93	04.96	- ABS				
	1.6	76		01.94	03.95					
	1.4	51		08.91	03.95	+ ABS	24.5111-0290.3	330108	2	L=290
	1.4	55		08.91	03.95	+ ABS				
	1.4	69		08.91	03.95	+ ABS				
1.4	72		08.91	03.95	+ ABS					
1.4 D	37		08.92	03.95	+ ABS					
1.5 D			06.94	03.95	+ ABS					
1.6	65		01.94	03.95	+ ABS					
1.3 Rallye	72		04.95	04.96		24.5111-0301.3	330499	2	L=300	
1.4	51		04.95	03.96	+ ABS					
1.4	55		04.95	04.96	+ ABS					
1.4	69		04.95	04.96	+ ABS					
1.4	72		04.95	03.96	+ ABS					
1.4 D	37		04.95	04.96	+ ABS					
1.5 D			04.95	04.96	+ ABS					
1.6	65		04.95	04.96	+ ABS					
1.6	76		04.95	04.96						
	1.0			08.91	04.96	- verstärktes Fahrwerk ³⁾	24.5229-0199.3	330534	2	L=200
	1.1	44		08.91	04.96	- verstärktes Fahrwerk ³⁾				
	1.3 Rallye	72		10.93	04.96	- verstärktes Fahrwerk ³⁾				
	1.4	51		08.91	03.96	- verstärktes Fahrwerk ³⁾				
	1.4	55		08.91	04.96	- verstärktes Fahrwerk ³⁾				
	1.4	69		08.91	04.96	- verstärktes Fahrwerk ³⁾				
	1.4	72		08.91	03.96	- verstärktes Fahrwerk ³⁾				
	1.4 D	37		08.92	04.96	- verstärktes Fahrwerk ³⁾				
	1.5 D			06.94	04.96	- verstärktes Fahrwerk ³⁾				
	1.6	65		06.93	04.96	- verstärktes Fahrwerk ³⁾				
	1.6	76		01.94	04.96	- verstärktes Fahrwerk ³⁾				
	1.0			08.91	04.96	+ verstärktes Fahrwerk ⁴⁾	24.5229-0199.3	330534		L=200
	1.1	44		08.91	04.96	+ verstärktes Fahrwerk ⁴⁾	24.5229-0211.3	330573		L=210
	1.3 Rallye	72		10.93	04.96	+ verstärktes Fahrwerk ⁴⁾				
	1.4	51		08.91	03.96	+ verstärktes Fahrwerk ⁴⁾				
	1.4	55		08.91	04.96	+ verstärktes Fahrwerk ⁴⁾				
	1.4	69		08.91	04.96	+ verstärktes Fahrwerk ⁴⁾				
	1.4	72		08.91	03.96	+ verstärktes Fahrwerk ⁴⁾				
	1.4 D	37		08.92	04.96	+ verstärktes Fahrwerk ⁴⁾				
	1.5 D			06.94	04.96	+ verstärktes Fahrwerk ⁴⁾				
1.6	65		06.93	04.96	+ verstärktes Fahrwerk ⁴⁾					
1.6	76		01.94	04.96	+ verstärktes Fahrwerk ⁴⁾					
	1.0			08.91	04.96	- ABS/ + 3 türig ¹⁾	24.3219-1609.3	020319	<input type="checkbox"/>	RzR 19,05
	1.1	44		08.91	04.96	- ABS/ + 3 türig ¹⁾	24.3219-1610.3	020320	<input type="checkbox"/>	RzR 19,05
	1.0			08.91	04.96	- ABS/ + 5 türig ²⁾	24.3219-1603.3	020200	<input type="checkbox"/>	RzR 19,05
	1.1	44		08.91	04.96	- ABS/ + 5 türig ²⁾	24.3219-1604.3	020201	<input type="checkbox"/>	RzR 19,05
	1.0			08.91	04.96	+ ABS	24.3219-1112.3	020311		Rz 19,05
	1.1	44		08.91	04.96	+ ABS				BDX
	1.3 Rallye	72		10.93	04.96	- ABS	24.3219-1609.3	020319	<input type="checkbox"/>	RzR 19,05
	1.4	51		08.91	03.96	- ABS	24.3219-1610.3	020320	<input type="checkbox"/>	RzR 19,05
	1.4	55		08.91	04.96	- ABS				
	1.4	69		08.91	04.96	- ABS				
	1.4	72		08.91	03.96	- ABS				
	1.4 D	37		08.92	04.96	- ABS				
	1.5 D			06.94	04.96	- ABS				
	1.6	65		06.93	04.96	- ABS				
	1.6	76		01.94	04.96	- ABS				
	1.3 Rallye	72		10.93	04.96	+ ABS	24.3219-1112.3	020311		Rz 19,05
	1.4	51		08.91	03.96	+ ABS				BDX
	1.4	55		08.91	04.96	+ ABS				
	1.4	69		08.91	04.96	+ ABS				
	1.4	72		08.91	03.96	+ ABS				
1.4 D	37		08.92	04.96	+ ABS					
1.5 D			06.94	04.96	+ ABS					
1.6	65		06.93	04.96	+ ABS					
1.6	76		01.94	04.96	+ ABS					
	1.0			08.91	04.96	- ABS/ + 3 türig ¹⁾	03.0137-0196.2	650196	<input type="checkbox"/>	180 x 32 AUT
	1.1	44		08.91	04.96	- ABS/ + 3 türig ¹⁾	03.0137-9055.2	669055	<input type="checkbox"/>	Bremsbacken-Zubehör
	1.0			08.91	04.96	- ABS/ + 5 türig ²⁾	03.0137-0195.2	650195	<input type="checkbox"/>	164 x 32 AUT
	1.1	44		08.91	04.96	- ABS/ + 5 türig ²⁾	03.0137-9079.2	669079	<input type="checkbox"/>	Bremsbacken-Zubehör

¹⁾ - ABS/ + 3 door / - ABS/ + 3 porte / - ABS/ + 3 portes / - ABS/ + 3 puertas

²⁾ - ABS/ + 5 door / - ABS/ + 5 porte / - ABS/ + 5 portes / - ABS/ + 5 puertas

³⁾ - reinforced suspension / - sospensione rinforzata / - châssis renforcé / - suspensión reforzada

⁴⁾ + reinforced suspension / + sospensione rinforzata / + châssis renforcé / + suspensión reforzada

⁵⁾ + 4 bore wheel rim / + cerchione a 4 fori / + jante à 4 trous / + Liantas de 4 taladros

⁶⁾ + 3 bore wheel rim / + cerchione a 3 fori / + jante à 3 trous / + Liantas de 3 taladros



PEUGEOT 106 (91-96)

	1.0			08.91	04.96 + ABS	03.0137-0196.2	650196		180 x 32 AUT	BDX
	1.1	44		08.91	04.96 + ABS	03.0137-9055.2	669055		Bremsbacken-Zubehör	BDX
	1.3 Rallye	72		10.93	04.96	03.0137-0196.2	650196		180 x 32 AUT	BDX
	1.4	51		08.91	03.96	03.0137-9055.2	669055		Bremsbacken-Zubehör	BDX
	1.4	55		08.91	04.96					
	1.4	69		08.91	04.96					
	1.4	72		08.91	03.96					
	1.4 D	37		08.92	04.96					
	1.5 D			06.94	04.96					
	1.6	65		06.93	04.96					
1.6	76		01.94	04.96						
	1.0			08.91	04.96 - ABS/ + 3 türig ¹⁾	24.0218-0017.1	480060		+ 4-Loch-Felge ²⁾	180/181 x 40,5 - Lager
	1.1	44		08.91	04.96 - ABS/ + 3 türig ¹⁾					
	1.0			08.91	04.96 - ABS/ + 5 türig ³⁾	24.0216-5001.1	480001		für 3-Loch-Felge/- Sensorring ⁴⁾	165/166 x 38,5 - Lager
	1.1	44		08.91	04.96 - ABS/ + 5 türig ³⁾	24.0216-5701.2	480212		für 3-Loch-Felge/- Sensorring ⁴⁾	165/166 x 38,5 + Lager
	1.0			08.91	04.96 + ABS	24.0218-0017.1	480060			180/181 x 40,5 - Lager
	1.1	44		08.91	04.96 + ABS					
	1.4	51		08.91	03.96	24.0218-0017.1	480060			180/181 x 40,5 - Lager
	1.4	55		08.91	04.96					
	1.4 D	37		08.92	04.96					
	1.6	65		06.94	04.96 - ABS					
1.6	76		06.93	04.96 - ABS						
	1.0			08.91	04.96 - ABS/ + 3 türig ¹⁾	03.0420-1619.3	681619		+ 4-Loch-Felge ²⁾	19,05/180x32 Kit
	1.1	44		08.91	04.96 - ABS/ + 3 türig ¹⁾	03.0520-1619.3	691619		+ 4-Loch-Felge ²⁾	BDX 19,05/180x32 TopKit
	1.0			08.91	04.96 - ABS/ + 5 türig ³⁾	03.0420-0519.3	680519		+ 3-Loch-Felge ⁵⁾	BDX 19,05/164x32 Kit
	1.1	44		08.91	04.96 - ABS/ + 5 türig ³⁾	03.0520-0519.3	690519		+ 3-Loch-Felge ⁵⁾	BDX 19,05/164x32 TopKit
	1.3 Rallye	72		10.93	04.96 - ABS	03.0420-1619.3	681619			19,05/180x32 Kit
	1.4	51		08.91	03.96 - ABS	03.0520-1619.3	691619			BDX 19,05/180x32 TopKit
	1.4	55		08.91	04.96 - ABS					
	1.4	69		08.91	04.96 - ABS					
	1.4	72		08.91	03.96 - ABS					
	1.4 D	37		08.92	04.96 - ABS					
1.5 D			06.94	04.96 - ABS						
1.6	65		06.93	04.96 - ABS						
1.6	76		01.94	04.96 - ABS						
	1.0		S 51224674	08.91		24.3727-0807.2	580807	2		L=1292
	1.1	44	S 51224674	08.91						
	1.3 Rallye	72	S 51224674	10.93						
	1.4	51	S 51224674	08.91						
	1.4	55	S 51224674	08.91						
	1.4	69	S 51224674	08.91						
	1.4	72	S 51224674	08.91						
	1.4 D	37	S 51224674	08.92						
	1.5 D		S 51224674	06.94						
	1.6	65	S 51224674	06.93						
1.6	76	S 51224674	01.94							
	1.0		S 51224675	04.96		24.3727-0816.2	580816	2		L=1442
	1.1	44	S 51224675	04.96						
	1.3 Rallye	72	S 51224675	04.96						
	1.4	51	S 51224675	03.96						
	1.4	55	S 51224675	04.96						
	1.4	69	S 51224675	04.96						
	1.4	72	S 51224675	03.96						
	1.4 D	37	S 51224675	04.96						
	1.5 D		S 51224675	04.96						
	1.6	65	S 51224675	04.96						
1.6	76	S 51224675	04.96							
	1.0			08.91	04.96 - Servolenkung ⁶⁾	24.3728-0812.2	590812			L=658
	1.1	44		08.91	04.96 - Servolenkung ⁶⁾					
	1.3 Rallye	72		10.93	04.96 - Servolenkung ⁶⁾					
	1.0			08.91	04.96 + Servolenkung ⁷⁾	24.3728-0814.2	590814			L=678
	1.1	44		08.91	04.96 + Servolenkung ⁷⁾					
	1.3 Rallye	72		10.93	04.96 + Servolenkung ⁷⁾					
	1.4	51		08.91	03.96 - Servolenkung ⁶⁾	24.3728-0819.2	590819			L=1276
	1.4	55		08.91	04.96 - Servolenkung ⁶⁾					
	1.4	69		08.91	04.96 - Servolenkung ⁶⁾					
	1.4	72		08.91	03.96 - Servolenkung ⁶⁾					
1.4 D	37		08.92	04.96 - Servolenkung ⁶⁾						
1.5 D			06.94	04.96 - Servolenkung ⁶⁾						
1.6	65		06.93	04.96 - Servolenkung/ - Klimaanlage ⁹⁾						
1.6	76		01.94	04.96 - Servolenkung/ - Klimaanlage ⁹⁾						
	1.0			10.93	04.96 + Servolenkung ⁷⁾	24.3728-0814.2	590814			L=678
	1.4	51		08.91	03.96 + Servolenkung ⁷⁾					
	1.4	55		08.91	04.96 + Servolenkung ⁷⁾					
	1.4	69		08.91	04.96 + Servolenkung ⁷⁾					
	1.4	72		08.91	03.96 + Servolenkung ⁷⁾					
	1.4 D	37		08.92	04.96 + Servolenkung ⁷⁾					
	1.6	65		06.93	04.96 + Servolenkung/ + Klimaanlage ⁹⁾					
	1.6	76		01.94	04.96 + Servolenkung/ + Klimaanlage ⁹⁾					

¹⁾ - ABS/ + 3 door / - ABS/ + 3 porte / - ABS/ + 3 portes / - ABS/ + 3 puertas

²⁾ + 4 bore wheel rim / + cerchione a 4 fori / + jante à 4 trous / + Llantas de 4 taladros

³⁾ - ABS/ + 5 door / - ABS/ + 5 porte / - ABS/ + 5 portes / - ABS/ + 5 puertas

⁴⁾ f.3 bore wheel rim/-sensorring / p.cerchione a 3 fori/- sensore / p.jant.à 3 trous/- secours ABS / Llant.3 tala./-anillo sens.ABS

⁵⁾ + 3 bore wheel rim / + cerchione a 3 fori / + jante à 3 trous / + Llantas de 3 taladros

⁶⁾ - power steering / - servosterzo / - direction assistée / - dirección asistida

⁷⁾ + power steering / + servosterzo / + direction assistée / + dirección asistida

⁸⁾ - power steering/-air condition / - servosterzo/ + aria condizionata / - direc.assis./ - air conditionné / - direc.asist./ - aire acondic.

⁹⁾ + power steering/+air condition. / + servosterzo/ + aria condizionata / + direc.assis./ + air conditionné / + direc. asist./ + aire acondic.





PEUGEOT 106 (91-96)										
	1.5 D			06.94	04.96	+ Servolenkung 1)	24.3728-0315.2	590315		L=673
PEUGEOT 204 (65-77)										
	1.1 Cabrio			10.67	03.70		24.3219-1114.3	020323		Rz 19,05 BDX
	1.1 Coupe			10.67	03.70					
	1.1 GL	9.254.614		10.65		+ A				
	1.1 GL			10.65	09.72	+ N S				
	1.1 Kombi	7.677.725		09.75		- N S				
	1.2 D	7.987.370		10.67		- N S				
	1.2 D			10.67	09.72	+ N S				
	1.3 D		8.341.273	10.74		- N S				
	1.1 GL	9.254.615		06.77			24.3223-1105.3	020292		Rz 23,81 BDX
	1.1 Kombi	7.677.726		06.77						
	1.2 D	7.987.371		06.77						
	1.3 D	8.341.274		06.77						
	1.1 GL			07.75	06.77		03.0137-0139.2	650139		229 x 42 BDX
	1.1 Kombi			07.75	06.77		03.0137-0124.2	650124		229 x 42 HEB AUT BDX
	1.2 D			07.75	06.77		03.0137-0271.2	650271		229 x 42 HEB TRW
	1.3 D			07.75	06.77		03.0137-9020.2	669020		Bremsbacken-Zubehör BDX
							03.0137-9027.2	669027		Bremsbacken-Zubehör TRW
PEUGEOT 205 (83-90)										
	1.0	33		01.83	08.85	- Bremsgerät 2)	03.2119-1281.3	010054		THz 19,05 ATE
	1.1			01.83	08.85	- Bremsgerät 2)				
	1.0	33		01.83	08.90	+ Bremsgerät 3)	03.2119-3389.3	010057	+ 4 Anschlüsse 4)	THz 19,05 ATE
	1.1			01.83	08.90	+ Bremsgerät 3)	03.2120-2031.3	010106	+ 4 Anschlüsse 4)	THz 20,64 ATE
	1.1 i			07.89	08.90		03.3517-5100.1	390326		Verschlußschraube ATE
	1.3 Rallye			09.87	08.90					
	1.4			01.83	08.90					
	1.4 i			07.88	08.90					
	1.5			02.84	10.87					
	1.6			01.83	08.90					
	1.6	58		10.87	08.90	+ Automatikgetriebe 5)				
	1.6	65		05.90	08.90	+ Automatikgetriebe 5)				
	1.9 GTI	88		09.88	08.90	- ABS				
	1.9 GTI	94		10.86	08.88	- ABS				
	1.9 GTI/CTI	75		04.89	08.90					
	1.7 D	44		07.83	08.90		03.2119-3389.3	010057		THz 19,05 ATE
	1.9 D			09.88	08.90					
	1.0	33		01.83	08.90		24.3481-1609.7	220197	<input type="checkbox"/>	D=48, + Halter TRW
	1.1			01.83	08.89		24.3481-1610.7	220198	<input type="checkbox"/>	D=48, + Halter TRW
	1.4			01.83	08.90					
	1.6			01.83	02.87					
	1.7 D	44		07.83	08.90					
	1.9 D			09.88	08.90					
	1.1 i			07.89	08.90		24.3481-1609.7	220197	<input type="checkbox"/>	D=48, + Halter TRW
	1.4 i			07.88	08.90		24.3481-1610.7	220198	<input type="checkbox"/>	D=48, + Halter TRW
	1.6			03.87	08.90					
	1.6	58		10.87	08.90	+ Automatikgetriebe 5)				
	1.6	65		05.90	08.90	+ Automatikgetriebe 5)				
	1.6 GTI/CTI			01.84	08.90					
	1.9 GTI/CTI	75		04.89	08.90					
	1.9 GTI	88		09.88	08.90		24.3481-1615.5	240031	<input type="checkbox"/>	D=48, - Halter TRW
	1.9 GTI	94		10.86	08.88		24.3481-1616.5	240032	<input type="checkbox"/>	D=48, - Halter TRW
							24.0101-4806.2	260052		Bremsattel-Zubehör TRW
	1.0	33		01.83	08.90		13.0460-3911.2	603911		20905 18,0 +/WK BDX
	1.1			01.83	08.90		13.0460-2956.2	602956		20989 17,7 +/WK TRW
	1.4			01.83	08.90		13.0460-0060.2	610060		Belagsatz-Zubehör TRW
	1.6			08.86	08.90		13.0460-0402.2	610402		Belagsatz-Zubehör BDX
	1.6	58		10.87	08.90	+ Automatikgetriebe 5)				
	1.6	65		05.90	08.90	+ Automatikgetriebe 5)				
	1.6 GTI/CTI			01.84	08.90					
	1.7 D	44		07.83	08.90					
	1.9 D			09.88	08.90					
	1.1 i			09.89	08.90		13.0460-3911.2	603911		20905 18,0 +/WK BDX
	1.3 Rallye			09.87	08.90		13.0460-2956.2	602956		20989 17,7 +/WK TRW
	1.4 i			09.88	08.90		13.0460-0060.2	610060		Belagsatz-Zubehör TRW
	1.9 GTI/CTI	75		04.89	08.90		13.0460-0404.2	610404		Belagsatz-Zubehör BDX
	1.9 GTI	88		09.88	08.90		13.0460-2955.2	602955		20772 18,0 +/WK/S TRW
	1.9 GTI	94		10.86	08.88					
	1.0	33		01.83	08.90		24.0110-0187.1	410187		247 10,0 9,0 +S +B
	1.1			01.83	08.90					
	1.1 i			07.89	08.90					
	1.4			01.83	08.90					
	1.4 i			07.88	08.90					
	1.6			08.86	02.87					
	1.7 D	44		07.83	08.90					
	1.9 D			09.88	08.90					
	1.3 Rallye			09.87	08.90		24.0120-0131.1	420131		247 20,4 18,5 V
	1.6			03.87	08.90					
	1.6	58		10.87	08.90	+ Automatikgetriebe 5)				
	1.6	65		05.90	08.90	+ Automatikgetriebe 5)				
	1.6 GTI/CTI			01.84	08.90					
	1.9 GTI/CTI	75		04.89	08.90					















1) + power steering / + servosterzo / + direction assistée / + dirección asistida

2) - booster unit / - servofreno / - servo-frein / - servofreno

3) + booster unit / + servofreno / + servo-frein / + servofreno

4) + 4 connections / + 4 attacchi / + 4 raccords / + 4 conexiones

5) + autom.transmission / + scatola cambio automatico / + transmission automatique / + cambio automático

















PEUGEOT 205 (83-90)											
	1.9 GTI 1.9 GTI	88 94		09.88 10.86	08.90 08.88	24.0120-0132.1 24.0320-0132.1	420132 520132		247 20,4 18,5 V +S +B 247 20,4 18,5 V +S +B PD		
	1.0 1.1 1.1 i 1.4 1.4 i 1.5 1.6 1.6 1.6 1.9 GTI 1.9 GTI 1.9 GTI/CTI	33 58 65 88 94 75		01.83 01.83 07.89 01.83 07.88 02.84 08.86 10.87 05.90 09.88 10.86 04.89	08.90 08.90 08.90 08.90 08.90 10.87 08.90 08.90 08.90 + Automatikgetriebe 2) 08.90 + Automatikgetriebe 2) 08.90 08.88 08.90	24.5112-0325.3 24.5112-0405.3	330415 330428	2 2	Länge beachten 1) Länge beachten 1)	L=355 L=405	
	1.3 Rallye 1.7 D 1.9 D	44		09.87 07.83 09.88	08.90 08.90 08.90	24.5112-0325.3 24.5112-0405.3	330415 330428	2 2	Länge beachten 1) Länge beachten 1)	L=355 L=405	
	1.6 1.6 GTI 1.9 GTI 1.9 GTI	85 74 88 94		09.87 02.83 09.88 10.86	08.90 10.87 08.90 08.88	13.0460-3954.2 13.0460-0435.2	603954 610435		20973 11,0 + Belagsatz-Zubehör	BDX BDX	
	1.6 1.6 GTI 1.9 GTI 1.9 GTI	85 74 88 94		09.87 02.83 09.88 10.86	08.90 10.87 08.90 08.88	24.0108-0105.1	408105			248 8,0 6,5	
	1.0 1.1 1.1 i 1.4 1.4 i 1.5 1.6 1.6 1.6 1.9 GTI 1.9 GTI 1.9 GTI/CTI	33 58 65 44		01.83 01.83 07.89 01.83 07.88 02.84 08.86 10.87 05.90 07.83 09.88	08.90 08.90 08.90 08.90 08.90 10.87 08.90 08.90 + Automatikgetriebe 2) 08.90 + Automatikgetriebe 2) 08.90 08.90	24.5228-0255.3	330409	2		L=255	
	1.6 1.9 GTI 1.9 GTI 1.9 GTI/CTI	85 88 94 75		09.87 09.88 10.86 04.89	08.90 08.90 08.88 08.90	24.5228-0255.3 24.5112-0155.3	330409 330507	2 2	Länge beachten 1) Länge beachten 1)	L=255 L=155	
	1.0 1.1	33		01.83 01.83	08.90 08.89	24.3220-1609.3 24.3220-1610.3	020236 020237	<input type="checkbox"/> <input type="checkbox"/>		RzR 20,64 RzR 20,64	BDX BDX
	1.0 1.1 1.4 1.4 Kasten 1.6 1.7 D 1.9 D	33 44 44		01.83 01.83 01.83 02.83 08.86 07.83 09.88	08.90 08.89 08.90 07.87 02.87 08.90 08.90	24.3219-1605.3 24.3219-1606.3 24.3219-1601.3 24.3219-1602.3	020202 020203 020198 020199	<input type="checkbox"/> <input type="checkbox"/> <input type="checkbox"/> <input type="checkbox"/>		RzR 19,05 RzR 19,05 RzR 19,05 RzR 19,05	BDX BDX TRW TRW
	1.1 i 1.3 Rallye 1.4 i 1.4 Kasten 1.6 1.6 1.6 1.6 GTI 1.9 GTI/CTI	44 44 58 65 74 75		07.89 09.87 07.89 02.83 03.87 10.87 05.90 01.84 04.89	08.90 08.90 08.90 07.87 08.90 08.90 + Automatikgetriebe 2) 08.90 + Automatikgetriebe 2) 08.90 08.90	24.3219-1118.3	020332			Rz 19,05	TRW
	1.0 1.1 1.4 1.6 1.7 D 1.9 D	33 44		01.83 01.83 01.83 08.86 07.83 09.88	08.90 08.89 08.90 02.87 08.90 08.90	03.0137-0196.2 03.0137-0197.2 03.0137-9055.2 03.0137-9175.2	650196 650197 669055 669175			180 x 32 AUT 180 x 32 HEB Bremsbacken-Zubehör Bremsbacken-Zubehör	BDX TRW BDX TRW
	1.1 i 1.3 Rallye 1.4 i 1.6 1.6 1.6 1.6 GTI 1.9 GTI/CTI	58 65 74 75		07.89 09.87 07.88 03.87 10.87 05.90 01.84 04.89	08.90 08.90 08.90 08.90 08.90 + Automatikgetriebe 2) 08.90 + Automatikgetriebe 2) 08.90 08.90	03.0137-0201.2 03.0137-9056.2	650201 669056			180 x 41 HEB Bremsbacken-Zubehör	TRW TRW
	1.0 1.1 1.4 1.6 1.7 D 1.9 D	33 44		01.83 01.83 01.83 08.86 07.83 09.88	08.90 08.89 08.90 02.87 08.90 08.90	24.0218-0014.1	480009			180/181 x 43 - Lager	
	1.1 i 1.3 Rallye 1.4 i 1.6			07.89 09.87 07.88 03.87	08.90 08.90 08.90 08.90	24.0218-0015.1	480010			180/181 x 53,5 - Lager	

1) notice length / attenzione lunghezza / faire attention longueur / atención largo

2) + autom.transmission / + scatola cambio automatico / + transmission automatique / + cambio automático

3) - booster unit / - servofreno / - servo-frein / - servofreno

4) + booster unit / + servofreno / + servo-frein / + servofreno

									
PEUGEOT 205 (83-90)									
	1.6 1.6 1.6 GTI 1.9 GTI/CTI	58 65 74 75		10.87 08.90 05.90 01.84 04.89 08.90	+ Automatikgetriebe ¹⁾ + Automatikgetriebe ¹⁾	24.0218-0015.1	480010		180/181 x 53,5 - Lager
	1.0 1.1	33		01.83 01.83	08.90 - Bremsgerät ²⁾ 08.89 - Bremsgerät ²⁾	03.0520-2420.3	692420		20,64/180x32 TopKit BDX
	1.0 1.1 1.4 1.6 1.7 D 1.9 D	33		01.83 01.83 01.83 08.86 07.83 09.88	+ Bremsgerät ³⁾ + Bremsgerät ³⁾	03.0520-0619.3 03.0520-0419.3	690619 690419		19,05/180x32 TopKit BDX 19,05/180x32 TopKit TRW
	1.1 i 1.3 Rallye 1.4 i 1.6 1.6 1.6 1.6 GTI 1.9 GTI/CTI	58 65 74 75		10.87 05.90 01.84 04.89 08.90	+ Automatikgetriebe ¹⁾ + Automatikgetriebe ¹⁾				
	1.1 i 1.3 Rallye 1.4 i 1.6 1.6 1.6 1.6 GTI 1.9 GTI/CTI	58 65 74 75		07.89 09.87 07.88 03.87 10.87 05.90 01.84 04.89 08.90		03.0520-0919.3	690919		19,05/180x41 TopKit TRW
	1.0 1.1 1.1 i 1.3 Rallye 1.4 1.4 i 1.5 1.6 1.6 1.6 1.7 D 1.9 D 1.9 GTI/CTI	33 58 65 44 75		01.83 01.83 07.89 09.87 01.83 07.88 02.84 08.86 10.87 05.90 07.83 09.88 04.89 08.90		24.3727-0802.2 24.3727-0801.2	580802 580801	<input type="checkbox"/> <input type="checkbox"/>	L=1372 L=1386
	1.9 GTI 1.9 GTI	88 94		09.88 10.86		24.3727-0810.2 24.3727-0811.2	580810 580811	<input type="checkbox"/> <input type="checkbox"/>	L=1417 L=1432
	1.9 GTI 1.9 GTI	94 94	S 1831920 S 1811241	10.86 10.86	- ABS/ + E - ABS/ - E	24.6043-1701.3	320150		BRE 3/15
	1.9 GTI 1.9 GTI	88 S 1811242 88 S 1831921		08.90 08.90	- ABS/ - E - ABS/ + E	24.6042-1701.3	320149		BRE 2/20
	1.3 Rallye 1.4	◀ ◀		08.88 08.88	+ MA-Getriebe ⁴⁾ + MA-Getriebe ⁴⁾	24.3728-0807.2	590807		L=1262
	1.0 1.1 1.1 i 1.3 Rallye 1.4 1.6 1.7 D 1.9 GTI/CTI	◀ 33 ◀ ◀ ◀ ◀ ◀ ◀ 44 ◀		08.89 08.89 07.89 08.89 08.89 01.84 07.83 10.86	+ MA-Getriebe ⁴⁾ + MA-Getriebe ⁴⁾ + MA-Getriebe ⁴⁾ + MA-Getriebe ⁴⁾ + MA-Getriebe ⁴⁾ + BE1-Getriebe ⁵⁾ + BE1-Getriebe ⁵⁾	24.3728-0810.2 24.3728-0811.2 24.3728-0803.2	590810 590811 590803		L=625 L=1271 L=705
	1.6 1.7 D 1.9 GTI/CTI	◀ ◀ 44 ◀		08.88 08.88 08.88	+ BE1-Getriebe ⁵⁾ + BE1-Getriebe ⁵⁾ + BE1-Getriebe ⁵⁾	24.3728-0806.2	590806		L=710
	1.6 GTI/CTI 1.7 D 1.9 GTI/CTI	◀ ◀ 44 ◀		08.88 08.88 08.88	+ BE1-Getriebe ⁵⁾ + BE1-Getriebe ⁵⁾ + BE1-Getriebe ⁵⁾				
	1.6 GTI/CTI 1.7 D 1.9 GTI/CTI	◀ ◀ 44 ◀		09.89 09.89 09.89	+ BE3-Getriebe ⁶⁾ + BE3-Getriebe ⁶⁾ + BE3-Getriebe ⁶⁾	24.3728-0813.2	590813		L=660
PEUGEOT 304 (69-80)									
	1.3 Cabrio 1.3 Cabrio 1.3 Coupe 1.3 Coupe 1.3 Kombi 1.3 Kombi 1.3 Lim. 1.3 Lim.	48 48 48 48	3.298.000 3.298.000	03.70 03.70 03.70 09.72 09.70 09.70 09.69 09.69	- (N) (S) + (N) (S) - (N) (S) + (N) (S) - (N) (S) + (N) (S) - (N) (S) + (N) (S)	24.3219-1114.3	020323		Rz 19,05 BDX
	1.1 1.3 Kombi 1.4 D Lim.	43 33	3.733.770 3.733.770 3.733.770	10.80 10.80 10.79		24.3223-1105.3	020292		Rz 23,81 BDX
	1.1 1.3 Cabrio 1.3 Kombi 1.3 Lim. 1.4 D Lim.	43 55		10.76 07.75 07.75 07.75 10.76	10.80 07.76 10.80 09.75 10.80	03.0137-0139.2 03.0137-0124.2 03.0137-0271.2 03.0137-9020.2 03.0137-9027.2	650139 650124 650271 669020 669027		229 x 42 BDX 229 x 42 HEB AUT BDX 229 x 42 HEB TRW Bremsbacken-Zubehör BDX Bremsbacken-Zubehör TRW
PEUGEOT 305 (77-90)									
	1.3 Kombi 1.3 Lim. 1.5 D Kombi 1.5 D Lim. 1.5 Kombi 1.5 Lim.	8.619.360 8.622.710 8.619.360 8.622.710 8.619.360 8.622.710		08.86 08.85 09.82 09.82 10.86 07.90		24.2119-1704.3	010339		Thz 19,05
	1.3 1.5 1.6 1.8			10.82 10.82 10.82 11.82	08.86 08.86 12.88 12.88	03.2119-3389.3 03.3517-5100.1	010057 390326		Thz 19,05 ATE Verschlussschraube ATE

¹⁾ + autom.transmission / + scatola cambio automatico / + transmission automatique / + cambio automático

















²⁾ - booster unit / - servofreno / - servo-frein / - servofreno

³⁾ + booster unit / + servofreno / + servo-frein / + servofreno

⁴⁾ + MA transmission / + scatola cambio MA / + boîte de vitesse MA / + cambio MA

⁵⁾ + BE1 transmission / + scatola cambio BE1 / + boîte de vitesse BE1 / + cambio BE1

⁶⁾ + BE3 transmission / + scatola cambio BE3 / + boîte de vitesse BE3 / + cambio BE3







									
PEUGEOT 305 (77-90)									
	1.8 D 1.9 1.9 D 1.9 i	44 75 72		11.82 12.88 10.82 10.87 10.82 12.88 10.86 12.88	03.2119-3389.3 03.3517-5100.1	010057 390326		THz 19,05 Verschlusschraube ATE ATE	
	1.3 1.5 1.6 1.6 GT 1.8 1.8 D 1.9 1.9 D 1.9 i	59 44 75 72		10.82 08.86 10.82 07.90 10.82 12.88 07.84 08.87 11.82 12.88 11.82 12.88 10.82 10.87 10.82 12.88 10.86 12.88	13.0460-3911.2 13.0460-0402.2	603911 610402		20905 18,0 +/WK Belagsatz-Zubehör BDX BDX	
	1.3 1.5 1.6 1.8 1.8 D 1.9 D 1.6 GT 1.9 1.9 i	59 44 72		10.82 08.86 10.82 07.90 10.82 12.88 11.82 12.88 11.82 12.88 10.82 12.88 07.84 08.87 10.82 10.87 10.86 12.88	24.0110-0183.1 24.0120-0133.1 24.0320-0133.1	410183 420133 520133		266 10,0 8,0 266 20,5 18,5 V +S +B 266 20,5 18,5 V +S +B PD	
	1.3 Kombi 1.5 D Kombi 1.5 Kombi 1.6 Kombi 1.8 1.8 D 1.9 D Kombi 1.9 i Kombi 1.9 Kombi	59 44 72 75		08.80 08.86 08.80 09.82 08.80 10.86 10.82 12.88 11.82 12.88 11.82 12.88 10.82 12.88 11.86 12.88 10.82 10.87	24.5228-0185.3	330107 2		L=185	
	1.3 Lim. 1.5 D Lim. 1.5 Lim. 1.3 Lim. 1.5 D Lim. 1.5 Lim. 1.3 Lim. 1.5 Lim. 1.6 GT 1.6 Lim. 1.8 1.8 D 1.9 D Lim. 1.9 i Lim. 1.9 Lim. 1.3 Kombi 1.5 Kombi 1.6 Kombi 1.8 1.8 D 1.9 D Kombi 1.9 i Kombi 1.9 Kombi	8.209.617 8.209.617 8.209.617 59 44 72 75 59 44 72 75		09.82 09.82 09.82 11.77 09.82 11.77 09.82 11.79 09.82 10.82 08.85 10.82 08.86 10.82 10.86 10.82 12.88 11.82 12.88 11.82 12.88 10.82 12.88 10.82 07.88 11.86 12.88 10.82 08.85 10.82 08.86 10.82 10.86 10.82 12.88 11.82 12.88 11.82 12.88 10.82 12.88 10.82 07.88 11.82 12.88 10.82 12.88 10.82 12.88 11.86 12.88	24.3222-1708.3 24.3223-1105.3 24.3220-0905.3 24.3220-0905.3	020407 020292 020207 020207		Rz 22,20 Rz 23,81 Rz 20,64 Rz 20,64	ATE BDX TRW TRW
	1.3 1.5 1.5 D 1.3 1.5 1.5 D 1.3 1.5 1.5 D 1.6 1.6 GT 1.8 1.8 D 1.9 1.9 D 1.9 i	47 44 57 75 88 94 96		11.77 09.82 11.79 09.82 11.77 09.82 11.77 09.82 11.79 09.82 11.77 09.82 10.82 08.86 10.82 08.86 10.82 12.88 07.84 08.87 11.82 12.88 11.82 12.88 10.82 12.88 10.82 10.87 10.82 12.88 11.86 12.88	03.0137-0124.2 03.0137-0139.2 03.0137-9020.2 03.0137-0271.2 03.0137-9027.2 03.0137-0285.2 03.0137-9188.2	650124 650139 669020 650271 669027 650285 669188		229 x 42 HEB AUT 229 x 42 Bremsbacken-Zubehör BDX BDX BDX 229 x 42 HEB Bremsbacken-Zubehör TRW TRW 229 x 42 AUT Bremsbacken-Zubehör BDX BDX	
PEUGEOT 309 (85-93)									
	1.1 1.3 1.4 1.5 1.6 1.8 D 1.8 TD 1.9 1.9 D 1.9 GTi 1.9 GTi 1.9 GTi 1.9 GTi 16V	47 44 57 75 88 94 96		09.85 12.93 09.85 07.89 03.89 12.93 06.87 12.89 09.85 12.93 07.89 12.93 07.89 12.93 10.85 07.89 06.86 12.93 09.88 12.93 10.86 07.89 10.86 12.93 08.89 12.93	03.2119-3389.3 03.3517-5100.1 03.2120-2031.3	010057 390326 010106		THz 19,05 Verschlusschraube ATE ATE THz 20,64 ATE	
↓	↓			- ABS/ + ⊕ - ABS/ + ⊕ - ABS/ - ⊖ - ABS					



PEUGEOT 309 (85-93)

	1.9 i 1.9 i	72 80		03.86 07.88	12.93 12.93		03.2120-2031.3	010106			Thz 20,64	ATE
	1.1 1.3 1.4 1.5 1.6 1.6 1.8 D 1.8 TD 1.9 1.9 D 1.9 i 1.9 i	47		09.85 09.85 03.89 06.87 09.85 09.88 07.89 07.89 10.85 06.86 03.86 07.88	12.93 12.93 12.93 12.89 12.93 12.93 12.93 12.93 07.89 12.92 09.88 12.93	+ Schaltgetriebe ¹⁾ + Automatikgetriebe ²⁾	24.3481-1609.7 24.3481-1610.7	220197 220198			D=48, + Halter D=48, + Halter	TRW TRW
	1.6 GTi	76		11.85	09.88		24.3481-1615.5 24.3481-1616.5 24.0101-4806.2	240031 240032 260052			D=48, - Halter D=48, - Halter Bremsattel-Zubehör	TRW TRW TRW
	1.9 GTi 1.9 GTi 1.9 GTi 1.9 GTi 16V	88 94 96		09.88 10.86 10.86 08.89	12.93 + ⊕ 07.89 + ⊕ 12.93 - ⊕ 12.93		24.3481-1615.5 24.3481-1616.5 24.0101-4806.2	240031 240032 260052			D=48, - Halter D=48, - Halter Bremsattel-Zubehör	TRW TRW TRW
	1.1 1.3 1.4 1.5 1.6 1.8 D 1.8 TD 1.9 1.9 1.9 1.9 D	47		09.85 09.85 03.89 06.87 09.85 07.89 07.89 03.86 10.85 07.88 06.86	12.93 12.89 12.93 12.89 12.93 12.93 12.93 12.93 07.89 12.93 12.93		13.0460-3911.2 13.0460-2956.2 13.0460-0060.2 13.0460-0402.2	603911 602956 610060 610402			20905 18,0 +/WK 20989 17,7 +/WK Belagsatz-Zubehör Belagsatz-Zubehör	BDX TRW TRW BDX
	1.6 GTi 1.9 GTi 1.9 GTi 1.9 GTi 1.9 GTi 16V	76 88 94 96		11.85 09.88 10.86 10.86 08.89	09.88 12.93 + ⊕ 07.89 + ⊕ 12.93 - ⊕ 12.93		13.0460-3911.2 13.0460-2955.2 13.0460-0404.2	603911 602955 610404			20905 18,0 +/WK 20772 18,0 +/WK/S Belagsatz-Zubehör	BDX TRW BDX
	1.1 1.3 1.4 1.5 1.6 1.8 D 1.8 TD 1.9 1.9 1.9 1.9 D	47		09.85 09.85 03.89 06.87 09.85 07.89 07.89 03.86 10.85 07.88 06.86	12.93 07.89 12.93 12.89 12.93 12.93 12.93 12.93 07.89 12.93 12.93		24.0110-0187.1	410187			247 10,0 9,0 +S +B	TRW
	1.6 GTi 1.9 GTi 1.9 GTi 1.9 GTi 1.9 GTi 16V	76 88 94 96		11.85 09.88 10.86 10.86 08.89	09.88 12.93 + ⊕ 07.89 + ⊕ 12.93 - ⊕ 12.93		24.0120-0132.1 24.0320-0132.1	420132 520132			247 20,4 18,5 V +S +B 247 20,4 18,5 V +S +B PD	TRW TRW
	1.1 1.3 1.4 1.5 1.6 1.8 D 1.8 TD 1.9 1.9 D 1.9 i 1.9 i	47		09.85 09.85 03.89 06.87 09.85 07.89 07.89 10.85 06.86 03.86 07.88	08.89 07.89 08.89 08.89 08.89 08.89 08.89 07.89 08.89 08.89 08.89		24.5112-0327.3	330417	2		L=325	
	1.1 1.4 1.5 1.6 1.8 D 1.8 TD 1.9 D 1.9 i 1.9 i			09.89 09.89 09.89 09.89 09.89 09.89 09.89 09.89 09.89	12.93 12.93 12.89 12.93 12.93 12.93 12.93 12.93 12.93		24.5112-0327.3 24.5112-0405.3	330417 330428	2	Länge beachten ³⁾ Länge beachten ³⁾	L=325 L=405	
	1.9 GTi 1.9 GTi 1.9 GTi 1.9 GTi 16V 1.9 i	88 94 96		09.88 10.86 10.86 08.89 07.88	12.93 + ⊕ 07.89 + ⊕ 12.93 - ⊕ 12.93 12.93		24.5112-0405.3	330428	2		L=405	
	1.6 GTi 1.9 GTi 1.9 GTi 1.9 GTi 1.9 GTi 16V	76 88 94 96		03.86 09.88 10.86 10.86 08.89	12.93 12.93 + ⊕ 07.89 + ⊕ 12.93 - ⊕ 12.93		13.0460-3954.2 13.0460-0435.2	603954 610435			20973 11,0 + Belagsatz-Zubehör	BDX BDX

¹⁾ + manual transmission / + scatola cambio velocità / + transmission mécanique / + cambio de velocidad
²⁾ + autom.transmission / + scatola cambio automatico / + transmission automatique / + cambio automático
³⁾ notice length / attenzione lunghezza / faire attention longueur / atención largo

PEUGEOT 309 (85-93)											
	1.6 GTi 1.9 GTi 1.9 GTi 1.9 GTi 1.9 GTi 16V	76 88 94 96		03.86 09.88 10.86 10.86 08.89	12.93 12.93 + ⊕ 07.89 + ⊕ 12.93 - ⊕ 12.93		24.0108-0105.1	408105		248 8,0 6,5	
	1.1 1.3 1.4 1.5 1.6 1.8 D 1.8 TD 1.9 1.9 D 1.9 i 1.9 i	47 44 57 75 72 80		09.85 09.85 03.89 06.87 09.85 07.89 07.89 09.85 06.86 03.86 07.88	08.89 07.89 08.89 08.89 08.89 08.89 08.89 07.89 08.89 08.89 08.89		24.5112-0230.3 24.5228-0255.3	330508 330409	<input type="checkbox"/> <input type="checkbox"/>	L=230 L=255	
	1.1 1.4 1.5 1.6 1.8 D 1.8 TD 1.9 D 1.9 i 1.9 i	44 57 72 80		09.89 09.89 09.89 09.89 09.89 09.89 09.89 09.89 09.89	12.93 12.93 12.89 12.93 12.93 12.93 12.93 12.93 12.93		24.5228-0255.3	330409	2	L=255	
	1.6 GTi 1.9 GTi 1.9 GTi 1.9 GTi 1.9 GTi 16V	76 88 94 96		03.86 09.88 10.86 10.86 08.89	12.93 12.93 + ⊕ 07.89 + ⊕ 12.93 - ⊕ 12.93		24.5228-0255.3 24.5112-0155.3	330409 330507	<input type="checkbox"/> <input type="checkbox"/>	L=255 L=155	
	1.1 1.4 1.5 1.6 1.9 1.9 1.9 D 1.9 i 1.6 1.9 1.9 D 1.9 i 1.8 D 1.8 TD 1.8 D 1.8 TD	72 75 80 72 75 80 44 57 44 57 44 57		09.89 03.89 09.89 09.85 03.87 10.85 06.86 07.88 09.89 09.89 09.89 09.89 07.89 07.89 09.89 09.89	12.93 12.93 12.89 08.89 08.89 08.89 08.89 08.89 12.93 12.93 12.93 12.93 08.89 08.89 08.89 08.89		24.3220-1609.3 24.3220-1610.3 24.3220-1607.3 24.3220-1608.3 24.3222-1709.3 24.3222-1710.3 24.3222-1107.3 24.3220-1607.3 24.3220-1608.3 24.3222-1709.3 24.3222-1710.3 24.3220-1619.3	020236 020237 020234 020235 020111 020112 020262 020234 020235 020111 020112 020246	<input type="checkbox"/> <input type="checkbox"/> <input type="checkbox"/> <input type="checkbox"/> <input type="checkbox"/> <input type="checkbox"/> <input type="checkbox"/> <input type="checkbox"/> <input type="checkbox"/> <input type="checkbox"/> <input type="checkbox"/> <input type="checkbox"/> <input type="checkbox"/> <input type="checkbox"/> <input type="checkbox"/> <input type="checkbox"/>	RzR 20,64 RzR 20,64 RzR 20,64 RzR 20,64 Rz 22,20 Rz 22,20 Rz 22,20 RzR 20,64 RzR 20,64 Rz 22,20 Rz 22,20 Rz 22,20 RzR 20,64 RzR 20,64 Rz 20,64	BDX BDX TRW TRW BDX BDX TRW TRW TRW BDX BDX TRW
	1.1 1.3 1.5 1.1 1.4 1.5 1.6 1.8 D 1.8 TD 1.9 1.9 D 1.9 i 1.9 1.6 1.9 1.9 D 1.9 i 1.8 D 1.8 TD	47 44 57 75 80 72 75 80 44 57 44 57 72 75 80 44 57		09.85 09.85 06.87 09.89 03.89 09.89 09.85 07.89 07.89 09.85 06.86 07.88 03.86 09.85 09.85 06.86 07.88 09.89 09.89	08.89 07.89 08.89 12.93 12.93 12.89 08.89 08.89 08.89 07.89 08.89 08.89 12.93 12.93 12.93 08.89 08.89 12.93 12.93		03.0137-0203.2 03.0137-9055.2 03.0137-0196.2 03.0137-0197.2 03.0137-9055.2 03.0137-9175.2 03.0137-0203.2 03.0137-9055.2 03.0137-0201.2 03.0137-9056.2 03.0137-0201.2 03.0137-9056.2 03.0137-0201.2 03.0137-9056.2	650203 669055 650196 650197 669055 669175 650203 669055 650201 669056 650201 669056 650201 669056	<input type="checkbox"/> <input type="checkbox"/> <input type="checkbox"/> <input type="checkbox"/> <input type="checkbox"/> <input type="checkbox"/> <input type="checkbox"/> <input type="checkbox"/> <input type="checkbox"/> <input type="checkbox"/> <input type="checkbox"/> <input type="checkbox"/> <input type="checkbox"/> <input type="checkbox"/> <input type="checkbox"/> <input type="checkbox"/> <input type="checkbox"/> <input type="checkbox"/> <input type="checkbox"/>	180 x 42 AUT Bremsbacken-Zubehör 180 x 32 AUT 180 x 32 HEB Bremsbacken-Zubehör Bremsbacken-Zubehör 180 x 42 AUT Bremsbacken-Zubehör 180 x 41 HEB 180 x 41 HEB Bremsbacken-Zubehör 180 x 41 HEB Bremsbacken-Zubehör	BDX BDX BDX TRW BDX BDX BDX BDX TRW TRW TRW TRW TRW TRW
	1.1 1.3 1.4 1.5 1.6 1.8 D 1.8 TD 1.9 1.9 D 1.9 i 1.1 1.4 1.5 1.6	47 44 57 72 75 80 44 57 72 75 80 44 57		09.85 09.85 03.89 06.87 09.85 07.89 07.89 09.85 06.86 07.88 09.89 09.89 09.89 09.89	08.89 07.89 08.89 08.89 08.89 08.89 08.89 07.89 08.89 08.89 12.93 12.93 12.89 12.93		24.0218-0015.1 24.0218-0716.2	480010 480011 480203	<input type="checkbox"/> <input type="checkbox"/> <input type="checkbox"/> <input type="checkbox"/> <input type="checkbox"/> <input type="checkbox"/> <input type="checkbox"/> <input type="checkbox"/> <input type="checkbox"/> <input type="checkbox"/> <input type="checkbox"/> <input type="checkbox"/> <input type="checkbox"/> <input type="checkbox"/>	180/181 x 53,5 - Lager 180/181 x 44,5 - Lager 180/181 x 44,5 + Lager	TRW TRW TRW





PEUGEOT 309 (85-93)

	1.8 D 1.8 TD 1.9 1.9 D 1.9 i	44 57 72 80		09.89 09.89 09.89 09.89	12.93 12.93 12.93 12.93	24.0218-0016.1 24.0218-0716.2	480011 480203		180/181 x 44,5 - Lager 180/181 x 44,5 + Lager
	1.1 1.3 1.5	47		09.85 09.85 06.87	08.89 07.89 08.89	03.0520-1117.3	691117		17,46/180x42 TopKit BDX
	1.1 1.4 1.5			09.89 03.89 09.89	12.93 12.93 12.89	03.0520-2420.3 03.0520-1820.3	692420 691820		20,64/180x32 TopKit BDX 20,64/180x32 TopKit TRW
	1.6 1.9 1.9 1.9 D 1.9 i	72 75 80		09.85 03.86 09.85 06.86 07.88	08.89 08.89 07.89 08.89 08.89	03.0520-0922.3	690922		22,20/180x42 TopKit BDX
	1.6 1.9 1.9 D 1.9 i	72 80		09.89 09.89 09.89 09.89	12.93 12.93 12.93 12.93	03.0520-2720.3	692720		20,64/180x41 TopKit TRW
	1.8 D 1.8 TD	44 57		07.89 07.89	08.89 08.89	03.0520-0922.3	690922		22,20/180x42 TopKit BDX
	1.8 D 1.8 TD	44 57		09.89 09.89	12.93 12.93	03.0520-3120.3	693120		20,64/180x41 TopKit TRW
	1.1 1.3 1.4 1.5 1.6 1.8 D 1.8 TD 1.9 1.9 D 1.9 i 1.9 i	47		09.85 09.85 03.89 06.87 09.85 07.89 07.89 09.85 06.86 03.86 07.88	12.93 07.89 12.93 12.89 12.93 12.93 12.93 07.89 12.93 12.93 12.93	24.3727-0806.2 24.3727-0805.2	580806 580805	<input type="checkbox"/> + HA-Trommelbremse 1) <input type="checkbox"/> + HA-Trommelbremse 1)	L=1426 L=1445
	1.1 1.3 1.4 1.5 1.6 1.8 D 1.8 TD 1.9 1.9 1.9 D	S 2815520 47 S 2815520 S 2815520 S 2815520		08.90 07.89 03.89 12.89 08.90	08.90 08.90 08.90 08.90 08.90	24.6042-1701.3	320149		BRE 2/20
	1.9 GTi 1.9 GTi 1.9 GTi	88 94 96	S 2851976 S 2851976 S 2851976	09.88 10.86 10.86		24.6043-1701.3	320150		BRE 3/15
	1.1 1.4	◀		09.85 03.89	07.89 07.89	24.3728-0807.2	590807		L=1262
	1.1 1.4 1.4 i 1.6 1.8 D 1.8 TD 1.9	◀ ◀ 49 ◀ 55 ◀ ◀ 44 ◀ 57 ◀		08.89 08.89 08.89 08.89 08.89 08.89	12.93 12.93 12.93 12.93 12.93 12.93	24.3728-0810.2	590810		L=625
	1.4 i	◀ 62		03.89	12.93	24.3728-0811.2	590811		L=1271
	1.6 1.9	◀ ◀		09.85 09.85	07.88 07.88	24.3728-0803.2	590803		L=705
	1.6 1.9	◀ ◀		08.88 08.88	12.93 12.93	24.3728-0806.2	590806		L=710
	1.5 1.6 1.8 TD 1.9	◀ ◀ ◀ 57 ◀		06.87 09.85 07.89 09.85	12.89 12.93 12.93 12.93	24.3728-0813.2	590813		L=660

PEUGEOT 404 (62-75)

	1.6			07.66	09.68	24.3219-1114.3	020323		Rz 19,05 BDX
--	-----	--	--	-------	-------	----------------	--------	--	--------------

PEUGEOT 405 (87-92)

	1.6 1.9	70		09.87 09.87	08.92 08.92	24.2120-1701.3	010427		Thz 20,64
	1.8 TD 1.9 1.9 1.9 i 1.9 i 1.9 Mi 16 1.9 Mi 16	66 80 93 77 88 108 116		09.88 09.88 07.87 09.87 09.88 05.88 09.87	08.92 08.92 08.92 08.88 08.92 08.92 12.88	24.2122-1704.3	010423		Thz 22,20

1) + RA drum brake / + P freno a tamburo / + frein à tambour essieu AR / + ET-tambores de freno
 2) + MA transmission / + scatola cambio MA / + boîte de vitesse MA / + cambio MA
 3) + XU engine / + BE1 transmission / + motore XU / + scatola cambio BE1 / + motore XU / + boîte vitesse BE1 / + motor de XU / + cambio BE1
 4) + BE3 transmission / + scatola cambio BE3 / + boîte de vitesse BE3 / + cambio BE3



PEUGEOT 405 (87-92)

	1.8 TD	66		09.90	08.92	24.3481-1707.5	240073		D=48, - Halter	TRW	
	1.9	70	S 70536852		08.92	24.3481-1708.5	240074		D=48, - Halter	TRW	
	1.9 D		S 70536852		08.92	24.0101-3601.2	260044		Bremssattel-Zubehör	TRW	
	1.9	80			09.88	08.92	24.0101-3601.2		260044	Bremssattel-Zubehör	TRW
	1.9	93			07.87	08.92					
	1.9 i	77			09.87	08.88					
	1.9 i	88			09.88	08.92					
1.9 Mi 16	108			05.88	08.92						
1.9 Mi 16	116			09.87	12.88						
	1.4 i	47		01.87	08.92	13.0460-3911.2	603911		20905 18,0 +/WK	BDX	
	1.6			09.87	08.92	13.0460-0402.2	610402		Belagsatz-Zubehör	BDX	
	1.8 D Kombi			03.88	08.92 + Ⓢ						
	1.8 TD	66		09.88	08.90						
	1.9	70	S 70536851	09.87							
	1.9 D		S 70536851	05.88							
	1.6			09.87	08.92	13.0460-2971.2	602971			21209 18,5 +/WK/S	TRW
	1.8 TD	66		09.90	08.92						
	1.9	70	S 70536852		08.92						
	1.9	80		09.88	08.92						
1.9	93		07.87	08.92							
1.9 D		S 70536852		08.92							
1.9 i	77		09.87	08.88							
1.9 i	88		09.88	08.92							
1.9 Mi 16	108		05.88	08.92							
1.9 Mi 16	116		09.87	12.88							
	1.4 i	47		01.87	08.92	24.0110-0183.1	410183		266 10,0 8,0		
	1.6			09.87	08.92						
	1.8 D Kombi			03.88	08.92 + Ⓢ						
	1.8 TD	66		09.88	08.90						
	1.9	70	S 70536851	09.87							
	1.9 D		S 70536851	05.88							
	1.8 TD	66		09.90	08.92	24.0120-0133.1	420133		266 20,5 18,5 V +S +B		
	1.9	70	S 70536852		08.92	24.0320-0133.1	520133		266 20,5 18,5 V +S +B PD		
	1.9	80		09.88	08.92						
	1.9	93		07.87	08.92						
1.9 D		S 70536852		08.92							
1.9 i	77		09.87	08.88							
1.9 i	88		09.88	08.92							
1.9 Mi 16	108		05.88	08.92							
1.9 Mi 16	116		09.87	12.88							
	1.4 i	47		01.87	08.92	24.5118-0470.3	330462		L=470		
	1.6			09.87	08.92	24.5118-0420.3	330444		L=420		
	1.8 D Kombi			03.88	08.92 + Ⓢ						
	1.8 TD	66		09.88	08.92						
	1.9	70		09.87	08.92						
	1.9	80		09.88	08.92						
	1.9	93		07.87	08.92						
	1.9 D			05.88	08.92						
	1.9 i	77		09.87	08.88						
	1.9 i	88		09.88	08.92						
1.9 Mi 16	108		05.88	08.92							
1.9 Mi 16	116		09.87	12.88							
	1.9	80		09.88	08.92	24.3384-1605.5	240295		D=38, - Halter	TRW	
	1.9	93		07.87	08.92	24.3384-1606.5	240296		D=38, - Halter	TRW	
	1.9 i	77		09.87	08.88						
	1.9 i	88		09.88	08.92						
	1.9 Mi 16	108		05.88	08.92						
	1.9 Mi 16	116		09.87	12.88						
	1.9	80		09.88	08.92	13.0460-2842.2	602842		20961 15,2 /S	TRW	
	1.9	93		07.87	08.92	13.0460-0072.2	610072		Belagsatz-Zubehör	TRW	
	1.9 i	77		09.87	08.88						
	1.9 i	88		09.88	08.92						
	1.9 Mi 16	108		05.88	08.92						
	1.9 Mi 16	116		09.87	12.88						
	1.9 Mi 16 X4	108		05.88	08.92	13.0460-2937.2	602937		20961 15,2 /Zub/S	TRW	
	1.9 X4	80		09.88	08.92	13.0460-0419.2	610419		Belagsatz-Zubehör	TRW	
	1.9	80		09.88	08.92	24.0110-0199.1	410199		247 10,0 8,0		
	1.9	93		07.87	08.92						
1.9 i	77		09.87	08.88							
1.9 i	88		09.88	08.92							
1.9 Mi 16	108		05.88	08.92							
1.9 Mi 16	116		09.87	12.88							
	1.9 Mi 16 X4	108		05.88	08.92	24.0110-0187.1	410187		247 10,0 9,0 +S +B		
	1.9 X4	80		09.88	08.92						
	1.4 i	47		01.87	08.92	24.5111-0235.3	330477		L=234		
	1.6			09.87	08.92	24.5229-0181.3	330533		L=180		
	1.8 D Kombi			03.88	08.92 + Ⓢ						
	1.9	70		09.87	08.92						
	1.9	80		09.88	08.92						
	1.9	93		07.87	08.92						
	1.9 D			05.88	08.92						
	1.9 i	77		09.87	08.88						
	1.9 i	88		09.88	08.92						
	1.9 Mi 16	108		05.88	08.92						
1.9 Mi 16	116		09.87	12.88							

1) - brake pressure regulator / - correttore di frenata / - correcteur de freinage / - corrector de frenado
 2) + Ⓢ / - brake press.regulator / + Ⓢ / - correttore di frenata / + Ⓢ / - correcteur de freinage / + Ⓢ / - corrector de frenado
 3) - ABS/ - brake press.regulator / - ABS/ - correttore di frenata / - ABS/ - correcteur de freinage / - ABS/ - corrector de frenado







































PEUGEOT 405 (87-92)

	1.4 i	47		01.87	08.92 + Bremskraftregler ¹⁾	24.5229-0181.3	330533	2		L=180	
	1.6			09.87	08.92 + Bremskraftregler ¹⁾						
	1.8 D Kombi			03.88	08.92 + ⊕ / + Bremskraftregler ²⁾						
	1.9	70		09.87	08.92 + Bremskraftregler ¹⁾						
	1.9	80		09.88	08.92 - ABS/ + Bremskraftregler ³⁾						
	1.9	93		07.87	08.92 - ABS/ + Bremskraftregler ³⁾						
	1.9 D			05.88	08.92 + Bremskraftregler ¹⁾						
	1.9 i	77		09.87	08.88 - ABS/ + Bremskraftregler ³⁾						
	1.9 i	88		09.88	08.92 - ABS/ + Bremskraftregler ³⁾						
	1.9 Mi 16	108		05.88	08.92 - ABS/ + Bremskraftregler ³⁾						
1.9 Mi 16	116		09.87	12.88 - ABS/ + Bremskraftregler ³⁾							
	1.8 TD	66		09.88	08.92 + ABS	24.5229-0181.3	330533	2	Länge beachten ⁴⁾	L=180	
	1.9	80		09.88	08.92 + ABS	24.5111-0235.3	330477	2	Länge beachten ⁴⁾	L=234	
	1.9	93		07.87	08.92 + ABS						
	1.9 i	77		09.87	08.88 + ABS						
	1.9 i	88		09.88	08.92 + ABS						
	1.9 Mi 16	108		05.88	08.92 + ABS						
	1.9 Mi 16	116		09.87	12.88 + ABS						
		1.4 i	47		01.87	08.92 - ABS	24.3220-1611.3	020238	<input type="checkbox"/>		RzR 20,64
		1.6 Lim.			09.87	08.92 - ABS	24.3220-1612.3	020239	<input type="checkbox"/>		RzR 20,64
		1.8 TD Lim.	66		09.88	08.92 - ABS					
1.9 D Lim.				05.88	08.92 - ABS						
1.9 Lim.		70		09.87	08.92 - ABS						
1.4 i		47		01.87	08.92 + ABS	24.3220-0905.3	020207			Rz 20,64	
1.6 Kombi				10.88	08.92						
1.6 Lim.				09.87	08.92 + ABS						
1.8 D Kombi				10.88	08.92 + ⊕						
1.8 TD Kombi		66		10.88	08.92						
1.8 TD Lim.	66		09.88	08.92 + ABS							
1.9 D Kombi			10.88	08.92							
1.9 D Lim.			05.88	08.92 + ABS							
1.9 Kombi	70		10.88	08.92							
1.9 Lim.	70		09.87	08.92							
	1.4 i	47		01.87	08.92 - ABS	03.0137-0202.2	650202			229 x 42	
	1.6 Lim.			09.87	08.92 - ABS	03.0137-9089.2	669089			Bremsbacken-Zubehör	
	1.8 TD Lim.	66		09.88	08.92 - ABS						
	1.9 D Lim.			05.88	08.92 - ABS						
	1.9 Lim.	70		09.87	08.92 - ABS						
	1.4 i	47		01.87	08.92 + ABS	03.0137-0271.2	650271			229 x 42 HEB	
	1.6 Kombi			10.88	08.92	03.0137-9027.2	669027			Bremsbacken-Zubehör	
	1.6 Lim.			09.87	08.92 + ABS						
	1.8 D Kombi			10.88	08.92 + ⊕						
	1.8 TD Kombi	66		10.88	08.92						
1.8 TD Lim.	66		09.88	08.92 + ABS							
1.9 D Kombi			10.88	08.92							
1.9 D Lim.			05.88	08.92 + ABS							
1.9 Kombi	70		10.88	08.92							
1.9 Lim.	70		09.87	08.92 + ABS							
	1.4 i	47		01.87	08.92	24.0222-8017.1	480071			229/230 x 50,8	
	1.6			09.87	08.92						
	1.8 D Kombi			03.88	08.92 + ⊕						
	1.8 TD	66		09.88	08.92						
	1.9	70		09.88	08.92						
	1.9 D			05.88	08.92						
		1.4 i	47		01.87	08.92 - ABS	03.0520-1220.3	691220			20,64/229x42 TopKit
		1.6 Lim.			09.87	08.92 - ABS					
		1.8 TD Lim.	66		09.88	08.92 - ABS					
		1.9 D Lim.			05.88	08.92 - ABS					
1.9 Lim.		70		09.87	08.92 - ABS						
1.4 i		47		01.87	08.92 + ABS	03.0520-4120.3	694120			20,64/229x42 TopKit	
1.6 Kombi				10.88	08.92						
1.6 Lim.				09.87	08.92 + ABS						
1.8 D Kombi				10.88	08.92 + ⊕						
1.8 TD Kombi		66		10.88	08.92						
1.8 TD Lim.	66		09.88	08.92 + ABS							
1.9 D Kombi			10.88	08.92							
1.9 D Lim.			05.88	08.92 + ABS							
1.9 Kombi	70		10.88	08.92							
1.9 Lim.	70		09.87	08.92 + ABS							
	1.4 i	47		01.87	08.92	24.3727-0831.2	580831	1	<input type="checkbox"/>	L=1842	
	1.6			09.87	08.92	24.3727-0804.2	580804		<input type="checkbox"/>	L=855	
	1.8 D Kombi			03.88	08.92 + ⊕	24.3727-0803.2	580803		<input type="checkbox"/>	L=550	
	1.8 TD	66		09.88	08.92						
	1.9	70		09.87	08.92						
	1.9 D			05.88	08.92						
	1.9	80		09.88	08.92	24.3727-0831.2	580831	1	<input type="checkbox"/>	L=1842	
	1.9	93		07.87	08.92	24.3727-0809.2	580809		<input type="checkbox"/>	L=872	
	1.9 i	77		09.87	08.88	24.3727-0808.2	580808		<input type="checkbox"/>	L=558	
	1.9 i	88		09.88	08.92						
1.9 Mi 16	108		05.88	08.92							
1.9 Mi 16	116		09.87	12.88							
	1.4 i	47		01.87	08.92	03.6583-0037.3	320107			BRL 8/3 (4)	
	1.6			09.87	08.92						
	1.8 D Kombi			03.88	08.92 + ⊕						
	1.8 TD	66		09.88	08.92						
	1.9	70		09.87	08.92						

1) + brake pressure regulator / + correttore di frenata / + correcteur de freinage / + corrector de frenado
 2) + ⊕ / + brake press.regulator / + ⊕ / + correttore di frenata / + ⊕ / + correcteur de freinage / + ⊕ / + corrector de frenado
 3) - ABS/ + brake press.regulator / - ABS/ + correttore di frenata / - ABS/ + correcteur de freinage / - ABS/ + corrector de frenado
 4) notice length / attenzione lunghezza / faire attention longueur / atención largo

								
PEUGEOT 405 (87-92)								
	1.9	80		09.87	08.92	03.6583-0037.3	320107	BRL 8/3 (4) ATE
	1.9	93		07.87	08.92			
	1.9 D			05.88	08.92			
	1.9 i	77		09.87	08.92			
	1.9 i	88		09.88	08.92			
	1.9 Mi 16	108		05.88	08.92			
	1.9 Mi 16	116		09.87	12.88			
	1.6	◀		09.87	08.92 + BE3/5-Getriebe 1)	24.3728-0818.2	590818	L=1365
	1.8 TD	◀66		09.88	08.92 + BE3/5-Getriebe 1)			
	1.9	◀70		09.87	08.92 + BE3/5-Getriebe 1)			
	1.9	◀80		09.87	08.92 + BE3/5-Getriebe 1)			
	1.9	◀93		07.87	08.92 + BE3/5-Getriebe 1)			
	1.9 D	◀		05.88	08.92 + BE3/5-Getriebe 1)			
	1.9 i	◀77		09.87	08.92 + BE3/5-Getriebe 1)			
	1.9 i	◀88		09.88	08.92 + BE3/5-Getriebe 1)			
	1.9 Mi 16	◀108		05.88	08.92 + BE3/5-Getriebe 1)			
	1.9 Mi 16	◀116		09.87	12.88 + BE3/5-Getriebe 1)			
PEUGEOT 405 (93-95)								
	1.4 i	55		09.92	10.95 - ABS	24.2120-1701.3	010427	Thz 20,64
	1.6	65		09.92	10.95 - ABS			
	1.8 i			09.92	10.95 - ABS			
	1.4 i	55		09.92	10.95 + ABS	24.2122-1704.3	010423	Thz 22,20
	1.6	65		09.92	10.95 + ABS			
	1.8 i			09.92	10.95 + ABS			
	1.9	93		09.92	12.93 + ABS			
	1.9 D			09.92	10.95 + ABS			
	1.9 TD			09.92	10.95 + ABS			
	2.0 16V	144		09.92	10.95 + ABS			
	2.0 i	89		09.92	10.95 + ABS			
	1.8 i			09.92	10.95 - ABS	24.3481-1707.5	240073	D=48, - Halter TRW
	1.9 D			09.92	10.95 - ABS	24.3481-1708.5	240074	D=48, - Halter TRW
	1.9 TD			09.92	10.95 - ABS	24.0101-3601.2	260044	Bremssattel-Zubehör TRW
	1.8 i			09.92	10.95 + ABS	24.0101-3601.2	260044	Bremssattel-Zubehör TRW
	1.9	93		09.92	12.93			
	1.9 D			09.92	10.95 + ABS			
	1.9 TD			09.92	10.95 + ABS			
	2.0 16V	144		09.92	10.95			
	2.0 i	89		09.92	10.95			
	2.0 i X4	89		09.92	10.95			
	1.4 i	55		09.92	10.95	13.0460-3911.2	603911	20905 18,0 +/WK BDX
	1.6	65		09.92	10.95	13.0460-0403.2	610403	Belagsatz-Zubehör BDX
	1.6	65		09.92	10.95	13.0460-2971.2	602971	21209 18,5 +/WK/S TRW
	1.8 i			09.92	10.95			
	1.9	93		09.92	12.93			
	1.9 D			09.92	10.95			
	1.9 TD			09.92	10.95			
	2.0 16V	144		09.92	10.95			
	2.0 i	89		09.92	10.95			
	2.0 i X4	89		09.92	10.95			
	1.4 i	55		09.92	10.95	24.0110-0183.1	410183	266 10,0 8,0
	1.6	65		09.92	10.95			
	1.8 i			09.92	10.95	24.0120-0133.1	420133	266 20,5 18,5 V +S +B
	1.9	93		09.92	12.93	24.0320-0133.1	520133	266 20,5 18,5 V +S +B PD
	1.9 D			09.92	10.95			
	1.9 TD			09.92	10.95			
	2.0 16V	144		09.92	10.95			
	2.0 i	89		09.92	10.95			
	2.0 i X4	89		09.92	10.95			
	2.0 T16 X4	144		07.93	10.95	24.0122-0142.1	422142	283 22,0 20,0 V L +B
	1.4 i	55		09.92	10.95	24.5118-0420.3	330444	L=420
	1.6	65		09.92	10.95			
	1.8 i			09.92	10.95			
	1.9	93		09.92	12.93			
	1.9 D			09.92	10.95			
	1.9 TD			09.92	10.95			
	2.0 16V	144		09.92	10.95			
	2.0 i	89		09.92	10.95			
	1.9	93		09.92	12.93	24.3384-1605.5	240295	D=38, - Halter TRW
	1.9 TD			09.92	10.95 + ABS	24.3384-1606.5	240296	D=38, - Halter TRW
	2.0 16V	144		09.92	10.95			
	2.0 i	89		09.92	10.95			
	1.9	93		09.92	12.93	13.0460-2842.2	602842	20961 15,2 /S TRW
	1.9 TD			09.92	10.95 + ABS	13.0460-0072.2	610072	Belagsatz-Zubehör TRW
	2.0 16V	144		09.92	10.95			
	2.0 i	89		09.92	10.95			
	2.0 i X4	89		09.92	10.95	13.0460-2937.2	602937	20961 15,2 /Zub/S TRW
	2.0 T16 X4	144		07.93	10.95	13.0460-0419.2	610419	Belagsatz-Zubehör TRW
	1.9	93		09.92	12.93	24.0110-0199.1	410199	247 10,0 8,0
	1.9 TD			09.92	10.95 + ABS			
	2.0 16V	144		09.92	10.95			
	2.0 i	89		09.92	10.95			
	2.0 i X4	89		09.92	10.95	24.0110-0187.1	410187	247 10,0 9,0 +S +B
	2.0 T16 X4	144		07.93	10.95			

1) + BE3/5 transmission / + scatola cambio BE3/5 / + boîte de vitesse BE3/5 / + cambio BE3/5

									
PEUGEOT 405 (93-95)									
	1.4 i	55		09.92	10.95	24.5229-0181.3	330533	2	L=180
	1.6	65		09.92	10.95				
	1.8 i			09.92	10.95				
	1.9 D			09.92	10.95				
	1.9	93		09.92	12.93	24.5229-0181.3	330533	2	Länge beachten ¹⁾
	1.9 TD			09.92	10.95	24.5111-0235.3	330477	2	Länge beachten ¹⁾
	2.0 16V	144		09.92	10.95				L=234
	2.0 i	89		09.92	10.95				
	2.0 i X4			09.92	10.95	24.5111-0235.3	330477	2	L=234
	2.0 T16 X4	144		07.93	10.95				
	1.4 i Lim.	55		09.92	10.95	24.3220-1611.3	020238		RzR 20,64
	1.6 Lim.	65		09.92	10.95	24.3220-1612.3	020239		RzR 20,64
	1.8 i Lim.	74		09.92	10.95				BDX
	1.9 D Lim.			09.92	10.95				BDX
	1.4 i Kombi		S 71211989	09.92	10.95	24.3220-0905.3	020207		Rz 20,64
	1.4 i Kombi	55	S 71211989	09.92	10.95				TRW
	1.4 i Lim.	65	S 71211989	09.92	10.95				
	1.6 Kombi	65	S 71211989	09.92	10.95				
	1.6 Kombi	65	S 71211989	09.92	10.95				
	1.6 Lim.	65	S 71211989	09.92	10.95				
	1.8 i Kombi	74	S 71211989	09.92	10.95				
	1.8 i Kombi	74	S 71211989	09.92	10.95				
	1.8 i Lim.	74	S 71211989	09.92	10.95				
	1.9 D Kombi		S 71211989	09.92	10.95				
	1.9 D Kombi		S 71211989	09.92	10.95				
	1.9 D Lim.		S 71211989	09.92	10.95				
	1.4 i Kombi		S 71211989	09.92	10.95	24.3220-1715.3	020412		Rz 20,64
	1.4 i Kombi	65	S 71211989	09.92	10.95				TRW
	1.6 Kombi	65	S 71211989	09.92	10.95				
	1.6 Kombi	65	S 71211989	09.92	10.95				
	1.8 i Kombi	74	S 71211989	09.92	10.95				
1.8 i Kombi	74	S 71211989	09.92	10.95					
1.9 D Kombi		S 71211989	09.92	10.95					
1.9 D Kombi		S 71211989	09.92	10.95					
1.9 TD Kombi		S 71211989	09.92	10.95					
	1.4 i Lim.	55	S 71407666	09.92	10.95	03.0137-0202.2	650202		229 x 42
	1.6 Lim.	65	S 71407666	09.92	10.95	03.0137-9089.2	669089		Bremsbacken-Zubehör
	1.8 i Lim.	74	S 71407666	09.92	10.95				BDX
	1.9 D Lim.		S 71407666	09.92	10.95				BDX
	1.4 i Lim.	55	S 71407667		10.95	03.0137-0202.2	650202		229 x 42
	1.6 Lim.	65	S 71407667		10.95	03.0137-9228.2	669228		Bremsbacken-Zubehör
	1.8 i Lim.	74	S 71407667		10.95				BDX
	1.9 D Lim.		S 71407667		10.95				BDX
	1.4 i Kombi		S 71211989	09.92	10.95	03.0137-0271.2	650271		229 x 42 HEB
	1.4 i Kombi	55	S 71211989	09.92	10.95	03.0137-9027.2	669027		Bremsbacken-Zubehör
	1.4 i Lim.	65	S 71211989	09.92	10.95				TRW
	1.6 Kombi	65	S 71211989	09.92	10.95				
1.6 Kombi	65	S 71211989	09.92	10.95					
1.6 Lim.	65	S 71211989	09.92	10.95					
1.8 i Kombi	74	S 71211989	09.92	10.95					
1.8 i Kombi	74	S 71211989	09.92	10.95					
1.8 i Lim.	74	S 71211989	09.92	10.95					
1.9 D Kombi		S 71211989	09.92	10.95					
1.9 D Kombi		S 71211989	09.92	10.95					
1.9 D Lim.		S 71211989	09.92	10.95					
1.4 i Kombi		S 71211989	09.92	10.95	03.0137-0347.2	650347		229 x 42 HEB	
1.4 i Kombi	65	S 71211989	09.92	10.95	03.0137-9220.2	669220		Bremsbacken-Zubehör	
1.6 Kombi	65	S 71211989	09.92	10.95				TRW	
1.6 Kombi	65	S 71211989	09.92	10.95					
1.8 i Kombi	74	S 71211989	09.92	10.95					
1.8 i Kombi	74	S 71211989	09.92	10.95					
1.9 D Kombi		S 71211989	09.92	10.95					
1.9 D Kombi		S 71211989	09.92	10.95					
1.9 TD Kombi		S 71211989	09.92	10.95					
	1.4 i	55		09.92	10.95	24.0222-8017.1	480071		229/230 x 50,8
	1.6	65		09.92	10.95				
	1.8 i			09.92	10.95				
	1.9 D			09.92	10.95				
	1.9 TD			09.92	10.95				
	1.4 i Lim.	55	S 71407667		10.95	03.0520-1220.3	691220		20,64/229x42 TopKit
	1.6 Lim.	65	S 71407667		10.95				BDX
	1.8 i Lim.	74	S 71407667		10.95				
	1.9 D Lim.		S 71407667		10.95				
	1.4 i Kombi		S 71211989	09.92	10.95	03.0520-4120.3	694120		20,64/229x42 TopKit
	1.4 i Kombi	55	S 71211989	09.92	10.95				TRW
	1.4 i Lim.	65	S 71211989	09.92	10.95				
	1.6 Kombi	65	S 71211989	09.92	10.95				
	1.6 Kombi	65	S 71211989	09.92	10.95				
	1.6 Lim.	65	S 71211989	09.92	10.95				
1.8 i Kombi	74	S 71211989	09.92	10.95					
1.8 i Kombi	74	S 71211989	09.92	10.95					
1.8 i Lim.	74	S 71211989	09.92	10.95					
1.9 D Kombi		S 71211989	09.92	10.95					
1.9 D Kombi		S 71211989	09.92	10.95					
1.9 D Lim.		S 71211989	09.92	10.95					

¹⁾ notice length / attenzione lunghezza / faire attention longueur / atención largo

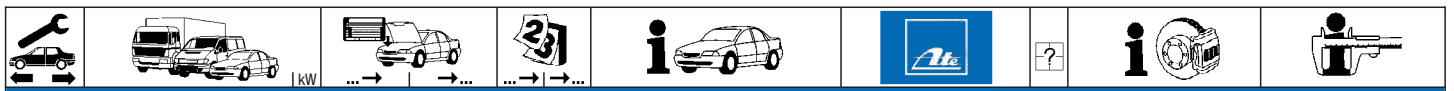

PEUGEOT 405 (93-95)

	1.4 i Kombi 1.4 i Kombi 1.6 Kombi 1.6 Kombi 1.8 i Kombi 1.8 i Kombi 1.9 D Kombi 1.9 D Kombi 1.9 TD Kombi	S 71211990 65 65 S 71211990 74 74 S 71211990 S 71211990	09.92 09.92 09.92 09.92 09.92 09.92	10.95 + ABS (Bosch) 10.95 - ABS 10.95 + ABS (Bosch) 10.95 - ABS 10.95 + ABS (Bosch) 10.95 - ABS 10.95 + ABS (Bosch) 10.95 - ABS 10.95 - ABS	03.0520-5420.3 695420			20,64/229x42 TopKit TRW
	1.4 i 1.6 1.8 i 1.9 D 1.9 TD	55 65	09.92 09.92 09.92 09.92 09.92	10.95 10.95 10.95 10.95 10.95 + HA-Trommelbremse 1)	24.3727-0831.2 24.3727-0804.2 24.3727-0803.2	580831 580804 580803	1 ☐ ☐ ☐	L=1842 L=855 L=550
	1.9 1.9 TD 2.0 16V 2.0 i	93 144 89	09.92 09.92 09.92 09.92	12.93 10.95 + HA-Scheibenbremse 2) 10.95 10.95	24.3727-0831.2 24.3727-0809.2 24.3727-0808.2	580831 580809 580808	1 ☐ ☐ ☐	L=1842 L=872 L=558
	1.4 i 1.6 1.8 i 1.9 1.9 D 1.9 TD 2.0 16V 2.0 i	55 65 93 144 89	09.92 09.92 09.92 09.92 09.92 09.92 09.92 09.92	10.95 10.95 10.95 12.93 10.95 10.95 10.95 10.95	03.6583-0037.3	320107		BRL 8/3 (4) ATE
	1.6 1.8 i 1.9 1.9 D 2.0 i	65 93 89	09.92 09.92 09.92 09.92 09.92	10.95 10.95 12.93 10.95 10.95	24.3728-0843.2	590843		L=1443, + AUT

PEUGEOT 504 (68-89)

	1.8 Kombi 1.8 Lim. 1.9 D Lim. 2.0 Kombi 2.0 Lim. 2.0 Ti 2.1 D Kombi 2.1 D Lim. 2.3 D Kombi 2.3 D Lim.	3.597.843 3.597.843 3.597.843 3.597.843 3.597.843 3.597.843 3.597.843 3.597.843 3.597.843 3.597.843	3.624.586 3.624.586 3.624.586 3.624.586	06.83 07.86 06.86 06.83 07.86 12.83	03.2120-1122.3 010084			THz 20,64 ATE
	1.6 Pick up 1.8 1.8 Pick-up 1.9 D 2.0 2.0 Ti 2.1 D 2.3 D	2.782.006 2.782.006 2.782.006 2.782.006 2.782.006 2.782.006	10.81 10.81	06.87 07.86 + (N) (S) (FR) 12.89 12.89 + (N) (S) (FR) 07.86 + (N) (S) (FR) 06.83 + (N) (S) (FR) 07.86 + (N) (S) (FR) 12.89 + (N) (S) (FR)	11.0441-5401.2 250027			Dichtungssatz ATE
	2.7 V6 Cabrio 2.7 V6 Coupe		09.74 09.74	08.84 08.84	11.0441-5401.2 250027			Dichtungssatz ATE
	1.6 Pick up 1.8 1.9 D 2.0 2.0 Ti 2.1 D 2.3 D		10.79 07.68 03.73 03.71 01.71 02.71 07.75	06.87 12.89 12.89 07.86 06.83 07.86 12.89	24.0113-0128.1 413128			273 13,0 10,7
	1.6 Pick up 1.8 Cabrio 1.8 Coupe 1.8 Kombi 1.8 Lim. 1.8 Pick-up 1.9 D Lim. 2.0 Cabrio 2.0 Coupe 2.0 Kombi 2.0 Lim. 2.1 D Kombi 2.1 D Lim. 2.3 D Kombi 2.3 D Lim. 2.7 V6 Cabrio 2.7 V6 Coupe	2.058.001 2.058.001 2.058.001 2.058.001 2.058.001 2.058.001 2.058.001 2.058.001 2.058.001 2.058.001 2.058.001 2.058.001 2.058.001 2.058.001 2.058.001 2.058.001	10.81 09.77 09.77 11.81 09.77 09.77 09.77 09.77 09.77 09.77 10.77 08.79 10.77 08.79	06.87 08.84 08.84 07.86 06.83 12.89 07.86 08.84 08.84 07.86 06.86 07.86 07.86 07.86 07.86 08.84 08.84	24.5112-0381.3 330711	2		L=380
	1.8 Cabrio 1.8 Coupe 1.8 GL 1.9 D Lim. 2.0 Cabrio 2.0 Coupe 2.0 GL 2.0 Ti 2.1 D Lim.	2.058.001 2.058.001 2.058.001 2.058.001 2.058.001 2.058.001 2.058.001 2.058.001	08.79 10.77 08.79	08.84 08.84 06.83 07.86 08.84 08.84 06.86 06.83 07.86	24.5228-0216.3 330908	2		L=216

1) + RA drum brake / + P freno a tamburo / + frein à tambour essieu AR / + ET-tambores de freno
2) + RA disc brake / + P disco freno / + frein à disque essieu AR / + ET-disco de freno





PEUGEOT 504 (68-89)										
	2.3 D Lim. 2.7 V6 Cabrio 2.7 V6 Coupe			08.79 09.74 09.74	12.83 12.84 12.84	24.5228-0216.3	330908	2		L=216
	1.8 Lim. 1.6 Pick up 1.8 Pick-up			09.77 09.81 09.81	06.83 06.87 12.89	24.3222-1107.3	020262			Rz 22,20 TRW Rz 22,20 TRW
	1.6 Pick up 1.8 Lim. 2.1 D Kastenw.			09.80 09.77 09.80	08.81 06.83 08.81	03.0137-9082.2	669082			Bremsbacken-Zubehör TRW
	1.8 Kombi 1.8 L/GR/SR 2.0 Kombi 2.0 L/GR/SR 2.1 D Kombi 2.3 D Kombi	2.058.001 2.058.001 2.058.001 2.058.001 2.058.001		07.75	07.86 06.83 07.86 06.86 07.86 07.86	03.6515-0600.3	320088			BRL 1/5 (2) ATE
	1.8 1.9 D 2.0 2.0 Ti 2.1 D 2.3 D 2.7 V6	1.974.191 1.974.191 1.974.191 1.974.191 1.974.191 1.974.191		09.74	12.89 12.89 07.86 06.83 07.86 12.89 08.84	24.2419-0929.3	030057			Gz 19,05
	1.8 1.9 D 2.0 2.0 Ti 2.1 D 2.3 D 2.7 V6	3.650.193 1.974.191 3.650.193 3.650.193 1.974.191 1.974.191 3.650.193			12.89 12.89 07.86 06.83 07.86 12.89 08.84	24.2528-1601.3	040063			Nz 28,57

PEUGEOT 505 (79-93)										
	1.8 2.0 Lim. 2.0 Ti/STi 2.2 GTi Lim. 2.2 i Lim. 2.2 Ti 2.3 TD 2.5 D Lim. 2.5 TD Lim. 2.8 V6			01.82 11.80 08.79 08.83 05.81 03.84 09.80 06.81 10.83 06.86	10.86 10.86 10.86 12.93 12.93 10.88 06.86 12.93 12.93 12.93	03.2120-1122.3	010084			Thz 20,64 ATE
	1.8 2.0 2.0 Ti/STi 2.2 GTi 2.2 i 2.3 TD 2.5 D 2.5 TD			01.82 11.80 08.79 08.83 05.81 09.80 06.81 10.83	10.86 11.87 10.86 12.93 12.93 06.86 12.93	11.0441-5401.2	250027			Dichtungssatz ATE
	2.2 Ti 2.8 V6			03.84 06.86	10.88 12.93	11.0441-5401.2	250027			Dichtungssatz ATE
	1.8 2.0 2.0 Ti/STi 2.2 GTi 2.2 i 2.3 TD 2.5 D 2.5 TD			01.82 11.80 08.79 08.83 05.81 09.80 06.81 10.83	10.86 11.87 10.86 12.93 12.93 06.86 12.93	24.0113-0128.1	413128			273 13,0 10,7
	1.8 2.0 2.0 Ti/STi 2.2 GTi 2.2 i 2.2 Ti 2.3 TD 2.5 D 2.5 TD 2.8 V6			01.82 11.80 08.79 08.83 05.81 03.84 09.80 06.81 10.83 06.86	10.86 11.87 10.86 12.93 12.93 10.88 06.86 12.93	24.5112-0381.3	330711	2		L=380
	1.8 2.0 Lim. 2.0 Ti/STi 2.2 GTi Lim. 2.2 i Lim. 2.2 Ti 2.3 TD 2.5 D Lim. 2.5 TD Lim. 2.8 V6			01.82 11.80 08.79 08.83 05.81 03.84 09.80 06.81 10.83 06.86	10.86 10.86 10.86 12.93 12.93 10.88 06.86 12.93	24.5228-0216.3	330908	2		L=216
	2.0 Lim. 2.0 Ti/STi 2.2 i Lim. 2.3 TD 2.5 D Lim.	1.214.334 1.214.334 1.214.334 1.214.334 1.214.334		11.80 08.79 05.81 09.80 06.81		24.3222-1107.3	020262			Rz 22,20 TRW
	1.8			01.82	10.86	24.3220-1619.3	020246			Rz 20,64 TRW



PEUGEOT 505 (79-93)

	2.0 Lim. 2.0 Ti/STi 2.2 i Lim. 2.3 TD 2.5 D Lim. 2.5 TD Lim.	1.214.335 1.214.335 1.214.335 1.214.335 1.214.335		10.86 10.86 12.93 06.86 12.93 10.83 12.93		24.3220-1619.3	020246		Rz 20,64	TRW
	2.0 Kombi 2.2 i Kombi 2.5 D Kombi 2.5 TD Kombi			04.82 11.87 01.86 12.93 08.83 12.93 10.85 12.93		24.3222-1615.3	020285		Rz 22,20	TRW
	2.0 Ti/STi		1.132.381	08.79		03.0137-9082.2	669082		Bremsbacken-Zubehör	TRW
	1.8 2.0 Lim. 2.0 Ti/STi 2.2 i Lim. 2.3 TD 2.5 D Lim. 2.5 TD Lim.	1.132.382		01.82 10.86 11.80 10.86 05.81 12.93 09.80 06.86 06.81 12.93 10.83 12.93		03.0137-9082.2	669082		Bremsbacken-Zubehör	TRW
	2.0 Kombi 2.2 i Kombi 2.5 D Kombi 2.5 TD Kombi			04.82 11.87 01.86 12.93 08.83 12.93 10.85 12.93		03.0137-9082.2	669082		Bremsbacken-Zubehör	TRW
	2.0 Kombi 2.2 GTi Kombi 2.2 i Kombi 2.5 D Kombi 2.5 TD Kombi			04.82 11.87 09.85 12.86 01.86 12.93 08.83 12.93 10.85 12.93		03.6515-0600.3	320088		BRL 1/5 (2)	ATE
	1.8 2.0 2.0 Ti/STi 2.2 GTi 2.2 i 2.2 Ti 2.3 TD 2.5 D 2.5 TD 2.8 V6			01.82 10.86 11.80 11.87 08.79 10.86 08.83 12.93 05.81 12.93 03.84 10.88 09.80 06.86 06.81 12.93 10.83 12.93 06.86 12.93		24.2419-0929.3	030057		Gz 19,05	
	1.8 2.0 2.0 Ti/STi 2.2 GTi 2.2 i 2.2 Ti 2.3 TD 2.5 D			01.82 10.86 11.80 11.87 08.79 10.86 08.83 12.93 05.81 12.93 03.84 10.88 09.80 06.86 06.81 12.93		24.2528-1601.3	040063		Nz 28,57	
	1.8 2.0 Kombi 2.0 Lim. 2.0 Ti/STi 2.2 GTi Kombi 2.2 GTi Lim. 2.2 i Kombi 2.2 i Lim. 2.2 Ti 2.3 TD 2.5 D Kombi 2.5 D Lim. 2.5 TD Kombi 2.5 TD Lim. 2.8 V6	◀ ◀ ◀ ◀ ◀ ◀ ◀ ◀ ◀ ◀ ◀ ◀ ◀ ◀ ◀		01.82 10.86 04.82 11.87 11.80 10.86 08.79 10.86 09.85 12.86 08.83 12.93 01.86 12.93 05.81 12.93 03.84 10.88 09.80 06.86 08.83 12.93 06.81 12.93 10.85 12.93 10.83 12.93 06.86 12.93		24.5228-0216.3	330908		L=216	
	2.3 TD 2.5 D Lim.	▶ ▶	1.292.000 1.292.000	09.80 06.81		24.5112-0381.3	330711		L=380	

PEUGEOT 604 (75-86)

	2.0 2.3 TD 2.5 TD	70 59 66		03.83 02.87 10.78 10.83 10.83 10.86		11.0441-5401.2	250027		Dichtungssatz	ATE
	2.7 V6 2.7 V6 2.8 V6	100 106		09.75 10.84 10.77 10.83 10.83 10.86		11.0441-5401.2	250027		Dichtungssatz	ATE
	2.0 2.3 TD 2.5 TD	70 59 66		03.83 02.87 10.78 10.83 10.83 10.86		24.0113-0128.1	413128		273 13,0 10,7	
	2.0 2.3 TD 2.5 TD 2.7 V6 2.7 V6 2.8 V6	70 59 66 100 106		03.83 02.87 10.78 10.83 10.83 10.86 09.75 10.84 10.77 10.83 10.83 10.86		24.5112-0381.3	330711	2	L=380	
	2.0 2.3 TD 2.5 TD 2.7 V6 2.7 V6 2.8 V6	70 59 66 100 106		03.83 02.87 10.78 10.83 10.83 10.86 09.75 10.84 10.77 10.83 10.83 10.86		24.5228-0216.3	330908	2	L=216	



PEUGEOT 604 (75-86)									
	2.0 2.3 TD 2.5 TD 2.7 V6 2.7 V6 2.8 V6	70 59 66 100 106		03.83 10.78 10.83 09.75 10.77 10.83	02.87 10.83 10.86 10.84 10.83 10.86	24.2419-0929.3	030057		Gz 19,05
	2.0 2.3 TD 2.5 TD	70 59 66		03.83 10.78 10.83	02.87 10.83 10.86	24.2528-1601.3	040063		Nz 28,57
	2.7 V6 2.8 V6	106		10.77 10.83	10.83 10.86	24.5228-0216.3	330908		L=216
POL MOT 125 (67-74)									
	alle Typen			09.67	08.74	24.2119-0806.3	010345		THz 19,05
POL MOT 126 (72-90)									
	alle Typen			01.79	07.90	24.2119-0815.3	010347		THz 19,05
	alle Typen			04.72	12.78	24.3223-0801.3	020316		Rz 23,81
	alle Typen			01.79	07.90	24.3223-0802.3	020286		Rz 23,81 FI
	alle Typen			04.72	07.90	03.0137-0015.2 03.0137-9021.2	650015 669021		185 x 31 AUT Bremsbacken-Zubehör FI
	alle Typen			04.72	12.78	24.3215-0802.3	020308		Rz 15,87 FI
	alle Typen			01.79	07.90	24.3219-0801.3	020181		Rz 19,05 FI
	alle Typen			04.72	07.90	03.0137-0015.2 03.0137-9021.2	650015 669021		185 x 31 AUT Bremsbacken-Zubehör FI
PORSCHE 356 (51-65)									
	356 1.1/1.3/1.5 356 A 1.3/1.5 356 B 1.6 502 Super 1.5 550 Spyder 1.5			01.51 01.54 01.60 01.52 01.55	12.53 12.59 12.62 12.53 12.56	03.3119-0201.3 03.3119-0211.3 24.3526-0110.3	010257 010258 340018	1	Hz 19,05 Hz 19,05 + Behälter Bremslichtschalter ATE
	1600 1600 C/SC 1600 Super 90			01.63 01.63 01.63	12.65 12.65 12.65	03.3119-6551.3 03.3526-2002.3	010270 340010	1	Hz 19,05 Bremslichtschalter ATE
	1600 C/SC 1600 Super 90 356 1.1/1.3/1.5 356 A 1.3/1.5 356 A 1.5 356 B 1.6 B 2000 GS Carrera C 2000 GS Carrera			01.63 01.63 01.60 01.61 01.61 01.61 01.61 01.61	12.65 12.65 12.65 12.64 12.64 12.64 12.64 12.64	13.0441-4801.2	250100		Dichtungssatz ATE
	1600 C/SC 1600 Super 90 356 1.1/1.3/1.5 356 A 1.3/1.5 356 A 1.5 356 B 1.6 B 2000 GS Carrera C 2000 GS Carrera			01.63 01.63 01.60 01.61 01.61 01.61 01.64 01.64	12.65 12.65 12.65 12.65 12.65 12.65 12.65 12.65	13.0462-4855.2	600018		20910 15,0 /WE ATE
	1600 1600 C/SC 1600 Super 90 356 A 1.3/1.5 356 B 1.6			01.55 01.63 01.63 01.56 01.60	12.65 12.65 12.65 12.65 12.65	24.5165-0350.3	331257	2	L=350
	1500 S 356 A 1.3/1.5 356 B 1.6 550 Spyder 1.5			01.50 01.50 01.60 01.50	12.59 12.59 12.63 12.59	03.2719-0209.3 03.2719-0309.3	020002 020003	2 2	links oben + rechts unten ¹⁾ rechts oben + links unten ²⁾ Rz 19,05 Rz 19,05
	1600 C/SC 1600 Super 90 356 1.1/1.3/1.5 356 A 1.3/1.5 356 A 1.5 356 B 1.6 B 2000 GS Carrera C 2000 GS Carrera			01.63 01.63 01.60 01.61 01.61 01.61 01.61 01.61	12.65 12.65 12.65 12.64 12.64 12.64 12.64 12.64	13.0441-3502.2	250049		Dichtungssatz ATE
	356 A 1.3/1.5			01.55	12.59	83.6101-0520.3	330215	2	L=520
	1600 1600 C/SC 1600 Super 90 356 B 1.6			01.63 01.63 01.63 01.60	12.65 12.65 12.65 12.65	83.6101-0240.3	330202	2	L=240

¹⁾ upper left and lower right / sinistra alto e destra basso / gauche, en haut + droite, en bas / izquierda arriba+derecha abajo

²⁾ upper right and lower left / destra alto e sinistra basso / droite, en haut+gauche, en bas / derecha arriba+izquierda abajo



PORSCHE 356 (51-65)

	1600 C/SC		01.60	12.65	03.3219-0102.3	020036			Rz 19,05
	1600 GT		01.60	12.65	03.0470-2619.2	060051			Rz Dichtungssatz
	1600 Super 90		01.60	12.65					
	356 1.1/1.3/1.5		01.51	12.53					
	356 A 1.3/1.5	G 18 605		12.59					
	356 A 1.5	G 18 605		12.59					
	356 B 1.6		01.60	12.65					
	502 Super 1.5		01.52	12.53					
	550 Spyder 1.5		01.55	12.56					
	B 2000 GS Carrera		01.60	12.65					
C 2000 GS Carrera		01.60	12.65						

PORSCHE 911/930 (63-90)

	911		01.64	12.67	03.3119-7251.3	010272			Hz 19,05	ATE
	911		01.68	12.75	03.2119-2301.3	010055			THz 19,05	ATE
					03.2119-0881.3	010053			THz 19,05 + WE	ATE
	911		01.76	12.77	03.2119-0881.3	010053			THz 19,05 + WE	ATE
	911 Carrera 3.0		01.74	12.77						
	911 S		01.74	12.77						
	930		01.75	12.77						
	911 Cabrio		01.84	12.89	03.2120-2462.3	010113			THz 20,64 + WE	ATE
	911 Coupe		01.84	12.89	24.3526-1900.0	340038	2		Bremslichtschalter	
	911 SC		01.78	12.83						
911 Targa		01.78	12.89							
	911 Turbo Look Coupe		01.84	12.89	03.2123-0162.3	010162			THz 23,81 + WE	ATE
	930		01.78	12.89	24.3526-1900.0	340038	2		Bremslichtschalter	
	911		01.69	12.75	13.2481-9999.2	210103		<input type="checkbox"/> Flanschmaß=76,2 ¹⁾	D=48	ATE
	911 S		01.74	12.75	13.2481-9998.2	210102		<input type="checkbox"/> Flanschmaß=76,2 ¹⁾	D=48	ATE
	911 T		01.69	12.70	13.0441-4815.2	250102			Dichtungssatz	ATE
	911 USA		01.69	12.70						
	911		01.76	12.77	13.2481-8067.2	210098		<input type="checkbox"/>	D=48	ATE
	911 Carrera 3.0		01.74	12.77	13.2481-8068.2	210099		<input type="checkbox"/>	D=48	ATE
	911 E/S		01.69	12.76	13.0441-4819.2	250104		+ GG-Sättel ²⁾	Dichtungssatz	ATE
	911 S		01.76	12.77	13.0441-4806.2	250101		+ ALU-Sättel ³⁾	Dichtungssatz	ATE
	911 SC		01.78	12.83						
	911 Targa		01.78	12.83						
	911 Cabrio		01.84	12.89	13.2481-0075.2	210081		<input type="checkbox"/>	D=48	ATE
	911 Carrera		01.84	12.89	13.2481-0076.2	210082		<input type="checkbox"/>	D=48	ATE
	911 Coupe		01.84	12.89	13.0441-4819.2	250104			Dichtungssatz	ATE
	911 Targa		01.84	12.89						
	911 Turbo Look Coupe		01.84	12.89						
	911		01.74	12.75	13.0462-4855.2	600018		für M-Sattel ⁴⁾	20910 15,0 / WE	ATE
	911 S		01.74	12.77						
		911		01.76	12.77	13.0460-4048.2	604048			20011 15,0 / WE
911 Carrera 3.0			01.74	12.77						
911 SC			01.78	12.83						
911 Targa			01.78	12.83						
911 Cabrio			01.84	12.89	13.0460-4048.2	604048			20011 15,0 / WE	ATE
911 Carrera			01.84	12.89	24.8190-0927.2	620927	2		Warnkontakt L=276mm	
911 Coupe			01.84	12.89						
911 Turbo Look Coupe			01.84	12.89						
911 Turbo			01.78	12.89	24.8190-0904.2	620904	2		Warnkontakt L=275mm	
		911		01.69	12.77	24.0120-0103.1	420103			283 20,5 19,1 V L
	911 Carrera 3.0		01.74	12.77						
	911 S		01.74	12.77						
	911 Carrera 3.2		08.83	12.89	24.0124-0189.1	424189			283 24,0 22,6 V L	
	911 Turbo 3.3		01.81	12.90	24.0132-0140.1	432140		<input type="checkbox"/>	304 32,0 30,6 V L +B	
					24.0132-0146.1	432146		<input type="checkbox"/>	304 32,0 30,6 V L +B	
					24.5225-0300.3	331266	2		L=300	
	911		01.74	12.77						
	911 Cabrio		01.84	12.89						
	911 Carrera		01.84	12.89						
	911 Carrera 3.0		01.74	12.77						
	911 Coupe		01.84	12.89						
	911 S		01.74	12.77						
	911 SC		01.78	12.83						
	911 Targa		01.78	12.89						
	911 Turbo		01.78	12.89						
	911 Turbo Look Coupe		01.84	12.89						
	911		01.69	12.77	13.0441-3805.2	250061			Dichtungssatz	ATE
	911 E/S		01.69	12.77						
	911 S		01.69	12.77						
	911 T		01.69	12.77						
	911 USA		01.69	12.77						
	911		01.74	12.77	13.2381-9996.2	210039		<input type="checkbox"/>	D=38	ATE
	911 Carrera 3.0		01.74	12.77	13.2381-9997.2	210040		<input type="checkbox"/>	D=38	ATE
	911 S		01.74	12.77	13.0441-3801.2	250058			Dichtungssatz	ATE
	911 SC		01.78	12.83						
	911 Targa		01.78	12.83						
	911 Cabrio		01.84	12.89	13.2421-0026.2	210146		<input type="checkbox"/>	D=42	ATE
	911 Carrera		01.84	12.89	13.2421-0025.2	210145		<input type="checkbox"/>	D=42	ATE
	911 Coupe		01.84	12.89	13.0441-4206.2	250087			Dichtungssatz	ATE
	911 Turbo Look Coupe		01.84	12.89						























¹⁾ flange dimension=76,2 / misura flangia=76,2 / dimension de la bride=76,2 / medida de brida=76,2



























²⁾ + cast iron caliper / + pinza in ghisa / + étriers en fonte grise / + fundición gris-pinza

³⁾ + aluminium calipers / + pinze in alluminio / + étriers en aluminium / + pinzas de aluminio































⁴⁾ for M caliper / per pinze M / pour étrier M / para pinza de M



									
PORSCHE 911/930 (63-90)									
	911		01.74	12.74	13.0462-4855.2	600018		20910 15,0 /WE	ATE
	911 Carrera 3.0		01.74	12.74	13.0460-0192.2	610192		Belagsatz-Zubehör	ATE
	911 S		01.74	12.74					
	911 Cabrio		01.84	12.89	13.0462-4855.2	600018		20910 15,0 /WE	ATE
	911 Carrera		01.84	12.89	13.0460-0193.2	610193		Belagsatz-Zubehör	ATE
	911 Coupe		01.84	12.89	24.8190-0904.2	620904	2	Warnkontakt L=275mm	
911 Targa		01.78	12.89						
911 Turbo Look Coupe		01.84	12.89						
	911		01.74	12.83	24.0120-0185.1	420185		290 20,0 18,7 V L	
	911 Carrera 3.0		01.74	12.83					
	911 S		01.74	12.77					
	911 SC		01.78	12.83					
	911 Targa		01.78	12.83					
	911 Carrera 3.2		08.83	12.89	24.0124-0190.1	424190		290 24,0 22,6 V L	
911 Turbo 3.3		01.87	12.90	24.0128-0171.1	428171		309 28,0 26,0 V L +B		
		01.87	12.90	24.0128-0172.1	428172		309 28,0 26,0 V L +B		
	911		01.64	12.69	83.6101-0240.3	330202	2	L=240	
	911 E/S		01.64	12.69					
	911 S		01.66	12.68					
	911		01.74	12.77	24.5225-0240.3	331321	2	L=240	
	911 Carrera 3.0		01.74	12.77					
	911 E/S		01.64	12.69					
	911 S		01.74	12.77					
	911 SC		01.78	12.83					
	911 Targa		01.78	12.83					
	911 Turbo		01.78	12.83					
911 Turbo Look Coupe			01.70	12.77					
	911 Cabrio		01.84	12.89	83.6205-0252.3	330315	2	L=250	
	911 Carrera		01.84	12.89					
	911 Coupe		01.84	12.89					
	911 Targa		01.84	12.89					
	911 Turbo		01.84	12.89					
	911 Turbo Look Coupe		01.84	12.89					
	911 Cabrio		01.87	12.89	24.2523-0909.3	040050		Nz 23,81	
	911 Carrera		01.87	12.89					
	911 Coupe		01.87	12.89					
911 Targa		01.87	12.89						
911 Turbo Look Coupe		01.87	12.89						
PORSCHE 911 (964) (88-93)									
	3.3 TURBO	235	08.90	09.93	24.8190-0917.2	620917	2	Warnkontakt L=518mm	
	3.6 CARRERA RS	191	06.91	09.93					
	3.6 CARRERA	184	07.89	09.93	24.8190-0917.2	620917	2	Warnkontakt L=518mm	
	3.6 CARRERA 4	184	12.88	09.93					
	3.6 TURBO	265	01.93	09.93	13.0460-4056.2	604056		21402 17,5 /WE	BRE
	3.6 CARRERA	184	07.89	09.93	24.0128-0174.1	428174		298 28,0 26,0 V L	
	3.6 CARRERA 4	184	12.88	09.93					
	3.6 CARRERA	184	07.89	09.93	83.6220-0296.3	330324	2	L=295	
	3.6 CARRERA 4	184	12.88	09.93					
	3.6 CARRERA RS	191	06.91	09.93					
	3.3 TURBO	235	08.90	12.91	24.8190-0918.2	620918	2	Warnkontakt L=440mm	
	3.3 TURBO	235	01.92	09.93	24.8190-0918.2	620918	2	Warnkontakt L=440mm	
	3.6 CARRERA 4	184	12.88	09.93					
	3.6 CARRERA RS	191	06.91	09.93					
	3.6 TURBO	265	01.93	09.93					
	3.6 CARRERA	184	07.89	09.93	13.0460-4070.2	604070		21163 14,5 /WE	ATE
	3.6 CARRERA 4	184	12.88	09.93	24.8190-0918.2	620918	2	Warnkontakt L=440mm	
3.6 CARRERA 4		184	24.0124-0117.1	424117			299 24,0 22,0 V L		
		184	12.88	09.93					
	3.3 TURBO	235	08.90	09.93	83.6205-0252.3	330315	2	L=250	
	3.3 TURBO S	261	06.91	12.92					
	3.6 CARRERA	184	07.89	09.93					
	3.6 CARRERA 4	184	12.88	09.93					
	3.6 CARRERA RS	191	06.91	09.93					
	3.6 TURBO	265	01.93	09.93					
	3.3 TURBO	235	08.90	09.93	03.0137-3002.2	653002		180 x 25	
	3.3 TURBO S	261	06.91	12.92					
	3.6 CARRERA	184	07.89	09.93					
	3.6 CARRERA 4	184	12.88	09.93					
	3.6 CARRERA RS	191	06.91	09.93					
	3.6 TURBO	265	01.93	09.93					
PORSCHE 911 CABRIO (964) (89-94)									
	3.6 CARRERA	184	07.89	05.94	24.8190-0917.2	620917	2	Warnkontakt L=518mm	
	3.6 CARRERA 4	184	05.89	05.94					
	3.6 CARRERA	184	07.89	05.94	24.0128-0174.1	428174		298 28,0 26,0 V L	
	3.6 CARRERA 4	184	05.89	05.94					

									
PORSCHE 911 CABRIO (964) (89-94)									
	3.6 CARRERA 3.6 CARRERA 4	184 184		07.89 05.89	05.94 05.94	83.6220-0296.3	330324	2	L=295
	3.6 CARRERA 3.6 CARRERA 4	184 184		07.89 05.89	05.94 05.94	13.0460-4070.2 24.8190-0918.2	604070 620918	2	21163 14,5 /WE Warnkontakt L=440mm
	3.6 CARRERA 3.6 CARRERA 4	184 184		07.89 05.89	05.94 05.94	24.0124-0117.1	424117		299 24,0 22,0 V L
	3.6 CARRERA 3.6 CARRERA 4	184 184		07.89 05.89	05.94 05.94	83.6205-0252.3	330315	2	L=250
	3.6 CARRERA 3.6 CARRERA 4	184 184		07.89 05.89	05.94 05.94	03.0137-3002.2	653002		180 x 25
PORSCHE 911 (993) (93-97)									
	3.6 CARRERA 3.6 CARRERA 4 3.8 CARRERA 3.8 CARRERA 4	 210 210		10.93 07.94 06.95 06.95	09.97 09.97 09.97 09.97	24.8190-0917.2	620917	2	Warnkontakt L=518mm
	3.6 TURBO 4 3.6 TURBO GT2 3.6 TURBO GT2 4 3.8 CARRERA RS 3.8 CARRERA RS 4	300 316 221 221		03.95 03.95 08.95 06.95 08.95	09.97 09.97 09.97 09.97 09.97	13.0460-4056.2 24.8190-0926.2	604056 620926	2	21402 17,5 /WE Warnkontakt L=475mm
	3.6 CARRERA 3.6 CARRERA 4 3.8 CARRERA 3.8 CARRERA 4	 210 210		10.93 07.94 06.95 06.95	09.97 09.97 09.97 09.97	24.0132-0142.1 24.0132-0143.1	432142 432143	<input type="checkbox"/> <input type="checkbox"/>	304 32,0 30,0 V L +B 304 32,0 30,0 V L +B
	3.6 TURBO 4 3.6 TURBO GT2 3.6 TURBO GT2 4	300 316		03.95 03.95 08.95	09.97 09.97 09.97	24.0132-0163.2 24.0132-0164.2	432163 432164	<input type="checkbox"/> zweiteilige Bremsscheibe/ mit ABE ¹⁾ <input type="checkbox"/> zweiteilige Bremsscheibe/ mit ABE ¹⁾	322 32,0 30,0 V L +B 322 32,0 30,0 V L +B
	3.6 CARRERA 3.6 CARRERA 4 3.6 TURBO 4 3.6 TURBO GT2 3.6 TURBO GT2 4 3.8 CARRERA 3.8 CARRERA 4 3.8 CARRERA RS 3.8 CARRERA RS 4	 300 316 210 210 221 221		10.93 07.94 03.95 03.95 08.95 06.95 06.95 06.95 08.95	09.97 09.97 09.97 09.97 09.97 09.97 09.97 09.97 09.97	83.6220-0296.3	330324	2	L=295
	3.6 CARRERA 3.6 CARRERA 4 3.8 CARRERA 3.8 CARRERA 4	 210 210		10.93 07.94 06.95 06.95	09.97 09.97 09.97 09.97	24.8190-0920.2	620920	2	Warnkontakt L=698mm
	3.6 TURBO 4 3.6 TURBO GT2 3.6 TURBO GT2 4 3.8 CARRERA RS 3.8 CARRERA RS 4	300 316 221 221		03.95 03.95 08.95 06.95 08.95	09.97 09.97 09.97 09.97 09.97	24.8190-0920.2	620920	2	Warnkontakt L=698mm
	3.6 CARRERA 3.6 CARRERA 4 3.8 CARRERA 3.8 CARRERA 4	 210 210		10.93 07.94 06.95 06.95	09.97 09.97 09.97 09.97	24.0124-0183.1	424183		299 24,0 22,0 V L +B
	3.6 CARRERA 3.6 CARRERA 4 3.6 TURBO 4 3.6 TURBO GT2 3.6 TURBO GT2 4 3.8 CARRERA 3.8 CARRERA 4 3.8 CARRERA RS 3.8 CARRERA RS 4	 300 316 210 210 221 221		01.95 01.95 03.95 03.95 08.95 06.95 06.95 06.95 08.95	09.97 09.97 09.97 09.97 09.97 09.97 09.97 09.97 09.97	83.6116-0226.3	330454	2	L=230
PORSCHE 911 CABRIO (993) (94-97)									
	3.6 CARRERA 3.6 CARRERA 4 3.8 CARRERA 3.8 CARRERA 4	 210 210		07.94 07.94 06.95 06.95	09.97 09.97 09.97 09.97	24.8190-0917.2	620917	2	Warnkontakt L=518mm
	3.8 CARRERA RS 3.8 CARRERA RS 4	221 221		08.95 08.95	09.97 09.97	13.0460-4056.2 24.8190-0926.2	604056 620926	2	21402 17,5 /WE Warnkontakt L=475mm
	3.6 CARRERA 3.6 CARRERA 4 3.8 CARRERA 3.8 CARRERA 4	 210 210		07.94 07.94 06.95 06.95	09.97 09.97 09.97 09.97	24.0132-0142.1 24.0132-0143.1	432142 432143	<input type="checkbox"/> <input type="checkbox"/>	304 32,0 30,0 V L +B 304 32,0 30,0 V L +B
	3.6 CARRERA 3.6 CARRERA 4 3.8 CARRERA 3.8 CARRERA 4 3.8 CARRERA RS 3.8 CARRERA RS 4	 210 210 221 221		07.94 07.94 06.95 06.95 08.95 08.95	09.97 09.97 09.97 09.97 09.97 09.97	83.6220-0296.3	330324	2	L=295

¹⁾ two-piece brake disc/ with ABE / disco frenante in due parti/ con ABE / disque d.fr.en deux parties/ avec ABE / disco de fr.de dos piezas/ con ABE

	 kW							
PORSCHE 911 CABRIO (993) (94-97)								
	3.6 CARRERA 3.6 CARRERA 4 3.8 CARRERA 210 3.8 CARRERA 4 210		07.94 07.94 06.95 06.95	09.97 09.97 09.97 09.97	24.8190-0920.2	620920	2	Warnkontakt L=698mm
	3.8 CARRERA RS 221 3.8 CARRERA RS 4 221		08.95 08.95	09.97 09.97	24.8190-0920.2	620920	2	Warnkontakt L=698mm
	3.6 CARRERA 3.6 CARRERA 4 3.8 CARRERA 210 3.8 CARRERA 4 210		07.94 07.94 06.95 06.95	09.97 09.97 09.97 09.97	24.0124-0183.1	424183		299 24,0 22,0 V L +B
	3.6 CARRERA 3.6 CARRERA 4 3.8 CARRERA 210 3.8 CARRERA 4 210 3.8 CARRERA RS 221 3.8 CARRERA RS 4 221		01.95 01.95 06.95 06.95 08.95 08.95	09.97 09.97 09.97 09.97 09.97 09.97	83.6116-0226.3	330454	2	L=230
PORSCHE 911 TARGA (993) (95-97)								
	3.6 CARRERA 210		08.95	09.97	24.8190-0917.2	620917	2	Warnkontakt L=518mm
	3.6 CARRERA 210		08.95	09.97	24.0132-0142.1 24.0132-0143.1	432142 432143		304 32,0 30,0 V L +B 304 32,0 30,0 V L +B
	3.6 CARRERA 210		08.95	09.97	83.6220-0296.3	330324	2	L=295
	3.6 CARRERA 210		08.95	09.97	24.8190-0920.2	620920	2	Warnkontakt L=698mm
	3.6 CARRERA 210		08.95	09.97	24.0124-0183.1	424183		299 24,0 22,0 V L +B
	3.6 CARRERA 210		08.95	09.97	83.6116-0226.3	330454	2	L=230
PORSCHE 912 TARGA (65-70)								
	1.6 66		01.65	12.67	03.3119-7251.3	010272		Hz 19,05 ATE
	1.6 66		01.68	12.69	03.2119-2301.3 03.2119-0881.3	010055 010053		THz 19,05 ATE THz 19,05 + WE ATE
	1.6 66		01.65	12.69	24.5225-0300.3	331266	2	L=300
	1.6 66		01.65	12.68	83.6101-0240.3	330202	2	L=240
	1.6 66		01.69	12.69	24.5225-0240.3	331321	2	L=240
PORSCHE 912 (65-69)								
	912 1.6 66		01.65	12.67	03.3119-7251.3	010272		Hz 19,05 ATE
	912 1.6 66		01.68	12.69	03.2119-2301.3 03.2119-0881.3	010055 010053		THz 19,05 ATE THz 19,05 + WE ATE
	912 1.6 66		01.65	12.68	13.0441-4815.2	250102		Dichtungssatz ATE
	912 USA 66		01.64	12.68				
	912 1.6 66		01.64	12.69	24.5225-0300.3	331266	2	L=300
	912 USA 66		01.67	12.69				
	912 1.6 66		01.65	12.68	13.0441-3502.2	250049		Dichtungssatz ATE
	912 1.6 66		01.69	12.69	13.0441-3805.2	250061		Dichtungssatz ATE
	912 USA 66		01.69	12.69				
	912 1.6 66		01.65	12.68	83.6101-0240.3	330202	2	L=240
	912 1.6 66		01.69	12.69	24.5225-0240.3	331321	2	L=240
	912 USA 66		01.69	12.69				
PORSCHE 914/4 (69-76)								
	1.7 59		01.70	12.73	03.2117-1601.3	010039		THz 17,46 + WE ATE
	1.8 63		01.74	12.76				
	2.0 65		01.75	12.76				
	2.0 74		01.73	12.76				
	1.7 59		01.70	12.72	13.0441-4205.2	250086		Dichtungssatz ATE
	1.7 59		01.70	12.72	13.0460-4033.2	604033		20034 15,0 ATE
	1.7 59 47279 19032			12.72	13.0462-4855.2	600018		20910 15,0 /WE ATE
	1.8 63 47279 19032			12.72				
	2.0 65 47279 19032			12.72				
	2.0 74 47279 19032			12.72				
	1.7 59 47229 19033			12.73	13.0462-4855.2	600018		20910 15,0 /WE ATE
	1.8 63 47229 19033			12.76				
	2.0 65 47229 19033			12.76				
	2.0 74 47229 19033			12.76				



PORSCHE 914/4 (69-76)										
	1.7	59		01.70	12.71		24.5225-0300.3	331266	2	L=300
	1.7	59		01.72	12.73		24.5224-0295.3	331261	2	L=295
	1.8	63		01.74	12.76					
	2.0	65		01.75	12.76					
	2.0	74		01.73	12.76					
	1.7	59		01.70	12.73		13.0441-3302.2	250042		Dichtungssatz ATE
	1.8	63		01.74	12.76					
	2.0	65		01.75	12.76					
	2.0	74		01.73	12.76					
	1.7	59		01.70	02.73		24.5224-0240.3	331260	2	L=240
	1.8	63		01.74	12.76					
	2.0	65		01.75	12.76					
	2.0	74		01.73	12.76					
PORSCHE 914/6 (70-73)										
	2.0	81		01.70	12.72		03.2119-2301.3	010055		THz 19,05 ATE
							03.2119-0881.3	010053		THz 19,05 + WE ATE
	2.0	81		01.70	12.72		13.2481-9999.2	210103	<input type="checkbox"/>	D=48 ATE
							13.2481-9998.2	210102	<input type="checkbox"/>	D=48 ATE
							13.0441-4815.2	250102		Dichtungssatz ATE
	2.0	81	47279 19032		12.72		13.0462-4855.2	600018		20910 15,0 /WE ATE
	2.0	81	47229 19033		12.73		13.0462-4855.2	600018		20910 15,0 /WE ATE
	2.0	81		01.70	12.72		24.0120-0103.1	420103		283 20,5 19,1 V L
	2.0	81		01.70	12.72		24.5225-0300.3	331266	2	L=300
	2.0	81		01.70	12.72		13.0441-3810.2	250066		Dichtungssatz ATE
	2.0	81		01.70	12.72		24.5224-0240.3	331260	2	L=240
PORSCHE 924 (76-85)										
	2.0	92		01.80	12.85		03.7750-5702.4	300083		9" ATE
	2.0 CARRERA GT	154		06.80	12.81					
	2.0 Turbo	125		01.80	12.80					
	2.0 Turbo	130		01.81	12.84					
	2.0	74		01.77	12.77		03.2120-0322.3	010074		THz 20,64 + WE ATE
	2.0	85		01.77	12.79		24.3526-1900.0	340038	2	Bremslichtschalter
	2.0	92		01.76	12.79					
	2.0 Turbo	125		01.77	12.77		03.2123-9002.3	010198		THz 23,81 + WE ATE
							24.3526-1900.0	340038	2	Bremslichtschalter
	2.0	92		01.80	12.80		03.2123-7902.3	010191		THz 23,81 + WE ATE
	2.0 Turbo	125		01.80	12.80		24.3526-1900.0	340038	2	Bremslichtschalter
	2.0	92		01.81	12.85		03.2123-8902.3	010197		THz 23,81 ATE
	2.0 Turbo	130		01.81	12.84					
	2.0 CARRERA GT	154		06.80	12.81		03.2023-0172.3	010016		THz 23,81/19,05 ATE
	2.0	74		01.77	12.77		11.0441-4802.2	250017		Dichtungssatz ATE
	2.0	85		01.77	12.79					
	2.0	92		01.76	12.79					
	2.0	92		01.80	12.85		11.0441-5401.2	250027		Dichtungssatz ATE
	2.0 CARRERA GT	154		06.80	12.81					
	2.0 Turbo	125		01.79	12.79					
	2.0 Turbo	125		01.80	12.80					
	2.0 Turbo	130		01.81	12.84					
	2.0	74		01.77	12.77		13.0460-3612.2	603612		20482 18,5 /WE ATE
	2.0	85		01.77	12.79					
	2.0	92		01.76	12.79					
	2.0	74		01.77	12.77		24.0113-0170.1	413170		257 13,0 11,5
	2.0	85		01.77	12.79					
	2.0	92		01.76	12.79					
	2.0	92		01.80	12.85		24.0120-0103.1	420103		283 20,5 19,1 V L
	2.0 CARRERA GT	154		06.80	12.81					
	2.0 Turbo	125		01.77	12.77					
	2.0 Turbo	125		01.80	12.80					
	2.0 Turbo	130		01.81	12.84					
	2.0	74		01.77	12.77		24.5171-0393.3	331311	2	L=393
	2.0	85		01.77	12.79					
	2.0	92		01.76	12.79					
	2.0	92		01.80	12.85		83.6101-0412.3	330212	2	L=410
	2.0 CARRERA GT	154		06.80	12.81					
	2.0 Turbo	125		01.77	12.77					
	2.0 Turbo	125		01.80	12.80					
	2.0 Turbo	130		01.81	12.84					
	2.0 CARRERA GT	154		06.80	12.81		11.0441-3601.2	250007		Dichtungssatz ATE
	2.0 Turbo	125		01.77	12.77					
	2.0 Turbo	125		01.80	12.80					
	2.0 Turbo	130		01.81	12.84					
↓	↓									



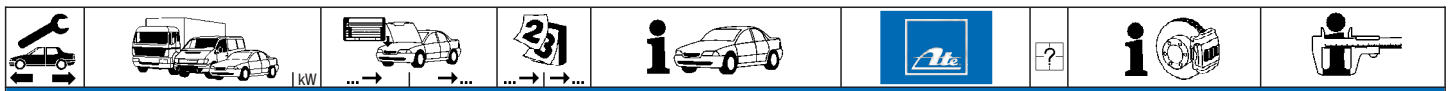

PORSCHE 924 (76-85)

	2.0 CARRERA GT 2.0 Turbo 2.0 Turbo 2.0 Turbo	154 125 125 130		06.80 01.77 01.80 01.81	12.81 12.77 12.80 12.84	13.0460-3612.2	603612		20482 18,5 /WE	ATE
	2.0 CARRERA GT 2.0 Turbo 2.0 Turbo 2.0 Turbo	154 125 125 130		06.80 01.77 01.80 01.81	12.81 12.77 12.80 12.84	24.0120-0112.1	420112		289 19,9 18,7 V L +B	
	2.0 2.0 2.0 2.0 CARRERA GT 2.0 Turbo 2.0 Turbo 2.0 Turbo	74 85 92 154 125 125 130		01.77 01.77 01.76 06.80 01.79 01.80 01.81	12.77 12.79 12.85 12.81 12.79 12.80 12.84	83.6201-0175.3	330663	2	L=175	
	2.0 2.0 2.0	74 85 92		01.77 01.77 01.76	12.77 12.79 12.85	24.3219-0906.3	020187		Rz 19,05	
	2.0 2.0 2.0	74 85 92		01.77 01.77 01.76	12.77 12.79 12.85	03.0137-0041.2 03.0137-9005.2	650041 669005		230 x 40 Bremsbacken-Zubehör	ATE
	2.0 2.0 2.0	74 85 92		01.77 01.77 01.76	12.77 12.79 12.85	24.0223-0004.1	480034		230/231 x 50,2	
	2.0 2.0 2.0 2.0 Turbo	74 85 92 125		01.77 01.77 01.76 01.80	12.77 12.79 12.80 12.80	24.3727-0902.2	580902	<input type="checkbox"/>	L=2034	
	2.0 2.0 2.0 2.0 CARRERA GT 2.0 Turbo 2.0 Turbo 2.0 Turbo	74 85 92 154 125 125 130		01.77 01.77 01.76 06.80 01.79 01.80 01.81	12.77 12.79 12.85 12.81 12.79 12.80 12.84	24.2419-0926.3	030054		Gz 19,05	

PORSCHE 924S (86-88)













	2.5 S 2.5 S	110 118		09.85 08.87	07.87 12.88	03.7750-5702.4	300083		9"	ATE
	2.5 S 2.5 S	110 118		09.85 08.87	07.87 12.88	03.2023-0172.3	010016		Thz 23,81/19,05	ATE
	2.5 S 2.5 S	110 118		09.85 08.87	07.87 12.88	11.0441-5401.2	250027		Dichtungssatz	ATE
	2.5 S 2.5 S	110 118		09.85 08.87	07.87 12.88	24.0120-0103.1	420103		283 20,5 19,1 V L	
	2.5 S 2.5 S	110 118		09.85 08.87	07.87 12.88	83.6101-0412.3	330212	2	L=410	
	2.5 S 2.5 S	110 118		09.85 08.87	07.87 12.88	11.0441-3601.2	250007		Dichtungssatz	ATE
	2.5 S 2.5 S	110 118		09.85 08.87	07.87 12.88	13.0460-3612.2	603612		20482 18,5 /WE	ATE
	2.5 S 2.5 S	110 118		09.85 08.87	07.87 12.88	24.0120-0112.1	420112		289 19,9 18,7 V L +B	
	2.5 S 2.5 S	110 118		09.85 08.87	07.87 12.88	83.6201-0175.3	330663	2	L=175	
	2.5 S 2.5 S	110 118		09.85 08.87	07.87 12.88	03.0137-3002.2	653002		180 x 25	
	2.5 S 2.5 S	110 118		09.85 08.87	07.87 12.88	24.2419-0926.3	030054		Gz 19,05	
	2.5 S 2.5 S	110 118		09.85 08.87	07.87 12.88	24.2523-0903.3	040045		Nz 23,81	

PORSCHE 928 (77-95)





	4.5 4.7 S 4.7 S 4.7 S 5.0 GT 5.0 S4 5.4 GTS	177 212 221 228 243 235 257	92A0800750		08.82 09.85 09.79 08.83 01.89 08.86 08.91	12.86 12.83 12.86 07.91 07.91 11.95	03.7760-0402.4	300087		10"	ATE



PORSCHE 928 (77-95)

	4.5 4.7 S 4.7 S 4.7 S 4.7 S 5.0 GT 5.0 S4 5.4 GTS	177 221 228 212 228 243 235 257		09.77 09.79 08.83 09.85 08.83 01.89 08.86 08.91	08.82 12.83 12.86 12.86 12.86 07.91 07.91 11.95		03.2123-9002.3 24.3526-1900.0 03.2023-0183.3 03.2023-0262.3	010198 340038 010017 010020	2		THz 23,81 + WE Bremslichtschalter THz 23,81/19,05 THz 23,81/20,64	ATE ATE ATE
	4.5 4.5 4.7 S 4.7 S	177 177 221 228	92A0800749 92A0800750	09.77 09.79 08.83	08.82 12.83 12.85		11.0441-5401.2 11.0441-5402.2 11.0101-5407.2 11.8171-0008.1	250027 250028 260011 990049			Dichtungssatz Dichtungssatz Hülzensatz Führungsbolzen	ATE ATE ATE
	4.7 S 4.7 S 5.0 GT 5.0 S4 5.4 GTS	212 228 243 235 257		09.85 01.86 01.89 08.86 08.91	12.86 12.86 07.91 07.91 11.95		24.8190-0909.2 24.8190-0915.2	620909 620915	2 2		Warnkontakt L=207mm Warnkontakt L=333mm	BRE
	4.5 4.7 S 4.7 S 4.7 S 4.7 S 5.0 GT 5.0 S4	177 221 228 212 228 243 235	92A0800750	09.77 09.79 08.83 09.85 01.86 01.89 08.86	08.82 12.83 12.85 12.86 12.86 07.91 07.91		24.0132-0127.1 24.0132-0128.1 24.0132-0151.1 24.0132-0150.1	432127 432128 432151 432150	<input type="checkbox"/> <input type="checkbox"/> <input type="checkbox"/> <input type="checkbox"/>		282 32,0 30,6 V L 282 32,0 30,6 V L 304 32,0 30,0 V L +B 304 32,0 30,0 V L +B	
	4.5 4.7 S 4.7 S 5.0 GT 5.0 S4 5.4 GTS	177 212 228 243 235 257	92A0800749	09.77 09.85 01.86 01.89 08.86 08.91	08.82 12.86 12.86 07.91 07.91 11.95		83.6121-0340.3 83.6289-0391.3	330261 330341	2 2		L=340 L=390	
	4.5 4.7 S 4.7 S	177 221 228		09.77 09.79 08.83	08.82 12.83 12.85		11.0441-3601.2	250007			Dichtungssatz	ATE
	4.5 4.7 S 4.7 S 4.7 S 4.7 S 5.0 GT 5.0 S4 5.4 GTS	177 221 228 212 228 243 235 257		09.77 09.79 08.83 09.85 01.86 01.89 08.86 08.91	08.82 12.83 12.85 12.86 12.86 07.91 07.91 11.95		13.0460-3612.2 24.8190-0903.2 13.0460-3612.2	603612 620903 603612	2		20482 18,5 /WE Warnkontakt L=1005mm 20482 18,5 /WE	ATE ATE
	4.7 S 4.7 S 5.0 GT 5.0 S4 5.4 GTS	212 228 243 235 257		09.85 01.86 01.89 08.86 08.91	12.86 12.86 07.91 07.91 11.95		24.8190-0910.2 24.8190-0919.2	620910 620919	2 2		Warnkontakt L=515mm Warnkontakt L=638mm	
	4.5 4.7 S 4.7 S 4.7 S 4.7 S 5.0 GT 5.0 S4 5.4 GTS	177 221 228 212 228 243 235 257		09.77 09.79 08.83 09.85 01.86 01.89 08.86 08.91	08.82 12.83 12.85 12.86 12.86 07.91 07.91 11.95		24.0120-0112.1 24.0124-0116.1	420112 424116			289 19,9 18,7 V L +B 299 24,0 22,0 V L	
	4.5 4.5 4.7 S 4.7 S 4.7 S 5.0 GT 5.0 S4 5.4 GTS	177 177 212 221 228 243 235 257	9289101485 9289101486	09.77 09.85 09.79 08.83 01.89 08.86 08.91	08.82 12.86 12.83 12.86 07.91 07.91 11.95		83.6101-0250.3 83.6121-0250.3	330203 330260	2 2		L=250 L=250	
	4.5 4.7 S 4.7 S 4.7 S 5.0 GT 5.0 S4 5.4 GTS	177 212 221 228 243 235 257		09.77 09.85 09.79 08.83 01.89 08.86 08.91	08.82 12.86 12.83 12.86 07.91 07.91 11.95		03.0137-3002.2	653002			180 x 25	
	5.0 GT 5.0 S4 5.4 GTS	243 235 257		01.89 08.86 08.91	07.91 07.91 11.95		24.2522-0908.3	040044			Nz 22,20	

PORSCHE 944 (81-91)

	944 944 S 944 Turbo			10.81 01.87 04.85	12.89 08.91 08.91		03.7750-5702.4	300083			9"	ATE
	944 944 Turbo			10.81 04.85	12.86 12.86	- ABS - ABS	03.2023-0172.3	010016			THz 23,81/19,05	ATE
	944 944 S 944 Turbo			01.87 01.87 01.87	12.89 08.91 08.91	- ABS - ABS - ABS	03.2023-0562.3	010025			THz 23,81/20,64	ATE
	944 944 S 944 Turbo			01.85 01.85 04.85	12.89 08.91 08.91	+ ABS + ABS + ABS	03.2023-0542.3 03.3517-0101.2	010024 390322			THz 23,81/20,64 Verschlußschraube	ATE





























PORSCHE 944 (81-91)											
	944 944 S			10.81 01.87	12.89 12.88		11.0441-5401.2	250027		Dichtungssatz	ATE
	944 944 S			10.81 01.87	12.89 12.88		24.8190-0904.2	620904	2	Warnkontakt L=275mm	
	944 S2 944 Turbo			01.89 04.85	08.91 07.88		24.8190-0904.2 24.8190-0916.2	620904 620916	2 2	Warnkontakt L=275mm Warnkontakt L=395mm	
	944 Turbo			08.88	08.91		24.8190-0916.2	620916	2	Warnkontakt L=395mm	
	944			10.81	12.86		24.0120-0103.1	420103		283 20,5 19,1 V L	
	944 944 S			01.87 01.87	12.89 12.88		24.0121-0112.1	421112		282 20,5 19,0 V L +B	
	944 Turbo			04.85	12.86		24.0128-0165.1	428165		298 28,0 26,0 V L	
	944 S2 944 Turbo			01.89 01.87	12.91 12.88	- Sportfahrwerk ¹⁾	24.0128-0167.1	428167		298 28,0 26,0 V L +B	
	944 S2 944 Turbo			01.89 01.89	12.91 12.91	+ Sportfahrwerk ²⁾	24.0132-0151.1 24.0132-0150.1	432151 432150	 	304 32,0 30,0 V L +B 304 32,0 30,0 V L +B	
	944			10.81	12.86		83.6101-0412.3	330212	2	L=410	
	944 944 S			01.87 01.87	12.89 08.91		24.5165-0415.3	331320	2	L=415	
	944 Turbo			01.87	08.91		83.6251-0301.3	330556	2	L=300	
	944 944 S 944 Turbo			10.81 01.87 04.85	12.89 08.91 08.91		11.0441-3601.2	250007		Dichtungssatz	ATE
	944 944 S			10.81 01.87	12.89 12.88		13.0460-3612.2 24.8190-0905.2 24.8190-0913.2	603612 620905 620913	 2 2	20482 18,5 /WE Warnkontakt L=357mm Warnkontakt L=308mm	ATE
	944 S 944 Turbo			01.89 04.85	08.91 08.91		24.8190-0916.2	620916	2	Warnkontakt L=395mm	
	944			10.81	12.86		24.0120-0112.1	420112		289 19,9 18,7 V L +B	
	944 944 S			01.87 01.87	12.89 12.88		24.0120-0104.1	420104		289 20,0 18,6 V L	
	944 Turbo			04.85	12.86		24.0124-0116.1	424116		299 24,0 22,0 V L	
	944 S 944 Turbo			01.89 01.87	08.91 08.91		24.0124-0117.1	424117		299 24,0 22,0 V L	
	944			10.81	07.84		83.6201-0175.3	330663	2	L=175	
	944 944 S 944 Turbo	◀ ◀ ◀		10.81 01.87 01.85	12.89 12.89 12.89		24.2419-0926.3	030054		Gz 19,05	
	944 944 S 944 Turbo			01.85 01.87 08.85	12.89 08.91 08.91		24.2523-0903.3	040045		Nz 23,81	
PORSCHE 968 COUPE (91-95)											
	3.0 3.0 S TURBO	176 224		06.91 03.93	11.95 11.95		03.7750-5702.4	300083		9"	ATE
	3.0 3.0 S TURBO	176 224		06.91 03.93	11.95 11.95		03.2023-0542.3 03.3517-0101.2	010024 390322		Thz 23,81/20,64 Verschlusschraube	ATE
	3.0 3.0 S TURBO	176 224		06.91 03.93	11.95 11.95	- Sportfahrwerk ¹⁾ - Sportfahrwerk ¹⁾	24.8190-0916.2	620916	2	Warnkontakt L=395mm	
	3.0 3.0 S TURBO	176 224		06.91 03.93	11.95 11.95	+ Sportfahrwerk ²⁾ + Sportfahrwerk ²⁾	24.8190-0916.2	620916	2	Warnkontakt L=395mm	
	3.0 3.0 S TURBO	176 224		06.91 03.93	11.95 11.95	- Sportfahrwerk ¹⁾ - Sportfahrwerk ¹⁾	24.0128-0167.1	428167		298 28,0 26,0 V L +B	
	3.0 3.0 S TURBO	176 224		06.91 03.93	11.95 11.95	- Sportfahrwerk ¹⁾ - Sportfahrwerk ¹⁾	24.5165-0415.3	331320	2	L=415	
	3.0 3.0 S TURBO	176 224		06.91 03.93	11.95 11.95	+ Sportfahrwerk ²⁾ + Sportfahrwerk ²⁾	83.6251-0301.3	330556	2	L=300	
	3.0 3.0 S TURBO	176 224		06.91 03.93	11.95 11.95		24.8190-0916.2	620916	2	Warnkontakt L=395mm	
	3.0 3.0 S TURBO	176 224		06.91 03.93	11.95 11.95	- Sportfahrwerk ¹⁾ - Sportfahrwerk ¹⁾	24.0124-0117.1	424117		299 24,0 22,0 V L	
	3.0 3.0 S TURBO	176 224		06.91 03.93	11.95 11.95		83.6201-0175.3	330663	2	L=175	
	3.0 3.0 S TURBO	176 224		06.91 03.93	11.95 11.95		03.0137-3002.2	653002		180 x 25	
PORSCHE 968 CABRIO (91-95)											
	3.0	176		06.91	11.95		03.7750-5702.4	300083		9"	ATE

¹⁾ - sports suspension / - sospensione sportiva / - châssis de sport / - suspensión deportiva

²⁾ + sports suspension / + sospensione sportiva / + châssis de sport / + suspensión deportiva

										
PORSCHE 968 CABRIO (91-95)										
	3.0	176		06.91	11.95	03.2023-0542.3 03.3517-0101.2	010024 390322	THz 23,81/20,64 Verschlußschraube	ATE	
	3.0	176		06.91	11.95	24.8190-0916.2	620916	2	Warnkontakt L=395mm	
	3.0	176		06.91	11.95	24.8190-0916.2	620916	2	Warnkontakt L=395mm	
	3.0	176		06.91	11.95	24.0128-0167.1	428167		298 28,0 26,0 V L +B	
	3.0	176		06.91	11.95	24.5165-0415.3	331320	2	L=415	
	3.0	176		06.91	11.95	83.6251-0301.3	330556	2	L=300	
	3.0	176		06.91	11.95	24.8190-0916.2	620916	2	Warnkontakt L=395mm	
	3.0	176		06.91	11.95	24.0124-0117.1	424117		299 24,0 22,0 V L	
	3.0	176		06.91	11.95	83.6201-0175.3	330663	2	L=175	
RENAULT ALPINE A310 (77-84)										
	2.7 (2700VA)		0047708	01.77	- ☉	13.0460-3928.2	603928		20140 14,0 +/WE	BDX
	2.7 (2700VA)		0047708	01.77		13.0460-3961.2	603961		20336 14,0 +/WK	BDX
	2.7 (2700VA)			01.77	12.84	24.2528-0908.3	040065		Nz 28,57	
RENAULT ESPACE I (J/S 11_) (84-90)										
	2.0 (J/S112)	74		01.88	12.90	03.2120-2031.3	010106		THz 20,64	ATE
	2.0 (J/S112)	80	T022234		12.90					
	2.0 (J/S112)	80	T000349		12.90					
	2.0 i (J116)	87		01.89	12.90					
	2.0 i Quadra (J116)	87		03.88	12.90					
	2.1 TD (J/S115)	65	T012278		12.90					
	2.1 TD (J/S115)	65	T000494		12.90					
	2.2 (J117)	79		07.86	12.90					
	2.2 Quadra	81		06.87	12.87					
	2.2 Quadra (J117)	79		01.88	12.90					
	2.0 (J/S112)	74		01.88	12.90	24.3541-1625.5	240045	<input type="checkbox"/>	D=54, - Halter	TRW
	2.0 (J/S112)	80		07.84	12.90	24.3541-1626.5	240046	<input type="checkbox"/>	D=54, - Halter	TRW
	2.0 i (J116)	87		01.89	12.90					
	2.0 i Quadra (J116)	87		03.88	12.92					
	2.1 TD (J/S115)	65		10.84	12.90					
	2.2 (J117)	79		07.86	12.90					
	2.2 Quadra	81		06.87	12.87					
	2.2 Quadra (J117)	79		01.88	12.90					
	2.0 (J/S112)	74		01.88	12.90	13.0460-3911.2	603911		20905 18,0 +/WK	BDX
	2.0 (J/S112)	80		07.84	12.90	13.0460-2834.2	602834		21463 18,0 /WK/S	TRW
	2.0 i (J116)	87		01.89	12.90	13.0460-0411.2	610411		Belagsatz-Zubehör	BDX
	2.0 i Quadra (J116)	87		03.88	12.92					
	2.1 TD (J/S115)	65		10.84	12.90					
	2.2 (J117)	79		07.86	12.90					
	2.2 Quadra	81		06.87	12.87					
	2.2 Quadra (J117)	79		01.88	12.90					
	2.0 (J/S112)	74		01.88	12.90	24.0120-0126.1	420126		259 20,2 17,7 V +B	
	2.0 (J/S112)	80	T022234		12.90					
	2.0 (J/S112)	80	T000349		12.90					
	2.0 i (J116)	87		01.89	12.90					
	2.0 i Quadra (J116)	87		03.88	12.92					
	2.1 TD (J/S115)	65	T012278		12.90					
	2.1 TD (J/S115)	65	T000494		12.90					
	2.2 (J117)	79		07.86	12.90					
	2.2 Quadra	81		06.87	12.87					
	2.2 Quadra (J117)	79		01.88	12.90					
	2.0 (J/S112)	74		01.88	12.90	24.5112-0385.3	330392	2	L=385	
	2.0 (J/S112)	80		07.84	12.90					
	2.0 i (J116)	87		01.89	12.90					
	2.0 i Quadra (J116)	87		03.88	12.92					
	2.1 TD (J/S115)	65		10.84	12.90					
	2.2 (J117)	79		07.86	12.90					
	2.2 Quadra	81		06.87	12.87					
	2.2 Quadra (J117)	79		01.88	12.90					
	2.0 i (J116)	87		01.89	12.90	13.0460-3961.2	603961		20336 14,0 +/WK	BDX
	2.0 i Quadra (J116)	87		03.88	12.92					
	2.1 TD (J/S115)	65		10.84	12.90					
	2.2 (J117)	79		07.86	12.90					
	2.2 Quadra	81		06.87	12.87					
	2.2 Quadra (J117)	79		01.88	12.90					

1) - sports suspension / - sospensione sportiva / - ch ssis de sport / - suspensi n deportiva

2) + sports suspension / + sospensione sportiva / + ch ssis de sport / + suspensi n deportiva

3) + suspension level control / + correttore assetto / + correcteur d'assiette / + regulaci n altura suspensi n

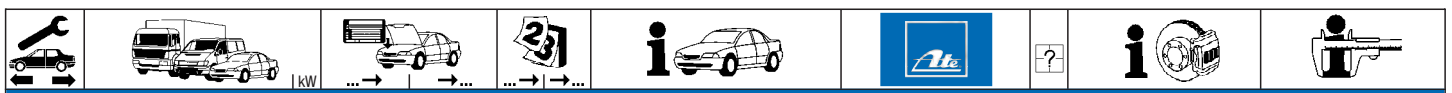

RENAULT ESPACE I (J/S 11_) (84-90)

	2.0 i (J116)	87		01.89	12.90	+ ABS	24.0112-0134.1	412134			254 12,0 10,5
	2.1 TD (J/S115)	65		10.84	12.90	+ Niveauregulierung ¹⁾					
	2.2 (J117)	79		07.86	12.90	+ ABS					
	2.0 i Quadra (J116)	87		03.88	12.92		24.0111-0122.1	411122			255 10,5 9,5
	2.2 Quadra	81		06.87	12.87						
	2.2 Quadra (J117)	79		01.88	12.90						
	2.0 (J/S112)	74		01.88	12.90	- ABS/ - Niveauregulierung ²⁾	24.5228-0350.3	330396	2		L=350
	2.0 (J/S112)	80		07.84	12.90	- ABS/ - Niveauregulierung ²⁾					
	2.0 i (J116)	87		01.89	12.90	- ABS/ - Niveauregulierung ²⁾					
	2.1 TD (J/S115)	65		10.84	12.90	- ABS/ - Niveauregulierung ²⁾					
	2.2 (J117)	79		07.86	12.90	- ABS/ - Niveauregulierung ²⁾					
	2.0 (J/S112)	74		01.88	12.90	+ ABS/ + Niveauregulierung ³⁾	24.5112-0220.3	330613	2		L=220
	2.0 (J/S112)	80		07.84	12.90	+ ABS/ + Niveauregulierung ³⁾					
	2.0 i (J116)	87		01.89	12.90	+ ABS/ + Niveauregulierung ³⁾					
	2.1 TD (J/S115)	65		10.84	12.90	+ ABS/ + Niveauregulierung ³⁾					
	2.2 (J117)	79		07.86	12.90	+ ABS/ + Niveauregulierung ³⁾					
	2.0 (J/S112)	74		01.88	12.90		24.3222-1118.3	020315			Rz 22,20
	2.0 (J/S112)	80		07.84	12.90						BDX
	2.0 i (J116)	87		01.89	12.90	- ABS					
	2.1 TD (J/S115)	65		10.84	12.90	- Niveauregulierung ⁴⁾					
	2.2 (J117)	79		07.86	12.90	- ABS					
	2.0 (J/S112)	74		01.88	12.90		03.0137-0124.2	650124			229 x 42 HEB AUT
	2.0 (J/S112)	80		07.84	12.90		03.0137-9020.2	669020			BDX
	2.0 i (J116)	87		01.89	12.90	- ABS					
	2.1 TD (J/S115)	65		10.84	12.90	- Niveauregulierung ⁴⁾					
	2.2 (J117)	79		07.86	12.90	- ABS					
	2.0 (J/S112)	74		01.88	12.90		24.0222-8015.1	480055			229/229,5 x 52,5
	2.0 (J/S112)	80		07.84	12.90		24.0222-8019.2	480087			229/229,5 x 52,5
	2.0 i (J116)	87		01.89	12.90	- ABS					
	2.1 TD (J/S115)	65		10.84	12.90	- Niveauregulierung ⁴⁾					
	2.2 (J117)	79		07.86	12.90	- ABS					
	2.0 (J/S112)	74		01.88	12.90		03.0520-3122.3	693122			22,20/229x42 TopKit
	2.0 (J/S112)	80		07.84	12.90						BDX
	2.0 i (J116)	87		01.89	12.90	- ABS					
	2.1 TD (J/S115)	65		10.84	12.90	- Niveauregulierung ⁴⁾					
	2.2 (J117)	79		07.86	12.90	- ABS					
	2.0 (J/S112)	74		01.88	12.90		24.3727-1031.2	581031	1		L=1984/1045
	2.0 (J/S112)	80	T005830	07.84	12.90	-					
	2.0 (J/S112)	80		01.89	12.90	+					
	2.0 i (J116)	87		01.89	12.90	- Niveauregulierung ⁴⁾					
	2.1 TD (J/S115)	65		10.84	12.90	- Niveauregulierung ⁴⁾					
	2.2 (J117)	79		07.86	12.90	- Niveauregulierung ⁴⁾					
	2.0 (J/S112)	74	T041871	01.88			03.6583-0005.3	320099			BRL 8/3 (4)
	2.0 (J/S112)	74	K001772	01.88							ATE
	2.0 (J/S112)	80	T041871	07.84							
	2.0 (J/S112)	80	T000771	01.86							
	2.0 (J/S112)	80	K001772	07.84							
	2.0 i (J116)	87	T004699	01.89		- Niveauregulierung ⁴⁾					
	2.0 i (J116)	87	K001363	01.89		- Niveauregulierung ⁴⁾					
	2.1 TD (J/S115)	65	T031062	10.84		- Niveauregulierung ⁴⁾					
	2.1 TD (J/S115)	65	T001266	01.86							
	2.2 (J117)	79	T009177	07.86		- Niveauregulierung ⁴⁾					

RENAULT ESPACE II (J/S 63_) (91-96)

	2.0 (J/- 636)	76		01.91	10.96		03.6750-2902.4	300037			9"
	2.1 RTDT Quadra	65		01.91	05.92						ATE
	2.1 TD (J633-635,63D)	65		01.91	10.96						
	2.1 TD (J63E)	66		11.94	10.96						
	2.2 (J/S637,J63G)	79		01.91	10.96						
	2.2 4x4 (J/S637,J63G)	79		03.91	12.96						
	2.0 (J/- 636)	76		01.91	10.96	- ABS/ - Niveauregulierung ²⁾	03.2120-2682.3	010118			Thz 20,64
	2.1 RTDT Quadra	65		01.91	05.92	- Niveauregulierung ⁴⁾					ATE
	2.1 TD (J633-635,63D)	65		01.91	10.96	- Niveauregulierung ⁴⁾					
	2.2 (J/S637,J63G)	79		01.91	10.96	- ABS/ - Niveauregulierung ²⁾					
	2.2 4x4 (J/S637,J63G)	79		03.91	12.96	- ABS/ - Niveauregulierung ²⁾					
	2.0 (J/- 636)	76		01.91	10.96	- ABS	03.2122-9631.3	010160			Thz 22,20
	2.1 RTDT Quadra	65		01.91	05.92	- ABS					ATE
	2.1 TD (J633-635,63D)	65		01.91	10.96	- ABS					
	2.1 TD (J63E)	66		11.94	10.96	- ABS					
	2.2 (J/S637,J63G)	79		01.91	10.96	- ABS					
	2.2 4x4 (J/S637,J63G)	79		03.91	12.96	- ABS					
	2.0 (J/- 636)	76		07.93	10.96	+ ABS	03.2122-0626.3	010539			Thz 22,20
	2.1 TD (J633-635,63D)	65		07.93	10.96	+ ABS					ATE
	2.1 TD (J63E)	66		11.94	10.96	+ ABS					
	2.2 (J/S637,J63G)	79		07.93	10.96	+ ABS					
	2.2 4x4 (J/S637,J63G)	79		07.93	12.96	+ ABS					
	2.8 V6 (J638,J63J)	110		01.91	10.96		24.2123-1701.3	010424			Thz 23,81
	2.0 (J/- 636)	76		01.91	10.96		24.3541-1625.5	240045			D=54, - Halter
	2.1 RTDT Quadra	65		01.91	05.92		24.3541-1626.5	240046			D=54, - Halter
	2.1 TD (J633-635,63D)	65		01.91	10.96						TRW
	2.1 TD (J63E)	66		11.94	10.96						
	2.2 (J/S637,J63G)	79		01.91	10.96						
	2.2 4x4 (J/S637,J63G)	79		03.91	12.96						

1) + suspension level control / + correttore assetto / + correcteur d'assiette / + regulación altura suspensión
 2) - ABS/ - suspens.level control / - ABS/ - correttore assetto / - ABS/ - correcteur d'assiette / - ABS/ - regul.alt.suspensión
 3) + ABS/ + suspens.level control / + ABS/ + correttore d'assetto / + ABS/ + correcteur d'assiette / + ABS/ + regul.alt.suspensión
 4) - suspension level control / - correttore assetto / - correcteur d'assiette / - regulación altura suspensión

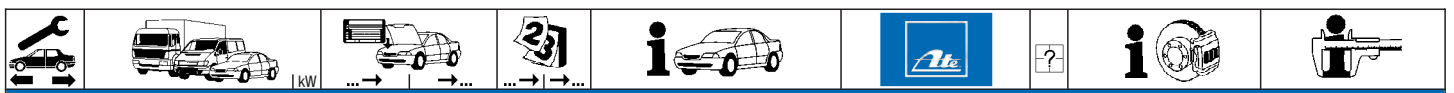

RENAULT ESPACE II (J/S 63_) (91-96)

	2.0 (J/- 636) 2.1 RTDT Quadra 2.1 TD (J633-635,63D) 2.1 TD (J63E) 2.2 (J/S637,J63G) 2.2 4x4 (J/S637,J63G) 2.8 V6 (J638,J63J)	76 65 65 66 79 79 110		01.91 01.91 01.91 11.94 01.91 03.91	10.96 05.92 10.96 10.96 10.96 12.96	13.0460-2810.2 602810			20236 18,0 +/WK/S	TRW
	2.0 (J/- 636) 2.1 RTDT Quadra 2.1 TD (J633-635,63D) 2.1 TD (J63E) 2.2 (J/S637,J63G) 2.2 4x4 (J/S637,J63G) 2.8 V6 (J638,J63J)	76 65 65 66 79 79 110		01.91 01.91 01.91 11.94 01.91 03.91	10.96 05.92 10.96 10.96 10.96 12.96	13.0460-2983.2 602983			21388 18,0 +/WK/S	TRW
	2.0 (J/- 636) 2.1 RTDT Quadra 2.1 TD (J633-635,63D) 2.1 TD (J63E) 2.2 (J/S637,J63G) 2.2 4x4 (J/S637,J63G)	76 65 65 66 79 79		01.91 01.91 01.91 11.94 01.91 03.91	10.96 05.92 10.96 10.96 10.96 12.96	24.5111-0396.3 330609	2		L=395	
	2.0 (J/- 636) 2.1 RTDT Quadra 2.1 TD (J633-635,63D) 2.1 TD (J63E) 2.2 (J/S637,J63G) 2.2 4x4 (J/S637,J63G) 2.8 V6 (J638,J63J)	76 65 65 66 79 79 110		01.91 01.91 01.91 11.94 05.93 05.93 01.91	10.96 + ABS/ + Niveauregulierung ¹⁾ 05.92 + Niveauregulierung ²⁾ 10.96 + Niveauregulierung ²⁾ 10.96 + Niveauregulierung ²⁾ 10.96 + ABS/ + Niveauregulierung ¹⁾ 12.96 + ABS/ + Niveauregulierung ¹⁾ 12.96	13.0460-3961.2 603961			20336 14,0 +/WK	BDX
	2.0 (J/- 636) 2.1 RTDT Quadra 2.1 TD (J633-635,63D) 2.1 TD (J63E) 2.2 (J/S637,J63G) 2.2 4x4 (J/S637,J63G) 2.8 V6 (J638,J63J)	76 65 65 66 79 79 110		01.91 01.91 01.91 11.94 01.91 05.93 01.91	10.96 + ABS/ + Niveauregulierung ¹⁾ 05.92 + Niveauregulierung ²⁾ 10.96 + Niveauregulierung ²⁾ 10.96 + Niveauregulierung ²⁾ 10.96 + ABS/ + Niveauregulierung ¹⁾ 12.96 + ABS/ + Niveauregulierung ¹⁾ 10.96	24.0112-0134.1 412134			254 12,0 10,5	
	2.0 (J/- 636) 2.1 RTDT Quadra 2.1 TD (J633-635,63D) 2.1 TD (J63E) 2.2 (J/S637,J63G) 2.2 4x4 (J/S637,J63G) 2.8 V6 (J638,J63J)	76 65 65 66 79 79 110		01.91 01.91 01.91 11.94 05.93 05.93 01.91	10.96 05.92 10.96 10.96 10.96 12.96 10.96	24.5112-0220.3 330613 24.5228-0350.3 330396	2 2	Länge beachten ³⁾ Länge beachten ³⁾	L=220 L=350	
	2.0 (J/- 636) 2.1 RTDT Quadra 2.1 TD (J633-635,63D) 2.1 TD (J63E) 2.2 (J/S637,J63G) 2.2 4x4 (J/S637,J63G)	76 65 65 66 79 79		01.91 01.91 01.91 11.94 01.91 03.91	10.96 - ABS/ - Niveauregulierung ⁴⁾ 05.92 - Niveauregulierung ⁵⁾ 10.96 - Niveauregulierung ⁵⁾ 10.96 - Niveauregulierung ⁵⁾ 10.96 - ABS/ - Niveauregulierung ⁴⁾ 12.96 - ABS/ - Niveauregulierung ⁴⁾	24.3222-1118.3 020315			Rz 22,20	BDX
	2.0 (J/- 636) 2.1 RTDT Quadra 2.1 TD (J633-635,63D) 2.1 TD (J63E) 2.2 (J/S637,J63G) 2.2 4x4 (J/S637,J63G)	76 65 65 66 79 79		01.91 01.91 01.91 11.94 01.91 03.91	10.96 - ABS/ - Niveauregulierung ⁴⁾ 05.92 - Niveauregulierung ⁵⁾ 10.96 - Niveauregulierung ⁵⁾ 10.96 - Niveauregulierung ⁵⁾ 10.96 - ABS/ - Niveauregulierung ⁴⁾ 12.96 - ABS/ - Niveauregulierung ⁴⁾	24.3222-1615.3 020285			Rz 22,20	TRW
	2.0 (J/- 636) 2.1 RTDT Quadra 2.1 TD (J633-635,63D) 2.1 TD (J63E) 2.2 (J/S637,J63G) 2.2 4x4 (J/S637,J63G)	76 65 65 66 79 79		01.91 01.91 01.91 11.94 01.91 03.91	10.96 - ABS/ - Niveauregulierung ⁴⁾ 05.92 - Niveauregulierung ⁵⁾ 10.96 - Niveauregulierung ⁵⁾ 10.96 - Niveauregulierung ⁵⁾ 10.96 - ABS/ - Niveauregulierung ⁴⁾ 12.96 - ABS/ - Niveauregulierung ⁴⁾	03.0137-0124.2 650124 03.0137-9020.2 669020			229 x 42 HEB AUT Bremsbacken-Zubehör	BDX BDX
	2.0 (J/- 636) 2.1 RTDT Quadra 2.1 TD (J633-635,63D) 2.1 TD (J63E) 2.2 (J/S637,J63G) 2.2 4x4 (J/S637,J63G)	76 65 65 66 79 79		01.91 01.91 01.91 11.94 01.91 03.91	10.96 - ABS/ - Niveauregulierung ⁴⁾ 05.92 - Niveauregulierung ⁵⁾ 10.96 - Niveauregulierung ⁵⁾ 10.96 - Niveauregulierung ⁵⁾ 10.96 - ABS/ - Niveauregulierung ⁴⁾ 12.96 - ABS/ - Niveauregulierung ⁴⁾	03.0137-0271.2 650271 03.0137-9027.2 669027			229 x 42 HEB Bremsbacken-Zubehör	TRW TRW
	2.0 (J/- 636) 2.1 RTDT Quadra 2.1 TD (J633-635,63D) 2.1 TD (J63E) 2.2 (J/S637,J63G) 2.2 4x4 (J/S637,J63G)	76 65 65 66 79 79		01.91 01.91 01.91 11.94 01.91 03.91	10.96 - ABS/ - Niveauregulierung ⁴⁾ 05.92 - Niveauregulierung ⁵⁾ 10.96 - Niveauregulierung ⁵⁾ 10.96 - Niveauregulierung ⁵⁾ 10.96 - ABS/ - Niveauregulierung ⁴⁾ 12.96 - ABS/ - Niveauregulierung ⁴⁾	24.0222-8015.1 480055 24.0222-8019.2 480087			229/229,5 x 52,5 229/229,5 x 52,5	
	2.0 (J/- 636) 2.1 TD (J633-635,63D)	76 65		01.91 01.91	11.92 - ABS/ - Niveauregulierung ⁴⁾ 11.92 - Niveauregulierung ⁵⁾	03.0520-3122.3 693122			22,20/229x42 TopKit	BDX
	2.0 (J/- 636) 2.1 TD (J633-635,63D) 2.1 TD (J63E) 2.2 (J/S637,J63G) 2.2 4x4 (J/S637,J63G)	76 65 66 79 79		12.92 12.92 11.94 01.91 03.91	10.96 - ABS/ - Niveauregulierung ⁴⁾ 10.96 - Niveauregulierung ⁵⁾ 10.96 - Niveauregulierung ⁵⁾ 10.96 - ABS/ - Niveauregulierung ⁴⁾ 12.96 - ABS/ - Niveauregulierung ⁴⁾	03.0520-2422.3 692422			22,20/229x42 TopKit	TRW

¹⁾ + ABS/ + suspens.level control / + ABS/ + correttore d'assetto / + ABS/ + correcteur d'assiette / + ABS/ + regul.alt.suspension

²⁾ + suspension level control / + correttore assetto / + correcteur d'assiette / + regulacion altura suspension

³⁾ notice length / attenzione lunghezza / faire attention longueur / atencion largo

⁴⁾ - ABS/ - suspens.level control / - ABS/ - correttore assetto / - ABS/ - correcteur d'assiette / - ABS/ - regul.alt.suspension

⁵⁾ - suspension level control / - correttore assetto / - correcteur d'assiette / - regulacion altura suspension





RENAULT ESPACE II (J/S 63_) (91-96)										
	2.0 (J/- 636)	76		01.91	10.96	- ABS/ - Niveauregulierung ¹⁾	24.3727-1031.2	581031	1	L=1984/1045
	2.1 RTDT Quadra	65		01.91	05.92	- Niveauregulierung ²⁾				
	2.1 TD (J633-635,63D)	65		01.91	10.96	- Niveauregulierung ²⁾				
	2.1 TD (J63E)	66		11.94	10.96	- Niveauregulierung ²⁾				
	2.2 (J/S637,J63G)	79		01.91	10.96	- ABS/ - Niveauregulierung ¹⁾				
	2.2 4x4 (J/S637,J63G)	79		03.91	12.96	- ABS/ - Niveauregulierung ¹⁾				
	2.0 (J/- 636)	76		01.91	10.96	+ ABS/ + Niveauregulierung ³⁾	24.3727-1024.2	581024	1	
2.1 RTDT Quadra	65		01.91	05.92	+ Niveauregulierung ⁴⁾					
2.1 TD (J633-635,63D)	65		01.91	10.96	+ Niveauregulierung ⁴⁾					
2.1 TD (J63E)	66		11.94	10.96	+ Niveauregulierung ⁴⁾					
2.2 (J/S637,J63G)	79		01.91	10.96	+ ABS/ + Niveauregulierung ³⁾					
2.2 4x4 (J/S637,J63G)	79		03.91	12.96	+ ABS/ + Niveauregulierung ³⁾					
2.8 V6 (J638,J63J)	110		01.91	10.96						
	2.0 (J/- 636)	76		01.91	01.95		24.3728-1015.2	591015		L=1330, - AUT
	2.1 RTDT Quadra	65		01.91	05.92					
	2.1 TD (J633-635,63D)	65		01.91	01.95					
	2.1 TD (J63E)	66		11.94	01.95					
	2.2 (J/S637,J63G)	79		01.91	01.95					
	2.2 4x4 (J/S637,J63G)	79		03.91	01.95					
	2.0 (J/- 636)	76		02.95	10.96		24.3728-1026.2	591026		L=1318, + AUT
2.1 TD (J633-635,63D)	65		02.95	10.96						
2.1 TD (J63E)	66		02.95	10.96						
2.2 (J/S637,J63G)	79		02.95	10.96						
2.2 4x4 (J/S637,J63G)	79		02.95	12.96						
RENAULT ESTAFETTE (R_) (69-80)										
	1.3 (R2136)	29		01.69	12.80		24.3222-1125.3	020356		Rz 22,20
	1.3 (R2137)	29		01.69	12.80					
RENAULT FUEGO (80-92)										
	1.4 (R1360)			01.80	12.85	- (N)	03.2119-0781.3	010052		THz 19,05
	1.6 (R1361)			01.83	12.85	- (N)				ATE
	1.6 (R1362)			01.80	12.85		24.3541-1625.5	240045	<input type="checkbox"/>	D=54, - Halter
							24.3541-1626.5	240046	<input type="checkbox"/>	D=54, - Halter
	1.6 T (R1365)			01.84	12.85		24.3541-1625.5	240045	<input type="checkbox"/>	D=54, - Halter
	2.1 (R1366)			01.83	12.84		24.3541-1626.5	240046	<input type="checkbox"/>	D=54, - Halter
	1.4 (R1360)			01.80	12.85		13.0460-3911.2	603911		20905 18,0 +WK
	1.6 (R1361)			01.83	12.85		13.0460-2834.2	602834		21463 18,0 /WK/S
	1.6 (R1362)			01.80	12.85		13.0460-0411.2	610411		Belagsatz-Zubehör
	2.0 (R1363)			01.81	12.85		13.0460-3911.2	603911		20905 18,0 +WK
							13.0460-0411.2	610411		Belagsatz-Zubehör
	1.6 T (R1365)			01.84	12.85		13.0460-2834.2	602834		21463 18,0 /WK/S
	1.6 T (R1365)			01.84	12.85		24.0120-0126.1	420126		259 20,2 17,7 V +B
	2.1 (R1366)	0003901			12.84					
	1.6 T (R1365)			01.84	12.85		13.0460-3961.2	603961		20336 14,0 +WK
	2.1 (R1366)									
	1.6 T (R1365)			01.84	12.85		24.0112-0134.1	412134		254 12,0 10,5
	2.1 (R1366)									
	1.4 (R1360)			01.80	12.85		24.5112-0220.3	330613	2	L=220
	1.6 (R1361)			01.83	12.85					
	1.6 (R1362)			01.80	12.85					
	1.6 T (R1365)			01.84	12.85					
	2.0 (R1363)			01.82	12.85					
	2.1 (R1366)			01.83	12.84					
	1.4 (R1360)		0059000	01.80			24.3222-1710.3	020112	<input type="checkbox"/>	Rz 22,20
	1.6 (R1361)		0006100	01.83			24.3222-1709.3	020111	<input type="checkbox"/>	Rz 22,20
							24.3222-1107.3	020262	<input type="checkbox"/>	Rz 22,20
	1.4 (R1360)	0059001		12.85			24.3222-1710.3	020112	<input type="checkbox"/>	Rz 22,20
1.6 (R1361)	0006101		12.85			24.3222-1107.3	020262	<input type="checkbox"/>	Rz 22,20	
	1.6 (R1362)			01.80	12.85		24.3222-1118.3	020315		Rz 22,20
	2.0 (R1363)			01.81	12.85					
	2.1 (R1366)			01.83	12.84					
	1.6 (R1362)			01.80	12.85		03.0137-0124.2	650124		229 x 42 HEB AUT
	2.0 (R1363)			01.81	12.85		03.0137-9020.2	669020		Bremsbacken-Zubehör
	2.1 (R1366)			01.83	12.84					
	1.6 (R1362)			01.80	12.85		03.0520-3122.3	693122		22,20/229x42 TopKit
	2.0 (R1363)			01.81	12.85					
	2.1 (R1366)			01.83	12.84					
RENAULT R4 (62-90)										
	0.8 (R1123)		1357385	01.71		+ (OK)	24.3120-1702.3	010467		Hz 20,64
	0.8 (R1123)		1109666	01.71		+ (F)				
	0.8 (R1123)		1077042	01.71		+ (CH)				
	0.8 (R1123)		1006411	01.71		+ (N)				
	0.8 (R1123)		0765581	10.62						
	0.8 (R1123)	0765582			12.70	- (S)				
	0.8 (R1126)		0028263	01.72						
	0.8 (R2105)		0044278	01.65						

1) - ABS/ - suspens.level control / - ABS/ - correttore assetto / - ABS/ - correcteur d'assiette / - ABS/ - regul.alt.suspension
2) - suspension level control / - correttore assetto / - correcteur d'assiette / - regulacion altura suspension
3) + ABS/ + suspens.level control / + ABS/ + correttore d'assetto / + ABS/ + correcteur d'assiette / + ABS/ + regul.alt.suspension
4) + suspension level control / + correttore assetto / + correcteur d'assiette / + regulacion altura suspension

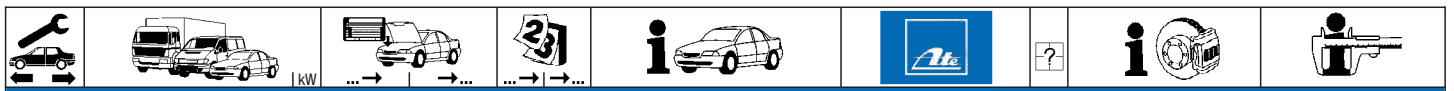

RENAULT R4 (62-90)

	0.8 (R2106) ▶ 0.8 (R2106) ▶		0025949 0021494	01.66 01.66		24.3120-1702.3	010467		Hz 20,64	
	0.8 (R1123) 0.8 (R1123) 0.8 (R1126) 0.8 (R1129) 0.8 (R2106) 0.8 (R2391) 0.8 (R2392) ◀ 0.8 (R2430) ◀ 1.1 (R2370) 1.1 (R2370) 1.1 (R2370)	1109667 0765582 0028264 0042589	1742851 1077042 0469894 0082242 0002129 0005564 0001119 0056080 0027449 0001660	01.76 12.78 01.74 01.74 01.76 01.76 01.76 01.76	+ F + S + F + S + D L FIN + F A + CH DK	24.3119-1702.3	010465		Hz 19,05	
	0.8 (R1123) 0.8 (R1126) 0.8 (R2106) 0.8 (R2109) 0.8 (R2391) 0.8 (R2392) 1.1 (R1128) ▶ 1.1 (R2370)	0223420 0002130 0005565	2159152 0736614 0279900 0372900 0006250 0011800 0121915 0027449	01.76 01.76 01.76 01.76 01.76 01.76 01.76 01.76	+ F S + F + CH DK N	24.2120-1503.3	010397		THz 20,64	BDX
	0.8 (R1123) ◀ 0.8 (R1123) ▶ 0.8 (R1126) 0.8 (R2106) ◀ 0.8 (R2106) ▶ 0.8 (R2109) ◀ 0.8 (R2391) 0.8 (R2391) 0.8 (R2392) 1.1 (R1128) 1.1 (R1128) ▶ 1.1 (R1128) 1.1 (R2370)	2159153 1951460 0736615 0279901 0239871 0372901 0006251 0011801 0033060 0121916 0033060 0086721	0212750 0212750 0168855	01.83 12.86 12.86 12.82 + F S 12.86 12.86 12.82 + F 12.86 12.82 + CH		24.2120-1715.3	010469		THz 20,64	
	1.0 (R112C) 1.1 (R1128) 1.1 (R1128) 1.1 (R210B) 1.1 (R2370) 1.1 (R2370) 1.1 (R239B) 1.1 (S 128)	0461101 0212751 0025501 0168856 0361751 0002181	0212750 0168855	01.87 06.90 06.90 - CH GB 06.88 12.86 + D 12.86 - CH 06.88 06.90		24.2119-1703.3	010323		THz 19,05	
	1.0 (R112C) 1.1 (R1128) 1.1 (R2370) 1.1 (S 128)			01.87 01.83 01.83 06.89	06.90 + D 12.86 06.90	13.0460-3928.2 13.0460-2967.2	603928 602967		20140 14,0 +/-WE 20480 15,5 /S	BDX TRW
	1.1 (R210B) 1.1 (R239B) 1.1 (R210B) 1.1 (R239B)			01.83 01.83 01.83 01.83	06.88 - D 06.88 - D 06.88 + D 06.88 + D	13.0460-3928.2 13.0460-2967.2	603928 602967		20140 14,0 +/-WE 20480 15,5 /S	BDX TRW
	1.0 (R112C) 1.1 (R1128) 1.1 (R210B) 1.1 (R2370) 1.1 (R239B) 1.1 (S 128)			01.87 01.83 01.83 01.83 01.83 06.89	06.90 + D 06.88 12.86 06.88 06.90	24.0110-0139.1	410139		228 10,0 9,0	
	1.0 (R112C) 1.1 (R1128) 1.1 (R210B) 1.1 (R2370) 1.1 (R239B) 1.1 (S 128)			01.87 01.83 01.83 01.83 01.83 06.89	06.90 + D 06.88 12.86 06.88 06.90	24.5115-0400.3	330413	2	L=400	
	0.8 (R1120) 0.8 (R1123) 0.8 (R1123) 0.8 (R1123) 0.8 (R1126) 0.8 (R1129) 0.8 (R2105) ◀ 0.8 (R2105) ▶ 0.8 (R2106) ◀ 0.8 (R2106) ▶ 0.8 (R2106) 0.8 (R2109) 0.8 (R2391) 0.8 (R2392) 0.8 (R2430) 1.1 (R1128) 1.1 (R1128) 1.1 (R2370)	0046235 0048235 0022627 0022289	0046244	01.67 10.62 01.76 01.76 01.76 01.76 12.75 12.75 12.75 01.76 01.72 01.74 01.74 01.76 01.78 01.83 01.76	12.71 + N S 12.86 12.82 + F 12.78 12.78 12.75 12.75 12.75 12.86 12.82 12.86 12.82 12.78 12.82 06.90 - D 12.86	24.3223-1101.3 24.3223-1102.3	020288 020289		Rz 23,81 Rz 23,81	BDX BDX
	0.8 (R1120) 0.8 (R1123) 0.8 (R1123) 0.8 (R1126) 0.8 (R2105) 0.8 (R2106)			01.67 01.67 01.83 01.72 01.65 01.66	12.71 12.80 12.86 12.82 + F 12.71 12.71	03.0137-9028.2	669028		Bremsbacken-Zubehör	BDX





RENAULT R4 (62-90)

	0.8 (R1123) 0.8 (R1126) 0.8 (R1129) 0.8 (R2105) 0.8 (R2106) 0.8 (R2109) 0.8 (R2391) 0.8 (R2392) 0.8 (R2430) 1.1 (R1128) 1.1 (R2370)			01.81 12.82 01.72 12.76 + S 01.76 12.78 01.72 12.75 01.72 12.86 01.76 12.82 + S 01.74 12.86 01.74 12.82 + F 01.76 12.78 01.78 06.90 - D 01.76 12.86		03.0137-9020.2 669020	+ autom. Nachstellung ¹⁾	Bremsbacken-Zubehör	BDX
	0.8 (R1120) 0.8 (R1123) 0.8 (R1123) 0.8 (R1123) 0.8 (R1126) 0.8 (R1126)	1226001	1229200 1112761 1077042	10.62 10.62 10.62 12.86 01.72 12.75 01.76 12.82 + F	+ CH + N S - CH N S	24.3219-1101.3 020189		Rz 19,05	BDX
	0.8 (R1120) 0.8 (R1123) 0.8 (R1126) 0.8 (R1129) 0.8 (R2105) 0.8 (R2106) 0.8 (R2106) 0.8 (R2109) 0.8 (R2391) 0.8 (R2392) 0.8 (R2430) 1.1 (R1128) 1.1 (R1128) 1.1 (R2370)	0621991 1077043 0007089 0002799 0002799	1226000 1379976 0137567 0002390 0056080	01.76 12.82 01.76 12.78 12.75 12.86 01.71 12.82 01.74 12.86 01.74 12.82 01.71 12.82 01.76 12.82 01.83 06.90 - D 01.76	+ S + S + DK N S - DK N S	24.3220-1101.3 020212		Rz 20,64	BDX
	0.8 (R1123) 0.8 (R2106) 0.8 (R2430) 1.1 (R2370)	1379977 0137568 0002391 0056081		12.86 + S 12.86 + DK N S 12.78 12.82		24.3222-1101.3 020256		Rz 22,20	BDX
	1.0 (R112C) 1.1 (R1128) 1.1 (R210B) 1.1 (R2370) 1.1 (R239B) 1.1 (S 128)			01.87 06.90 01.83 06.88 01.83 12.86 01.83 06.88 06.89 06.90	+ D	24.3222-1101.3 020256 24.3222-1103.3 020258		Rz 22,20 Rz 22,20	BDX TRW
	0.8 (R1120) 0.8 (R1123) 0.8 (R1129) 0.8 (R2106) 0.8 (R2430) 1.1 (R2370)		0000020 0001660	01.67 12.72 01.67 12.82 - DK N 01.76 12.78 01.66 12.82 01.76 12.82		03.0137-0082.2 650082 03.0137-9031.2 669031		180 x 32 Bremsbacken-Zubehör	BDX BDX
	0.8 (R1123) 0.8 (R1126) 0.8 (R2105) 0.8 (R2106) 0.8 (R2109) 0.8 (R2391) 0.8 (R2392)			01.83 12.86 01.76 12.82 + F 01.65 12.75 01.83 06.87 01.72 12.82 + F 01.74 12.86 01.74 12.82		03.0137-9039.2 669039		Bremsbacken-Zubehör	BDX
	0.8 (R1123) 0.8 (R1126) 0.8 (R2109) 0.8 (R2430) 1.0 (R112C) 1.1 (R1128) 1.1 (R210B) 1.1 (R239B) 1.1 (S 128)	0000021		01.76 12.82 + DK N 01.76 12.82 + S 01.72 12.82 + S 12.82 01.87 06.90 01.78 06.90 01.83 06.88 01.83 06.88 06.89 06.90		03.0137-9032.2 669032		Bremsbacken-Zubehör	BDX
	1.1 (R2370)	0001661		12.86		03.0137-9032.2 669032		Bremsbacken-Zubehör	BDX
	0.8 (R2430) 1.1 (R2370) 1.0 (R112C) 1.1 (R1128) 1.1 (R210B) 1.1 (R2370) 1.1 (R239B) 1.1 (S 128)	0002391 0056081		12.78 12.82 01.87 06.90 01.83 06.88 01.83 12.86 01.83 06.88 06.89 06.90		03.0520-0622.3 690622 03.0520-0622.3 690622		22,20/180x32 TopKit 22,20/180x32 TopKit	BDX BDX
	1.0 (R112C) 1.1 (R1128) 1.1 (R1128) 1.1 (R1128) 1.1 (R210B) 1.1 (R239B) 1.1 (S 128)	0414670 0390246 0015201 0000480		01.87 06.90 06.90 - F 06.90 + F 01.83 06.90 06.88 06.88 06.89 06.90		24.3727-1004.2 581004	2 ↓	L=1500	

RENAULT R5 SUPER (85-96)

	1.0 (B/C/S 400) 1.0 (B/C/S 400) 1.1 (B/C/- 40H) 1.1 (B/C/S 401)			01.85 08.90 06.87 08.90 01.85 03.95		24.2117-1503.3 010400 03.2119-3389.3 010057		THz 17,46 THz 19,05	BDX ATE
--	--	--	--	--	--	--	--	------------------------	--------------------------

¹⁾ + automatic adjustment / + correzione automatica / + ajustage automatique / + reajuste automático

RENAULT R5 SUPER (85-96)

	1.2 (B/C/S 40F) 1.4 (-/C/- 405) 1.4 (B/C/- 402) 1.4 (B/C/- 403) 1.4 (B/C/- 407) 1.4 (B/C/- 40J) 1.4 (B/C/- 40M) 1.6 (B/C/S 404) 1.7 (-/C/- 409) 1.7 (B/C/- 408) 1.7 (B/C/- 40G) 1.7 (B/C/- 40K)			01.86 08.90 01.85 08.90 01.85 08.90 01.85 08.90 01.85 12.96 06.87 08.90 06.87 08.90 01.85 12.96 01.87 08.91 01.87 03.95 06.87 03.95 06.87 03.95		03.2119-3389.3	010057		Thz 19,05	ATE	
	1.0 (B/C/S 400) 1.1 (B/C/- 40H) 1.1 (B/C/S 401)			01.85 08.90 06.87 08.90 01.85 03.95		24.3451-1501.5 24.3451-1502.5	240263 240264	<input type="checkbox"/> <input type="checkbox"/>	D=45, - Halter D=45, - Halter	BDX BDX	
	1.2 (-/-/S 40F) 1.2 (-/-/S 40F) 1.2 (-/C/- 40F) 1.2 (-/C/- 40F) 1.2 (-/C/- 40F) 1.2 (B/-/ 40F) 1.2 (B/-/ 40F) 1.2 (B/-/ 40F) 1.4 (-/C/- 402) 1.4 (-/C/- 403) 1.4 (-/C/- 403) 1.4 (-/C/- 407) 1.4 (-/C/- 40J) 1.4 (-/C/- 40M) 1.4 (B/-/ 402) 1.4 (B/-/ 402) 1.4 (B/-/ 403) 1.4 (B/-/ 403) 1.4 (B/-/ 403) 1.4 (B/-/ 403) 1.4 (B/-/ 407) 1.4 (B/-/ 40J) 1.4 (B/-/ 40J) 1.4 (B/-/ 40M) 1.4 (B/-/ 40M) 1.6 (-/-/S 404) 1.6 (-/-/S 404) 1.6 (-/C/- 404) 1.6 (B/-/ 404) 1.6 (B/-/ 404) 1.6 (B/-/ 404) 1.6 (B/-/ 404) 1.7 (-/C/- 408) 1.7 (B/-/ 408)	J0002048 F0003023 F0041900 E0031616 A0014817 F0036138 E0022098 A0015020 E0032423 F0091886 E0010323 F0011863 F0002765 F0012574 F0040540 E0039388 H0024395 F0040959 E0005420 F0007769 H0000118 F0000321 H0000389 F0003205 J0015987 F0033520 E0003969 H0004300 F0092729 E0005191 F0003232 F0001836		06.87 06.87 01.87 01.87 01.87 01.86 01.86 01.86 01.85 01.85 01.85 01.85 06.87 06.87 01.85 01.85 01.85 01.85 01.85 01.85 01.86 06.87 06.87 06.87 01.85 01.85 01.85 01.85 01.86 01.86 01.86 01.87 01.87			24.3481-1611.5 24.3481-1612.5 24.0101-4807.2	240029 240030 260053	<input type="checkbox"/> <input type="checkbox"/>	D=48, - Halter D=48, - Halter Bremsattel-Zubehör	TRW TRW TRW
	1.2 (-/-/S 40F) 1.2 (-/-/S 40F) 1.2 (-/C/- 40F) 1.2 (-/C/- 40F) 1.2 (-/C/- 40F) 1.2 (B/-/ 40F) 1.2 (B/-/ 40F) 1.2 (B/C/- 40F) 1.4 (-/C/- 402) 1.4 (-/C/- 403) 1.4 (-/C/- 403) 1.4 (-/C/- 407) 1.4 (-/C/- 40J) 1.4 (-/C/- 40M) 1.4 (B/-/ 402) 1.4 (B/-/ 402) 1.4 (B/-/ 403) 1.4 (B/-/ 403) 1.4 (B/-/ 403) 1.4 (B/-/ 403) 1.4 (B/-/ 407) 1.4 (B/-/ 40J) 1.4 (B/-/ 40J) 1.4 (B/-/ 40M) 1.4 (B/-/ 40M) 1.6 (-/-/S 404) 1.6 (-/-/S 404) 1.6 (-/C/- 404) 1.6 (B/-/ 404) 1.6 (B/-/ 404) 1.6 (B/-/ 404) 1.6 (B/-/ 404) 1.6 (B/C/- 404) 1.7 (-/C/- 408) 1.7 (B/-/ 408)	F0003024 J0002049 A0014818 E0031617 F0041901 A0015021 E0022099 F0036139 E0032424 E0010324 F0091887 F0011864 F0002766 F0012575 E0039389 F0040541 E0005421 F0040960 H0024396 F0007770 F0000322 H0000119 F0003206 H0000390 F0033521 J0015988 E0003970 E0005292 F0092730 H0004301 F0003233 F0001837		08.90 08.90 08.90 - E 08.90 - E 08.90 - E 08.90 - E 08.90 - E 08.90 + E 06.89 - E (MA) 08.90 - E (MA) 08.90 - E (MA) 12.96 08.90 08.90 08.90 - E 08.90 - E 08.90 - E 08.90 - E 12.96 08.90 08.90 08.90 08.90 08.90 08.90 08.90 08.90 08.90 + E (MA) 08.90 + E (MA) 12.96 - E (MA) 12.96 - E (MA) 01.85 12.96 + E (MA) 12.96 - E (MA) 12.96 - E (MA) 12.96 - E (MA) 12.96 - E (MA) 12.96 - E (MA) 12.96 - E (MA) 12.96 - E (MA) 12.96 - E (MA) 01.85 12.96 + E (MA) 03.95 03.95			24.3481-1505.5 24.3481-1506.5 24.3481-1611.5 24.3481-1612.5 24.0101-4803.2 24.0101-4807.2	240047 240048 240029 240030 260049 260053	<input type="checkbox"/> <input type="checkbox"/> <input type="checkbox"/> <input type="checkbox"/>	D=48, - Halter D=48, - Halter D=48, - Halter D=48, - Halter Bremsattel-Zubehör Bremsattel-Zubehör	BDX BDX TRW TRW BDX TRW
	1.4 (-/C/- 405) 1.7 1.7 (-/C/- 409)			01.85 08.90 06.87 03.95 01.87 08.91		24.3481-1615.5 24.3481-1616.5 24.0101-4806.2	240031 240032 260052	<input type="checkbox"/> <input type="checkbox"/>	D=48, - Halter D=48, - Halter Bremsattel-Zubehör	TRW TRW TRW	

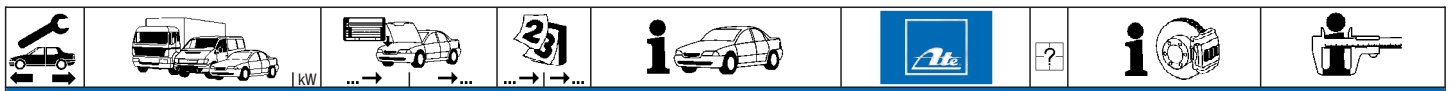

RENAULT R5 SUPER (85-96)

	1.7 (B/C/- 40G) 1.7 (B/C/- 40K)		06.87 03.95 06.87 03.95		24.3481-1615.5 240031 24.3481-1616.5 240032 24.0101-4806.2 260052		D=48, - Halter D=48, - Halter Bremsattel-Zubehör	TRW TRW TRW
	1.0 (B/C/S 400) 1.1 (B/C/- 40H) 1.1 (B/C/S 401) 1.2 (B/C/S 40F) 1.4 (-/C/- 405) 1.4 (B/C/- 402) 1.4 (B/C/- 403) 1.4 (B/C/- 407) 1.4 (B/C/- 40J) 1.4 (B/C/- 40M) 1.6 (B/C/S 404) 1.7 1.7 (-/C/- 409) 1.7 (B/C/- 408) 1.7 (B/C/- 40G) 1.7 (B/C/- 40K)		01.85 08.90 06.87 08.90 01.85 03.95 01.86 08.90 01.85 08.90 01.85 08.90 01.85 08.90 01.85 12.96 06.87 08.90 06.87 08.90 01.86 12.96 06.87 03.95 01.87 08.91 01.87 03.95 06.87 03.95 06.87 03.95		13.0460-3955.2 603955 13.0460-3911.2 603911 13.0460-2834.2 602834 13.0460-0411.2 610411		21097 15,0 +WK 20905 18,0 +WK 21463 18,0 /WK/S Belagsatz-Zubehör	BDX BDX TRW BDX
	1.0 (B/C/S 400) 1.1 (B/C/- 40H) 1.1 (B/C/S 401) 1.2 (B/C/S 40F) 1.4 (B/C/- 402) 1.4 (B/C/- 403) 1.4 (B/C/- 407) 1.4 (B/C/- 40J) 1.4 (B/C/- 40M) 1.6 (B/C/S 404) 1.7 (B/C/- 408) 1.4 (-/C/- 405) 1.7 1.7 (-/C/- 409) 1.7 (B/C/- 40G) 1.7 (B/C/- 40K)		01.85 08.90 06.87 08.90 01.85 03.95 01.85 08.90 01.85 08.90 01.85 12.96 06.87 08.90 06.87 08.90 01.85 12.96 01.87 03.95 01.85 08.90 06.87 03.95 01.87 08.91 06.87 03.95 06.87 03.95		24.0108-0104.1 408104 24.0112-0116.1 412116 24.0120-0125.1 420125		238 8,2 7,0 +S +B 238 12,0 10,5 +S +B 238 20,1 17,7 V +S +B	
	1.0 (B/C/S 400) 1.1 (B/C/- 40H) 1.1 (B/C/S 401) 1.2 (B/C/S 40F) 1.4 (-/C/- 405) 1.4 (B/C/- 402) 1.4 (B/C/- 403) 1.4 (B/C/- 407) 1.4 (B/C/- 40J) 1.4 (B/C/- 40M) 1.6 (B/C/S 404) 1.7 (-/C/- 409) 1.7 (B/C/- 408) 1.7 (B/C/- 40G) 1.7 (B/C/- 40K)		01.85 08.90 06.87 08.90 01.85 03.95 01.86 08.90 01.85 08.90 01.85 08.90 01.85 12.96 06.87 08.90 06.87 08.90 01.85 12.96 01.87 08.91 01.87 03.95 06.87 03.95 06.87 03.95		24.5111-0300.3 330407	2	L=300	
	1.4 (-/C/- 405) 1.7 1.7 (-/C/- 409)		01.85 08.90 06.87 03.95 01.87 08.91		13.0460-3954.2 603954		20973 11,0 +	BDX
	1.0 (B/C/S 400) 1.1 (-/C/- 401) 1.1 (B/-/S 401) 1.1 (B/C/- 40H) 1.2 (B/C/S 40F) 1.4 (B/C/- 402) 1.4 (B/C/- 403) 1.4 (B/C/- 407) 1.4 (B/C/- 40J) 1.4 (B/C/- 40M) 1.6 (B/C/S 404) 1.7 (B/C/- 408) 1.7 (B/C/- 40G) 1.7 (B/C/- 40K) 1.1 (-/C/- 401) 1.4 (-/C/- 405) 1.4 (B/C/- 402) 1.7 (-/C/- 409)		01.85 08.90 01.85 08.90 + ⊕ 01.85 03.95 06.87 08.90 01.86 08.90 01.85 08.90 + ⊕ 01.85 08.90 01.85 12.96 06.87 08.90 06.87 08.90 01.85 12.96 01.87 03.95 06.87 03.95 06.87 03.95 01.85 03.95 - ⊖ 01.85 08.90 01.85 08.90 - ⊖ 01.87 08.91		24.5229-0240.3 330400 24.5229-0285.3 330032 24.5229-0240.3 330400	 2	L=242 L=285 L=242	
	1.0 (B/C/S 400) 1.1 (B/C/S 401) 1.2 (B/-/ 40F) 1.2 (B/C/S 40F) 1.4 (B/C/- 402) 1.4 (B/C/- 403) 1.4 (B/C/- 407) 1.6 (B/C/S 404) 1.7 (B/C/- 408)		01.85 05.87 - E (MA) 01.85 05.87 - E (MA) 06.87 08.90 - E 01.86 05.87 01.85 05.87 - E (MA) 01.85 05.87 - E (MA) 01.85 05.87 01.86 05.87 - E (MA) 01.87 05.87		24.3222-1709.3 020111 24.3222-1710.3 020112	 	Rz 22,20 Rz 22,20	BDX BDX
	1.0 (B/C/- 400) 1.1 (B/C/- 401) 1.1 (B/C/- 40H) 1.2 (-/C/S 40F) 1.2 (B/-/ 40F) 1.4 (-/C/- 403)		06.87 08.90 06.87 03.95 06.87 08.90 06.87 08.90 06.87 08.90 - E 06.87 08.90		24.3220-1623.3 020353 24.3220-1624.3 020354	 	RzR 20,64 RzR 20,64	BDX BDX



RENAULT R5 SUPER (85-96)

	1.4 (B/-/ 403)		06.87	08.90	- E	24.3220-1623.3	020353	<input type="checkbox"/>	RzR 20,64	BDX
	1.4 (B/C/- 402)		06.87	08.90		24.3220-1624.3	020354	<input type="checkbox"/>	RzR 20,64	BDX
	1.4 (B/C/- 407)		06.87	12.96						
	1.4 (B/C/- 40J)		06.87	08.90						
	1.4 (B/C/- 40M)		06.87	08.90						
	1.6 (-/C/S 404)		06.87	12.96						
	1.6 (B/-/ 404)		06.87	12.96	- E					
	1.7 (B/C/- 408)		06.87	03.95						
	1.7 (B/C/- 40K)		06.87	03.95						
	1.0 (-/C/- 400)	J0002661	01.85			24.3222-1107.3	020262	<input type="checkbox"/>	Rz 22,20	TRW
	1.0 (-/C/- 400)	F0136026	01.85							
	1.0 (-/C/- 400)	E0019232	01.85							
	1.0 (-/C/- 400)	A0004689	01.85							
	1.1 (-/C/- 401)	H0014971	01.85							
	1.1 (-/C/- 401)	F0241694	01.85							
	1.1 (-/C/- 401)	E0033906	01.85							
	1.1 (-/C/- 401)	A0026303	01.85							
	1.1 (B/-/ 401)	H0090813	01.85							
	1.1 (B/-/ 401)	F0141915	01.85							
	1.1 (B/-/ 401)	A0017137	01.85							
	1.2 (-/C/- 40F)	F0014301	01.87							
	1.2 (-/C/- 40F)	A0007044	01.87							
	1.2 (B/-/ 40F)	F0012819	01.86							
	1.2 (B/-/ 40F)	A0008584	01.86							
	1.4 (-/C/- 402)	H0017842	01.85							
	1.4 (-/C/- 402)	F0047933	01.85							
	1.4 (-/C/- 402)	E0004507	01.85							
	1.4 (-/C/- 403)	H0015774	01.85							
	1.4 (-/C/- 403)	F0074221	01.85							
	1.4 (-/C/- 407)	F0005257	01.85							
	1.4 (-/C/- 40J)	F0000958	06.87							
	1.4 (-/C/- 40M)	F0003838	06.87							
	1.4 (B/-/ 402)	H0018358	01.85							
	1.4 (B/-/ 402)	F0039701	01.85							
	1.4 (B/-/ 403)	H0018137	01.85							
	1.4 (B/-/ 403)	F0028155	01.85							
	1.4 (B/-/ 40J)	F0000136	06.87							
	1.4 (B/-/ 40M)	F0001177	06.87							
	1.6 (-/S 404)	J0009075	01.85							
	1.6 (-/S 404)	F0018026	01.85							
	1.6 (-/C/- 404)	F0021950	01.85							
	1.6 (B/-/ 404)	F0067508	01.86							
	1.7 (-/C/- 408)	F0001222	01.87							
	1.7 (-/C/- 40G)	F0007082	06.87							
	1.7 (-/C/- 40K)	F0001063	06.87							
	1.7 (B/-/ 408)	F0000958	01.87							
	1.7 (B/-/ 40G)	F0004650	06.87							
	1.7 (B/-/ 40K)	F0000015	06.87							
	1.0 (-/C/- 400)	A0004690	08.90			24.3220-1713.3	020410	<input type="checkbox"/>	RzR 20,64	TRW
	1.0 (-/C/- 400)	E0019233	08.90			24.3220-1714.3	020411	<input type="checkbox"/>	RzR 20,64	TRW
	1.0 (-/C/- 400)	F0136027	08.90							
	1.0 (-/C/- 400)	H0002281	08.90							
	1.0 (-/C/- 400)	J0002662	08.90							
	1.1 (-/C/- 401)	A0026304	03.95							
	1.1 (-/C/- 401)	E0033907	03.95							
	1.1 (-/C/- 401)	F0241695	03.95							
	1.1 (-/C/- 401)	J0017039	03.95							
	1.1 (B/-/ 401)	A0017138	03.95							
	1.1 (B/-/ 401)	F0141916	03.95							
	1.1 (B/-/ 401)	H0090814	03.95							
	1.2 (-/C/- 40F)	A0007045	08.90							
	1.2 (-/C/- 40F)	F0014302	08.90							
	1.2 (B/-/ 40F)	A0008585	08.90							
	1.2 (B/-/ 40F)	F0012820	08.90							
	1.4 (-/C/- 402)	E0004508	06.89							
	1.4 (-/C/- 402)	F0047934	06.89							
	1.4 (-/C/- 403)	F0074222	08.90							
	1.4 (-/C/- 403)	H0015775	08.90							
	1.4 (-/C/- 407)	F0005258	12.96							
	1.4 (-/C/- 40J)	F0000959	08.90							
	1.4 (-/C/- 40M)	F0003839	08.90							
	1.4 (B/-/ 402)	F0039702	08.90							
	1.4 (B/-/ 402)	H0018359	08.90							
	1.4 (B/-/ 403)	F0028156	08.90							
	1.4 (B/-/ 403)	H0018138	08.90							
	1.4 (B/-/ 40J)	F0000137	08.90							
	1.4 (B/-/ 40M)	F0001178	08.90							
	1.6 (-/S 404)	F0018027	12.96							
	1.6 (-/S 404)	J0009076	12.96							
	1.6 (-/C/- 404)	F0021951	12.96							
	1.6 (B/-/ 404)	F0067509	12.96							
	1.7 (-/C/- 408)	F0001223	03.95							
	1.7 (-/C/- 40G)	F0007083	03.95							
	1.7 (-/C/- 40K)	F0001064	03.95							
	1.7 (B/-/ 408)	F0000959	03.95							
	1.7 (B/-/ 40G)	F0004651	03.95							
	1.7 (B/-/ 40K)	F0000016	03.95							





RENAULT R5 SUPER (85-96)

	1.0 1.1 1.2 1.4 1.6 1.7	85		01.85 08.90 01.85 03.95 01.86 08.90 01.85 12.96 01.85 12.96 06.87 03.95		03.0137-0209.2 650209 03.0137-0203.2 650203 03.0137-0201.2 650201 03.0137-9086.2 669086 03.0137-9055.2 669055 03.0137-9056.2 669056		- autom. Nachstellung ¹⁾ + autom. Nachstellung ²⁾	180 x 42 180 x 42 AUT 180 x 41 HEB Bremsbacken-Zubehör Bremsbacken-Zubehör Bremsbacken-Zubehör	BDX BDX TRW BDX BDX TRW
	1.0 1.1 1.2 1.4 1.6 1.7	85		01.85 08.90 01.85 03.95 01.86 08.90 01.85 12.96 01.85 12.96 06.87 03.95		24.0218-0032.1 480118 24.0218-0732.2 480207			180/181 x 53,5 - Lager 180/181 x 53,5 + Lager	
	1.0 (B/C/S 400) 1.1 (B/C/S 401) 1.2 (B/C/S 40F) 1.4 (B/C/- 402) 1.4 (B/C/- 403) 1.4 (B/C/- 407) 1.6 (B/C/S 404)			01.85 06.86 - (E) MA 01.85 06.86 - (E) MA 01.86 06.86 01.85 06.86 - (E) MA 01.85 06.86 - (E) MA 01.85 06.86 01.86 06.86 - (E) MA		03.0520-0922.3 690922			22,20/180x42 TopKit	BDX
	1.0 (B/C/S 400) 1.1 (B/C/S 401) 1.2 (B/-/ 40F) 1.2 (B/C/S 40F) 1.4 (B/C/- 402) 1.4 (B/C/- 403) 1.4 (B/C/- 407) 1.6 (B/C/S 404) 1.7 (B/C/- 408)			07.86 05.87 - (E) MA 07.86 05.87 - (E) MA 07.86 05.87 - (E) 07.86 05.87 07.86 05.87 - (E) MA 07.86 05.87 - (E) MA 07.86 05.87 07.86 05.87 - (E) MA 01.87 05.87		03.0520-1022.3 691022			22,20/180x42 TopKit	BDX
	1.0 (B/C/- 400) 1.1 (B/C/- 401) 1.1 (B/C/- 40H) 1.2 (-/C/S 40F) 1.2 (B/-/ 40F) 1.4 (-/C/- 403) 1.4 (B/-/ 403) 1.4 (B/C/- 402) 1.4 (B/C/- 407) 1.4 (B/C/- 40J) 1.4 (B/C/- 40M) 1.6 (-/C/S 404) 1.6 (B/-/ 404) 1.7 (B/C/- 408) 1.7 (B/C/- 40K)			06.87 08.90 06.87 03.95 06.87 08.90 06.87 08.90 06.87 08.90 - (E) 06.87 08.90 06.87 08.90 - (E) 06.87 08.90 06.87 12.96 06.87 08.90 06.87 08.90 06.87 12.96 06.87 12.96 - (E) 06.87 03.95 06.87 03.95		03.0420-1020.3 681020 03.0520-1020.3 691020			20,64/180x42 Kit 20,64/180x42 TopKit	BDX BDX
	1.0 (-/C/- 400) 1.0 (-/C/- 400) 1.0 (-/C/- 400) 1.0 (-/C/- 400) 1.0 (-/C/- 400) 1.1 (-/C/- 401) 1.1 (-/C/- 401) 1.1 (-/C/- 401) 1.1 (-/C/- 401) 1.1 (B/-/ 401) 1.1 (B/-/ 401) 1.1 (B/-/ 401) 1.2 (-/C/- 40F) 1.2 (-/C/- 40F) 1.2 (B/-/ 40F) 1.2 (B/-/ 40F) 1.4 (-/C/- 402) 1.4 (-/C/- 402) 1.4 (-/C/- 402) 1.4 (-/C/- 403) 1.4 (-/C/- 407) 1.4 (-/C/- 40J) 1.4 (-/C/- 40M) 1.4 (B/-/ 402) 1.4 (B/-/ 402) 1.4 (B/-/ 403) 1.4 (B/-/ 403) 1.4 (B/-/ 40J) 1.6 (-/S 404) 1.6 (-/S 404) 1.6 (-/C/- 404) 1.6 (B/-/ 404) 1.7 (-/C/- 408) 1.7 (-/C/- 40G) 1.7 (-/C/- 40K) 1.7 (B/-/ 408) 1.7 (B/-/ 40G) 1.7 (B/-/ 40K)			J0002661 01.85 H0002280 01.85 F0136026 01.85 E0019232 01.85 A0004689 01.85 H0014971 01.85 F0241694 01.85 E0033906 01.85 A0026303 01.85 H0090813 01.85 F0014915 01.85 A0017137 01.85 F0014301 01.87 A0007044 01.87 F0012819 01.86 A0008584 01.86 H0017842 01.85 F0047933 01.85 E0004507 01.85 F0074221 01.85 F0005257 01.85 F0000958 06.87 F0003838 06.87 H0018358 01.85 F0039701 01.85 H0018137 01.85 F0028155 01.85 F0000136 06.87 J0009075 01.85 F0018026 01.85 F0021950 01.85 F0067508 01.86 F0001222 01.87 F0007082 06.87 F0001063 06.87 F0000958 01.87 F0004650 06.87 F0000015 06.87		03.0520-1122.3 691122			22,20/180x41 TopKit	TRW
	1.0 (-/C/- 400) 1.0 (-/C/- 400) 1.0 (-/C/- 400) 1.0 (-/C/- 400) 1.1 (-/C/- 401)	A0004690 E0019233 F0136027 H0002281 J0002662 A0026304		08.90 08.90 08.90 08.90 03.95		03.0520-6320.3 696320			20,64/180x41 TopKit	TRW

¹⁾ - automatic adjustment / - correzione automatica / - ajustage automatique / - reajuste automático
²⁾ + automatic adjustment / + correzione automatica / + ajustage automatique / + reajuste automático

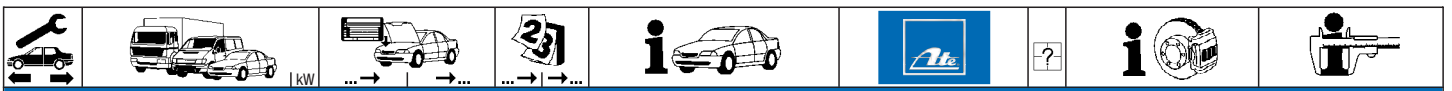

RENAULT R5 SUPER (85-96)

	1.1 (-/C/- 401)	E0033907	03.95	03.0520-6320.3	696320		20,64/180x41 TopKit TRW
	1.1 (-/C/- 401)	F0241695	03.95				
	1.1 (-/C/- 401)	J0017039	03.95				
	1.1 (B/-/ 401)	A0017138	03.95				
	1.1 (B/-/ 401)	F0141916	03.95				
	1.1 (B/-/ 401)	H0090814	03.95				
	1.2 (-/C/- 40F)	A0007045	08.90				
	1.2 (-/C/- 40F)	F0014302	08.90				
	1.2 (B/-/ 40F)	A0008585	08.90				
	1.2 (B/-/ 40F)	F0012820	08.90				
	1.4 (-/C/- 402)	E0004508	06.89				
	1.4 (-/C/- 402)	F0047934	06.89				
	1.4 (-/C/- 403)	F0074222	08.90				
	1.4 (-/C/- 403)	H0015775	08.90				
	1.4 (-/C/- 407)	F0005258	12.96				
	1.4 (-/C/- 40J)	F0000959	08.90				
	1.4 (-/C/- 40M)	F0003839	08.90				
	1.4 (B/-/ 402)	F0039702	08.90				
	1.4 (B/-/ 402)	H0018359	08.90				
	1.4 (B/-/ 403)	F0028156	08.90				
	1.4 (B/-/ 403)	H0018138	08.90				
	1.4 (B/-/ 40J)	F0000137	08.90				
	1.4 (B/-/ 40M)	F0001178	08.90				
	1.6 (-/S 404)	F0018027	12.96				
	1.6 (-/S 404)	J0009076	12.96				
	1.6 (-/C/- 404)	F0021951	12.96				
	1.6 (B/-/ 404)	F0067509	12.96				
	1.7 (-/C/- 408)	F0001223	03.95				
	1.7 (-/C/- 40G)	F0007083	03.95				
	1.7 (-/C/- 40K)	F0001064	03.95				
	1.7 (B/-/ 408)	F0000959	03.95				
	1.7 (B/-/ 40G)	F0004651	03.95				
	1.7 (B/-/ 40K)	F0000016	03.95				
	1.0		01.85 08.90	24.3727-1005.2	581005	2 ↓	L=1330
	1.1		01.85 03.95				
	1.2		01.86 08.90				
	1.4	85	01.85 12.96 + HA-Trommelbremse 1)				
	1.6		01.85 12.96				
	1.7		06.87 03.95 + HA-Trommelbremse 1)				
	1.4 (-/C/- 405)		01.85 08.90 + HA-Scheibenbremse 2)	24.3727-1017.2	581017	2 ↓	L=1403
	1.7 (-/C/- 409)		01.87 08.91 + HA-Scheibenbremse 2)				
	1.0 (B/C/- 400)		01.85 08.90 + E MA	03.6583-0007.3	320101		BRL 8/3 (4) ATE
	1.1 (B/C/- 401)		01.85 03.95 + E MA				
	1.2 (-/C/- 40F)		01.87 05.87				
	1.2 (-/C/- 40F)		06.87 08.90 + E MA				
	1.2 (B/-/ 40F)		01.86 08.90 + E MA				
	1.4 (-/C/- 403)		01.85 05.87				
	1.4 (-/C/- 403)		06.87 08.90 + E MA				
	1.4 (B/-/ 403)		06.87 08.90 + E MA				
	1.4 (B/C/- 402)		01.85 08.90 + E MA				
	1.6 (-/S 404)		01.85 05.87				
	1.6 (B/C/- 404)		01.86 05.87				
	1.6 (B/C/- 404)		06.87 12.96 + E MA				
	1.7 (B/C/- 408)		01.87 05.87				
	1.7 (B/C/- 40G)		06.87 08.90 + E MA				
	1.0		01.85 08.90	24.3728-1006.2	591006		L=1050
	1.1		01.85 03.95				
	1.2		01.86 08.90				
	1.4	85	01.85 12.96				
	1.6		01.85 12.96				
	1.7		06.87 03.95				

RENAULT R5 (72-84)

	0.8 (R1220)		01.72 12.81 + A F	24.3119-1702.3	010465		Hz 19,05
	0.8 (R1221)	0238423	01.73 + L				
	0.8 (R1221)	0127674	01.73 + D				
	0.8 (R1221)	0037964	01.73 + B A IL NL				
	0.8 (R1221)	0009569	01.73 + DK				
	0.8 (R1221)		01.73 12.84 + FH IS				
	0.8 (R1220)		01.72 12.81 + EDN S	24.2120-1503.3	010397		THz 20,64 BDX
	0.8 (R1221)	0238424	0280142 + L				
	0.8 (R1221)	0127676	0280142				
	1.0 (R1222)	1117921	01.72 + L	24.3119-1703.3	010466		Hz 19,05
	1.0 (R1222)	0897764	01.72 + D				
	1.0 (R1222)	0774925	01.72 + F MA				
	1.0 (R1222)	0574925	01.72 + B NL				
	1.0 (R1222)	0173346	01.72 + DK				
	1.0 (R2382)	0008799	01.72 + F MA				
	1.1 (R1227)	0151059	12.84 + CH				
	0.8 (R1221)	0288143	0335200	24.2120-1715.3	010469		THz 20,64
	0.8 (R1391)	0009234	0051150				
	0.8 (R2381)	0020549	0038990				
	1.0 (R1222)	0574926	0775074				
	1.0 (R1222)	1015701					
	1.0 (R2382)	0008799	01.76				
	1.0 (R2382)	0034296	12.84 + CH DK N				
			12.84 + D F A B CH				
			12.84 + DK				
			12.84 - DK				

1) + RA drum brake / + P freno a tamburo / + frein à tambour essieu AR / + ET-tambores de freno

2) + RA disc brake / + P disco freno / + frein à disque essieu AR / + ET-disco de freno



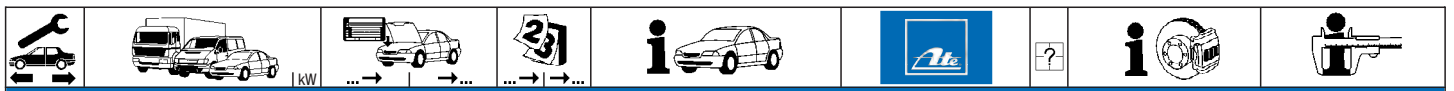





RENAULT R5 (72-84)

	0.8 (R1221) 0.8 (R1391) 0.8 (R2381) 1.0 (R1222) 1.0 (R1392) 1.1 (R1227) 1.1 (R1227) 1.1 (R1397) 1.3 (R2387)	0335201 0051151 0038991 1117922	0151058	01.80 01.80 01.80 01.80 01.80	12.84 12.84 12.84 12.84 12.84 12.84 12.84 12.84 12.84	- Bremsgerät ¹⁾ + CH - CH	24.2119-1703.3	010323		Thz 19,05	
	1.0 (R1222) 1.0 (R1222) 1.0 (R1222) 1.0 (R1222) 1.0 (R1222) 1.0 (R2382) 1.0 (R2382)	0897755 0775075 0762309 0774926 0574926 0008800 0025883	1015700 1015700 1015700 1015700 1015700 0036295 0025883	01.72	12.84 12.84 12.84 12.84 12.84 12.84 12.84	+ D + E A CH CH N + GB + I + B IL + F DK MA + B	24.2120-1718.3	010491		Thz 20,64	BDX
	1.0 (R1392) 1.1 (R1227) 1.1 (R1227) 1.1 (R1397) 1.3 (R1395) 1.3 (R2387) 1.4 (R122B) 1.4 (R1399)		0151058	01.80 01.80 01.80 01.80 01.80 01.82 01.81	12.84 12.84 12.84 12.84 12.84 12.84 12.84 12.84	+ Bremsgerät ²⁾ + CH - CH + Bremsgerät ²⁾ - CH	03.2119-0781.3	010052		Thz 19,05	ATE
	0.8 (R1221) 0.8 (R1391) 0.8 (R2381) 1.0 (R1222) 1.1 (R1227) 1.3 (R1224) 1.3 (R1225) 1.3 (R2387) 1.4 (R1229)	0335201 0051151 0038981		01.72 01.80 01.76 01.76 01.80 01.80	12.84 12.84 12.84 12.84 12.84 12.84 12.84 12.84 12.84		13.0460-2967.2	602967		20480 15,5 /S	TRW
	1.0 (R1222) 1.0 (R1392) 1.1 (R1227) 1.1 (R1397) 1.3 (R1224) 1.3 (R1225) 1.3 (R1395) 1.3 (R2387) 1.4 (R1229) 1.4 (R1399)	1185269 0026816 0411329 0503339 0497566 0399951 0048701 0052900 0083872 0026223		01.76 01.82	12.81 12.81		13.0460-3928.2	603928		20140 14,0 +/WE	BDX
	1.4 (R1223) 1.4 (R122B)			01.76 01.82	12.81 12.81		13.0460-3928.2	603928		20140 14,0 +/WE	BDX
	0.8 (R1221) 0.8 (R1391) 0.8 (R2381) 1.0 (R1222) 1.0 (R1392) 1.1 (R1227) 1.1 (R1397) 1.3 (R1224) 1.3 (R1225) 1.3 (R1395) 1.3 (R2387) 1.4 (R1223) 1.4 (R1229) 1.4 (R122B) 1.4 (R1399) 1.4 (R8220)	0335201 0051151 0038981 0026816 0503339 0048701 0026223		01.72 01.80 01.76 01.76 01.80 01.76 01.80 01.76 01.82 01.80 01.80	12.84 12.84 12.84 12.84 12.84 12.84 12.84 12.84 12.84 12.84 12.81 12.84 12.84 12.84 12.84		24.0110-0139.1	410139		228 10,0 9,0	
	1.0 (R1222) 1.0 (R1392) 1.1 (R1227) 1.1 (R1397) 1.3 (R1224) 1.3 (R1225) 1.3 (R1395) 1.3 (R2387) 1.4 (R1223) 1.4 (R1229) 1.4 (R1399)			01.72 01.80 01.80 01.80 01.76 01.76 01.80 01.80 01.80 01.81	12.84 12.84 12.84 12.84 12.84 12.84 12.84 12.84 12.81 12.84 12.84		24.5115-0400.3	330413	2	L=400	
	0.8 (R1220) 0.8 (R1221) 0.8 (R1391) 0.8 (R2381)	0335200 0051150 0038980		01.72 01.73 01.80 01.78	12.81 12.81 12.81 12.81		24.3223-1101.3 24.3223-1102.3	020288 020289	<input type="checkbox"/> <input type="checkbox"/>	Rz 23,81 Rz 23,81	BDX BDX
	0.8 (R1220) 0.8 (R1221) 0.8 (R1221) 0.8 (R2381)	0238423 0009569 0011591		01.72 01.73 01.73 01.78	12.81 12.81 12.81 12.81	- S - DK N S + DK	03.0137-9028.2	669028		Bremsbacken-Zubehör	BDX
	0.8 (R1220) 0.8 (R1221) 0.8 (R1221) 0.8 (R1221) 0.8 (R1391) 0.8 (R2381)	0238424 0009570 0011592	0335200 0335200 0335200 0051150 0038980	01.72 01.73 01.73 01.80	12.81 12.81 12.81 12.81	+ S - DK N S + DK + N S	03.0137-9020.2	669020	+ autom. Nachstellung ³⁾	Bremsbacken-Zubehör	BDX

¹⁾ - booster unit / - servofreno / - servo-frein / - servofreno

²⁾ + booster unit / + servofreno / + servo-frein / + servofreno

³⁾ + automatic adjustment / + correzione automatica / + ajustage automatique / + reajuste automático

RENAULT R5 (72-84)										
	1.4 (R122B)			01.82	12.84		24.0110-0139.1	410139		228 10,0 9,0
	0.8 (R1220)		0118673	01.72			24.3219-1101.3	020189		Rz 19,05 BDX
	0.8 (R1221)		0238423	01.73						
	0.8 (R2381)		0011591	01.78						
	0.8 (R1220)	0118674	0335200		12.81		24.3220-1101.3	020212		Rz 20,64 BDX
	0.8 (R1221)	0238424	0051150	01.80						
	0.8 (R1391)		0038980							
	0.8 (R2381)	0011592								
	0.8 (R1221)	0335201			12.84		24.3222-1101.3	020256		Rz 22,20 BDX
	0.8 (R1391)	0051151			12.84					
	0.8 (R2381)	0038981			12.84					
	1.0 (R1222)			01.72	12.84		24.3222-1101.3	020256		Rz 22,20 BDX
	1.0 (R1392)			01.80	12.84		24.3222-1103.3	020258		Rz 22,20 TRW
	1.1 (R1227)			01.80	12.84					
	1.1 (R1397)			01.80	12.84					
	1.3 (R1224)			01.74	12.84					
	1.3 (R1225)			01.76	12.84					
	1.3 (R1395)			01.80	12.84					
	1.4 (R1229)			01.80	12.84					
	1.4 (R1399)			01.81	12.84					
	1.3 (R2387)			01.80	12.84		24.3222-1103.3	020258		Rz 22,20 TRW
	0.8 (R1220)		0335200	01.72	12.81	- (S)	03.0137-9039.2	669039		Bremsbacken-Zubehör BDX
	0.8 (R1221)		0051150	01.73						
	0.8 (R1391)		0038980	01.80						
	0.8 (R2381)			01.78						
	0.8 (R1220)			01.72	12.81	+	03.0137-9032.2	669032		Bremsbacken-Zubehör BDX
	0.8 (R1221)	0009570	0360620				03.0137-0082.2	650082		180 x 32 BDX
	0.8 (R1391)	0051151	0062540				03.0137-9031.2	669031		Bremsbacken-Zubehör BDX
	0.8 (R2381)	0038981	0044870							
	1.0 (R1222)		1197930	01.72						
	1.0 (R1392)		0032000	01.80						
	1.1 (R1227)		0502120	01.80						
	1.1 (R1397)		0637940	01.80						
	1.3 (R1224)		0409290	01.74						
	1.3 (R1225)		0400600	01.76						
	1.3 (R1395)		0049300	01.80						
	1.3 (R2387)		0073140	01.80						
	1.4 (R1229)		0133890	01.80						
	1.4 (R1399)		0040100	01.81						
	0.8 (R1221)	0360621			12.84		03.0137-9032.2	669032		Bremsbacken-Zubehör BDX
	0.8 (R1391)	0062541			12.84					
0.8 (R2381)	0044871			12.84						
	1.0 (R1222)	1197931			12.84		03.0520-0622.3	690622		22,20/180x32 TopKit BDX
	1.0 (R1392)	0032001			12.84					
	1.1 (R1227)	0502121			12.84					
	1.1 (R1397)	0637941			12.84					
	1.3 (R1224)	0409291			12.84					
	1.3 (R1225)	0400601			12.84					
	1.3 (R1395)	0049301			12.84					
	1.3 (R2387)	0073141			12.84					
	1.4 (R1229)	0133891			12.84					
	1.4 (R1399)	0040101			12.84					
	0.8 (R1220)			01.72	12.81		24.3727-1004.2	581004	<input type="checkbox"/>	L=1500
	0.8 (R1221)			01.73	12.84					
	0.8 (R1391)			01.80	12.84					
	0.8 (R2381)			01.78	12.84					
	1.0 (R1222)			01.72	12.84					
	1.0 (R1392)			01.80	12.84					
	1.1 (R1227)			01.80	12.84					
	1.1 (R1397)			01.80	12.84					
	1.3 (R1224)			01.76	12.84					
	1.3 (R1225)			01.76	12.84					
1.3 (R1395)			01.80	12.84						
1.3 (R2387)			01.80	12.84						
1.4 (R1223)			01.76	12.81						
1.4 (R1229)			01.80	12.84						
1.4 (R122B)			01.82	12.84						
1.4 (R1399)			01.81	12.84						
1.4 (R8220)			01.80	12.84						





RENAULT R6 (69-80)

	0.8 (R1180)		0581126	01.76	+ (D)	24.3119-1702.3	010465		Hz 19,05	
	0.8 (R1180)		0555819	01.76	+ (F) MA					
	0.8 (R1180)	0325727	0439661		+ (DK)					
	0.8 (R1180)	0244979	0325726							
	0.8 (R1180)		0244978	01.69	+ (S)					
	0.8 (R1180)	0325727		12.75	- (DK)					
	0.8 (R1180)	0581127		12.80	+ (A)					
	0.8 (R1180)			01.76	+ (L) (GB) (FR)					
	0.8 (ACL1A) Rodeo	0222715		12.80		24.2120-1503.3	010397		THz 20,64	BDX
	0.8 (R1180)			01.76						
	1.1 (R1181)		0433930	01.70	+ (GH) (S)	24.3119-1703.3	010466		Hz 19,05	
	1.1 (R1181)		0337811	01.70	+ (DK)					
	1.1 (R1181)		0050697	01.70	+ (N)					
	1.1 (R1181)			01.70	- (DK) (CH) (S) (N)					
	1.1 (R1181)			01.76	+ (GR) (MA) (P) (FR)					
	1.1 (R1181)			01.76		24.2120-1715.3	010469		THz 20,64	
	1.1 (R1181)			01.70		13.0460-3928.2	603928		20140 14,0 +/WE	BDX
	1.1 (R1181)			01.70		24.0110-0139.1	410139		228 10,0 9,0	
	0.8 (ACL1A) Rodeo			01.71		24.3223-1101.3	020288		Rz 23,81	BDX
	0.8 (R1180)			01.69		24.3223-1102.3	020289		Rz 23,81	BDX
	0.8 (ACL1A) Rodeo		0455167	01.71		24.3220-1101.3	020212		Rz 20,64	BDX
	0.8 (R1180)			01.69	+ (DK)					
	0.8 (R1180)			01.69	- (DK)					
	0.8 (R1180)	0455168		12.75	+ (DK)	24.3222-1101.3	020256		Rz 22,20	BDX
	1.1 (R1181)			01.70						
	0.8 (R1180)		0555819	01.69	+ (GH)	03.0137-0082.2	650082		180 x 32	BDX
	1.1 (R1181)			01.76		03.0137-9031.2	669031		Bremsbacken-Zubehör	BDX
	0.8 (R1180)	0439662	0555819		+ (DK)	03.0137-9032.2	669032		Bremsbacken-Zubehör	BDX
	0.8 (R1180)			01.69		03.0137-9039.2	669039		Bremsbacken-Zubehör	BDX
	0.8 (R1180)	0455168			+ (DK)	03.0520-0622.3	690622		22,20/180x32 TopKit	BDX

RENAULT R9 (82-89)

	1.1 (L421)	35		01.82	06.87	03.2119-1281.3	010054		THz 19,05	ATE
	1.2 (L42S)	40		10.86	11.89					
	1.4 (L422)	▶ 44		01.82	12.86					
	1.4 (L423)	▶		01.82	09.86	+ Schaltgetriebe ¹⁾				
	1.4 (L423)	◀		01.82	09.86	+ Klimaanlage/ + Automatikgetr. ²⁾				
	1.4 (L423)			10.86	11.89	- (E)				
	1.4 (L42C)	44		10.86	11.89					
	1.4 (L42R)	49		10.86	11.89					
	1.4 i (L42A)			06.87	11.89					
	1.4 T (L425)	◀		01.85	11.89					
	1.6 (L424)	◀ 40		01.83	11.89	- (E)				
	1.7 (L42D)			06.87	11.89					
	1.7 (L42L)	55		10.86	11.89					
	1.7 (L42N)	◀ 65		10.86	11.89					
	1.7 i (L42E)	69		10.86	11.89					
	1.7 i (L42F)	54		01.85	11.89					
	1.4 T (L425)	▶		01.85	11.89	03.2119-3389.3	010057		THz 19,05	ATE
	1.2 (L42S)	40		01.86	11.89	24.3481-1505.5	240047		D=48, - Halter	BDX
	1.4 (L422)	44		01.82	12.86	24.3481-1506.5	240048		D=48, - Halter	BDX
	1.4 (L423)			01.82	11.89	24.3481-1611.5	240029		D=48, - Halter	TRW
	1.4 (L42C)	44		10.86	11.89	24.3481-1612.5	240030		D=48, - Halter	TRW
	1.4 (L42R)	49		10.86	11.89	24.0101-4807.2	260053		Bremsattel-Zubehör	TRW
	1.4 i (L42A)			06.87	11.89					
	1.6 (L424)	40		01.83	11.89					
	1.7 (L426)	59		01.85	06.87					
	1.7 (L42L)	55		10.86	11.89					
	1.7 i (L42F)	54		01.85	11.89					
	1.4 T (L425)			01.85	11.89	24.3481-1615.5	240031		D=48, - Halter	TRW
	1.7 (L42D)			06.87	11.89	24.3481-1616.5	240032		D=48, - Halter	TRW
	1.7 (L42N)	65		10.86	11.89	24.0101-4806.2	260052		Bremsattel-Zubehör	TRW
	1.7 i (L42E)	69		10.86	11.89					
	1.1 (L421)	35		01.82	06.87	13.0460-3911.2	603911		20905 18,0 +/WK	BDX
	1.2 (L42S)	40		01.86	11.89	13.0460-2834.2	602834		21463 18,0 /WK/S	TRW
	1.4 (L422)	44		01.82	12.86	13.0460-0411.2	610411		Belagsatz-Zubehör	BDX
	1.4 (L423)			01.82	11.89					
	1.4 (L42C)	44		10.86	11.89					
	1.4 (L42R)	49		10.86	11.89					
	1.4 i (L42A)			06.87	11.89					
	1.6 (L424)	40		01.83	11.89					
	1.7 (L426)	59		01.85	06.87					
	1.7 (L42L)	55		10.86	11.89					
	1.7 i (L42F)	54		01.85	11.89					
	1.4 T (L425)			01.85	11.89	13.0460-2834.2	602834		21463 18,0 /WK/S	TRW
	1.7 (L42D)			06.87	11.89					
	1.7 (L42N)	65		10.86	11.89					

¹⁾ + manual transmission / + scatola cambio velocità / + transmission mécanique / + cambio de velocidad

²⁾ + air conditioning/+autom.transm. / + aria condizionata/+scatola camb.autom. / + air conditionné / + transm.automatique / + aire acondicionado / + camb.automático

RENAULT R9 (82-89)											
	1.7 i (L42E)	69		10.86	11.89		13.0460-2834.2	602834		21463 18,0 /WK/S	TRW
	1.1 (L421)	35	0084201		06.87		24.0112-0116.1	412116		238 12,0 10,5 +S +B	
	1.2 (L42S)	40		01.86	11.89						
	1.4 (L422)	44	0170421		12.86						
	1.4 (L423)			01.82	11.89						
	1.4 (L42C)	44		10.86	11.89						
	1.4 (L42R)	49		10.86	11.89						
	1.4 i (L42A)			06.87	11.89						
	1.6 (L424)	40		01.83	11.89						
	1.7 (L426)	59		01.85	06.87						
	1.7 (L42L)	55		10.86	11.89						
	1.7 i (L42F)	54		01.85	11.89						
	1.4 T (L425)			01.85	11.89		24.0120-0125.1	420125		238 20,1 17,7 V +S +B	
	1.7 (L42D)			06.87	11.89						
	1.7 (L42N)	65		10.86	11.89						
	1.7 i (L42E)	69		10.86	11.89						
	1.1 (L421)	35		01.82	06.87		24.5111-0345.3	330406	2	L=345	
	1.2 (L42S)	40		01.86	11.89						
	1.4 (L422)	44		01.82	12.86						
	1.4 (L423)			01.82	11.89						
	1.4 (L42C)	44		10.86	11.89						
	1.4 (L42R)	49		10.86	11.89						
	1.4 i (L42A)			06.87	11.89						
	1.4 T (L425)			01.85	11.89						
	1.6 (L424)	40		01.83	11.89						
	1.7 (L426)	59		01.85	06.87						
	1.7 (L42D)			06.87	11.89						
	1.7 (L42L)	55		10.86	11.89						
	1.7 (L42N)	65		10.86	11.89						
	1.7 i (L42E)	69		10.86	11.89						
	1.7 i (L42F)	54		01.85	11.89						
	1.4 T (L425)			10.86	11.89		13.0460-3954.2	603954		20973 11,0 +	BDX
	1.1 (L421)	35		01.82	06.87		24.5229-0240.3	330400	2	L=242	
	1.2 (L42S)	40		01.86	11.89						
	1.4 (L422)	44		01.82	12.86						
	1.4 (L423)			01.82	11.89						
	1.4 (L42C)	44		10.86	11.89						
	1.4 (L42R)	49		10.86	11.89						
	1.4 i (L42A)			06.87	11.89						
	1.4 T (L425)			01.85	11.89						
	1.6 (L424)	40		01.83	11.89						
	1.7 (L426)	59		01.85	06.87						
	1.7 (L42D)			06.87	11.89						
	1.7 (L42L)	55		10.86	11.89						
	1.7 (L42N)	65		10.86	11.89						
	1.7 i (L42E)	69		10.86	11.89						
	1.7 i (L42F)	54		01.85	11.89						
	1.1 (L421)	35		10.86	06.87		24.3222-1709.3	020111	<input type="checkbox"/>	Rz 22,20	BDX
	1.2 (L42S)	40		01.86	09.86	- E	24.3222-1710.3	020112	<input type="checkbox"/>	Rz 22,20	BDX
	1.2 (L42S)	40		01.86	11.89	+ E	24.3222-1709.3	020111	<input type="checkbox"/>	Rz 22,20	BDX
	1.4 (L422)	44		01.82	12.86		24.3222-1710.3	020112	<input type="checkbox"/>	Rz 22,20	BDX
	1.4 (L423)			01.82	09.86	- E	24.3222-1107.3	020262	<input type="checkbox"/>	Rz 22,20	TRW
	1.4 (L423)			01.82	11.89	+ E					
	1.6 (L424)	40		01.83	09.86	- E					
	1.6 (L424)	40		01.83	11.89	+ E					
	1.7 (L426)	59		01.85	09.86						
	1.7 i (L42F)	54		01.85	09.86						
	1.2 (L42S)	40		10.86	11.89	- E	24.3220-1603.3	020230	<input type="checkbox"/>	RzR 20,64	BDX
	1.4 (L423)			10.86	11.89	- E	24.3220-1604.3	020231	<input type="checkbox"/>	RzR 20,64	BDX
	1.4 (L42C)	44		10.86	11.89		24.3222-1107.3	020262	<input type="checkbox"/>	Rz 22,20	TRW
	1.4 (L42R)	49		10.86	11.89						
	1.4 i (L42A)			06.87	11.89						
	1.6 (L424)	40		10.86	11.89	- E					
	1.7 (L426)	59		10.86	06.87						
	1.7 (L42D)			06.87	11.89						
	1.7 (L42N)	65		10.86	11.89						
	1.7 i (L42E)	69		10.86	11.89						
	1.7 i (L42F)	54		10.86	11.89						
	1.1 (L421)	35		01.82	06.87		03.0137-0209.2	650209		180 x 42	BDX
	1.2 (L42S)	40		01.86	11.89		03.0137-0203.2	650203		180 x 42 AUT	BDX
	1.4 (L422)	44		01.82	12.86		03.0137-0201.2	650201		180 x 41 HEB	TRW
	1.4 (L423)			01.82	11.89		03.0137-9086.2	669086		Bremsbacken-Zubehör	BDX
	1.4 (L42C)	44		10.86	11.89		03.0137-9055.2	669055		Bremsbacken-Zubehör	BDX
	1.4 (L42R)	49		10.86	11.89		03.0137-9056.2	669056		Bremsbacken-Zubehör	TRW
	1.4 i (L42A)			06.87	11.89						
	1.6 (L424)	40		01.83	11.89						
	1.7 (L426)	59		01.85	06.87						
	1.7 (L42D)			06.87	11.89						
	1.7 (L42L)	55		10.86	11.89						
	1.7 i (L42E)	69		10.86	11.89						
	1.7 i (L42F)	54		01.85	11.89						

1) - automatic adjustment / - correzione automatica / - ajustage automatique / - reajuste automático
2) + automatic adjustment / + correzione automatica / + ajustage automatique / + reajuste automático



RENAULT R9 (82-89)

	1.1 (L421)	35	01.82	06.87	24.0218-0032.1	480118			180/181 x 53,5 - Lager	
	1.2 (L42S)	40	01.86	11.89	24.0218-0732.2	480207			180/181 x 53,5 + Lager	
	1.4 (L422)	44	01.82	12.86						
	1.4 (L423)		01.82	11.89						
	1.4 (L42C)	44	10.86	11.89						
	1.4 (L42R)	49	10.86	11.89						
	1.4 i (L42A)		06.87	11.89						
	1.6 (L424)	40	01.83	11.89						
	1.7 (L426)	59	01.85	06.87						
	1.7 (L42D)		06.87	11.89						
	1.7 (L42L)	55	10.86	11.89						
	1.7 i (L42E)	69	10.86	11.89						
	1.7 i (L42F)	54	01.85	11.89						
	1.1 (L421)	35	01.82	09.86	03.0520-1117.3	691117			17,46/180x42 TopKit	BDX
	1.1 (L421)	35	10.86	06.87	03.0520-0922.3	690922		+ autom. Nachstellung ¹⁾	22,20/180x42 TopKit	BDX
	1.2 (L42S)	40	01.86	09.86	03.0520-0922.3	690922		+ autom. Nachstellung ¹⁾	22,20/180x42 TopKit	BDX
	1.4 (L422)	44	01.82	12.86	03.0520-1122.3	691122			22,20/180x41 TopKit	TRW
	1.4 (L423)		01.82	09.86						
	1.6 (L424)	40	01.83	09.86						
	1.7 (L426)	59	01.85	09.86						
	1.7 i (L42F)	54	01.85	09.86						
	1.2 (L42S)	40	10.86	11.89	03.0520-0920.3	690920			20,64/180x42 TopKit	BDX
	1.4 (L423)		10.86	11.89	03.0520-1122.3	691122			22,20/180x41 TopKit	TRW
	1.4 (L42C)	44	10.86	11.89						
	1.4 (L42R)	49	10.86	11.89						
	1.4 i (L42A)		06.87	11.89						
	1.6 (L424)	40	10.86	11.89						
	1.7 (L426)	59	10.86	06.87						
	1.7 (L42D)		06.87	11.89						
	1.7 (L42N)	65	10.86	11.89						
	1.7 i (L42E)	69	10.86	11.89						
	1.7 i (L42F)	54	10.86	11.89						

RENAULT R11 (83-89)

	1.1 (B/C/S 371)	35	01.83	06.87	03.2119-1281.3	010054			Thz 19,05	ATE
	1.2 (B/-/- 37S)	40	10.86	11.89						
	1.4 (-/-/S 373)	▶	01.85	09.86						
	1.4 (B/C/- 372)	▶▶	01.83	12.86						
	1.4 (B/C/- 373)	▶▶	01.83	09.86						
	1.4 (B/C/- 373)	◀	01.83	09.86	+ Klimaanlage/ + Automatikgetr. ²⁾					
	1.4 (B/C/- 373)		10.86	11.89	- (E)					
	1.4 (B/C/- 37C)	44	10.86	11.89						
	1.4 (B/C/- 37R)	49	10.86	11.89						
	1.4 i (B/C/- 37A)		06.87	11.89						
	1.4 T (-/C/- 375)	◀	01.84	11.89	- (E)					
	1.4 T (B/-/- 375)	◀	01.84	11.89						
	1.6 D (-/C/- 374)	◀◀	01.84	11.89						
	1.6 D (B/-/- 374)	◀◀	01.84	11.89	- (E) (GB)					
	1.7 (B/-/- 376)	59	01.84	11.89	- (E) (GB)					
	1.7 (B/-/- 37N)	◀	10.86	11.89						
	1.7 (B/C/- 37D)	64	06.87	11.89						
	1.7 (B/C/- 37L)	54	10.86	11.89						
	1.7 i (B/C/- 37E)	69	10.86	11.89						
	1.7 i (B/C/- 37F)	55	01.85	11.89						
	1.4 T (B/C/- 375)	▶	01.84	11.89	03.2119-3389.3	010057			Thz 19,05	ATE
	1.1 (-/-/S 371)	35	01.84	10.86	24.3481-1505.5	240047	■		D=48, - Halter	BDX
	1.1 (B/C/- 371)	35	01.83	06.87	24.3481-1506.5	240048	■		D=48, - Halter	BDX
	1.2 (B/C/S 37S)	40	01.86	11.89	24.3481-1611.5	240029	■		D=48, - Halter	TRW
	1.4 (-/-/S 373)		01.85	10.86	24.3481-1612.5	240030	■		D=48, - Halter	TRW
	1.4 (B/C/- 372)	44	01.83	12.86	24.0101-4807.2	260053	■		Bremssattel-Zubehör	TRW
	1.4 (B/C/- 373)		01.83	11.89						
	1.4 (B/C/- 37C)	44	10.86	11.89						
	1.4 (B/C/- 37R)	49	06.87	11.89						
	1.4 i (B/C/- 37A)		06.87	11.89						
	1.6 D (B/C/S 374)	40	01.84	11.89						
	1.7 (B/C/- 376)	59	01.84	11.89						
	1.7 (B/C/- 37L)	54	10.86	11.89						
	1.7 i (B/C/- 37F)	55	01.85	11.89						
	1.4 T (B/-/- 375)		01.84	11.89	24.3481-1615.5	240031	■		D=48, - Halter	TRW
	1.4 T (B/C/- 375)		01.84	11.89	24.3481-1616.5	240032	■		D=48, - Halter	TRW
	1.7 (B/C/- 37D)	64	06.87	11.89	24.0101-4806.2	260052			Bremssattel-Zubehör	TRW
	1.7 (B/C/- 37N)	65	10.86	11.89						
	1.7 i (B/C/- 37E)	69	10.86	11.89						
	1.1 (-/-/S 371)	35	01.84	10.86	13.0460-3911.2	603911			20905 18,0 +WK	BDX
	1.1 (B/C/- 371)	35	01.83	06.87	13.0460-2834.2	602834			21463 18,0 WK/S	TRW
	1.2 (B/C/S 37S)	40	01.86	11.89	13.0460-0411.2	610411			Belagsatz-Zubehör	BDX
	1.4 (-/-/S 373)		01.85	10.86						
	1.4 (B/C/- 372)	44	01.83	12.86						
	1.4 (B/C/- 373)		01.83	11.89						
	1.4 (B/C/- 37C)	44	10.86	11.89						
	1.4 (B/C/- 37R)	49	06.87	11.89						
	1.4 i (B/C/- 37A)		06.87	11.89						
	1.6 D (B/C/S 374)	40	01.84	11.89						
	1.7 (B/C/- 376)	59	01.84	06.87						
	1.7 (B/C/- 37L)	54	10.86	11.89						
	1.7 i (B/C/- 37F)	55	01.85	11.89						

¹⁾ + automatic adjustment / + correzione automatica / + ajustage automatique / + reajuste automático

²⁾ + air conditioning/+autom.transm. / + aria condizionata/+scatola camb.autom. / + air conditionné / + transm.automatique / + aire acondicionado/ + camb.automático





















RENAULT R11 (83-89)

	1.4 T (B/C/- 375) 1.7 (B/C/- 37D) 1.7 (B/C/- 37N) 1.7 i (B/C/- 37E)	64 65 69	01.84 06.87 10.86 10.86	11.89 11.89 11.89 11.89	13.0460-2834.2	602834			21463 18,0 /WK/S	TRW
	1.1 (-/-/S 371) 1.1 (B/C/- 371) 1.2 (B/C/S 37S) 1.4 (-/-/S 373) 1.4 (B/C/- 372) 1.4 (B/C/- 373) 1.4 (B/C/- 37C) 1.4 (B/C/- 37R) 1.4 i (B/C/- 37A) 1.6 D (B/C/S 374) 1.7 (B/C/- 376) 1.7 (B/C/- 37L) 1.7 i (B/C/- 37F)	35 35 40 44 44 44 49 40 59 54 55	01.84 01.83 01.86 01.85 01.83 01.83 10.86 06.87 06.87 01.84 01.84 10.86 01.85	10.86 06.87 11.89 10.86 12.86 11.89 11.89 11.89 11.89 11.89 06.87 11.89 11.89	24.0112-0116.1	412116			238 12,0 10,5 +S +B	
	1.4 T (B/C/- 375) 1.7 (B/C/- 37D) 1.7 (B/C/- 37N) 1.7 i (B/C/- 37E)	64 65 69	01.84 06.87 10.86 10.86	11.89 11.89 11.89 11.89	24.0120-0125.1	420125			238 20,1 17,7 V +S +B	
	1.1 (-/-/S 371) 1.1 (B/C/- 371) 1.2 (B/C/S 37S) 1.4 (-/-/S 373) 1.4 (B/C/- 372) 1.4 (B/C/- 373) 1.4 (B/C/- 37C) 1.4 (B/C/- 37R) 1.4 i (B/C/- 37A) 1.4 T (B/C/- 375) 1.6 D (B/C/S 374) 1.7 (B/C/- 376) 1.7 (B/C/- 37D) 1.7 (B/C/- 37N) 1.7 i (B/C/- 37E)	35 35 40 44 44 44 49 40 59 64 65 69	01.84 01.83 01.86 01.85 01.83 01.83 10.86 06.87 06.87 01.84 01.84 01.84 10.86 10.86 10.86	10.86 06.87 11.89 10.86 12.86 11.89 11.89 11.89 11.89 11.89 11.89 06.87 11.89 11.89 11.89	24.5111-0345.3	330406	2		L=345	
	1.4 T (B/C/- 375)		10.86	11.89	13.0460-3954.2	603954			20973 11,0 +	BDX
	1.1 (-/-/S 371) 1.1 (B/C/- 371) 1.2 (B/C/S 37S) 1.4 (-/-/S 373) 1.4 (B/C/- 372) 1.4 (B/C/- 373) 1.4 (B/C/- 37C) 1.4 (B/C/- 37R) 1.4 i (B/C/- 37A) 1.4 T (B/C/- 375) 1.6 D (B/C/S 374) 1.7 (B/C/- 376) 1.7 (B/C/- 37D) 1.7 (B/C/- 37N) 1.7 i (B/C/- 37E)	35 35 40 44 44 44 49 40 59 64 65 69	01.84 01.83 01.86 01.85 01.83 01.83 10.86 06.87 06.87 01.84 01.84 01.84 10.86 10.86 10.86	10.86 06.87 11.89 10.86 12.86 11.89 11.89 11.89 11.89 11.89 11.89 06.87 11.89 11.89 11.89	24.5229-0240.3	330400	2		L=242	
	1.1 (B/C/S 371) 1.2 (B/C/S 37S) 1.4 (B/C/- 372) 1.4 (B/C/S 373) 1.4 T (B/C/- 375) 1.6 D (B/C/S 374) 1.7 (B/C/- 376) 1.7 i (B/C/- 37F)	35 40 44 44 40 59 55	10.86 01.86 01.83 01.83 01.84 01.84 01.84 01.85	06.87 09.86 12.86 09.86 09.86 09.86 08.86 09.86	24.3222-1709.3 24.3222-1710.3	020111 020112	<input type="checkbox"/> <input type="checkbox"/>	Rz 22,20 Rz 22,20	BDX BDX	
	1.2 (B/C/S 37S) 1.4 (B/C/- 372) 1.4 (B/C/S 373) 1.4 T (B/C/- 375) 1.6 D (B/C/S 374) 1.7 (B/C/- 376) 1.7 i (B/C/- 37F)	40 44 44 40 59 55	01.86 01.83 01.83 01.84 01.84 01.84 01.85	09.86 12.86 09.86 09.86 09.86 08.86 09.86	24.3222-1709.3 24.3222-1710.3 24.3222-1107.3	020111 020112 020262	<input type="checkbox"/> <input type="checkbox"/> <input type="checkbox"/>	Rz 22,20 Rz 22,20 Rz 22,20	BDX BDX TRW	
	1.2 (B/C/S 37S) 1.4 (B/C/- 37C) 1.4 (B/C/- 37R) 1.4 (B/C/S 373) 1.4 i (B/C/- 37A) 1.4 T (B/C/- 375) 1.6 D (B/C/S 374) 1.7 (B/C/- 376) 1.7 (B/C/- 37D) 1.7 (B/C/- 37L) 1.7 (B/C/- 37N) 1.7 i (B/C/- 37E) 1.7 i (B/C/- 37F)	40 44 49 49 40 59 64 54 65 69 55	10.86 10.86 06.87 10.86 06.87 10.86 10.86 09.86 06.87 10.86 10.86 10.86 10.86	11.89 11.89 11.89 11.89 11.89 11.89 11.89 06.87 11.89 11.89 11.89 11.89 11.89	24.3220-1603.3 24.3220-1604.3 24.3222-1107.3	020230 020231 020262	<input type="checkbox"/> <input type="checkbox"/> <input type="checkbox"/>	RzR 20,64 RzR 20,64 Rz 22,20	BDX BDX TRW	
	1.1 (B/C/S 371) 1.2 (B/C/S 37S) 1.4 (B/C/- 37C) 1.4 (B/C/- 37R) 1.4 (B/C/S 373) 1.4 i (B/C/- 37A) 1.6 D (B/C/S 374) 1.7 (B/C/- 376) 1.7 (B/C/- 37D) 1.7 (B/C/- 37L) 1.7 (B/C/- 37N) 1.7 i (B/C/- 37E) 1.7 i (B/C/- 37F)	35 40 44 49 49 40 59 64 54 65 69 55	01.83 01.86 10.86 06.87 10.86 06.87 10.86 09.86 06.87 10.86 10.86 10.86 10.86	06.87 11.89 11.89 11.89 11.89 11.89 11.89 06.87 11.89 11.89 11.89 11.89 11.89	03.0137-0209.2 03.0137-0203.2 03.0137-0201.2 03.0137-9086.2 03.0137-9055.2 03.0137-9056.2	650209 650203 650201 669086 669055 669056	- autom. Nachstellung ¹⁾ + autom. Nachstellung ²⁾	180 x 42 180 x 42 AUT 180 x 41 HEB Bremsbacken-Zubehör Bremsbacken-Zubehör Bremsbacken-Zubehör	BDX BDX TRW BDX BDX TRW	









































¹⁾ - automatic adjustment / - correzione automatica / - ajustage automatique / - reajuste automatico
²⁾ + automatic adjustment / + correzione automatica / + ajustage automatique / + reajuste automático



								
RENAULT R11 (83-89)								
	1.7 (B/C/- 37N) 1.7 i (B/C/- 37E) 1.7 i (B/C/- 37F)	65 69 55		10.86 11.89 10.86 11.89 01.85 11.89		03.0137-0209.2 650209 03.0137-0203.2 650203 03.0137-0201.2 650201 03.0137-9086.2 669086 03.0137-9055.2 669055 03.0137-9056.2 669056	- autom. Nachstellung ¹⁾ + autom. Nachstellung ²⁾	180 x 42 BDX 180 x 42 AUT BDX 180 x 41 HEB TRW Bremsbacken-Zubehör BDX Bremsbacken-Zubehör BDX Bremsbacken-Zubehör TRW
	1.1 (B/C/S 371) 1.2 (B/C/S 37S) 1.4 (B/C/- 37C) 1.4 (B/C/- 37R) 1.4 (B/C/S 373) 1.4 i (B/C/- 37A) 1.6 D (B/C/S 374) 1.7 (B/C/- 376) 1.7 (B/C/- 37D) 1.7 (B/C/- 37L) 1.7 (B/C/- 37N) 1.7 i (B/C/- 37E) 1.7 i (B/C/- 37F)	35 40 44 49 40 40 59 64 54 65 69 55		01.83 06.87 10.86 11.89 10.86 11.89 06.87 11.89 10.86 11.89 06.87 11.89 10.86 11.89 09.86 06.87 06.87 11.89 10.86 11.89 10.86 11.89 01.85 11.89		24.0218-0032.1 480118 24.0218-0732.2 480207		180/181 x 53,5 - Lager 180/181 x 53,5 + Lager
	1.1 (B/C/S 371) 1.1 (B/C/S 371) 1.2 (B/C/S 37S) 1.4 (B/C/- 372) 1.4 (B/C/S 373) 1.4 T (B/C/- 375) 1.6 D (B/C/S 374) 1.7 (B/C/- 376) 1.7 i (B/C/- 37F)	35 35 40 44 40 40 59 55		01.83 09.86 10.86 06.87 01.86 09.86 01.83 12.86 01.83 09.86 01.84 09.86 01.84 09.86 01.84 09.86 01.85 09.86		03.0520-1117.3 691117 03.0520-0922.3 690922 03.0520-0922.3 690922 03.0520-1122.3 691122	+ autom. Nachstellung ²⁾ + autom. Nachstellung ²⁾	17,46/180x42 TopKit BDX 22,20/180x42 TopKit BDX 22,20/180x42 TopKit BDX 22,20/180x41 TopKit TRW
	1.2 (B/C/S 37S) 1.4 (B/C/- 37C) 1.4 (B/C/- 37R) 1.4 (B/C/S 373) 1.4 i (B/C/- 37A) 1.6 D (B/C/S 374) 1.7 (B/C/- 376) 1.7 (B/C/- 37D) 1.7 (B/C/- 37L) 1.7 (B/C/- 37N) 1.7 i (B/C/- 37E) 1.7 i (B/C/- 37F)	40 44 49 40 40 59 64 54 65 69 55		10.86 11.89 10.86 11.89 06.87 11.89 10.86 11.89 06.87 11.89 10.86 11.89 10.86 06.87 06.87 11.89 10.86 11.89 10.86 11.89 10.86 11.89 10.86 11.89		03.0520-0920.3 690920 03.0520-1122.3 691122		20,64/180x42 TopKit BDX 22,20/180x41 TopKit TRW

RENAULT R12 (70-80)									
	1.3 (R1170) 1.3 (R1170) 1.3 (R1170) 1.3 (R1170) 1.3 (R1170) 1.3 (R1177) 1.3 (R1177) 1.3 (R1177) 1.3 (R1177) 1.3 (R1177) 1.3 (R1177) 1.3 (R1330) 1.3 (R1330) 1.3 (R1330) 1.3 (R1330) 1.3 (R1337) 1.3 (R1337) 1.3 (R1337) 1.3 (R1337) 1.3 (R1337) 1.3 (R2360) 1.3 (R2360) 1.3 (R2360) 1.3 (R2360) 1.3 (R2360) 1.4 (R1179) 1.4 (R1338)	1396401 1281821 1281821 1460412 1624301 0266701 0266701 0331341 0331643 0382301 0262013 0262013 0317821 0375981 0028396 0031001 0035168 0028396 0035155 0003887 0006151 0006114 0003887 0009201 0002937 0001975	1403219 1396327 0312522 0301630 0033533 0004984	+ F + F 12.80 - D 12.80 + A B CH DK N 12.80 + D GB TR 12.80 + P + F 12.79 + F B A CH 12.79 + DK N 12.79 + D GB TR 12.79 + F 12.79 + P MA + F 12.80 + B A DK N IL 12.80 + F 12.80 + P + F / + Automatikgetriebe ³⁾ 12.80 + F B / + Schaltgetriebe ⁴⁾ 12.80 + F / + Automatikgetriebe ³⁾ 12.80 + B CH DK IL / + Automatik. ⁵⁾ 12.80 + GB TR + F 12.80 + F 12.80 + GB 12.80 + B DK MA IL 12.80 + RA BR C 12.80 + S 12.80 + S		03.2119-0781.3 010052		1Hz 19,05	ATE
	1.3 (R1170) 1.3 (R1170) 1.3 (R1330) 1.4 (R1179) 1.4 (R1338)	1460412 0317359 0009901	1624841 0376767 0007424 0017282	01.70 12.80 + MEX 01.76 + CHN + CHN		13.0460-3928.2 603928		20140 14,0 +/-WE BDX	
	1.3 (R1170) 1.3 (R1330) 1.3 (R1337) 1.3 (R2360) 1.4 (R1179) 1.4 (R1338)			01.70 12.80 01.72 12.80 01.74 12.80 01.76 12.80 01.76 12.80 01.76 12.80		24.0110-0139.1 410139		228 10,0 9,0	
	1.6 (R1173)			01.71 12.74		24.0110-0139.1 410139		228 10,0 9,0	
	1.3 (R1330) Kombi 1.3 (R1337) Kombi			01.76 12.80 01.76 12.80		24.3222-1125.3 020356		Rz 22,20	

¹⁾ - automatic adjustment / - correzione automatica / - ajustage automatique / - reajuste automatico
²⁾ + automatic adjustment / + correzione automatica / + ajustage automatique / + reajuste automatico
³⁾ + F / + autom.transmission / + F / + scatola cambio autom. / + F / + transmission automatique / + F / + cambio automatico
⁴⁾ + F B / + manual transm. / + F B / + scatola camb.velocità / + F B / + transmission mécanique / + F B / + cambio de velocidad
⁵⁾ + B CH DK IL / + autom.transm. / + B CH DK IL / + scat.camb.autom. / + B CH DK IL / + transm.autom. / + B CH DK IL / + camb.autom.

RENAULT R12 (70-80)									
	1.3 (R2360) 1.4 (R1179) 1.4 (R1338) Kombi	0007115	01.76 12.80 01.76	12.80 12.80 +  12.80	24.3222-1125.3	020356		Rz 22,20	
	1.3 (R1330) 1.3 (R1337) 1.3 (R2360) 1.4 (R1338)		01.76 01.76 01.76 01.76	12.80 12.80 12.80 12.80	03.0137-0124.2 03.0137-0139.2 03.0137-9020.2	650124 650139 669020		229 x 42 HEB AUT 229 x 42 Bremsbacken-Zubehör	BDX BDX BDX
RENAULT R14 (76-83)									
	1.2 (R1210) 1.2 TL/GTL (R1210) 1.4 (R1212) 1.4 (R1212) 1.4 (R1213)	0570870 0083700	01.76 01.76 01.80 01.80 01.82	+  12.83 -  +  12.83 -  12.83 - 	03.2119-0781.3	010052		Thz 19,05	ATE
	1.2 (R1210) 1.4 (R1212) 1.4 (R1213)		01.76 01.80 01.82	12.83 12.83 12.83	13.0460-3928.2	603928		20140 14,0 +/WE	BDX
	1.2 (R1210) 1.4 (R1212) 1.4 (R1213)		01.76 01.80 01.82	12.83 12.83 12.83	24.3222-1709.3 24.3222-1710.3 24.3222-1107.3	020111 020112 020262	  	Rz 22,20 Rz 22,20 Rz 22,20	BDX BDX TRW
RENAULT R15 (72-79)									
	1.3 (R1300)	0126200	12.79		03.2119-0781.3	010052		Thz 19,05	ATE
	1.3 (R1300) 1.6 (R1304) 1.6 (R1308)		01.72 01.72 01.72	12.79 12.76 +  12.76 + 	13.0460-3928.2	603928		20140 14,0 +/WE	BDX
	1.3 (R1300) 1.6 (R1304) 1.6 (R1308)		01.72 01.72 01.72	12.79 12.76 +  12.76 + 	24.0110-0139.1	410139		228 10,0 9,0	
RENAULT R16 (68-80)									
	1.6 (R1152) 1.6 (R1153) 1.6 (R1155) 1.6 (R1157)		01.68 01.69 01.75 01.77	12.80 +  12.79 +  12.79 +  12.79 + 	24.3222-1125.3	020356		Rz 22,20	
	1.6 (R1152) 1.6 (R1153) 1.6 (R1155) 1.6 (R1156) 1.6 (R1157)		01.72 01.72 01.75 01.74 01.77	12.80 12.80 12.79 12.80 12.79	03.0137-0271.2 03.0137-9027.2	650271 669027		229 x 42 HEB Bremsbacken-Zubehör	TRW TRW
RENAULT R17 (72-80)									
	1.6 (R1312) 1.6 (R1314) 1.6 (R1316) 1.6 (R1317) 1.6 (R1318) 1.6 (R1322) 1.6 (R1323) 1.6 (R1324) 1.6 (R1326) 1.6 (R1327) 1.6 (R1328)	0008153 0030470	01.72 01.72 01.72 01.76 01.72 01.72 01.72 01.72 01.76 01.76 01.76	12.75 12.75 12.78 12.80 12.76 12.77 12.75 12.80 12.78 12.78 12.78	13.0460-3928.2	603928		20140 14,0 +/WE	BDX
	1.6 (R1313) 1.6 (R1316) 1.6 (R1323) 1.6 (R1326)	0007371 0001511	01.72	12.76 +  12.75 12.77 +  12.80	24.0110-0139.1	410139		228 10,0 9,0	
	1.6 (R1313) 1.6 (R1317) 1.6 (R1327) 1.6 TS (R1323)		01.72 01.72 01.72 01.72	12.76 -   12.80 12.80 12.77	13.0460-3961.2	603961		20336 14,0 +/WK	BDX
	1.6 (R1313) 1.6 (R1317) 1.6 (R1327) 1.6 TS (R1323)		01.72 01.72 01.72 01.72	12.76 -   12.80 12.80 12.77	24.0110-0139.1	410139		228 10,0 9,0	
	1.6 (R1312) 1.6 (R1313) 1.6 (R1316) 1.6 (R1318) 1.6 (R1322) 1.6 (R1326) 1.6 (R1328) 1.6 (R1328) 1.6 TL (R1323)		01.72 01.72 01.72 01.76 01.72 01.72 01.76 01.79 01.72	12.76 12.76 12.75 12.80 12.76 12.80 12.78 12.80 12.77	24.3222-1125.3	020356		Rz 22,20	
RENAULT R18 Kasten (79-86)									
	1.4 (R2350) 2.1 D (R2354)	47 49	01.82 01.82	07.86 07.86	03.2119-0781.3 03.2119-1281.3	010052 010054		Thz 19,05 Thz 19,05	ATE ATE
	1.4 (R2350)	47	01.83	07.86	13.0460-3911.2 13.0460-2834.2 13.0460-0411.2	603911 602834 610411		20905 18,0 +/WK 21463 18,0 /WK/S Belagsatz-Zubehör	BDX TRW BDX

RENAULT R18 Kasten (79-86)										
	2.1 D (R2354)	49		01.83	07.86	13.0460-3911.2 13.0460-0411.2	603911 610411		20905 18,0 +WK Belagsatz-Zubehör	BDX BDX
	1.4 (R2350)	47		01.82	12.83	24.0110-0139.1	410139		228 10,0 9,0	
	2.1 D (R2354)	49		11.81	07.86	24.5112-0385.3	330392	2	L=385	
	1.4 (R2350) 2.1 D (R2354)	47 49		05.79 11.81	07.86 07.86	24.5112-0220.3	330613	2	L=220	
	1.4 (R2350) 2.1 D (R2354)	47 49		01.82 11.81	07.86 07.86	24.3222-1118.3	020315		Rz 22,20	BDX
	1.4 (R2350) 2.1 D (R2354)	47 49		01.82 11.81	07.86 07.86	03.0137-0124.2 03.0137-9020.2	650124 669020		229 x 42 HEB AUT Bremsbacken-Zubehör	BDX BDX
	1.4 (R2350) 2.1 D (R2354)	47 49		01.82 11.81	07.86 07.86	03.0520-3122.3	693122		22,20/229x42 TopKit	BDX
RENAULT R18 Limousine (78-86)										
	1.4 (R1340) 1.4 (R1340) 1.6 (R1341) 1.6 (R1341) 1.6 (R1341) 1.6 (R1341) 2.1 D (R1344)	47 47 54 54 58 58 49	0346651 0262801 0262801	04.78 04.78 04.82 04.82 04.78 04.78 05.82	07.86 07.86 07.86 07.86 09.82 07.86 07.86	+ CH - CH + CH - CH + CH - CH + E	03.2119-0781.3	010052	THz 19,05	ATE
	2.1 D (R1344) 2.1 D (R1346)	49 53		11.81 11.81	07.86 07.86	- E	03.2119-1281.3	010054	THz 19,05	ATE
	1.6 TS (R1342) 1.6 Turbo (R1345) 1.6 Turbo (R1345) 2.0 (R1343)	71 80 92 77		05.82 10.80 10.82 05.82	12.82 09.82 12.82 12.82		24.3541-1625.5 24.3541-1626.5	240045 240046	D=54, - Halter D=54, - Halter	TRW TRW
	1.4 (R1340) 1.6 (R1341) 1.6 TS (R1342) 1.6 Turbo (R1345) 2.0 (R1343) 2.1 D (R1344) 2.1 D (R1346)	47 54 71 92 77 49 53		01.83 01.83 01.83 01.83 01.83 01.83 11.81	07.86 07.86 07.86 07.86 07.86 07.86 07.86		24.3541-1625.5 24.3541-1626.5	240045 240046	D=54, - Halter D=54, - Halter	TRW TRW
	1.4 (R1340) 1.6 (R1341) 2.0 (R1343) 2.1 D (R1344) 2.1 D (R1346)	47 54 77 49 53		01.83 01.83 01.83 01.83 11.81	07.86 07.86 07.86 07.86 07.86		13.0460-3911.2 13.0460-2834.2 13.0460-0411.2	603911 602834 610411	20905 18,0 +WK 21463 18,0 /WK/S Belagsatz-Zubehör	BDX TRW BDX
	1.6 TS (R1342) 1.6 Turbo (R1345)	71 92		01.83 01.83	07.86 07.86		13.0460-2834.2	602834	21463 18,0 /WK/S	TRW
	1.4 (R1340) 1.6 (R1341) 1.6 (R1341)	47 54 58	0534400 0504400 0504400	04.78 04.82 04.78	07.86 07.86 07.86	+ CBN USA + CBN USA + CBN USA	24.0110-0139.1	410139	228 10,0 9,0	
	1.4 (R1340) 1.6 (R1341) 1.6 (R1341)	47 54 58	0534401 0504401 0504401	07.86 07.86 09.82	07.86 07.86 07.86	+ CBN USA + CBN USA + CBN USA	24.0120-0126.1	420126	259 20,2 17,7 V +B	
	1.6 TS (R1342) 1.6 Turbo (R1345) 1.6 Turbo (R1345) 2.0 (R1343) 2.1 D (R1344) 2.1 D (R1346)	71 80 92 77 49 53		05.82 10.80 10.82 05.82 11.81 11.83	07.86 09.82 07.86 07.86 07.86 07.86		24.5112-0385.3	330392	L=385	
	1.6 Turbo (R1345) 1.6 Turbo (R1345)	80 92		10.80 10.82	09.82 07.86		13.0460-3961.2	603961	20336 14,0 +WK	BDX
	1.6 Turbo (R1345) 1.6 Turbo (R1345)	80 92		10.80 10.82	09.82 07.86		24.0112-0134.1	412134	254 12,0 10,5	
	1.4 (R1340) 1.6 (R1341) 1.6 (R1341) 1.6 TS (R1342) 1.6 Turbo (R1345) 1.6 Turbo (R1345) 2.0 (R1343) 2.1 D (R1344) 2.1 D (R1346)	47 54 58 71 80 92 77 49 53		04.78 04.82 04.78 05.82 10.80 10.82 05.82 11.81 11.81	07.86 07.86 09.82 07.86 07.86 07.86 07.86 07.86 07.86		24.5112-0220.3	330613	L=220	
	1.4 (R1340) 1.6 (R1341) 1.6 (R1341) 1.6 TS (R1342) 2.1 D (R1344)	47 54 58 71 49	0534400 0504400 0504400 0024200	04.78 04.82 04.78 05.82 11.81	07.86 07.86 07.86 07.86 07.86		24.3222-1710.3 24.3222-1709.3 24.3222-1107.3	020112 020111 020262	Rz 22,20 Rz 22,20 Rz 22,20	BDX BDX TRW
	1.4 (R1340) 1.6 (R1341)	47 54	0534401 0504401	07.86 07.86	07.86 07.86		24.3222-1710.3 24.3222-1107.3	020112 020262	Rz 22,20 Rz 22,20	BDX TRW



RENAULT R18 Variable (79-86)

	1.4 (R1350)	47	05.79	12.82	03.0137-0124.2 03.0137-9020.2	650124 669020		229 x 42 HEB AUT Bremsbacken-Zubehör	BDX BDX
	1.6 (R1351)	54	01.82	07.86					
	1.6 (R1351)	58	05.79	09.82					
	1.6 4x4 (R1351)	54	01.83	07.86					
	1.6 TS (R1352)	71	05.82	07.86					
	1.6 Turbo (R1355)	80	09.82	12.82					
	1.6 Turbo (R1355)	92	10.82	12.82					
	2.0 (R1353)	77	10.81	07.86					
	2.0 4x4 (R1353)	76	05.83	12.86					
	2.1 D (R1354)	49	11.80	07.86					
2.1 D (R1356)	53	05.79	07.86						
	1.4 (R1350)	47	05.79	07.86	03.0520-3122.3	693122		22,20/229x42 TopKit	BDX
	1.6 (R1351)	54	01.82	07.86					
	1.6 (R1351)	58	05.79	09.82					
	1.6 4x4 (R1351)	54	01.83	07.86					
	1.6 TS (R1352)	71	05.82	07.86					
	1.6 Turbo (R1355)	80	09.82	12.82					
	1.6 Turbo (R1355)	92	10.82	12.82					
	2.0 (R1353)	77	10.81	07.86					
	2.0 4x4 (R1353)	76	05.83	12.86					
	2.1 D (R1354)	49	11.80	07.86					
2.1 D (R1356)	53	05.79	07.86						

RENAULT R19 (3/5-tuerig) (B53/C53/S53_) (88-95)

	1.2	40	09.88	01.92	03.2119-3389.3	010057		Thz 19,05	ATE
	1.4	43	09.88	01.92					
	1.4 (B/C/S537)	59	09.88	01.92					
	1.4 (B/C53A)	59	09.90	01.92 - ABS					
	1.4 (B537)	59	02.92	12.95 + Fahrschule 1)					
	1.4 (B53A)	59	02.92	12.95 - ABS/ + Fahrschule 2)					
	1.4 (B53H)	59	06.89	12.95					
	1.7	66	09.88	01.92 - ABS					
	1.7	66	02.92	12.95 - ABS/ + Fahrschule 2)					
	1.7 (B/C533)	54	09.88	01.92 - ABS					
	1.7 (B533)	54	02.92	12.95 - ABS/ + Fahrschule 2)					
	1.7 (B536/E)	54	09.88	12.95					
	1.7 (B53M)	54	09.88	12.95 - ABS					
	1.9 D (B/C534/J)	47	09.88	01.92 - ABS					
	1.9 D (S534/J)	47	09.88	01.92					
	1.9 dT (B/C53K)	66	09.90	01.92 - ABS					
	1.9 dT (B53K)	66	02.92	12.95 - ABS/ + Fahrschule 2)					
1.9 dT (S53K)	66	04.91	01.92						
	1.2	40	02.92	12.95	03.2120-2031.3	010106		Thz 20,64	ATE
	1.4	43	02.92	12.95					
	1.4 (B/C535)	55	09.94	12.95 - ABS					
	1.4 (B537)	59	02.92	12.95 - Fahrschule 3)					
	1.4 (B53A)	59	02.92	12.95 - ABS/ - Fahrschule 4)					
	1.4 (B53G)	59	05.92	12.95					
	1.4 (C/S537)	59	02.92	12.95					
	1.4 (C53A)	59	02.92	12.95 - ABS					
	1.7 (B533)	54	02.92	12.95 - ABS/ - Fahrschule 4)					
	1.7 (B53B)	54	02.92	12.95 - ABS/ - Fahrschule 4)					
	1.7 (B53C/F)	54	02.92	12.95 - ABS/ - Fahrschule 4)					
	1.7 (C533)	54	02.92	12.95 - ABS					
	1.7 (C53B)	54	02.92	12.95 - ABS					
	1.7 (C53C/F)	54	02.92	12.95 - ABS					
	1.8	65	05.92	12.95 - ABS					
	1.8 (B/C53V/553H)	66	09.94	12.95					
	1.8 (B553A/C/D/F)	66	09.94	12.95 - ABS					
	1.8 (C353A/C/D/F)	66	09.94	12.95 - ABS					
	1.8 16V	99	09.88	12.95 - ABS					
	1.9 D (B/C531)	47	05.92	12.95 - ABS					
	1.9 D (B534/J)	47	02.92	12.95 - ABS/ - Fahrschule 4)					
	1.9 D (C534/J)	47	02.92	12.95 - ABS					
	1.9 D (C534/J)	47	02.92	12.95					
	1.9 D (S531)	47	05.92	12.95					
	1.9 dT (B/C53T)	66	05.92	12.95					
	1.9 dT (B53K)	66	02.92	12.95 - ABS/ - Fahrschule 4)					
	1.9 dT (C53K)	66	02.92	12.95 - ABS					
1.9 dT (S53K)	66	02.92	12.95						
	1.4	55	09.94	12.95 + ABS/ + Schaltgetriebe 5)	24.2120-1725.3	010579		Thz 20,64	BDX
	1.7	54	09.88	12.95 + ABS/ + Schaltgetriebe 5)					
	1.7	66	09.88	12.95 + ABS/ + Schaltgetriebe 5)					
	1.8	65	05.92	12.95 + ABS/ + Schaltgetriebe 5)					
	1.8	66	09.94	12.95 + ABS/ + Schaltgetriebe 5)					
	1.8	81	10.91	12.95 + ABS/ + Schaltgetriebe 5)					
	1.8 16V (B/C539)	99	09.88	12.95 + ABS/ + Schaltgetriebe 5)					
	1.8 16V (B/C53D)	99	06.89	12.95 + ABS/ + Schaltgetriebe 5)					
	1.9 D (B/C534/J)	47	09.88	12.95 + ABS/ + Schaltgetriebe 5)					
	1.9 dT	66	10.95	12.95 + ABS/ + Schaltgetriebe 5)					
1.9 dT (B/C53T)	66	10.95	12.95 + ABS/ + Schaltgetriebe 5)						

1) + driving school / + scuola guida / + auto école / + autoescuela
 2) - ABS/ + driving school / - ABS/ + scuola guida / - ABS/ + auto école / - ABS/ + autoescuela
 3) - driving school / - scuola guida / - auto école / - autoescuela
 4) - ABS/ - driving school / - ABS/ - scuola guida / - ABS/ - auto école / - ABS/ - autoescuela
 5) + ABS/ + manual transm. / + ABS/+ scatola camb.velocità / + ABS/ + transmission mécanique / + ABS/ + cambio de velocidad



RENAULT R19 (3/5-tuerig) (B53/C53/S53_) (88-95)

	1.2	40	09.88	12.95		24.3481-1505.5	240047		D=48, - Halter	BDX		
	1.4	43	09.88	12.95		24.3481-1506.5	240048		D=48, - Halter	BDX		
	1.4 (B/C535)	55	09.94	12.95		24.3481-1611.5	240029		D=48, - Halter	TRW		
	1.7 (B/C536/E)		09.88	12.95		24.3481-1612.5	240030		D=48, - Halter	TRW		
	1.9 D (B/C/S531)	47	05.92	12.95		24.0101-4803.2	260049		Bremssattel-Zubehör	BDX		
	1.9 D (B/C534/J)	47	09.88	12.95	- ABS	24.0101-4807.2	260053		Bremssattel-Zubehör	TRW		
	1.9 D (B/C534/J)	47	10.91	12.95	+ ABS							
	1.9 D (S534/J)	47	09.88	12.95								
	1.4 (B/C53A)	59	09.90	12.95		24.3481-1505.5	240047		D=48, - Halter	BDX		
	1.7 (B/C53B)	54	09.88	12.95		24.3481-1506.5	240048		D=48, - Halter	BDX		
						24.0101-4803.2	260049		Bremssattel-Zubehör	BDX		
	1.4 (B/C53A)	59	09.90	12.95	- ABS	24.3481-1611.5	240029		D=48, - Halter	TRW		
	1.4 (B/C53A)	59	09.90	12.94	+ ABS	24.3481-1612.5	240030		D=48, - Halter	TRW		
	1.4 (B/C53A)	59	09.90	12.95		24.0101-4807.2	260053		Bremssattel-Zubehör	TRW		
	1.7 (B/C53B)	54	09.88	12.95	- ABS							
	1.7 (B/C53B)	54	09.88	12.94	+ ABS/ + Automatikgetriebe ¹⁾							
	1.7 (B/C53B)	54	09.88	12.95	+ Schaltgetriebe ²⁾							
	1.7 (B/C53M)	54	09.88	12.95								
	1.4 (B/C53A)	59	01.95	12.95	+ ABS/ + Automatikgetriebe ¹⁾	24.3481-1615.5	240031		D=48, - Halter	TRW		
	1.7 (B/C533)	54	09.88	12.95		24.3481-1616.5	240032		D=48, - Halter	TRW		
	1.7 (B/C53B)	54	01.95	12.95	+ ABS/ + Automatikgetriebe ¹⁾	24.0101-4806.2	260052		Bremssattel-Zubehör	TRW		
	1.7 (B/C53C/F)		09.88	12.95								
	1.8	65	05.92	12.95								
	1.8	66	09.94	12.95								
	1.8	81	10.91	12.95								
	1.8 16V	99	09.88	12.95								
	1.9 D (B/C534/J)	47	09.88	09.91	+ ABS							
	1.9 dT	66	09.90	12.95								
	1.9 dT (B/C53T)	66	05.92	12.95								
		1.2	40	09.88	12.95		13.0460-3911.2		603911		20905 18,0 +WK	BDX
1.4		43	09.88	12.95		13.0460-2834.2	602834	21463 18,0 /WK/S	TRW			
1.4 (B/C535)		55	09.94	12.95		13.0460-0411.2	610411	Belagsatz-Zubehör	BDX			
1.7 (B/C536/E)			09.88	12.95								
1.9 D (B/C/S531)		47	05.92	12.95								
1.9 D (B/C534/J)		47	09.88	12.95	- ABS							
1.9 D (B/C534/J)		47	10.91	12.95	+ ABS							
1.9 D (S534/J)		47	09.88	12.95								
1.4 (B/C53A)		59	09.90	12.95		13.0460-3911.2	603911	20905 18,0 +WK	BDX			
1.7 (B/C53B)		54	09.88	12.95		13.0460-0411.2	610411	Belagsatz-Zubehör	BDX			
1.4 (B/C53A)		59	09.90	12.95	- ABS	13.0460-2834.2	602834	21463 18,0 /WK/S	TRW			
1.4 (B/C53A)		59	09.90	12.94	+ ABS/ + Automatikgetriebe ¹⁾							
1.4 (B/C53A)		59	09.90	12.95	+ Schaltgetriebe ²⁾							
1.7 (B/C53B)		54	09.88	12.95	- ABS							
1.7 (B/C53B)		54	09.88	12.94	+ ABS/ + Automatikgetriebe ¹⁾							
1.7 (B/C53B)		54	09.88	12.95	+ Schaltgetriebe ²⁾							
1.7 (B/C53M)		54	09.88	12.95								
1.4 (B/C53A)		59	01.95	12.95	+ ABS/ + Automatikgetriebe ¹⁾	13.0460-2834.2	602834	21463 18,0 /WK/S	TRW			
1.7 (B/C533)		54	09.88	12.95								
1.7 (B/C53B)		54	01.95	12.95	+ ABS/ + Automatikgetriebe ¹⁾							
1.7 (B/C53C/F)			09.88	12.95								
1.8		65	05.92	12.95								
1.8		66	09.94	12.95								
1.8 (B/C53B)			10.91	12.95								
1.8 16V		99	09.88	12.95								
1.9 D (B/C534/J)		47	09.88	09.91	+ ABS							
1.9 dT		66	09.90	12.95								
1.9 dT (B/C53T)		66	05.92	12.95								
		1.2	40	09.88	12.95		24.0112-0116.1	412116			238 12,0 10,5 +S +B	
		1.4	43	09.88	12.95							
	1.4 (B/C535)	55	09.94	12.95								
	1.4 (B/C53A)	59	09.90	12.95	- ABS/ + Automatikgetriebe ³⁾							
	1.4 (B/C53A)	59	09.90	12.94	+ ABS/ + Automatikgetriebe ¹⁾							
	1.4 (B/C53A)	59	09.90	12.95	+ Schaltgetriebe ²⁾							
	1.7 (B/C536/E)		09.88	12.95								
	1.7 (B/C53B)	54	09.88	12.95	- ABS/ + Automatikgetriebe ³⁾							
	1.7 (B/C53B)	54	09.88	12.94	+ ABS/ + Automatikgetriebe ¹⁾							
	1.7 (B/C53B)	54	09.88	12.95	+ ABS/ + Schaltgetriebe ⁴⁾							
	1.9 D (B/C/S531)	47	05.92	12.95								
	1.9 D (B/C534/J)	47	09.88	12.95	- ABS							
	1.9 D (B/C534/J)	47	10.91	12.95	+ ABS							
	1.9 D (S534/J)	47	09.88	12.95								
	1.7 (B/C533)	54	09.88	12.95	- ABS/ + Automatikgetriebe ³⁾	24.0120-0125.1	420125	238 20,1 17,7 V +S +B				
	1.7 (B/C533)	54	09.88	12.94	+ ABS/ + Automatikgetriebe ¹⁾							
	1.7 (B/C533)	54	09.88	12.95	+ Schaltgetriebe ²⁾							
	1.7 (B/C53C)	66	09.88	12.95	- ABS/ + Automatikgetriebe ³⁾							
	1.7 (B/C53C)	66	09.88	12.94	+ ABS/ + Automatikgetriebe ¹⁾							
	1.7 (B/C53C)	66	09.88	12.95	+ Schaltgetriebe ²⁾							
1.7 (B/C53F)		09.90	12.95									
1.7 (B/C53M)	54	09.88	12.95									
1.8 (353/535F)	79	09.94	12.94	+ ABS								
1.8 (353/535F)	66	09.94	12.95	- ABS								
1.8 (B/C53V)	66	09.94	12.95	- ABS								
1.8 (B/C53V)	66	09.94	12.94	+ ABS								
1.8 (B/C53Y)	65	05.92	12.95	+ Schaltgetriebe ²⁾								
1.8 4x4 (B/C53Y)	65	05.92	12.95	- ABS								
1.8 4x4 (B/C53Y)	65	05.92	12.94	+ ABS								

¹⁾ + ABS/ + autom.transmission / + ABS/ + scatola cambio autom. / + ABS/ + transmission automatique / + ABS/ + cambio automático
²⁾ + manual transmission / + scatola cambio velocità / + transmission mécanique / + cambio de velocidad
³⁾ - ABS/ + autom.transmission / - ABS/ + scatola cambio autom. / - ABS/ + transmission automatique / - ABS/ + cambio automático
⁴⁾ + ABS/ + manual transm. / + ABS/+ scatola camb.velocità / + ABS/ + transmission mécanique / + ABS/ + cambio de velocidad



RENAULT R19 (3/5-tuerig) (B53/C53/S53_) (88-95)

	1.9 D (B/C534/J) 47 1.9 dT (B/C53K) 66 1.9 dT (B/C53K) 66 1.9 dT (B/C53T) 66 1.9 dT (B/C53T) 66 1.9 dT (S53K) 66		09.88 09.91 + ABS 09.90 12.95 - ABS 09.90 12.94 + ABS 05.92 12.95 - ABS 05.92 12.94 + ABS 04.91 12.95	24.0120-0125.1 420125			238 20,1 17,7 V +S +B
	1.4 (B/C53A) 59 1.7 (B/C533) 54 1.7 (B/C53C) 66 1.8 (353/553F) 66 1.8 (353A/C/D) 66 1.8 (553A/C/D/H) 66 1.8 (B/C/538) 66 1.8 (B/C/53V) 66 1.8 16V 99 1.8 4x4 (B/C53Y) 65 1.9 dT (B/C53K) 66 1.9 dT (B/C53T) 66		01.95 12.95 + ABS/ + Automatikgetriebe ¹⁾ 01.95 12.95 + ABS/ + Automatikgetriebe ¹⁾ 01.95 12.95 + ABS/ + Automatikgetriebe ¹⁾ 01.95 12.95 + ABS 09.94 12.95 09.94 12.95 10.91 12.95 01.95 12.95 + ABS 09.88 12.95 01.95 12.95 + ABS 01.95 12.95 + ABS 01.95 12.95 + ABS	24.0121-0106.1 421106			259 20,6 17,7 V +S +B
	1.2 40 1.4 43 1.4 (B/C535) 55 1.7 54 1.7 66 1.7 66 1.8 65 1.8 66 1.8 81 1.8 16V 99 1.9 D 47 1.9 dT 66		09.88 12.95 09.88 12.95 09.90 12.95 09.88 12.95 09.88 12.95 09.88 12.95 05.92 12.95 09.94 12.95 10.91 12.95 09.88 12.95 09.88 12.95 09.90 12.95	24.5111-0280.3 330389	2		L=280
	1.4 (B/C535) 55 1.7 54 1.7 66 1.7 79 1.8 65 1.8 66 1.8 79 1.8 81 1.8 16V 99 1.9 D 47 1.9 dT 66		09.94 12.95 + ABS 09.88 12.95 + ABS 09.88 12.95 + ABS 05.92 09.94 + ABS 05.92 12.95 + ABS 09.94 12.95 + ABS 09.94 12.95 + ABS 10.91 12.95 + ABS 09.88 12.95 09.88 12.95 + ABS 09.90 12.95 + ABS	13.0460-3822.2 603822			21597 11,0 +/S BDX
	1.4 (B/C535) 55 1.7 79 1.7 (B/C533) 54 1.7 (B/C53F) 54 1.7 (B/C53M) 54 1.7 (C53C/F) 54 1.8 79 1.8 81 1.8 (353/553F) 66 1.8 (B/C53V) 66 1.8 (B/C53Y) 65 1.8 (B553A/C/D) 66 1.8 (C353A/C/D) 66 1.8 16V (B/C539) 99 1.8 16V (B/C53D) 99 1.8 16V (B/C53D) 99 1.9 D (B/C534) 47 1.9 D (B/C531/J) 47 1.9 dT (B/C53K) 66 1.9 dT (B/C53T) 66		09.94 12.95 + ABS 05.92 09.94 + ABS 09.88 12.95 + ABS 06.89 12.95 + ABS 09.88 12.95 + ABS 09.88 12.95 + ABS 09.94 12.95 + ABS 10.91 12.95 + ABS 11.94 12.95 + ABS 09.94 12.95 + ABS 05.92 12.95 + ABS 09.94 12.95 + ABS 09.94 12.95 + ABS 09.94 12.95 + ABS 06.89 12.95 05.93 12.95 + Klimaanlage ³⁾ 09.88 12.95 + ABS 09.90 12.95 + ABS 09.90 12.95 + ABS 05.92 12.95 + ABS	24.0108-0108.1 408108		ohne Sensorring ²⁾	238 8,0 7,0 +B
	1.2 40 1.4 43 1.4 55 1.7 54 1.7 66 1.7 66 1.8 65 1.8 66 1.8 81 1.8 16V 99 1.9 D 47 1.9 dT 66		09.88 12.95 09.88 12.95 09.90 12.95 - ABS 09.88 12.95 - ABS 09.88 12.95 - ABS 09.88 12.95 - ABS 05.92 12.95 - ABS 09.94 12.95 - ABS 10.91 12.95 - ABS 09.88 12.95 - ABS 09.88 12.95 - ABS 09.90 12.95 - ABS 09.90 12.95 - ABS	24.5229-0240.3 330400 24.5229-0255.3 330581	2 2	Länge beachten ⁴⁾ Länge beachten ⁴⁾	L=242 L=255
	1.4 55 1.7 54 1.7 66 1.8 65 1.8 66 1.8 81 1.8 16V 99 1.9 D 47 1.9 dT 66		09.90 12.95 + ABS 09.88 12.95 + ABS 09.88 12.95 + ABS 05.92 12.95 + ABS 09.94 12.95 + ABS 10.91 12.95 + ABS 09.88 12.95 + ABS 09.88 12.95 + ABS 04.91 12.95 + ABS	24.5229-0220.3 330399	2		L=220
	1.2 40 1.4 43 1.4 59 1.7 (B/C533/536) 54 1.7 (B/C53C/F) 54 1.7 (B/C53E/M) 54		09.88 04.91 09.88 04.91 09.90 04.91 - ABS 09.88 04.91 - ABS 09.88 04.91 - ABS 09.88 12.95	24.3220-1618.3 020245 24.3220-1617.3 020244	<input type="checkbox"/> <input type="checkbox"/>		RzR 20,64 BDX RzR 20,64 BDX

¹⁾ + ABS/ + autom.transmission / + ABS/ + scatola cambio autom. / + ABS/ + transmission automatique / + ABS/ + cambio automático

²⁾ without sensor ring / senza sensori / sans secours ABS / sin anillo sensor ABS

³⁾ + air conditioning / + aria condizionata / + air conditionné / + aire acondicionado

⁴⁾ notice length / attenzione lunghezza / faire attention longueur / atención largo



RENAULT R19 (3/5-tuerig) (B53/C53/S53_) (88-95)

	1.9 D (B/C534/J)	47	09.88	04.91	- ABS	24.3220-1618.3	020245			RzR 20,64	BDX
	1.9 D (S534)	47	09.88	04.91		24.3220-1617.3	020244			RzR 20,64	BDX
	1.9 dT (B/-53K)	66	09.90	04.91	- ABS						
	1.2	40	05.91	12.95		24.3220-1617.3	020244			RzR 20,64	BDX
	1.4	43	05.91	12.95		24.3220-1618.3	020245			RzR 20,64	BDX
	1.4	59	05.91	12.95	- ABS						
	1.7 (B/C533/536)	54	05.91	12.95	- ABS						
	1.7 (B/C53C/F)		05.91	12.95	- ABS						
	1.9 D (B/C534/J)	47	05.91	12.95	- ABS						
	1.9 D (S534/J)	47	05.91	12.95							
	1.9 dT (B/-53K)	66	05.91	04.92	- ABS						
	1.9 dT (S53K)	66	05.91	12.95							
	1.2	40	05.92	12.95		24.3220-1617.3	020244			RzR 20,64	BDX
	1.4	59	09.94	12.95	- ABS	24.3220-1618.3	020245			RzR 20,64	BDX
	1.4 (B/C535)	55	09.94	12.95	- ABS	24.3220-1615.3	020242			RzR 20,64	TRW
	1.8 (353/535/A/F)	66	09.94	12.95	- ABS	24.3220-1616.3	020243			RzR 20,64	TRW
	1.8 (B/C53V)	66	09.94	12.95	- ABS						
	1.8 (B/C53Y)	65	05.92	12.95	- ABS						
	1.9 D (B/C53I)	47	05.92	12.95	- ABS						
	1.9 D (S53I)	47	05.92	12.95							
	1.9 dT (-/C53K)	66	10.91	04.92	- ABS						
	1.2	40	09.88	12.95		24.3220-1615.3	020242			RzR 20,64	TRW
	1.4 (B/C532)	43	09.88	12.95		24.3220-1616.3	020243			RzR 20,64	TRW
	1.7 (B/C533)	54	09.88	12.95	- ABS						
	1.7 (B/C53C/F)		09.88	12.95	- ABS						
	1.7 (B536)	54	09.88	12.95							
	1.9 D (B/C534/J)	47	09.88	12.95	- ABS						
	1.9 D (S534/J)	47	09.88	12.95							
	1.9 dT (B/C53K)	66	09.90	04.92	- ABS						
	1.2	40	09.88	12.95		03.0137-0209.2	650209			180 x 42	BDX
	1.4	43	09.88	12.95		03.0137-9086.2	669086			Bremsbacken-Zubehör	BDX
	1.4	59	09.94	12.95	- ABS	03.0137-0201.2	650201			180 x 41 HEB	TRW
	1.4 (B/C535)	55	09.94	12.95	- ABS	03.0137-9056.2	669056			Bremsbacken-Zubehör	TRW
	1.7	54	09.88	12.95	- ABS						
	1.7 (B/C53C/F)		09.88	12.95	- ABS						
	1.8	65	05.92	12.95	- ABS						
	1.8 (353/535/A/F)	66	09.94	12.95	- ABS						
	1.8 (B/C53V)	66	09.94	12.95	- ABS						
	1.8 (B/C53Y)	65	05.92	12.95	- ABS						
	1.9 D (B/C534/I/J)	47	09.88	12.95	- ABS						
	1.9 D (S534/I/J)	47	09.88	12.95							
	1.9 dT (B/C53K)	66	09.90	04.92	- ABS						
	1.9 dT (S53K)	66	04.91	12.95							
	1.7 (B/C53F)		09.90	12.95	- ABS	03.0137-0211.2	650211			203 x 39	BDX
	1.8 (353C/D)		09.94	12.95	- ABS	03.0137-9125.2	669125			Bremsbacken-Zubehör	BDX
	1.8 (553C/D/H)		09.94	12.95	- ABS						
	1.8 (B/C538)		10.91	12.95	- ABS						
	1.9 dT (B/C53K)	66	05.92	12.95	- ABS						
	1.9 dT (B/C53T)	66	05.92	12.95	- ABS						
	1.2	40	09.88	12.95		24.0218-0032.1	480118			180/181 x 53,5 - Lager	
	1.4	43	09.88	12.95		24.0218-0732.2	480207			180/181 x 53,5 + Lager	
	1.4	59	09.90	12.95	- ABS						
	1.4 (B/C535)	55	09.90	12.95	- ABS						
	1.7	54	09.88	12.95	- ABS						
	1.7 (B/C53C/F)		09.88	12.95	- ABS						
	1.8 (353/553A)	66	09.94	12.95	- ABS						
	1.8 (B/C53V)	66	09.94	12.95	- ABS						
	1.8 (B/C53Y)	65	05.92	12.95	- ABS						
	1.9 D (B/C534/I/J)	47	09.88	12.95	- ABS						
	1.9 D (S534/I/J)	47	09.88	12.95							
	1.9 dT (B/C53K)	66	09.90	04.92	- ABS						
	1.9 dT (S53K)	66	04.91	04.92							
	1.7 (B/C53F)		05.92	12.95	- ABS	24.0220-3021.1	480127			203/204,5 x 48 - Lager	
	1.8 (B/C538)		10.91	12.95	- ABS						
	1.8 (B553C/D/F/H)	66	09.94	12.95	- ABS						
	1.8 (C353C/D/F)		09.94	12.95	- ABS						
	1.9 dT (B/C53K)	66	05.92	12.95	- ABS						
	1.9 dT (B/C53T)	66	05.92	12.95	- ABS						
	1.2	40	09.88	04.91		03.0520-2020.3	692020			20,64/180x42 TopKit	BDX
	1.4	43	09.88	04.91							
	1.4	59	09.90	04.91	- ABS						
	1.7 (B/C533/536)	54	09.88	04.91	- ABS						
	1.7 (B/C53C/F)		09.88	04.91	- ABS						
	1.7 (B/C53E/M)	54	09.88	12.95							
	1.9 D (B/C534/J)	47	09.88	04.91	- ABS						
	1.9 D (S534)	47	09.88	04.91							
	1.9 dT (B/-53K)	66	09.90	04.91	- ABS						
	1.2	40	05.92	12.95		03.0520-2020.3	692020			20,64/180x42 TopKit	BDX
	1.4	59	09.94	12.95	- ABS	03.0520-2920.3	692920			20,64/180x41 TopKit	TRW
	1.4 (B/C535)	55	09.94	12.95	- ABS						
	1.8 (353/535/A/F)	66	09.94	12.95	- ABS						
	1.8 (B/C53V)	66	09.94	12.95	- ABS						
	1.8 (B/C53Y)	65	05.92	12.95	- ABS						
	1.9 D (B/C53I)	47	05.92	12.95	- ABS						
	1.9 D (S53I)	47	05.92	12.95							
	1.9 dT (-/C53K)	66	10.91	04.92	- ABS						
	1.2	40	09.88	12.95		03.0520-2920.3	692920			20,64/180x41 TopKit	TRW





RENAULT R19 (3/5-tuerig) (B53/C53/S53_) (88-95)

	1.4	43	09.88	12.95	03.0520-2920.3	692920		20,64/180x41 TopKit	TRW
	1.7 (B/C533)	54	09.88	12.95 - ABS					
	1.7 (B/C53C/F)		09.88	12.95 - ABS					
	1.7 (B536)	54	09.88	12.95					
	1.9 D (B/C534/J)	47	09.88	12.95 - ABS					
	1.9 D (S534/J)	47	09.88	12.95					
	1.9 dT (B/C53K)	66	09.90	04.92 - ABS					
	1.7 (B/C53F)		09.90	12.95 - ABS	03.0520-1919.3	691919		19,05/203x39 TopKit	BDX
	1.8 (353C/D)		09.94	12.95 - ABS					
	1.8 (553C/D/H)		09.94	12.95 - ABS					
1.8 (B/C538)		10.91	12.95 - ABS						
1.9 dT (B/C53K)	66	05.92	12.95 - ABS						
1.9 dT (B/C53T)	66	05.92	12.95 - ABS						
	1.2	40	09.88	12.95	24.3727-1012.2	581012	2	L=1564	
	1.4	43	09.88	12.95					
	1.4	59	09.90	12.95 - ABS					
	1.4 (B/C535)	55	09.90	12.95 - ABS					
	1.7	54	09.88	12.95 - ABS					
	1.7	66	09.88	12.95 - ABS					
	1.8	65	05.92	12.95 - ABS					
	1.8	66	09.94	12.95 - ABS					
	1.8	81	10.91	12.95 - ABS					
	1.9 D	47	09.88	12.95 - ABS					
	1.9 dT	66	09.90	12.95 - ABS					
	1.4 (B/C535)	55	09.90	12.95 + ABS	24.3727-1011.2	581011	2	L=1564	
	1.7	54	09.88	12.95 + ABS					
	1.7	66	09.88	12.95 + ABS					
	1.8	65	05.92	12.95 + ABS					
1.8	66	09.94	12.95 + ABS						
1.8	81	10.91	12.95 + ABS						
1.8 16V	99	09.88	12.95						
1.9 D	47	09.88	12.95 + ABS						
1.9 dT	66	09.90	12.95 + ABS						
	1.7 (B/C53F)		12.94	12.95 - ABS	24.6583-1710.3	320166		BRL (4)	
	1.8 (353C/D)		12.94	12.95 - ABS					
	1.8 (553C/D/H)		12.94	12.95 - ABS					
	1.8 (B/C538)		12.94	12.95 - ABS					
	1.9 D (B/C53Z)	47	09.94	12.95 - ABS					
	1.9 dT (B/C53K)	66	12.94	12.95 - ABS					
	1.9 dT (B/C53T)	66	12.94	12.95 - ABS					
1.9 dT (S53K)	66	12.94	12.95						
	1.2	40	09.88	12.95	24.3728-1005.2	591005		L=1010	
	1.4	43	09.88	12.95					
	1.4	55	09.90	12.95					
	1.4	59	09.90	12.95					
	1.7	54	09.88	12.95					
	1.7	66	09.88	12.95					
	1.8	65	05.92	12.95					
	1.8	66	09.94	12.95					
	1.8	81	10.91	12.95					
	1.8 16V	99	09.88	12.95					
	1.9 D	47	09.88	12.95					
	1.9 dT	66	09.90	12.95					

RENAULT R19 CHAMADE (L53_) (89-95)

	1.2	40	06.89	01.92	03.2119-3389.3	010057		Thz 19,05	ATE
	1.4	43	05.89	01.92					
	1.4 (L537)		05.89	01.92 + Fahrschule 1)					
	1.4 (L53A)		09.90	01.92 - ABS					
	1.4 (L53A)		02.92	12.95 - ABS/ + Fahrschule 2)					
	1.4 (L53P)	43	05.89	12.95					
	1.7	66	05.89	01.92 - ABS					
	1.7	66	02.92	12.95 - ABS/ + Fahrschule 2)					
	1.7 (L533)	54	05.89	01.92 - ABS					
	1.7 (L533)	54	02.92	12.95 - ABS/ + Fahrschule 2)					
	1.7 (L536)	54	06.89	12.95					
	1.9 D (L534/J)	47	05.89	01.92 - ABS					
	1.9 D (L534/J)	47	02.92	12.95 - ABS/ + Fahrschule 2)					
	1.9 dT	66	04.91	01.92 - ABS					
	1.9 dT	66	02.92	12.95 - ABS/ + Fahrschule 2)					
1.9 TD (L53K)	68	09.90	01.92 - ABS						
	1.2	40	02.92	12.92	03.2120-2031.3	010106		Thz 20,64	ATE
	1.4	43	02.92	12.95					
	1.4 (L535)	55	09.94	12.95 - ABS					
	1.4 (L537)		02.92	12.95 - Fahrschule 3)					
	1.4 (L53A)		02.92	12.95 - ABS/ - Fahrschule 4)					
	1.4 (L53G)		05.92	12.95					
	1.7 (L533)	54	02.92	12.95 - ABS/ - Fahrschule 4)					
	1.7 (L53C)	66	02.92	12.95 - ABS/ - Fahrschule 4)					
	1.7 (L53F)	79	02.92	12.95 - ABS					
	1.8	65	05.92	12.95 - ABS					
	1.8	79	05.92	12.95 - ABS					
	1.8 (L453A/C/D)	66	09.94	12.95 - ABS					
	1.8 (L538)	81	05.92	12.95 - ABS					
	1.8 (L53V/453/F/H)	66	09.94	12.95					
	1.8 16V	99	05.89	12.95 - ABS					
1.9 D (L534/J)	47	02.92	12.95 - ABS/ - Fahrschule 4)						

1) + driving school / + scuola guida / + auto école / + autoescuela

2) - ABS/ + driving school / - ABS/ + scuola guida / - ABS/ + auto école / - ABS/ + autoescuela

3) - driving school / - scuola guida / - auto école / - autoescuela

4) - ABS/ - driving school / - ABS/ - scuola guida / - ABS/ - auto-école / - ABS/ - autoescuela

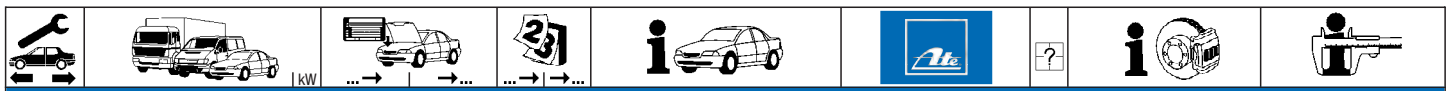

RENAULT R19 CHAMADE (L53_) (89-95)

	1.9 D (L53I) 1.9 dT 1.9 TD (L53K)	47 66 68		05.92 02.92 02.92	12.95 - ABS 12.95 - ABS/ - Fahrschule 1) 04.92 - ABS	03.2120-2031.3	010106			Thz 20,64	ATE
	1.4 1.7 1.7 1.8 1.8 1.8 1.8 (L538) 1.8 16V 1.9 D 1.9 dT 1.9 TD (L53K)	55 54 66 65 66 79 81 99 47 66 68		09.94 05.89 05.89 05.92 09.94 05.92 05.92 05.89 05.89 10.95 09.90	12.95 + ABS/ + Schaltgetriebe 2) 12.95 + ABS/ + Schaltgetriebe 2) 12.95 + ABS/ + Schaltgetriebe 2) 12.95 + ABS/ + Schaltgetriebe 2) 12.95 + ABS/ + Schaltgetriebe 2) 12.95 + ABS/ + Schaltgetriebe 2) 12.95 + ABS/ + Schaltgetriebe 2) 12.95 + ABS/ + Schaltgetriebe 2) 12.95 + ABS/ + Schaltgetriebe 2) 12.95 + ABS/ + Schaltgetriebe 2) 12.95 + ABS/ + Schaltgetriebe 2)	24.2120-1725.3	010579		Thz 20,64	BDX	
	1.2 1.4 1.4 (L535) 1.7 (L536) 1.9 D (L534/J) 1.9 D (L534/J) 1.9 D (L53I)	40 43 55 54 47 47 47		06.89 05.89 09.94 06.89 05.89 10.91 05.92	12.92 12.95 12.95 12.95 12.95 - ABS 12.95 + ABS 12.95	24.3481-1505.5 24.3481-1506.5 24.3481-1611.5 24.3481-1612.5 24.0101-4803.2 24.0101-4807.2	240047 240048 240029 240030 260049 260053	<input type="checkbox"/> <input type="checkbox"/> <input type="checkbox"/> <input type="checkbox"/> <input type="checkbox"/> <input type="checkbox"/>		D=48, - Halter D=48, - Halter D=48, - Halter D=48, - Halter Bremsattel-Zubehör Bremsattel-Zubehör	BDX BDX TRW TRW BDX TRW
	1.4 (L53A) 1.7 (L53B)	54		09.90 05.89	12.95 12.95	24.3481-1505.5 24.3481-1506.5 24.0101-4803.2	240047 240048 260049	<input type="checkbox"/> <input type="checkbox"/>		D=48, - Halter D=48, - Halter Bremsattel-Zubehör	BDX BDX BDX
	1.4 (L53A) 1.4 (L53A) 1.4 (L53A) 1.7 (L53B) 1.7 (L53B) 1.7 (L53B)	54 54 54 54 54		09.90 09.90 09.90 05.89 05.89 05.89	12.95 - ABS 12.94 + ABS/ + Automatikgetriebe 3) 12.95 + Schaltgetriebe 4) 12.95 - ABS 12.94 + ABS/ + Automatikgetriebe 3) 12.95 + Schaltgetriebe 4)	24.3481-1611.5 24.3481-1612.5 24.0101-4807.2	240029 240030 260053	<input type="checkbox"/> <input type="checkbox"/> <input type="checkbox"/>		D=48, - Halter D=48, - Halter Bremsattel-Zubehör	TRW TRW TRW
	1.4 (L53A) 1.7 (L533) 1.7 (L53B) 1.7 (L53C/F) 1.8 1.8 1.8 1.8 (L538) 1.8 16V 1.9 D (L534/J) 1.9 D (L53Z) 1.9 dT	54 54 54 65 66 79 81 99 47 47 66		01.95 05.89 01.95 05.89 05.92 11.94 05.92 05.92 05.89 05.89 05.92 04.91	12.95 + ABS/ + Automatikgetriebe 3) 12.95 12.95 + ABS/ + Automatikgetriebe 3) 12.95 + ABS/ + Automatikgetriebe 3) 12.95 12.95 12.95 12.95 12.95 12.95 12.95 + ABS 12.95 12.95	24.3481-1615.5 24.3481-1616.5 24.0101-4806.2	240031 240032 260052	<input type="checkbox"/> <input type="checkbox"/>		D=48, - Halter D=48, - Halter Bremsattel-Zubehör	TRW TRW TRW
	1.2 1.4 1.4 1.4 (L535) 1.7 (L536) 1.9 D (L534/J) 1.9 D (L534/J) 1.9 D (L53I)	40 43 55 54 47 47 47		06.89 05.89 05.89 09.94 06.89 05.89 10.91 05.92	12.92 12.95 12.95 12.95 12.95 12.95 - ABS 12.95 + ABS 12.95	13.0460-3911.2 13.0460-2834.2 13.0460-0411.2	603911 602834 610411			20905 18,0 +/WK 21463 18,0 /WK/S Belagsatz-Zubehör	BDX TRW BDX
	1.4 (L53A) 1.7 (L53B)	54		09.90 05.89	12.95 12.95	13.0460-3911.2 13.0460-0411.2	603911 610411			20905 18,0 +/WK Belagsatz-Zubehör	BDX BDX
	1.4 (L53A) 1.4 (L53A) 1.4 (L53A) 1.7 (L533) 1.7 (L53B) 1.7 (L53B) 1.7 (L53B) 1.7 (L53B) 1.7 (L53C/F) 1.8 1.8 1.8 1.8 (L538) 1.8 16V 1.9 D (L534/J) 1.9 D (L53Z) 1.9 dT 1.9 TD (L53K)	54 54 54 54 54 54 54 54 65 66 79 81 99 47 47 66 68		09.90 09.90 09.90 05.89 05.89 05.89 05.89 05.89 05.92 11.94 05.92 05.92 05.89 05.89 05.92 04.91 09.90	12.95 - ABS 12.95 + ABS/ + Automatikgetriebe 3) 12.95 + Schaltgetriebe 4) 12.95 - ABS 12.95 + ABS/ + Automatikgetriebe 3) 12.95 + Schaltgetriebe 4) 12.95 12.95 12.95 12.95 12.95 12.95 12.95 12.95 12.95 + ABS 12.95 12.95	13.0460-2834.2	602834		21463 18,0 /WK/S	TRW	
	1.2 1.4 1.4 (L535) 1.4 (L53A) 1.4 (L53A) 1.4 (L53A) 1.4 (L53A) 1.7 (L536) 1.7 (L53B) 1.7 (L53B) 1.7 (L53B) 1.7 (L53B) 1.9 D (L534/J) 1.9 D (L534/J) 1.9 D (L53I)	40 43 55 54 54 54 54 54 54 54 54 47 47 47		06.89 05.89 09.94 09.90 09.90 09.90 06.89 05.89 05.89 05.89 05.89 05.89 10.91 05.92	12.92 12.95 12.95 12.95 + Schaltgetriebe 4) 12.95 - ABS/ + Automatikgetriebe 5) 12.94 + ABS/ + Automatikgetriebe 3) 12.95 12.95 + Schaltgetriebe 4) 12.95 - ABS/ + Automatikgetriebe 5) 12.94 + ABS/ + Automatikgetriebe 3) 12.95 - ABS 12.95 + ABS 12.95	24.0112-0116.1	412116			238 12,0 10,5 +S +B	
	1.7 (L533) 1.7 (L533) 1.7 (L533) 1.7 (L53C)	54 54 54 66		05.89 05.89 05.89 05.89	12.95 + Schaltgetriebe 4) 12.95 - ABS/ + Automatikgetriebe 5) 12.94 + ABS/ + Automatikgetriebe 3) 12.95 + Schaltgetriebe 4)	24.0120-0125.1	420125			238 20,1 17,7 V +S +B	

1) - ABS/ - driving school / - ABS/ - scuola guida / - ABS/ - auto-école / - ABS/ - autoescuela

2) + ABS/ + manual transm. / + ABS/+ scatola camb.velocità / + ABS/ + transmission mécanique / + ABS/ + cambio de velocidad

3) + ABS/ + autom.transmission / + ABS/ + scatola cambio autom. / + ABS/ + transmission automatique / + ABS/ + cambio automático

4) + manual transmission / + scatola cambio velocità / + transmission mécanique / + cambio de velocidad

5) - ABS/ + autom.transmission / - ABS/ + scatola cambio autom. / - ABS/ + transmission automatique / - ABS/ + cambio automático





























RENAULT R19 CHAMADE (L53_) (89-95)

	1.7 (L53C) 66 1.7 (L53C) 66 1.8 65 1.8 65 1.8 65 1.8 (L53V/453F) 66 1.8 (L53V/453F) 66 1.9 D (L534/J) 47 1.9 D (L53Z) 47 1.9 D (L53Z) 47 1.9 dT 66 1.9 dT 66 1.9 TD (L53K) 68		05.89 12.95 - ABS/ + Automatikgetriebe ¹⁾ 05.89 12.94 + ABS/ + Automatikgetriebe ²⁾ 05.92 12.95 + Schaltgetriebe ³⁾ 05.92 12.95 - ABS/ + Automatikgetriebe ¹⁾ 05.92 12.94 + ABS/ + Automatikgetriebe ²⁾ 09.94 12.95 - ABS 09.94 12.94 + ABS 05.89 09.91 + ABS 05.92 12.95 - ABS 05.92 12.94 + ABS 04.91 12.95 - ABS 04.91 12.94 + ABS 09.90 04.92	24.0120-0125.1 420125		238 20,1 17,7 V +S +B
	1.4 (L53A) 54 1.7 (L533) 66 1.7 (L53C) 66 1.7 (L53F) 79 1.8 65 1.8 79 1.8 (L453A/C/D/H) 66 1.8 (L538) 81 1.8 (L53V/453F) 66 1.8 16V 99 1.9 D (L53Z) 47 1.9 dT 66		01.95 12.95 + ABS/ + Automatikgetriebe ²⁾ 01.95 12.95 + ABS/ + Automatikgetriebe ²⁾ 01.95 12.95 + ABS/ + Automatikgetriebe ²⁾ 09.90 12.95 01.95 12.95 + ABS/ + Automatikgetriebe ²⁾ 05.92 12.95 09.94 12.95 05.92 12.95 01.95 12.95 + ABS 05.89 12.95 01.95 12.95 + ABS 01.95 12.95 + ABS	24.0121-0106.1 421106		259 20,6 17,7 V +S +B
	1.2 40 1.4 43 1.4 55 1.4 55 1.7 54 1.7 66 1.7 66 1.8 65 1.8 66 1.8 79 1.8 (L538) 81 1.8 16V 99 1.9 D 47 1.9 dT 66 1.9 TD (L53K) 68		06.89 12.92 05.89 12.95 05.89 12.95 05.89 12.95 05.89 12.95 05.89 12.95 05.92 12.95 09.94 12.95 05.92 12.95 05.92 12.95 05.89 12.95 05.89 12.95 04.91 12.95 09.90 04.92	24.5111-0280.3 330389	2	L=280
	1.4 55 1.7 54 1.7 66 1.8 65 1.8 66 1.8 79 1.8 (L538) 81 1.8 16V 99 1.9 D 47 1.9 dT 66 1.9 TD (L53K) 68		09.90 12.95 + ABS 05.89 12.95 + ABS 05.89 12.95 + ABS 07.91 12.95 + ABS 09.94 12.95 + ABS 05.92 12.95 + ABS 05.92 12.95 + ABS 05.89 12.95 05.89 12.95 + ABS 04.91 12.95 + ABS 09.90 04.92	13.0460-3822.2 603822		21597 11,0 +/S BDX
	1.4 55 1.7 54 1.7 (L53C) 66 1.7 (L53F) 79 1.8 65 1.8 79 1.8 (L453A/C/D) 66 1.8 (L538) 81 1.8 (L53V/453F) 66 1.8 16V (L539) 99 1.8 16V (L53D) 99 1.8 16V (L53D) 99 1.9 D (L534) 47 1.9 D (L531/J) 47 1.9 D (L53Z) 47 1.9 dT 66 1.9 TD (L53K) 68		09.90 12.95 + ABS 05.89 12.95 + ABS 05.89 12.95 + ABS 09.90 12.95 + ABS 05.92 12.95 + ABS 05.92 12.95 + ABS 09.94 12.95 + ABS 05.89 12.95 06.89 04.93 + ABS 05.93 12.95 + ABS/ + Klimaanlage ⁵⁾ 05.89 12.95 + ABS 09.90 12.95 + ABS 05.92 12.95 + ABS 04.91 12.95 + ABS 09.90 04.92	24.0108-0108.1 408108		ohne Sensorring ⁴⁾ 238 8,0 7,0 +B
	1.2 40 1.4 43 1.4 55 1.4 55 1.7 54 1.7 (L53C) 66 1.8 65 1.8 (L53V/453A/F/H) 66 1.8 16V 99 1.9 D 47 1.9 dT 66		06.89 12.92 05.89 12.95 05.89 12.95 09.94 12.95 - ABS 05.89 12.95 - ABS 05.89 12.95 - ABS 05.92 12.95 - ABS 09.94 12.95 - ABS 05.89 12.95 05.89 12.95 - ABS 04.91 12.95 - ABS	24.5229-0240.3 330400 24.5229-0255.3 330581	2 2	Länge beachten ⁶⁾ Länge beachten ⁶⁾ L=242 L=255
	1.4 55 1.7 54 1.7 (L53C) 66 1.7 (L53F) 79 1.8 65 1.8 66 1.8 79 1.8 (L538) 81 1.9 D 47		09.90 12.95 + ABS 05.89 12.95 + ABS 05.89 12.95 + ABS 09.90 12.95 05.92 12.95 + ABS 09.94 12.95 + ABS 05.89 12.95 + ABS 05.89 12.95 + ABS 05.92 12.95 + ABS 05.92 12.95 + ABS 05.89 12.95 + ABS	24.5229-0220.3 330399	2	L=220

¹⁾ - ABS/ + autom.transmission / - ABS/ + scatola cambio autom. / - ABS/ + transmission automatique / - ABS/ + cambio automático
²⁾ + ABS/ + autom.transmission / + ABS/ + scatola cambio autom. / + ABS/ + transmission automatique / + ABS/ + cambio automático
³⁾ + manual transmission / + scatola cambio velocità / + transmission mécanique / + cambio de velocidad
⁴⁾ without sensor ring / senza sensori / sans secours ABS / sin anillo sensor ABS
⁵⁾ + ABS/ + air conditioning / + ABS/ + aria condizionata / + ABS/ + air conditionné / + ABS/ + aire acondicionado
⁶⁾ notice length / attenzione lunghezza / faire attention longueur / atención largo

										
RENAULT R19 CHAMADE (L53_) (89-95)										
	1.9 dT 1.9 TD (L53K)	66 68		04.91 09.90	12.95 + ABS 04.92	24.5229-0220.3	330399	2	L=220	
	1.2 1.4 1.4 (L537/53H) 1.4 (L53A) 1.4 (L53P) 1.7 (L533/536) 1.7 (L53C) 1.9 D (L534/J)	40 43 43 43 54 66 47		06.89 05.89 05.89 09.90 05.89 05.89 05.89	04.91 04.91 04.91 - ABS 12.95 04.91 - ABS 04.91 - ABS	24.3220-1618.3 24.3220-1617.3	020245 020244	 	RzR 20,64 RzR 20,64	BDX BDX
	1.2 1.4 1.4 (L537/53H) 1.4 (L53A) 1.7 (L533/536) 1.7 (L53C) 1.9 D (L534/J)	40 43 43 54 66 47		05.91 05.91 05.91 05.91 05.91 05.91	12.92 12.95 12.95 - ABS - ABS - ABS - ABS	24.3220-1617.3 24.3220-1618.3	020244 020245	 	RzR 20,64 RzR 20,64	BDX BDX
	1.4 (L535) 1.4 (L53G) 1.8 1.8 (L53V/453A/F) 1.9 D (L53I) 1.9 dT	55 65 66 47 66		09.94 05.92 09.94 09.94 05.92 04.91	12.95 - ABS 12.95 - ABS - ABS - ABS 04.92 - ABS	24.3220-1617.3 24.3220-1618.3 24.3220-1615.3 24.3220-1616.3	020244 020245 020242 020243	   	RzR 20,64 RzR 20,64 RzR 20,64 RzR 20,64	BDX BDX TRW TRW
	1.4 1.4 (L537/53H) 1.4 (L53A) 1.7 1.7 (L53C) 1.9 D (L534/J)	43 54 66 47		05.89 05.89 09.90 05.89 05.89	12.95 12.95 - ABS - ABS - ABS - ABS	24.3220-1615.3 24.3220-1616.3	020242 020243	 	RzR 20,64 RzR 20,64	TRW TRW
	1.2 1.4 1.4 1.4 (L537/53H) 1.7 (L533/536) 1.7 (L53C) 1.8 1.8 (L53V/453A/F) 1.9 D (L534/I/J) 1.9 dT	40 43 55 54 66 65 66 47 66		06.89 05.89 05.89 09.94 05.89 05.89 05.92 09.94 05.89 04.91	12.92 12.95 12.95 - ABS - ABS - ABS - ABS - ABS - ABS - ABS 04.92 - ABS	03.0137-0209.2 03.0137-9086.2 03.0137-0201.2 03.0137-9056.2	650209 669086 650201 669056		180 x 42 Bremsbacken-Zubehör 180 x 41 HEB Bremsbacken-Zubehör	BDX BDX TRW TRW
	1.7 (L53F) 1.8 1.8 (453C/D/H) 1.9 D (L53Z) 1.9 dT	79 79 66 47 66		09.90 05.92 09.94 05.92 05.92	12.95 - ABS 12.95 - ABS - ABS - ABS - ABS	03.0137-0211.2 03.0137-9125.2	650211 669125		203 x 39 Bremsbacken-Zubehör	BDX BDX
	1.2 1.4 1.4 1.4 1.7 1.7 (L53C) 1.8 1.8 (L53V/453A/F) 1.9 D (L534/I/J) 1.9 dT	40 43 55 54 66 65 66 47 66		06.89 05.89 05.89 09.94 05.89 05.89 05.92 09.94 05.89 04.91	12.92 12.95 12.95 - ABS - ABS - ABS - ABS - ABS - ABS - ABS 04.92 - ABS	24.0218-0032.1 24.0218-0732.2	480118 480207		180/181 x 53,5 - Lager 180/181 x 53,5 + Lager	
	1.7 (L53F) 1.8 1.8 (453C/D/H) 1.9 D (L53Z) 1.9 dT	79 79 66 47 66		09.90 05.92 09.94 05.92 05.92	12.95 - ABS 12.95 - ABS - ABS - ABS - ABS	24.0220-3021.1	480127		203/204,5 x 48 - Lager	
	1.2 1.4 1.4 (L537/53H) 1.4 (L53A) 1.4 (L53P) 1.7 (L533/536) 1.7 (L53C) 1.9 D (L534/J)	40 43 43 43 54 66 47		06.89 05.89 05.89 09.90 05.89 05.89 05.89	04.91 04.91 - ABS 04.91 - ABS - ABS - ABS	03.0520-2020.3	692020		20,64/180x42 TopKit	BDX
	1.4 (L535) 1.4 (L53G) 1.8 1.8 (L53V/453A/F) 1.9 D (L53I) 1.9 dT	55 65 66 47 66		09.94 05.92 05.92 09.94 05.92 04.91	12.95 - ABS 12.95 - ABS - ABS - ABS 04.92 - ABS	03.0520-2020.3 03.0520-2920.3	692020 692920		20,64/180x42 TopKit 20,64/180x41 TopKit	BDX TRW
	1.4 1.4 (L537/53H) 1.4 (L53A) 1.7 1.7 (L53C) 1.9 D (L534/J)	43 54 66 47		05.89 05.89 09.90 05.89 05.89	12.95 12.95 - ABS - ABS - ABS - ABS	03.0520-2920.3	692920		20,64/180x41 TopKit	TRW
	1.7 (L53F) 1.8 1.8 (453C/D/H) 1.9 D (L53Z) 1.9 dT	79 79 66 47 66		09.90 05.92 09.94 05.92 05.92	12.95 - ABS 12.95 - ABS - ABS - ABS - ABS	03.0520-1919.3	691919		19,05/203x39 TopKit	BDX

RENAULT R19 CHAMADE (L53_) (89-95)										
	1.2	40	06.89	12.92	24.3727-1012.2	581012	2		L=1564	
	1.4		05.89	12.95						
	1.4	43	05.89	12.95						
	1.4	55	09.94	12.95	- ABS					
	1.7	54	05.89	12.95	- ABS					
	1.7 (L53C)	66	05.89	12.95	- ABS					
	1.8	65	05.92	12.95	- ABS					
	1.8 (L53V/453A/F)	66	09.94	12.95	- ABS					
	1.9 D (L534/I/J)	47	05.89	12.95	- ABS					
	1.9 dT	66	04.91	12.95	- ABS					
	1.4	55	09.90	12.95	+ ABS	24.3727-1011.2	581011	2	L=1564	
	1.7	54	05.89	12.95	+ ABS					
	1.7 (L53C/F)		05.89	12.95	+ ABS					
	1.8	65	05.92	12.95	+ ABS					
	1.8	79	05.92	12.95	+ ABS					
	1.8 (L538)	81	05.92	12.95	+ ABS					
	1.8 (L53V/453A/C-F)	66	09.94	12.95	+ ABS					
	1.8 16V	99	05.89	12.95						
	1.9 D	47	05.89	12.95	+ ABS					
	1.9 dT	66	04.91	12.95	+ ABS					
1.9 TD (L53K)	68	09.90	04.92							
	1.7 (L53F)	79	12.94	12.95	- ABS	24.6583-1710.3	320166		BRL (4)	
	1.8 (453C/D/H)	66	12.94	12.95	- ABS					
	1.8 (L538)	81	12.94	12.95	- ABS					
	1.9 D (L53Z)	47	09.94	12.95	- ABS					
	1.9 dT	66	12.94	12.95	- ABS					
	1.9 dT (L53T)	66	12.94	12.95	- ABS					
	1.2	40	06.89	12.92	24.3728-1005.2	591005			L=1010	
	1.4		05.89	12.95						
	1.4	43	05.89	12.95						
	1.4	55	05.89	12.95						
	1.7	54	05.89	12.95						
	1.7	66	05.89	12.95						
	1.8	65	05.92	12.95						
	1.8	66	09.94	12.95						
	1.8	79	05.92	12.95						
	1.8 (L538)	81	05.92	12.95						
	1.8 16V	99	05.89	12.95						
	1.9 D	47	05.89	12.95						
	1.9 dT	66	04.91	12.95						
1.9 TD (L53K)	68	09.90	04.92							
RENAULT R19 Cabriolet (D53_) (91-96)										
	1.7		02.91	01.92	- ABS	03.2119-3389.3	010057		THz 19,05	ATE
	1.7		02.92	08.96	- ABS	03.2120-2031.3	010106		THz 20,64	ATE
	1.8	65	04.92	12.94						
	1.8	66	01.93	12.94						
	1.8	79	01.93	08.96	- ABS					
	1.8 16V		02.91	03.95	- ABS					
	1.7		02.91	08.96	+ ABS/ + Schaltgetriebe 1)	24.2120-1725.3	010579		THz 20,64	BDX
	1.8 (853A)	66	01.93	08.96	+ ABS/ + Schaltgetriebe 1)					
	1.8 16V		02.91	03.95	+ ABS					
	1.7		02.91	08.96		24.3481-1615.5	240031	<input type="checkbox"/>	D=48, - Halter	TRW
	1.8	65	04.92	12.94		24.3481-1616.5	240032	<input type="checkbox"/>	D=48, - Halter	TRW
	1.8	66	01.93	12.94		24.0101-4806.2	260052		Bremssattel-Zubehör	TRW
	1.8	79	09.94	08.96						
	1.8 16V		02.91	03.95						
	1.7		02.91	08.96		13.0460-2834.2	602834		21463 18,0 /WK/S	TRW
	1.8	65	04.92	12.94						
	1.8	66	01.93	12.94						
	1.8	79	09.94	08.96						
	1.8 16V		02.91	03.95						
	1.7		02.91	08.96	- ABS/ + Automatikgetriebe 2)	24.0120-0125.1	420125		238 20,1 17,7 V +S +B	
	1.7		02.91	12.94	+ ABS/ + Automatikgetriebe 3)					
	1.7		02.91	08.96	+ Schaltgetriebe 4)					
	1.8	65	04.92	12.94	- ABS/ + Automatikgetriebe 2)					
	1.8	65	04.92	12.94	+ ABS/ + Automatikgetriebe 3)					
	1.8	65	04.92	12.94	+ Schaltgetriebe 4)					
	1.8 (853A)	66	01.93	08.96	- ABS					
	1.7		01.95	08.96	+ ABS/ + Automatikgetriebe 3)	24.0121-0106.1	421106		259 20,6 17,7 V +S +B	
	1.8	66	01.93	08.96	+ ABS					
1.8 16V	79	09.94	08.96							
		02.91	03.95							
	1.7		02.91	08.96		24.5111-0280.3	330389	2	L=280	
	1.8	65	04.92	12.94						
	1.8	66	01.93	08.96						
	1.8	79	09.94	08.96						
	1.8 16V		02.91	03.95						
	1.7		02.91	08.96	+ ABS	13.0460-3822.2	603822		21597 11,0 +/S	BDX
	1.8	65	04.92	12.95	+ ABS					
	1.8	66	01.93	08.96	+ ABS					
	1.8 (853F)	79	09.94	08.96	+ ABS					
	1.8 16V		02.91	03.95						

1) + ABS/ + manual transm. / + ABS/+ scatola camb.velocità / + ABS/ + transmission mécanique / + ABS/ + cambio de velocidad
2) - ABS/ + autom.transmission / - ABS/ + scatola cambio autom. / - ABS/ + transmission automatique / - ABS/ + cambio automático
3) + ABS/ + autom.transmission / + ABS/ + scatola cambio autom. / + ABS/ + transmission automatique / + ABS/ + cambio automático
4) + manual transmission / + scatola cambio velocità / + transmission mécanique / + cambio de velocidad



RENAULT R19 Cabriolet (D53_) (91-96)













	1.7 1.8 1.8 1.8 (853F) 1.8 16V	65 66 79	02.91 04.92 01.93 09.94 02.91	08.96 + ABS 12.94 + ABS 08.96 + ABS 08.96 + ABS 03.95	24.0108-0108.1	408108	ohne Sensorring ¹⁾	238 8,0 7,0 +B	
	1.7 1.8 1.8 1.8 1.8 16V	65 66 79	02.91 04.92 01.93 09.94 02.91	08.96 - ABS 12.94 - ABS 08.96 - ABS 08.96 - ABS 03.95 - ABS	24.5229-0255.3	330581	2	L=255	
	1.7 1.8 1.8 1.8 1.8 16V	65 66 79	02.91 04.92 01.93 09.94 02.91	08.96 + ABS 12.94 + ABS 08.96 + ABS 08.96 + ABS 03.95 + ABS	24.5229-0220.3	330399	2	L=220	
	1.7 1.8 1.8	65 66	02.91 04.92 01.93	08.96 - ABS 12.94 - ABS 08.96 - ABS	24.3220-1617.3 24.3220-1618.3 24.3220-1615.3 24.3220-1616.3	020244 020245 020242 020243		RzR 20,64 RzR 20,64 RzR 20,64 RzR 20,64	BDX BDX TRW TRW
	1.7 1.8 1.8	65 66	02.91 04.92 01.93	08.96 - ABS 12.94 - ABS 08.96 - ABS	03.0137-0209.2 03.0137-9086.2 03.0137-0201.2 03.0137-9056.2	650209 669086 650201 669056		180 x 42 Bremsbacken-Zubehör 180 x 41 HEB Bremsbacken-Zubehör	BDX BDX TRW TRW
	1.7 1.8 1.8	65 66	02.91 04.92 01.93	08.96 - ABS 12.94 - ABS 08.96 - ABS	24.0218-0032.1 24.0218-0732.2	480118 480207		180/181 x 53,5 - Lager 180/181 x 53,5 + Lager	
	1.7 1.8 1.8	65 66 79	09.94 08.96	- ABS	24.0220-3021.1	480127		203/204,5 x 48 - Lager	
	1.7 1.8 1.8	65 66	02.91 04.92 01.93	08.96 - ABS 12.94 - ABS 08.96 - ABS	03.0520-2020.3 03.0520-2920.3	692020 692920		20,64/180x42 TopKit 20,64/180x41 TopKit	BDX TRW
	1.7 1.8 1.8	65 66 79	09.94 08.96	- ABS	03.0520-1919.3	691919		19,05/203x39 TopKit	BDX
	1.7 1.8 1.8	65 66	02.91 04.92 01.93	08.96 - ABS 12.94 - ABS 08.96 - ABS	24.3727-1012.2	581012	2	L=1564	
	1.7 1.8 1.8 1.8 1.8 16V	65 66 79	02.91 04.92 01.93 09.94 02.91	08.96 + ABS 12.94 + ABS 08.96 + ABS 08.96 03.95	24.3727-1011.2	581011	2	L=1564	
	1.7 1.8 1.8 1.8 1.8 16V	65 66 79	02.91 04.92 01.93 09.94 02.91	08.96 12.94 08.96 08.96 03.95	24.3728-1005.2	591005		L=1010	













RENAULT R20 (76-84)

	2.0 (R1272) 2.0 (R1277) 2.1 (R1276)		01.78 01.81 01.80	12.84 + (S) 12.84 + (D) 12.84	24.2120-1709.3	010276		THz 20,64	
	2.0 (R1277) 2.1 (R1276)		01.81 01.80	12.84 + (D) 12.84	24.3541-1625.5 24.3541-1626.5	240045 240046		D=54, - Halter D=54, - Halter	TRW TRW
	1.6 (R1271) 1.6 (R1271)		01.76 06.80	05.80 12.81	13.0460-3928.2 13.0460-3911.2 13.0460-0411.2	603928 603911 610411		20140 14,0 +/-WE 20905 18,0 +/-WK Belagsatz-Zubehör	BDX BDX BDX
	2.0 (R1272) 2.0 (R1272) 2.0 (R1277) 2.2 (R1279)		01.78 01.81 01.81 01.81	12.80 12.84 - (S) 12.84 - (D) 12.84	13.0460-3968.2	603968		20488 18,5 +/-WK	BDX
	2.0 (R1272) 2.0 (R1277) 2.1 (R1276)		01.81 01.81 01.80	12.84 + (S) 12.84 + (D) 12.84	13.0460-3911.2 13.0460-2834.2 13.0460-0411.2	603911 602834 610411		20905 18,0 +/-WK 21463 18,0 /WK/S Belagsatz-Zubehör	BDX TRW BDX
	2.0 (R1272) 2.0 (R1272) 2.0 (R1277) 2.2 (R1279)		01.78 01.81 01.81 01.81	12.80 12.84 - (S) 12.84 - (D) 12.84	24.0124-0103.1	424103		253 24,0 22,0 V +B	
	1.6 (R1271) 2.0 (R1272) 2.0 (R1277) 2.1 (R1276) 2.2 (R1279)		01.81 01.81 01.81 01.80 01.81	12.81 12.84 - (S) 12.84 12.84 12.84	24.5112-0385.3	330392	2	L=385	
	1.6 (R1271) 2.0 (R1272) 2.0 (R1277) 2.1 (R1276)		01.76 01.78 01.81 01.80	12.81 12.84 12.84 12.84	24.3222-1108.3 24.3222-1109.3	020263 020264		Rz 22,20 Rz 22,20	BDX BDX
	1.6 (R1271) 2.0 (R1272) 2.0 (R1277) 2.1 (R1276)		01.76 01.78 01.81 01.80	12.81 12.84 12.84 12.84	03.0137-0139.2 03.0137-0124.2 03.0137-0271.2 03.0137-9020.2	650139 650124 650271 669020		229 x 42 229 x 42 HEB AUT 229 x 42 HEB Bremsbacken-Zubehör	BDX BDX TRW BDX

¹⁾ without sensor ring / senza sensori / sans secours ABS / sin anillo sensor ABS



									
RENAULT R20 (76-84)									
	1.6 (R1271)		01.76	12.81		03.0520-0522.3	690522		22,20/229x42 TopKit BDX
	2.0 (R1272)		01.78	12.84					
	2.0 (R1277)		01.81	12.84					
	2.1 (R1276)		01.80	12.84					
	2.0 (R1272)		01.78	12.84		24.2528-0908.3	040065		Nz 28,57
	2.0 (R1277)		01.81	12.84					
	2.2 (R1279)		01.81	12.84					
RENAULT R21 Limousine (B48/L48_) (86-93)									
	1.4 (B/L 48D)	51	06.88	12.92		03.2119-3389.3	010057		THz 19,05 ATE
	1.6 (L 48U)		06.88	08.90	- MA				
	1.7 (B 482)	65	09.89	05.92	- MA				
	1.7 (B/L 481)	55	01.86	05.92					
	1.7 (B/L 484)		06.90	05.92					
	1.7 (B/L 48J)		01.87	05.91					
	1.7 (L 482)	65	01.86	05.92	- E MA				
	1.7 (L 48M)	54	10.87	05.92					
	1.7 (L 48N)	64	10.87	05.92					
	1.7 i (B 48F)	54	08.86	05.92					
	1.7 i (B/L 48E)	66	08.86	05.92					
	1.9 D (B/L 48H)	47	05.89	12.92					
	1.9 D (B/L 48I)	47	04.92	12.93					
	2.2 i (L 48S)	79	06.88	04.89					
	1.6 (B 48U)		06.90	03.92		03.2120-2682.3	010118		THz 20,64 ATE
	1.6 (L 48U)		01.91	12.93	- MA				
	1.7 (B 482)	65	09.89	05.92	+ MA				
	1.7 (B 482)	65	06.92	12.92	- MA				
	1.7 (B/L 481)	55	06.92	12.92					
	1.7 (B/L 484)		06.92	12.93					
	1.7 (L 482)	65	01.86	05.92	+ E				
	1.7 (L 482)	65	06.92	12.92	- E				
	1.7 i (B 48E)	66	06.92	12.93					
	1.7 i (B 48F)	54	06.92	12.93					
	1.7 i (L 48E)	66	06.92	12.93	+ F				
	2.0 (L 489)	◀	01.87	04.89					
	2.0 (L 489)	▶	01.87	03.93					
	2.0 i (B 483)	▶	01.86	12.92	- ABS				
	2.0 i (B 48R)	▶ 99	09.89	12.93	- ABS				
	2.0 i (B 48Y)	▶ 99	09.89	03.92					
	2.0 i (B/L 48C)	▶ 88	06.90	12.93	- ABS				
	2.1 D (B 48V)	▶ 53	09.89	12.93					
	2.1 TD (B 486)	▶ 65	09.89	12.92					
	2.1 TD (B 48W)	▶ 65	09.89	05.91					
	2.1 TD (L 486)	◀ 65	01.86	04.89					
	2.1 TD (L 486)	▶ 65	01.86	10.92					
	2.2 i (B 48K)	▶ 79	06.90	10.92	- ABS				
	2.2 i (L 48K)	◀ 79	08.86	04.89	- ABS				
	2.2 i (L 48K)	▶ 79	08.86	12.93	- ABS				
	1.6 (L 48U)		06.88	12.93	+ MA	03.2122-9631.3	010160		THz 22,20 ATE
	1.7 (L 482)	65	09.90	12.92	+ E MA				
	2.0 (L 489)	◀	05.89	03.93					
	2.0 i (B 483)	◀	09.89	12.92	- ABS/ - MA				
	2.0 i (B 483)	◀	09.90	12.92	- ABS/ + MA				
	2.0 i (B 48R)	◀ 99	09.89	12.93	- ABS				
	2.0 i (B 48Y)	◀ 99	09.89	03.92	- ABS				
	2.0 i (B/L 48C)	◀ 88	06.90	12.93	- ABS				
	2.0 i (L 483)		05.89	12.92	- ABS				
	2.0 i (L 48Q)		05.89	03.92	- ABS				
	2.0 i (L 48R)	99	05.89	12.93					
	2.0 i (L 48Y)	99	05.89	03.92	- ABS				
	2.1 D (B 480)	53	04.92	12.92	- ABS				
	2.1 D (B 48V)	◀ 53	09.89	12.93					
	2.1 D (B/L 480)	51	04.92	12.93	- ABS				
	2.1 D (L 480)	53	04.92	12.93					
	2.1 D (L 48V)	53	05.89	12.93					
	2.1 TD (B 487)	65	06.91	12.93	- ABS				
	2.1 TD (B 488)	65	09.89	10.92	- ABS/ - MA				
	2.1 TD (B 488)	65	09.90	10.92	- ABS/ + MA				
	2.1 TD (B 48A)	65	04.92	12.93					
	2.1 TD (B/L 486)	65	05.89	12.92					
	2.1 TD (B/L 48W)	65	05.89	05.91					
	2.1 TD (L 487)	65	07.91	12.93					
	2.1 TD (L 488)	65	05.89	10.92	- ABS				
	2.1 TD (L 48A)	65	04.92	12.93	- ABS				
	2.2 i (B 48K)	79	09.89	10.92	- ABS				
	2.2 i (L 48K)	◀ 79	05.89	12.93	- ABS				
	2.2 i (L 48S)	79	05.89	12.93					
	1.4 (B/L 48D)	51	06.88	12.92		24.3481-1611.5	240029	<input type="checkbox"/>	D=48, - Halter TRW
	1.7 (B/L 481)	55	01.86	12.92		24.3481-1612.5	240030	<input type="checkbox"/>	D=48, - Halter TRW
						24.0101-4807.2	260053		Bremssattel-Zubehör TRW
	1.7 (L 48M)	54	10.87	05.90		24.3481-1615.5	240031	<input type="checkbox"/>	D=48, - Halter TRW
	1.7 i (B 48F)	54	08.86	12.93		24.3481-1616.5	240032	<input type="checkbox"/>	D=48, - Halter TRW
	1.6 (L 48U)		06.88	12.93		24.3481-1615.5	240031	<input type="checkbox"/>	D=48, - Halter TRW
	1.7 (B 482)	65	09.89	12.92	- MA	24.3481-1616.5	240032	<input type="checkbox"/>	D=48, - Halter TRW
	1.7 (B/L 484)		06.90	12.93		24.0101-4806.2	260052	<input type="checkbox"/>	Bremssattel-Zubehör TRW
	1.7 (B/L 48J)		01.87	05.91					

										
RENAULT R21 Limousine (B48/L48_) (86-93)										
	1.7 (L 482)	65	01.86	12.92	- (E) (MA)	24.3481-1615.5	240031	D=48, - Halter D=48, - Halter Bremsattel-Zubehör	TRW	
	1.7 (L 48N)	64	10.87	05.90		24.3481-1616.5	240032		TRW	
	1.7 i (B/L 48E)	66	08.86	12.93		24.0101-4806.2	260052		TRW	
	1.9 D (B/L 48H)	47	05.89	12.92						
	1.9 D (B/L 48I)	47	04.92	12.93						
	1.6 (L 48U)	65	06.90	03.92		24.3541-1625.5	240045		D=54, - Halter	TRW
1.7 (B 482)	65	09.89	12.92	+	(MA)	24.3541-1626.5	240046	D=54, - Halter	TRW	
1.7 (L 482)	65	01.86	12.92	+	(E) (MA)					
	1.4 (B/L 48D)	51	06.88	12.92		13.0460-3911.2	603911	20905 18,0 +WK	BDX	
	1.7 (B/L 481)	55	01.86	12.92		13.0460-2834.2	602834	21463 18,0 /WK/S	TRW	
	1.7 (L 48M)	54	10.87	05.90		13.0460-0411.2	610411	Belagsatz-Zubehör	BDX	
	1.7 i (B 48F)	54	08.86	12.93						
	1.6 (B/L 48U)	65	06.88	12.93		13.0460-2834.2	602834	21463 18,0 /WK/S	TRW	
	1.7 (B/L 482)	65	01.86	12.92						
	1.7 (B/L 484)	65	06.90	12.93						
	1.7 (B/L 48J)	65	01.87	05.91						
	1.7 (L 48N)	64	10.87	05.90						
	1.7 i (B/L 48E)	66	08.86	12.93						
	1.9 D (B/L 48H)	47	05.89	12.92						
	1.9 D (B/L 48I)	47	04.92	12.93						
	2.0 (L 489)	88	01.87	03.93		13.0460-3933.2	603933	21016 17,0 +WK	BDX	
	2.0 i (B/L 483)	88	01.86	12.92						
	2.0 i (B/L 48C)	88	06.90	12.93						
	2.0 i (B/L 48R)	99	05.89	12.93						
	2.0 i (B/L 48Y)	99	05.89	03.92						
	2.0 i (L 48Q)	99	05.89	03.92						
	2.0 T (L 485)	99	06.87	03.92						
	2.0 T (L 48L)	99	05.89	12.93						
	2.1 D (B/L 480)	51	04.92	12.93						
	2.1 D (B/L 480)	53	04.92	12.93						
	2.1 D (B/L 48V)	53	05.89	12.93						
	2.1 TD (B/L 486)	65	01.86	12.92						
	2.1 TD (B/L 487)	65	06.91	12.93						
	2.1 TD (B/L 488)	65	01.86	10.92						
	2.1 TD (B/L 48A)	65	04.92	12.93						
2.1 TD (B/L 48W)	65	05.89	05.91							
2.2 i (B/L 48K)	79	08.86	12.93							
2.2 i (L 48S)	79	06.88	12.93							
	1.4 (B/L 48D)	51	06.88	12.92		24.0112-0116.1	412116	238 12,0 10,5 +S +B		
	1.7 (B/L 481)	55	01.86	12.92						
	1.6 (B/L 48U)	65	06.88	12.93		24.0120-0125.1	420125	238 20,1 17,7 V +S +B		
	1.7 (B/L 482)	65	01.86	12.92						
	1.7 (B/L 484)	65	06.90	12.93						
	1.7 (B/L 48J)	65	01.87	05.91						
	1.7 (L 48M)	54	10.87	05.90						
	1.7 (L 48N)	64	10.87	05.90						
	1.7 i (B 48F)	54	08.86	12.93						
	1.7 i (B/L 48E)	66	08.86	12.93						
	1.9 D (B/L 48H)	47	05.89	12.92						
	1.9 D (B/L 48I)	47	04.92	12.93						
	2.0 (L 489)	88	01.87	03.93		24.0120-0134.1	420134	265 20,5 17,7 V		
	2.0 i (B/L 483)	88	01.86	12.92						
	2.0 i (B/L 48C)	88	06.90	12.93						
	2.2 i (B/L 48K)	79	08.86	12.93						
	2.2 i (L 48S)	79	06.88	12.93						
	2.0 i (B/L 48R)	99	05.89	12.93		24.0121-0103.1	421103	285 21,0 19,0 V		
	2.0 i (B/L 48Y)	99	05.89	03.92						
	2.0 i (L 48Q)	99	05.89	03.92						
	2.0 T (L 485)	99	06.87	03.92		24.0121-0101.1	421101	285 21,0 19,0 V		
	2.0 T (L 48L)	99	05.89	12.93						
	2.1 D (B 480)	53	04.92	12.93		24.0120-0135.1	420135	244 20,5 17,7 V		
	2.1 D (B 48V)	53	09.89	12.93						
	2.1 D (B/L 480)	51	04.92	12.93						
	2.1 TD (B 486)	65	09.89	12.92						
	2.1 TD (B/L 487)	65	06.91	12.93						
	2.1 TD (B/L 48W)	65	05.89	05.91						
	2.1 TD (L 48A)	65	04.92	12.93						
	2.1 TD (L 48P)	65	07.91	03.92						
	2.1 D (L 480)	53	04.92	12.93	-	(MA)	24.0120-0135.1	420135	244 20,5 17,7 V	
	2.1 D (L 48V)	53	05.89	12.93	-	(MA)				
	2.1 TD (B 488)	65	09.89	10.92	-	(MA)				
2.1 TD (B 48A)	65	04.92	12.92	-	(MA)					
2.1 TD (L 486)	65	01.86	10.92	-	(E)					
2.1 TD (L 488)	65	01.86	10.92	-	(E) (MA)					
2.1 D (L 480)	53	04.92	12.93	+	(MA)	24.0120-0134.1	420134	265 20,5 17,7 V		
2.1 D (L 48V)	53	05.89	12.93	+	(MA)					
2.1 TD (B 488)	65	09.89	10.92	+	(MA)					
2.1 TD (B 48A)	65	04.92	12.92	+	(MA)					
2.1 TD (L 486)	65	01.86	10.92	+	(E)					
2.1 TD (L 488)	65	01.86	10.92	+	(E) (MA)					
	1.4 (B/L 48D)	51	06.88	12.92		24.5111-0241.3	330680	2	L=242	
	1.6 (L 48U)	65	06.88	12.93						
	1.7 (B 482)	65	09.89	12.92	-	(MA)				
	1.7 (B/L 481)	55	01.86	12.92						
	1.7 (B/L 484)	55	06.90	12.93						





RENAULT R21 Limousine (B48/L48_) (86-93)

	1.7 (B/L 48J)		01.87	05.91		24.5111-0241.3	330680	2			L=242	
	1.7 (L 482)	65	01.86	12.92	- E MA							
	1.7 (L 48M)	54	10.87	05.92								
	1.7 (L 48N)	64	10.87	05.92								
	1.7 i (B 48F)	54	08.86	12.93								
	1.7 i (L 48E)	66	08.86	12.93								
	1.9 D (B/L 48H)	47	05.89	12.92								
	1.9 D (B/L 48I)	47	04.92	12.93								
	2.0 (L 489)		01.87	03.93								
	2.0 i (B/L 483)		01.86	12.92	- ABS							
2.0 i (B/L 48C)	88	06.90	12.93	- ABS								
2.0 i (B/L 48R)	99	05.89	12.93	- ABS								
2.0 i (B/L 48Y)	99	05.89	03.92	- ABS								
2.0 i (L 48Q)		05.89	03.92	- ABS								
2.1 D (B/L 480)	51	04.92	12.93	- ABS								
2.1 D (B/L 480)	53	04.92	12.93	- ABS								
2.1 D (B/L 48V)	53	05.89	12.93									
2.1 TD (B/L 486)	65	01.86	12.92									
2.1 TD (B/L 487)	65	06.91	12.93									
2.1 TD (B/L 488)	65	01.86	10.92	- ABS								
2.1 TD (B/L 48A)	65	04.92	12.93	- ABS								
2.1 TD (B/L 48P)	65	06.91	03.92									
2.1 TD (B/L 48W)	65	05.89	05.91									
2.2 i (B/L 48K)	79	08.86	12.93	- ABS								
2.2 i (L 48S)	79	06.88	12.93									
2.0 i (B/L 483)		01.86	12.92	+ ABS								
2.0 i (B/L 48C)	88	06.90	12.93	+ ABS								
2.0 i (B/L 48R)	99	05.89	12.93	+ ABS								
2.0 i (B/L 48Y)	99	05.89	03.92	+ ABS								
2.0 i (L 48Q)		05.89	03.92	+ ABS								
2.1 D (B/L 480)	51	04.92	12.93	+ ABS								
2.1 D (B/L 480)	53	04.92	12.93	+ ABS								
2.1 TD (B/L 488)	65	01.86	10.92	+ ABS								
2.1 TD (B/L 48A)	65	04.92	12.93	+ ABS								
2.2 i (B/L 48K)	79	08.86	12.93	+ ABS								
	2.0 i (B/L 483)		03.87	12.92		24.0711-1403.3	360100				Radsensor L=1289	
	2.0 i (B/L 48C)	88	06.90	12.93								
	2.0 i (B/L 48R)	99	05.89	12.93								
	2.0 i (B/L 48Y)	99	05.89	03.92								
	2.0 i (L 48Q)		05.89	03.92								
	2.0 T (L 485)		06.87	03.92								
	2.0 T (L 48L)		05.89	12.93								
	2.1 D (B/L 480)	51	04.92	12.93								
	2.1 TD (B 487)	65	06.91	12.93								
	2.1 TD (B/L 488)	65	03.87	12.92								
2.1 TD (B/L 48A)	65	04.92	12.93									
2.2 i (B/L 48K)	79	03.87	12.93									
	2.0 i (B/L 483)		03.87	12.92	+ ABS	13.0460-3961.2	603961				20336 14,0 +WK 20410 15,0 + Belagsatz-Zubehör	BDX BRE BRE
	2.0 i (B/L 48C)	88	06.90	12.93	+ ABS							
	2.0 i (B/L 48R)	99	05.89	12.93								
	2.0 i (B/L 48Y)	99	05.89	03.92								
	2.0 i (L 48Q)		05.89	03.92								
	2.0 T (L 485)		06.87	03.92								
	2.0 T (L 48L)		05.89	12.93								
	2.1 D (B 480)	53	04.92	12.92	+ ABS							
	2.1 D (B/L 480)	51	04.92	12.93	+ ABS							
	2.1 TD (B 487)	65	06.91	12.93	+ ABS							
2.1 TD (B/L 488)	65	03.87	10.92	+ ABS								
2.1 TD (B/L 48A)	65	04.92	12.93	+ ABS								
2.1 TD (L 48P)	65	07.91	03.92	+ ABS								
2.2 i (B/L 48K)	79	03.87	12.93	+ ABS								
	2.0 i (B/L 483)		03.87	12.92	+ ABS	24.0111-0122.1	411122				255 10,5 9,5	
	2.0 i (B/L 48C)	88	06.90	12.93	+ ABS							
	2.0 i (B/L 48R)	99	05.89	12.93								
	2.0 i (B/L 48Y)	99	05.89	03.92								
	2.0 i (L 48Q)		05.89	03.92								
	2.1 D (B 480)	53	04.92	12.92	+ ABS							
	2.1 D (B/L 480)	51	04.92	12.93	+ ABS							
	2.1 TD (B 487)	65	06.91	12.93	+ ABS							
	2.1 TD (B/L 488)	65	03.87	10.92	+ ABS							
	2.1 TD (B/L 48A)	65	04.92	12.93	+ ABS							
2.1 TD (L 48P)	65	07.91	03.92	+ ABS								
2.2 i (B/L 48K)	79	03.87	12.93	+ ABS								
	2.0 i (B/L 483)		01.86	12.92	- ABS	24.5229-0220.3	330399	2			L=220	
	2.0 i (B/L 48C)	88	06.90	12.93	- ABS							
	2.0 i (B/L 48R)	99	05.89	12.93	- ABS							
	2.0 i (B/L 48Y)	99	05.89	03.92	- ABS							
	2.0 i (L 48Q)		05.89	03.92	- ABS							
	2.1 D (B/L 480)	51	04.92	12.93	- ABS							
	2.1 D (B/L 480)	53	04.92	12.93	- ABS							
	2.1 TD (B/L 488)	65	01.86	10.92	- ABS							
	2.1 TD (B/L 48A)	65	04.92	12.93	- ABS							
	2.2 i (B/L 48K)	79	08.86	12.93	- ABS							

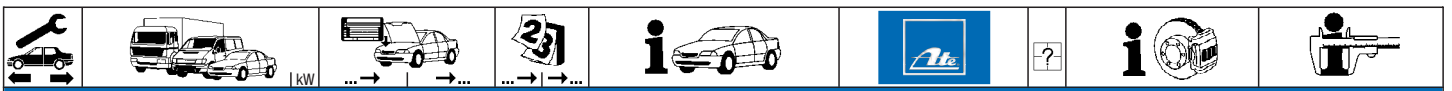

RENAULT R21 Limousine (B48/L48_) (86-93)

	2.0 i (B/L 483)			01.86	12.92 + ABS	24.5229-0220.3	330399	2	Länge beachten ¹⁾	L=220
	2.0 i (B/L 48C)	88		06.90	12.93 + ABS	24.5111-0320.3	330487	2	Länge beachten ¹⁾	L=320
	2.0 i (B/L 48R)	99		05.89	12.93 + ABS	24.5111-0260.3	330408	2	Länge beachten ¹⁾	L=260
	2.0 i (B/L 48Y)	99		05.89	03.92 + ABS	24.5229-0285.3	330032	2	Länge beachten ¹⁾	L=285
	2.0 i (L 48Q)			05.89	03.92 + ABS					
	2.0 T (L 485)			06.87	03.92 + ABS					
	2.1 D (B/L 480)	51		04.92	12.93 + ABS					
	2.1 D (B/L 480)	53		04.92	12.93 + ABS					
	2.1 TD (B/L 488)	65		01.86	10.92 + ABS					
	2.1 TD (B/L 48A)	65		04.92	12.93 + ABS					
	2.2 i (B/L 48K)	79		08.86	12.93 + ABS					
	1.6 (B 48U)			06.90	03.92	24.3222-1709.3	020111		<input type="checkbox"/>	Rz 22,20
	1.7 (B 482)	65		09.89	12.92 + (MA)	24.3222-1710.3	020112		<input type="checkbox"/>	Rz 22,20
	1.7 (L 481)	55	S0001313	01.86						BDX
	1.7 (L 481)	55	H0009140	01.86						BDX
	1.7 (L 481)	55	D0003266	01.86						
	1.7 (L 482)	65	U0034082	01.86						
	1.7 (L 482)	65	S0070467	01.86						
	1.7 (L 482)	65	H0043418	01.86						
	1.7 (L 482)	65	D0024931	01.86						
	1.7 (L 48J)	65	S0000116	01.87						
	1.7 i (L 48E)	66	H0003449	08.86						
	2.1 TD (L 486)	65	U0020806	01.86	- (E)					
	2.1 TD (L 486)	65	S0005652	01.86	- (E)					
	2.1 TD (L 486)	65	H0007702	01.86	- (E)					
	2.1 TD (L 486)	65		01.86	10.92 + (E)					
	1.4 (B 48D)	51	S0006089	09.89		24.3222-1618.3	020325		<input type="checkbox"/>	Rz 22,20
	1.4 (L 48D)	51	S0002915	06.88		24.3222-1617.3	020324		<input type="checkbox"/>	Rz 22,20
	1.4 (L 48D)	51	H0012053	06.88						
	1.7 (B 481)	55	S0007101	09.89						
	1.7 (B 482)	65	S0060304	09.89	- (MA)					
	1.7 (B 484)		S0000049	06.90						
	1.7 (B 48J)			09.89	05.91					
	1.7 (L 481)	55	S0001314	S0025346						
	1.7 (L 481)	55	H0009141	H0011287						
	1.7 (L 481)	55	D0003267	D0006514						
	1.7 (L 482)	65	U0034083	U0090483						
	1.7 (L 482)	65	S0070468	S0223510						
	1.7 (L 482)	65	H0043419	H0082328						
	1.7 (L 482)	65	E0070609	01.86						
	1.7 (L 482)	65	D0024932	D0037794						
	1.7 (L 484)		S0000019	06.90						
	1.7 (L 48J)		S0000117	S0003038						
	1.7 (L 48M)	54		10.87	05.90					
	1.7 (L 48N)	64		10.87	05.90					
	1.7 i (B 48E)	66	S0008733	09.89						
	1.7 i (B 48F)	54	S0036357	09.89						
	1.7 i (L 48E)	66	S0005972	08.86						
	1.7 i (L 48E)	66	H0003450	H0011574						
	1.9 D (B 48H)	47	S0005583	09.89						
	1.9 D (L 48H)	47	S0002098	05.89						
	1.9 D (L 48H)	47	H0001369	05.89						
	1.9 D (L 48I)	47		04.92	12.92					
	2.1 D (B 48V)	53	S0060120	09.89						
	2.1 D (B 48V)	53	E0006146	09.89						
	2.1 D (L 48V)	53	S0022488	05.89						
	2.1 D (L 48V)	53	H0011781	05.89						
	2.1 TD (B 486)	65	S0005100	09.89						
	2.1 TD (L 486)	65	U0020807	U0074005						
	2.1 TD (L 486)	65	S0005653	S0040195						
	2.1 TD (L 486)	65	H0007703	H0017034						
	1.4 (B 48D)	51	S0006090	10.92		24.3222-1617.3	020324		<input type="checkbox"/>	Rz 22,20
	1.4 (L 48D)	51	H0012054	12.92		24.3222-1618.3	020325		<input type="checkbox"/>	Rz 22,20
	1.4 (L 48D)	51	S0002916	12.92						
	1.6 (L 48U)			06.88	12.93 + (MA)					
	1.7 (B 481)	55	S0007102	12.92						
	1.7 (B 482)	65	S0060305	12.92	- (MA)					
	1.7 (B 484)		S0000050	03.93						
	1.7 (L 481)	55	D0006515	12.92						
	1.7 (L 481)	55	H0011288	12.92						
	1.7 (L 481)	55	S0025347	12.92						
	1.7 (L 482)	65	D0037795	12.92						
	1.7 (L 482)	65	E0070610	12.92						
	1.7 (L 482)	65	H0082329	12.92						
	1.7 (L 482)	65	S0223511	12.92						
	1.7 (L 482)	65	U0090484	12.92						
	1.7 (L 484)		S0000020	12.93						
	1.7 (L 48J)		S0003039	02.91						
	1.7 i (B 48E)	66	S0008734	12.93						
	1.7 i (L 48E)	66	H0011575	12.93						
	1.7 i (L 48E)	66	S0005973	12.93						
	1.9 D (B 48H)	47	S0005584	12.92						
	1.9 D (B/L 48I)	47		04.92	12.93					
	1.9 D (B/L 48I)	47	S0002099	10.92						
	1.9 D (L 48H)	47	H0001370	10.92						
	2.1 D (B 480)	53		04.92	12.92 - ABS					
	2.1 D (B 48V)	53	E0006147	12.93						

¹⁾ notice length / attenzione lunghezza / faire attention longueur / atención largo



RENAULT R21 Limousine (B48/L48) (86-93)										
	2.1 D (B 48V)	53	S0060121		12.93		24.3222-1617.3	020324		Rz 22,20 Rz 22,20
	2.1 D (B/L 480)	51		04.92	12.93 - ABS		24.3222-1618.3	020325		
	2.1 D (L 480)	53		04.92	12.93					
	2.1 D (L 48V)	53	H0011782		12.93					
	2.1 D (L 48V)	53	S0022489		12.93					
	2.1 TD (B 486)	65	S0005101		12.92					
	2.1 TD (L 486)	65	H0017035		10.92	- E				
	2.1 TD (L 486)	65	S0040196		10.92	- E				
	2.1 TD (L 486)	65	U0074006		10.92	- E				
	2.1 TD (L 486)	65			10.92	- E				
	1.6 (L 48U)			06.88	12.93 - (MA)		24.3222-1122.3	020335		Rz 22,20 Rz 22,20
	2.0 (L 489)			01.87	03.93		24.3222-1123.3	020336		
	2.0 i (B/L 483)			01.86	12.92 - ABS					
	2.0 i (B/L 48C)	88		06.90	12.93 - ABS					
	2.1 TD (B 487)	65		06.91	12.93 - ABS					
	2.1 TD (B/L 488)	65		01.86	10.92 - ABS					
	2.1 TD (B/L 48A)	65		04.92	12.93 - ABS					
	2.1 TD (B/L 48W)	65		05.89	05.91					
	2.1 TD (L 487)	65		07.91	12.93					
	2.1 TD (L 48P)	65		07.91	03.92 - ABS					
	2.2 i (B/L 48K)	79		08.86	12.93 - ABS					180 x 42 Bremsbacken-Zubehör BDX
	2.2 i (L 48S)	79		06.88	12.93					
	1.4 (B/L 48D)	51		06.88	12.92		03.0137-0209.2	650209		
	1.6 (B 48U)			06.90	03.92		03.0137-9086.2	669086		
	1.6 (L 48U)			06.88	12.93 + (MA)					
	1.7 (B/L 481)	55		01.86	12.92					
	1.7 (B/L 482)	65		01.86	12.92					
	1.7 (B/L 484)			06.90	12.93					
	1.7 (B/L 48J)			01.87	05.91					
	1.7 (L 48M)	54		10.87	05.90					
	1.7 (L 48N)	64		10.87	05.90					229 x 42 HEB Bremsbacken-Zubehör TRW
	1.7 i (B 48F)	54		08.86	12.93					
	1.7 i (B/L 48E)	66		08.86	12.93					
	1.9 D (B/L 48H)	47		05.89	12.92					
	1.9 D (B/L 48I)	47		04.92	12.93					
	2.1 D (B/L 480)	51		04.92	12.93 - ABS					
	2.1 D (B/L 480)	53		04.92	12.93					
	2.1 D (B/L 48V)	53		05.89	12.93					
	2.1 TD (B/L 486)	65		01.86	12.92					
	2.1 TD (B/L 486)	65		01.86	12.92					
	1.6 (L 48U)			06.88	12.93 - (MA)		03.0137-0271.2	650271		229 x 42 HEB Bremsbacken-Zubehör TRW
	1.7 (L 484)			06.90	12.93		03.0137-9027.2	669027		
	2.0 (L 489)			01.87	03.93					
	2.0 i (B/L 483)			01.86	12.92 - ABS					
	2.0 i (B/L 48C)	88		06.90	12.93 - ABS					
	2.1 TD (B 487)	65		06.91	12.93 - ABS					
	2.1 TD (B/L 488)	65		01.86	10.92 - ABS					
	2.1 TD (B/L 48A)	65		04.92	12.93 - ABS					
	2.1 TD (B/L 48W)	65		05.89	05.91					
	2.1 TD (L 487)	65		07.91	12.93					
	2.2 i (B/L 48K)	79		08.86	12.93 - ABS					180/181,3 x 53 - Lager
	2.2 i (L 48S)	79		06.88	12.93					
	1.4 (B/L 48D)	51		06.88	12.92		24.0218-0013.1	480008		
	1.6 (B/L 48U)			06.88	12.93					
	1.7 (B/L 481)	55		01.86	12.92					
	1.7 (B/L 482)	65		01.86	12.92					
	1.7 (B/L 484)			06.90	12.93					
	1.7 (B/L 48J)			01.87	05.91					
	1.7 (L 48M)	54		10.87	05.90					
	1.7 (L 48N)	64		10.87	05.90					
	1.7 i (B 48F)	54		08.86	12.93					229/229,5 x 52,5 229/229,5 x 52,5
	1.7 i (B/L 48E)	66		08.86	12.93					
	1.9 D (B/L 48H)	47		05.89	12.92					
	1.9 D (B/L 48I)	47		04.92	12.93					
	2.1 D (B 480)	53		04.92	12.92 - ABS/ - (MA)					
	2.1 D (B/L 480)	51		04.92	12.93 - ABS					
	2.1 D (B/L 48V)	53		05.89	12.93 - (MA)					
	2.1 D (L 480)	53		04.92	12.93					
	2.1 TD (B/L 486)	65		01.86	12.92					
	2.1 TD (B/L 486)	65		01.86	12.92					
	2.0 (L 489)			01.87	03.93		24.0222-8015.1	480055		229/229,5 x 52,5 229/229,5 x 52,5
	2.0 i (B/L 483)			01.86	12.92 - ABS		24.0222-8019.2	480087		
	2.0 i (B/L 48C)	88		06.90	12.93 - ABS					
	2.1 D (B 480)	53		09.89	12.92 - ABS/ + (MA)					
	2.1 D (B/L 48V)	53		05.89	12.93 + (MA)					
	2.1 TD (B 487)	65		06.91	12.93 - ABS					
	2.1 TD (B/L 488)	65		01.86	10.92 - ABS					
	2.1 TD (B/L 48A)	65		04.92	12.93 - ABS					
	2.1 TD (B/L 48W)	65		05.89	05.91					
	2.1 TD (L 487)	65		07.91	12.93					
	2.2 i (B/L 48K)	79		08.86	12.93 - ABS					22,20/180x42 TopKit BDX
	2.2 i (L 48S)	79		06.88	12.93					
	1.6 (B 48U)	65		06.90	03.92		03.0520-1022.3	691022		
	1.7 (B 482)	65		09.89	12.92 + (MA)					
	1.7 (L 481)	55	S0001313	01.86						
	1.7 (L 481)	55	H0009140	01.86						
	1.7 (L 481)	55	D0003266	01.86						
	1.7 (L 482)	65	U0034082	01.86						
	1.7 (L 482)	65	S0070467	01.86						
	1.7 (L 482)	65	H0043418	01.86						

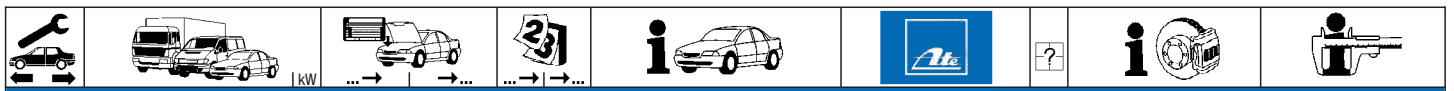

RENAULT R21 Limousine (B48/L48_) (86-93)

	1.7 (L 482)	65	D0024931	01.86		03.0520-1022.3	691022		22,20/180x42 TopKit	BDX	
	1.7 (L 48J)		S0000116	01.87							
	1.7 i (L 48E)	66	H0003449	08.86							
	2.1 TD (L 486)	65	U0020806	01.86							
	2.1 TD (L 486)	65	S0005652	01.86							
	2.1 TD (L 486)	65	H0007702	01.86	- E						
	2.1 TD (L 486)	65		01.86	+ E						
	1.4 (B 48D)	51		09.89	12.93		03.0520-1222.3	691222		22,20/180x42 TopKit	BDX
	1.4 (L 48D)	51		06.88	12.93						
	1.7 (B 481)	55		09.89	12.93						
1.7 (B 482)	65		09.89	12.93	- MA						
1.7 (B 484)			06.90	12.93							
1.7 (B 48J)			09.89	05.91							
1.7 (L 481)	55	D0003267		12.93							
1.7 (L 481)	55	H0009141		12.93							
1.7 (L 481)	55	S0001314		12.93							
1.7 (L 482)	65	D0024932		12.93							
1.7 (L 482)	65	S0070468		12.93							
1.7 (L 482)	65	H0043419		12.93							
1.7 (L 482)	65	U0034083		12.93							
1.7 (L 484)			06.90	12.93							
1.7 (L 48J)		S0000117		12.93							
1.7 (L 48M)	54		10.87	05.90							
1.7 (L 48N)	64		10.87	05.90							
1.7 i (B 48E)	66		09.89	12.93							
1.7 i (B 48F)	54		09.89	12.93							
1.7 i (L 48E)	66	H0003450		12.93							
1.9 D (B 48H)	47		09.89	12.93							
1.9 D (L 48H)	47		05.89	12.93							
1.9 D (L 48I)	47		04.92	12.92							
2.1 D (B 48V)	53		09.89	12.93							
2.1 D (L 48V)	53		05.89	12.93							
2.1 TD (B 486)	65		09.89	12.93							
2.1 TD (L 486)	65	H0007703		12.93							
2.1 TD (L 486)	65	S0005653		12.93							
2.1 TD (L 486)	65	U0020807		12.93							
1.6 (L 48U)			06.88	12.93	- MA	03.0520-1722.3	691722		22,20/229x42 TopKit	TRW	
2.0 (L 489)			01.87	03.93							
2.0 i (B/L 483)			01.86	12.92	- ABS						
2.0 i (B/L 48C)			06.90	12.93	- ABS						
2.1 TD (B 487)	65		06.91	12.93	- ABS						
2.1 TD (B/L 488)	65		01.86	10.92	- ABS						
2.1 TD (B/L 48A)	65		04.92	12.93	- ABS						
2.1 TD (B/L 48W)	65		05.89	05.91							
2.1 TD (L 487)	65		07.91	12.93							
2.1 TD (L 48P)	65		07.91	03.92	- ABS						
2.2 i (B/L 48K)	79		08.86	12.93	- ABS						
2.2 i (L 48S)	79		06.88	12.93							
	1.4 (B/L 48D)	51		06.88	12.92	24.3727-1010.2	581010	2 ↓	L=1467		
	1.6 (B 48U)			06.90	03.92						
	1.6 (L 48U)			06.88	12.93	+ MA					
	1.7 (B/L 481)			01.86	12.92						
	1.7 (B/L 482)	65		01.86	12.92						
	1.7 (B/L 484)			06.90	12.93						
	1.7 (B/L 48J)			01.87	05.91						
	1.7 (L 48M)	54		10.87	05.90						
	1.7 (L 48N)	64		10.87	05.90						
	1.7 i (B 48F)	54		08.86	12.93						
	1.7 i (B/L 48E)	66		08.86	12.93						
	1.9 D (B/L 48H)	47		05.89	12.92						
	1.9 D (B/L 48I)	47		04.92	12.93						
	2.1 D (B 48V)	53		09.89	12.93	- MA					
2.1 D (B/L 480)	51		04.92	12.93							
2.1 D (B/L 480)	53		04.92	12.93							
2.1 D (L 48V)	53		05.89	12.93							
2.1 TD (B/L 486)	65		01.86	12.92							

RENAULT R21 NEVADA (K48_) (86-95)





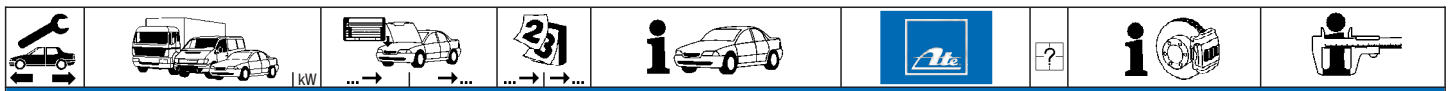











	1.6 (U)			06.88	12.95	03.2119-3389.3	010057		THz 19,05	ATE	
	1.7 (K 481)	55		07.86	12.95						
	1.7 (K 482)	65		07.86	12.95	- E MA					
	1.7 (K 484)			06.90	12.95						
	1.7 (K 48J)			07.86	12.95						
	1.7 (K 48M)	54		10.87	12.95						
	1.7 (K 48N)	64		10.87	12.95						
	1.7 (S 482)	65		07.86	12.95						
	1.7 i (K 48E)			07.86	12.95						
	1.7 i (K 48F)	54		07.86	12.95						
	1.9 D (K 48I)	47		04.92	12.95						
	1.9 D (K/S 48H)	47		05.89	12.95						
	1.7 (K 482)	65		06.92	12.95	- E MA	03.2120-2682.3	010118		THz 20,64	ATE
	1.7 (K 482)	65		07.86	12.95	+ E MA					
1.7 (K 48E)			06.92	12.95							
1.7 (S 481)	55		06.92	12.95							
2.0 i (K 483)	85		07.86	04.89	- ABS						
2.0 i (K 48C)	▶ 88		06.90	12.95	- ABS						
2.1 D (K 486)			07.86	04.89							

























RENAULT R21 NEVADA (K48_) (86-95)

	2.1 D (S 486)		07.86	12.95	03.2120-2682.3	010118		ThZ 20,64	ATE
	2.1 D 4x4 (K 486)	48	07.86	12.95					
	2.1 TD (K 488)	65	07.86	04.89					
	2.2 i (K 48K)	79	07.86	04.89	- ABS				
	2.2 i (K 48S)	79	06.88	04.89					
	2.2 i 4x4 (K 48K)	79	07.86	12.95	- ABS				
	1.7 (K 482)	65	09.90	12.95	+ E (MA)	03.2122-9631.3	010160	ThZ 22,20	ATE
	2.0 i (K 483)	85	05.89	12.95	- ABS				
	2.0 i (K 48C)	88	06.90	12.95	- ABS				
	2.0 i (K 48R)	99	07.91	12.95	- ABS				
	2.1 D (K 480)	51	04.92	12.95	- ABS				
	2.1 D (K 486)		05.89	12.95					
	2.1 D (K 480)	53	04.92	12.95	- ABS				
	2.1 D (K/S 48V)	53	05.89	12.95					
	2.1 D (S 480)	53	04.92	12.95					
	2.1 TD (K 487)	65	06.91	12.95	- ABS				
	2.1 TD (K 488)	65	05.89	12.95					
	2.1 TD (K 48A)	65	04.92	12.95	- ABS				
	2.1 TD (K 48P)	65	06.90	12.95					
	2.1 TD (K 48W)	65	05.89	12.95					
	2.2 i (K 48B)	79	04.93	12.95	- ABS				
	2.2 i (K 48K)	79	05.89	12.95	- ABS				
	2.2 i (K 48S)	79	05.89	12.95					
	1.7 (K/S 481)	55	07.86	12.95		24.3481-1615.5	240031	D=48, - Halter	TRW
	1.7 i (K 48F)	54	07.86	12.95		24.3481-1616.5	240032	D=48, - Halter	TRW
	1.9 D (K 48I)	47	04.92	12.95		24.0101-4806.2	260052	Bremssattel-Zubehör	TRW
	1.9 D (K/S 48H)	47	05.89	12.95					
	1.6 (U)		06.88	12.95		24.3481-1615.5	240031	D=48, - Halter	TRW
	1.7 (K 482)	65	07.86	12.95	- E (MA)	24.3481-1616.5	240032	D=48, - Halter	TRW
	1.7 (K 484)		06.90	12.95		24.0101-4806.2	260052	Bremssattel-Zubehör	TRW
	1.7 (K 48J)		07.86	12.95					
	1.7 (K 48M)	54	10.87	12.95					
	1.7 (K 48N)	64	10.87	12.95					
	1.7 (S 482)	65	07.86	12.95					
	1.7 i (K 48E)		07.86	12.95					
	1.7 (K 482)	65	07.86	12.95	+ E (MA)	24.3541-1625.5	240045	D=54, - Halter	TRW
						24.3541-1626.5	240046	D=54, - Halter	TRW
	1.7 (K/S 481)	55	07.86	12.95		13.0460-3911.2	603911	20905 18,0 +/WK	BDX
	1.7 i (K 48F)	54	07.86	12.95		13.0460-2834.2	602834	21463 18,0 /WK/S	TRW
	1.9 D (K 48I)	47	04.92	12.95		13.0460-0411.2	610411	Belagsatz-Zubehör	BDX
	1.9 D (K/S 48H)	47	05.89	12.95					
	1.6 (U)		06.88	12.95		13.0460-2834.2	602834	21463 18,0 /WK/S	TRW
	1.7 (K 484)		06.90	12.95					
	1.7 (K 48J)		07.86	12.95					
	1.7 (K 48M)	54	10.87	12.95					
	1.7 (K 48N)	64	10.87	12.95					
	1.7 (K/S 482)	65	07.86	12.95					
	1.7 i (K 48E)		07.86	12.95					
	2.0 i (K 483)	85	07.86	12.95		13.0460-3933.2	603933	21016 17,0 +/WK	BDX
	2.0 i (K 48C)	88	06.90	12.95					
	2.0 i (K 48R)	99	07.91	12.95					
	2.1 D (K 480)	51	04.92	12.95					
	2.1 D (K/S 486)		07.86	12.95					
	2.1 D (K/S 480)	53	04.92	12.95					
	2.1 D (K/S 48V)	53	05.89	12.95					
	2.1 TD (K 487)	65	06.91	12.95					
	2.1 TD (K 488)	65	07.86	12.95					
	2.1 TD (K 48A)	65	04.92	12.95					
	2.1 TD (K 48P)	65	06.90	12.95					
	2.1 TD (K 48W)	65	05.89	12.95					
	2.2 i (K 48B)	79	04.93	12.95					
	2.2 i (K 48K)	79	07.86	12.95					
	2.2 i (K 48S)	79	06.88	12.95					
	1.6 (U)		06.88	12.95		24.0120-0125.1	420125	238 20,1 17,7 V +S +B	
	1.7 (K 484)		06.90	12.95					
	1.7 (K 48J)		07.86	12.95					
	1.7 (K 48M)	54	10.87	12.95					
	1.7 (K 48N)	64	10.87	12.95					
	1.7 (K/S 481)	55	07.86	12.95					
	1.7 (K/S 482)	65	07.86	12.95					
	1.7 i (K 48E)		07.86	12.95					
	1.7 i (K 48F)	54	07.86	12.95					
	1.9 D (K 48I)	47	04.92	12.95					
	1.9 D (K/S 48H)	47	05.89	12.95					
	2.0 i (K 483)	85	07.86	12.95		24.0120-0134.1	420134	265 20,5 17,7 V	
	2.0 i (K 48C)	88	06.90	12.95					
	2.1 D (K 480)	51	04.92	12.95	+ ABS				
	2.1 D (K 486)	48	07.86	12.95	+ ABS				
	2.1 D (K 480)	53	04.92	12.95	+ ABS				
	2.1 D (K 48V)	53	05.89	12.95	+ ABS				
	2.1 TD (K 487)	65	06.91	12.95					
	2.1 TD (K 488)	65	07.86	12.95	+ ABS				
	2.1 TD (K 48A)	65	04.92	12.95	+ ABS				
	2.1 TD (K 48P)	65	06.90	12.95					
	2.1 TD (K 48W)	65	05.89	12.95					
	2.2 i (K 48B)	79	04.93	12.95					

								
RENAULT R21 NEVADA (K48_) (86-95)								
	2.2 i (K 48K)	79	07.86	12.95	24.0120-0134.1	420134		265 20,5 17,7 V
	2.2 i (K 48S)	79	06.88	12.95				
	2.0 i (K 48R)	99	07.91	12.95	24.0121-0103.1	421103		285 21,0 19,0 V
	2.1 D (K 480)	51	04.92	12.95 - ABS	24.0120-0135.1	420135		244 20,5 17,7 V
	2.1 D (K 486)	48	07.86	12.95 - ABS				
	2.1 D (K 480)	53	04.92	12.95 - ABS				
	2.1 D (K 48V)	53	05.89	12.95 - ABS				
	2.1 D (S 486)		07.86	12.95				
	2.1 D (S 480)	53	04.92	12.95				
	2.1 D (S 48V)	53	05.89	12.95				
	2.1 TD (K 488)	65	07.86	12.95 - ABS				
	2.1 TD (K 48A)	65	04.92	12.95 - ABS				
	1.6 (U)		06.88	12.95	24.5111-0241.3	330680	2	L=242
	1.7 (K 482)	65	07.86	12.95 - E (MA)				
	1.7 (K 484)		06.90	12.95				
	1.7 (K 48J)		07.86	12.95				
	1.7 (K 48M)	54	10.87	12.95				
	1.7 (K 48N)	64	10.87	12.95				
	1.7 (K/S 481)	55	07.86	12.95				
	1.7 (S 482)	65	07.86	12.95				
	1.7 i (K 48E)		07.86	12.95				
	1.7 i (K 48F)	54	07.86	12.95				
	1.9 D (K 48I)	47	04.92	12.95				
	1.9 D (K/S 48H)	47	05.89	12.95				
	1.7 (K 482)	65	07.86	12.95 + E (MA)	24.5111-0300.3	330407	2	L=300
	2.0 i (K 483)	85	07.86	12.95 - ABS	24.5111-0320.3	330487	2	L=320
	2.0 i (K 48C)	88	06.90	12.95 - ABS				
	2.0 i (K 48R)	99	07.91	12.95 - ABS				
	2.1 D (K 480)	51	04.92	12.95 - ABS				
	2.1 D (K 480)	53	04.92	12.95 - ABS				
	2.1 D (K/S 486)		07.86	12.95				
	2.1 D (K/S 48V)	53	05.89	12.95				
	2.1 D (S 480)	53	04.92	12.95				
	2.1 TD (K 487)	65	06.91	12.95 - ABS				
	2.1 TD (K 488)	65	07.86	12.95				
	2.1 TD (K 48A)	65	04.92	12.95 - ABS				
	2.1 TD (K 48P)	65	06.90	12.95				
	2.1 TD (K 48W)	65	05.89	12.95				
	2.2 i (K 48K)	79	07.86	12.95 - ABS				
	2.2 i (K 48S)	79	06.88	12.95				
	2.0 i (K 483)	85	07.86	12.95 + ABS	24.5111-0320.3	330487	2	L=320
	2.0 i (K 48C)	88	06.90	12.95 + ABS				
	2.0 i (K 48R)	99	07.91	12.95 + ABS				
	2.1 D (K 480)	51	04.92	12.95 + ABS				
	2.1 D (K 480)	53	04.92	12.95 + ABS				
	2.1 TD (K 487)	65	06.91	12.95 + ABS				
	2.1 TD (K 48A)	65	04.92	12.95 + ABS				
	2.2 i (K 48K)	79	07.86	12.95 + ABS				
	2.0 i (K 483)	85	05.87	12.95	24.0711-1403.3	360100		Radsensor L=1289
	2.0 i (K 48C)	88	06.91	12.95				
	2.0 i (K 48R)	99	07.91	12.95				
	2.1 D (K 480)	51	04.92	12.95				
	2.1 D (K 480)	53	04.92	12.95				
	2.1 D (K 48V)	53	05.89	12.95				
	2.1 TD (K 487)	65	06.91	12.95				
	2.1 TD (K 48A)	65	04.92	12.95				
	2.2 i (K 48B)	79	04.93	12.95				
	2.2 i (K 48K)	79	03.87	12.95				
	2.0 i (K 483)	85	07.86	12.95 + ABS	13.0460-3961.2	603961		20336 14,0 +/-WK BDX
	2.0 i (K 48C)	88	06.90	12.95 + ABS	13.0460-4957.2	604957		20410 15,0 + BRE
	2.0 i (K 48R)	99	07.91	12.95	13.0460-0438.2	610438		Belagsatz-Zubehör BRE
	2.1 D (K 480)	51	04.92	12.95 + ABS				
	2.1 TD (K 487)	65	06.91	12.95 + ABS				
	2.2 i (K 48B)	79	04.93	12.95 + ABS				
	2.2 i (K 48K)	79	07.86	12.95 + ABS				
	2.0 i (K 483)	85	07.86	12.95 + ABS	24.0111-0122.1	411122		255 10,5 9,5
	2.0 i (K 48C)	88	06.90	12.95 + ABS				
	2.0 i (K 48R)	99	07.91	12.95				
	2.1 D (K 480)	51	04.92	12.95 + ABS				
	2.1 TD (K 487)	65	06.91	12.95 + ABS				
	2.2 i (K 48B)	79	04.93	12.95 + ABS				
	2.2 i (K 48K)	79	07.86	12.95 + ABS				
	1.6 (U)		06.88	12.95	24.5229-0220.3	330399	2	L=220
	1.7 (K 484)		06.90	12.95				
	1.7 (K 48J)		07.86	12.95				
	1.7 (K 48M)	54	10.87	12.95				
	1.7 (K 48N)	64	10.87	12.95				
	1.7 (K/S 481)	55	07.86	12.95				
	1.7 (K/S 482)	65	09.90	12.95				
	1.7 i (K 48E)		07.86	12.95				
	1.7 i (K 48F)	54	07.86	12.95				
	1.9 D (K 48I)	47	04.92	12.95				
	1.9 D (K/S 48H)	47	05.89	12.95				
	2.0 i (K 483)	85	05.89	12.95 - ABS				
	2.0 i (K 48C)	88	06.90	12.95 - ABS				
	2.0 i (K 48R)	99	07.91	12.95 - ABS				

RENAULT R21 NEVADA (K48_) (86-95)											
											
	2.1 D (K 480)	51		04.92	12.95	- ABS	24.5229-0220.3	330399	2		L=220
	2.1 D (K 486)			05.89	12.95						
	2.1 D (K 480)	53		04.92	12.95	- ABS					
	2.1 D (K/S 48V)	53		05.89	12.95						
	2.1 D (S 480)	53		04.92	12.95						
	2.1 TD (K 487)	65		06.91	12.95	- ABS					
	2.1 TD (K 488)	65		05.89	12.95						
	2.1 TD (K 48A)	65		04.92	12.95	- ABS					
	2.1 TD (K 48P)	65		06.90	12.95						
	2.1 TD (K 48W)	65		05.89	12.95						
	2.2 i (K 48B)	79		04.93	12.95	- ABS					
	2.2 i (K 48K)	79		05.89	12.95	- ABS					
	2.2 i (K 48S)	79		05.89	12.95						
	2.0 i (K 483)	85		07.86	12.95	+ ABS	24.5229-0220.3	330399	2	Länge beachten ¹⁾	L=220
	2.0 i (K 48C)	88		06.90	12.95	+ ABS	24.5111-0260.3	330408	2	Länge beachten ¹⁾	L=260
	2.0 i (K 48R)	99		07.91	12.95	+ ABS	24.5229-0285.3	330032	2	Länge beachten ¹⁾	L=285
	2.1 D (K 480)	51		04.92	12.95	+ ABS					
	2.1 D (K 480)	53		04.92	12.95	+ ABS					
	2.1 TD (K 487)	65		06.91	12.95	+ ABS					
	2.1 TD (K 48A)	65		04.92	12.95	+ ABS					
	2.2 i (K 48B)	79		04.93	12.95	+ ABS					
	2.2 i (K 48K)	79		07.86	12.95	+ ABS					
	1.6 (U)			06.88	12.95		24.3222-1122.3	020335	<input type="checkbox"/>		Rz 22,20
	1.7 (K 484)			06.90	12.95		24.3222-1123.3	020336	<input type="checkbox"/>		Rz 22,20
	1.7 (K 48J)			07.86	12.95						
	1.7 (K 48M)	54		10.87	12.95						
	1.7 (K 48N)	64		10.87	12.95						
	1.7 (K/S 481)	55		07.86	12.95						
	1.7 (K/S 482)	65		07.86	12.95						
	1.7 i (K 48E)			07.86	12.95						
	1.7 i (K 48F)	54		07.86	12.95						
	1.9 D (K 48I)	47		04.92	12.95						
	1.9 D (K/S 48H)	47		05.89	12.95						
	2.0 i (K 483)	85		07.86	12.95	- ABS					
	2.0 i (K 48C)	88		06.90	12.95	- ABS					
	2.1 D (K 480)	51		04.92	12.95	- ABS					
	2.1 D (K 486)			07.86	12.95						
	2.1 D (K/S 480)	53		04.92	12.95						
	2.1 D (K/S 48V)	53		05.89	12.95						
	2.1 D (S 486)			07.86	12.95						
	2.1 TD (K 487)	65		06.91	12.95	- ABS					
	2.1 TD (K 488)	65		07.86	12.95						
	2.1 TD (K 48A)	65		04.92	12.95						
	2.1 TD (K 48P)	65		06.90	12.95						
	2.1 TD (K 48W)	65		05.89	12.95						
	2.2 i (K 48B)	79		04.93	12.95	- ABS					
	2.2 i (K 48K)	79		07.86	12.95	- ABS					
	2.2 i (K 48S)	79		06.88	12.95						
	1.6 (U)			06.88	12.95		03.0137-0271.2	650271			229 x 42 HEB TRW
	1.7 (K 484)			06.90	12.95		03.0137-9027.2	669027			Bremsbacken-Zubehör TRW
	1.7 (K 48J)			07.86	12.95						
	1.7 (K 48M)	54		10.87	12.95						
	1.7 (K 48N)	64		10.87	12.95						
	1.7 (K/S 481)	55		07.86	12.95						
	1.7 (K/S 482)	65		07.86	12.95						
	1.7 i (K 48E)			07.86	12.95						
	1.7 i (K 48F)	54		07.86	12.95						
	1.9 D (K 48I)	47		04.92	12.95						
	1.9 D (K/S 48H)	47		05.89	12.95						
	2.0 i (K 483)	85		07.86	12.95	- ABS					
	2.0 i (K 48C)	88		06.90	12.95	- ABS					
	2.1 D (K 480)	51		04.92	12.95	- ABS					
	2.1 D (K 486)			07.86	12.95						
	2.1 D (K/S 480)	53		04.92	12.95						
	2.1 D (K/S 48V)	53		05.89	12.95						
	2.1 D (S 486)			07.86	12.95						
	2.1 TD (K 487)	65		06.91	12.95	- ABS					
	2.1 TD (K 488)	65		07.86	12.95						
	2.1 TD (K 48A)	65		04.92	12.95						
	2.1 TD (K 48P)	65		06.90	12.95						
	2.1 TD (K 48W)	65		05.89	12.95						
	2.2 i (K 48B)	79		04.93	12.95	- ABS					
	2.2 i (K 48K)	79		07.86	12.95	- ABS					
	2.2 i (K 48S)	79		06.88	12.95						
	1.6 (U)			06.88	12.95		24.0222-8015.1	480055			229/229,5 x 52,5
	1.7 (K 484)			06.90	12.95		24.0222-8019.2	480087			229/229,5 x 52,5
	1.7 (K 48J)			07.86	12.95						
	1.7 (K 48M)	54		10.87	12.95						
	1.7 (K 48N)	64		10.87	12.95						
	1.7 (K/S 481)	55		07.86	12.95						
	1.7 (K/S 482)	65		07.86	12.95						
	1.7 i (K 48E)			07.86	12.95						
	1.7 i (K 48F)	54		07.86	12.95						
	1.9 D (K 48I)	47		04.92	12.95						
	1.9 D (K/S 48H)	47		05.89	12.95						
	2.0 i (K 483)	85		07.86	12.95	- ABS					
	2.0 i (K 48C)	88		06.90	12.95	- ABS					













¹⁾ notice length / attenzione lunghezza / faire attention longueur / atención largo

RENAULT R21 NEVADA (K48_) (86-95)										
	2.1 D (K 480)	51	04.92	12.95	- ABS	24.0222-8015.1	480055		229/229,5 x 52,5	
	2.1 D (K 486)		07.86	12.95		24.0222-8019.2	480087		229/229,5 x 52,5	
	2.1 D (K/S 480)	53	04.92	12.95						
	2.1 D (K/S 48V)	53	05.89	12.95						
	2.1 D (S 486)		07.86	12.95						
	2.1 TD (K 487)	65	06.91	12.95	- ABS					
	2.1 TD (K 488)	65	07.86	12.95						
	2.1 TD (K 48A)	65	04.92	12.95						
	2.1 TD (K 48P)	65	06.90	12.95						
	2.1 TD (K 48W)	65	05.89	12.95						
	2.2 i (K 48B)	79	04.93	12.95	- ABS					
	2.2 i (K 48K)	79	07.86	12.95	- ABS					
	2.2 i (K 48S)	79	06.88	12.95						
	1.6 (U)		06.88	12.95		03.0520-1722.3	691722		22,20/229x42 TopKit	TRW
	1.7 (K 484)		06.90	12.95						
	1.7 (K 48J)		07.86	12.95						
	1.7 (K 48M)	54	10.87	12.95						
	1.7 (K 48N)	64	10.87	12.95						
	1.7 (K/S 481)	55	07.86	12.95						
	1.7 (K/S 482)	65	07.86	12.95						
	1.7 i (K 48E)		07.86	12.95						
	1.7 i (K 48F)	54	07.86	12.95						
	1.9 D (K 48I)	47	04.92	12.95						
	1.9 D (K/S 48H)	47	05.89	12.95						
	2.0 i (K 483)	85	07.86	12.95	- ABS					
	2.0 i (K 48C)	88	06.90	12.95	- ABS					
	2.1 D (K 480)	51	04.92	12.95	- ABS					
	2.1 D (K 486)		07.86	12.95						
	2.1 D (K/S 480)	53	04.92	12.95						
	2.1 D (K/S 48V)	53	05.89	12.95						
	2.1 D (S 486)		07.86	12.95						
	2.1 TD (K 487)	65	06.91	12.95	- ABS					
	2.1 TD (K 488)	65	07.86	12.95						
	2.1 TD (K 48A)	65	04.92	12.95						
	2.1 TD (K 48P)	65	06.90	12.95						
	2.1 TD (K 48W)	65	05.89	12.95						
	2.2 i (K 48B)	79	04.93	12.95	- ABS					
	2.2 i (K 48K)	79	07.86	12.95	- ABS					
	2.2 i (K 48S)	79	06.88	12.95						
RENAULT R25 (84-92)										
	2.0 (B297)		01.84	12.92	- ABS	24.2120-1709.3	010276		THz 20,64	
	2.0 i (B29H)		01.87	12.92	- ABS					
	2.1 D (B296)		01.84	12.92	- ABS					
	2.1 TD (B290)		01.84	12.92	- ABS					
	2.1 TD (B29W)		06.89	02.90						
	2.2 i (B29B)		06.87	05.88						
	2.2 i (B29B)		06.88	12.92	- ABS					
	2.2 i (B29E)		06.87	05.88						
	2.2 i (B29E)		06.88	06.89	- ABS					
	2.0 i (B292)		06.88	12.92		24.2122-1501.3	010403		THz 22,20	
	2.0 i (B294)		02.90	12.92						
	2.2 i (B29B)		01.86	05.87		24.2123-1702.3	010431		THz 23,81	
	2.2 i (B29E)		01.84	05.87						
	2.5 T (B295)		01.85	06.89						
	2.5 T (B29G)		06.89	12.92						
	2.7 V6 (B298)		01.85	05.89						
	2.8 V6 (B293)		06.87	06.89						
	2.8 V6 (B29A)		01.87	05.88						
	2.8 V6 (B29F)		06.87	12.92						
	2.0 (B297)		01.84	12.92		24.3541-1625.5	240045		D=54, - Halter	TRW
	2.0 i (B292)		06.88	12.92		24.3541-1626.5	240046		D=54, - Halter	TRW
	2.0 i (B294)		02.90	12.92						
	2.0 i (B29H)		01.87	12.92						
	2.1 D (B296)		01.84	12.92						
	2.1 TD (B290)		01.84	12.92						
	2.1 TD (B29W)		06.89	02.90						
	2.2 i (B29B)		01.86	05.88	- ABS					
	2.2 i (B29B)		06.87	05.88	+ ABS					
	2.2 i (B29B)		06.88	12.92						
	2.2 i (B29E)		01.84	05.88	- ABS					
	2.2 i (B29E)		06.87	05.88	+ ABS					
	2.2 i (B29E)		06.88	06.89						
	2.0 (B297)		01.84	12.92		13.0460-2834.2	602834		21463 18,0 /WK/S	TRW
	2.0 i (B292)		06.88	12.92						
	2.0 i (B294)		02.90	12.92						
	2.0 i (B29H)		01.87	12.92						
	2.1 D (B296)		01.84	12.92						
	2.1 TD (B290)		01.84	12.92						
	2.1 TD (B29W)		06.89	02.90						
	2.2 i (B29B)		01.86	05.88	- ABS					
	2.2 i (B29B)		06.87	05.88	+ ABS					
	2.2 i (B29B)		06.88	12.92						
	2.2 i (B29E)		01.84	05.88	- ABS					
	2.2 i (B29E)		06.87	05.88	+ ABS					
	2.2 i (B29E)		06.88	06.89						

























RENAULT R25 (84-92)

	2.2 i (B29B) 2.2 i (B29E) 2.5 T (B295) 2.5 T (B29G) 2.7 V6 (B298) 2.8 V6 (B293) 2.8 V6 (B29A) 2.8 V6 (B29F)			01.86 01.84 01.85 06.89 01.84 06.87 01.87 06.87	05.87 + ABS 05.87 + ABS 06.89 12.92 05.89 06.89 05.88 12.92	13.0460-2983.2	602983			21388 18,0 +WK/S	TRW
	2.0 (B297) 2.0 i (B292) 2.0 i (B294) 2.0 i (B29H) 2.1 D (B296) 2.1 TD (B290) 2.1 TD (B29W) 2.2 i (B29B) 2.2 i (B29B) 2.2 i (B29E) 2.2 i (B29E) 2.2 i (B29E)			01.84 06.88 02.90 01.87 01.84 01.84 06.89 01.86 06.87 06.88 06.87 06.88	12.92 12.92 12.92 12.92 12.92 12.92 02.90 05.88 - ABS 05.88 + ABS 12.92 05.88 - ABS 05.88 + ABS 06.89	24.0120-0126.1	420126			259 20,2 17,7 V +B	
	2.2 i (B29B) 2.2 i (B29E) 2.5 T (B295) 2.5 T (B29G) 2.7 V6 (B298) 2.8 V6 (B293) 2.8 V6 (B29A) 2.8 V6 (B29F)			01.86 01.84 01.85 06.89 01.84 06.87 01.87 06.87	05.87 + ABS 05.87 + ABS 06.89 12.92 05.89 06.89 05.88 12.92	24.0122-0143.1	422143			280 22,0 20,0 V	
	2.0 (B297) 2.0 i (B292) 2.0 i (B294) 2.0 i (B29H) 2.1 D (B296) 2.1 TD (B290) 2.1 TD (B29W) 2.2 i (B29B) 2.2 i (B29E) 2.5 T (B295) 2.5 T (B29G) 2.7 V6 (B298) 2.8 V6 (B293) 2.8 V6 (B29A) 2.8 V6 (B29F)			09.84 06.88 02.90 01.87 09.84 09.84 06.89 01.86 09.84 01.85 06.89 09.84 06.87 01.87 06.87	12.92 12.92 12.92 12.92 12.92 12.92 02.90 12.92 06.89 06.89 12.92 05.89 06.89 05.88 12.92	24.5111-0405.3	330410	2		L=405	
	2.0 (B297) 2.0 i (B292) 2.0 i (B294) 2.0 i (B29H) 2.1 D (B296) 2.1 TD (B290) 2.1 TD (B29W) 2.2 i (B29B) 2.2 i (B29E) 2.5 T (B295) 2.5 T (B29G) 2.7 V6 (B298) 2.8 V6 (B293) 2.8 V6 (B29A) 2.8 V6 (B29F)			01.84 06.88 02.90 01.87 01.84 01.84 06.89 01.86 01.84 01.85 06.89 01.84 06.87 01.87 06.87	12.92 + ABS 12.92 12.92 12.92 + ABS 12.92 + ABS 12.92 + ABS 02.90 + ABS 12.92 + ABS 06.89 + ABS 06.89 12.92 05.89 06.89 05.88 12.92	13.0460-3961.2	603961			20336 14,0 +WK	BDX
	2.0 (B297) 2.0 i (B292) 2.0 i (B294) 2.0 i (B29H) 2.1 D (B296) 2.1 TD (B290) 2.1 TD (B29W) 2.2 i (B29B) 2.2 i (B29E)			01.84 06.88 02.90 01.87 01.84 01.84 06.89 06.87 06.87	12.92 + ABS 12.92 12.92 12.92 + ABS 12.92 + ABS 12.92 + ABS 02.90 + ABS 12.92 + ABS 06.89 + ABS	24.0112-0134.1	412134			254 12,0 10,5	
	2.2 i (B29B) 2.2 i (B29E) 2.5 T (B295) 2.5 T (B29G) 2.7 V6 (B298) 2.8 V6 (B293) 2.8 V6 (B29A) 2.8 V6 (B29F)			01.86 01.84 01.85 06.89 01.84 06.87 01.87 06.87	05.87 + ABS 05.87 + ABS 06.89 12.92 05.89 06.89 05.88 12.92	24.0112-0133.1	412133			254 12,0 10,5	
	2.0 (B297) 2.0 i (B292) 2.0 i (B294) 2.0 i (B29H) 2.1 D (B296) 2.1 TD (B290) 2.1 TD (B29W) 2.2 i (B29B) 2.2 i (B29E) 2.5 T (B295)			01.84 06.88 02.90 01.87 01.84 01.84 06.89 01.86 01.84 01.85	12.92 - ABS 12.92 - ABS 12.92 - ABS 12.92 - ABS 12.92 - ABS 12.92 - ABS 02.90 - ABS 12.92 - ABS 06.89 - ABS 06.89 - ABS	24.5229-0240.3	330400	2	▣	L=242	

RENAULT R25 (84-92)									
	2.7 V6 (B298) 2.8 V6 (B293) 2.8 V6 (B29A) 2.8 V6 (B29F)		01.84 05.89 - ABS 06.87 05.88 - ABS 01.87 05.88 - ABS 06.87 05.88 - ABS	24.5229-0240.3	330400	2		L=242	
	2.0 (B297) 2.0 i (B292) 2.0 i (B294) 2.0 i (B29H) 2.1 D (B296) 2.1 TD (B290) 2.1 TD (B29W) 2.2 i (B29B) 2.2 i (B29E) 2.5 T (B295) 2.5 T (B29G) 2.7 V6 (B298) 2.8 V6 (B293) 2.8 V6 (B29A) 2.8 V6 (B29F)		01.84 12.92 + ABS 06.88 12.92 + ABS 02.90 12.92 + ABS 01.87 12.92 + ABS 01.84 12.92 + ABS 01.84 12.92 + ABS 06.89 02.90 + ABS 01.86 12.92 + ABS 01.84 06.89 + ABS 01.85 06.89 + ABS 06.89 12.92 + ABS 01.84 05.89 + ABS 06.87 06.89 + ABS 01.87 05.88 + ABS 06.87 12.92 + ABS	24.5229-0240.3 24.5111-0150.3	330400 330497	2 2		L=242 L=150	
	2.0 (B297) 2.0 i (B29H) 2.1 D (B296) 2.1 TD (B290) 2.1 TD (B29W) 2.2 i (B29B) 2.2 i (B29E)		01.84 12.92 - ABS 01.87 12.92 - ABS 01.84 12.92 - ABS 01.84 12.92 - ABS 06.89 02.90 - ABS 01.86 12.92 - ABS 01.84 06.89 - ABS	24.3222-1108.3 24.3222-1109.3	020263 020264	<input type="checkbox"/> <input type="checkbox"/>		Rz 22,20 Rz 22,20	BDX BDX
	2.0 (B297) 2.0 i (B29H) 2.1 D (B296) 2.1 TD (B290) 2.1 TD (B29W) 2.2 i (B29B) 2.2 i (B29E)		01.84 12.92 - ABS 01.87 12.92 - ABS 01.84 12.92 - ABS 01.84 12.92 - ABS 06.89 02.90 - ABS 01.86 12.92 - ABS 01.84 06.89 - ABS	03.0137-0139.2 03.0137-0124.2 03.0137-0271.2 03.0137-9020.2	650139 650124 650271 669020			229 x 42 229 x 42 HEB AUT 229 x 42 HEB Bremsbacken-Zubehör	BDX BDX TRW BDX
	2.0 (B297) 2.0 i (B29H) 2.1 D (B296) 2.1 TD (B290) 2.1 TD (B29W) 2.2 i (B29B) 2.2 i (B29E)		01.84 12.92 - ABS 01.87 12.92 - ABS 01.84 12.92 - ABS 01.84 12.92 - ABS 06.89 02.90 - ABS 01.86 12.92 - ABS 01.84 06.89 - ABS	24.0222-8015.1 24.0222-8019.2	480055 480087			229/229,5 x 52,5 229/229,5 x 52,5	
	2.0 (B297) 2.0 i (B29H) 2.1 D (B296) 2.1 TD (B290) 2.1 TD (B29W) 2.2 i (B29B) 2.2 i (B29E)		01.84 12.92 - ABS 01.87 12.92 - ABS 01.84 12.92 - ABS 01.84 12.92 - ABS 06.89 02.90 - ABS 01.86 12.92 - ABS 01.84 06.89 - ABS	03.0520-0522.3	690522			22,20/229x42 TopKit	BDX
	2.0 (B297) 2.0 i (B292) 2.0 i (B294) 2.0 i (B29H) 2.1 D (B296) 2.1 TD (B290) 2.1 TD (B29W) 2.2 i (B29B) 2.2 i (B29E)		01.84 12.92 - ABS 06.88 12.92 - ABS 02.90 12.92 - ABS 01.87 12.92 - ABS 01.84 12.92 - ABS 01.84 12.92 - ABS 06.89 02.90 - ABS 01.86 12.92 - ABS 01.84 06.89 - ABS	24.3727-1036.2	581036	2		L=1020	
	2.0 (B297) 2.0 i (B292) 2.0 i (B294) 2.0 i (B29H) 2.1 D (B296) 2.1 TD (B290) 2.1 TD (B29W) 2.2 i (B29B) 2.2 i (B29E) 2.5 T (B295) 2.5 T (B29G) 2.7 V6 (B298) 2.8 V6 (B293) 2.8 V6 (B29A) 2.8 V6 (B29F)		01.84 12.92 + ABS 06.88 12.92 + ABS 02.90 12.92 + ABS 01.87 12.92 + ABS 01.84 12.92 + ABS 01.84 12.92 + ABS 06.89 02.90 + ABS 01.86 12.92 + ABS 01.84 06.89 + ABS 01.85 06.89 06.89 12.92 01.86 05.89 06.87 06.89 01.87 05.88 06.87 12.92	24.3727-1037.2	581037	2		L=1090	
	2.2 i (B29E) 2.7 V6 (B298)		01.84 05.88 01.84 05.88	24.2528-0908.3	040065			Nz 28,57	
RENAULT R30 (75-84)									
	2.1 TD (R1270)	63	01.82 12.84	24.2120-1709.3	010276			THz 20,64	
	2.1 TD (R1270)	63	01.82 12.84	24.3541-1625.5 24.3541-1626.5	240045 240046	<input type="checkbox"/> <input type="checkbox"/>		D=54, - Halter D=54, - Halter	TRW TRW
	2.1 TD (R1270)	63	01.82 12.84	13.0460-2834.2	602834			21463 18,0 /WK/S	TRW



								
RENAULT R30 (75-84)								
	2.6 V6 (R1275)	94		01.75	12.84	24.0124-0103.1	424103	253 24,0 22,0 V +B
	2.6 V6 (R1275)	94		01.75	12.84	13.0460-3961.2	603961	20336 14,0 +/WK BDX
	2.1 TD (R1270)	63		01.82	12.84	24.3222-1108.3 24.3222-1109.3	020263 020264	Rz 22,20 BDX Rz 22,20 BDX
	2.1 TD (R1270)	63		01.82	12.84	03.0137-0139.2 03.0137-0124.2 03.0137-0271.2 03.0137-9020.2	650139 650124 650271 669020	229 x 42 BDX 229 x 42 HEB AUT BDX 229 x 42 HEB TRW Bremsbacken-Zubehör BDX
	2.1 TD (R1270)	63		01.82	12.84	03.0520-0522.3	690522	22,20/229x42 TopKit BDX
	2.6 V6 (R1275)	94		01.75	12.84	24.2528-0908.3	040065	Nz 28,57
RENAULT TRAFIC I Bus (T5/T6/T7) (80-89)								
	1.4 1.6 1.6 4x4 1.7 2.0 2.0 2.0 4x4 2.1 D 2.1 D 4X4	35 48 48 50 58 59 59 43 43		03.80 01.84 03.80 06.86 07.80 06.86 06.86 03.86 05.85	04.89 06.86 08.86 04.89 04.85 04.89 04.89 04.89 02.89	03.2120-1142.3	010085	THz 20,64 ATE
	1.4 1.6 1.6 4x4 1.7 2.0 2.0 2.1 D 2.1 D 4X4	35 48 48 50 58 59 43 43		01.85 01.85 01.85 06.86 01.85 01.85 01.85 05.85	04.89 06.86 08.86 04.89 04.85 04.89 04.89 02.89	13.0460-3969.2	603969	20926 18,5 /WK BDX
	1.4 1.6 1.6 4x4 1.7 2.0 2.0 2.1 D 2.1 D 4X4	35 48 48 50 58 59 43 43		03.80 01.84 03.80 06.86 07.80 03.80 03.80 05.85	04.89 06.86 08.86 04.89 04.85 04.89 04.89 02.89	24.0124-0103.1	424103	253 24,0 22,0 V +B
	1.4 1.6 1.6 4x4 1.7 2.0 2.0 2.0 4x4 2.1 D 2.1 D 4X4	35 48 48 50 58 59 59 43 43		03.80 01.84 03.80 06.86 07.80 06.86 06.86 03.85 05.85	04.89 06.86 08.86 04.89 04.85 04.89 04.89 04.89 02.89	24.5111-0320.3	330487 4	L=320
	1.4 1.6 1.6 4x4 1.7 2.0 2.0 2.0 4x4 2.1 D 2.1 D 4X4	35 48 48 50 58 59 59 43 43		03.80 01.84 03.80 06.86 07.80 06.86 06.86 03.85 05.85	04.89 06.86 08.86 04.89 04.85 04.89 04.89 04.89 02.89	24.5111-0386.3	330503 1	L=385
	1.4 1.6 1.6 4x4 1.7 2.0 2.0 2.0 4x4 2.1 D 2.1 D 4X4	35 48 48 50 58 59 59 43 43		03.80 01.84 03.80 06.86 07.80 06.86 06.86 03.85 05.85	04.89 06.86 08.86 04.89 04.85 04.89 04.89 04.89 02.89	24.3223-1106.3	020317	Rz 23,81 BDX
	1.4 1.6 1.6 4x4 1.7 2.0 2.0 2.0 4x4 2.1 D 2.1 D 4X4	35 48 48 50 58 59 59 43 43		03.80 01.84 03.80 06.86 07.80 06.86 06.86 03.85 05.85	04.89 06.86 08.86 04.89 04.85 04.89 04.89 04.89 02.89	03.0137-0153.2 03.0137-9211.2	650153 669211	255 x 46 AUT BDX Bremsbacken-Zubehör BDX

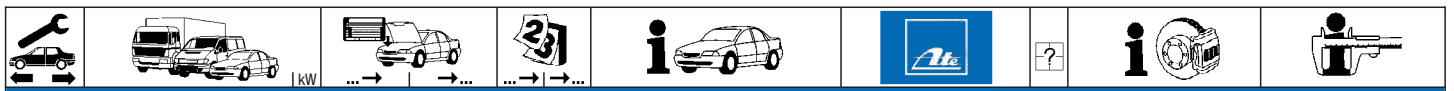

RENAULT TRAFIC I Bus (T5/T6/T7) (80-89)

	1.4 1.6 1.6 4x4 1.7 2.0 2.0 2.0 4x4 2.1 D 2.1 D 4X4	35 48 48 50 58 59 59 43 43		03.80 04.89 01.84 06.86 03.80 08.86 06.86 04.89 07.80 04.85 06.86 04.89 06.86 04.89 03.85 04.89 05.85 02.89	03.0520-0723.3 690723		23,81 /255x45 TopKit BDX
	1.4 1.6 1.6 4x4 1.7 2.0 2.0 2.0 4x4 2.1 D 2.1 D 4X4	35 48 48 50 58 59 59 43 43		03.80 04.89 01.84 06.86 03.80 06.86 06.86 04.89 07.80 04.85 06.86 04.89 06.86 04.89 03.85 04.89 05.85 02.89	03.6512-0100.3 320077		BRL 1/2 (2) ATE
	1.6 4x4 2.0 4x4	48 59		03.80 06.86 06.86 12.86	24.2528-0908.3 040065		Nz 28,57

RENAULT TRAFIC I Kasten (T1/T2/T3/T4) (80-89)

	1.4 1.6 1.6 4x4 1.7 2.0 2.0 2.0 2.0 4x4 2.1 D 2.1 D	35 48 48 50 58 59 60 59 43 43		03.80 04.89 01.83 06.86 08.85 06.86 06.86 04.89 07.80 04.85 06.86 04.89 05.85 02.89 06.86 04.89 09.80 04.89 05.86 02.89	03.2120-1142.3 010085		Thz 20,64 ATE
	1.4 1.6 1.7 2.0 2.0 2.0 2.1 D (T1--) 2.1 D (T1--) 2.1 D (T3--) 2.1 D (T3--) 2.1 D (T4--) 2.1 D (T4--)	35 48 50 58 59 60 43 43 43 43 43 43	0046160 0027230 0038050	03.80 04.89 01.83 06.86 06.86 04.89 07.80 04.85 03.80 04.89 05.85 02.89 09.80 04.89 09.80 04.89 + A (OK) 09.80 04.89 09.80 04.89 + B (D E F N) 09.80 04.89 09.80 04.89	13.0460-3968.2 603968		20488 18,5 +/WK BDX
	1.4 1.6 1.6 4x4 1.7 2.0 2.0 2.0 2.0 4x4 2.1 D 2.1 D 2.1 D 4x4	35 48 48 50 58 59 60 59 43 43 43		03.80 04.89 01.83 06.86 08.85 06.86 06.86 04.89 07.80 04.85 03.80 04.89 05.85 02.89 03.80 04.89 09.80 04.89 05.86 02.89 11.86 04.89	24.0124-0103.1 424103		253 24,0 22,0 V +B
	1.4 1.6 1.6 4x4 1.7 2.0 2.0 2.0 2.0 4x4 2.1 D 2.1 D 2.1 D 4x4	35 48 48 50 58 59 60 59 43 43 43		03.80 04.89 01.83 06.86 08.85 06.86 06.86 04.89 07.80 04.85 06.86 04.89 05.85 02.89 06.86 04.89 09.80 04.89 05.86 02.89 11.86 04.89	24.5111-0320.3 330487 4		L=320
	1.4 1.6 1.6 4x4 1.7 2.0 2.0 2.0 2.0 4x4 2.1 D 2.1 D 2.1 D 4x4	35 48 48 50 58 59 60 59 43 43 43		03.80 04.89 01.83 06.86 08.85 06.86 06.86 04.89 07.80 04.85 06.86 04.89 05.85 02.89 06.86 04.89 09.80 04.89 05.86 02.89 11.86 04.89	24.5111-0320.3 330487 1 <input type="checkbox"/>		L=320
	1.4 1.6 1.6 4x4 1.7 2.0 2.0 2.0 2.0 4x4	35 48 48 50 58 59 60 59		03.80 04.89 01.83 06.86 08.85 06.86 06.86 04.89 07.80 04.85 06.86 04.89 05.85 02.89 06.86 04.89	24.3222-1118.3 020315		Rz 22,20 BDX
↓	↓						





RENAULT TRAFIC I Kasten (T1/T2/T3/T4) (80-89)

	2.1 D (T1--)	▶ 43	0046160	09.80		24.3222-1118.3	020315		Rz 22,20	BDX								
	2.1 D (T1--)	◀ 43		09.80	04.89						- A CH DK							
	2.1 D (T3--)	▶ 43	0027230	09.80														
	2.1 D (T3--)	◀ 43		09.80	04.89						+ B D E F N							
	2.1 D (T4--)	▶ 43	0038050	09.80														
	2.1 D (T4--)	◀ 43		09.80	04.89													
	2.1 D (T1--)	◀ 43		09.80	04.89	+ CH	24.3223-1106.3	020317	Rz 23,81	BDX								
	2.1 D (T1--)	▶ 43	0046161	09.80	04.89													
	2.1 D (T3--)	◀ 43		09.80	04.89	+ CH												
	2.1 D (T3--)	▶ 43	0027231	09.80	04.89													
	2.1 D (T4--)	◀ 43		09.80	04.89	+ CH												
	2.1 D (T4--)	▶ 43	0038051	09.80	04.89													
	1.4	35		03.80	04.89	03.0137-0153.2	650153	255 x 46 AUT	BDX									
	1.6	48		01.83	06.86					03.0137-9211.2	669211	Bremsbacken-Zubehör	BDX					
	1.6 4x4	48		08.85	06.86													
	1.7	50		06.86	04.89													
	2.0	58		07.80	04.85													
	2.0	59		06.86	04.89													
	2.0	60		05.85	02.89													
	2.0 4x4	59		06.86	04.89													
	2.1 D (T1--)	▶ 43	0046160	09.80														
	2.1 D (T1--)	◀ 43		09.80	04.89									- A CH DK				
	2.1 D (T3--)	▶ 43	0027230	09.80														
	2.1 D (T3--)	◀ 43		09.80	04.89									+ B D E F N				
	2.1 D (T4--)	▶ 43	0038050	09.80														
	2.1 D (T4--)	◀ 43		09.80	04.89													
	2.1 D (T1--)	◀ 43		09.80	04.89									+ CH	03.0137-0153.2	650153	255 x 46 AUT	BDX
	2.1 D (T1--)	▶ 43	0046161	09.80	04.89													
	2.1 D (T3--)	◀ 43		09.80	04.89									+ CH				
	2.1 D (T3--)	▶ 43	0027231	09.80	04.89													
2.1 D (T4--)	◀ 43		09.80	04.89	+ CH													
2.1 D (T4--)	▶ 43	0038051	09.80	04.89														
	2.1 D (T1--)	◀ 43		09.80	04.89	+ CH	03.0520-0723.3	690723	23,81/255x45 TopKit	BDX								
	2.1 D (T1--)	▶ 43	0046161	09.80	04.89													
	2.1 D (T3--)	◀ 43		09.80	04.89	+ CH												
	2.1 D (T3--)	▶ 43	0027231	09.80	04.89													
	2.1 D (T4--)	◀ 43		09.80	04.89	+ CH												
	2.1 D (T4--)	▶ 43	0038051	09.80	04.89													
	1.4	35		03.80	04.89	03.6512-0100.3	320077	BRL 1/2 (2)	ATE									
	1.6	48		01.83	06.86													
	1.6 4x4	48		08.85	06.86													
	1.7	50		06.86	04.89													
	2.0	58		07.80	04.85													
	2.0	59		06.86	04.89													
	2.0	60		05.85	02.89													
	2.0 4x4	59		06.86	04.89													
	2.1 D	43		09.80	04.89													
	2.1 D 4x4	43		05.86	02.89													
	1.6 4x4	48		08.86	12.86	24.2528-0908.3	040065	Nz 28,57										
	1.7	50		06.86	04.89													
	2.0 4x4	59		06.86	12.86													
	2.1 D	43		09.80	12.86													
	2.1 D	43		05.86	02.89													

RENAULT TRAFIC I PROPULSION (PXX) (80-89)

	1.7 (P3--)	50	0005150	06.86		03.2120-1142.3	010085		THz 20,64	ATE
	2.0 (P3--) Kastenw.	59	0005150	01.81						
	2.1 D (P3--)	43	0005150	01.81						
	1.7 (P3--)	50	0005151		04.89	03.2125-3801.3	010215		THz 25,40	ATE
	2.0 (P3--) Kastenw.	59	0005151		04.89					
	2.1 D (P3--)	43	0005151		04.89					
	1.7 (P3--)	50	0005150	06.86		13.0460-3968.2	603968		20488 18,5 +/-WK	BDX
	2.0 (P3--) Kastenw.	59	0005150	01.81						
	2.1 D (P3--)	43	0005150	01.81						
	1.7 (P3--)	50	0005151		04.89	13.0460-3969.2	603969		20926 18,5 /WK	BDX
	2.0 (P3--) Kastenw.	59	0005151		04.89					
	2.1 D (P3--)	43	0005151		04.89					
	1.4	35		03.80	04.89	24.0124-0103.1	424103		253 24,0 22,0 V +B	
	1.6	48		03.80	04.89					
	1.7 (P3--)	50		01.81	04.89					
	2.0 (P3--) Kastenw.	59		01.81	04.89					
	2.1 D (P3--)	43		01.81	04.89					
	1.7 (P3--)	50		01.81	04.89	24.5111-0320.3	330487	4	L=320	
	2.0 (P3--) Kastenw.	59		01.81	04.89					
	2.1 D (P3--)	43		01.81	04.89					
	1.7 (P3--)	50	0005150	01.81		24.3223-1106.3	020317		Rz 23,81	BDX
	2.0 (P3--) Kastenw.	59	0005150	01.81						
	2.1 D (P3--)	43	0005150	01.81						
	1.7 (P3--)	50	0005151		04.89	24.3225-1601.3	020359		Rz 25,40	TRW
	2.0 (P3--) Kastenw.	59	0005151		04.89					
	2.1 D (P3--)	43	0005151		04.89					



RENAULT TRAFIC I PROPULSION (PXX) (80-89)

	1.7 (P3--)	50	0005150	01.81		03.0137-0153.2	650153		255 x 46 AUT	BDX
	2.0 (P3--)	59	0005150	01.81		03.0137-9211.2	669211		Bremsbacken-Zubehör	BDX
	2.1 D (P3--)	43	0005150	01.81						
	1.7 (P3--)	50	0005151		04.89	03.0137-0036.2	650036		254 x 57	TRW
	2.0 (P3--)	59	0005151		04.89	03.0137-9013.2	669013		Bremsbacken-Zubehör	TRW
	2.1 D (P3--)	43	0005151		04.89					
	1.7 (P3--)	50	0005151		04.89	24.0225-4019.1	480305		254/254,8 x 70	
	2.0 (P3--)	59	0005151		04.89					
	2.1 D (P3--)	43	0005151		04.89					
	1.7 (P3--)	50	0005150	01.81		03.0520-0723.3	690723		23,81/255x45 TopKit	BDX
	2.0 (P3--)	59	0005150	01.81						
	2.1 D (P3--)	43	0005150	01.81						
	1.4	35		01.81	04.89	03.6512-0100.3	320077		BRL 1/2 (2)	ATE
	1.6	48		01.84	04.89					
	1.4	35		01.81	04.89	24.2528-0908.3	040065		Nz 28,57	
	1.6	48		01.84	04.89					
	1.7	50		06.86	04.89					
	2.0	59		06.86	04.89					
	2.1 D	43		03.85	04.89					

RENAULT TRAFIC I Propulsion (PXX) (89-97)

	1.7	50		05.89	08.94	03.2125-3801.3	010215		THz 25,40	ATE
	2.0	59		05.89	10.97					
	2.1 D	43		05.89	06.94					
	2.1 D	47		06.94	10.97					
	1.7	50		05.89	08.94	13.0460-3969.2	603969		20926 18,5 /WK	BDX
	2.0	59		05.89	10.97					
	2.1 D	43		05.89	06.94					
	2.1 D	47		06.94	10.97					
	2.2	70		05.89	06.94					
	2.2	74		09.94	12.97					
	2.2 4x4	74		09.94	12.97					
	2.5 D	51		05.89	12.97					
	2.5 D	55		05.98	03.01					
	2.5 D	56		03.89	08.94					
	1.7	50		05.89	08.94	24.0124-0103.1	424103		253 24,0 22,0 V +B	
	2.0	59		05.89	10.97					
	2.1 D	43		05.89	06.94					
	2.1 D	47		06.94	10.97					
	2.2	70		05.89	06.94					
	2.2	74		09.94	12.97					
	2.2 4x4	74		09.94	12.97					
	2.5 D	51		05.89	12.97					
	2.5 D	55		05.98	03.01					
	2.5 D	56		03.89	08.94					
	1.7 (P3-8)	50		05.89	08.94 + 1,0 t	24.5111-0317.3	330501	2	L=315	
	2.0 (PC-2)	59		05.89	10.97 + 1,4 t	24.5111-0320.3	330487	2	L=320	
	2.1 D (P3-3)	43		05.89	06.94 + 1,0 t					
	2.1 D (P3-3)	47		06.94	10.97 + 1,0 t					
	2.1 D (PC-3)	43		05.89	06.94 + 1,4 t					
	2.1 D (PC-3)	47		06.94	10.97 + 1,4 t					
	1.7	50		05.89	08.94	24.3225-1601.3	020359		Rz 25,40	TRW
	2.0	59		05.89	10.97					
	2.1 D	43		05.89	06.94					
	2.1 D	47		06.94	10.97					
	1.7	50		05.89	08.94	03.0137-0036.2	650036		254 x 57	TRW
	2.0	59		05.89	08.94	03.0137-9013.2	669013		Bremsbacken-Zubehör	TRW
	2.1 D	43		05.89	06.94					
	2.1 D	47		06.94	08.94					
	2.0	59		09.94	10.97	03.0137-0330.2	650330		254 x 57 HEB	TRW
	2.1 D	47		09.94	10.97	03.0137-9216.2	669216		Bremsbacken-Zubehör	TRW
	1.7	50		05.89	08.94	24.0225-4019.1	480305		254/254,8 x 70	
	2.0	59		05.89	10.97					
	2.1 D	43		05.89	06.94					
	2.1 D	47		06.94	10.97					
	2.0	59		09.94	10.97	03.0520-0825.3	690825		25,40/254x57 TopKit	TRW
	2.1 D	47		09.94	10.97					
	1.7	50		05.89	08.94	03.6512-0100.3	320077		BRL 1/2 (2)	ATE
	2.0	59		05.89	10.97					
	2.1 D	43		05.89	06.94					
	2.1 D	47		06.94	10.97					



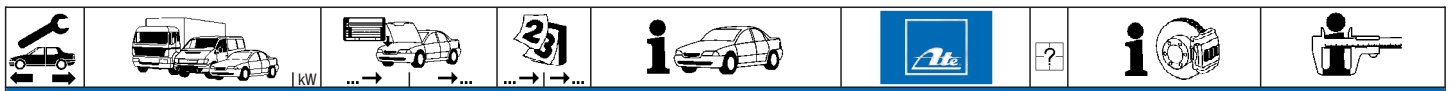

ROVER 200-Serie (XH) (85-89)

	213 216 216 Vitesse	61 75	03.85 03.85 03.85	09.89 09.89 09.89	13.0460-5999.2	605999		21127 15,0 +WK	AKE
	213 216 216 Vitesse	61 75	03.85 03.85 03.85	09.89 09.89 09.89	24.0112-0102.1	412102		231 12,0 10,0	
	213 216 216 Vitesse	61 75	03.85 03.85 03.85	09.89 09.89 09.89	24.0117-0101.1	417101		231 17,0 15,0 V	AKE
	213 216	61	03.85 03.85	09.89 09.89	24.3219-1121.3 24.3219-1122.3	020363 020364	<input type="checkbox"/> <input type="checkbox"/>	Rz 19,05 Rz 19,05	
	213 216 216 Vitesse	61 75	03.85 03.85 03.85	09.89 09.89 09.89	03.0137-0179.2 03.0137-9096.2	650179 669096		180 x 31 Bremsbacken-Zubehör	





























ROVER 200-Serie (XW) (90-95)































	214 214 16V 216 216 16V 218 D 218 TD 220 16V 220 Turbo		10.89 01.90 10.89 01.90 09.91 01.91 01.91 01.93	10.95 10.95 10.95 10.95 10.95 10.95 10.95 10.95	24.3541-1813.5 24.3541-1814.5	240381 240382	<input type="checkbox"/> + ABS <input type="checkbox"/> + ABS	D=54, - Halter D=54, - Halter	TRW TRW
	214 214 16V 216 216 16V 218 D 218 TD 220 16V 220 Turbo		10.89 01.90 10.89 01.90 09.91 01.91 01.91 01.93	10.95 10.95 10.95 10.95 10.95 10.95 10.95 10.95	13.0460-2805.2 13.0460-2803.2 13.0460-0142.2	602805 602803 610142	- ABS + ABS	21520 17,5 +WK 21515 17,5 +WK/S Belagsatz-Zubehör	TRW TRW
	214 214 16V		09.93 09.93	10.95 10.95	24.0113-0188.1	413188	- ABS - ABS	238 12,7 10,7	
	214 214 16V 216 216 16V 218 D 218 TD 220 16V 220 Turbo		10.89 01.90 10.89 10.89 09.91 09.91 09.91 01.93	10.95 10.95 10.95 10.95 10.95 10.95 10.95 10.95	24.0121-0107.1	421107	+ ABS + ABS	262 21,0 19,0 V +B	
	214 216 218 D 220 Turbo		10.89 10.89 09.91 01.93	10.95 10.95 10.95 10.95	13.0460-5998.2 13.0460-0430.2	605998 610430		21312 12,8 +WK Belagsatz-Zubehör	AKE AKE
	214 214 16V 216 16V 218 TD 220 16V		01.90 01.90 01.90 01.91 01.91	10.95 10.95 10.95 10.95 10.95	24.0110-0212.1	410212	+ ABS + ABS + ABS + ABS	239 10,0 8,0 +S +B	
	214 216 218 D		10.89 01.91 01.91	10.95 10.95 10.95	03.0137-0339.2 03.0137-9221.2	650339 669221	- ABS - ABS - ABS	203 x 38 Bremsbacken-Zubehör	
	214 216 218 D		10.89 01.91 01.91	10.95 10.95 10.95	03.0420-3719.3	683719	- ABS - ABS - ABS	19,05/203x38 Kit	TRW



























ROVER 400-Serie (XW) (90-95)



























	414 414 16V 416 16V		04.90 01.90 04.90	04.95 04.95 04.95	24.3541-1813.5 24.3541-1814.5	240381 240382	<input type="checkbox"/> + ABS <input type="checkbox"/> + ABS	D=54, - Halter D=54, - Halter	TRW TRW
	418 418 D 418 TD 420 16V 420 Turbo		09.91 01.91 01.91 01.91 01.93	04.95 04.95 04.95 04.95 04.95	24.3541-1813.5 24.3541-1814.5	240381 240382	<input type="checkbox"/> + ABS <input type="checkbox"/> + ABS	D=54, - Halter D=54, - Halter	TRW TRW
	414 414 16V 416 16V 418 418 D 418 TD 420 16V 420 Turbo		04.90 01.90 04.90 09.91 01.91 01.91 01.91 01.93	04.95 04.95 04.95 04.95 04.95 04.95 04.95 04.95	13.0460-2805.2 13.0460-2803.2 13.0460-0142.2	602805 602803 610142	- ABS + ABS	21520 17,5 +WK 21515 17,5 +WK/S Belagsatz-Zubehör	TRW TRW
	414 414 16V		01.90 01.90	04.95 04.95	24.0113-0188.1	413188	- ABS - ABS	238 12,7 10,7	
	414 414 16V 416 16V 418 D 418 TD 420 16V 420 Turbo		04.90 01.90 04.90 09.91 09.91 02.92 01.93	04.95 04.95 04.95 04.95 04.95 04.95 04.95	24.0121-0107.1	421107	+ ABS + ABS	262 21,0 19,0 V +B	

ROVER 400-Serie (XW) (90-95)								
	414 416 16V 418 418 TD		04.90 04.90 09.91 01.91	04.95 04.95 04.95 04.95		13.0460-5998.2 13.0460-0430.2	605998 610430	21312 12,8 +/WK Belagsatz-Zubehör AKE AKE
	414 414 16V 416 16V 418 TD 420 16V 420 Turbo		01.90 01.90 01.90 01.91 01.91 01.93	04.95 + ABS + ABS + ABS + ABS 04.95		24.0110-0212.1	410212	239 10,0 8,0 +S +B
	414 416 16V 418 D		01.90 01.90 01.91	04.95 - ABS - ABS - ABS		03.0137-0339.2 03.0137-9221.2	650339 669221	203 x 38 Bremsbacken-Zubehör
ROVER 2000/2300/2600/3500 (SD) (76-86)								
	2.3 2.6 3.5 V8		09.77 09.77 06.76	12.81 12.81 12.81	- ⊖ - ⊖ - ⊖	13.0460-6910.2 13.0460-0414.2	606910 610414	20364 15,0 +/Zub Belagsatz-Zubehör AP AP
ROVER MINI (91-95)								
	1.3 MK I		01.91	04.95		13.0460-6914.2	606914	20038 14,0 AP
	1.3 MK I		01.91	04.95		24.0110-0239.1	410239	214 9,6 8,6
	1.3 MK I		01.91	04.95		24.3219-1401.3	020351	Rz 19,05 AP
	1.3 MK I		01.91	04.95		03.0137-0080.2 03.0137-9205.2	650080 669205	178 x 32 Bremsbacken-Zubehör AP AP
SAAB 90 (84-87)								
	2.0		08.84	07.87		13.0460-0431.2	610431	Belagsatz-Zubehör TRW
	2.0		08.84	07.87		24.0113-0117.1	413117	280 12,7 11,7
	2.0		08.84	07.87		24.5303-0275.3	331213	2 L=275
	2.0		08.84	07.87		13.0441-3001.2	250041	Dichtungssatz ATE
	2.0		08.84	07.87		24.0111-0120.1	411120	270 10,5 9,5
	2.0		08.84	07.87		24.5310-0270.3	331369	2 L=270
SAAB 99 (69-73)								
	1.7 1.9		12.68 05.70	08.70 08.73		13.0460-4035.2	604035	20173 15,0 ATE
	1.7 1.9		12.68 05.70	08.70 08.73		24.0111-0120.1	411120	270 10,5 9,5
	1.7 1.9		12.68 05.70	08.70 08.73		13.0441-3001.2	250041	Dichtungssatz ATE
	1.7 1.9		12.68 05.70	08.70 08.73		24.0111-0120.1	411120	270 10,5 9,5
SAAB 99 (74-84)								
	1.9 2.0		09.73 09.73	08.74 12.74		13.0441-4819.2	250104	Dichtungssatz ATE
	2.0 2.0 EMS		01.75 01.75	08.84 08.84		13.0460-0431.2	610431	Belagsatz-Zubehör TRW
	1.9 2.0		09.73 09.73	08.74 12.74		24.0111-0120.1	411120	270 10,5 9,5
	2.0 2.0 2.0 2.0 2.0 2.0 EMS	C06010842 99766008979 99762022110 99766009735 99767004036 99762018780 99766007925	99766009281	08.84 08.84 08.84 08.84 08.84		24.0113-0117.1 13.0441-3001.2	413117 250041	280 12,7 11,7 Dichtungssatz ATE
↓	↓							

								
SAAB 99 (74-84)								
	2.0 EMS	99767003176		08.84		13.0441-3001.2	250041	Dichtungssatz ATE
	1.9 2.0			09.73 09.73	08.74 08.84	24.0111-0120.1	411120	270 10,5 9,5
	2.0			01.75	08.84	24.5310-0270.3	331369 2	L=270
SAAB 900 (79-93)								
	2.0 16V 2.0 C 2.0 i 2.0 Turbo 2.1 16V			01.89 09.87 09.87 09.87 09.90	08.93 12.88 08.90 08.93 12.91	24.0101-3601.2	260044	Bremssattel-Zubehör TRW
	2.0 C 2.0 EMS 2.0 i 2.0 Turbo			09.85 11.78 09.85 10.80	08.87 12.80 08.87 08.87	13.0460-0431.2	610431	Belagsatz-Zubehör TRW
	2.0 16V 2.0 C 2.0 i 2.0 Turbo 2.1 16V			01.89 09.87 09.87 09.87 09.90	08.93 12.88 08.90 08.93 12.91	13.0460-2811.2	602811	21068 17,0 /S TRW
	2.0 C 2.0 EMS 2.0 i			09.80 09.80 11.80	08.87 12.80 08.87	24.0113-0117.1	413117	280 12,7 11,7
	2.0 16V 2.0 C 2.0 i 2.0 Turbo 2.1 16V			01.89 09.87 09.87 09.87 09.90	08.93 12.88 08.90 08.93 12.91	24.0123-0101.1	423101	280 23,4 21,5 V
	2.0 16V 2.0 C 2.0 EMS 2.0 i 2.0 Turbo 2.1 16V			01.89 09.79 11.78 11.80 10.80 09.90	08.93 12.88 12.80 08.90 08.93 12.91	24.5303-0275.3	331213 2	L=275
	2.0 16V 2.0 i 2.0 Turbo 2.1 16V			09.89 09.89 09.89 09.90	08.93 08.90 08.93 12.91	24.0711-1154.1 24.0711-1155.1	360009 360010	Radsensor L=1295 Radsensor L=1295
	2.0 C 2.0 EMS 2.0 i			09.79 11.78 11.80	08.87 12.80 08.87	13.0441-3001.2	250041	Dichtungssatz ATE
	2.0 16V 2.0 C 2.0 i 2.0 Turbo 2.1 16V			01.89 09.87 09.87 09.87 09.90	08.93 12.88 08.90 08.93 12.91	11.0441-3302.2 11.0101-5407.2 11.8171-0008.1	250004 260011 990049	Dichtungssatz ATE Hülensatz ATE Führungsbolzen ATE
	2.0 16V 2.0 C 2.0 i 2.0 Turbo 2.1 16V			01.89 09.87 09.87 09.87 09.90	08.93 12.88 08.90 08.93 12.91	13.0460-3306.2	603306	21089 15,0 + ATE
	2.0 C 2.0 EMS 2.0 i 2.0 Turbo			09.79 11.78 11.80 10.80	08.87 12.80 08.87 08.87	24.0111-0120.1	411120	270 10,5 9,5
	2.0 16V 2.0 C 2.0 i 2.0 Turbo 2.1 16V			01.89 09.87 09.87 09.87 09.90	08.93 12.88 08.90 08.93 12.91	24.0109-0130.1	409130	258 9,0 7,5
	2.0 C 2.0 EMS 2.0 i 2.0 Turbo			09.79 11.78 11.80 10.80	08.85 12.80 08.85 08.85	24.5310-0270.3	331369 2	L=270
	2.0 16V 2.0 C 2.0 i 2.0 Turbo			01.89 09.85 09.85 09.85	08.89 12.88 08.89 08.89	24.5310-0270.3 83.6155-0160.3	331369 330717	L=270 L=160
	2.0 16V 2.0 i 2.0 Turbo 2.1 16V			09.89 09.89 09.89 09.90	08.93 08.90 08.93 12.91	24.5310-0270.3	331369 2	L=270
	2.0 16V 2.0 i 2.0 Turbo 2.1 16V			09.89 09.89 09.89 09.90	08.93 08.90 08.93 12.91	24.0711-1157.1	360012	Radsensor L=1020

								
SAAB 900 (79-93)								
	2.0 C 2.0 EMS 2.0 i 2.0 Turbo			09.79 08.87 11.78 12.80 11.80 08.87 10.80 08.87		24.3727-1101.2 581101	2	L=1918
SAAB 9000 (85-93)								
	2.0 16V 2.0 16V Turbo 2.3 16V 2.3 16V Turbo			08.92 08.93 + ABS/ - ASR/ - TCS 08.92 08.93 + ABS/ - ASR/ - TCS 08.92 08.93 + ABS/ - ASR/ - TCS 08.92 08.93 + ABS/ - ASR/ - TCS		10.6123-0522.3 010633		Thz 23,81 ATE
	2.0 16V 2.0 16V Turbo			09.86 08.89 09.86 08.87		24.0101-3601.2 260044		Bremssattel-Zubehör TRW
	2.0 16V 2.0 16V Turbo 2.3 16V 2.3 16V Turbo			09.89 08.93 09.87 08.93 09.89 08.93 09.89 08.93		11.0441-5702.2 250033 11.0101-5407.2 260011 11.8171-0008.1 990049 11.8116-0073.1 390498	2	Dichtungssatz ATE Hülzensatz ATE Führungsbolzen ATE Haltefeder ATE
	2.0 16V 2.0 16V Turbo			09.84 08.89 09.84 08.87		13.0460-2811.2 602811		21068 17,0 /S TRW
	2.0 16V 2.0 16V Turbo 2.3 16V 2.3 16V Turbo			09.89 08.93 09.87 08.93 09.89 08.93 09.89 08.93		13.0460-5703.2 605703		21154 19,5 +/-WE ATE
	2.0 16V 2.0 16V Turbo			09.84 08.89 09.84 08.87		24.0123-0101.1 423101		280 23,4 21,5 V
	2.0 16V 2.0 16V Turbo 2.3 16V 2.3 16V Turbo			09.89 08.93 09.87 08.93 09.89 08.93 09.89 08.93		24.0125-0125.1 425125		280 25,0 23,0 V
	2.0 16V 2.0 16V Turbo 2.3 16V 2.3 16V Turbo			09.84 08.93 09.84 08.93 09.89 08.93 09.89 08.93		83.6169-0505.3 330288	2	L=505
	2.0 16V 2.0 16V Turbo			08.86 08.89 08.86 08.89		24.0712-1308.3 360032 24.0712-1307.3 360031	<input type="checkbox"/> <input type="checkbox"/>	Radsensor L=1100 Radsensor L=1100
	2.0 16V 2.0 16V Turbo 2.3 16V 2.3 16V Turbo			09.84 08.93 09.84 08.93 09.89 08.93 09.89 08.93		11.0441-3302.2 250004 11.0101-5407.2 260011 11.8171-0008.1 990049		Dichtungssatz ATE Hülzensatz ATE Führungsbolzen ATE
	2.0 16V 2.0 16V Turbo 2.3 16V 2.3 16V Turbo			09.84 08.93 09.84 08.93 09.89 08.93 09.89 08.93		13.0460-3306.2 603306		21089 15,0 + ATE
	2.0 16V 2.0 16V Turbo 2.3 16V 2.3 16V Turbo			09.84 08.93 09.84 08.93 09.89 08.93 09.89 08.93		24.0109-0130.1 409130		258 9,0 7,5
	2.0 16V 2.0 16V Turbo 2.3 16V 2.3 16V Turbo			09.84 08.93 09.84 08.93 09.89 08.93 09.89 08.93		83.6155-0327.3 330287	2	L=325
	2.0 16V 2.0 16V Turbo			08.86 08.89 08.86 08.89		24.0712-1310.3 360034 24.0712-1309.3 360033	<input type="checkbox"/> <input type="checkbox"/>	Radsensor L=1120 Radsensor L=1120
	2.0 16V 2.0 16V Turbo			09.86 08.89 09.86 08.89		24.3727-1105.2 581105 24.3727-1107.2 581107	<input type="checkbox"/> <input type="checkbox"/>	L=2025 L=1892
	2.0 16V 2.0 16V Turbo 2.3 16V 2.3 16V Turbo			09.89 08.93 09.89 08.93 09.89 08.93 09.89 08.93		24.3727-1105.2 581105 24.3727-1107.2 581107	<input type="checkbox"/> <input type="checkbox"/>	L=2025 L=1892
SEAT 124 (66-74)								
	alle Typen			01.66 12.74		24.2119-0831.3 010416		Thz 19,05
	alle Typen			01.66 12.74		24.0111-0130.1 411130		227 10,8 9,0 +B
SEAT 127 (72-83)								
	127			01.72 12.82		24.2119-0806.3 010345		Thz 19,05
	alle Typen			01.72 12.83		24.0111-0130.1 411130		227 10,8 9,0 +B
	alle Typen			01.72 12.82		24.3219-0801.3 020181		Rz 19,05 FI

								
SEAT 128 (69-84)								
	alle Typen		01.76	09.80	24.0111-0130.1	411130		227 10,8 9,0 +B
	alle Typen		01.76	12.80	24.3219-0801.3	020181		Rz 19,05 FI
SEAT 131 (75-85)								
	alle Typen		01.75	12.85	24.0111-0130.1	411130		227 10,8 9,0 +B
SEAT 132 (72-82)								
	alle Typen		05.73	12.82	24.2119-0806.3	010345		THz 19,05
	alle Typen		05.73	12.82	24.0111-0130.1	411130		227 10,8 9,0 +B
SEAT 600 (57-73)								
	alle Typen		01.57	12.73	24.3219-0801.3	020181		Rz 19,05 FI
SEAT 850 (64-73)								
	850 E Special		06.64	06.73	24.0111-0130.1	411130		227 10,8 9,0 +B
	alle Typen		06.64	06.73	24.3219-0801.3	020181		Rz 19,05 FI
SEAT FURA (82-86)								
	0.9		02.82	12.86	13.0460-3936.2	603936		20073 17,3 BDX
	1.4		02.82	06.86	13.0460-2997.2	602997		20708 15,8 /S TRW
	0.9		02.82	12.86	24.0111-0130.1	411130		227 10,8 9,0 +B
SEAT IBIZA I (85-92)								
	0.9		11.86	01.93	03.2120-2031.3	010106		THz 20,64 ATE
	1.2		05.85	01.93				
	1.5		05.85	01.93				
	1.5 i		04.88	01.93				
	1.7 D		05.85	01.93				
	0.9		11.86	01.93	13.0460-3939.2	603939		20775 18,0 /WE BDX
	1.2		05.85	01.93	13.0460-3940.2	603940		20775 18,0 /WK BDX
	1.5		05.85	01.93	13.0460-0410.2	610410		Belagsatz-Zubehör BDX
	1.5 i		04.88	01.93				
	1.7 D		05.85	01.93				
	1.7 i		01.92	01.93				
	0.9		11.86	01.93	24.0111-0130.1	411130		227 10,8 9,0 +B
	1.2		05.85	01.93				
	1.5	63	05.85	01.93				
	1.7 D		05.85	01.93				
	1.5 i	66	04.88	01.93	24.0111-0129.1	411129		251 11,0 9,5
	1.5 i	74	04.88	01.93	24.0120-0157.1	420157		251 20,0 18,0 V
	1.7 i		01.92	01.93				
	0.9		11.86	01.93	24.5112-0412.3	330569	2	L=410
	1.2		05.85	01.93				
	1.5		05.85	01.93				
	1.5 i		04.88	01.93				
	1.7 D		05.85	01.93				
	1.7 i		01.92	01.93				
	0.9		11.86	01.93	24.5223-0294.3	330576	2	L=294
	1.2		05.85	01.93				
	1.5		05.85	01.93				
	1.5 i		04.88	01.93				
	1.7 D		05.85	01.93				
	1.7 i		01.92	01.93				
	0.9		11.86	01.93	24.3217-1115.3	020310		Rz 17,46 FI
	1.2		05.85	01.93				
	1.5		05.85	01.93				
	1.5 i		04.88	01.93				
	1.7 D		05.85	01.93				
	1.7 i		01.92	01.93				
	0.9		11.86	01.93	03.0137-0015.2	650015		185 x 31 AUT FI
	1.2		05.85	01.93	03.0137-9021.2	669021		Bremsbacken-Zubehör FI
	1.5		05.85	01.93				
	1.5 i		04.88	01.93				
	1.7 D		05.85	01.93				
	1.7 i		01.92	01.93				
↓	↓							

								
SEAT IBIZA I (85-92)								
	0.9 1.2 1.5 1.5 i 1.7 D 1.7 i			11.86 01.93 05.85 01.93 05.85 01.93 04.88 01.93 05.85 01.93 01.92 01.93		24.0218-5001.1	480012	185/186,8 x 37
	0.9 1.2 1.5 1.5 i 1.7 D 1.7 i			11.86 01.93 05.85 01.93 05.85 01.93 04.88 01.93 05.85 01.93 01.92 01.93		03.0420-0917.3	680917	17,46/185x31 Kit FI
	0.9 1.2 1.5 1.5 i 1.7 D			11.86 01.93 05.85 01.93 05.85 01.93 04.88 01.93 05.85 01.93		24.3727-2701.2	582701	1  L=2275
SEAT MALAGA (85-92)								
	1.2 1.5 1.5 i 1.7 D			09.85 12.92 09.85 12.92 09.87 12.92 09.85 12.92		03.2120-2031.3	010106	Thz 20,64 ATE
	1.2 1.5 1.5 i 1.7 D			09.85 12.92 09.85 12.92 09.87 12.92 09.85 12.92		13.0460-3939.2 13.0460-3940.2 13.0460-0410.2	603939 603940 610410	20775 18,0 /WE BDX 20775 18,0 /WK BDX Belagsatz-Zubehör BDX
	1.2 1.5 1.7 D 1.5 i 1.5 i	63 66 74		09.85 12.92 09.85 12.92 09.85 12.92 09.87 12.92 02.88 12.89		24.0111-0130.1 24.0111-0129.1 24.0120-0157.1	411130 411129 420157	227 10,8 9,0 +B 251 11,0 9,5 251 20,0 18,0 V
	1.2 1.5 1.5 i 1.7 D			09.85 12.92 09.85 12.92 09.87 12.92 09.85 12.92		24.5112-0412.3	330569	2 L=410
	1.2 1.5 1.5 i 1.7 D			09.85 12.92 09.85 12.92 09.87 12.92 09.85 12.92		24.5223-0294.3	330576	2 L=294
	1.2 1.5 1.5 i 1.7 D			09.85 12.92 09.85 12.92 09.87 12.92 09.85 12.92		24.3217-1115.3	020310	Rz 17,46 FI
	1.2 1.5 1.5 i 1.7 D			09.85 12.92 09.85 12.92 09.87 12.92 09.85 12.92		03.0137-0015.2 03.0137-9021.2	650015 669021	185 x 31 AUT FI Bremsbacken-Zubehör FI
	1.2 1.5 1.5 i 1.7 D			09.85 12.92 09.85 12.92 09.87 12.92 09.85 12.92		24.0218-5001.1	480012	185/186,8 x 37
	1.2 1.5 1.5 i 1.7 D			09.85 12.92 09.85 12.92 09.87 12.92 09.85 12.92		03.0420-0917.3	680917	17,46/185x31 Kit FI
	1.2 1.5 1.5 i 1.7 D			09.85 12.92 09.85 12.92 09.87 12.92 09.85 12.92		24.3727-2701.2	582701	1  L=2275
SEAT PANDA (80-86)								
	30 45			10.80 12.86 10.80 12.86		03.0137-0015.2 03.0137-9021.2	650015 669021	185 x 31 AUT FI Bremsbacken-Zubehör FI
SEAT RITMO (79-83)								
	60 65 75			01.79 12.83 01.79 12.83 01.79 12.83		24.0111-0130.1	411130	227 10,8 9,0 +B
SEAT RONDA (83-86)								
	1.2 1.4 1.5 1.6 1.7 D			06.83 07.86 06.82 07.86 09.85 07.86 06.83 08.85 06.83 07.86		03.2120-2031.3	010106	Thz 20,64 ATE
	1.2 1.4 1.5 1.6 1.7 D			06.83 07.86 06.82 07.86 09.85 07.86 06.83 08.85 06.83 07.86		13.0460-3940.2 13.0460-0410.2	603940 610410	20775 18,0 /WK BDX Belagsatz-Zubehör BDX



SEAT RONDA (83-86)											
	1.2 1.4 1.5 1.6 1.7 D			06.83 06.82 09.85 06.83 06.83	07.86 07.86 07.86 08.85 07.86			24.0111-0130.1	411130		227 10,8 9,0 +B
	1.2 1.4 1.5 1.6 1.7 D			06.83 06.82 09.85 06.83 06.83	07.86 07.86 07.86 08.85 07.86			24.5112-0412.3	330569	2	L=410
	1.2 1.4 1.5 1.6 1.7 D			06.83 06.82 09.85 06.83 06.83	07.86 07.86 07.86 08.85 07.86			24.3217-1115.3	020310		Rz 17,46 FI
	1.2 1.4 1.5 1.6 1.7 D			06.83 06.82 09.85 06.83 06.83	07.86 07.86 07.86 08.85 07.86			03.0137-0015.2 03.0137-9021.2	650015 669021		185 x 31 AUT Bremsbacken-Zubehör FI
	1.2 1.4 1.5 1.6 1.7 D			06.83 06.82 09.85 06.83 06.83	07.86 07.86 07.86 08.85 07.86			24.0218-5001.1	480012		185/186,8 x 37
	1.2 1.4 1.5 1.6 1.7 D			06.83 06.82 09.85 06.83 06.83	07.86 07.86 07.86 08.85 07.86			03.0420-0917.3	680917		17,46/185x31 Kit FI
	1.2 1.4 1.5 1.6 1.7 D			06.83 06.82 09.85 06.83 06.83	07.86 07.86 07.86 08.85 07.86			24.3727-2701.2	582701	1	L=2275
SEAT TERRA (87-96)											
	0.9 1.3 D 1.4 D			03.87 03.90 01.90	12.96 12.96 12.96			13.0460-3939.2 13.0460-0410.2	603939 610410		20775 18,0 /WE Belagsatz-Zubehör BDX
	0.9 1.3 D 1.4 D			03.87 03.90 01.90	12.96 12.96 12.96			24.0111-0130.1	411130		227 10,8 9,0 +B
	0.9 1.3 D 1.4 D			09.90 09.90 09.90	12.96 12.96 12.96			24.3219-0803.3	020183		Rz 19,05
	0.9 1.3 D 1.4 D			03.87 03.90 01.90	12.96 12.96 12.96			03.0137-0015.2 03.0137-9021.2	650015 669021		185 x 31 AUT Bremsbacken-Zubehör FI
	0.9 1.3 D 1.4 D			03.87 03.90 01.90	12.96 12.96 12.96			24.3727-2705.2	582705	1	L=3170
SKODA FAVORIT (781) (87-95)											
	1.3 (135) 1.3 (136)			08.87 08.87	12.95 12.95			13.0460-2964.2	602964		20861 17,5 /S TRW
	1.3 (135) 1.3 (136) 1.3 (135) 1.3 (136)			08.87 08.87 01.93 01.93	12.92 12.92 03.94 03.94			24.0113-0169.1 24.0113-0193.1	413169 413193		236 12,8 11,4 236 12,8 11,4
	1.3 (135) 1.3 (136)			04.94 04.94	12.95 12.95			24.0113-0182.1	413182		236 12,8 11,4 +B
	1.3 (135) 1.3 (136)			08.87 08.87	12.95 12.95			24.5166-0325.3	331293	2	L=325
	1.3 (135) 1.3 (136)			08.87 08.87	12.95 12.95			24.5228-0235.3	330395	2	L=235
	1.3 (135) 1.3 (136)			01.93 01.93	12.95 12.95			24.3219-1721.3	020422		Rz 19,05
	1.3 (135) 1.3 (136) 1.3 (135) 1.3 (136)			08.87 08.87 01.93 01.93	12.92 12.92 12.95 12.95			03.0137-9133.2 03.0137-0268.2 03.0137-9168.2	669133 650268 669168		Bremsbacken-Zubehör 200 x 40 HEB Bremsbacken-Zubehör VW
	1.3 (135) 1.3 (136)			01.93 01.93	12.95 12.95			24.0220-0018.1 24.0220-0718.2	480019 480209	ohne Sensorring ¹⁾ ohne Sensorring ¹⁾	200/201 x 50 - Lager 200/201 x 50 + Lager
	1.3 (135) 1.3 (136)			01.93 01.93	12.95 12.95			03.0520-5319.3	695319		19,05/200x40 TopKit

¹⁾ without sensor ring / senza sensori / sans secours ABS / sin anillo sensor ABS



































SKODA FELICIA I (791/795) (95-97)

	1.3 (135) 1.3 i (136) 1.6 i 1.9 D	50		10.94 02.98 10.94 02.98 08.95 02.98 10.96 02.98	24.2122-1731.3 010656 03.2123-1428.3 010476	- ABS + ABS	THz 22,20 THz 23,81	ATE
	1.3 (135) 1.3 i (136) 1.6 i 1.9 D	50		10.94 02.98 10.94 02.98 08.95 02.98 10.96 02.98	24.3541-1737.5 240197 24.3541-1738.5 240198		D=54, - Halter D=54, - Halter	TRW TRW
	1.3 (135) 1.3 i (136) 1.6 i 1.9 D	50		10.94 02.98 10.94 02.98 08.95 02.98 10.96 02.98	13.0460-2964.2 602964		20861 17,5 /S	TRW
	1.3 (135) 1.3 i (136) 1.6 i 1.9 D	50		10.94 02.98 10.94 02.98 08.95 02.98 10.96 02.98	24.0113-0182.1 413182		236 12,8 11,4 +B	
	1.3 (135) 1.3 i (136) 1.6 i 1.9 D	50		10.94 06.96 10.94 06.96 08.95 06.96	24.5112-0339.3 330771	2 - ABS	L=340	
	1.3 (135) 1.3 i (136) 1.6 i 1.9 D	50		07.96 02.98 07.96 02.98 07.96 02.98 10.96 02.98	24.5166-0325.3 331293	2 - ABS	L=325	
	1.3 (135) 1.3 i (136) 1.6 i 1.9 D	50		10.94 03.95 10.94 03.95	24.5228-0235.3 330395	2	L=235	
	1.3 (135) 1.3 i (136) 1.6 i 1.9 D	50		04.95 02.98 04.95 02.98 08.95 02.98 10.96 02.98	24.5228-0180.3 330761	2	L=180	
	1.3 (135) 1.3 i (136) 1.6 i 1.9 D	50		10.94 02.98 10.94 02.98 08.95 02.98 10.96 02.98	24.0721-1951.3 360367	2	Radsensor L=1240	
	1.3 (135) Lim. 1.3 i (136) Lim. 1.6 i Lim.	50		10.94 02.98 10.94 02.98 08.95 02.98	24.3219-1721.3 020422		Rz 19,05	
	1.3 (135) Kombi 1.3 i (136) Kombi 1.6 i Kombi 1.9 D Kombi	50		10.94 02.98 10.94 02.98 08.95 02.98 10.96 02.98	24.3222-1712.3 020424		Rz 22,20	
	1.3 (135) 1.3 i (136) 1.6 i 1.9 D	50		10.94 02.98 10.94 02.98 08.95 02.98 10.96 02.98	03.0137-0268.2 650268 03.0137-9168.2 669168		200 x 40 HEB Bremsbacken-Zubehör	VW VW
	1.3 (135) 1.3 i (136) 1.6 i 1.9 D	50		10.94 02.98 10.94 02.98 08.95 02.98 10.96 02.98	24.0220-0018.1 480019 24.0220-0718.2 480209	ohne Sensorring ¹⁾ ohne Sensorring ¹⁾	200/201 x 50 - Lager 200/201 x 50 + Lager	
	1.3 (135) Lim. 1.3 i (136) Lim. 1.6 i Lim.	50		10.94 02.98 10.94 02.98 08.95 02.98	03.0520-5319.3 695319		19,05/200x40 TopKit	
	1.3 (135) Kombi 1.3 i (136) Kombi 1.6 i Kombi 1.9 D Kombi	50		10.94 02.98 10.94 02.98 08.95 02.98 10.96 02.98	03.0520-7022.3 697022		22,20/200x40 TopKit	VW
	1.3 (135) 1.3 i (136) 1.6 i 1.9 D	50		10.94 02.98 10.94 02.98 08.95 02.98 10.96 02.98	24.3727-2500.2 582500	2	L=1752	
	1.3 (135) 1.3 i (136) 1.6 i 1.9 D	50		10.94 02.98 10.94 02.98 08.95 02.98 10.96 02.98	03.6584-0107.3 320110		BRL 8/4 (4)	ATE
	1.3 (135) 1.3 i (136) 1.6 i 1.9 D	50		10.94 02.98 10.94 02.98 08.95 02.98 10.96 02.98	03.6583-0167.3 320140		BRL 8/3 (4)	ATE
	1.3 (135) 1.3 i (136) 1.6 i	50		10.94 02.98 10.94 02.98 08.95 02.98	24.3728-2500.2 592500		L=742	

SKODA FORMAN (785) (91-95)





	1.3 1.3 i			09.91 12.95 02.94 12.95	13.0460-2964.2 602964		20861 17,5 /S	TRW
	1.3 1.3 1.3 i			09.91 12.92 01.93 12.95 04.94 12.95	24.0113-0169.1 413169 24.0113-0193.1 413193 24.0113-0182.1 413182		236 12,8 11,4 236 12,8 11,4 236 12,8 11,4 +B	
	1.3 1.3 i			01.93 12.95 02.94 12.95	24.3219-1721.3 020422		Rz 19,05	
	1.3 1.3 1.3 i			09.91 12.92 01.93 12.95 02.94 12.95	03.0137-9133.2 669133 03.0137-0268.2 650268 03.0137-9168.2 669168		Bremsbacken-Zubehör 200 x 40 HEB Bremsbacken-Zubehör	VW VW

¹⁾ without sensor ring / senza sensori / sans secours ABS / sin anillo sensor ABS

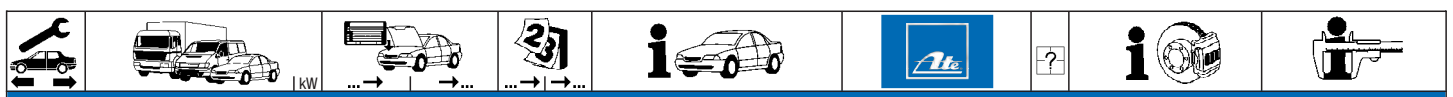



								
SKODA FORMAN (785) (91-95)								
	1.3 1.3 i		01.93 02.94	12.95 12.95	24.0220-0018.1 24.0220-0718.2	480019 480209	ohne Sensorring ¹⁾ ohne Sensorring ¹⁾	200/201 x 50 - Lager 200/201 x 50 + Lager
	1.3 1.3 i		01.93 02.94	12.95 12.95	03.0520-5319.3	695319		19,05/200x40 TopKit
SKODA PICK-UP (93-95)								
	1.3		12.92	12.95	13.0460-2964.2	602964		20861 17,5 /S TRW
	1.3		04.94	12.95	24.0113-0182.1	413182		236 12,8 11,4 +B
	1.3		12.92	12.95	24.3222-1712.3	020424		Rz 22,20
	1.3		12.92	12.95	03.0137-0268.2 03.0137-9168.2	650268 669168		200 x 40 HEB Bremsbacken-Zubehör VW VW
	1.3		12.92	12.95	24.0220-0018.1 24.0220-0718.2	480019 480209	ohne Sensorring ¹⁾ ohne Sensorring ¹⁾	200/201 x 50 - Lager 200/201 x 50 + Lager
	1.3		12.92	12.95	03.0520-7022.3	697022		22,20/200x40 TopKit VW
STEYR DAIMLER PUCH CITY-BUS (82-92)								
	City Bus		01.82	12.92	03.2123-6002.3	010184		THz 23,81 ATE
	City Bus		01.82	12.92	13.0441-4825.2	250107		Dichtungssatz ATE
	City Bus		01.82	12.92	13.0460-5032.2	605032		20588 16,5 /WE ATE
STEYR DAIMLER PUCH HAFLINGER (61-79)								
	AP 700 AP 703		01.61 01.62	12.70 12.70	24.3526-0110.3	340018	1	Bremslichtschalter
	AP 700 AP 703 APK 703		01.61 01.62 01.71	12.76 12.76 12.76	83.6204-0400.3	330311		L=400
	AP 700		01.62	12.62	03.3219-0203.3	020037		Rz 19,05
	AP 700 AP 703		01.61 01.62	12.62 12.62	83.6204-0220.3	330308		L=220
	AP 700 AP 703 APK 703		01.63 01.63 01.71	12.76 12.76 12.76	24.5170-0201.3 83.6204-0220.3	331450 330308	■	L=201 L=220
	AP 700 AP 703 APK 703		01.61 01.62 01.71	12.76 12.79 12.79	03.3215-0221.3	020013		Rz 15,87
STEYR DAIMLER PUCH PINZGAUER (71-76)								
	710 4x4 712 6x6		01.71 01.71	12.76 12.76	03.2123-1003.3 24.3526-0810.3	010175 340037	1	THz 23,81 Bremslichtschalter ATE
	710 4x4 712 6x6		01.71 01.71	12.76 12.76	83.6203-0400.3	330302		L=400
	710 4x4 712 6x6		01.71 01.71	12.76 12.76	03.3508-0401.3 03.0350-1906.2	310014 071906		Behälter Gz Reparatursatz
STEYR DAIMLER PUCH TRA 292 / TRA 395 (60-68)								
	TRA 292		01.60	12.68	83.6103-0320.3	330224		L=320
	TRA 292		01.60	12.68	83.6103-0450.3	330228		L=450
	TRA 395		01.60	12.68	03.2419-3307.3 03.0350-1906.2	030014 071906		Gz 19,05 Gz Reparatursatz
	TRA 395		01.60	12.68	83.6103-0320.3	330224		L=320

¹⁾ without sensor ring / senza sensori / sans secours ABS / sin anillo sensor ABS



**STEYR DAIMLER PUCH 380-10230 (58-88)**

	590 591 690 691 1090			01.70 01.79 01.70 01.79 01.75	12.79 12.88 12.79 12.88 12.79		03.0370-1131.2	051131			Hz Reparatursatz
	590 591 690 691 890			01.70 01.79 01.70 01.79 01.69	12.79 12.88 12.79 12.88 12.79		03.3115-2102.3	010247			Hz 15,87 Behälter ATE
	590 690 890			01.70 01.70 01.69	12.79 12.79 12.79		83.6103-0550.3	330231			L=550
	480 586 680 780 870			01.60 01.62 01.58 01.62 01.75	12.70 12.67 12.70 12.68 12.79		03.2419-3307.3 03.0350-1906.2	030014 071906			Gz 19,05 Gz Reparatursatz
	480 586 680 780			01.60 01.62 01.58 01.62	12.70 12.67 12.70 12.68		83.6103-0320.3	330224			L=320



STEYR DAIMLER PUCH 500/600/700 (58-69)

	500/500 D 650T/650 TR 700C/700 E			01.58 01.61 01.60	12.69 12.69 12.69		03.3115-2102.3	010247			Hz 15,87 ATE
	650T/650 TR 700C/700 E			01.61 01.60	12.69 12.69		03.3217-0401.3	020023			Rz 17,46
	500/500 D 650T/650 TR 700C/700 E			01.58 01.61 01.60	12.69 12.69 12.69		83.6104-0220.3	330474			L=220
	500/500 D 650T/650 TR 700C/700 E			01.58 01.62 01.60	12.69 12.69 12.69		03.3215-0221.3	020013			Rz 15,87

SUBARU 1300/1600/1800 (84-90)

	1.3 (AC1) 1.3 (AG1) 1.3 (AN1) 1.6 (AC2) 1.6 (AG2) 1.6 (AN2) 1.6 4WD (AN3) 1.8 (AC4) 1.8 (AG4) 1.8 (AN4) 1.8 (AX4) XT Turbo 1.8 4WD (AC5) 1.8 4WD (AG5) 1.8 4WD (AK5) 1.8 Turbo 4WD (AC7) 1.8 Turbo 4WD (AG5) 1.8 Turbo 4WD (AK7) 1.8 Turbo 4WD (AX7)			11.84 11.84 11.84 11.84 11.84 11.84 11.84 11.84 11.84 11.84 11.84 11.84 11.84 11.84 11.84 11.84 11.84 11.84 11.84	12.90 12.90 12.90 12.90 12.90 12.90 12.90 12.90 12.90 12.90 12.90 12.90 12.90 12.90 12.90 12.90 12.90 12.90 12.90	- (⊖) / + Limousine/ + 4 türig ¹⁾ - (⊖) / + Limousine/ + 3 türig ²⁾ - (⊖) / + Kombiwoagen ³⁾ - (⊖) / + Limousine/ + 4 türig ¹⁾ - (⊖) / + Limousine/ + 3 türig ²⁾ - (⊖) / + Kombiwoagen ³⁾ - (⊖) / + Kombiwoagen ³⁾ + Limousine/ + 4 türig ⁴⁾ + Limousine/ + 3 türig ⁵⁾ + Kombiwoagen ⁶⁾ + Coupe ⁷⁾ + Limousine/ + 4 türig ⁴⁾ + Limousine/ + 3 türig ⁵⁾ + Kombiwoagen ⁶⁾ + Limousine/ + 4 türig ⁴⁾ + Limousine/ + 3 türig ⁵⁾ + Kombiwoagen ⁶⁾ + Limousine/ + 4 türig ⁴⁾ + Limousine/ + 3 türig ⁵⁾ + Kombiwoagen ⁶⁾ + Coupe ⁷⁾	13.0460-5991.2	605991			20112 18,0 +/WK AKE
	1.3 (AC1) 1.3 (AG1) 1.3 (AN1) 1.6 (AC2) 1.6 (AG2) 1.6 (AN2) 1.6 4WD (AN3) 1.8 (AC4) 1.8 (AG4) 1.8 (AN4) 1.8 (AX4) XT Turbo 1.8 4WD (AC5) 1.8 4WD (AG5) 1.8 4WD (AK5) 1.8 Turbo 4WD (AC7) 1.8 Turbo 4WD (AG5) 1.8 Turbo 4WD (AK7) 1.8 Turbo 4WD (AX7)			11.84 11.84 11.84 11.84 11.84 11.84 11.84 11.84 11.84 11.84 11.84 11.84 11.84 11.84 11.84 11.84 11.84 11.84 11.84	12.90 12.90 12.90 12.90 12.90 12.90 12.90 12.90 12.90 12.90 12.90 12.90 12.90 12.90 12.90 12.90 12.90 12.90 12.90	- (⊖) / + Limousine/ + 4 türig ¹⁾ - (⊖) / + Limousine/ + 3 türig ²⁾ - (⊖) / + Kombiwoagen ³⁾ - (⊖) / + Limousine/ + 4 türig ¹⁾ - (⊖) / + Limousine/ + 3 türig ²⁾ - (⊖) / + Kombiwoagen ³⁾ - (⊖) / + Kombiwoagen ³⁾ + Limousine/ + 4 türig ⁴⁾ + Limousine/ + 3 türig ⁵⁾ + Kombiwoagen ⁶⁾ + Coupe ⁷⁾ + Limousine/ + 4 türig ⁴⁾ + Limousine/ + 3 türig ⁵⁾ + Kombiwoagen ⁶⁾ + Limousine/ + 4 türig ⁴⁾ + Limousine/ + 3 türig ⁵⁾ + Kombiwoagen ⁶⁾ + Limousine/ + 4 türig ⁴⁾ + Limousine/ + 3 türig ⁵⁾ + Kombiwoagen ⁶⁾ + Coupe ⁷⁾	24.0118-0104.1	418104			242 18,0 16,0 V

SUBARU JUSTY (3-tuerig) (84-95)

	1.0 (KA5) 1.0 4WD (KA6)			09.84 09.84	12.88 12.88		13.0460-5963.2	605963			20958 16,0 AKE
	1.0 (KA5) 1.0 4WD (KA6)			09.84 09.84	09.95 11.94		24.0118-0115.1	418115			212 18,0 15,5 V
	1.2 (KA7) 1.2 4WD (KA8)			01.89 01.89	09.95 12.94		24.0118-0116.1	418116			240 18,0 15,5 V

1) - (⊖) / + Saloon/ + 4 door / - (⊖) / + Berlina/ + 4 porte / - (⊖) / + Berlina/ + 4 portes / - (⊖) / + Berlina/ + 4 puertas

2) - (⊖) / + Saloon/ + 3 door / - (⊖) / + Berlina/ + 3 porte / - (⊖) / + Berlina/ + 3 portes / - (⊖) / + Berlina/ + 3 puertas

3) - (⊖) / + Estate / - (⊖) / + Station Wagon / - (⊖) / + Break / - (⊖) / + Break





























4) + Saloon/ + 4 door / + Berlina/ + 4 porte / + Berlina/ + 4 portes / + Berlina/ + 4 puertas

5) + Saloon/ + 3 door / + Berlina/ + 3 porte / + Berlina/ + 3 portes / + Berlina/ + 3 puertas

6) + Estate / + Station Wagon / + Break / + Break

7) + Coupe / + Coupé / + Coupé / + Coupé



								
SUBARU JUSTY (3-tuerig) (84-95)								
	1.0 (KA5) 1.0 4WD (KA6) 1.2 (KA7) 1.2 4WD (KA8)		09.84 09.84 01.89 01.89	09.95 11.94 09.95 12.94	03.0137-0222.2 03.0137-9127.2	650222 669127		180 x 31 Bremsbacken-Zubehör
SUBARU JUSTY (5-tuerig) (84-95)								
	1.0 (KD5) 1.0 4WD (KD6)		09.84 09.84	12.88 12.88	13.0460-5963.2	605963		20958 16,0 AKE
	1.0 (KD5) 1.0 4WD (KD6) 1.2 4WD (KD8)		09.84 09.84 01.89	09.95 11.94 12.94	24.0118-0115.1 24.0118-0116.1	418115 418116		212 18,0 15,5 V 240 18,0 15,5 V
	1.0 (KD5) 1.0 4WD (KD6) 1.2 4WD (KD8)		09.84 09.84 01.89	09.95 11.94 12.94	03.0137-0222.2 03.0137-9127.2	650222 669127		180 x 31 Bremsbacken-Zubehör
SUBARU LEGACY (89-93)								
	1.8 4WD (BJ3) 2.0 4WD (BC5) 2.0 4WD (BF5) 2.2 4WD 2.2 i Turbo	100	01.89 01.89 01.89 01.89 06.91	12.93 12.93 12.93 12.93 12.93	13.0460-5978.2	605978		21495 17,0 +/WK
	1.8 4WD (BJ3) 2.0 4WD (BC5) 2.0 4WD (BF5) 2.2 4WD 2.0 i Turbo 2.2 i Turbo	100	01.89 01.89 01.89 01.89 06.91 06.91	12.93 12.93 12.93 12.93 12.93 12.93	24.0124-0141.1 24.0124-0145.1	424141 424145		260 24,0 22,0 V +B 277 24,0 22,0 V +B
	1.8 4WD (BJ3) 2.0 4WD (BC5) 2.0 4WD (BF5)		01.89 01.89 01.89	12.93 12.93 12.93	03.0137-0302.2 03.0137-9192.2	650302 669192		229 x 37 Bremsbacken-Zubehör
SUBARU LIBERO E10/E12 (87-93)								
	1.0 (KJ5) 1.0 4WD (KJ6) 1.2 4WD (KJ8)		01.87 01.87 01.87	04.93 04.93 04.93	13.0460-5963.2	605963		20958 16,0 AKE
	1.0 (KJ5) 1.0 4WD (KJ6) 1.2 4WD (KJ8)		01.87 01.87 01.87	04.93 04.93 04.93	24.0118-0115.1	418115		212 18,0 15,5 V
SUZUKI SJ410 (81-88)								
	1.0	33	09.81	12.88	13.0460-5961.2	605961		21252 15,0 + AKE
	1.0	33	09.81	12.88	24.0110-0192.1	410192		290 10,0 9,0
	1.0 1.0	33 33	09.81 06.83	05.83 12.88	03.0137-9128.2 03.0137-0306.2	669128 650306		Bremsbacken-Zubehör 220 x 40
SUZUKI SJ413 (84-90)								
	1.3		09.84	08.90	13.0460-5966.2 13.0460-2997.2	605966 602997		21142 15,0 SUM 20708 15,8 /S TRW
	1.3		09.84	08.90	24.0110-0192.1	410192		290 10,0 9,0
	1.3		09.84	08.90	03.0137-0306.2	650306		220 x 40
SUZUKI ALTO (86-91)								
	0.8 (CA91/CB91)		01.86	08.91	13.0460-5916.2	605916		20731 15,3 AKE
	0.8 (CA91/CB91)		01.86	08.91	24.0110-0136.1	410136		215 10,0 8,0
	0.8 (CA91/CB91)		01.86	08.91	03.0137-0222.2 03.0137-9127.2	650222 669127		180 x 31 Bremsbacken-Zubehör
SUZUKI CAPPUCINO (92-95)								
	0.7 i 12V	47	02.92	08.95	13.0460-5985.2	605985		21333 15,0 +/WK TOK
	0.7 i 12V	47	02.92	08.95	24.0117-0103.1	417103		231 17,0 15,0 V +B

SUZUKI SAMURAI (88-92)		SUZUKI SUPER-CARRY (80-85)		SUZUKI SUPER-CARRY (85-88)		SUZUKI SWIFT I (84-89)		SUZUKI SWIFT II (89-96)		SUZUKI X-90 (95-97)		
	1.0 1.3 (SJ413)			11.88 11.88	12.92 12.92			13.0460-5966.2 13.0460-2997.2	605966 602997		21142 15,0 20708 15,8 /S	SUM TRW
	1.0 1.3 (SJ413)			11.88 11.88	12.92 12.92			24.0110-0192.1	410192		290 10,0 9,0	
	1.0 1.3 (SJ413)			11.88 11.88	12.92 12.92			03.0137-0306.2	650306		220 x 40	
	0.8 (ST90)			10.80	02.85			03.0137-9128.2	669128		Bremsbacken-Zubehör	
	1.0 (SK410)			03.85	02.88			13.0460-5916.2	605916		20731 15,3	AKE
	1.0 (SK410)			03.85	02.88			24.0110-0136.1	410136		215 10,0 8,0	
	1.0 Van			08.85	02.88			24.0110-0192.1	410192		290 10,0 9,0	
	1.0 (SA310) 1.3 (SA413) 1.3 i 16V GTi (SA413)			10.83 10.84 08.86	12.89 12.89 12.89			13.0460-5961.2 13.0460-5985.2	605961 605985		21252 15,0 + 21333 15,0 +/WK	AKE TOK
	1.0 (SA310) 1.3 (SA413) 1.0 (SA310) 1.3 (SA413)			10.83 10.84 03.89 03.89	02.89 02.89 12.89 12.89			24.0110-0136.1 24.0117-0103.1	410136 417103		215 10,0 8,0 231 17,0 15,0 V +B	
	1.0 i (SF310) 1.3 (SF413) 1.3 4WD (SF413)		320339 320339 320339	08.92 04.89 04.89				13.0460-5985.2	605985		21333 15,0 +/WK	TOK
	1.0 i (SF310) 1.3 (SF413) 1.3 4WD (SF413)	320340 320340 320340			10.96 10.96 10.96			13.0460-5837.2	605837		23296 14,5 +/WK	BOS
	1.0 i (SF310) 1.3 (SF413) 1.3 4WD (SF413)			08.91 04.89 04.89	10.96 10.96 10.96			24.0117-0103.1	417103		231 17,0 15,0 V +B	
	1.3 (SF413) 1.3 (SF413)			04.89 04.89	10.96 + 3 türig ¹⁾ 10.96 + 5 türig ²⁾			24.3215-1704.3	020532		Rz 15,87	
	1.0 i (SF310) 1.3 (SF413) 1.3 (SF413)	320339 320339 320339		08.92 04.89 04.89	+ ABS/ + 4 türig ³⁾ + ABS/ + 4 türig ³⁾ + ABS/ + 4 türig ³⁾			24.3217-1725.3 24.3217-1726.3	020512 020513	<input type="checkbox"/> <input type="checkbox"/>	Rz 17,46 Rz 17,46	
	1.0 i (SF310) 1.0 i (SF310) 1.3 (SF413) 1.3 (SF413) 1.3 4WD (SF413) 1.3 4WD (SF413)			08.92 08.92 04.89 04.89 08.92 08.92	10.96 - ABS/ + 3 türig ⁴⁾ 10.96 - ABS/ + 5 türig ⁵⁾ 10.96 - ABS/ + 3 türig ⁴⁾ 10.96 - ABS/ + 5 türig ⁵⁾ 10.96 - ABS/ + 3 türig ⁴⁾ 10.96 - ABS/ + 5 türig ⁵⁾			03.0137-0414.2	650414		180 x 27	
	1.0 i (SF310) 1.3 (SF413) 1.3 4WD (SF413) 1.6 i 16V (SF416)	320339 320339 320339		08.92 04.89 04.89 08.92	+ ABS/ + 4 türig ³⁾ + ABS/ + 4 türig ³⁾ + ABS/ + 4 türig ³⁾ 10.96			03.0137-0315.2 03.0137-9271.2	650315 669271		200 x 32 Bremsbacken-Zubehör	
	1.0 i (SF310) 1.3 (SF413) 1.3 4WD (SF413)	320340 320340 320340			10.96 + ABS/ + 4 türig ³⁾ 10.96 + ABS/ + 4 türig ³⁾ 10.96 + ABS/ + 4 türig ³⁾			03.0137-0500.2	650500		200 x 32 HEB	BOS
	1.0 i (SF310) 1.0 i (SF310) 1.3 (SF413) 1.3 (SF413)			08.92 08.92 04.89 04.89	10.96 - ABS/ + 3 türig ⁴⁾ 10.96 - ABS/ + 5 türig ⁵⁾ 10.96 - ABS/ + 3 türig ⁴⁾ 10.96 - ABS/ + 5 türig ⁵⁾			24.0218-0042.1	480164		180/182 x 36	
	1.0 i (SF310) 1.0 i (SF310) 1.0 i (SF310) 1.3 (SF413) 1.3 (SF413) 1.3 (SF413) 1.3 4WD (SF413) 1.6 i 16V (SF416)			08.92 08.92 08.92 04.89 04.89 08.92 04.89 08.92	10.96 + ABS/ + 3 türig ⁶⁾ 10.96 + ABS/ + 4 türig ³⁾ 10.96 + ABS/ + 5 türig ⁷⁾ 10.96 + ABS/ + 3 türig ⁶⁾ 10.96 + ABS/ + 4 türig ³⁾ 10.96 + ABS/ + 5 türig ⁷⁾ 10.96 + ABS 10.96			24.0220-0040.1	480166		200/202 x 40	
	1.0 i (SF310) 1.3 4WD (SF413)			08.92 04.89	10.96 10.96			24.3728-2003.2 24.3728-2201.2	592003 592201		L=607 L=525	
	1.6 i 16V 1.6 i 16V 4x4	71 71		09.95 09.95	10.97 10.97			13.0460-5967.2	605967		21500 15,0 +/WK	AKE
	1.6 i 16V 1.6 i 16V 4x4	71 71		09.95 09.95	10.97 10.97			24.0110-0242.1	410242		290 10,0 8,0 +B	

1) + 3 door / + 3 porte / + 3 portes / + 3 puertas

2) + 5 door / + 5 porte / + 5 portes / + 5 puertas

3) + ABS/ + 4 door / + ABS/ + 4 porte / + ABS/ + 4 portes / + ABS/ + 4 puertas

4) - ABS/ + 3 door / - ABS/ + 3 porte / - ABS/ + 3 portes / - ABS/ + 3 puertas

5) - ABS/ + 5 door / - ABS/ + 5 porte / - ABS/ + 5 portes / - ABS/ + 5 puertas





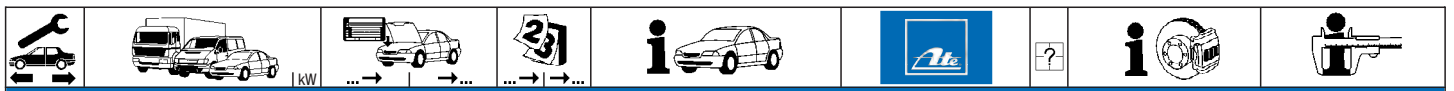























6) + ABS/ + 3 door / + ABS/ + 3 porte / + ABS/ + 3 portes / + ABS/ + 3 puertas



































7) + ABS/ + 5 door / + ABS/ + 5 porte / + ABS/ + 5 portes / + ABS/ + 5 puertas



TALBOT 1100 (68-81)											
	1.3 Spezial/TI			09.78	12.81			13.0441-4819.2	250104	Dichtungssatz	ATE
	0.9			01.73	12.81			13.0460-3010.2	603010	20009 15,0	ATE
	1.1			01.73	12.81						
	1.2			01.73	12.81						
	1.3 Spezial/TI			01.74	12.81			13.0460-4033.2	604033	20034 15,0	ATE
								13.0460-0038.2	610038	Belagsatz-Zubehör	ATE
	0.9			01.70	12.76			24.3219-1114.3	020323	Rz 19,05	BDX
	1.1			01.70	12.76						
	1.2			01.70	12.76						
	1.3 Spezial/TI			01.77	12.81			24.3220-0905.3	020207	Rz 20,64	TRW
	0.9			01.70	12.81			03.0137-0271.2	650271	229 x 42 HEB	TRW
	1.1			01.70	12.81			03.0137-9027.2	669027	Bremsbacken-Zubehör	TRW
	1.2			01.70	12.81						
	1.3 Spezial/TI			08.74	12.81			03.0137-0139.2	650139	229 x 42	BDX
								03.0137-0124.2	650124	229 x 42 HEB AUT	BDX
								03.0137-9020.2	669020	Bremsbacken-Zubehör	BDX
	0.9			10.76	12.81			24.2525-1601.3	040062	Nz 25,40	
	1.1			10.76	12.81						
	1.2			10.76	12.81						
	1.3 Spezial/TI			10.76	12.81						
TALBOT 1301 (66-76)											
	1.3			09.66	12.76			13.0460-4033.2	604033	20034 15,0	ATE
								13.0460-0038.2	610038	Belagsatz-Zubehör	ATE
	1.3			09.66	12.76			03.0137-0139.2	650139	229 x 42	BDX
								03.0137-0124.2	650124	229 x 42 HEB AUT	BDX
								03.0137-9020.2	669020	Bremsbacken-Zubehör	BDX
TALBOT 1307 (75-80)											
	1.3			07.75	01.80			24.3220-0905.3	020207	Rz 20,64	TRW
	1.3 S			07.75	12.78						
	1.3			07.75	01.80			03.0137-0139.2	650139	229 x 42	BDX
	1.3 S			07.75	12.78			03.0137-0124.2	650124	229 x 42 HEB AUT	BDX
								03.0137-0271.2	650271	229 x 42 HEB	TRW
								03.0137-9020.2	669020	Bremsbacken-Zubehör	BDX
								03.0137-9027.2	669027	Bremsbacken-Zubehör	TRW
	1.3			07.75	01.80			24.2419-1601.3	030080	Gz 19,05	
	1.3 S			07.75	12.78						
	1.3			07.75	01.80			24.2525-1601.3	040062	Nz 25,40	
	1.3 S			07.75	12.78						
TALBOT 1308 (78-81)											
	1.4			11.78	08.81			24.3220-0905.3	020207	Rz 20,64	TRW
	1.4			11.78	08.81			03.0137-0139.2	650139	229 x 42	BDX
								03.0137-0124.2	650124	229 x 42 HEB AUT	BDX
								03.0137-0271.2	650271	229 x 42 HEB	TRW
								03.0137-9020.2	669020	Bremsbacken-Zubehör	BDX
								03.0137-9027.2	669027	Bremsbacken-Zubehör	TRW
	1.4			11.78	08.81			24.2419-1601.3	030080	Gz 19,05	
	1.4			11.78	08.81			24.2525-1601.3	040062	Nz 25,40	
TALBOT 1309 (78-80)											
	1.6			10.78	01.80			24.3220-0905.3	020207	Rz 20,64	TRW
	1.6			10.78	01.80			03.0137-0139.2	650139	229 x 42	BDX
								03.0137-0124.2	650124	229 x 42 HEB AUT	BDX
								03.0137-0271.2	650271	229 x 42 HEB	TRW
								03.0137-9020.2	669020	Bremsbacken-Zubehör	BDX
								03.0137-9027.2	669027	Bremsbacken-Zubehör	TRW
	1.6			10.78	01.80			24.2419-1601.3	030080	Gz 19,05	
	1.6			10.78	01.80			24.2525-1601.3	040062	Nz 25,40	
TALBOT 1501 (66-76)											
	1.5			09.66	12.76			13.0460-4033.2	604033	20034 15,0	ATE
								13.0460-0038.2	610038	Belagsatz-Zubehör	ATE

TALBOT 1501 (66-76)									
	1.5		09.66	12.76			03.0137-0139.2 650139 03.0137-0124.2 650124 03.0137-9020.2 669020	229 x 42 229 x 42 HEB AUT Bremsbacken-Zubehör	BDX BDX BDX
TALBOT 1510/ALPINE (79-84)									
	1.4 1.6		09.80 09.80	04.84 12.83			11.0441-5402.2 250028 11.0101-5407.2 260011 11.8171-0008.1 990049	Dichtungssatz Hülzensatz Führungsbolzen	ATE ATE ATE
	1.4 1.6		08.79 08.79	04.84 12.83			24.3222-1708.3 020407 24.3220-0905.3 020207 24.3222-1118.3 020315	Rz 22,20 Rz 20,64 Rz 22,20	ATE TRW BDX
	1.4 1.6		08.79 08.79	04.84 12.83			03.0137-0139.2 650139 03.0137-0124.2 650124 03.0137-0271.2 650271 03.0137-9020.2 669020 03.0137-9027.2 669027	229 x 42 229 x 42 HEB AUT 229 x 42 HEB Bremsbacken-Zubehör Bremsbacken-Zubehör	BDX BDX TRW BDX TRW
	1.4 1.6		08.79 08.79	04.84 12.83			03.0520-3122.3 693122	22,20/229x42 TopKit	BDX
	1.4 1.6		08.79 08.79	04.84 12.83			24.2419-1601.3 030080	Gz 19,05	
	1.4 1.6		08.79 08.79	04.84 12.83			24.2525-1601.3 040062	Nz 25,40	
TALBOT HORIZON (78-86)									
	1.1 1.3 1.4 1.6 1.9 D		02.83 02.83 02.83 02.83 02.83	09.84 06.86 06.86 06.86 06.86			03.2120-2031.3 010106 03.3517-0101.2 390322	THz 20,64 Verschlußschraube	ATE
	1.1 1.3 1.4 1.6 1.9 D		01.79 02.78 07.79 07.82 07.82	09.84 06.86 06.86 06.86 06.86			13.0441-4819.2 250104	Dichtungssatz	ATE
	1.1 1.3 1.4 1.6 1.9 D		01.79 02.78 07.79 07.82 07.82	09.84 06.86 06.86 06.86 06.86			24.3220-0905.3 020207	Rz 20,64	TRW
	1.1 1.3 1.4 1.6 1.9 D		01.79 02.78 07.79 07.82 07.82	09.84 06.86 06.86 06.86 06.86			03.0137-0139.2 650139 03.0137-0124.2 650124 03.0137-0271.2 650271 03.0137-9020.2 669020 03.0137-9027.2 669027	229 x 42 229 x 42 HEB AUT 229 x 42 HEB Bremsbacken-Zubehör Bremsbacken-Zubehör	BDX BDX TRW BDX TRW
	1.1 1.3 1.4 1.6 1.9 D		01.79 02.78 07.79 07.82 07.82	09.84 06.86 06.86 06.86 06.86			24.2419-1601.3 030080	Gz 19,05	
	1.1 1.3 1.4 1.6		11.77 02.78 07.79 07.82	09.84 06.86 06.86 06.86			24.2525-1601.3 040062	Nz 25,40	
TALBOT MATRA BAGHEERA (74-80)									
	1.3 1.4		01.74 12.75	01.78 01.78			13.0460-4035.2 604035	20173 15,0	ATE
	1.3 1.4		01.74 12.75	03.78 09.80			13.0460-3961.2 603961	20336 14,0 +/WK	BDX
	1.3 1.4		01.77 01.77	03.78 09.80			24.2525-1601.3 040062	Nz 25,40	
TALBOT MATRA MURENA (81-85)									
	1.6 2.1		08.81 04.83	01.85 01.85			13.0460-3961.2 603961	20336 14,0 +/WK	BDX
	1.6		08.81	01.85			24.2525-1601.3 040062	Nz 25,40	
TALBOT MATRA RANCHO (77-84)									
	1.4		03.77	12.81			13.0441-4819.2 250104	Dichtungssatz	ATE
	1.4		03.77	12.78			13.0460-4035.2 604035	20173 15,0	ATE

										
TALBOT MATRA RANCHO (77-84)										
	1.4			03.77	12.79		24.3220-0905.3	020207	Rz 20,64	TRW
	1.4			01.80	06.84		24.3222-1118.3	020315	Rz 22,20	BDX
	1.4			03.77	06.84		03.0137-0124.2	650124	229 x 42 HEB AUT	BDX
							03.0137-0271.2	650271	229 x 42 HEB	TRW
							03.0137-9020.2	669020	Bremsbacken-Zubehör	BDX
							03.0137-9027.2	669027	Bremsbacken-Zubehör	TRW
	1.4			01.80	06.84		03.0520-3122.3	693122	22,20/229x42 TopKit	BDX
	1.4			03.77	06.84		24.2525-1601.3	040062	Nz 25,40	
TALBOT SAMBA (81-86)										
	0.9			01.81	12.85		24.2119-1503.3	010404	THz 19,05	
	1.1			01.81	06.86					
	1.2 Rallye			01.83	10.86					
	1.4			01.81	10.86					
	1.4 Cabrio			01.81	06.86					
	1.4 Rallye			01.83	10.86					
	0.9			01.81	09.83		13.0460-3928.2	603928	20140 14,0 +/-WE	BDX
	1.1			01.81	09.83					
	1.2 Rallye			01.83	09.83					
	1.4			01.81	09.83					
	1.4 Cabrio			01.81	09.83					
	1.4 Rallye			01.83	09.83					
	0.9			01.81	12.85		24.3222-1102.3	020257	Rz 22,20	BDX
	1.1			01.81	06.86					
	1.2 Rallye			01.83	10.86					
	1.4			01.81	10.86					
	1.4 Cabrio			01.81	06.86					
	1.4 Rallye			01.83	10.86					
	0.9			01.81	12.85		03.0137-9032.2	669032	Bremsbacken-Zubehör	BDX
	1.1			01.81	06.86					
	1.2 Rallye			01.83	10.86					
	1.4			01.81	10.86					
	1.4 Cabrio			01.81	06.86					
	1.4 Rallye			01.83	10.86					
TALBOT SOLARA (80-86)										
	1.3			09.80	06.82		11.0441-5402.2	250028	Dichtungssatz	ATE
	1.6			09.80	07.86		11.0101-5407.2	260011	Hülssensatz	ATE
							11.8171-0008.1	990049	Führungsbolzen	ATE
	1.3			02.80	06.82		24.3222-1708.3	020407	Rz 22,20	ATE
	1.6			02.80	07.86		24.3222-1118.3	020315	Rz 22,20	BDX
							24.3220-0905.3	020207	Rz 20,64	TRW
	1.3			02.80	06.82		03.0137-0139.2	650139	229 x 42	BDX
	1.6			02.80	07.86		03.0137-0124.2	650124	229 x 42 HEB AUT	BDX
							03.0137-0271.2	650271	229 x 42 HEB	TRW
							03.0137-9020.2	669020	Bremsbacken-Zubehör	BDX
							03.0137-9027.2	669027	Bremsbacken-Zubehör	TRW
	1.3			02.80	06.82		24.2419-1601.3	030080	Gz 19,05	
	1.6			02.80	07.86					
	1.3			02.80	06.82		24.2525-1601.3	040062	Nz 25,40	
	1.6			02.80	07.86					
TALBOT TAGORA (80-87)										
	2.1			06.80	12.83		11.0441-5401.2	250027	Dichtungssatz	ATE
	2.3 TD			08.81	12.87					
	2.6			08.81	10.83		11.0441-5401.2	250027	Dichtungssatz	ATE
	2.1			06.80	12.83		24.0113-0128.1	413128	273 13,0 10,7	
	2.3 TD			08.81	12.87					
	2.1			06.80	12.83		24.3220-1619.3	020246	Rz 20,64	TRW
	2.3 TD			08.81	12.87					
	2.1			06.80	12.83		03.0137-9082.2	669082	Bremsbacken-Zubehör	TRW
	2.3 TD			08.81	12.87					
TOYOTA 4-RUNNER (83-88)										
	2.0 (YN60)			08.83	07.88		13.0460-5935.2	605935	20852 15,5	SUM
	2.4 D (LN60)			08.83	07.88					
	2.0 (YN63)			08.83	07.88		13.0460-5935.2	605935	20852 15,5	SUM
	2.4 D (LN61)			08.83	07.88		13.0460-0327.2	610327	Belagsatz-Zubehör	SUM
	2.0 (YN60)			08.83	07.88		24.0113-0105.1	413105	302 12,5 11,5	
	2.4 D (LN60)			08.83	07.88					
	2.0 (YN63)			08.85	07.88		24.0120-0168.1	420168	289 20,0 18,0 V	
	2.4 D (LN61)			08.85	07.88					

								
TOYOTA 4-RUNNER (83-88)								
	2.0 (YN60) 2.4 D (LN60)		08.83 08.83	07.88 07.88	03.0137-0226.2	650226		254 x 58
TOYOTA 4-RUNNER (88-96)								
	3.0 (VZN130)		08.88	11.95	13.0460-5992.2	605992		21679 15,0 +/WK
	3.0 (VZN130)		08.88	11.95	24.0120-0168.1	420168		289 20,0 18,0 V
	3.0 i V6 (VZN130) 3.0 TD (KZN130)	105 92	07.90 10.93	11.95 03.96	24.0125-0135.1	425135		291 25,0 23,0 V
	3.0 (VZN130)		08.88	11.95	03.0137-0308.2	650308		295 x 51
	3.0 (VZN130)		08.88	11.95	24.0229-5004.1	480312		295/297 x 67
TOYOTA CAMRY (82-86)								
	1.8 (SV10) 1.8 TD (CV10) 2.0 (SV11) 2.0 TD (CV11)		10.82 10.82 10.82 08.85	10.86 07.85 10.86 10.86	13.0460-5976.2 13.0460-0325.2	605976 610325		20870 15,0 Belagsatz-Zubehör AKE AKE
	1.8 (SV10) 1.8 TD (CV10) 2.0 (SV11) 2.0 TD (CV11)		10.82 10.82 10.82 08.85	10.86 07.85 10.86 10.86	24.3219-1712.3	020388		Rz 19,05
	1.8 (SV10) 1.8 TD (CV10) 2.0 (SV11) 2.0 TD (CV11)		10.82 10.82 10.82 08.85	10.86 07.85 10.86 10.86	03.0137-0313.2 03.0137-9114.2	650313 669114		200 x 37 Bremsbacken-Zubehör
TOYOTA CAMRY (86-91)								
	1.8 (SV20) 2.0 i (SV21) 2.0 TD (CV20)		10.86 10.86 10.86	12.87 - ABS 12.87	13.0460-0333.2	610333		Belagsatz-Zubehör SUM
	1.8 (SV20) 2.0 i (SV21) 2.0 i (SV21) 2.0 i 4WD (SV25) 2.0 i 4WD (SV25) 2.0 TD (CV20) 2.5 i V6 (VZV21)		01.88 01.88 08.88 10.87 08.88 01.88 02.88	07.88 - ABS 11.88 - ABS 11.88 11.88 11.88	13.0460-5938.2	605938		21158 15,5 AKE
	2.0 i (SV21) 2.0 i 4WD (SV25) 2.0 TD (CV20) 2.5 i V6 (VZV21)		12.88 12.88 12.88 12.88	08.89 08.89 08.89 08.89	13.0460-0333.2	610333		Belagsatz-Zubehör SUM
	1.8 (SV20) 2.0 i (SV21) 2.0 TD (CV20)		10.86 10.86 10.86	12.87 - ABS 12.87	24.0122-0154.1	422154		255 22,0 21,0 V
	2.0 i (SV21) 2.5 i V6 (VZV21)		10.86 02.88	05.91 05.91	24.0110-0241.1	410241		269 10,0 9,0
	1.8 (SV20) 2.0 i (SV21) 2.0 TD (CV20)		10.86 10.86 10.86	07.88 + Limousine ¹⁾ 05.91 + Limousine ¹⁾ 05.91 + Limousine ¹⁾	24.3219-1712.3	020388		Rz 19,05
	1.8 (SV20) 2.0 i (SV21) 2.0 TD (CV20)		10.86 10.86 10.86	07.88 + Limousine ¹⁾ 05.91 + Limousine ¹⁾ 05.91 + Limousine ¹⁾	03.0137-0313.2 03.0137-9114.2	650313 669114		200 x 37 Bremsbacken-Zubehör
TOYOTA CAMRY (91-96)								
	2.2 i (SXV10) 2.2 i (SXV10) 3.0 i V6 (VCV10)		06.91 08.93 06.91	07.93 08.96 08.96	24.0128-0114.1 24.0128-0115.1	428114 428115		255 28,0 26,0 V 275 28,0 26,0 V +B
	2.2 i (SXV10) 3.0 i V6 (VCV10)		06.91 06.91	08.96 + ABS 08.96	13.0460-5835.2	605835		20076 15,5 +/WK AKE
	2.2 i (SXV10)		06.91	08.96 + ABS	24.0110-0700.1	410700		269 10,0 9,0
	2.2 i (SXV10)		06.91	08.96 - ABS	03.0137-0318.2	650318		229 x 41
TOYOTA CARINA II (83-87)								
	1.6 (AT151) 1.8 (ST150) 2.0 D (CT150)		10.83 10.83 10.83	11.87 - Europa ²⁾ 11.87 - Europa ²⁾ 11.87 - Europa ²⁾	24.3219-1712.3	020388		Rz 19,05
	1.6 (AT151) 1.8 (ST150) 2.0 D (CT150)		10.83 10.83 10.83	11.87 11.87 11.87	03.0137-0313.2 03.0137-9114.2	650313 669114		200 x 37 Bremsbacken-Zubehör



























¹⁾ + Saloon / + Berlina / + Berline / + Berlina

²⁾ - Europe / - Europa / - Europe / - Europa



TOYOTA CARINA II (87-92)											
	1.6 (AT171)			12.87	01.92	+ 13" Rad ¹⁾	13.0460-5976.2	605976		20870 15,0	AKE
	2.0 (ST171)			12.87	01.92	+ 13" Rad ¹⁾	13.0460-0325.2	610325		Belagsatz-Zubehör	AKE
	2.0 D (CT170)			12.87	01.92						
	1.6 (AT171)			12.87	01.92	+ 14" Rad ²⁾	13.0460-0333.2	610333		Belagsatz-Zubehör	SUM
	2.0 (ST171)			12.87	01.92	+ 14" Rad ²⁾					
	2.0 D (CT170)			12.87	01.92						
	1.6 (AT171)			12.87	01.92	+ 13" Rad ¹⁾	24.0122-0153.1	422153		238 22,0 21,0 V	
	2.0 (ST171)			12.87	01.92	+ 13" Rad ¹⁾					
	2.0 D (CT170)			12.87	01.92						
	1.6 (AT171)			12.87	01.92	+ 14" Rad ²⁾	24.0122-0154.1	422154		255 22,0 21,0 V	
	2.0 (ST171)			12.87	01.92	+ 14" Rad ²⁾					
	2.0 D (CT170)			12.87	01.92						
	2.0 (ST171)			12.87	01.92		24.0110-0241.1	410241		269 10,0 9,0	
	1.6 (AT171)	◀		12.87	01.92		24.3219-1712.3	020388	☐	Rz 19,05	
	2.0 (ST171)	◀		12.87	01.92						
	2.0 D (CT170)	◀		12.87	01.92						
	1.6 (AT171)			12.87	01.92		03.0137-0313.2	650313		200 x 37	
	2.0 (ST171)			12.87	01.92		03.0137-9114.2	669114		Bremsbacken-Zubehör	
	2.0 D (CT170)			12.87	01.92						
	TOYOTA CARINA E (92-97)										
		1.6 i (AT190)			02.92	09.97		24.3571-1713.5	240201	☐	D=57, - Halter
1.8 i (AT191)				02.92	09.97		24.3571-1714.5	240202	☐	D=57, - Halter	SUM
2.0 D (CT190)				02.92	09.97						
	1.6 i (AT190)			02.92	09.97		13.0460-5951.2	605951		21601 17,5 +/WK	SUM
	1.8 i (AT191)			02.92	09.97		13.0460-0441.2	610441		Belagsatz-Zubehör	SUM
	2.0 D (CT190)			02.92	09.97						
	2.0 i (ST191)			02.92	09.97						
	1.6 i (AT190)			02.92	09.97		24.0125-0124.1	425124		255 24,9 24,0 V +B	
	2.0 D (CT190)			02.92	09.97						
	1.8 i (AT191)			02.92	09.97		24.0128-0113.1	428113		255 28,0 26,0 V	
	2.0 i (ST191)			02.92	09.97		24.0128-0116.1	428116		255 28,0 26,0 V	
	1.6 i (AT190)			03.94	09.97		24.5264-0526.3	330927	☐	L=525	
	1.8 i (AT191)			03.94	09.97		24.5264-0525.3	330926	☐	L=525	
	2.0 D (CT190)			03.94	09.97						
	2.0 GTi (ST191)			03.94	09.97						
	2.0 i (ST191)			03.94	09.97						
	2.0 GTi (ST191)			02.92	02.94		13.0460-5835.2	605835		20076 15,5 +/WK	AKE
	1.6 i (AT190)			02.92	12.95	+ Hosei Bremse ³⁾	24.3219-1729.3	020446	☐	Rz 19,05	
	1.8 i (AT191)			02.92	12.95	+ Hosei Bremse ³⁾	24.3219-1730.3	020447	☐	Rz 19,05	
	2.0 D (CT190)			02.92	12.95	+ Hosei Bremse ³⁾					
	2.0 i (ST191)			02.92	12.95	+ Hosei Bremse ³⁾					
	1.6 i (AT190)			02.92	12.95	+ Hosei Bremse ³⁾	03.0137-0313.2	650313		200 x 37	
	1.8 i (AT191)			02.92	12.95	+ Hosei Bremse ³⁾	03.0137-9114.2	669114		Bremsbacken-Zubehör	
	2.0 D (CT190)			02.92	12.95	+ Hosei Bremse ³⁾					
	2.0 i (ST191)			02.92	12.95	+ Hosei Bremse ³⁾					
	1.6 i (AT190)			01.96	09.97		03.0137-0375.2	650375	für TRW-System	200 x 37 HEB	TRW
	1.8 i (AT191)			01.96	09.97		03.0137-9301.2	669301		Bremsbacken-Zubehör	TRW
	2.0 D (CT190)			01.96	09.97						
	2.0 i (ST191)			01.96	09.97						
	1.6 i (AT190)			02.92	09.97		24.0220-0022.1	480083		200/201 x 55	
	1.8 i (AT191)			02.92	09.97						
	2.0 D (CT190)			02.92	09.97						
	2.0 i (ST191)			02.92	09.97						
	2.0 GTi (ST191)			03.94	09.97		03.0137-0402.2	650402		170 x 40	
	1.6 i (AT190)			02.92	09.97		24.3727-1932.2	581932	☐	L=1780	
	1.8 i (AT191)			02.92	09.97		24.3727-1933.2	581933	☐	L=1727	
	2.0 D (CT190)			02.92	09.97						
	2.0 i (ST191)			02.92	09.97						
	TOYOTA CELICA (85-89)										
	1.6 (AT160)			08.85	09.89		13.0460-5976.2	605976		20870 15,0	AKE
	1.6 i (AT160)			08.85	09.89		13.0460-0325.2	610325		Belagsatz-Zubehör	AKE
	2.0 i (ST162)			08.85	09.89	- ABS					
	2.0 i (ST162)			08.85	11.88	+ ABS	13.0460-5938.2	605938		21158 15,5	AKE
	2.0 i (ST162)			12.88	09.89	+ ABS	13.0460-0333.2	610333		Belagsatz-Zubehör	SUM
	2.0 i (ST162)			08.85	09.89		24.0110-0241.1	410241		269 10,0 9,0	
	1.6 (AT160)			08.85	09.89		24.3219-1712.3	020388	☐	Rz 19,05	
	1.6 i (AT160)			08.85	09.89						
	1.6 (AT160)			08.85	09.89		03.0137-0313.2	650313		200 x 37	
	1.6 i (AT160)			08.85	09.89		03.0137-9114.2	669114		Bremsbacken-Zubehör	

1) + 13" wheel / + ruota 13" / + roue 13" / + rueda 13"
 2) + 14" wheel / + ruota 14" / + roue 14" / + rueda 14"
 3) + Hosei brake / + freno Hosei / + freins Hosei / + freno de Hosei

									
TOYOTA CELICA (89-93)									
	1.6 i (AT180)	77		10.89	11.93	13.0460-5976.2	605976	20870 15,0	AKE
	2.0 i (ST182)	115		10.89	11.93	13.0460-0325.2	610325	Belagsatz-Zubehör	AKE
	2.0 Turbo 4x4 (ST185)			10.89	11.93				SUM
	1.6 i (AT180)	77		08.91	11.93	24.0122-0178.1	422178	255 22,0 20,0 V	
	2.0 i (ST182)	115		10.89	11.93				
	2.0 Turbo 4x4 (ST185)			10.89	01.92	24.0125-0144.1	425144	277 25,0 23,0 V	
	2.0 i (ST182)	115		10.89	11.93	24.0110-0241.1	410241	269 10,0 9,0	
	1.6 i (AT180)	77		10.89	11.93	24.3219-1712.3	020388	Rz 19,05	
	1.6 i (AT180)	77		10.89	11.93	03.0137-0313.2	650313	200 x 37	
						03.0137-9114.2	669114	Bremsbacken-Zubehör	
TOYOTA COROLLA (83-87)									
	1.3 (AE80)			05.83	04.87	13.0460-5976.2	605976	20870 15,0	AKE
	1.3 (EE80)			05.83	04.87	13.0460-0325.2	610325	Belagsatz-Zubehör	AKE
	1.6 (AE82)			05.83	04.87				
	1.8 D (CE80)			05.83	04.87				
	1.6 GT (AE82)			05.83	04.87	24.0109-0128.1	409128	242 9,0 8,0	
	1.3 (AE80)			05.83	04.87	03.0137-9114.2	669114	Bremsbacken-Zubehör	
	1.3 (EE80)			05.83	04.87				
	1.6 (AE82)			05.83	04.87				
	1.8 D (CE80)			05.83	04.87				
TOYOTA COROLLA (87-92)									
	1.3 (EE90)			05.87	05.92	13.0460-5976.2	605976	20870 15,0	AKE
	1.6 (AE92)			05.87	05.92	13.0460-0325.2	610325	Belagsatz-Zubehör	AKE
	1.6 4WD (AE95)			05.87	05.92				
	1.8 D (CE90)			05.87	05.92				
	1.3 (EE90)			09.89	05.92	24.0118-0110.1	418110	238 18,0 17,0 V	
	1.6 (AE92)			05.87	05.92				
	1.6 4WD (AE95)			05.87	05.92				
	1.8 D (CE90)			05.87	05.92				
	1.6 GTi (AE92)			05.87	05.92	24.0122-0188.1	422188	258 22,0 21,0 V	
	1.6 GTi (AE92)			05.87	05.92	24.0109-0128.1	409128	242 9,0 8,0	
	1.6 GTi (AE92)			05.87	05.92	24.0109-0128.1	409128	242 9,0 8,0	
	1.3 (EE90)			05.87	05.92	03.0137-0221.2	650221	200 x 37/30	
	1.6 (AE92)			05.87	05.92	03.0137-9114.2	669114	Bremsbacken-Zubehör	
	1.8 D (CE90)			05.87	05.92				
	1.3 (EE90)			05.87	05.92	03.0137-0313.2	650313	200 x 37	
	1.6 (AE92)			05.87	05.92	03.0137-9114.2	669114	Bremsbacken-Zubehör	
	1.8 D (CE90)			05.87	05.92				
	1.3 (EE90)			09.89	05.92	24.3727-1902.2	581902	L=1560	
	1.6 (AE92)			05.87	05.92				
	1.8 D (CE90)			05.87	05.92				
TOYOTA COROLLA (92-97)									
	1.3 16V (EE101)			05.92	04.97	24.3541-1705.5	240111	D=54, - Halter	SUM
	1.6 (AE101)			05.92	04.97	24.3541-1706.5	240112	D=54, - Halter	SUM
	1.8 (AE102)			05.92	05.95	24.0101-5405.2	260063	Bremsattel-Zubehör	SUM
	1.8 (AE103)			05.95	04.97				
	1.8 GTi 4WD			11.92	04.95				
	2.0 D (CE100)			05.92	04.97				
	1.3 16V (EE101)			05.92	04.97	13.0460-5951.2	605951	21601 17,5 +/WK	SUM
	1.6 (AE101)			05.92	04.97	13.0460-0441.2	610441	Belagsatz-Zubehör	SUM
	1.8 (AE102)			05.92	05.95				
	1.8 (AE103)			05.95	04.97				
	1.8 GTi 4WD			11.92	04.95				
	2.0 D (CE100)			05.92	04.97				
	1.3 (EE100)			05.92	05.95	13.0460-5976.2	605976	20870 15,0	AKE
	1.3 16V (EE101)			05.92	04.97	13.0460-0325.2	610325	Belagsatz-Zubehör	AKE
	1.6 (AE101)			05.92	04.97				
	1.6 GT APEX (AE101)			05.92	05.95				
	1.8 (AE102)			05.92	05.95				
	2.0 D (CE100)			05.92	04.97				
	1.3 (EE100)			05.92	05.95	24.0118-0110.1	418110	238 18,0 17,0 V	
	1.3 16V (EE101)			05.92	04.97	24.0122-0158.1	422158	255 22,0 20,0 V +B	
	1.6 (AE101)			05.92	04.97				
	1.8 (AE102)			05.92	05.95				
	1.8 (AE103)			05.95	04.97				
	1.8 GTi 4WD			11.92	04.95				
	2.0 D (CE100)			05.92	04.97				
	1.3 (EE100)			05.92	05.95	24.5235-0275.3	331179	L=275	
	1.3 16V (EE101)			05.92	04.97				
	1.6 (AE101)			05.92	04.95				
	1.6 GT APEX (AE101)			05.92	05.95				
	2.0 D (CE100)			05.92	04.95				

1) + Saloon / + Berlina / + Berline / + Berlina
2) + Estate / + Station Wagon / + Break / + Break
3) + Europe / + Europa / + Europe / + Europa
4) + Europe / + Estate / + Europa / + Station Wagon / + Europa / + Break / + Europa / + Break
5) + Europe / - GUS States / + Europa / - Stati del GUS / + Europe / - Etats de la CEI / + Europa / - estados del GUS
6) - Europe / - Europa / - Europe / - Europa
7) - Europe / + Coupe / - Europa / + Coupé / - Europe / + Coupé / - Europa / + Coupé
8) - Europe / + GUS-States / - Europa / + Stati del GUS / - Europe / + Etats de la CEI / - Europa / + estados del GUS



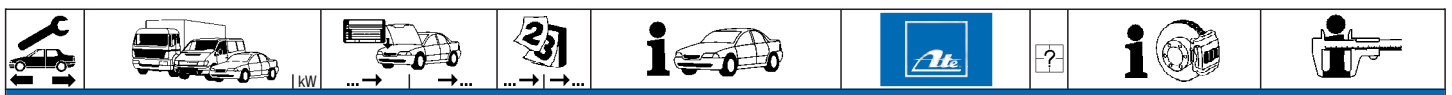

TOYOTA COROLLA (92-97)										
	1.6 GT APEX (AE101) 1.8 (AE102)			05.92 05.92	05.95 + Coupe 1) 05.95 + Europa 2)	24.0109-0159.1	409159			266 9,0 8,0 +B
	1.3 (EE100) 1.3 16V (EE101) 1.6 (AE101) 1.6 GT APEX (AE101) 2.0 D (CE100)			05.92 05.92 05.92 05.92 05.92	05.95 05.95 05.95 05.95 05.95	24.5235-0275.3	331179	2		L=275
	1.3 16V (EE101) 1.6 (AE101) 1.8 (AE103) 2.0 D (CE100)			06.95 06.95 05.95 06.95	04.97 04.97 04.97 04.97	24.5260-0280.3	330883	2		L=280
	1.3 16V (EE101) 1.6 (AE101) 2.0 D (CE100)			05.92 05.92 05.92	04.97 + Europa 2) 04.97 + Europa 2) 04.97 + Europa / - GUS-Staaten 3)	24.3219-1729.3 24.3219-1730.3	020446 020447	<input type="checkbox"/> <input type="checkbox"/>		Rz 19,05 Rz 19,05
	1.3 (EE100) 1.3 16V (EE101) 1.6 (AE101) 1.8 (AE102) 1.8 (AE103) 2.0 D (CE100)			05.92 05.92 05.92 05.92 05.95 05.92	05.95 - Europa 4) 04.97 - Europa 4) 04.97 - Europa 4) 05.95 - Europa 4) 04.97 - Europa / + Kombiwagen 5) 04.97 - Europa / + GUS-Staaten 6)	24.3217-1733.3 24.3217-1734.3	020559 020560	<input type="checkbox"/> <input type="checkbox"/>		Rz 17,46 Rz 17,46
	1.3 (EE100) 1.3 16V (EE101) 1.6 (AE101) 2.0 D (CE100)			05.92 05.92 05.92 05.92	05.95 + Europa 2) 04.97 + Europa 2) 04.97 + Europa 2) 04.97 + Europa 2)	03.0137-0221.2 03.0137-9114.2	650221 669114			200 x 37/30 Bremsbacken-Zubehör
	1.3 (EE100) 1.3 16V (EE101) 1.6 (AE101) 1.8 (AE102) 1.8 (AE103) 2.0 D (CE100)			05.92 05.92 05.92 05.92 05.95 05.92	05.95 - Europa 4) 04.97 - Europa 4) 04.97 - Europa 4) 05.95 - Europa 4) 04.97 - Europa / + Kombiwagen 5) 04.97 - Europa 4)	03.0137-0313.2 03.0137-9114.2	650313 669114			200 x 37 Bremsbacken-Zubehör
	1.3 (EE100) 1.3 16V (EE101) 1.6 (AE101) 2.0 D (CE100)			05.92 05.92 05.92 05.92	05.95 + Europa 2) 04.97 + Europa 2) 04.97 + Europa 2) 04.97 + Europa 2)	24.0220-0023.1	480084			200/201 x 56
	1.3 (EE100) 1.3 16V (EE101) 1.6 (AE101) 1.8 (AE102) 2.0 D (CE100)			05.92 05.92 05.92 05.92 05.92	05.95 - Europa 4) 04.97 - Europa 4) 04.97 - Europa 4) 05.95 - Europa 4) 04.97 - Europa 4)	24.0220-0023.1	480084			200/201 x 56
	1.6 GT APEX (AE101) 1.8 (AE102)			05.92 05.92	05.95 - Europa / + Coupe 7) 05.95 + Europa 2)	24.3727-1922.2 24.3727-1923.2	581922 581923	<input type="checkbox"/> <input type="checkbox"/>		L=1448 L=1457
	1.3 (EE100) 1.3 16V (EE101) 1.6 (AE101) 1.6 GT APEX (AE101) 1.8 (AE102) 2.0 D (CE100)			05.92 05.92 05.92 05.92 08.91 05.92	05.93 05.93 05.93 05.93 + Europa / + Coupe 8) 05.95 - Europa 4) 05.93	24.3727-1907.2 24.3727-1908.2	581907 581908	<input type="checkbox"/> <input type="checkbox"/>		L=1585 L=1603
TOYOTA CORONA (82-87)										
	1.6 (AT151) 1.8 (ST150) 2.0 (ST151) 2.0 D (CT150)			10.83 10.83 10.83 10.83	11.87 11.87 11.87 11.87	13.0460-5976.2 13.0460-0325.2	605976 610325			20870 15,0 Belagsatz-Zubehör AKE AKE
	1.6 (AT151) 1.8 (ST150) 2.0 (ST151) 2.0 D (CT150)			10.83 10.83 10.83 10.83	11.87 11.87 11.87 11.87	03.0137-0313.2 03.0137-9114.2	650313 669114			200 x 37 Bremsbacken-Zubehör
TOYOTA CROWN (74-79)										
	2.0 (RS80) 2.6 (MS83) 2.6 (MS85) 2.6 (MS88) 2.6 (MS95)			10.74 10.74 10.74 10.74 10.74	08.79 08.79 08.79 08.79 08.79	03.0137-9203.2	669203			Bremsbacken-Zubehör
										- Royal Saloon Typ 9)
TOYOTA CROWN (79-83)										
	2.0 (RS110) 2.2 D (LS110) 2.6 (MS111) 2.8 (MS112)			09.79 09.79 09.79 09.79	07.83 07.83 07.83 07.83	03.0137-9203.2	669203			Bremsbacken-Zubehör
TOYOTA CROWN (83-87)										
	2.0 (YS120) 2.4 D (LS120) 2.8 (MS122)			08.83 08.83 08.83	09.87 09.87 09.87	03.0137-9203.2	669203			Bremsbacken-Zubehör
TOYOTA HIACE (77-82)										
	1.6 (RH11) 1.6 (RH20/30) 2.0 (RH22/25/32/42) 2.2 D (LH11/20/30)			02.77 02.77 02.77 02.77	11.82 + Scheibenbremse 10) 11.82 + Scheibenbremse 10) 11.82 + Scheibenbremse 10) 11.82 + Scheibenbremse 10)	03.0137-0226.2	650226			254 x 58

1) + Coupe / + Coupé / + Coupé / + Coupé

2) + Europe / + Europa / + Europe / + Europa

3) + Europe / - GUS States / + Europa / - Stati del GUS / + Europe / - Etats de la CEI / + Europa / - estados del GUS

4) - Europe / - Europa / - Europe / - Europa

5) - Europe / + Estate / - Europa / + Station Wagon / - Europe / + Break / - Europa / + Break











6) - Europe / + GUS-Staaten / - Europa / + Stati del GUS / - Europe / + Etats de la CEI / - Europa / + estados del GUS

7) - Europe / + Coupe / - Europa / + Coupé / - Europe / + Coupé / - Europa / + Coupé





















8) + Europe / + Coupe / + Europa / + Coupé / + Europe / + Coupé / + Europa / + Coupé

9) - type Royal Saloon / - tipo Royal berlina / - type Royal Saloon / - tipo Royal Saloon



























10) + disc brake / + disco freno / + disques de frein / + disco de freno

TOYOTA HIACE (Pickup) (83-85)										
	1.6 (RH11) 2.2 D (LH11)			12.82 12.82	07.85 07.85		03.0137-0226.2	650226		254 x 58
TOYOTA HIACE (Bus) (83-87)										
	1.8 (YH50/60) 2.0 (YH51/61) 2.0 (YH71) 2.2 (YH53) 2.2 (YH63) 2.2 (YH73) 2.2 D (LH50/60) 2.2 D (LH70) 2.4 D (LH51/61) 2.4 D (LH71)			12.82 12.82 12.82 12.82 12.82 12.82 12.82 12.82 12.82 12.82	08.87 08.87 08.87 08.87 08.87 08.87 08.87 08.87 08.87 08.87		13.0460-5938.2	605938		21158 15,5 AKE
	1.8 (YH50/60) 2.0 (YH51/61) 2.0 (YH71) 2.2 (YH53) 2.2 (YH63) 2.2 (YH73) 2.2 D (LH50/60) 2.2 D (LH70) 2.4 D (LH51/61) 2.4 D (LH71)			12.82 12.82 12.82 12.82 12.82 12.82 12.82 12.82 12.82 12.82	08.87 08.87 08.87 08.87 08.87 08.87 08.87 08.87 08.87 08.87		24.0125-0118.1	425118		257 25,0 23,0 V
	1.8 (YH50/60) 2.0 (YH51/61) 2.0 (YH71) 2.2 (YH53) 2.2 (YH63) 2.2 (YH73) 2.2 D (LH50/60) 2.2 D (LH70) 2.4 D (LH51/61) 2.4 D (LH71)			12.82 12.82 12.82 12.82 12.82 12.82 12.82 12.82 12.82 12.82	08.87 08.87 08.87 08.87 08.87 08.87 08.87 08.87 08.87 08.87		03.0137-0226.2	650226		254 x 58
	2.2 4WD (YH56) 2.2 4WD (YH66) 2.4 D 4WD (LH56/66)			08.86 08.86 08.86	08.87 08.87 08.87		03.0137-0308.2	650308		295 x 51
TOYOTA HIACE (87-89)										
	2.0 (YH51) 2.0 (YH61) 2.4 D (LH51) 2.4 D (LH61)			09.87 09.87 09.87 09.87	11.89 11.89 11.89 11.89		13.0460-5938.2	605938		21158 15,5 AKE
	2.0 (YH51) 2.0 (YH61) 2.4 D (LH51) 2.4 D (LH61)			09.87 09.87 09.87 09.87	11.89 11.89 11.89 11.89		24.0125-0118.1	425118		257 25,0 23,0 V
	2.0 (YH51) 2.0 (YH61) 2.4 D (LH51) 2.4 D (LH61)			09.87 09.87 09.87 09.87	08.88 08.88 08.88 08.88	- (DK) - (S) - (DK) - (DK)	03.0137-0226.2	650226		254 x 58
	2.0 (YH51) 2.0 (YH51) 2.0 (YH61) 2.0 (YH61) 2.4 D (LH51) 2.4 D (LH51) 2.4 D (LH61) 2.4 D (LH61)			09.87 09.88 09.87 09.88 09.87 09.88 09.87 09.88	02.88 11.89 02.88 11.89 02.88 11.89 02.88 11.89	+ (DK) + (S) + (DK) + (DK)	03.0137-0193.2 03.0137-9115.2	650193 669115		254 x 52 Bremsbacken-Zubehör
	2.2 4WD (YH56) 2.2 4WD (YH66) 2.4 D 4WD (LH56/66)			09.87 09.87 09.87	11.89 11.89 11.89		03.0137-0308.2	650308		295 x 51
TOYOTA HIACE (89-95)										
	2.0 (RZH 102) 2.4 (RZH 103) 2.4 D 2.4 4WD	74 88		02.90 08.89 08.89 08.89	08.95 08.95 08.95 08.95		13.0460-5892.2	605892		21689 15,5
				08.89	08.95		13.0460-5722.2	605722		21468 15,5
TOYOTA HILUX (78-83)										
	2.0 4WD (RN36) 2.0 4WD (RN46) 2.2 D 4WD (LN36) 2.2 D 4WD (LN46)			08.78 08.78 08.78 08.78	07.83 07.83 07.83 07.83		13.0460-5935.2 13.0460-0327.2	605935 610327		20852 15,5 Belagsatz-Zubehör
	2.0 4WD (RN36) 2.0 4WD (RN46) 2.2 D 4WD (LN36) 2.2 D 4WD (LN46)			08.78 08.78 08.78 08.78	07.83 07.83 07.83 07.83		24.0113-0105.1	413105		302 12,5 11,5
	1.6 (RN30) 1.6 (RN40) 2.0 (RN31) 2.0 (RN41) 2.0 4WD (RN36) 2.0 4WD (RN46) 2.2 D (LN30)			08.78 08.78 08.78 08.78 08.78 08.78 08.78	07.83 07.83 07.83 07.83 07.83 07.83 07.83	+ Scheibenbremse ¹⁾ + Scheibenbremse ¹⁾ + Scheibenbremse ¹⁾ + Scheibenbremse ¹⁾	03.0137-0226.2	650226		254 x 58
				08.78	07.83	+ Scheibenbremse ¹⁾				

¹⁾ + disc brake / + disco freno / + disques de frein / + disco de freno

								
TOYOTA HILUX (78-83)								
	2.2 D (LN40) 2.2 D 4WD (LN36) 2.2 D 4WD (LN46)		08.78 08.78 08.78	07.83 07.83 07.83	+ Scheibenbremse ¹⁾	03.0137-0226.2	650226	254 x 58
TOYOTA HILUX (83-88)								
	1.6 (YN50) 1.6 (YN55) 2.0 (YN52/57/58) 2.2 D (LN50) 2.2 D (LN55) 2.4 (RN50) 2.4 D (LN51) 2.4 D (LN56)		08.83 08.83 08.83 08.83 08.83 08.83 08.83 08.83	07.88 07.88 07.88 07.88 07.88 07.88 07.88 07.88		13.0460-5938.2	605938	21158 15,5 AKE
	2.0 4WD (YN60) 2.0 4WD (YN62) 2.0 4WD (YN65) 2.0 4WD (YN67) 2.4 D 4WD (LN60) 2.4 D 4WD (LN65)		08.83 08.83 08.83 08.83 08.83 08.83	07.88 07.88 07.88 07.88 07.88 07.88		13.0460-5935.2	605935	20852 15,5 SUM
	2.0 4WD (YN60) 2.0 4WD (YN62) 2.0 4WD (YN65) 2.0 4WD (YN67) 2.4 D 4WD (LN60) 2.4 D 4WD (LN65)		08.83 08.83 08.83 08.83 08.83 08.83	07.88 07.88 07.88 07.88 07.88 07.88		24.0113-0105.1	413105	302 12,5 11,5
	1.6 (YN50) 1.6 (YN55) 2.0 (YN52/57/58) 2.0 4WD (YN60) 2.0 4WD (YN62) 2.0 4WD (YN65) 2.0 4WD (YN67) 2.2 D (LN50) 2.2 D (LN55) 2.4 (RN50) 2.4 D (LN51) 2.4 D (LN56) 2.4 D 4WD (LN60) 2.4 D 4WD (LN65)		08.83 08.83 08.83 08.83 08.83 08.83 08.83 08.83 08.83 08.83 08.83 08.83 08.83 08.83	07.88 07.88 07.88 07.88 07.88 07.88 07.88 07.88 07.88 07.88 07.88 07.88 07.88 07.88	+ Scheibenbremse ¹⁾ + Scheibenbremse ¹⁾ + Scheibenbremse ¹⁾ + Scheibenbremse ¹⁾ + Scheibenbremse ¹⁾ + Scheibenbremse ¹⁾ + Scheibenbremse ¹⁾	03.0137-0226.2	650226	254 x 58
TOYOTA HILUX (88-97)								
	1.8 (YN85/90) 2.4 D (LN85/90) 2.4 D 4WD (LN85/90)		08.88 08.88 01.94	07.97 07.97 07.97		13.0460-5938.2	605938	21158 15,5 AKE
	2.4 D 4WD (LN105/110) 2.4 i 4WD (RN106/110)		08.88 08.88	07.97 07.97		13.0460-5992.2	605992	21679 15,0 +/WK
	1.8 (YN85/90) 2.4 D (LN85/90) 2.4 D 4WD (LN85/90)		08.88 08.88 01.94	07.97 07.97 07.97		24.0125-0118.1	425118	257 25,0 23,0 V
	2.4 D 4WD (LN105/110) 2.4 i 4WD (RN106/110)		08.88 08.88	07.97 07.97		24.0120-0168.1	420168	289 20,0 18,0 V
	1.8 (YN85/90) 2.4 D (LN85/90) 2.4 D 4WD (LN105/110) 2.4 D 4WD (LN85/90) 2.4 i 4WD (RN106/110)		08.88 08.88 08.88 01.94 08.88	07.97 07.97 07.97 07.97 07.97		24.3222-1740.3	020566	Rz 22,20
	1.8 (YN85/90) 2.4 D (LN85/90)		08.88 08.88	07.97 07.97		03.0137-0226.2	650226	254 x 58
	2.4 D (LN85/90) 2.4 D 4WD (LN105/110) 2.4 D 4WD (LN85/90) 2.4 i 4WD (RN106/110)		08.88 08.88 01.94 08.88	07.97 07.97 07.97 07.97		03.0137-0308.2	650308	295 x 51
	2.4 D 4WD (LN85/90) 2.4 i 4WD (RN106/110)		01.94 08.88	07.97 07.97		24.0229-5004.1	480312	295/297 x 67
TOYOTA LAND CRUISER 40-47 (80-86)								
	3.0 D (BJ40/43) 3.4 D (BJ42/46) 3.4 D (BJ45)		08.80 08.80 08.80	04.86 04.86 04.86		13.0460-5935.2	605935	20852 15,5 SUM
	4.0 D (HJ47) 4.3 (FJ40/43) 4.3 (FJ45)		08.80 08.80 08.80	04.86 04.86 04.86		13.0460-0327.2	610327	Belagsatz-Zubehör SUM
	3.0 D (BJ40/43) 3.4 D (BJ42/46) 3.4 D (BJ45) 4.0 D (HJ47) 4.3 (FJ40/43) 4.3 (FJ45)		08.80 08.80 08.80 08.80 08.80 08.80	04.86 04.86 04.86 04.86 04.86 04.86		24.0120-0153.1	420153	302 20,0 19,0 V

































¹⁾ + disc brake / + disco freno / + disques de frein / + disco de freno

        												
TOYOTA LAND CRUISER 40-55 (69-80)												
	3.0 D (BJ40/43)			09.79	07.80	13.0460-5935.2	605935			20852 15,5	SUM	
	3.9 (FJ40/42/43/55)			09.79	07.80	13.0460-0327.2	610327			Belagsatz-Zubehör	SUM	
	4.3 (FJ40/43/55)			09.79	07.80							
	3.0 D (BJ40/43)			09.79	07.80	24.0120-0153.1	420153			302 20,0 19,0 V		
	3.9 (FJ40/42/43/55)			09.79	07.80							
	4.3 (FJ40/43/55)			09.79	07.80							
TOYOTA LAND CRUISER 70-75 (84-89)												
	2.4 (RJ70)			11.84	12.89	13.0460-5935.2	605935			20852 15,5	SUM	
	2.4 D (LJ70)			11.84	12.89							
	2.4 TD (LJ70)			11.84	12.89							
	3.4 D (BJ70/75)			11.84	12.89	13.0460-5935.2	605935			20852 15,5	SUM	
	3.4 TD (BJ71)			10.85	12.89	13.0460-0327.2	610327			Belagsatz-Zubehör	SUM	
	2.4 (RJ70)			11.84	12.89	24.0113-0105.1	413105			302 12,5 11,5		
	2.4 D (LJ70)			11.84	12.89							
	2.4 TD (LJ70)			11.84	12.89							
	3.4 D (BJ70/75)			11.84	12.89	24.0120-0153.1	420153			302 20,0 19,0 V		
	3.4 TD (BJ71)			10.85	12.89							
	2.4 (RJ70)			11.84	12.89	03.0137-0193.2	650193			254 x 52		
	2.4 D (LJ70)			11.84	12.89	03.0137-9115.2	669115			Bremsbacken-Zubehör		
	2.4 TD (LJ70)			11.84	12.89							
	TOYOTA LAND CRUISER 70-75 (90-96)											
		2.4 (RJ70/73)			01.90	12.96 + HA-Scheibenbremse ¹⁾	13.0460-5992.2	605992			21679 15,0 +WK	
		2.4 TD (LJ70/73)			01.90	05.96 + HA-Scheibenbremse ¹⁾						
3.0 TD (KZJ70/73/77)				05.93	05.96							
3.4 D (BJ73)				01.90	12.96							
3.5 D (PZJ70)				01.90	12.96							
4.2 TD (HZJ70/73)				01.90	12.96							
	2.4 (RJ70/73)			01.90	12.96 + HA-Scheibenbremse ¹⁾	24.0120-0153.1	420153			302 20,0 19,0 V		
	2.4 TD (LJ70/73)			01.90	05.96 + HA-Scheibenbremse ¹⁾							
	3.0 TD (KZJ70/73/77)			05.93	05.96							
	3.4 D (BJ73)			01.90	12.96							
	3.5 D (PZJ70)			01.90	12.96							
	4.2 TD (HZJ70/73)			01.90	12.96							
	2.4 (RJ70/73)			01.90	12.96 + HA-Trommelbremse ²⁾	24.0113-0105.1	413105			302 12,5 11,5		
	2.4 TD (LJ70/73)			01.90	05.96 + HA-Trommelbremse ²⁾							
	2.4 (RJ70/73)			01.90	12.96	13.0460-5744.2	605744			21947 15,4		
	2.4 TD (LJ70/73)			01.90	05.96							
	4.2 TD (HZJ70/73)			01.90	12.96							
	2.4 (RJ70/73)			01.90	04.93	03.0137-0193.2	650193			254 x 52		
	2.4 TD (LJ70/73)			01.90	04.93	03.0137-9115.2	669115			Bremsbacken-Zubehör		
	2.4 (RJ70/73)			05.93	12.96	03.0137-0308.2	650308			295 x 51		
	2.4 TD (LJ70/73)			05.93	05.96							
	TOYOTA LAND CRUISER STATION WAGON 60-62 (80-89)											
	3.4 D (BJ60)			08.80	08.87	13.0460-5935.2	605935			20852 15,5	SUM	
	4.0 D (HJ60)			08.80	12.89	13.0460-0327.2	610327			Belagsatz-Zubehör	SUM	
	4.0 TD (HJ61)			10.85	12.89							
	4.2 (FJ60)			08.80	08.87							
	4.2 (FJ62)			08.80	12.89							
	3.4 D (BJ60)			08.80	08.87	24.0120-0153.1	420153			302 20,0 19,0 V		
	4.0 D (HJ60)			08.80	12.89							
	4.0 TD (HJ61)			10.85	12.89							
	4.2 (FJ60)			08.80	08.87							
	4.2 (FJ62)			08.80	12.89							
TOYOTA LAND CRUISER STATION WAGON 80 (90-97)												
	4.0 i (FJ80)			01.90	08.92	13.0460-5745.2	605745			21775 15,0 +WK	SUM	
	4.2 D (HZJ80)			01.90	12.97							
	4.2 TD (HDJ80)			01.90	12.97							
	4.5 i 24V (FZJ80)			08.92	12.97							
	4.5 i 24V (FZJ80)			08.92	12.97	24.0132-0111.1	432111			311 32,0 30,0 V		
	4.0 i (FJ80)			01.90	08.92	13.0460-5744.2	605744			21947 15,4		
	4.2 D (HZJ80)			01.90	12.97							
	4.2 TD (HDJ80)			01.90	12.97							
	4.5 i 24V (FZJ80)			08.92	12.97							
	TOYOTA MODEL-F (82-88)											
		1.8 (YR20)			11.82	08.84 + ^{AUS} / + Europa ³⁾	03.0137-9203.2	669203			Bremsbacken-Zubehör	
		2.0 (YR21)			11.82	07.88 + ^{AUS} / + Europa ³⁾						
		2.0 (YR22)			11.82	07.88 + ^{AUS} / + Europa ³⁾						
2.0 4WD (YR31)				01.86	07.88 + ^{AUS} / + Europa ³⁾							
2.0 D (CR21)				11.82	07.88 + ^{AUS} / + Europa ³⁾							
TOYOTA MODEL-F (88-90)												
	2.0 (YR21/22)			08.88	01.90	03.0137-9203.2	669203			Bremsbacken-Zubehör		
	2.0 4WD (YR31)			08.88	01.90							

¹⁾ + RA disc brake / + P disco freno / + frein à disque essieu AR / + ET-disco de freno

²⁾ + RA drum brake / + P freno a tamburo / + frein à tambour essieu AR / + ET-tambores de freno

³⁾ + ^{AUS} / + Europe / + ^{AUS} / + Europa / + ^{AUS} / + Europe / + ^{AUS} / + Europa

								
TOYOTA MR2 (84-89)								
	1.6 i 16V (AW11)		11.84	12.89	13.0460-5976.2 13.0460-0325.2	605976 610325		20870 15,0 Belagsatz-Zubehör AKE AKE
TOYOTA PASEO (91-95)								
	1.5 i 16V (EL44)	85	04.91	07.95	13.0460-5976.2 13.0460-0325.2	605976 610325		20870 15,0 Belagsatz-Zubehör AKE AKE
	1.5 i 16V (EL44)	85	04.91	07.95	03.0137-0257.2 03.0137-9114.2	650257 669114		180 x 28 Bremsbacken-Zubehör
TOYOTA STARLET (84-89)								
	1.0 (EP70) 1.3 (EP71) 1.5 D (NP70)	40 55 40	10.84 10.84 12.86	12.89 12.89 12.89	03.0137-9080.2	669080		Bremsbacken-Zubehör
TOYOTA STARLET (89-96)								
	1.0 (EP80) 1.3 (EP81) 1.5 D (NP80)	40 55 40	12.89 12.89 12.89	03.96 - ABS 03.96 - ABS 03.96	13.0460-5969.2	605969		21948 13,5 + SUM
	1.0 (EP80) 1.3 (EP81)	40 55	12.89 12.89	11.90 + ABS 11.90 + ABS	13.0460-5976.2 13.0460-0325.2	605976 610325		20870 15,0 Belagsatz-Zubehör AKE AKE
	1.0 (EP80) 1.3 (EP81) 1.5 D (NP80)	40 55 40	01.92 01.92 12.89	03.96 + ABS 03.96 + ABS 03.96	24.0118-0124.1 03.0137-9080.2	418124 650257 669080		238 18,0 17,0 V +B 180 x 28 Bremsbacken-Zubehör
TOYOTA SUPRA (86-93)								
	3.0 i 24V (MA70) 3.0 i Turbo (MA70)	150	01.86 08.87	04.93 04.93	24.0118-0119.1	418119		291 18,0 17,0 V
TOYOTA TERCEL (82-88)								
	1.3 (AL20) 1.5 (AL21) 1.5 4WD (AL25)	48 52	05.82 05.82 08.82	08.84 08.84 01.88	13.0460-5976.2 13.0460-0325.2	605976 610325		20870 15,0 Belagsatz-Zubehör AKE AKE
	1.3 (AL20) 1.5 (AL21)	48 52	05.82 05.82	08.84 08.84	03.0137-9080.2	669080		Bremsbacken-Zubehör
TRABANT 1,1 (90-91)								
	1.1		05.90	05.91	03.0137-0228.2	650228		200 x 30
TRABANT 601 (65-90)								
	alle Typen		01.65	04.90	24.2722-1202.3 24.2722-1201.3	020144 020143	2  2 	Rz 22,20 Rz 22,20
	alle Typen		01.65	04.90	03.0137-0227.2	650227		200 x 30
	alle Typen		01.65	04.90	24.5110-0155.3	330040	2	L=155
	alle Typen		01.65	04.90	24.3215-1201.3	020160		Rz 15,87
	alle Typen		01.65	04.90	03.0137-0228.2	650228		200 x 30
VOLKSWAGEN 411/412 (Typ 4) (68-75)								
	1.7 1.8		07.68 07.73	12.73 03.75	03.3222-5011.3	020462		Rz 22,20
VOLKSWAGEN 1500/1600 (TYP 3) (61-75)								
	1500 A Limousine 1500 Limousine 1500 Variant	221975 221975	12.65 12.73 07.64		03.3526-2002.3	340010	1	Bremslichtschalter
	1500 A Limousine 1500 Variant 1600		08.65 01.66 08.65	07.67 12.67 07.67	03.3119-6457.3 03.3526-2002.3	010269 340010	1	HZ 19,05 Bremslichtschalter ATE
	1600		08.67	12.73	03.2119-6713.3 24.3526-1900.0	010061 340038	2	THz 19,05 Bremslichtschalter ATE
	1500 1500 1600	3112268739	01.66 12.67 08.65		13.0441-4205.2 13.0441-4205.2	250086 250086		Dichtungssatz Dichtungssatz ATE ATE



VOLKSWAGEN 1500/1600 (TYP 3) (61-75)

	1500			01.66	12.67	13.0460-3010.2	603010		20009	15,0	ATE
	1600			08.65	07.71	13.0460-0014.2	610014				ATE
	1600			08.71	12.73	13.0460-4033.2	604033		20034	15,0	ATE
	1500			01.66	12.67	13.0460-0029.2	610029				ATE
	1600			08.65	07.71	24.0110-0142.1	410142			278 9,5 8,0	
	1500 Limousine			01.61	12.73	24.5171-0393.3	331311	2		L=393	
	1500 Variant			01.61	12.65						
	1500 A			01.66	12.67	24.5165-0350.3	331257	2		L=350	
	1500 Variant			01.66	12.67						
	1600 Limousine			08.65	07.68						
	1600 Variant			08.65	07.67						
	1600 Limousine			08.68	12.73	83.6101-0325.3	330206	2		L=325	
	1600 Variant			08.67	12.73						
	1500			01.61	12.73	24.5224-0240.3	331260	2		L=240	
	1600 Limousine			08.65	07.68						
	1600 Variant			08.65	07.67						
	1600 Limousine			08.68	12.73	83.6101-0250.3	330203	2		L=250	
	1600 Variant			08.67	07.71						
	1600 Variant			08.71	12.73	24.5224-0240.3	331260	2		L=240	
	1500 Variant			08.64	12.65	03.3223-0611.3	020091			Rz 23,81	
	1500 Limousine	221975			12.73	03.3222-5011.3	020462			Rz 22,20	
	1500 Variant			01.66	12.67						
	1600			08.65	12.73						

VOLKSWAGEN CADDY I (83-92)

	1.5			08.82	07.83	03.2120-1531.3	010092	1		THz 20,64	ATE
	1.6		14-M-010000	08.83		03.3526-2002.3	340010			Bremslichtschalter	
	1.6 D		14-M-010000	08.82							
	1.8		14-M-010000	08.85							
	1.5			08.82	07.83	03.2120-1491.3	010089	2		THz 20,64 + WE	ATE
	1.6		14-M-010000	08.83		03.3526-2002.3	340010			Bremslichtschalter	
	1.6 D		14-M-010000	08.82							
	1.8		14-M-010000	08.85							
	1.6	◀	14-N-000001		07.92	03.2120-3943.3	010532			THz 20,64	ATE
	1.6 D	◀	14-N-000001		07.92						
	1.8	◀	14-N-000001		07.92						
	1.6	▶	14-N-000001		07.92	03.2120-1531.3	010092	1		THz 20,64	ATE
	1.6 D	▶	14-N-000001		07.92	03.3526-2002.3	340010			Bremslichtschalter	
	1.8	▶	14-N-000001		07.92						
	1.5		14-D-010000	08.82		11.0441-4808.2	250022		f.Vornr -8007/8008 -8503/8504 ¹⁾	Dichtungssatz	ATE
	1.6		14-D-010000	08.83		11.0441-4804.2	250019			Dichts. (+Sich. Ring)	ATE
	1.6 D		14-D-010000	08.82		11.0101-4801.2	260006			Hülensatz	ATE
						24.0102-4801.2	260085			Hülensatz+Schrauben	ATE
	1.6		14-E-010001		07.92	11.0441-4808.2	250022			Dichtungssatz	ATE
	1.6 D		14-E-010001		07.92	11.0101-4801.2	260006			Hülensatz	ATE
	1.8			08.85	07.92	24.0102-4801.2	260085			Hülensatz+Schrauben	ATE
	1.5			08.82	07.83	13.0460-7032.2	607032			20887 19,7 +/Zub	VW
	1.6			08.83	07.92						
	1.6 D			08.82	07.92						
	1.8			08.85	07.92						
	1.5			08.82	07.83	24.0112-0106.1	412106			239 12,0 10,0 +S +B	
	1.6			08.83	07.92	24.0312-0106.1	512106			239 12,0 10,0 +S +B PD	
	1.6 D			08.82	07.92						
	1.8			08.85	07.92						
	1.5			08.82	07.83	24.5170-0315.3	331309	2		L=315	
	1.6			08.83	07.92						
	1.6 D			08.82	07.92						
	1.8			08.85	07.92						
	1.5			08.82	07.83	83.6299-0807.3	330901	2		L=430/430	
	1.6			08.83	07.92						
	1.6 D			08.82	07.92						
	1.8			08.85	07.92						
	1.5			08.82	07.83	03.3217-2112.3	020027		+ GG ²⁾	Rz 17,46	
	1.6		14-H-011048	08.83		24.3217-0908.3	020167		+ ALU ³⁾	Rz 17,46	
	1.6 D		14-H-011048	08.82							
	1.8		14-H-011048	08.85							
	1.6		14-H-011049		07.92	24.3219-0909.3	020188			Rz 19,05	
	1.6 D		14-H-011049		07.92						
	1.8		14-H-011049		07.92						
	1.5			08.82	07.83	03.0137-0264.2	650264			230 x 40 HEB	VW
	1.6		14-M-006000	08.83		03.0137-9044.2	669044			Bremsbacken-Zubehör	VW
	1.6 D		14-M-006000	08.82							
	1.8		14-M-006000	08.85							
	1.6		14-M-006001		07.92	03.0137-0264.2	650264			230 x 40 HEB	VW
	1.6 D		14-M-006001		07.92	03.0137-9164.2	669164			Bremsbacken-Zubehör	
	1.8		14-M-006001		07.92						
	1.5			08.82	07.83	03.0420-1217.3	681217			17,46/230x40 Kit	VW
	1.6		14-H-011048	08.83							
	1.6 D		14-H-011048	08.82							
	1.8		14-H-011048	08.85							

¹⁾ f.partno.-8007/8008 -8503/8504 / p.no.codice -8007/8008 -8503/8504 / p.AV ref. -8007/8008 -8503/8504 / p.antes ref. -8007/8008 -8503/8504

²⁾ + cast iron / + ghisa / + fonte grise / + fundición de gris

³⁾ + aluminium / + alluminio / + aluminium / + aluminio



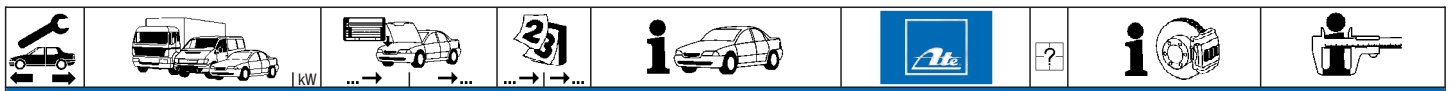

VOLKSWAGEN CADDY I (83-92)

	1.5 1.6 1.6 D 1.8			08.82 08.83 08.82 08.85	07.92 07.92 07.92 07.92		24.3727-0150.2	580150	2		L=2020
	1.5 1.6 1.6 D 1.8			08.82 08.83 08.82 08.85	07.92 07.92 07.92 07.92		24.3728-0108.2	590108			L=794

VOLKSWAGEN CORRADO (88-95)

	1.8 16V 1.8 G60 2.0 2.0 16V 2.9 VR6			04.89 10.88 04.93 08.91 08.91	07.92 09.93 07.95 07.95 07.95	- ABS - ABS - ABS - ABS - ABS	03.7750-4302.4	300076			9"	ATE
	1.8 16V 1.8 G60 2.0 2.0 16V 2.9 VR6			04.89 10.88 04.93 08.91 08.91	07.92 09.93 07.95 07.95 07.95	- ABS - ABS - ABS - ABS - ABS	03.7750-4902.4	300079			9"	ATE
	1.8 16V 1.8 G60 2.0 2.0 16V 2.9 VR6			04.89 10.88 04.93 08.91 08.91	07.92 09.93 07.95 07.95 07.95	- ABS - ABS - ABS - ABS - ABS	03.2122-1042.3 03.3517-0101.2	010137 390322			THz 22,20 Verschlußschraube	ATE
	1.8 16V 2.0 2.0 16V			04.89 04.93 08.91	07.92 07.95 07.95		24.3541-1609.5 24.3541-1610.5 24.0101-4301.2 11.0101-5403.2	240039 240040 260047 260010	<input type="checkbox"/> <input type="checkbox"/>		D=54, - Halter D=54, - Halter Bremsattel-Zubehör Fallenbalgsatz	TRW TRW TRW TRW
	1.8 G60		50-M-027000	10.88			24.3541-1719.5 24.3541-1720.5 24.0101-4301.2 11.0101-5403.2	240057 240058 260047 260010	<input type="checkbox"/> <input type="checkbox"/>		D=54, - Halter D=54, - Halter Bremsattel-Zubehör Fallenbalgsatz	TRW TRW TRW TRW
	1.8 G60 2.9 VR6		50-M-027001		09.93 07.95		24.3541-1731.5 24.3541-1732.5	240061 240062	<input type="checkbox"/> <input type="checkbox"/>		D=54, - Halter D=54, - Halter	TRW TRW
	1.8 16V 2.0 2.0 16V			04.89 04.93 08.91	07.92 07.95 07.95		13.0460-2957.2	602957			20168 16,0 /S	TRW
	1.8 G60 2.9 VR6			10.88 08.91	09.93 07.95		13.0460-2958.2	602958			20168 19,3 /S	TRW
	1.8 16V 2.0 2.0 16V			04.89 04.93 08.91	07.92 07.95 07.95		24.0120-0128.1 24.0320-0128.1	420128 520128			256 20,0 18,0 V L +S +B 256 20,0 18,0 V L +S +B PD	
	1.8 G60 2.9 VR6			10.88 08.91	09.93 07.95		24.0122-0101.1 24.0122-0100.1 24.0322-0100.1	422101 422100 522100			280 22,0 20,0 V L +B 280 22,0 20,0 V L +B 280 22,0 20,0 V L +B PD	
	1.8 16V 1.8 G60		50-M-035000	04.89 10.88			24.5237-0333.3	331425	2		L=333	
	1.8 16V 1.8 G60		50-N-000001 50-N-000001		07.92 09.93		24.5105-0442.3	331432	2		L=442	
	1.8 16V 1.8 G60		50-L-035000 50-L-035000	04.89 10.88			24.0711-1313.3	360016	2	<input type="checkbox"/>	Radsensor L=1130	
	1.8 16V 1.8 G60		50-M-000001 50-M-000001				24.0711-1313.3	360016	2	<input type="checkbox"/>	Radsensor L=1130	
	1.8 16V 1.8 G60 2.0 2.0 16V 2.9 VR6		50-N-000001 50-N-000001		07.92 09.93		24.0711-1361.3 24.0711-1362.3	360022 360023	<input type="checkbox"/> <input type="checkbox"/>		Radsensor Radsensor	
	2.0 2.0 16V 2.9 VR6		50-R-003691 50-R-003691 50-R-003691		07.95 07.95 07.95		24.0711-1361.3 24.0711-1362.3	360022 360023	<input type="checkbox"/> <input type="checkbox"/>		Radsensor Radsensor	
	1.8 16V 1.8 G60 2.0 16V 2.9 VR6			04.89 10.88 08.91 08.91	07.92 07.92 08.91 08.91		24.3384-1603.5 24.3384-1604.5 24.0101-3601.2 11.0101-5403.2	240015 240016 260044 260010	<input type="checkbox"/> <input type="checkbox"/>		D=38, - Halter D=38, - Halter Bremsattel-Zubehör Fallenbalgsatz	TRW TRW TRW TRW
	1.8 G60 2.0 2.0 16V 2.9 VR6		50-P-009001 50-P-009001 50-P-009001		09.93 07.95 07.95 07.95		24.3384-1707.5 24.3384-1708.5 24.0101-3601.2 11.0101-5403.2	240171 240172 260044 260010	<input type="checkbox"/> <input type="checkbox"/>		D=38, - Halter D=38, - Halter Bremsattel-Zubehör Fallenbalgsatz	TRW TRW TRW TRW
	1.8 16V 1.8 G60 2.0 2.0 16V 2.9 VR6			04.89 10.88 04.93 08.91 08.91	07.92 07.92 07.95 07.95 08.91		13.0460-2937.2 13.0460-0419.2	602937 610419			20961 15,2 /Zub/S Belagsatz-Zubehör	TRW TRW
	1.8 G60 2.9 VR6		50-P-009001 50-P-009001		09.93 07.95		13.0460-2984.2 13.0460-0072.2	602984 610072			20961 17,2 /Zub/S Belagsatz-Zubehör	TRW TRW



VOLKSWAGEN CORRADO (88-95)

	1.8 16V			04.89	07.92	24.0110-0111.1	410111	ohne Sensorring ¹⁾ mit Sensorring ²⁾	226 10,0 8,0 +B 226 10,0 8,0 +B		
	1.8 G60			10.88	09.93	24.0110-0275.2	410275				
	2.0			04.93	07.95						
	2.0 16V			08.91	07.95						
	2.9 VR6			08.91	07.95						
	1.8 16V			04.89	07.92	24.5201-0164.3	331414	2 am Bremsattel ³⁾	L=164 L=161		
	1.8 G60			10.88	09.93	24.5170-0161.3	331308				
	2.0			04.93	07.95						
	2.0 16V			08.91	07.95						
	2.9 VR6			08.91	07.95						
	1.8 16V		50-M-000001		07.92	24.0721-1925.1	360039	2 am Bremsattel ³⁾	Radsensor L=1220		
	1.8 G60		50-M-000001		09.93						
	2.0			50-R-003690	04.93						
	2.0 16V			50-R-003690	08.91						
	2.9 VR6			50-R-003690	08.91						
	2.0		50-R-003691		07.95	24.0721-1937.1	360040	2 am Bremsattel ³⁾	Radsensor L=1062		
	2.0 16V		50-R-003691		07.95						
	2.9 VR6		50-R-003691		07.95						
	1.8 16V			50-S-000361	04.89	24.3727-0134.2	580134			2 am Bremsattel ³⁾	L=1613
	1.8 G60			10.88	09.93						
2.0			50-S-000361	04.93							
2.0 16V			50-S-000361	08.91							
2.9 VR6			50-S-000361	08.91							
	2.0		50-S-000362		07.95	24.3727-0156.2	580156	2 am Bremsattel ³⁾	L=1616		
	2.0 16V		50-S-000362		07.95						
	2.9 VR6		50-S-000362		07.95						
	1.8 16V			04.89	07.92	03.6584-0015.3	320109			BRL 8/4 (4)	ATE
	1.8 G60			10.88	09.93						
2.0			04.93	07.95							
2.0 16V			08.91	07.95							
2.9 VR6			08.91	07.95	03.6584-0113.3	320111	BRL 8/4 (4)	ATE			
	1.8 16V	◀		04.89	07.92	03.2419-9310.3	030027	Gz 19,05			
	1.8 G60	◀		10.88	09.93						
	2.0	◀		50-R-000786	04.93						
	2.0 16V	◀		50-R-000786	08.91						
	2.9 VR6	◀		50-R-000786	08.91						
	2.0	◀	50-R-000787		07.95	03.2419-1206.3	030074	Gz 19,05			
	2.0 16V	◀	50-R-000787		07.95						
	2.9 VR6	◀	50-R-000787		07.95						
	1.8 16V			04.89	07.92	24.2523-0908.3	040049			Nz 23,81	
	1.8 G60			10.88	09.93						
2.0			04.93	07.95							
2.0 16V			08.91	07.95							
2.9 VR6			08.91	07.95							

VOLKSWAGEN DERBY/POLO Stufenheck (77-88)

	0.9			01.77	09.81	03.2117-3311.3	010040	1	THz 17,46 Bremslichtschalter Verschlusschraube	ATE				
	1.0			10.81	02.85	03.3526-2002.3	340010							
	1.1			01.77	02.85	03.3517-0101.2	390322							
	1.3			01.77	02.85									
	1.0	◀		..-F-127903	10.81	+ Bremsgerät ⁴⁾	03.2120-1531.3				010092	1	THz 20,64 Bremslichtschalter	ATE
1.1	◀		..-F-127903	10.81	+ Bremsgerät ⁵⁾	03.3526-2002.3	340010							
1.1	◀		..-F-127903	01.77	+ Bremsgerät ⁵⁾									
1.3	◀		..-F-127903	10.81	+ Bremsgerät ⁵⁾									
1.3	◀		..-F-127903	01.77	+ Bremsgerät ⁵⁾									
	1.0	◀	..-F-127904		12.88	+ Bremsgerät ⁵⁾	03.2120-2031.3	010106	THz 20,64	ATE				
	1.1	◀	..-F-127904		12.88	+ Bremsgerät ⁵⁾								
	1.3	◀	..-F-127904		12.88	+ Bremsgerät ⁵⁾								
	1.3 D	◀		08.86	12.88									
	0.9			01.77	09.81	03.3508-7504.3	310045	ohne Warneinrichtung			Behälter	ATE		
	1.0			10.81	02.85			11.0441-4402.2	250014	Dichtungssatz	ATE			
	1.1			01.77	02.85									
	1.3			01.77	02.85									
	1.0			..-F-127903	10.81		11.0441-4402.2					250014	Dichtungssatz	ATE
	1.1			..-F-127903	10.81									
	1.3		..-F-127903	10.81										
	1.0		..-F-127904		12.88	24.3481-1745.5	240277	D=48, - Halter D=48, - Halter Dichtungssatz Hülssensatz Hülssensatz+Schrauben	ATE ATE ATE ATE ATE					
	1.1		..-F-127904		12.88	24.3481-1746.5	240278							
	1.3		..-F-127904		12.88	11.0441-4808.2	250022							
	1.3 D			08.86	12.88	11.0101-4803.2	260008							
					24.0102-4803.2	260086								
	0.9			01.77	09.81	13.0460-4028.2	604028	20228 15,3	ATE					
	1.1			01.77	09.81									
	1.3			01.77	09.81									
	1.0			..-F-127903	10.81	13.0460-4028.2	604028			20228 15,3 Belagsatz-Zubehör	ATE ATE			
	1.1			..-F-127903	10.81	13.0460-0115.2	610115							
1.3			..-F-127903	10.81										
	1.0		..-F-127904		12.88	13.0460-7030.2	607030	20889 17,3 /Zub Belagsatz-Zubehör	VW VW					
	1.1		..-F-127904		12.88	13.0460-0184.2	610184							
	1.3		..-F-127904		12.88									

¹⁾ without sensor ring / senza sensori / sans secours ABS / sin anillo sensor ABS
²⁾ with sensor ring / con sensori / avec secours ABS / con anillo sensor ABS
³⁾ on the brake caliper / sulla pinza freno / sur l'étrier de frein / a la pinza de freno
⁴⁾ - booster unit / - servofreno / - servo-frein / - servofreno
⁵⁾ + booster unit / + servofreno / + servo-frein / + servofreno



VOLKSWAGEN DERBY/POLO Stufenheck (77-88)											
	1.3 D			08.86	12.88	13.0460-7030.2 13.0460-0184.2	607030 610184		20889 17,3 /Zub Belagsatz-Zubehör	VW VW	
	0.9 1.1 1.3 1.0 1.1 1.3 1.3 D			01.77 01.77 01.77 10.81 10.81 10.81 08.86	09.81 09.81 09.81 12.88 12.88 12.88 12.88	24.0108-0100.1	408100		239 8,0 7,0		
	1.0 1.1 1.3 1.3 D			10.81 10.81 10.81 08.86	12.88 12.88 12.88 12.88	24.0110-0151.1 24.0310-0151.1	410151 510151		239 10,0 8,0 +S +B 239 10,0 8,0 +S +B PD		
	0.9 1.0 1.1 1.3 1.3 D			01.77 01.77 01.77 01.77 08.86	09.81 12.88 12.88 12.88 12.88	24.5170-0296.3	331451	2	L=296		
	0.9 1.0 1.1 1.3 1.3 D			01.77 01.77 01.77 01.77 08.86	09.81 12.88 12.88 12.88 12.88	24.5204-0180.3	331461	2	L=180		
	0.9 1.0 1.1 1.3 1.3 D			01.77 01.77 01.77 01.77 08.86	09.81 12.88 12.88 12.88 12.88	03.3214-0812.3	020011		+ GG ²⁾	Rz 14,29	
	1.0 1.1 1.3 1.3 D	...F-127904 ...F-127904 ...F-127904		12.88 12.88 12.88 08.86	- Bremskraftregler ¹⁾ - Bremskraftregler ¹⁾ - Bremskraftregler ¹⁾ - Bremskraftregler ¹⁾	03.3215-2311.3 24.3215-0903.3	020018 020154		+ GG ²⁾ + ALU ³⁾	Rz 15,87 Rz 15,87	
	0.9 1.0 1.1 1.3 1.3 D			01.77 10.81 01.77 01.77 08.86	09.81 + Bremskraftregler ⁴⁾ + Bremskraftregler ⁴⁾ + Bremskraftregler ⁴⁾ + Bremskraftregler ⁴⁾	03.3217-2112.3	020027		+ GG ²⁾	Rz 17,46	
	1.0 1.1 1.3 1.3 D	...F-127904 ...F-127904 ...F-127904		12.88 12.88 12.88 08.86	+ Bremskraftregler ⁴⁾ + Bremskraftregler ⁴⁾ + Bremskraftregler ⁴⁾ + Bremskraftregler ⁴⁾	24.3219-0909.3	020188			Rz 19,05	
	0.9 1.1 1.3			01.77 01.77 01.77	07.78 07.78 07.78	03.0137-9006.2	669006		- autom. Nachstellung ⁵⁾	Bremsbacken-Zubehör	
	0.9 1.0 1.1 1.3 1.3 D			08.78 10.81 08.78 08.78 08.86	09.81 12.88 12.88 12.88 12.88	03.0137-0126.2 03.0137-9008.2	650126 669008			180 x 31 HEB Bremsbacken-Zubehör	
	0.9 1.0 1.1 1.3 1.3 D			01.77 10.81 01.77 01.77 08.86	09.81 12.88 12.88 12.88 12.88	24.0218-0007.1 24.0218-0707.2	480003 480211			180/181 x 38,5 - Lager 180/181 x 38,5 + Lager	
	0.9 1.0 1.1 1.3			08.78 10.81 08.78 08.78	09.81 - Bremskraftregler ¹⁾ - Bremskraftregler ¹⁾ - Bremskraftregler ¹⁾ - Bremskraftregler ¹⁾	03.0520-0114.3	690114			14,29/180x31 TopKit	VW
	0.9 1.0 1.1 1.3			08.78 10.81 08.78 08.78	+ Bremskraftregler ⁴⁾ + Bremskraftregler ⁴⁾ + Bremskraftregler ⁴⁾ + Bremskraftregler ⁴⁾	03.0420-0617.3 03.0520-3917.3	680617 693917		+ Rz GG ⁶⁾ + Rz ALU ⁷⁾	17,46/180x31 Kit 17,46/180x31 TopKit	VW VW
	1.0 1.1 1.3 1.3 D	...F-127904 ...F-127904 ...F-127904		12.88 12.88 12.88 08.86	- Bremskraftregler ¹⁾ - Bremskraftregler ¹⁾ - Bremskraftregler ¹⁾ - Bremskraftregler ¹⁾	03.0520-0215.3	690215			15,87/180x31 TopKit	VW
	0.9 1.0 1.1 1.3			01.77 10.81 01.77 01.77	09.81 10.81 01.77 01.77	24.3727-0146.2 24.3727-0103.2	580146 580103	1 1		L=794 L=1960	
	1.0 1.1 1.3 1.3 D	...F-000001 ...F-000001 ...F-000001		12.88 12.88 12.88 08.86	12.88 12.88 12.88 12.88	24.3727-0137.2 24.3727-0129.2	580137 580129	1 2		L=1594 L=633	
	1.0 1.1 1.3 1.3 D	...F-000001 ...F-000001 ...F-000001		12.88 12.88 12.88 08.86	12.88 12.88 12.88 12.88	03.6584-0015.3	320109			BRL 8/4 (4)	ATE
	0.9 1.0 1.1 1.3			01.77 10.81 01.77 01.77	09.81 10.81 01.77 01.77	24.3728-0101.2	590101			L=607	
VOLKSWAGEN GOLF I (74-83)											
	1.1 1.1 1.5 1.5 D 1.6			04.74 04.74 02.74 08.76 04.74	03.75 - Bremsgerät/ + VA-Trommelbremse ⁹⁾ - Bremsgerät/ + VA-Scheibenbremse ⁹⁾ - Bremsgerät/ + ⊕ ¹⁰⁾ - Bremsgerät ¹¹⁾ - Bremsgerät/ + ⊕ ¹⁰⁾	03.3526-2002.3 03.3526-2002.3 24.3526-1900.0	340010 340010 340038	1 1 1		Bremslichtschalter Bremslichtschalter Bremslichtschalter	

1) - brake pressure regulator / - correttore di frenata / - correcteur de freinage / - corrector de frenado

2) + cast iron / + ghisa / + fonte grise / + fundición de gris

3) + aluminium / + alluminio / + aluminio / + aluminium

4) + brake pressure regulator / + correttore di frenata / + correcteur de freinage / + corrector de frenado

5) - automatic adjustment / - correzione automatica / - ajustage automatique / - reajuste automatico

6) + WC cast iron / + CR ghisa / + CR fontegrise / + CR fundición de gris

7) + WC aluminium / + CR alluminio / + CR aluminio / + CR aluminium

8) - booster unit/+ FA drum brake / - servofreno/+ A freno a tamburo / - servofr./+ fr.à tambour ess.AV / - servofr./+ eje del.-tamb.fr.

9) - booster unit/+ FA disc brake / - servofreno/+ A disco freno / - servofr./+ fr.à disque ess.AV / - servofr./+ eje del.-disco fr.

10) - booster unit/ + ⊕ / - servofreno/ + ⊕ / - servo-frein/ + ⊕ / - servofreno/ + ⊕

11) - booster unit / - servofreno / - servo-frein / - servofreno

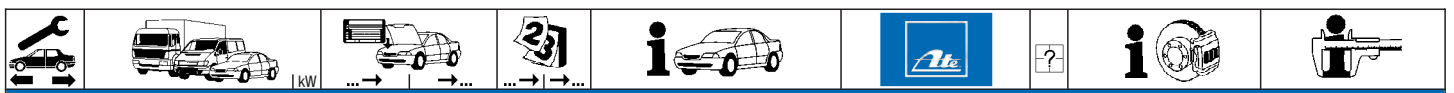

VOLKSWAGEN GOLF I (74-83)

	1.6 D		08.80	07.81	- Bremsgerät ¹⁾	03.3526-2002.3	340010	1		Bremslichtschalter	
						24.3526-1900.0	340038	1		Bremslichtschalter	
	1.1		04.74	07.79	+ Bremsgerät ²⁾	03.2120-1531.3	010092			THz 20,64	ATE
	1.5		02.74	07.79	+ Bremsgerät ²⁾	03.3526-2002.3	340010	1		Bremslichtschalter	
	1.6		04.74	07.79	+ Bremsgerät ²⁾	24.3526-1900.0	340038	2		Bremslichtschalter	
	1.5 D		08.76	07.79	+ Bremsgerät ²⁾	24.3526-1900.0	340038	2		Bremslichtschalter	
	1.6 GTI		06.76	07.79							
	1.5 D		08.79	07.80	+ Bremsgerät ²⁾	03.2120-1491.3	010089			THz 20,64 + WE	ATE
	1.6 D		08.80	07.81	+ Bremsgerät ²⁾	03.3526-2002.3	340010	2		Bremslichtschalter	
	1.1		08.79	10.83	+ Bremsgerät ²⁾	03.2120-1531.3	010092			THz 20,64	ATE
	1.3		08.79	10.83	+ Bremsgerät ²⁾	03.3526-2002.3	340010	1		Bremslichtschalter	
	1.5		08.79	10.83	+ Bremsgerät ²⁾	03.2120-1491.3	010089			THz 20,64 + WE	ATE
	1.6		08.79	10.83	+ Bremsgerät ²⁾						
	1.6 D		08.81	10.83	+ Bremsgerät ²⁾						
	1.1		08.79	10.83	+ Bremsgerät ²⁾	03.2120-1491.3	010089			THz 20,64 + WE	ATE
	1.3		08.79	10.83	+ Bremsgerät ²⁾	03.3526-2002.3	340010	2		Bremslichtschalter	
	1.5		08.79	10.83	+ Bremsgerät ²⁾						
	1.6		08.79	10.83	+ Bremsgerät ²⁾						
	1.6 D		08.81	10.83	+ Bremsgerät ²⁾						
	1.6 GTI		08.79	07.82		03.2120-1491.3	010089			THz 20,64 + WE	ATE
	1.6 TD		03.82	10.83							
	1.8 GTI		08.82	10.83							
	1.1		08.76	08.80	+	03.2120-1821.3	010100			THz 20,64	ATE
	1.3		08.79	08.80	+						
	1.5		08.76	08.80	+						
	1.5 D		08.76	08.80	+						
	1.6		08.76	08.80	+						
	1.6 GTI		08.76	08.80	+						
	1.1		09.80	10.83	+	03.2120-1821.3	010100			THz 20,64	ATE
	1.3		09.80	10.83	+						
	1.5		09.80	10.83	+						
	1.6		09.80	10.83	+						
	1.6 D		08.80	10.83	+						
	1.6 GTI		09.80	07.82	+						
	1.6 TD		03.82	10.83	+						
	1.8 GTI		08.82	10.83	+						
	1.1		04.74	07.79		03.3508-7504.3	310045		ohne Warneinrichtung	Behälter	ATE
	1.5		02.74	07.79							
	1.5 D		08.76	07.79							
	1.6		04.74	07.79							
	1.6 GTI		06.76	07.79							
	1.1		04.74	07.75		11.0441-4402.2	250014			Dichtungssatz	ATE
	1.5		02.74	07.80	+ Schwimmsättel ³⁾						
	1.6		04.74	07.80	+ Schwimmsättel ³⁾						
	1.1		08.75	10.83		11.0441-4402.2	250014			Dichtungssatz	ATE
	1.3		08.79	10.83							
	1.5 D		08.76	07.80							
	1.6 D		08.80	10.83							
	1.6 GTI		06.76	07.80	+ Schwimmsättel ³⁾	11.0441-4402.2	250014			Dichtungssatz	ATE
	1.5		08.78	10.83	+ Faustsättel ⁴⁾	11.0441-4808.2	250022		f.Vornr -8007/8008 -8503/8504 ⁵⁾	Dichtungssatz	ATE
	1.6		08.78	10.83	+ Faustsättel ⁴⁾	11.0441-4804.2	250019			Dichts.a.(+Sich.Ring)	ATE
	1.6 GTI		04.79	07.82	+ Faustsättel ⁴⁾	11.0101-4801.2	260006			Hülzensatz	ATE
	1.6 TD		03.82	10.83		24.0102-4801.2	260085			Hülzensatz+Schrauben	ATE
	1.7		08.80	10.83	+						
	1.8 GTI		08.82	10.83							
	1.1		04.74	07.75		13.0460-4029.2	604029			20228 18,5	ATE
	1.5		02.74	07.80	+ Schwimmsättel ³⁾						
	1.6		04.74	07.80	+ Schwimmsättel ³⁾						
	1.1		08.75	02.78		13.0460-4028.2	604028			20228 15,3	ATE
	1.5 D		08.76	02.78		13.0460-0029.2	610029			Belagsatz-Zubehör	ATE
						13.0460-0905.2	610905			Belagsatz-Zubehör	TRW
	1.1		03.78	10.83		13.0460-4028.2	604028			20228 15,3	ATE
	1.3		08.79	10.83		13.0460-0115.2	610115			Belagsatz-Zubehör	ATE
	1.5 D		03.78	07.80		13.0460-0905.2	610905			Belagsatz-Zubehör	TRW
	1.6 D		08.80	10.83							
	1.5		08.78	10.83	+ Faustsättel ⁴⁾	13.0460-7032.2	607032			20887 19,7 +/Zub	VW
	1.6		08.78	10.83	+ Faustsättel ⁴⁾						
	1.6 TD		03.82	10.83							
	1.6 GTI		06.76	07.80	+ Schwimmsättel ³⁾	13.0460-4028.2	604028			20228 15,3	ATE
	1.6 GTI		04.79	07.82	+ Faustsättel ⁴⁾	13.0460-7033.2	607033			20887 15,3 +/Zub	VW
	1.8 GTI		08.82	10.83							
	1.1		04.74	07.75		24.0112-0106.1	412106			239 12,0 10,0 +S +B	
	1.5		02.74	10.83		24.0312-0106.1	512106			239 12,0 10,0 +S +B PD	
	1.6		08.75	10.83							
	1.6 TD		03.82	10.83							
	1.7		08.80	10.83	+						
	1.1		08.75	10.83		24.0110-0151.1	410151			239 10,0 8,0 +S +B	
	1.3		08.79	10.83		24.0310-0151.1	510151			239 10,0 8,0 +S +B PD	
	1.5 D		08.76	07.80							
	1.6 D		08.80	10.83							
	1.6 GTI		06.76	07.82		24.0120-0123.1	420123			239 20,0 18,0 V L +S +B	
	1.8 GTI		08.82	10.83		24.0320-0123.1	520123			239 20,0 18,0 V L +S +B PD	

¹⁾ - booster unit / - servofreno / - servo-frein / - servofreno

²⁾ + booster unit / + servofreno / + servo-frein / + servofreno

³⁾ + floating calipers / + pinze flottante / + étriers flottant / + pinzas flotante

⁴⁾ + fist type calipers / + pinza freno flottante / + étriers à griffe / + pinza de puno

⁵⁾ f.partno.-8007/8008 -8503/8504 / p.no.codice -8007/8008 -8503/8504 / p.AV ref. -8007/8008 -8503/8504



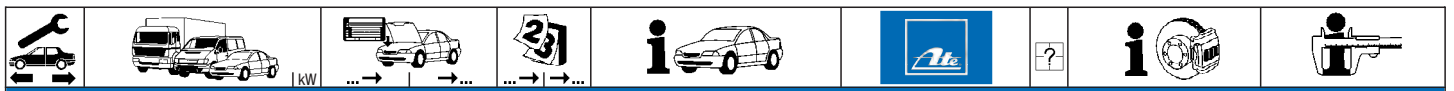

VOLKSWAGEN GOLF I (74-83)

	1.1	04.75	10.78	+ VA-Scheibenbremse ¹⁾	83.6104-0325.3	330246	2		L=325	ATE
	1.5	02.74	10.78							
	1.5 D	08.76	10.78							
	1.6	04.74	10.78							
	1.6 GTI	06.76	10.78							
	1.1	11.78	10.83			24.5170-0315.3	331309	2		L=315
1.3	08.79	10.83			24.5108-0266.3	330038	2		L=266	
1.5	11.78	10.83								
1.5 D	11.78	07.80								
1.6	11.78	10.83								
1.6 D	08.80	10.83								
1.6 GTI	11.78	07.82								
1.6 TD	03.82	10.83								
1.8 GTI	08.82	10.83								
1.1	04.74	10.83			24.5201-0164.3	331414	2		L=164	
1.3	08.79	10.83								
1.5	02.74	10.83								
1.5 D	08.76	07.80								
1.6	04.74	10.83								
1.6 D	08.80	10.83								
1.6 GTI	06.76	07.82								
1.6 TD	03.82	10.83								
1.8 GTI	08.82	10.83								
	1.1	04.74	10.83		03.3214-0812.3	020011		+ GG ²⁾	Rz 14,29	Rz 14,29
	1.3	08.79	10.83		24.3214-0902.3	020147		+ ALU ³⁾	Rz 14,29	
	1.5	02.74	10.83	+ Schaltgetriebe ⁴⁾						
	1.5 D	08.76	07.80	+ Schaltgetriebe ⁴⁾						
	1.6	04.74	10.83	+ Schaltgetriebe/ - $\text{\textcircled{S}}$ ⁵⁾						
	1.6 D	08.80	10.83	+ Schaltgetriebe ⁴⁾						
	1.6 TD	03.82	10.83							
	1.5	02.74	10.83	+ Automatikgetriebe ⁶⁾	03.3217-2112.3	020027		+ GG ²⁾	Rz 17,46	
	1.5 D	08.76	07.80	+ Automatikgetriebe ⁶⁾	24.3217-0908.3	020167		+ ALU ³⁾	Rz 17,46	
	1.6	04.74	10.83	+ $\text{\textcircled{S}}$						
1.6	04.74	10.83	+ Automatikgetriebe ⁶⁾							
1.6 D	08.80	10.83	+ Automatikgetriebe ⁶⁾							
1.6 GTI	06.76	07.82								
1.7	08.80	10.83	+ $\text{\textcircled{J}}$							
1.8 GTI	08.82	10.83								
	1.1	04.74	07.78		03.0137-9006.2	669006		- autom. Nachstellung ⁷⁾	Bremsbacken-Zubehör	
	1.5	02.74	07.78							
	1.6	04.74	07.78							
	1.6 GTI	06.76	07.78							
	1.1	08.78	10.83		03.0137-0126.2	650126			180 x 31 HEB	Bremsbacken-Zubehör
	1.3	08.79	10.83		03.0137-9008.2	669008				
	1.5	08.78	10.83							
	1.5 D	08.78	07.80							
	1.6	08.78	10.83							
	1.6 D	08.80	10.83							
	1.6 GTI	08.78	07.82							
	1.6 TD	03.82	10.83							
	1.7	08.80	10.83	+ $\text{\textcircled{J}}$						
	1.8 GTI	08.82	10.83							
	1.1	04.74	10.83		24.0218-0007.1	480003			180/181 x 38,5 - Lager	180/181 x 38,5 - Lager 180/181 x 38,5 - Lager
	1.3	08.79	10.83		24.0218-0707.2	480211				
	1.5	02.74	10.83							
	1.5 D	08.76	07.80							
	1.6	04.74	10.83							
	1.6 D	08.80	10.83							
	1.6 GTI	06.76	07.82							
	1.6 TD	03.82	10.83							
1.8 GTI	08.82	10.83								
	1.1	08.78	10.83		03.0520-0114.3	690114			14,29/180x31 TopKit	VW
	1.3	08.79	10.83							
	1.5	08.78	10.83	+ Schaltgetriebe ⁴⁾						
	1.5 D	08.78	07.80	+ Schaltgetriebe ⁴⁾						
	1.6	08.78	10.83	+ Schaltgetriebe/ - $\text{\textcircled{S}}$ ⁵⁾						
	1.6 D	08.80	10.83	+ Schaltgetriebe ⁴⁾						
	1.6 TD	03.82	10.83							
	1.5	08.78	10.83	+ Automatikgetriebe ⁶⁾	03.0420-0617.3	680617		+ Rz GG ⁸⁾	17,46/180x31 Kit	
	1.5 D	08.78	07.80	+ Automatikgetriebe ⁶⁾	03.0520-3917.3	693917		+ Rz ALU ⁹⁾	17,46/180x31 TopKit	
	1.6	08.78	10.83	+ $\text{\textcircled{S}}$						
1.6	08.78	10.83	+ Automatikgetriebe ⁶⁾							
1.6 D	08.80	10.83	+ Automatikgetriebe ⁶⁾							
1.6 GTI	08.78	07.82								
1.7	08.80	10.83	+ $\text{\textcircled{J}}$							
1.8 GTI	08.82	10.83								
	1.1	01.74	10.83		24.3727-0102.2	580102	2	$\text{\textcircled{J}}$	L=1690	
	1.3	08.79	10.83							
	1.5	02.74	10.83							
	1.5 D	08.76	07.80							
	1.6	04.74	10.83							
	1.6 D	08.80	10.83							
	1.6 GTI	06.76	07.82							
	1.6 TD	03.82	10.83							
	1.8 GTI	08.82	10.83							

¹⁾ + FA disc brake / + A disco freno / + frein à disque essieu AV / + ED disco de freno

²⁾ + cast iron / + ghisa / + fonte grise / + fundición de gris

³⁾ + aluminium / + alluminio / + aluminio / + aluminio

⁴⁾ + manual transmission / + scatola cambio velocità / + transmission mécanique / + cambio de velocidad

⁵⁾ + manual transmission / - $\text{\textcircled{S}}$ / + scatola camb.velocità / - $\text{\textcircled{S}}$ / + transmission mécanique / - $\text{\textcircled{S}}$ / + cambio de velocidad / - $\text{\textcircled{S}}$

⁶⁾ + autom. transmission / + scatola cambio automatico / + transmission automatique / + cambio automático

⁷⁾ - automatic adjustment / - correzione automatica / - ajustage automatique / - reajuste automatico

⁸⁾ + WC cast iron / + CR ghisa / + CR fonte grise / + CR fundición de gris

⁹⁾ + WC aluminium / + CR alluminio / + CR aluminium / + CR aluminio



VOLKSWAGEN GOLF I (74-83)















	1.1			04.74	10.83		03.6565-0101.3	320097		BRL 6/5 (4)	ATE
	1.3			08.79	10.83						
	1.5			02.74	10.83						
	1.5 D			08.76	07.80						
	1.6			04.74	10.83						
	1.6 D			08.80	10.83						
	1.6 GTI			06.76	07.82						
	1.6 TD			03.82	10.83						
	1.8 GTI			08.82	10.83						
	1.1			08.75	10.83		24.3728-0107.2	590107		L=1055	
	1.5			02.74	10.83		24.3728-0108.2	590108		L=794	
	1.5 D	◀		08.76	07.80						
	1.6	◀		04.74	10.83						
	1.6 D	◀		08.80	10.83						
	1.6 GTI	◀		06.76	07.82						
	1.6 TD	◀		03.82	10.83						
	1.7	◀		08.80	10.83	+ ①					
	1.8 GTI	◀		08.82	10.83						



VOLKSWAGEN GOLF I Cabriolet (79-93)

	1.1			01.79	07.83		03.2120-1531.3	010092		THz 20,64	ATE
	1.5			01.79	07.83		03.3526-2002.3	340010	1	Bremslichtschalter	
	1.6		15-E-011290	08.83	08.83		03.3517-0101.2	390322		Verschlußschraube	
	1.6 GLI			07.79	07.82						
	1.8		15-E-011290	08.82	08.82						
	1.1			01.79	07.83		03.2120-1491.3	010089	2	THz 20,64 + WE	ATE
	1.5			01.79	07.83		03.3526-2002.3	340010		Bremslichtschalter	
	1.6		15-E-011290	08.83	08.83		03.3517-0101.2	390322		Verschlußschraube	
	1.6 GLI			07.79	07.82						
	1.8		15-E-011290	08.82	08.82						
	1.6		15-E-011291	15-L-015000			03.2120-2031.3	010106		THz 20,64	ATE
	1.8		15-E-011291	15-L-015000			03.3517-0101.2	390322		Verschlußschraube	
	1.6	◀	15-L-015001		12.92		03.2120-3943.3	010532		THz 20,64	ATE
	1.8	◀	15-L-015001		08.93						
	1.1			01.79	07.83		11.0441-4402.2	250014		Dichtungssatz	ATE
	1.5			01.79	07.80	+ Schwimmsättel 1)					
	1.6 GLI			01.79	07.80	+ Schwimmsättel 1)	11.0441-4402.2	250014		Dichtungssatz	ATE
	1.5			09.79	07.83	+ Faustsättel 2)	11.0441-4808.2	250022	f.Vornr - 8007/8008 - 8503/8504 3)	Dichtungssatz	ATE
	1.6		15-E-011290	08.83	08.83	+ Faustsättel 2)	11.0441-4804.2	250019		Dichts. (+Sich. Ring)	ATE
	1.6 GLI			09.79	07.82	+ Faustsättel 2)	11.0101-4801.2	260006		HülSENSatz	ATE
	1.8		15-E-011290	08.82	08.82		24.0102-4801.2	260085		HülSENSatz+Schrauben	ATE
	1.6		15-E-011291		12.92		11.0441-4808.2	250022		Dichtungssatz	ATE
	1.8		15-E-011291		08.93		11.0101-4801.2	260006		HülSENSatz	ATE
							24.0102-4801.2	260085		HülSENSatz+Schrauben	ATE
	1.1			01.79	07.83		13.0460-4028.2	604028		20228 15,3	ATE
	1.5			01.79	07.80	+ Schwimmsättel 1)	13.0460-0115.2	610115		Belagsatz-Zubehör	ATE
	1.5			09.79	07.83	+ Faustsättel 2)	13.0460-7032.2	607032		20887 19,7 +/Zub	VW
	1.6			08.83	12.92						
	1.6 GLI			07.79	07.80	+ Schwimmsättel 1)	13.0460-4028.2	604028		20228 15,3	ATE
	1.6 GLI			09.79	07.82	+ Faustsättel 2)	13.0460-7033.2	607033		20887 15,3 +/Zub	VW
	1.8			08.82	08.93						
	1.1			01.79	07.83		24.0110-0151.1	410151		239 10,0 8,0 +S +B	
	1.5			01.79	07.83		24.0310-0151.1	510151		239 10,0 8,0 +S +B PD	
	1.6			08.83	12.92		24.0112-0106.1	412106		239 12,0 10,0 +S +B	
	1.6 GLI			07.79	07.82		24.0312-0106.1	512106		239 12,0 10,0 +S +B PD	
	1.8			08.82	08.93		24.0120-0123.1	420123		239 20,0 18,0 V L +S +B	
							24.0320-0123.1	520123		239 20,0 18,0 V L +S +B PD	
	1.1			01.79	07.83		24.5170-0315.3	331309	2	L=315	
	1.5			01.79	07.83		24.5108-0266.3	330038	2	L=266	TRW
	1.6			08.83	08.93						
	1.6 GLI			07.79	07.82						
	1.8			08.82	08.93						
	1.1			01.79	07.83		24.5204-0180.3	331461	2	L=180	
	1.5			01.79	07.83						
	1.6 GLI			07.79	07.82						
	1.8			08.82	07.83						
	1.6			08.83	07.93		24.5201-0164.3	331414	2	L=164	
	1.8			08.83	07.93						
	1.1			01.79	07.83	- Bremskraftregler 4)	03.3214-0812.3	020011		+ GG 5)	Rz 14,29
	1.5			01.79	07.83	- Bremskraftregler 4)	24.3214-0902.3	020147		+ ALU 6)	Rz 14,29
	1.6		15-E-011290	08.83	08.83	- Bremskraftregler 4)					
	1.6 GLI			07.79	07.82	- Bremskraftregler 4)					
	1.8		15-E-011290	08.82	08.82	- Bremskraftregler 4)					
	1.1			01.79	07.83	+ Bremskraftregler 7)	03.3217-2112.3	020027		+ GG 5)	Rz 17,46
	1.5			01.79	07.83	+ Bremskraftregler 7)	24.3217-0908.3	020167		+ ALU 6)	Rz 17,46
	1.6			08.83	08.83	+ Bremskraftregler 7)					
	1.6 GLI		15-E-011291		12.92	+ Bremskraftregler 7)					
	1.8		15-E-011290	08.82	07.79	+ Bremskraftregler 7)					
		15-E-011291		08.93	+ Bremskraftregler 7)						

1) + floating calipers / + pinze flottante / + étriers flottant / + pinzas flotante
 2) + fist type calipers / + pinza freno flottante / + étriers à griffe / + pinza de puno
 3) f.partno. -8007/8008 -8503/8504 / p.no.codice -8007/8008 -8503/8504 / p.AV ref. -8007/8008 -8503/8504 / p.antes ref. -8007/8008 -8503/8504
 4) - brake pressure regulator / - correttore di frenata / - correcteur de freinage / - corrector de frenado
 5) + cast iron / + ghisa / + fonte grise / + fundición de gris
 6) + aluminium / + alluminio / + aluminium / + aluminio
 7) + brake pressure regulator / + correttore di frenata / + correcteur de freinage / + corrector de frenado



								
VOLKSWAGEN GOLF I Cabriolet (79-93)								
	1.1 1.5 1.6 1.6 GLI 1.8			01.79 07.83 01.79 07.83 08.83 08.93 07.79 07.82 08.82 08.93		03.0137-0126.2 650126 03.0137-9008.2 669008		180 x 31 HEB Bremsbacken-Zubehör
	1.1 1.5 1.6 1.6 GLI 1.8			01.79 07.83 01.79 07.83 08.83 08.93 07.79 07.82 08.82 08.93		24.0218-0007.1 480003 24.0218-0707.2 480211		180/181 x 38,5 - Lager 180/181 x 38,5 + Lager
	1.1 1.5 1.6 1.6 GLI 1.8		15-E-011290	01.79 07.83 01.79 07.83 08.83 09.79 07.82 15-E-011290 08.82		03.0520-0114.3 690114		14,29/180x31 TopKit VW
	1.1 1.5 1.6 1.6 GLI 1.8 1.8		15-E-011291	01.79 07.83 01.79 07.83 08.83 12.92 07.79 07.82 15-E-011290 08.82 08.93		03.0420-0617.3 680617 03.0520-3917.3 693917	+ Rz GG ³⁾ + Rz ALU ⁴⁾	17,46/180x31 Kit VW 17,46/180x31 TopKit VW
	1.1 1.5 1.6 1.6 GLI 1.8			01.79 07.83 01.79 07.83 08.83 04.92 07.79 07.82 08.82 04.93		24.3727-0102.2 580102	2	L=1690
	1.1 1.5 1.6 1.6 GLI 1.8		15-E-011290 15-E-011290	01.79 07.83 01.79 07.83 08.83 01.79 07.82 08.82		03.6565-0101.3 320097		BRL 6/5 (4) ATE
	1.1 1.5 1.6 1.6 GLI 1.8			01.79 07.83 01.79 07.83 08.83 12.92 01.79 07.82 08.82 08.93		24.3728-0107.2 590107 24.3728-0108.2 590108		L=1055 L=794

VOLKSWAGEN GOLF II (84-93)								
	1.6 1.6 1.6 D 1.6 TD 1.8 1.8 GTI 1.8 GTI 1.8 GTI 16V 1.8 GTI 16V 1.8 Rallye 1.8 Syncro 1.8 Syncro G60			08.83 07.87 08.87 12.93 08.83 07.89 08.83 07.89 08.83 07.89 1G-KW240000 01.84 1G-KB075000 01.84 1G-KW240000 02.86 1G-KB075000 02.86 04.89 07.92 08.85 07.92 04.89 07.92		03.6750-0202.4 300033		9" ATE
	1.6 D 1.6 TD 1.8 1.8 G60 1.8 GTI 1.8 GTI 1.8 GTI 16V 1.8 GTI 16V		1G-KW240001 1G-KB075001 1G-KW240001 1G-KB075001	08.89 07.92 08.89 12.93 08.89 07.92 04.90 07.92 07.92 07.92 07.92 07.92		03.7750-4302.4 300076		9" ATE
	1.6 1.6 D 1.6 TD 1.8 1.8 G60 1.8 GTI 1.8 GTI 1.8 GTI 16V 1.8 GTI 16V		1G-KW240001 1G-KB075001 1G-KW240001 1G-KB075001	08.89 12.93 08.89 07.92 08.89 12.93 08.89 07.92 04.90 07.92 07.92 07.92 07.92 07.92		03.7750-4902.4 300079		9" ATE
	1.0 1.3 1.6 1.6 D 1.6 TD 1.8 1.8 GTI 1.8 GTI 1.8 GTI 16V 1.8 GTI 16V 1.8 Rallye 1.8 Syncro 1.8 Syncro G60			08.83 10.91 08.83 12.93 08.83 12.93 08.83 07.89 08.83 07.89 08.83 07.89 1G-KW240000 01.84 1G-KB075000 01.84 1G-KW240000 02.86 1G-KB075000 02.86 04.89 07.92 08.85 07.92 04.89 07.92		03.2120-2031.3 010106 03.3517-0101.2 390322		THz 20,64 Verschlusschraube ATE
	1.6 D 1.6 TD 1.8			08.89 07.92 08.89 12.93 08.89 07.92		03.2120-3943.3 010532 03.3517-0101.2 390322		THz 20,64 Verschlusschraube ATE

1) - brake pressure regulator / - correttore di frenata / - correcteur de freinage / - corrector de frenado
2) + brake pressure regulator / + correttore di frenata / + correcteur de freinage / + corrector de frenado
3) + WC cast iron / + CR ghisa / + CR fontegrise / + CR fundición de gris
4) + WC aluminium / + CR alluminio / + CR aluminium / + CR aluminio
5) - ABS/ + autom.transmission / - ABS/ + scatola cambio autom. / - ABS/ + transmission automatique / - ABS/ + cambio automático



VOLKSWAGEN GOLF II (84-93)

	1.8 GTI 1.8 GTI 1.8 GTI 16V 1.8 GTI 16V	1G-KB075001 1G-KW240001 1G-KB075001 1G-KW240001		07.92 - ABS 07.92 - ABS 07.92 - ABS 07.92 - ABS	03.2122-1042.3 03.3517-0101.2	010137 390322		THz 22,20 Verschlusschraube	ATE
	1.0 1.0 1.0 1.3 1.3 1.3 1.6 D 1.6 D 1.6 D		19-E-855000 19-E-855000 19-E-855000 19-E-855000	08.83 08.83 07.86 08.86 10.91 - ABS 08.83 08.83 07.86 08.86 12.93 - ABS 08.83 08.83 07.86 - (⊖) 08.86 07.92 + Schaltgetriebe 1)	24.3481-1745.5 24.3481-1746.5 11.0441-4808.2 11.0101-4803.2 24.0102-4803.2	240277 240278 250022 260008 260086	<input type="checkbox"/> <input type="checkbox"/>	D=48, - Halter D=48, - Halter Dichtungssatz Hülssensatz Hülssensatz+Schrauben	ATE ATE ATE ATE ATE
	1.0 1.0 1.3 1.3 1.6 1.6 D 1.6 D 1.6 D 1.6 TD 1.8 1.8 GT 1.8 GT Special 1.8 GTI 1.8 GTI 16V 1.8 GTI 16V 1.8 Syncro	19-E-855001 19-E-855001 19-E-855001 19-E-855001		07.86 08.89 10.91 + ABS 07.86 08.89 12.93 + ABS 08.83 12.93 08.83 07.86 - (⊖) 08.83 07.86 + (⊕) 08.86 07.92 + Automatikgetriebe 2) 08.83 12.93 08.83 07.92 08.85 07.92 08.85 07.92 01.84 07.92 02.86 02.86 08.85 07.92	11.0441-4808.2 11.0101-4801.2 24.0102-4801.2	250022 260006 260085		Dichtungssatz Hülssensatz Hülssensatz+Schrauben	ATE ATE ATE
	1.8 GTI 16V 1.8 GTI 16V	1G-KW240001 1G-KB075001		07.92 07.92	24.3541-1609.5 24.3541-1610.5 24.0101-4301.2 11.0101-5403.2	240039 240040 260047 260010	<input type="checkbox"/> <input type="checkbox"/>	D=54, - Halter D=54, - Halter Bremsattel-Zubehör Fallenbalgsatz	TRW TRW TRW TRW
	1.8 G60 1.8 G60 1.8 Rallye 1.8 Rallye 1.8 Syncro G60 1.8 Syncro G60	1G-MW720000 1G-MB225000 1G-MW720000 1G-MB225000 1G-MW720000 1G-MB225000		04.90 04.90 04.89 04.89 04.89 04.89	24.3541-1719.5 24.3541-1720.5 24.0101-4301.2 11.0101-5403.2	240057 240058 260047 260010	<input type="checkbox"/> <input type="checkbox"/>	D=54, - Halter D=54, - Halter Bremsattel-Zubehör Fallenbalgsatz	TRW TRW TRW TRW
	1.8 G60 1.8 G60 1.8 Rallye 1.8 Rallye 1.8 Syncro G60 1.8 Syncro G60	1G-MW720001 1G-MB225001 1G-MW720001 1G-MB225001 1G-MW720001 1G-MB225001		07.92 07.92 07.92 07.92 07.92 07.92	24.3541-1731.5 24.3541-1732.5	240061 240062	<input type="checkbox"/> <input type="checkbox"/>	D=54, - Halter D=54, - Halter	TRW TRW
	1.0 1.0 1.0 1.3 1.3 1.3 1.6 1.6 D 1.6 D 1.6 D		19-E-855000 19-E-855000 19-E-855000 19-E-855000 19-E-855000	08.83 08.83 07.86 08.86 10.91 - ABS 08.83 08.83 07.86 08.86 12.93 - ABS 08.83 07.86 08.83 07.86 - (⊖) 08.83 07.86 - (⊖) 08.86 07.92 + Schaltgetriebe 1)	13.0460-7030.2 13.0460-0184.2	607030 610184		20889 17,3 /Zub Belagsatz-Zubehör	VW VW
	1.0 1.0 1.3 1.3 1.6 1.6 D 1.6 D 1.6 D 1.6 TD 1.8 1.8 1.8 Syncro	19-E-855001 19-E-855001 19-E-855001 19-E-855001		07.86 08.89 10.91 + ABS 07.86 08.89 12.93 + ABS 08.86 12.93 08.83 07.86 08.83 07.86 - (⊖) 08.83 07.86 + (⊕) 08.86 07.92 + Automatikgetriebe 2) 08.83 12.93 01.84 07.92 - ABS/ - GT 01.84 07.92 - ABS/ - GT 08.85 07.92	13.0460-7032.2	607032		20887 19,7 +/Zub	VW
	1.8 1.8 1.8 1.8 GT 1.8 GT Special 1.8 GTI 1.8 GTI 16V 1.8 GTI 16V	62 19-JH560001 66 19-JH560001 77		07.92 + ABS 07.92 + ABS 08.88 07.92 + (⊕) 08.85 07.92 08.85 07.92 01.84 07.92 02.86 02.86	13.0460-7033.2	607033		20887 15,3 +/Zub	VW
	1.8 GTI 16V 1.8 GTI 16V	1G-KW240001 1G-KB075001		07.92 07.92	13.0460-2957.2	602957		20168 16,0 /S	TRW
	1.8 G60 1.8 Rallye 1.8 Syncro G60			04.90 04.89 04.89	13.0460-2958.2	602958		20168 19,3 /S	TRW
	1.0 1.0 1.0 1.3 1.3		19-E-855000 19-E-855000	08.83 08.83 07.86 08.86 10.91 - ABS 08.83 08.83 07.86	24.0110-0151.1 24.0310-0151.1	410151 510151		239 10,0 8,0 +S +B 239 10,0 8,0 +S +B PD	

1) + manual transmission / + scatola cambio velocità / + transmission mécanique / + cambio de velocidad
2) + autom.transmission / + scatola cambio automatico / + transmission automatique / + cambio automático



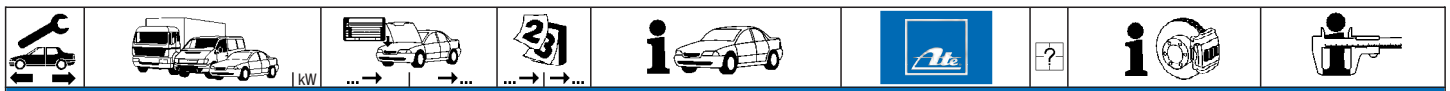

VOLKSWAGEN GOLF II (84-93)

	1.3			08.86	12.93	- ABS	24.0110-0151.1	410151		239 10,0 8,0 +S +B	
	1.6	53		08.83	07.86		24.0310-0151.1	510151		239 10,0 8,0 +S +B PD	
	1.6 D			08.83		- ①					
	1.6 D			08.83		- ②					
	1.6 D			08.86	07.92	+ Schaltgetriebe 1)					
	1.0		19-E-855001		07.86		24.0112-0106.1	412106		239 12,0 10,0 +S +B	
	1.0			08.89	10.91	+ ABS	24.0312-0106.1	512106		239 12,0 10,0 +S +B PD	
	1.3		19-E-855001		07.86						
	1.3			08.89	12.93	+ ABS					
	1.6			08.86	12.93						
	1.6	55		08.83	07.86						
	1.6 D			08.83	07.86	+ ①					
	1.6 D				07.86	- ②					
	1.6 D		19-E-855001		08.86	07.92	+ Automatikgetriebe 2)				
	1.6 TD			08.83	12.93						
1.8	62		01.84	07.92	- ABS/ - GT						
1.8	66		01.84	07.92	- ABS/ - GT						
1.8 Syncro			08.85	07.92							
1.8			01.84	07.92		24.0120-0123.1	420123		239 20,0 18,0 V L +S +B		
1.8	62	19-JH560001		07.92	+ ABS	24.0320-0123.1	520123		239 20,0 18,0 V L +S +B PD		
1.8	66	19-JH560001		07.92	+ ABS						
1.8	77		08.88	07.92	+ ③						
1.8 GT			08.85	07.92							
1.8 GT Special			08.85	07.92							
1.8 GTI			01.84	07.92							
1.8 GTI 16V			02.86								
1.8 GTI 16V			02.86								
1.8 GTI 16V		1G-KW240001		07.92		24.0120-0128.1	420128		256 20,0 18,0 V L +S +B		
1.8 GTI 16V		1G-KB075001		07.92		24.0320-0128.1	520128		256 20,0 18,0 V L +S +B PD		
1.8 G60			04.90	07.92		24.0122-0101.1	422101		280 22,0 20,0 V L +B		
1.8 Rallye			04.89	07.92							
1.8 Syncro G60			04.89	07.92							
	1.0			08.83	10.91		24.5170-0315.3	331309	2	L=315	
	1.3			08.83	12.93						
	1.6			08.83	12.93						
	1.6 D			08.83	07.92						
	1.6 TD			08.83	12.93						
	1.8			08.83	07.92						
	1.8 GTI		1G-KW240000	01.84							
	1.8 GTI		1G-KB075000	01.84							
	1.8 GTI 16V		1G-KW240000	02.86							
	1.8 GTI 16V		1G-KB075000	02.86							
	1.8 Syncro			08.85	07.92						
	1.8 GTI		1G-KW240001		07.92		83.6225-0287.3	330735	2	L=285	
	1.8 GTI		1G-KB075001		07.92						
	1.8 GTI 16V		1G-KW240001		07.92						
	1.8 GTI 16V		1G-KB075001		07.92						
1.8 G60			04.90	07.92		24.5237-0333.3	331425	2	L=333		
1.8 Rallye			04.89	07.92							
1.8 Syncro G60			04.89	07.92							
	1.0			08.86	10.91		24.0711-1313.3	360016	2	Radssensor L=1130	
	1.3			08.86	12.93						
	1.6			08.86	12.93						
	1.6 D			08.86	07.92						
	1.6 TD			08.86	12.93						
	1.8			08.86	07.92						
	1.8 G60			04.90	07.92						
	1.8 GTI			08.86	07.92						
	1.8 GTI 16V			02.86	07.92						
	1.8 Rallye			04.89	07.92						
	1.8 Syncro			02.86	07.92						
	1.8 Syncro G60			04.89	07.92						
	1.8 GT			08.85	07.88	- ABS/ - Special 3)	24.3364-1605.5	240011	☐	D=36, - Halter	TRW
	1.8 GTI			01.84	07.88	- ABS	24.3364-1606.5	240012	☐	D=36, - Halter	TRW
	1.8 GTI 16V			02.86	07.88	- ABS	24.0101-3601.2	260044		Bremssattel-Zubehör	TRW
						11.0101-5403.2	260010		Faltenbalgsatz	TRW	
1.8	62	19-JH480001		07.88	+ ABS	24.3384-1603.5	240015	☐	D=38, - Halter	TRW	
1.8	66	19-JH480001		07.88	+ ABS	24.3384-1604.5	240016	☐	D=38, - Halter	TRW	
1.8 GT		19-JH480001		07.88	+ ABS/ - Special 4)	24.0101-3601.2	260044		Bremssattel-Zubehör	TRW	
1.8 GTI		19-JH480001		07.88	+ ABS						
1.8 GTI 16V		19-JH480001		07.88	+ ABS						
1.8 Rallye			1G-LW330000	04.89							
1.8 Rallye			1G-LB085000	04.89							
1.8 Syncro G60			1G-LW330000	04.89							
1.8 Syncro G60			1G-LB085000	04.89							
1.8	62		08.88	07.89	+ ABS	24.3364-1605.5	240011	☐	D=36, - Halter	TRW	
1.8	66		08.88	07.89	+ ABS	24.3364-1606.5	240012	☐	D=36, - Halter	TRW	
1.8 GT			08.88	07.89	- Special 5)	24.0101-3601.2	260044		Bremssattel-Zubehör	TRW	
1.8 GTI			08.88	07.89		11.0101-5403.2	260010		Faltenbalgsatz	TRW	
1.8 GTI 16V			08.88	07.89							
1.8	62		08.89	07.92	+ ABS	24.3384-1603.5	240015	☐	D=38, - Halter	TRW	
1.8	66		08.89	07.92	+ ABS	24.3384-1604.5	240016	☐	D=38, - Halter	TRW	
1.8 G60			04.90	07.92		24.0101-3601.2	260044		Bremssattel-Zubehör	TRW	
1.8 GT			08.89	07.92							
1.8 GT Special			08.85	07.92							
1.8 GTI			08.89	07.92							

1) + manual transmission / + scatola cambio velocità / + transmission mécanique / + cambio de velocidad
 2) + autom.transmission / + scatola cambio automatico / + transmission automatique / + cambio automático
 3) - ABS/ - Special / - ABS/ - Speciale / - ABS/ - Spécial / - ABS/ - Especial
 4) + ABS/ - Special / + ABS/ - Speciale / + ABS/ - Spécial / + ABS/ - Especial
 5) - Special / - Speciale / - Spécial / - Especial



VOLKSWAGEN GOLF II (84-93)

	1.8 GTI 16V 1.8 Rallye 1.8 Rallye 1.8 Syncro G60 1.8 Syncro G60	1G-LB085001 1G-LW330001 1G-LB085001 1G-LW330001		08.89 07.92 07.92 07.92 07.92	24.3384-1603.5 24.3384-1604.5 24.0101-3601.2	240015 240016 260044		D=38, - Halter D=38, - Halter Bremsattel-Zubehör	TRW TRW TRW
	1.8 1.8 1.8 G60 1.8 GT 1.8 GT Special 1.8 GTI 1.8 GTI 16V 1.8 Rallye 1.8 Syncro G60	62 19-JH480001 66 19-JH480001		07.92 + ABS 07.92 + ABS 04.90 07.92 08.85 07.92 08.85 07.92 01.84 07.92 02.86 07.92 04.89 07.92 04.89 07.92	13.0460-2937.2 13.0460-0419.2	602937 610419		20961 15,2 /Zub/S Belagsatz-Zubehör	TRW TRW
	1.8 1.8 1.8 G60 1.8 GT 1.8 GT Special 1.8 GTI 1.8 GTI 16V 1.8 Rallye 1.8 Syncro G60	62 19-JH480001 66 19-JH480001		07.92 + ABS 07.92 + ABS 04.90 07.92 08.85 07.92 08.85 07.92 01.84 07.92 02.86 07.92 04.89 07.92 04.89 07.92	24.0110-0111.1 24.0110-0275.2	410111 410275	ohne Sensorring ¹⁾ mit Sensorring ²⁾	226 10,0 8,0 +B 226 10,0 8,0 +B	
	1.0 1.3 1.6 1.6 D 1.6 TD 1.8 1.8 1.8 Rallye 1.8 Syncro G60	62 66		08.83 07.88 08.83 07.88 08.83 07.88 08.83 07.88 01.84 07.88 - ABS 01.84 07.88 - ABS 04.89 07.92 04.89 07.92	24.5204-0180.3	331461	2	L=180	
	1.0 1.3 1.6 1.6 D 1.6 TD 1.8 1.8	62 66		08.88 10.91 08.88 12.93 08.88 12.93 08.88 07.92 08.88 12.93 08.88 07.92 - ABS 08.88 07.92 - ABS	24.5201-0164.3	331414	2	L=164	
	1.8 1.8 1.8 G60 1.8 GT 1.8 GTI 1.8 GTI 16V 1.8 Syncro	62 19-JH480001 66 19-JH480001		07.92 + ABS 07.92 + ABS 04.90 07.92 08.85 07.92 01.84 07.92 02.86 07.92 08.85 07.92	24.5170-0161.3	331308	2	L=161	
	1.0 1.3 1.6 1.6 D 1.6 TD 1.8 1.8 1.8 G60 1.8 GTI 1.8 GTI 16V	1G-M-000001 1G-M-000001 1G-M-000001 1G-M-000001 1G-M-000001 1G-M-000001 1G-M-000001 1G-M-000001 1G-M-000001 1G-M-000001		10.91 12.93 12.93 07.92 12.93 07.92 07.92 07.92 07.92 07.92	24.0721-1925.1	360039	2	Radsensor L=1220	
	1.0 1.3 1.6 1.6 D 1.6 TD 1.8 1.8 1.8 1.8 1.8 1.8 1.8 Syncro	62 66 77	1G-KW593279	08.83 10.91 - Bremskraftregler ³⁾ 08.83 12.93 - Bremskraftregler ³⁾ 08.83 12.93 - Bremskraftregler ³⁾ 08.83 07.92 - Bremskraftregler ³⁾ 08.83 12.93 - Bremskraftregler ³⁾ 01.84 07.92 - Bremskraftregler ³⁾ 01.84 07.92 - Bremskraftregler ³⁾ 08.88 +	03.3214-0812.3 24.3214-0902.3	020011 020147	+ GG ⁴⁾ + ALU ⁵⁾	Rz 14,29 Rz 14,29	
	1.0 1.3 1.6 1.6 D 1.6 TD 1.8 1.8 1.8 1.8 1.8 Syncro	62 66 77	1G-KW593280	08.83 10.91 + Bremskraftregler ⁶⁾ 08.83 12.93 + Bremskraftregler ⁶⁾ 08.83 12.93 + Bremskraftregler ⁶⁾ 08.83 07.92 + Bremskraftregler ⁶⁾ 08.83 12.93 + Bremskraftregler ⁶⁾ 01.84 07.92 + Bremskraftregler ⁶⁾ 01.84 07.92 + Bremskraftregler ⁶⁾ 07.92 +	03.3217-2112.3 24.3217-0908.3	020027 020167	+ GG ⁴⁾ + ALU ⁵⁾	Rz 17,46 Rz 17,46	
	1.0 1.3 1.6 1.6 D 1.6 TD 1.8 1.8 1.8 1.8 1.8 1.8 1.8 Syncro	62 66 77		08.83 10.91 08.83 12.93 08.83 12.93 08.83 07.92 08.83 12.93 01.84 07.92 - ABS 01.84 07.92 - ABS 08.88 07.92 - ABS +	03.0137-0126.2 03.0137-9008.2	650126 669008		180 x 31 HEB Bremsbacken-Zubehör	
	1.6 TD 1.8 1.8 Syncro	77		08.89 12.93 + 08.88 07.92 + ABS +	03.0137-0268.2 03.0137-9168.2	650268 669168		200 x 40 HEB Bremsbacken-Zubehör	VW VW
	1.8 Syncro			08.85 07.92	03.0137-0264.2	650264		230 x 40 HEB	VW

¹⁾ without sensor ring / senza sensori / sans secours ABS / sin anillo sensor ABS
²⁾ with sensor ring / con sensori / avec secours ABS / con anillo sensor ABS
³⁾ - brake pressure regulator / - correttore di frenata / - correcteur de freinage / - corrector de frenado
⁴⁾ + cast iron / + ghisa / + fonte grise / + fundición de gris
⁵⁾ + aluminium / + alluminio / + aluminium / + aluminio
⁶⁾ + brake pressure regulator / + correttore di frenata / + correcteur de freinage / + corrector de frenado



VOLKSWAGEN GOLF II (84-93)												
	1.0			08.83	10.91		24.0218-0007.1	480003		180/181 x 38,5 - Lager		
	1.3			08.83	12.93		24.0218-0707.2	480211		180/181 x 38,5 + Lager		
	1.6			08.83	12.93							
	1.6 D			08.83	07.92							
	1.6 TD			08.83	12.93	- ①						
	1.8	62		01.84	07.92	- ABS						
	1.8	66		01.84	07.92	- ABS						
	1.8	77		08.88	07.92	- ABS + ①						
	1.6 TD			08.89	12.93	+ ①	24.0220-0018.1	480019		ohne Sensorring 1)	200/201 x 50 - Lager	
	1.8	77		08.88	07.92	+ ABS + ①	24.0220-0718.2	480209		ohne Sensorring 1)	200/201 x 50 + Lager	
1.8 Syncro			08.85	07.92		24.0223-0017.1	480135			230/231,5 x 48,5		
	1.0			08.83	10.91	- Bremskraftregler/ - ① 2)	03.0520-0114.3	690114		14,29/180x31 TopKit	VW	
	1.3			08.83	12.93	- Bremskraftregler/ - ① 2)						
	1.6			08.83	12.93	- Bremskraftregler/ - ① 2)						
	1.6 D			08.83	07.92	- Bremskraftregler/ - ① 2)						
	1.6 TD			08.83	12.93	- Bremskraftregler/ - ① 2)						
	1.8	62		01.84	07.92	- Bremskraftregler/ - ① 2)						
	1.8	66		01.84	07.92	- Bremskraftregler/ - ① 2)						
	1.0			08.83	10.91	+ Bremskraftregler/ - ① 3)	03.0420-0617.3	680617	+ Rz GG 4)	17,46/180x31 Kit	VW	
	1.3			08.83	12.93	+ Bremskraftregler/ - ① 3)	03.0520-3917.3	693917	+ Rz ALU 5)	17,46/180x31 TopKit	VW	
	1.6			08.83	12.93	+ Bremskraftregler/ - ① 3)						
	1.6 D			08.83	07.92	+ Bremskraftregler/ - ① 3)						
	1.6 TD			08.83	12.93	+ Bremskraftregler/ - ① 3)						
	1.8	62		01.84	07.92	+ Bremskraftregler/ - ① 3)						
	1.8	66		01.84	07.92	+ Bremskraftregler/ - ① 3)						
	1.6 TD			08.89	12.93		03.0420-1517.3	681517		17,46/200x40 Kit	VW	
	1.8	77	1G-KW593280	07.92	07.92		03.0520-1517.3	691517		17,46/200x40 TopKit	VW	
		1.0			08.83	07.88		24.3727-0118.2	580118	2 ②	L=1748	
		1.3			08.83	07.88						
1.6				08.83	07.88							
1.6 D				08.83	07.88							
1.6 TD				08.83	07.88							
1.8		62		01.84	07.88	- ABS						
1.8		66		01.84	07.88	- ABS						
1.0				08.88	10.91		24.3727-0132.2	580132	2 ②	L=1527		
1.3				08.88	12.93							
1.6				08.88	12.93							
1.6 D				08.88	07.92							
1.6 TD				08.88	12.93							
1.8		62		08.88	07.92	- ABS						
1.8		66		08.88	07.92	- ABS						
1.8 GT				08.85	07.88	- ABS	24.3727-0123.2	580123	2 ②	L=1800		
1.8 GTI				01.84	07.88	- ABS						
1.8 GTI 16V				02.86	07.88	- ABS						
1.8			19-JH480001		07.88	+ ABS	24.3727-0124.2	580124	2 ②	L=1840		
1.8 GT		19-JH480001		07.88	+ ABS							
1.8 GTI		19-JH480001		07.88	+ ABS							
1.8 GTI 16V		19-JH480001		07.88	+ ABS							
1.8			08.88	07.92	+ ABS	24.3727-0133.2	580133	2 ②	L=1622			
1.8 GT			08.88	07.92								
1.8 GTI			08.88	07.92								
1.8 GTI 16V			08.88	07.92								
1.8 Syncro			08.85	07.92		24.3727-0166.2	580166	2 ②	L=1567			
1.8 G60			04.90	07.92		24.3727-0134.2	580134	2 ②	L=1613			
	1.0			08.83	10.91		03.6584-0015.3	320109		BRL 8/4 (4)	ATE	
	1.3			08.83	12.93							
	1.6			08.83	12.93							
	1.6 D			08.83	07.92							
	1.6 TD			08.83	12.93							
	1.8			08.83	07.92							
	1.8 G60			08.89	07.92							
	1.8 GTI			01.84	07.92							
	1.8 GTI 16V			02.86	07.92							
	1.8 Rallye			04.89	07.92							
	1.8 Syncro			04.89	07.92							
	1.8 Syncro G60			04.89	07.92							
	1.8 G60			04.90	07.92		03.2419-9310.3	030027		Gz 19,05		
	1.8 GTI			08.89	07.92							
	1.8 GTI 16V			08.89	07.92							
	1.8 Rallye			04.89	07.92							
	1.8 Syncro G60			04.89	07.92							
	1.8 G60			04.90	07.92		24.2523-0908.3	040049		Nz 23,81		
	1.8 GTI			08.89	07.92							
	1.8 GTI 16V			08.89	07.92							
	1.8 Rallye			04.89	07.92							
	1.8 Syncro G60			04.89	07.92							
	1.0			08.83	10.91		24.3728-0113.2	590113	- autom. Nachstellung 6)	L=1098		
	1.3			08.83	12.93							
	1.6			08.83	12.93		24.3728-0111.2	590111	- autom. Nachstellung 6)	L=806		
	1.8			08.83	07.92							
	1.6			08.83	12.93		24.3728-0121.2	590121	+ autom. Nachstellung 7)	L=800, + AUT		
	1.6 D			08.83	07.92							
1.6 TD		51	08.83	12.93								
1.8			08.83	07.92								

1) without sensor ring / senza sensori / sans secours ABS / sin anillo sensor ABS

2) - brake pressure regulator/ - ① / - correttore di frenata/ - ① / - correcteur de freinage/ - ① / - corrector de frenada/ - ①

3) + brake pressure regulator/ - ① / + correttore di frenata/ - ① / + correcteur de freinage/ - ① / + corrector de frenada/ - ①

4) + WC cast iron / + CR ghisa / + CR fontegrise / + CR fundición de gris

5) + WC aluminium / + CR alluminio / + CR aluminium / + CR aluminio

6) - automatic adjustment / - correzione automatica / - ajustage automatique / - reajuste automático

7) + automatic adjustment / + correzione automatica / + ajustage automatique / + reajuste automático



VOLKSWAGEN GOLF II (84-93)

	1.6 TD	59	04.89	12.93	24.3728-0120.2	590120		L=1081, + AUT
	1.8 G60		08.89	07.92	24.3728-0111.2	590111	- autom. Nachstellung ¹⁾	L=806
	1.8 GTI 16V		02.86	07.92	24.3728-0121.2	590121	+ autom. Nachstellung ²⁾	L=800, + AUT
	1.8 Syncro		08.85	07.92				

VOLKSWAGEN GOLF III (92-97)

	1.4		11.91	08.97	- ABS	03.7750-5502.4	300081	9"	ATE
	1.6		09.92	08.97	- ABS				
	1.8		11.91	08.97	- ABS				
	1.8 Syncro		01.93	08.97	- ABS				
	1.9 D		11.91	08.97	- ABS				
	1.9 D Ecomatic		08.93	07.95	- ABS				
	1.9 SDI		07.95	08.97	- ABS				
	1.9 TD	55	11.91	08.97	- ABS				
	1.9 TDI	66	10.93	08.97	- ABS				
	1.9 TDI	81	02.96	08.97	- ABS				
	1.9 TDI Syncro	66	03.95	08.97	- ABS				
	2.0	85	11.91	08.97	- ABS				
	2.0 GL	79	11.91	08.97	- ABS				
	2.0 GTI 16V	110	08.92	08.97	- ABS				
	2.0 Syncro		07.95	08.97	- ABS				
	2.8 VR6		01.92	08.97	- ABS				
	1.4		1H-S-088704	11.91	+ ABS	10.6360-1003.4	300156	10"	ATE
	1.6	55	1H-S-088704	09.92	+ ABS				
	1.6	74	1H-S-088704	07.94	+ ABS				
	1.8		1H-S-088704	11.91	+ ABS				
	1.8 GT		1H-S-088704	11.91	+ ABS				
	1.8 Syncro		1H-S-088704	01.93	+ ABS				
	1.9 D		1H-S-088704	11.91	+ ABS				
	1.9 D Ecomatic		1H-S-088704	08.93	+ ABS				
	1.9 TD	55	1H-S-088704	11.91	+ ABS				
	1.9 TDI	66	1H-S-088704	10.93	+ ABS				
	2.0 GL	79	1H-S-088704	11.91	+ ABS				
	2.0 GTI 16V	110	1H-S-088704	08.92	+ ABS				
	2.8 VR6		1H-S-088704	01.92	+ ABS				
	2.9 VR6 Syncro		1H-S-088704	10.94	+ ABS				
	1.4		1H-S-088705	08.97	+ ABS	10.6360-2002.4	300143	10"	ATE
	1.6	55	1H-S-088705	09.92	+ ABS				
	1.6	74	1H-S-088705	08.97	+ ABS				
	1.8		1H-S-088705	08.97	+ ABS				
	1.8 GT		1H-S-088705	08.97	+ ABS				
	1.8 Syncro		1H-S-088705	08.97	+ ABS				
	1.9 D		1H-S-088705	08.97	+ ABS				
	1.9 D Ecomatic		1H-S-088705	07.95	+ ABS				
	1.9 SDI		07.95	08.97	+ ABS				
	1.9 TD	55	1H-S-088705	08.97	+ ABS				
	1.9 TDI	66	1H-S-088705	08.97	+ ABS				
	1.9 TDI	81	02.96	08.97	+ ABS				
	1.9 TDI Syncro	66	03.95	08.97	+ ABS				
	2.0 GL	79	1H-S-088705	08.97	+ ABS				
	2.0 GTI 16V	110	1H-S-088705	08.97	+ ABS				
	2.0 Syncro		07.95	08.97	+ ABS				
	2.8 VR6		1H-S-088705	08.97	+ ABS				
	2.9 VR6 Syncro		1H-S-088705	08.97	+ ABS				
	1.4		11.91	08.97	- ABS	03.2120-3943.3	010532	THz 20,64	ATE
	1.6	55	09.92	08.97	- ABS	03.3517-0101.2	390322	Verschlußschraube	
	1.8		11.91	08.97	- ABS/ - GT				
	1.9 D		11.91	08.97	- ABS				
	1.9 D Ecomatic		08.93	07.95	- ABS				
	1.9 SDI		07.95	08.97	- ABS				
	1.9 TD	55	11.91	08.97	- ABS				
	1.6	74	07.94	08.97	- ABS	03.2122-1042.3	010137	THz 22,20	ATE
	1.8 GT		11.91	08.97	- ABS	03.3517-0101.2	390322	Verschlußschraube	
	1.8 Syncro		01.93	08.97	- ABS				
	1.9 TDI	66	10.93	08.97	- ABS				
	1.9 TDI	81	02.96	08.97	- ABS				
	1.9 TDI Syncro	66	03.95	08.97	- ABS				
	2.0	85	11.91	08.97	- ABS				
	2.0 GL	79	11.91	08.97	- ABS				
	2.0 GTI 16V	110	08.92	08.97	- ABS				
	2.0 Syncro		07.95	08.97	- ABS				
	1.4		1H-S-088705	08.97	+ ABS	03.2122-1144.3	010636	THz 22,20	ATE
	1.6	55	1H-S-088705	08.97	+ ABS				
	1.8		1H-S-088705	08.97	+ ABS/ - GT				
	1.9 D		1H-S-088705	08.97	+ ABS				
	1.9 D Ecomatic		1H-S-088705	07.95	+ ABS				
	1.9 SDI		07.95	08.97	+ ABS				
	1.9 TD	55	1H-S-088705	08.97	+ ABS				
	Citystromer	20	11.94	08.97	+ ABS				
	1.6	74	1H-S-088704	07.94	+ ABS	10.6123-0674.3	010639	THz 23,81	ATE
	1.8 GT		1H-S-088704	11.91	+ ABS				
	1.9 TDI	66	1H-S-088704	10.93	+ ABS				
	2.0 GL	79	1H-S-088704	11.91	+ ABS				
	2.0 GTI 16V	110	1H-S-088704	08.92	+ ABS				
	2.8 VR6		1H-S-088704	01.92	+ ABS				
	2.9 VR6 Syncro		1H-S-088704	10.94	+ ABS				

¹⁾ - automatic adjustment / - correzione automatica / - ajustage automatique / - reajuste automático

²⁾ + automatic adjustment / + correzione automatica / + ajustage automatique / + reajuste automático





VOLKSWAGEN GOLF III (92-97)

	1.6	74	1H-S-088705		08.97	+ ABS	03.2123-1424.3	010637		Thz 23,81	ATE		
	1.8 GT		1H-S-088705		08.97	+ ABS							
	1.8 Syncro		1H-S-088705		08.97	+ ABS							
	1.9 TDI	66	1H-S-088705		08.97	+ ABS							
	1.9 TDI	81			02.96	08.97	+ ABS						
	1.9 TDI Syncro	66			03.95	08.97	+ ABS						
	2.0 GL	79	1H-S-088705		08.97	+ ABS							
	2.0 GTI 16V	110	1H-S-088705		08.97	+ ABS							
	2.0 Syncro				07.95	08.97	+ ABS						
	2.8 VR6		1H-S-088705		08.97	+ ABS							
2.9 VR6 Syncro		1H-S-088705		08.97	+ ABS								
	1.4		1H-S-088705		08.97	+ ABS	03.2122-1184.3	010592		Thz 22,20	ATE		
	1.6	55	1H-S-088705		08.97	+ ABS							
	1.8		1H-S-088705		08.97	+ ABS/ - GT							
	1.9 D		1H-S-088705		08.97	+ ABS							
	1.9 SDI				07.95	08.97	+ ABS						
	1.9 TD	55	1H-S-088705		08.97	+ ABS							
		1.6	74	1H-S-088705		08.97	+ ABS	03.2123-1484.3	010595		Thz 23,81	ATE	
		1.8 GT		1H-S-088705		08.97	+ ABS						
		1.9 TDI	66	1H-S-088705		08.97	+ ABS						
		1.9 TDI	81			02.96	08.97	+ ABS					
2.0 GL		79	1H-S-088705		08.97	+ ABS							
2.0 GTI 16V		110	1H-S-088705		08.97	+ ABS							
2.8 VR6			1H-S-088705		08.97	+ ABS							
		1.4	55	1H-T-028354	11.91			11.0441-4808.2	250022		Dichtungssatz	ATE	
		1.6		1H-T-028354	09.92			11.0101-4801.2	260006		Hülsensatz	ATE	
		1.8		1H-T-028354	11.91		- GT/ + Schaltgetriebe ¹⁾	24.0102-4801.2	260085		Hülsensatz+Schrauben	ATE	
	1.8		1H-S-246940	11.91		- GT/ + Automatikgetriebe ²⁾							
	1.8 Syncro		1H-S-089450	01.93									
	1.9 D		1H-T-028354	11.91									
	1.9 D Ecomatic		1H-S-246940	08.93									
	1.9 SDI		1H-T-028354	07.95									
	1.9 TD	55	1H-T-028354	11.91									
		1.4	55	1H-T-028355		08.97	- ABS	11.0441-4808.2	250022		Dichtungssatz	ATE	
1.6			1H-T-028355		08.97	- ABS	11.0101-4801.2	260006		Hülsensatz	ATE		
1.8			1H-T-028355		08.97	- ABS/ - GT/+ Schaltgetriebe ³⁾	24.0102-4801.2	260085		Hülsensatz+Schrauben	ATE		
1.9 D			1H-T-028355		08.97	- ABS							
1.9 SDI			1H-T-028355		08.97	- ABS							
1.9 TD		55	1H-T-028355		08.97	- ABS							
		1.6 CL/GL	74			07.94	08.97	- ABS	24.3541-1739.5	240223	<input type="checkbox"/>	D=54, - Halter	TRW
		1.8		1H-S-246941		08.97	- ABS/ - GT/ + Automatikgetriebe ⁴⁾	24.3541-1740.5	240224	<input type="checkbox"/>	D=54, - Halter	TRW	
		1.8 Syncro		1H-S-089451		08.97		11.0101-5403.2	260010	<input type="checkbox"/>	Faltenbalgsatz	TRW	
		1.9 TDI	66			10.93	04.96						
	1.9 TDI Syncro	66			03.95	04.96							
	1.4	55			05.96	09.96	+ ABS	24.3541-1609.5	240039	<input type="checkbox"/>	D=54, - Halter	TRW	
	1.6	74			05.96	09.96	+ ABS	24.3541-1610.5	240040	<input type="checkbox"/>	D=54, - Halter	TRW	
	1.6 GT				07.94	08.97		24.0101-4301.2	260047	<input type="checkbox"/>	Bremssattel-Zubehör	TRW	
	1.8				05.96	08.97	+ ABS	11.0101-5403.2	260010	<input type="checkbox"/>	Faltenbalgsatz	TRW	
	1.8 GT				11.91	08.97							
1.9 D				05.96	09.96	+ ABS							
1.9 D Ecomatic		1H-S-246941		07.95	07.95								
1.9 SDI				05.96	09.96	+ ABS							
1.9 TD	55			05.96	09.96	+ ABS							
1.9 TDI	66			05.96	08.97								
1.9 TDI	81			02.96	08.97								
1.9 TDI Syncro	66			05.96	08.97								
2.0 GL	79			11.91	08.97								
2.0 Syncro				07.95	08.97								
	1.4	55			10.96	08.97	+ ABS	11.0441-4808.2	250022		Dichtungssatz	ATE	
	1.6				10.96	08.97	+ ABS	11.0101-4801.2	260006		Hülsensatz	ATE	
	1.9 D				10.96	08.97	+ ABS	24.0102-4801.2	260085		Hülsensatz+Schrauben	ATE	
	1.9 SDI				10.96	08.97	+ ABS						
	1.9 TD	55			10.96	08.97	+ ABS						
	2.0	85			11.91	04.96		24.3541-1731.5	240061	<input type="checkbox"/>	D=54, - Halter	TRW	
	2.0 GTI 16V	110			08.92	04.96		24.3541-1732.5	240062	<input type="checkbox"/>	D=54, - Halter	TRW	
	2.8 VR6		1H-S-399999	01.92				24.0101-4301.2	260047	<input type="checkbox"/>	Bremssattel-Zubehör	TRW	
	2.0	85			05.96	08.97		24.3541-8523.5	240551	<input type="checkbox"/>	D=54, - Halter	ATE	
	2.0 GTI 16V	110			05.96	08.97		24.3541-8524.5	240552	<input type="checkbox"/>	D=54, - Halter	ATE	
2.8 VR6		1H-S-400001		08.97			11.8170-0306.1	260102	2	Halter	ATE		
2.9 VR6 Syncro				10.94	08.97		11.0441-5409.2	250031		Dichtungssatz	ATE		
							11.0101-5409.2	260035		Hülsensatz	ATE		
							11.8171-0008.1	990049		Führungsbolzen	ATE		
							11.8116-0143.1	390513	2	Haltefeder	ATE		
	1.4	55	1H-T-028354	11.91			13.0460-7032.2	607032		20887 19,7 +/Zub	VW		
	1.6		1H-T-028354	09.92									
	1.8 CL/GL		1H-T-028354	11.91		+ Schaltgetriebe ⁶⁾							
	1.8 CL/GL		1H-S-246940	11.91		+ Automatikgetriebe ⁷⁾							
	1.8 Syncro		1H-S-089450	01.93		- ABS							
	1.9 D		1H-T-028354	11.91									
	1.9 D Ecomatic		1H-S-246940	08.93									
	1.9 SDI		1H-T-028354	07.95									
	1.9 TD	55	1H-T-028354	11.91									
		1.4		1H-T-028355		08.97	- ABS	13.0460-7072.2	607072		21866 19,7 +	VW	
1.6		55	1H-T-028355		08.97	- ABS							
1.8 CL/GL			1H-T-028355		08.97	- ABS/ + Schaltgetriebe ⁸⁾							
1.9 D			1H-T-028355		08.97	- ABS							

1) - GT/ + manual transm. / - GT/+ scatola cambio velocità / - GT/ + transmission mécanique / - GT/ + cambio de velocidad
2) - GT/ + autom.transmission / - GT/+ scatola cambio autom. / - GT/ + transmission automatique / - GT/ + cambio automático
3) - ABS/ - GT/ + manual transm. / - ABS/- GT/+ scatola camb.velocità / - ABS/ - GT/ + transmiss. mécanique / - ABS/ - GT/ + cambio de velocidad
4) - ABS/ - GT/ + autom.transm. / - ABS/- GT/+ scatola camb.autom. / - ABS/ - GT/ + transmiss. automatique / - ABS/ - GT/ + cambio automático
5) - red caliper / - pinza rossa / - étrier rouge / - pinza roja
6) + manual transmission / + scatola cambio velocità / + transmission mécanique / + cambio de velocidad
7) + autom.transmission / + scatola cambio automatico / + transmission automatique / + cambio automático
8) - ABS/ + manual transmission / - ABS/+ scatola camb.velocità / - ABS/ + transmission mécanique / - ABS/ + cambio de velocidad



VOLKSWAGEN GOLF III (92-97)												
	1.9 SDI	55	1H-T-028355		08.97	- ABS	13.0460-7072.2	607072		21866 19,7 +	VW	
	1.9 TD		1H-T-028355		08.97	- ABS						
	2.0	85		1H-S-560000	11.91		13.0460-2806.2	602806		20168 19,3 +WK/S	TRW	
	2.0 GTI 16V	110		1H-S-560000	08.92							
	2.8 VR6			1H-S-399999	01.92							
	1.6 CL/GL	74			07.94	08.97 - ABS	13.0460-2958.2	602958		20168 19,3 /S	TRW	
	1.8 CL/GL			1H-S-246941		08.97 - ABS						
	1.8 Syncro			1H-S-089451		08.97 - ABS						
	1.9 TDI	66			10.93	04.96						
	1.9 TDI	81			02.96	04.96 + roter Sattel 1)						
	1.9 TDI Syncro	66			03.95	04.96						
	2.0	85		1H-S-560001		04.96						
	2.0 GTI 16V	110		1H-S-560001		04.96						
		1.9 TDI	81			05.96	08.97 + roter Sattel 1)	13.0460-7081.2	607081		21911 20,3 +	ATE
2.0		85			05.96	08.97	13.0470-7081.2	LD7081		21911 20,3 +	ATE	
2.0 GTI 16V		110			05.96	08.97						
2.8 VR6				1H-S-400001		08.97						
2.9 VR6 Syncro					10.94	08.97						
1.4					05.96	09.96 + ABS	13.0460-2821.2	602821		21945 16,0 /S	TRW	
1.6		55			05.96	09.96 + ABS						
1.6 GT		74			07.94	08.97						
1.8					05.96	08.97 + ABS						
1.8 GT					11.91	08.97						
1.8 Syncro					01.93	08.97 + ABS						
1.9 D					05.96	09.96 + ABS						
1.9 D Ecomatic				1H-S-246941		07.95						
1.9 SDI					05.96	09.96 + ABS						
1.9 TD	55			05.96	09.96 + ABS							
1.9 TDI	66			05.96	08.97							
1.9 TDI	81			02.96	08.97 - roter Sattel 2)							
1.9 TDI Syncro	66			05.96	08.97							
2.0 GL	79			11.91	08.97							
2.0 Syncro				07.95	08.97							
	1.4				10.96	08.97 + ABS	13.0460-7101.2	607101		21866 15,3 +	VW	
	1.6	55			10.96	08.97 + ABS						
	1.9 D				10.96	08.97 + ABS						
	1.9 SDI				10.96	08.97 + ABS						
	1.9 TD	55			10.96	08.97 + ABS						
		1.4				11.91	08.97 - ABS	24.0112-0106.1	412106		239 12,0 10,0 +S +B	
		1.6	55			09.92	08.97 - ABS	24.0312-0106.1	512106		239 12,0 10,0 +S +B PD	
		1.8			1H-S-246940	11.91	- ABS/ - GT/+ Automatikgetriebe 3)					
		1.8				11.91	- ABS/ - GT/+ Schaltgetriebe 4)					
		1.8 Syncro			1H-S-089450	01.93	- ABS					
		1.9 D				11.91	08.97 - ABS					
		1.9 D Ecomatic			1H-S-246940	11.91						
		1.9 SDI				07.95	08.97 - ABS					
		1.9 TD	55			11.91	08.97 - ABS					
1.6 CL/GL		74			07.94	08.97 - ABS	24.0113-0178.1	413178		256 12,9 11,0 +S +B		
1.8				1H-S-246941		08.97 - ABS/ + Automatikgetriebe 5)	24.0313-0178.1	513178		256 12,9 11,0 +S +B PD		
1.8 Syncro				1H-S-089451		08.97 - ABS						
1.9 TDI		66			10.93	04.96						
1.9 TDI Syncro		66			03.95	04.96						
	1.4				05.96	09.96 + ABS	24.0120-0128.1	420128	für 4-Loch-Felge 6)	256 20,0 18,0 V L +S +B		
	1.6	55			05.96	09.96 + ABS	24.0320-0128.1	520128	für 4-Loch-Felge 6)	256 20,0 18,0 V L +S +B PD		
	1.6 GT	74			07.94	08.97						
	1.8				05.96	08.97 + ABS						
	1.8 GT				11.91	08.97 + ABS						
	1.8 Syncro				01.93	08.97 + ABS						
	1.9 D				05.96	09.96 + ABS						
	1.9 D Ecomatic			1H-S-246941		07.95						
	1.9 SDI				05.96	09.96 + ABS						
	1.9 TD	55			05.96	09.96 + ABS						
	1.9 TDI	66			05.96	08.97						
	1.9 TDI	81			02.96	08.97 - roter Sattel 2)						
	1.9 TDI Syncro	66			05.96	08.97						
	2.0 GL	79			11.91	08.97						
2.0 Syncro				07.95	08.97							
	1.4				10.96	08.97 + ABS	24.0120-0123.1	420123		239 20,0 18,0 V L +S +B		
	1.6	55			10.96	08.97 + ABS	24.0320-0123.1	520123		239 20,0 18,0 V L +S +B PD		
	1.9 D				10.96	08.97 + ABS						
	1.9 SDI				10.96	08.97 + ABS						
	1.9 TD	55			10.96	08.97 + ABS						
	1.9 TDI	81			02.96	04.96 + roter Sattel 1)	24.0122-0100.1	422100	für 5-Loch-Felge 7)	280 22,0 20,0 V L +B		
	2.0	85			11.91	04.96	24.0322-0100.1	522100	für 5-Loch-Felge 7)	280 22,0 20,0 V L +B PD		
	2.0 GTI 16V	110			08.92	04.96						
	2.8 VR6			1H-S-399999	01.92							
	1.9 TDI	81			05.96	08.97 + roter Sattel 1)	24.0125-0108.1	425108		288 25,0 23,0 V L +B		
	2.0	85			05.96	08.97						
	2.0 GTI 16V	110			05.96	08.97						
	2.8 VR6			1H-S-400001		08.97						
	2.9 VR6 Syncro				10.94	08.97						
	1.4				11.91	08.97	24.5105-0442.3	331432	2	L=442		
	1.6				09.92	08.97						
	1.8				11.91	08.97						
	1.8 Syncro				01.93	08.97						

1) + red caliper / + pinza rossa / + étrier rouge / + pinza roja

2) - red caliper / - pinza rossa / - étrier rouge / - pinza roja

3) - ABS/ - GT/ + autom.transm. / - ABS/ - GT/+ scatola camb.autom. / - ABS/ - GT/ + transmiss. automatique / - ABS/ - GT/ + cambio automático

4) - ABS/ - GT/ + manual transm. / - ABS/ - GT/+ scatola camb.velocità / - ABS/ - GT/ + transmiss. mécanique / - ABS/ - GT/ + cambio de velocidad

5) - ABS/ + autom.transmission / - ABS/ + scatola cambio autom. / - ABS/ + transmission automatique / - ABS/ + cambio automático

6) for 4 bore wheel rim / per cerchione a 4 fori / pour jante à 4 trous / para Liantas de 4 taladros

7) for 5 bore wheel rim / per cerchione a 5 fori / pour jante à 5 trous / para Liantas de 5 taladros

VOLKSWAGEN GOLF III (92-97)										
	1.9 D			11.91	08.97	24.5105-0442.3	331432	2		L=442
	1.9 D Ecomatic			08.93	07.95					
	1.9 SDI			07.95	08.97					
	1.9 TD	55		11.91	08.97					
	1.9 TDI	66		10.93	08.97					
	1.9 TDI	81		02.96	08.97					
	1.9 TDI Syncro	66		03.95	08.97					
	2.0 GL	79		11.91	08.97					
	2.0 Syncro			07.95	08.97					
	2.8 VR6			01.92	02.95					
2.9 VR6 Syncro			10.94	02.95						
Citystromer	20		11.94	08.97						
2.8 VR6			03.95	08.97	83.6232-0465.3	330736	2		L=465	
2.9 VR6 Syncro			03.95	08.97						
	1.4			11.91	08.97	24.0711-1361.3	360022	☐		Radsensor
	1.6			09.92	08.97					
	1.8			11.91	08.97					
	1.8 Syncro			01.93	08.97					
	1.9 D			11.91	08.97					
	1.9 D Ecomatic			08.93	07.95					
	1.9 SDI			07.95	08.97					
	1.9 TD	55		11.91	08.97					
	1.9 TDI	66		10.93	08.97					
	1.9 TDI	81		02.96	08.97					
	1.9 TDI Syncro	66		03.95	08.97					
	2.0	85		11.91	08.97					
	2.0 GL	79		11.91	08.97					
	2.0 GTI 16V	110		08.92	08.97					
	2.0 Syncro			07.95	08.97					
	2.8 VR6			01.92	08.97					
	2.9 VR6 Syncro			10.94	08.97					
	1.8 GT		1H-P-240000	11.91		24.3384-1603.5	240015	☐		D=38, - Halter
	2.0	85	1H-P-240000	11.91						
	2.8 VR6		1H-P-240000	01.92						
	1.6 GT	74		07.94	06.95					
	1.8 GT	1H-P-240001		06.95						
	2.0	85	1H-P-240001	06.95						
	2.0 GTI 16V	110		08.92	08.97					
	2.8 VR6	1H-P-240001		08.97						
	2.9 VR6 Syncro			10.94	08.97					
	1.6	74		07.95	08.97					
1.8 GT			07.95	08.97						
1.9 TDI	81		02.96	08.97						
2.0	85		07.95	08.97						
	1.8 GT			11.91	08.97	13.0460-2937.2	602937	☐		20961 15,2 /Zub/S
	2.0	85		11.91	08.97					
	2.0 GTI 16V	110	1H-P-240000	11.91						
	2.8 VR6		1H-P-240000	01.92						
	1.6 GT	74		07.94	08.97					
	1.9 TDI	81		02.96	08.97					
	2.0	85	1H-P-240001	08.97						
	2.0 GTI 16V	110	1H-P-240001	08.97						
	2.8 VR6	1H-P-240001		08.97						
	2.9 VR6 Syncro			10.94	08.97					
	1.6 GT	74		07.94	08.97	24.0110-0111.1	410111	☐		für 4-Loch-Felge/- Sensorring ²⁾
	1.8 GT			11.91	08.97					
	1.9 TDI	81		02.96	08.97					
	2.0 GL	79		11.91	08.97					
	1.9 TDI	81		02.96	08.97					
	2.0	85		11.91	08.97					
	2.0 GTI 16V	110		08.92	08.97					
	2.8 VR6			08.92	08.97					
	2.9 VR6 Syncro			01.92	08.97					
		1.4			11.91					
1.6				09.92	08.97					
1.8				11.91	08.97					
1.8 Syncro				01.93	08.97					
1.9 D				11.91	08.97					
1.9 D Ecomatic				08.93	07.95					
1.9 SDI				07.95	08.97					
1.9 TD		55		11.91	08.97					
1.9 TDI		66		10.93	08.97					
1.9 TDI Syncro		66		03.95	08.97					
2.0 Syncro			07.95	08.97						
Citystromer	20		11.94	08.97						
1.6 GT	74		07.94	08.97	83.7836-0135.3	330816	2		L=135	
1.8 GT			11.91	08.97	24.5170-0161.3	331308	2	am Bremssattel ⁶⁾	L=161	
1.9 TDI	81		02.96	08.97						
2.0	85		11.91	08.97						
2.0 GL	79		11.91	08.97						
2.0 GTI 16V	110		08.92	08.97						
2.8 VR6			01.92	08.97						
2.9 VR6 Syncro			10.94	08.97						

¹⁾ - red caliper / - pinza rossa / - étrier rouge / - pinza roja

²⁾ for 4-hole rim/-sensor ring / per cerch.4 fori/-sensore ruota / pour jante 4 trous/-roue codeuse / para llanta cuatro agujeros/-anillo sensor





³⁾ with sensor ring / con sensori / avec secours ABS / con anillo sensor ABS

⁴⁾ + red caliper / + pinza rossa / + étrier rouge / + pinza roja

⁵⁾ for 5 bore wheel rim / per cerchione a 5 fori / pour jante à 5 trous / para Llantas de 5 taladros

⁶⁾ on the brake caliper / sulla pinza freno / sur l'étrier de frein / a la pinza de freno

VOLKSWAGEN GOLF III (92-97)

	1.4 1.6 1.8 1.8 Syncro 1.9 D 1.9 D Ecomatic 1.9 SDI 1.9 TD 1.9 TDI 1.9 TDI 2.0 2.0 GL 2.0 GTI 16V 2.8 VR6 2.9 VR6 Syncro		1H-S-088704 1H-S-088704 1H-S-088704 1H-S-088704 1H-S-088704 1H-S-088704 1H-S-088704 1H-S-088704 1H-S-088704 1H-S-088704 1H-S-088704 1H-S-088704 1H-S-088704	11.91 09.92 11.91 01.93 11.91 08.93 07.95 07.95 11.91 10.93 02.96 11.91 11.91 08.92 01.92 10.94		24.0721-1937.1	360040	2		Radsensor L=1062
	1.4 1.6 1.8 1.9 D 1.9 SDI 1.9 TD 1.9 TDI 1.9 TDI 1.9 TDI Syncro 2.0 2.0 GL 2.0 GTI 16V 2.0 Syncro 2.8 VR6	1H-S-088705 1H-S-088705 1H-S-088705 1H-S-088705 1H-S-088705 55 1H-S-088705 66 1H-S-088705 81 1H-S-088705 66 85 1H-S-088705 79 1H-S-088705 110 1H-S-088705 1H-S-088705		08.97 08.97 08.97 08.97 08.97 08.97 08.97 08.97 03.95 08.97 08.97 08.97 08.97 07.95 08.97		24.0721-1191.3	360091	2		Radsensor L=1043
	1.8 Syncro 2.9 VR6 Syncro	1H-S-088705 1H-S-088705		08.97 08.97		24.0751-1139.3	360295	2		Radsensor L=1051
	1.4 1.8 CL/GL 1.9 D Ecomatic 1.9 TD		1H-S-246940 1H-S-246940	11.91 11.91 08.93 11.91	08.97 + Automatikgetriebe 3)	03.3215-2311.3 24.3215-0903.3	020018 020154		+ GG 1) + ALU 2)	Rz 15,87 Rz 15,87
	1.6 1.6 CL/GL 1.6 CL/GL 1.8 CL/GL 1.8 CL/GL 1.9 D 1.9 D Ecomatic 1.9 SDI 1.9 TDI	55 74 74	1H-S-246940 1H-S-246940	09.92 07.94 07.94 11.91	08.97 + Schaltgetriebe 4) + Automatikgetriebe 3) + Schaltgetriebe 4) + Automatikgetriebe 3)	03.3217-2112.3 24.3217-0908.3	020027 020167		+ GG 1) + ALU 2)	Rz 17,46 Rz 17,46
	1.6 CL/GL 1.8 CL/GL 1.9 D 1.9 D Ecomatic 1.9 SDI 1.9 TDI	74 66	1H-S-246941 1H-S-246941	11.91 08.97 07.95 10.93	08.97 + Automatikgetriebe 3)					
	1.6 CL/GL 1.8 CL/GL	74	1H-S-246941 1H-S-246941	08.97 08.97	+ Schaltgetriebe 4) + Schaltgetriebe 4)	24.3219-0909.3	020188			Rz 19,05
	1.8 Syncro		1H-S-400000	01.93		24.3220-0909.3	020210			Rz 20,64
	1.8 Syncro 1.9 TDI Syncro 2.0 Syncro	66	1H-S-400001	03.95 08.97 07.95	08.97	24.3222-0913.3	020255			Rz 22,20
	1.4 1.6 1.6 CL/GL 1.8 CL/GL 1.9 D 1.9 D Ecomatic 1.9 SDI 1.9 TD 1.9 TDI	55		11.91 09.92 09.92 11.91 11.91 08.93 07.95 11.91 10.93	08.97 08.97 08.97 08.97 08.97 07.95 08.97 08.97	03.0137-0268.2 03.0137-9168.2	650268 669168			200 x 40 HEB Bremsbacken-Zubehör
	1.8 Syncro 1.9 TDI Syncro 2.0 Syncro	66		01.93 03.95 07.95	08.97 08.97 08.97	03.0137-0264.2 03.0137-9044.2	650264 669044			230 x 40 HEB Bremsbacken-Zubehör
	1.4 1.6 CL/GL 1.8 CL/GL 1.9 D 1.9 D Ecomatic 1.9 SDI 1.9 TD 1.9 TDI			11.91 09.92 11.91 11.91 08.93 07.95 11.91 10.93	08.97 08.97 08.97 08.97 07.95 08.97 08.97	24.0220-0018.1 24.0220-0718.2	480019 480209		ohne Sensorring 5) ohne Sensorring 5)	200/201 x 50 - Lager 200/201 x 50 + Lager
	1.8 Syncro 1.9 TDI Syncro 2.0 Syncro	66		01.93 03.95 07.95	08.97 08.97 08.97	24.0223-0017.1	480135			230/231,5 x 48,5
	1.4 1.8 CL/GL 1.9 D Ecomatic 1.9 TD		1H-S-246940 1H-S-246940	11.91 11.91 08.93 11.91	08.97 + Automatikgetriebe 3)	03.0520-0415.3	690415			15,87/200x40 TopKit
	1.6 1.6 CL/GL 1.6 CL/GL 1.8 CL/GL 1.8 CL/GL 1.9 D 1.9 D Ecomatic 1.9 SDI	55 74 74	1H-S-246940 1H-S-246940	09.92 09.92 09.92 11.91	08.97 + Schaltgetriebe 4) + Automatikgetriebe 3) + Schaltgetriebe 4) + Automatikgetriebe 3)	03.0420-1517.3 03.0520-1517.3	681517 691517			17,46/200x40 Kit 17,46/200x40 TopKit
	1.8 CL/GL 1.9 D 1.9 D Ecomatic 1.9 SDI		1H-S-246941 1H-S-246941	11.91 11.91 07.95 07.95	08.97 + Automatikgetriebe 3)					

1) + cast iron / + ghisa / + fonte grise / + fundición de gris

2) + aluminium / + alluminio / + aluminium / + aluminio

3) + autom.transmission / + scatola cambio automatico / + transmission automatique / + cambio automático

4) + manual transmission / + scatola cambio velocità / + transmission mécanique / + cambio de velocidad

5) without sensor ring / senza sensori / sans secours ABS / sin anillo sensor ABS

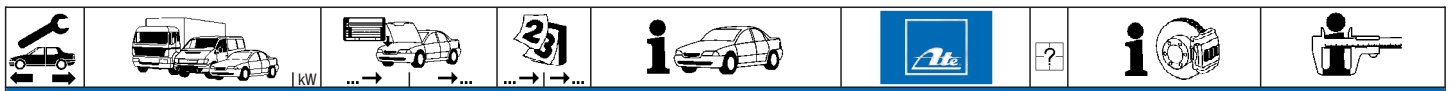

VOLKSWAGEN GOLF III (92-97)

	1.9 TDI	66		10.93	08.97		03.0420-1517.3 03.0520-1517.3	681517 691517		17,46/200x40 Kit 17,46/200x40 TopKit	VW VW
	1.6 CL/GL 1.8 CL/GL	74 1H-S-246941 1H-S-246941			08.97 08.97	+ Schaltgetriebe ¹⁾ + Schaltgetriebe ¹⁾	03.0420-4219.3 03.0520-4219.3	684219 694219		19,05/200x40 Kit 19,05/200x40 TopKit	VW VW
	1.4 1.6 1.8 1.9 D 1.9 D Ecomatic 1.9 TD 1.9 TDI		1H-S-037799 1H-S-037799 1H-S-037799 1H-S-037799 1H-S-037799 1H-S-037799 1H-S-037799	11.91 09.92 11.91 11.91 08.93 11.91 10.93		- GT - GT	24.3727-0135.2	580135	2	L=1500	
	1.4 1.6 1.8 1.9 D 1.9 D Ecomatic 1.9 SDI 1.9 TD 1.9 TDI		1H-S-037800 1H-S-037800 1H-S-037800 1H-S-037800 1H-S-037800 55 1H-S-037800 66 1H-S-037800		08.97 08.97 08.97 08.97 07.95 08.97 08.97	- GT - GT	24.3727-0160.2	580160	2	L=1498	
	1.8 GT 2.0 2.0 GL 2.0 GTI 16V 2.8 VR6	85 79 110	1H-S-037799 1H-S-037799 1H-S-037799 1H-S-037799 1H-S-037799	11.91 11.91 11.91 08.92 01.92			24.3727-0134.2	580134	2	L=1613	
	1.6 GT 1.8 GT 1.9 TDI 2.0 2.0 GL 2.0 GTI 16V 2.8 VR6	74 81 85 79 110	1H-S-037800 1H-S-037800 1H-S-037800 1H-S-037800 1H-S-037800 1H-S-037800 1H-S-037800	07.94 02.96 11.91 11.91 11.91 08.92 01.92	08.97 08.97 08.97 08.97 08.97 08.97 08.97		24.3727-0156.2	580156	2	L=1616	
	1.4 1.4 1.6 1.8 1.9 D 1.9 D Ecomatic 1.9 SDI 1.9 TD 1.9 TDI		1H-V-040000 1H-V-040001	11.91	08.97	- GT - GT	03.0101-0025.2 03.6584-0107.3	320014 320110		BRES 3/35 BRL 8/4 (4)	ATE ATE
	1.6 GT 1.8 GT 1.9 TDI 2.0 2.0 GL 2.0 GTI 16V 2.8 VR6	74 81 85 79 110		07.94 11.91 02.96 11.91 11.91 08.92 01.92	08.97 08.97 08.97 08.97 08.97 08.97 08.97		03.6584-0113.3	320111		BRL 8/4 (4)	ATE
	1.8 Syncro 1.9 TDI Syncro 2.0 Syncro 2.9 VR6 Syncro	66		01.93 03.95 07.95 10.94	08.97 08.97 08.97 08.97		03.6584-0015.3	320109		BRL 8/4 (4)	ATE
	1.8 Syncro 1.9 TDI 1.9 TDI 1.9 TDI Syncro 2.0 2.0 GTI 16V 2.0 Syncro 2.8 VR6 2.9 VR6 Syncro	◀ 66 81 66 85 110 ◀ ◀ ◀		01.93 10.93 02.96 03.95 11.91 08.92 07.95 01.92 10.94	08.97 08.97 08.97 08.97 08.97 08.97 08.97 08.97 08.97		03.2419-9510.3	030028		Gz 19,05	
	1.9 TDI 1.9 TDI 2.0 2.0 GTI 16V 2.8 VR6	▶ 81 85 110 ▶		10.93 02.96 11.91 08.92 01.92	08.97 08.97 08.97 08.97 08.97		03.2419-9910.3	030031		Gz 19,05	
	1.8 Syncro 1.9 TDI 1.9 TDI 1.9 TDI Syncro 2.0 2.0 GTI 16V 2.0 Syncro 2.8 VR6 2.9 VR6 Syncro	◀ 66 81 66 85 110 ◀ ◀ ◀		01.93 10.93 02.96 03.95 11.91 08.92 07.95 01.92 10.94	08.97 08.97 08.97 08.97 08.97 08.97 08.97 08.97 08.97		24.2523-0908.3	040049		Nz 23,81	
	1.4 1.6 1.6	◀ 55 74		11.91 09.92 07.94	08.97 08.97 12.95	- Motorcode AEX ²⁾ - Motorcode AEE ³⁾	24.3728-0130.2	590130		L=1025, + AUT	
	1.4 1.6 1.6 1.8 1.8 1.9 D 1.9 D Ecomatic 1.9 SDI 1.9 TD	◀ 55 74 ◀ ◀ ◀ ◀ ◀ ◀ 55		11.91 09.92 07.94 11.91 11.91 11.91 08.93 07.95 11.91	08.97 08.97 08.97 08.97 08.97 08.97 07.95 08.97 08.97	+ Motorcode AEX ⁴⁾ + Motorcode AEE ⁵⁾	24.3728-0127.2	590127		L=824, + AUT	

1) + manual transmission / + scatola cambio velocità / + transmission mécanique / + cambio de velocidad
 2) - engine code AEX / - codice motore AEX / - moteur code AEX / - motor code AEX
 3) - engine code AEE / - codice motore AEE / - moteur code AEE / - motor code AEE
 4) + engine code AEX / + codice motore AEX / + moteur code AEX / + motor code AEX
 5) + engine code AEE / + codice motore AEE / + moteur code AEE / + motor code AEE

VOLKSWAGEN GOLF III (92-97)									
	2.0 GL	79	11.91	08.97	24.3728-0127.2	590127			L=824, + AUT
VOLKSWAGEN ILTIS (79-88)									
	1.6 TD 1.7		08.87 01.79	12.88 + Bremsgerät/ + Bundeswehr 1) 12.88 + Bremsgerät 2)	03.3526-2002.3	340010	1		Bremslichtschalter
VOLKSWAGEN JETTA I (79-83)									
	1.1 1.3 1.5 1.6		08.79 08.79 08.79 08.80	07.83 07.83 07.83 07.83	03.2120-1531.3 03.3526-2002.3	010092 340010	1		THz 20,64 Bremslichtschalter
	1.1 1.3 1.5 1.6		08.79 08.79 08.79 08.80	07.83 07.83 07.83 07.83	03.2120-1491.3 03.3526-2002.3	010089 340010	2		THz 20,64 + WE Bremslichtschalter
	1.6 1.6 D 1.6 i 1.6 TD 1.7 1.8		08.81 08.80 08.79 03.82 08.80 08.82	07.83 + 6) 07.81 07.82 07.83 07.83 + 7) 07.83	03.2120-1491.3 03.3526-2002.3	010089 340010	2		THz 20,64 + WE Bremslichtschalter
	1.6 D		08.81	07.83	03.2120-1531.3 03.3526-2002.3	010092 340010	1		THz 20,64 Bremslichtschalter
	1.6 D		08.81	07.83	03.2120-1491.3 03.3526-2002.3	010089 340010	2		THz 20,64 + WE Bremslichtschalter
	1.1 1.3 1.6 D		08.79 08.79 08.80	07.83 07.83 07.83 + Schwimmsättel 3)	11.0441-4402.2	250014			Dichtungssatz
	1.5 1.6		08.79 01.79	07.80 + Schwimmsättel 3) 07.80 + Schwimmsättel 3)	11.0441-4402.2	250014			Dichtungssatz
	1.5 1.6 1.6 D 1.6 i 1.6 TD 1.7 1.8		08.79 08.80 08.80 08.79 03.82 08.80 08.82	07.83 + Faustsättel 4) 07.83 + Faustsättel 4) 07.83 + Faustsättel 4) 07.82 07.83 07.83 + 7) 07.83	11.0441-4808.2 11.0441-4804.2 11.0101-4801.2 24.0102-4801.2	250022 250019 260006 260085		f.Vornr -8007/8008 -8503/8504 5)	Dichtungssatz Dichts.a. (+Sich.Ring) Hülensatz Hülensatz+Schrauben
	1.1 1.3 1.6 D		08.79 08.79 08.80	07.83 07.83 07.83 + Schwimmsättel/- 6)	13.0460-4028.2 13.0460-0115.2 13.0460-0905.2	604028 610115 610905			20228 15,3 Belagsatz-Zubehör Belagsatz-Zubehör
	1.5 1.6		08.79 01.79	07.80 + Schwimmsättel 3) 07.80 + Schwimmsättel 3)	13.0460-4029.2	604029			20228 18,5
	1.5 1.6 1.6 D 1.6 TD 1.7 1.6 i 1.8		08.79 08.80 08.80 03.82 08.80 08.79 08.82	07.83 + Faustsättel 4) 07.83 + Faustsättel 4) 07.83 + Faustsättel 4) 07.83 07.83 + 7) 07.82 07.83	13.0460-7032.2	607032			20887 19,7 +/Zub
	1.5 1.6 1.6 D 1.6 TD 1.7 1.6 i 1.8		08.79 08.80 08.80 03.82 08.80 08.79 08.82	07.83 + Faustsättel 4) 07.83 + Faustsättel 4) 07.83 + Faustsättel 4) 07.83 07.83 + 7) 07.82 07.83	13.0460-7033.2	607033			20887 15,3 +/Zub
	1.1 1.3 1.6 D		08.79 08.79 08.80	07.83 07.83 07.83 - 7)	24.0110-0151.1 24.0310-0151.1	410151 510151			239 10,0 8,0 +S +B 239 10,0 8,0 +S +B PD
	1.5 1.6 1.6 D 1.6 TD 1.7		08.79 08.80 08.80 03.82 08.80	07.83 07.83 07.83 + 7) 07.83 07.83 + 7)	24.0112-0106.1 24.0312-0106.1	412106 512106			239 12,0 10,0 +S +B 239 12,0 10,0 +S +B PD
	1.6 i 1.8		08.79 08.82	07.82 07.83	24.0120-0123.1 24.0320-0123.1	420123 520123			239 20,0 18,0 V L +S +B 239 20,0 18,0 V L +S +B PD
	1.1 1.3 1.5 1.6 1.6 D 1.6 i 1.6 TD 1.7 1.8		08.79 08.79 08.79 08.80 08.80 08.79 03.82 08.80 08.82	07.83 07.83 07.83 07.83 07.83 07.82 07.83 07.83 + 7) 07.83	24.5170-0315.3 24.5108-0266.3	331309 330038	2 2		L=315 L=266
	1.1 1.3 1.5 1.6 1.6 D 1.6 i 1.6 TD 1.7 1.8		08.79 08.79 08.79 08.80 08.80 08.79 03.82 08.80 08.82	07.83 07.83 07.83 07.83 07.83 07.82 07.83 07.83 + 7) 07.83	24.5201-0164.3	331414	2		L=164
	1.1 1.3 1.5 1.6 1.6 D 1.6 i 1.6 TD 1.7 1.8		08.79 08.79 08.79 08.80 08.80 08.79 03.82 08.80 08.82	07.83 07.83 07.83 07.83 07.83 07.82 07.83 07.83 + 7) 07.83	03.3214-0812.3 24.3214-0902.3	020011 020147		+ GG 8) + ALU 9)	Rz 14,29 Rz 14,29

1) + booster unit/ + german army / + servofreno/ + esercito / + servo-frein/ + armée allemande / + servofreno/ + ejército
2) + booster unit / + servofreno / + servo-frein / + servofreno
3) + floating calipers / + pinza flottante / + étriers flottant / + pinzas flotante
4) + fist type calipers / + pinza freno flottante / + étriers à griffe / + pinza de puno
5) f.partno. -8007/8008 -8503/8504 / p.no.codice -8007/8008 -8503/8504 / p.AV ref. -8007/8008 -8503/8504 / p. antes ref. -8007/8008 -8503/8504
6) + floating calipers/ - 7) / + pinza flottante/ - 7) / + étriers flottant/ - 7) / + pinzas flotante/ - 7)

7) + 7) / + fist type calipers / + 7) / + pinza flottante / + 7) / + étriers à griffe / + 7) / + pinza de puno
8) + cast iron / + ghisa / + fonte grise / + fundición de gris
9) + aluminium / + alluminio / + aluminium / + aluminio
10) + manual transmission / + scatola cambio velocità / + transmission mécanique / + cambio de velocidad



VOLKSWAGEN JETTA I (79-83)

	1.6 D		08.80	07.83	+ Schaltgetriebe ¹⁾	03.3214-0812.3	020011	+ GG ²⁾	Rz 14,29	
	1.6 TD		03.82	07.83		24.3214-0902.3	020147	+ ALU ³⁾	Rz 14,29	
	1.5		08.79	07.83	+ Automatikgetriebe ⁴⁾	03.3217-2112.3	020027	+ GG ²⁾	Rz 17,46	
	1.6		08.80	07.83	+ Automatikgetriebe ⁴⁾	24.3217-0908.3	020167	+ ALU ³⁾	Rz 17,46	
	1.6 D		08.80	07.83	+ Automatikgetriebe ⁴⁾					
	1.6 i		08.79	07.82						
	1.7		08.80	07.83	+					
	1.8		08.82	07.83						
	1.1		08.79	07.83		03.0137-0126.2	650126		180 x 31 HEB	
	1.3		08.79	07.83		03.0137-9008.2	669008		Bremsbacken-Zubehör	
	1.5		08.79	07.83						
	1.6		08.80	07.83						
	1.6 D		08.80	07.83						
	1.6 i		08.79	07.82						
	1.6 TD		03.82	07.83						
	1.7		08.80	07.83	+					
1.8		08.82	07.83							
	1.1		08.79	07.83		03.0520-0114.3	690114		14,29/180x31 TopKit	VW
	1.3		08.79	07.83						
	1.5		08.79	07.83	+ Schaltgetriebe ¹⁾					
	1.6		08.80	07.83	+ Schaltgetriebe ¹⁾					
	1.6 D		08.80	07.83	+ Schaltgetriebe ¹⁾					
	1.6 TD		03.82	07.83						
	1.5		08.79	07.83	+ Automatikgetriebe ⁴⁾	03.0420-0617.3	680617	+ Rz GG ⁵⁾	17,46/180x31 Kit	VW
	1.6		08.80	07.83	+ Automatikgetriebe ⁴⁾	03.0520-3917.3	693917	+ Rz ALU ⁶⁾	17,46/180x31 TopKit	VW
	1.6 D		08.80	07.83	+ Automatikgetriebe ⁴⁾					
	1.6 i		08.79	07.82						
1.7		08.80	07.83	+						
1.8		08.82	07.83							
	1.1		08.79	07.83		24.3727-0102.2	580102	2	L=1690	
	1.3		08.79	07.83						
	1.5		08.79	07.83						
	1.6		08.80	07.83						
	1.6 D		08.80	07.83						
	1.6 i		08.79	07.82						
	1.6 TD		03.82	07.83						
	1.7		08.80	07.83	+					
1.8		08.82	07.83							
	1.1		08.79	07.83		03.6565-0101.3	320097		BRL 6/5 (4)	ATE
	1.3		08.79	07.83						
	1.5		08.79	07.83						
	1.6		08.80	07.83						
	1.6 D		08.80	07.83						
	1.6 i		08.79	07.82						
	1.6 TD		03.82	07.83						
	1.7		08.80	07.83	+					
1.8		08.82	07.83							
	1.1		08.79	07.83		24.3728-0107.2	590107		L=1055	
	1.3		08.79	07.83						
	1.5		08.79	07.83		24.3728-0108.2	590108		L=794	
	1.6		08.80	07.83						
	1.6 D		08.80	07.83						
	1.6 i		08.79	07.82						
	1.6 TD		03.82	07.83						
	1.7		08.80	07.83	+					
	1.8		08.82	07.83						

VOLKSWAGEN JETTA II (84-92)

	1.6	◀		01.84	07.87	- ABS/ + Automatikgetriebe ⁷⁾	03.6750-0202.4	300033		9"	ATE	
	1.6	◀	51	10.86	07.92	- ABS						
	1.6	◀	53	03.86	07.92	- ABS						
	1.6	◀	55	1G-LW400000	01.84	- ABS						
	1.6	◀	55	1G-LB125000	01.84	- ABS						
	1.6 D	◀		01.84	07.89	- ABS/ + Automatikgetriebe ⁷⁾						
	1.6 TD	◀		01.84	07.89	- ABS						
	1.8	◀		01.84	07.89	- ABS						
	1.8 16V	◀		1G-KW240000	08.86	- ABS						
	1.8 16V	◀		1G-KB075000	08.86	- ABS						
	1.8 Syncro	◀		08.87	07.92	- ABS						
	1.6	◀	55	1G-LW400001		07.92	- ABS	03.7750-4302.4	300076		9"	ATE
	1.6	◀	55	1G-LB125001		07.92	- ABS					
	1.6 D	◀			08.89	07.92	- ABS					
1.6 TD	◀			08.89	07.92	- ABS						
1.8	◀			08.89	07.92	- ABS						
1.8 16V	◀		1G-KW240001		07.92	- ABS						
1.8 16V	◀		1G-KB075001		07.92	- ABS						
1.6	▶			08.89	07.92	- ABS	03.7750-4902.4	300079		9"	ATE	

¹⁾ + manual transmission / + scatola cambio velocità / + transmission mécanique / + cambio de velocidad

²⁾ + cast iron / + ghisa / + fonte grise / + fundición de gris

³⁾ + aluminium / + alluminio / + aluminium / + aluminio

⁴⁾ + autom.transmission / + scatola cambio automatico / + transmission automatique / + cambio automático

⁵⁾ + WC cast iron / + CR ghisa / + CR fontegrise / + CR fundición de gris

⁶⁾ + WC aluminium / + CR alluminio / + CR aluminium / + CR aluminio

⁷⁾ - ABS/ + autom.transmission / - ABS/ + scatola cambio autom. / - ABS/ + transmission automatique / - ABS/ + cambio automático

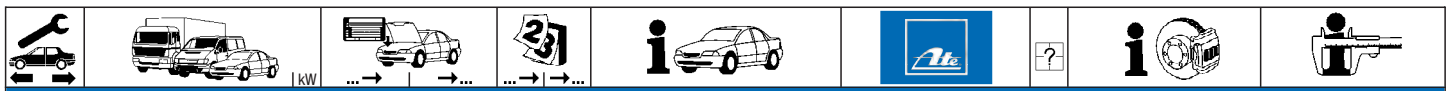

VOLKSWAGEN JETTA II (84-92)

	1.6 D 1.6 TD 1.8 1.8 16V 1.8 16V			08.89 08.89 08.89 07.92 07.92	07.92 07.92 07.92 - ABS - ABS	03.7750-4902.4	300079		9"	ATE
	1.3 1.6 1.6 D 1.6 TD 1.8 1.8 16V 1.8 16V 1.8 Syncro		1G-KW240001 1G-KB075001	08.83 01.84 01.84 01.84 01.84 08.86 08.86 08.87	07.92 - ABS - ABS - ABS - ABS - ABS - ABS - ABS	03.2120-2031.3 03.3517-0101.2	010106 390322		THz 20,64 Verschlußschraube	ATE
	1.6 D 1.6 TD 1.8			08.89 08.89 08.89	07.92 - ABS - ABS	03.2120-3943.3 03.3517-0101.2	010532 390322		THz 20,64 Verschlußschraube	ATE
	1.8 16V 1.8 16V	1G-KB075001 1G-KW240001		07.92 07.92	- ABS - ABS	03.2122-1042.3 03.3517-0101.2	010137 390322		THz 22,20 Verschlußschraube	ATE
	1.3 1.3 1.3 1.6 D 1.6 D 1.6 D		16-E-855000	08.83 08.83 08.86 01.84 01.84 08.86	07.86 - ABS - (⌚) - (⌚) + Schaltgetriebe 1)	24.3481-1745.5 24.3481-1746.5 11.0441-4808.2 11.0101-4803.2 24.0102-4803.2	240277 240278 250022 260008 260086	<input type="checkbox"/> <input type="checkbox"/>	D=48, - Halter D=48, - Halter Dichtungssatz Hülssensatz Hülssensatz+Schrauben	ATE ATE ATE ATE ATE
	1.3 1.3 1.6 1.6 D 1.6 D 1.6 D 1.6 TD 1.8 1.8 16V 1.8 16V 1.8 Syncro	16-E-855001 16-E-855001		07.86 08.89 01.84 07.86 01.84 08.86 01.84 01.84 08.86 08.86 08.87	+ ABS - (⌚) + (⌚) + Automatikgetriebe 2)	11.0441-4808.2 11.0101-4801.2 24.0102-4801.2	250022 260006 260085		Dichtungssatz Hülssensatz Hülssensatz+Schrauben	ATE ATE ATE
	1.8 16V 1.8 16V	1G-KW240001 1G-KB075001		07.92 07.92		24.3541-1609.5 24.3541-1610.5 24.0101-4301.2 11.0101-5403.2	240039 240040 260047 260010	<input type="checkbox"/> <input type="checkbox"/>	D=54, - Halter D=54, - Halter Bremsattel-Zubehör Fallenbalgsatz	TRW TRW TRW TRW
	1.3 1.3 1.3 1.6 1.6 D 1.6 D 1.6 D		16-E-855000	08.83 08.83 08.83 03.86 01.84 01.84 08.86	07.86 - ABS - (⌚) - (⌚) + Schaltgetriebe 1)	13.0460-7030.2 13.0460-0184.2	607030 610184		20889 17,3 /Zub Belagsatz-Zubehör	VW VW
	1.3 1.3 1.6 1.6 1.6 D 1.6 D 1.6 D 1.6 TD 1.8 1.8 1.8 Syncro	16-E-855001 55 16-E-855001 62 66		07.86 08.89 08.86 01.84 07.86 01.84 08.86 01.84 07.92 08.86 08.84 08.87	+ ABS - (⌚) + (⌚) + Automatikgetriebe 2) - ABS - ABS	13.0460-7032.2	607032		20887 19,7 +/Zub	VW
	1.8 1.8 1.8 1.8 1.8 1.8 16V 1.8 16V	62 16-JH560001 66 16-JH560001 77 79 82		07.92 07.92 08.88 08.85 01.84 08.86 08.86	+ ABS + ABS + (⌚)	13.0460-7033.2	607033		20887 15,3 +/Zub	VW
	1.8 16V 1.8 16V	1G-KW240001 1G-KB075001		07.92 07.92		13.0460-2957.2	602957		20168 16,0 /S	TRW
	1.3 1.3 1.3 1.6 1.6 D 1.6 D 1.6 D		16-E-855000	08.83 08.83 08.86 03.86 01.84 01.84 08.86	07.86 - ABS - (⌚) - (⌚) + Schaltgetriebe 1)	24.0110-0151.1 24.0310-0151.1	410151 510151		239 10,0 8,0 +S +B 239 10,0 8,0 +S +B PD	
	1.3 1.3 1.6 1.6 1.6 D 1.6 D 1.6 D 1.6 TD 1.8 1.8 1.8 Syncro	16-E-855001 55 16-E-855001 62 66		07.86 08.89 08.86 01.84 07.86 01.84 08.86 01.84 07.92 08.86 08.84 08.87	+ ABS - (⌚) + (⌚) + Automatikgetriebe 2) - ABS - ABS	24.0112-0106.1 24.0312-0106.1	412106 512106		239 12,0 10,0 +S +B 239 12,0 10,0 +S +B PD	

1) + manual transmission / + scatola cambio velocità / + transmission mécanique / + cambio de velocidad
2) + autom.transmission / + scatola cambio automatico / + transmission automatique / + cambio automático



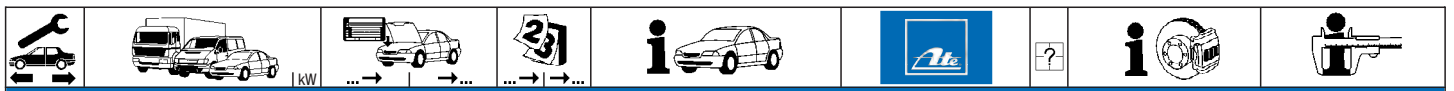

VOLKSWAGEN JETTA II (84-92)

	1.8 1.8 1.8 1.8 1.8 1.8 1.8 16V 1.8 16V	62 66 77 79 82	16-JH560001 16-JH560001		07.92 07.92 08.88 08.85 01.84 08.86 08.86	+ ABS + ABS + ☺	24.0120-0123.1 24.0320-0123.1	420123 520123		239 20,0 18,0 V L +S +B 239 20,0 18,0 V L +S +B PD		
	1.8 16V 1.8 16V		1G-KW240001 1G-KB075001		07.92 07.92	+ ABS + ABS	24.0120-0128.1 24.0320-0128.1	420128 520128		256 20,0 18,0 V L +S +B 256 20,0 18,0 V L +S +B PD		
	1.3 1.6 1.6 D 1.6 TD 1.8 1.8 16V 1.8 16V 1.8 Syncro				08.83 01.84 01.84 01.84 01.84 02.86 02.86 08.87	07.92 07.92 07.92 07.92 07.92 07.92 07.92		24.5170-0315.3	331309	2	L=315	
	1.8 16V 1.8 16V		1G-KW240001 1G-KB075001		07.92 07.92	+ ABS + ABS	83.6225-0287.3	330735	2	L=285		
	1.3 1.6 1.6 D 1.6 TD 1.8 1.8 16V 1.8 Syncro				08.86 08.86 08.86 08.86 08.86 08.86 08.87	07.92 07.92 07.92 07.92 07.92 07.92 07.92		24.0711-1313.3	360016	2	Radsensor L=1130	
	1.8 1.8 16V 1.8 GT				01.84 08.86 08.85	07.88 07.88 07.88	- ABS - ABS - ABS	24.3364-1605.5 24.3364-1606.5 24.0101-3601.2 11.0101-5403.2	240011 240012 260044 260010	<input type="checkbox"/> <input type="checkbox"/> <input type="checkbox"/>	D=36, - Halter D=36, - Halter Bremsattel-Zubehör Fallenbalsatz	TRW TRW TRW TRW
	1.8 1.8 1.8 1.8 16V 1.8 GT	62 66 82	16-JH480001 16-JH480001 16-JH480001 16-JH480001 16-JH480001		07.88 07.88 07.88 07.88 07.88	+ ABS + ABS + ABS + ABS + ABS	24.3384-1603.5 24.3384-1604.5 24.0101-3601.2	240015 240016 260044	<input type="checkbox"/> <input type="checkbox"/> <input type="checkbox"/>	D=38, - Halter D=38, - Halter Bremsattel-Zubehör	TRW TRW TRW	
	1.8 1.8 1.8 1.8 16V 1.8 GT	62 66 82			08.88 08.88 08.88 08.88 08.88	07.89 07.89 07.89 07.89 07.89	+ ABS + ABS	24.3364-1605.5 24.3364-1606.5 24.0101-3601.2 11.0101-5403.2	240011 240012 260044 260010	<input type="checkbox"/> <input type="checkbox"/> <input type="checkbox"/> <input type="checkbox"/>	D=36, - Halter D=36, - Halter Bremsattel-Zubehör Fallenbalsatz	TRW TRW TRW TRW
	1.8 1.8 1.8 1.8 16V 1.8 GT	62 66 82			08.89 08.89 08.89 08.89 08.89	07.92 07.92 07.92 07.92 07.92	+ ABS + ABS	24.3384-1603.5 24.3384-1604.5 24.0101-3601.2	240015 240016 260044	<input type="checkbox"/> <input type="checkbox"/> <input type="checkbox"/>	D=38, - Halter D=38, - Halter Bremsattel-Zubehör	TRW TRW TRW
	1.8 1.8 1.8 1.8 16V 1.8 GT	62 66 82	16-JH480001 16-JH480001		07.92 07.92 01.84 08.86 08.85	+ ABS + ABS	13.0460-2937.2 13.0460-0419.2	602937 610419		20961 15,2 /Zub/S Belagsatz-Zubehör	TRW TRW	
	1.8 1.8 1.8 1.8 16V 1.8 GT	62 66 82	16-JH480001 16-JH480001		07.92 07.92 01.84 08.86 08.85	+ ABS + ABS	24.0110-0111.1 24.0110-0275.2	410111 410275	ohne Sensorring ¹⁾ mit Sensorring ²⁾	226 10,0 8,0 +B 226 10,0 8,0 +B		
	1.3 1.6 1.6 D 1.6 TD 1.8 1.8				08.83 01.84 01.84 01.84 08.86 08.84	07.88 07.88 07.88 07.88 07.88 07.88	- ABS - ABS	24.5204-0180.3 24.5201-0164.3	331461 331414	2 2	L=180 L=164	
	1.3 1.6 1.6 D 1.6 TD 1.8 1.8 1.8 Syncro				08.88 08.88 08.88 08.88 08.88 08.88 08.87	07.92 07.92 07.92 07.92 07.92 07.92 07.92	- ABS - ABS	24.5201-0164.3	331414	2	L=164	
	1.8 1.8 1.8 1.8 16V	62 66 82	16-JH480001 16-JH480001		07.92 07.92 01.84 08.86	+ ABS + ABS	24.5170-0161.3	331308	2	L=161		
	1.3 1.6 1.6 D 1.6 TD 1.8 1.8 16V		1G-M-000001 1G-M-000001 1G-M-000001 1G-M-000001 1G-M-000001 1G-M-000001		07.92 07.92 07.92 07.92 07.92 07.92		24.0721-1925.1	360039	2	Radsensor L=1220		
	1.3 1.6 1.6 D 1.6 TD 1.8 1.8 1.8				08.83 01.84 01.84 01.84 08.86 08.84 08.88	07.92 07.92 07.92 07.92 07.92 07.92 07.92	- Bremskraftregler ³⁾ - Bremskraftregler ³⁾ - Bremskraftregler ³⁾ - Bremskraftregler ³⁾ - Bremskraftregler ³⁾ - Bremskraftregler ³⁾ + ☺	03.3214-0812.3 24.3214-0902.3	020011 020147	+ GG ⁴⁾ + ALU ⁵⁾	Rz 14,29 Rz 14,29	
	1.8 1.8 1.8	62 66 77	1G-KW593279		08.88							

¹⁾ without sensor ring / senza sensori / sans secours ABS / sin anillo sensor ABS

²⁾ with sensor ring / con sensori / avec secours ABS / con anillo sensor ABS

³⁾ - brake pressure regulator / - correttore di frenata / - correcteur de freinage / - corrector de frenado

⁴⁾ + cast iron / + ghisa / + fonte grise / + fundición de gris

⁵⁾ + aluminium / + alluminio / + aluminium / + aluminio



VOLKSWAGEN JETTA II (84-92)

	1.3			08.83	07.92 + Bremskraftregler ¹⁾	03.3217-2112.3	020027		+ GG ²⁾	Rz 17,46		
	1.6			01.84	07.92 + Bremskraftregler ¹⁾	24.3217-0908.3	020167		+ ALU ³⁾	Rz 17,46		
	1.6 D			01.84	07.92 + Bremskraftregler ¹⁾							
	1.6 TD			01.84	07.92 + Bremskraftregler ¹⁾							
	1.8	62		08.86	07.92 + Bremskraftregler ¹⁾							
	1.8	66		08.84	07.92 + Bremskraftregler ¹⁾							
	1.8	77	1G-KW593280	07.92	+							
1.8 Syncro			08.87	07.92	24.3219-0909.3	020188				Rz 19,05		
	1.3			08.83	07.92	03.0137-0126.2	650126			180 x 31 HEB		
	1.6			01.84	07.92	03.0137-9008.2	669008			Bremsbacken-Zubehör		
	1.6 D			01.84	07.92							
	1.6 TD			01.84	07.92 -							
	1.8	62		08.86	07.92 - ABS							
	1.8	66		08.84	07.92 - ABS							
	1.8	77	1G-KW593279	08.88	- ABS +							
1.6 TD			08.89	07.92 +	03.0137-0268.2	650268				200 x 40 HEB	VW	
1.8	77	1G-KW593280	07.92	+ ABS/ +	03.0137-9168.2	669168				Bremsbacken-Zubehör	VW	
1.8 Syncro			08.87	07.92	03.0137-0264.2	650264				230 x 40 HEB	VW	
	1.3			08.83	07.92	24.0218-0007.1	480003			180/181 x 38,5 - Lager		
	1.6			01.84	07.92	24.0218-0707.2	480211			180/181 x 38,5 + Lager		
	1.6 D			01.84	07.92							
	1.6 TD			01.84	07.92 -							
	1.8	62		08.86	07.92 - ABS							
	1.8	66		08.84	07.92 - ABS							
	1.8	77	1G-KW593279	08.88	+							
1.6 TD			08.89	07.92 +	24.0220-0018.1	480019		ohne Sensorring ⁴⁾		200/201 x 50 - Lager	VW	
1.8	77	1G-KW593280	07.92	+	24.0220-0718.2	480209		ohne Sensorring ⁴⁾		200/201 x 50 + Lager	VW	
1.8 Syncro			08.87	07.92	24.0223-0017.1	480135				230/231,5 x 48,5	VW	
	1.3			08.83	07.92 - Bremskraftregler/ -	03.0520-0114.3	690114				14,29/180x31 TopKit	VW
	1.6			01.84	07.92 - Bremskraftregler/ -							
	1.6 D			01.84	07.92 - Bremskraftregler/ -							
	1.6 TD			01.84	07.92 - Bremskraftregler/ -							
	1.8	62		08.86	07.92 - Bremskraftregler/ -							
	1.8	66		08.84	07.92 - Bremskraftregler/ -							
	1.3			08.83	07.92 + Bremskraftregler/ -	03.0420-0617.3	680617		+ Rz GG ⁷⁾		17,46/180x31 Kit	VW
	1.6			01.84	07.92 + Bremskraftregler/ -	03.0520-3917.3	693917		+ Rz ALU ⁸⁾		17,46/180x31 TopKit	VW
	1.6 D			01.84	07.92 + Bremskraftregler/ -							
	1.6 TD			01.84	07.92 + Bremskraftregler/ -							
1.8	62		08.86	07.92 + Bremskraftregler/ -								
1.8	66		08.84	07.92 + Bremskraftregler/ -								
1.6 TD			08.89	07.92 +	03.0420-1517.3	681517				17,46/200x40 Kit	VW	
1.8	77	1G-KW593280	07.92	+	03.0520-1517.3	691517				17,46/200x40 TopKit	VW	
	1.3			08.83	07.88	24.3727-0118.2	580118	2		L=1748		
	1.6			01.84	07.88							
	1.6 D			01.84	07.88							
	1.6 TD			01.84	07.88							
	1.8	62		08.86	07.88 - ABS							
	1.8	66		08.84	07.88 - ABS							
	1.3			08.88	07.92	24.3727-0132.2	580132	2		L=1527		
	1.6			08.88	07.92							
	1.6 D			08.88	07.92							
	1.6 TD			08.88	07.92							
	1.8	62		08.88	07.92 - ABS							
	1.8	66		08.88	07.92 - ABS							
	1.8	77		08.88	07.92 +							
	1.8	82		01.84	07.92 - ABS	24.3727-0123.2	580123	2		L=1800		
1.8 16V			08.86	07.92 - ABS								
1.8	82	16-JH480001	07.88	+ ABS	24.3727-0124.2	580124	2		L=1840			
1.8 16V		16-JH480001	07.88	+ ABS								
1.8	82		08.88	07.92 + ABS	24.3727-0133.2	580133	2		L=1622			
1.8 16V			08.88	07.92 + ABS								
1.8 Syncro			08.87	07.92	24.3727-0166.2	580166	2		L=1567			
	1.3			08.83	07.92	03.6584-0015.3	320109			BRL 8/4 (4)	ATE	
	1.6			01.84	07.92							
	1.6 D			01.84	07.92							
	1.6 TD			01.84	07.92							
	1.8			01.84	07.92							
	1.8 16V			08.86	07.92							
	1.8 Syncro			08.87	07.92							
	1.3			08.83	07.92	24.3728-0113.2	590113			L=1098		
	1.6			01.84	07.92	24.3728-0111.2	590111		- autom. Nachstellung ⁹⁾	L=806		
	1.8			01.84	07.92							
	1.8 16V			08.86	07.92							
	1.6 D			01.84	07.92	24.3728-0121.2	590121		+ autom. Nachstellung ¹⁰⁾	L=800, + AUT		
	1.6 TD		51	01.84	07.92							
	1.6 TD		59	04.89	07.92	24.3728-0120.2	590120			L=1081, + AUT		
1.8 Syncro			08.87	10.91	24.3728-0111.2	590111		- autom. Nachstellung ⁹⁾	L=806			
					24.3728-0121.2	590121		+ autom. Nachstellung ¹⁰⁾	L=800, + AUT			

¹⁾ + brake pressure regulator / + correttore di frenata / + correcteur de freinage / + corrector de frenado

²⁾ + cast iron / + ghisa / + fonte grise / + fundición de gris

³⁾ + aluminium / + alluminio / + aluminium / + aluminio

⁴⁾ without sensor ring / senza sensori / sans secours ABS / sin anillo sensor ABS

⁵⁾ - brake pressure regulator/ - / - correttore di frenata/ - / - correcteur de freinage/ - / - corrector de frenado/ -

⁶⁾ + brake pressure regulator/ + / + correttore di frenata/ + / + correcteur de freinage/ + / + corrector de frenado/ +













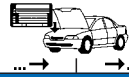





⁷⁾ + WC cast iron / + CR ghisa / + CR fonte grise / + CR fundición de gris

⁸⁾ + WC aluminium / + CR alluminio / + CR aluminium / + CR aluminio

⁹⁾ - automatic adjustment / - correzione automatica / - ajustage automatique / - reajuste automatico

¹⁰⁾ + automatic adjustment / + correzione automatica / + ajustage automatique / + reajuste automático



									
VOLKSWAGEN KÄFER (TYP 1) (49-03)									
	1200			01.54 07.64	03.3119-0507.3 010264 03.3526-2002.3 340010	1		Hz 19,05 Bremslichtschalter	ATE
	1200 1300			08.64 07.69 08.65 07.67	03.3117-1408.3 010255 03.3526-2002.3 340010	1		Hz 17,46 Bremslichtschalter	ATE
	1500			08.66 07.67	03.3526-2002.3 340010	1		Bremslichtschalter	
	1200 1300 1500			08.69 07.81 08.67 12.74 + VA-Trommelbremse ¹⁾ 08.67 12.70	03.2119-8511.3 010062 03.3526-2002.3 340010	1		THz 19,05 Bremslichtschalter	ATE
	1200			08.81 12.85	03.2119-8711.3 010064 24.3526-1900.0 340038	2		THz 19,05 + WE Bremslichtschalter	ATE
	1300 1302 1303			08.67 12.74 + VA-Scheibenbremse ²⁾ 08.70 07.72 08.72 07.79	03.2119-8911.3 010066 03.3526-2002.3 340010 03.2119-9111.3 010068 24.3526-1900.0 340038	1 2	- (USA) - (USA) + (USA) + (USA)	THz 19,05 Bremslichtschalter THz 19,05 + WE Bremslichtschalter	ATE ATE ATE
	1302 1303			08.70 07.72 08.72 07.79	03.2119-9011.3 010067 03.3526-2002.3 340010	1		THz 19,05 Bremslichtschalter	ATE
	1500			08.67 12.70	03.2119-8611.3 010063 03.3526-2002.3 340010	1		THz 19,05 Bremslichtschalter	ATE
	1300 1302 1500			01.65 01.73 08.69 07.75 08.66 11.73	13.2401-8007.2 210047 13.2401-8008.2 210048 13.0441-4002.2 250074 13.0441-4008.2 250076		<input type="checkbox"/> bis 07.72 verwenden ³⁾ <input type="checkbox"/> ab 08.72 verwenden ⁴⁾	D=40 D=40 Dichtungssatz Dichtungssatz	ATE ATE ATE ATE
	1303			08.72 12.79	13.2401-8007.2 210047 13.2401-8008.2 210048 13.0441-4002.2 250074 13.0441-4008.2 250076		<input type="checkbox"/> nur paarweise austauschen ⁵⁾ <input type="checkbox"/> nur paarweise austauschen ⁵⁾	D=40 D=40 Dichtungssatz Dichtungssatz	ATE ATE ATE ATE
	1200 1300 1302	1122076274 1122076274 1122076274	1332013626 1332013626 1332013626		13.0460-3010.2 603010 13.0460-0014.2 610014			20009 15,0 Belagsatz-Zubehör	ATE ATE
	1303			08.72 07.79	13.0460-2905.2 602905 13.0460-3010.2 603010 13.0460-0908.2 610908		für TRW-System für ATE-System ⁶⁾	20286 16,2 20009 15,0 Belagsatz-Zubehör	TRW ATE TRW
	1200 1300 1302 1303 1500			01.54 12.77 08.67 12.74 08.70 07.72 08.72 07.79 08.66 12.70	24.0110-0142.1 410142			278 9,5 8,0	
	1200 1200 1200 1300 1200 1300 1500 1300 1500 1302 1303 1303			01.54 12.57 01.57 07.64 08.64 12.66 08.65 07.66 01.67 12.85 08.66 07.67 08.67 12.70 08.67 12.74 08.66 07.67 08.70 07.72 08.72 07.74 08.73 07.79	24.5165-0450.3 331259 83.6101-0240.3 330202 24.5165-0425.3 331258 24.5165-0350.3 331257 83.6101-0325.3 330206 24.5224-0295.3 331261 24.5230-0285.3 331322	2 2 2 2 2 2 2 2		L=450 L=240 L=425 L=350 L=325 L=295 L=285	
	1.1 1200 1200 1200 1300 1302 1303	18		12.47 12.53 01.54 12.57 01.54 07.64 01.54 12.85 08.65 12.74 08.70 07.72 08.72 07.74	03.3219-0102.3 020036 03.0470-2619.2 060051 03.3219-0411.3 020038 03.0470-2619.2 060051 03.3222-5211.3 020081 03.3222-5211.3 020081 03.3223-0611.3 020091		03.3518-0200.2 mitverwenden ⁷⁾	Rz 19,05 Rz Dichtungssatz Rz 19,05 Rz Dichtungssatz Rz 22,20 Rz 22,20 Rz 23,81	
	1200 1300 1302 1303			01.68 12.85 08.67 12.74 08.70 07.72 08.72 07.74	03.0137-0041.2 650041 03.0137-9229.2 669229 03.0137-0073.2 650073 03.0137-9009.2 669009			230 x 40 Bremsbacken-Zubehör 248 x 46 Bremsbacken-Zubehör	ATE ATE
	1200 1300	118000001		01.68 12.85 12.74	24.0223-0002.1 480032			230/231 x 47	
	1200 1300 1500 1200 1300 1302 1303 1500			01.54 12.85 + Schaltgetriebe ⁸⁾ 08.65 12.74 + Schaltgetriebe ⁸⁾ 08.66 12.70 + Schaltgetriebe ⁸⁾ 08.69 12.77 + Automatikgetriebe ⁹⁾ 08.67 07.71 + Automatikgetriebe ⁹⁾ 08.70 07.72 08.72 07.79 08.67 12.70 + Automatikgetriebe ⁹⁾	24.5224-0240.3 331260 24.5165-0215.3 331319	2 2		L=240 L=215	
	1.1 1200 1200 1200 1300 1500 1200	18		12.47 12.53 01.54 12.57 01.57 07.64 08.64 12.66 08.65 07.67 08.66 07.67 01.67 12.85	03.3219-0102.3 020036 03.0470-2619.2 060051 03.3217-0211.3 020021 03.3219-3211.3 020048 03.3219-3211.3 020048 03.3217-1811.3 020026		03.3518-0200.2 mitverwenden ⁷⁾	Rz 19,05 Rz Dichtungssatz Rz 17,46 Rz 19,05 Rz 19,05 Rz 17,46	

¹⁾ + FA drum brake / + A freno a tamburo / + frein à tambour ess.AV / + ED tambores de freno

²⁾ + FA disc brake / + A disco freno / + frein à disque essieu AV / + ED disco de freno

³⁾ reuse up to 07.72 / riutilizzare fino a 07.72 / utiliser jusqu'au 07.72 / hasta 07.72 emplear

⁴⁾ reuse from 08.72 / utilizzare dal 08.72 / utiliser à partir de 08.72 / desde 08.72 emplear

⁵⁾ to change only by pairs / sostituire solo a coppie / à changer seulement par paires / cambiar solamente por parejas

⁶⁾ for ATE system / per sistema ATE / pour système ATE / para sistema ATE

⁷⁾ 03.3518-0200.2 reuse / 03.3518-0200.2 riutilizzare / 03.3518-0200.2 utiliser / 03.3518-0200.2 emplear

⁸⁾ + manual transmission / + scatola cambio velocità / + transmission mécanique / + cambio de velocidad

⁹⁾ + autom.transmission / + scatola cambio automatico / + transmission automatique / + cambio automático



VOLKSWAGEN KÄFER (TYP 1) (49-03)

	1300 1302 1303 1500			08.67 08.70 08.72 08.67	12.74 07.72 07.79 12.70		03.3217-1811.3	020026			Rz 17,46	
	1200 1300 1302 1303 1500			01.68 08.67 08.70 08.72 08.66	12.85 12.74 07.72 07.79 12.70		03.0137-0041.2 03.0137-9005.2	650041 669005			230 x 40 Bremsbacken-Zubehör	ATE
	1200 1300 1302 1303 1600 i			01.68 08.67 08.70 08.72 10.93	12.85 12.74 07.72 07.79 08.03 + ⊕		24.0223-0003.1	480033			230/231 x 50	
	1200 1300 1302 1303 1500			01.67 08.67 08.70 08.72 08.67	12.85 12.74 07.72 07.79 12.70		03.0420-2917.3	682917			17,46/230x40 Kit	ATE
	1200 1303 1600 i	1182100001		08.72 10.93	12.85 07.79 08.03 + ⊕		24.3727-0101.2	580101	2	↓	L=1750	
	1200 1300 1302 1303	1122000001 1122000001 1122000001	1142663259 1342663259	12.74 07.72 08.72			24.3728-0106.2	590106			L=2285	

VOLKSWAGEN LT/LT 4x4 (75-96)

	LT 28 LT 31 LT 35			04.75 04.75 04.75	07.96 07.96 07.96 - Doppelbereifung 1)		03.6850-5402.4	300055			9"	ATE
	LT 28 LT 31 LT 35			04.75 04.75 04.75	07.96 - ABS 07.96 - ABS 07.96 - ABS/ - Doppelbereifung 2)		03.2123-5212.3 03.3526-2002.3	010183 340010	2		THz 23,81 Bremslichtschalter	ATE
	LT 35 LT 40 LT 45 LT 50 LT 55			04.75 08.78 08.78 12.82 08.85	07.96 - ABS/ + Doppelbereifung 3) 07.96 - ABS 07.96 - ABS 07.96 - ABS 07.96 - ABS		03.2125-1712.3 03.3526-2002.3	010204 340010	2		THz 25,40 Bremslichtschalter	ATE
	LT 28 LT 31 LT 35			04.75 04.75 04.75	07.96 07.96 07.96		24.9257-8027.5 24.9257-8028.5 13.0441-5720.2	230039 230040 250122		☐ ☐ ☐	D=57 D=57 Dichtungssatz	ATE ATE ATE
	LT 40 LT 45 LT 50 LT 55			08.78 08.78 12.82 08.85	07.96 07.96 07.96 07.96		13.9571-0041.2 13.9571-0042.2 24.9257-0041.5 24.9257-0042.5 13.0441-5720.2	210259 210260 230049 230050 250122		☐ ☐ ☐ ☐ ☐	D=57 D=57 D=57 D=57 Dichtungssatz	ATE ATE ATE ATE ATE
	LT 28 LT 31 LT 35 LT 40 LT 45 LT 50 LT 55			04.75 04.75 04.75 08.78 08.78 12.82 08.85	07.96 07.96 07.96 07.96 07.96 07.96 07.96		13.0460-5701.2 13.0460-0091.2	605701 610091			20392 18,5 /WE Belagsatz-Zubehör	ATE ATE
	LT 28 LT 28 LT 28 LT 31 LT 31 LT 31 LT 35 LT 40 LT 45 LT 50 LT 55	◀ 28-B-018541 ▶ 28-B-019163 28-D-007274 ◀ 28-B-018541 ▶ 28-B-019163 28-D-007274 28-B-012411 28-B-012411 28-B-012411	28-D-007273 28-D-007273 28-D-007273 28-D-007273 28-D-007273 28-D-007273	07.96 07.96 07.96 07.96 12.82 08.85			24.0120-0114.2	420114			281 19,9 18,0 +B	
	LT 28 LT 31 LT 35			04.75 04.75 04.75	07.96 07.96 07.96		24.5224-0299.3	331262	2		L=300	
	LT 40 LT 45 LT 50 LT 55			08.78 08.78 12.82 08.85	07.96 07.96 07.96 07.96		24.5224-0440.3	331378	2		L=445	
	LT 28 LT 31 LT 35 LT 40 LT 45		28-D-007273 28-D-007273 28-D-007273 28-D-007273 28-D-007273	04.75 04.75 04.75 08.78 08.78			83.6301-0355.3	330343	2		L=355	
	LT 28 LT 31 LT 35 LT 40 LT 45 LT 50 LT 55	28-D-007274 28-D-007274 28-D-007274 28-D-007274 28-D-007274		07.96 07.96 07.96 07.96 12.82 08.85			83.6124-0362.3	330715	1		L=360	
↓	LT 28			04.75	07.96 PR: 1X1		83.7724-0467.3	331274	1		L=465	

1) - twin tyres / - ruote gemellate / - roue jumelée / - cubierta doble
 2) - ABS/ - twin tyres / - ABS/ - ruote gemellate / - ABS/ - roue jumelée / - ABS/ - cubierta doble
 3) - ABS/ + twin tyres / - ABS/ + ruote gemellate / - ABS/ + roue jumelée / - ABS/ + cubierta doble





VOLKSWAGEN LT/LT 4x4 (75-96)

	LT 31 LT 35 LT 40 LT 45 LT 50 LT 55			04.75 04.75 08.78 08.78 12.82 08.85	07.96 07.96 07.96 07.96 07.96 07.96	PR: 1X1 PR: 1X1 PR: 1X1 PR: 1X1 PR: 1X1 PR: 1X1	83.7724-0467.3	331274	1		L=465
	LT 28 LT 31 LT 35			04.75 04.75 04.75	07.96 07.96 07.96		03.3225-5511.3	020102			Rz 25,40
	LT 35 LT 35 LT 40 LT 45 LT 50 LT 55	29-M-009907		04.75 10.90 07.96 08.78 07.96 08.78 07.96 12.82 07.96 08.85 07.96	07.96 07.96 07.96 07.96 07.96 07.96 07.96 07.96 07.96 07.96 07.96	- Doppelbereifung ¹⁾ + Doppelbereifung ²⁾ - Radstand 3650 mm ³⁾ - Radstand 3650 mm ³⁾ - Radstand 3650 mm ³⁾ - Radstand 3650 mm ³⁾	03.3225-5512.3	020103			Rz 25,40
	LT 40 LT 45 LT 50 LT 55			08.78 08.78 12.82 08.85	07.96 07.96 07.96 07.96	+ Radstand 3650 mm ⁴⁾ + Radstand 3650 mm ⁴⁾ + Radstand 3650 mm ⁴⁾ + Radstand 3650 mm ⁴⁾	24.3226-0901.3	020295			Rz 26,99
	LT 28 LT 31		28-A0020471 28-A0020471	04.75 04.75			03.0137-9151.2	669151			Bremsbacken-Zubehör
	LT 28 LT 31 LT 35	28-A0020472 28-A0020472		07.96 07.96			03.0137-0259.2 03.0137-9159.2	650259 669159			252 x 56 HEB Bremsbacken-Zubehör
	LT 35 LT 40 LT 45 LT 50 LT 55	28-D-007274 28-D-007274 28-D-007274		07.96 07.96 07.96 12.82 07.96 08.85 07.96	07.96 07.96 07.96 07.96 07.96 07.96	+ Doppelbereifung ²⁾	03.0137-0252.2 03.0137-9152.2	650252 669152			270 x 66 HEB Bremsbacken-Zubehör
	LT 28 LT 31 LT 35			04.75 04.75 04.75	07.96 07.96 07.96		24.0225-2003.1	480047			252/253,5 x 65,5
	LT 35 LT 40 LT 45 LT 50 LT 55			04.75 08.78 08.78 12.82 07.96 08.85 07.96	07.96 07.96 07.96 07.96 07.96 07.96	+ Doppelbereifung ²⁾	24.0227-0001.1	480052			270/271,5 x 71
	LT 28 LT 31	◀	28-D-007246 28-D-007246	04.75 04.75			24.3727-0112.2 24.3727-0113.2	580112 580113	<input type="checkbox"/> <input type="checkbox"/>		L=1042 L=1690
	LT 28 LT 31	▶	28-D-007246 28-D-007246	04.75 04.75			24.3727-0113.2 24.3727-0112.2	580113 580112	<input type="checkbox"/> <input type="checkbox"/>		L=1690 L=1042
	LT 28 LT 31		28-D-007247 28-D-007247	07.96 07.96			24.3727-0112.2 24.3727-0113.2	580112 580113	<input type="checkbox"/> <input type="checkbox"/>		L=1042 L=1690
	LT 35		29-G-014001	07.96		+ Einfachbereifung ⁵⁾	24.3727-0112.2 24.3727-0113.2	580112 580113	<input type="checkbox"/> <input type="checkbox"/>		L=1042 L=1690
	LT 50 LT 55		29-G-014001	07.96 08.85 07.96			24.3727-0120.2	580120	2 <input type="checkbox"/>		L=1400
	LT 28 LT 31 LT 35 LT 40 LT 45 LT 50 LT 55	◀ ◀ ◀ ◀ ◀ ◀ ◀	28-D-007274 28-D-007274 28-D-007274 28-D-007274 28-D-007274	07.96 07.96 07.96 07.96 07.96 12.82 07.96 08.85 07.96			24.3728-0126.2	590126			L=1819

VOLKSWAGEN PASSAT Limousine (85-88)

	1.3 1.6 1.6 D 1.6 TD 1.8 2.0 2.2	◀ ◀ ◀ ◀ ◀ ◀ ◀		08.84 08.84 08.84 08.84 08.84 08.84 08.85	07.86 03.88 03.88 03.88 03.88 03.88 03.88		03.7750-0302.4	300071			9" ATE
	2.2	◀100		01.85	03.88		03.2122-9612.3	010159			THz 22,20 ATE
	1.3 1.6 1.6 D 1.6 TD 1.8 2.0 2.2	▶ ▶ ▶ ▶ ▶ ▶ ▶		08.84 08.84 08.84 08.84 08.84 08.84 08.85	07.86 03.88 03.88 03.88 03.88 03.88 03.88		03.2120-2331.3	010110			THz 20,64 ATE
	1.3 1.6 1.6 D 1.6 TD 1.8 2.0 2.2			08.84 08.84 08.84 08.84 08.84 08.84 08.85	07.86 03.88 03.88 03.88 03.88 03.88 03.88		11.0441-4808.2 11.0101-4801.2 24.0102-4801.2	250022 260006 260085			Dichtungssatz ATE Hülensatz ATE Hülensatz+Schrauben ATE
	1.3 1.6 1.6 D 1.6 TD 1.8 2.0 2.2		85	08.84 08.84 08.84 08.84 08.84 08.84 08.85	07.86 03.88 03.88 03.88 03.88 03.88 03.88		24.3541-1610.5 24.3541-1609.5 24.0101-4301.2 11.0101-5403.2	240040 240039 260047 260010	<input type="checkbox"/> <input type="checkbox"/>		D=54, - Halter TRW D=54, - Halter TRW Bremsattel-Zubehör TRW Fallenbalgsatz TRW
	2.2		100	01.85	03.88		24.3541-1610.5 24.3541-1609.5 24.0101-4301.2 11.0101-5403.2	240040 240039 260047 260010	<input type="checkbox"/> <input type="checkbox"/>		D=54, - Halter TRW D=54, - Halter TRW Bremsattel-Zubehör TRW Fallenbalgsatz TRW
	1.3 1.6			08.84 08.84	07.86 03.88		13.0460-7032.2	607032			20887 19,7 +/Zub VW

1) - twin tyres / - ruote gemellate / - roue jumelée / - cubierta doble
 2) + twin tyres / + ruote gemellate / + roue jumelée / + cubierta doble
 3) - wheel base 3650mm / - passo 3650mm / - empattement 3650mm / - distancia entre ejes 3650mm
 4) + wheel base 3650 mm / + passo 3650 mm / + empattement 3650 mm / + distancia entre ejes 3650 mm
 5) + single tyre / + ruota singola / + roue simple / + cubierta simple





VOLKSWAGEN PASSAT Limousine (85-88)

	1.8 1.8 2.0 2.2	85		08.84 08.84 08.84 08.85	03.88 03.88 03.88 03.88	+ verstärkte Bremse/+ Schaltgetr. ¹⁾ + Automatikgetriebe ³⁾	24.0220-0018.1 24.0220-0718.2	480019 480209	ohne Sensorring ²⁾ ohne Sensorring ²⁾	200/201 x 50 - Lager 200/201 x 50 + Lager
	1.3 1.6 1.8			08.84 08.84 08.84	07.86 03.88 03.88	- verstärkte Bremse ⁴⁾ - verstärkte Br./+ Schaltgetr. ⁵⁾ - verstärkte Br./+ Schaltgetr. ⁵⁾	03.0520-0215.3	690215		15,87/180x31 TopKit VW
	1.6 D			08.84	03.88	- verstärkte Br./+ Schaltgetr. ⁵⁾	03.0520-0114.3	690114		14,29/180x31 TopKit VW
	1.3 1.6 1.6 1.6 D 1.6 D 1.6 TD 1.8 1.8 2.0 2.2	85		08.84 08.84 08.84 08.84 08.84 08.84 08.84 08.84 08.84 08.85	07.86 03.88 03.88 03.88 03.88 03.88 03.88 03.88 03.88 03.88	+ verstärkte Bremse ⁶⁾ + verstärkte Bremse/+ Schaltgetr. ¹⁾ + Automatikgetriebe ³⁾ + verstärkte Bremse/+ Schaltgetr. ¹⁾ + Automatikgetriebe ³⁾ + verstärkte Bremse/+ Schaltgetr. ¹⁾ + Automatikgetriebe ³⁾	03.0420-0417.3	680417		17,46/200x40 Kit VW
	1.3 1.6 1.6 D 1.6 TD 1.8 2.0 2.2	85		08.84 08.84 08.84 08.84 08.84 08.84 08.85	07.86 03.88 03.88 03.88 03.88 03.88 03.88		24.3727-0108.2	580108	1	L=2565
	2.0 2.2	◀		08.84 08.85	03.88 03.88		03.2419-8150.3	030019		Gz 19,05
	2.0 2.2			08.84 08.85	03.88 03.88		03.2522-4211.3	040017		Nz 22,20
	1.3 1.6 1.8	◀		08.84 08.84 08.84	07.86 03.88 03.88		24.3728-0114.2	590114		L=944

VOLKSWAGEN PASSAT Variant (73-84)

	1.3 1.5 1.6			05.73 05.73 09.75	07.80 08.75 07.80	-	03.3526-2002.3 24.3526-1900.0	340010 340038	1 2	Bremslichtschalter Bremslichtschalter
	1.3 1.6 1.9	◀		08.80 08.80 01.81	09.82 09.82 07.81		03.3526-2002.3	340010	1	Bremslichtschalter
	1.3 1.6 1.9	◀		08.80 08.80 01.81	09.82 09.82 07.81		03.3526-2002.3	340010	2	Bremslichtschalter
	1.3 1.6 1.6 1.6 TD 1.8 i 1.9 2.0 2.2	◀		10.82 10.82 08.80 12.81 08.83 01.81 08.83 01.81	07.84 07.84 07.83 07.84 07.84 07.83 07.84 07.83	+	03.3526-2002.3	340010	2	Bremslichtschalter
	1.5 1.5 D 1.6 1.6 i			05.73 08.77 09.75 06.78	08.75 07.80 04.78 07.80	+	24.3526-1900.0	340038	2	Bremslichtschalter
	1.6 D	◀		02.79	09.82		03.3526-2002.3	340010	1	Bremslichtschalter
	1.6 D	◀		02.79	09.82		03.3526-2002.3	340010	2	Bremslichtschalter
	1.3 1.6 1.6 D 1.6 TD 1.8 i 1.9 2.0	▶		08.81 10.82 02.79 12.81 08.83 01.81 08.83	07.84 07.84 07.84 07.84 07.84 07.83 07.84		03.2120-2331.3	010110		THz 20,64 ATE
	1.3 1.5 1.6 1.6 i			05.73 05.73 09.75 06.78	07.77 08.75 07.77 07.80	+	03.3508-7504.3	310045		ohne Warneinrichtung Behälter ATE
	1.3 1.5 1.5 D 1.6 1.6 1.6 i			05.73 05.73 08.77 09.75 08.78 06.78	01.80 08.75 01.80 07.78 01.80 01.80	+ Schwimmsättel ⁷⁾ + Schaltgetriebe ⁸⁾ + / + Schwimmsättel ⁹⁾	11.0441-4402.2	250014		Dichtungssatz ATE
	1.3 1.5 D 1.6 1.6 D 1.6 i 1.6 TD 1.8 1.9			02.80 02.80 02.80 02.79 06.78 12.81 01.83 01.81	11.83 07.80 11.83 11.83 07.80 11.83 11.83 07.83	+ Faustsättel ¹⁰⁾ + / + Faustsättel ¹¹⁾	11.0441-4808.2 11.0101-4801.2 24.0102-4801.2	250022 260006 260085		Dichtungssatz ATE Hülsensatz ATE Hülsensatz+Schrauben ATE

1) + heavy duty br./+ manual transm. / + fr.rinforzato/+ scatola camb.velocità / + frein renforcé/ + transm.mécanique / + freno reforzado/ + camb.de velocidad
2) without sensor ring / senza sensori / sans secours ABS / sin anillo sensor ABS
3) + autom.transmission / + scatola cambio automatico / + transmission automatique / + cambio automático
4) - heavy duty brake / - freno rinforzato / - frein renforcé / - freno reforzado
5) - heavy duty br./+ manual transm. / - fr.rinforzato/+ scatola camb.velocità / - frein renforcé/ + transm.mécanique / - freno reforzado/ + camb.velocidad
6) + heavy duty brake / + freno rinforzato / + frein renforcé / + freno reforzado

7) + floating calipers / + pinze flottante / + étriers flottant / + pinzas flotante
8) + manual transmission / + scatola cambio velocità / + transmission mécanique / + cambio de velocidad
9) + / + floating calipers / + / + pinze flottanti / + / + étriers flottant / + / + pinza flotante
10) + fist type calipers / + pinza freno flottante / + étriers à griffe / + pinza de puno
11) + / + fist type caliper / + / + pinza flottante / + / + étriers à griffe / + / + pinza de puno

VOLKSWAGEN PASSAT Variant (73-84)

	2.0			08.83	11.83		11.0441-4808.2	250022		Dichtungssatz	ATE	
	2.2			01.81	07.83	+ S	11.0101-4801.2	260006		Hülsensatz	ATE	
							24.0102-4801.2	260085		Hülsensatz+Schrauben	ATE	
	1.3			12.83	07.84		11.0441-4808.2	250022		Dichtungssatz	ATE	
	1.6			12.83	07.84		11.0101-4801.2	260006		Hülsensatz	ATE	
	1.6 D			12.83	07.84		24.0102-4801.2	260085		Hülsensatz+Schrauben	ATE	
	1.6 TD			12.83	07.84							
	1.8			12.83	07.84							
	2.0			12.83	07.84							
		1.3			05.73	01.80		13.0460-4029.2	604029		20228 18,5	ATE
		1.5			05.73	08.75						
		1.5 D			08.77	01.80	+ Schwimmsättel 1)					
		1.6			09.75	07.78						
		1.6			08.78	01.80	+ Schaltgetriebe 2)					
		1.6 i			06.78	01.80	+ S J / + Schwimmsättel 3)					
		1.3			02.80	07.84		13.0460-7032.2	607032		20887 19,7 +/Zub	VW
		1.5 D			02.80	07.80	+ Faustsättel 4)					
		1.6			02.80	07.84						
1.6 D				02.79	07.84							
1.6 i				02.80	07.80	+ S J / + Faustsättel 5)						
1.6 TD				12.81	07.84							
	1.8			01.83	07.84							
	1.8 i			12.83	07.84		13.0460-7033.2	607033		20887 15,3 +/Zub	VW	
	1.9			01.81	07.83							
	2.0			08.83	07.84							
	2.2			01.81	07.83	+ S						
	1.3			05.73	07.84		24.0112-0106.1	412106		239 12,0 10,0 +S +B		
	1.5			05.73	08.75		24.0312-0106.1	512106		239 12,0 10,0 +S +B PD		
	1.5 D			08.77	07.80							
	1.6			09.75	07.84							
	1.6 D			02.79	07.84							
	1.6 i			06.78	07.80	+ S J						
	1.6 TD			12.81	07.84							
	1.8			01.83	07.84							
	1.8 i			12.83	07.84		24.0120-0123.1	420123		239 20,0 18,0 V L +S +B		
	1.9			01.81	07.83		24.0320-0123.1	520123		239 20,0 18,0 V L +S +B PD		
	2.0			08.83	07.84							
	2.2			01.81	07.83	+ S						
	1.3			05.73	07.84		24.5170-0315.3	331309	2	L=315		
	1.5			05.73	08.75		24.5108-0266.3	330038	2	L=266	TRW	
	1.5 D			08.77	07.80							
	1.6			09.75	07.84							
	1.6 D			02.79	07.84							
	1.6 i			06.78	07.80	+ S J						
	1.6 TD			12.81	07.84							
	1.8			01.83	07.84							
	1.9			01.81	07.83							
	2.0			08.83	07.84							
	2.2			01.81	07.83	+ S						
	1.3			05.73	07.80		24.5204-0180.3	331461	2	L=180		
	1.5			05.73	08.75							
	1.5 D			08.77	07.80							
	1.6			09.75	07.80							
	1.6 i			06.78	07.80	+ S J						
		1.3			08.80	07.84		24.5204-0180.3	331461	2	L=180	
		1.6			08.80	07.84		24.5201-0164.3	331414	2	L=164	
		1.6 D			02.79	07.84						
		1.6 TD			12.81	07.84						
		1.9			01.81	07.83						
		2.0			08.83	07.84						
	2.2			01.81	07.83	+ S						
	1.9			01.81	07.81		03.3215-2311.3	020018		Rz 15,87		
	2.2			01.81	07.81	+ S	24.3215-0903.3	020154		Rz 15,87		
		1.3			05.73	07.84		03.3217-2112.3	020027		Rz 17,46	
		1.5			05.73	08.75		24.3217-0908.3	020167		Rz 17,46	
		1.5 D			08.77	07.80						
		1.6			09.75	07.84						
		1.6 D			02.79	07.84						
		1.6 i			06.78	07.80	+ S J					
	1.6 TD			12.81	07.84							
	1.8			01.83	07.84							
	1.9			08.81	07.83							
	2.0			08.83	07.84							
2.2			08.81	07.83	+ S							
	1.3			08.78	07.84		03.0137-0146.2	650146		200 x 40 HEB		
	1.5 D			08.78	07.80		03.0137-9041.2	669041		Bremsbacken-Zubehör		
	1.6			08.78	07.84							
	1.6 D			02.79	07.84							
	1.6 i			08.78	07.80	+ S J						
	1.6 TD			12.81	07.84							
	1.8			01.83	07.84							
	1.9			08.81	07.83							
2.0			08.83	07.84								
2.2			01.81	07.83	+ S							

1) + floating calipers / + pinze flottante / + étriers flottant / + pinzas flotante

2) + manual transmission / + scatola cambio velocità / + transmission mécanique / + cambio de velocidad















3) + S J / + floating calipers / + S J / + pinze flottanti / + S J / + étriers flottant / + S J / + pinza flotante

4) + fist type calipers / + pinza freno flottante / + étriers à griffe / + pinza de puno

5) + S J / + fist type caliper / + S J / + pinza flotante / + S J / + étriers à griffe / + S J / + pinza de puno

6) + cast iron / + ghisa / + fonte grise / + fundición de gris

7) + aluminium / + alluminio / + aluminium / + aluminio

VOLKSWAGEN PASSAT Variant (73-84)										
	1.3 1.5 1.5 D 1.6 1.6 D 1.6 i 1.6 TD 1.8 1.9 2.0 2.2			05.73 05.73 08.77 09.75 02.79 06.78 12.81 01.83 01.81 08.83 01.81	07.84 08.75 07.80 07.84 07.84 07.80 + S J 07.84 07.84 07.84 07.84 07.83 + S		24.0220-0018.1 24.0220-0718.2	480019 480209	ohne Sensorring 1) ohne Sensorring 1)	200/201 x 50 - Lager 200/201 x 50 + Lager
	1.3 1.5 D 1.6 1.6 D 1.6 i 1.6 TD 1.8 1.9 2.0 2.2			08.78 08.78 08.78 02.79 06.78 12.81 01.83 08.81 08.83 08.81	07.84 07.80 07.84 07.84 07.80 + S J 07.84 07.84 07.83 07.84 07.83 + S		03.0420-0417.3	680417		17,46/200x40 Kit VW
	1.3 1.6 1.6 D 1.6 TD 1.8 1.9 2.0 2.2			08.80 08.80 02.79 12.81 01.83 01.81 08.83 01.81	07.84 07.84 07.84 07.84 07.84 07.83 07.84 07.83 + S		24.3727-0108.2	580108	1	L=2565
	1.3 1.5 1.5 D 1.6 1.6 i	32-42143626 32-42143626 32-42143626 32-42143626 32-42143626		07.80 08.75 07.80 07.80 07.80	07.80 08.75 07.80 07.80 07.80 + S J		03.6565-0101.3	320097		BRL 6/5 (4) ATE
	1.3 1.6 1.8	66		08.83 08.83 08.83	07.84 07.84 07.84		24.3728-0114.2	590114		L=944
VOLKSWAGEN PASSAT Variant (85-88)										
	1.3 1.6 1.6 D 1.6 TD 1.8 2.0 2.2			08.84 08.84 08.84 08.84 08.84 08.84 08.85	07.86 03.88 03.88 03.88 03.88 03.88 03.88		03.7750-0302.4	300071		9" ATE
	1.3 1.6 1.6 D 1.6 TD 1.8 2.0 2.2			08.84 08.84 08.84 08.84 08.84 08.84 08.85	07.86 03.88 03.88 03.88 03.88 03.88 03.88		03.2120-2331.3	010110		THz 20,64 ATE
	1.3 1.6 1.6 D 1.6 TD 1.8 2.0 2.2	85		08.84 08.84 08.84 08.84 08.84 08.84 08.85	07.86 03.88 03.88 03.88 03.88 03.88 03.88		11.0441-4808.2 11.0101-4801.2 24.0102-4801.2	250022 260006 260085		Dichtungssatz ATE Hülsensatz ATE Hülsensatz+Schrauben ATE
	1.8 Syncro 2.0 Syncro 2.2 2.2 Syncro	100		01.86 08.84 01.85 08.84	07.88 07.88 03.88 07.88		24.3541-1610.5 24.3541-1609.5 24.0101-4301.2 11.0101-5403.2	240040 240039 260047 260010	<input type="checkbox"/> <input type="checkbox"/>	D=54, - Halter TRW D=54, - Halter TRW Bremsattel-Zubehör TRW Fallenbalgsatz TRW
	1.3 1.6 1.6 D 1.6 TD 1.8			08.84 08.84 08.84 08.84 08.84	07.86 03.88 03.88 03.88 03.88		13.0460-7032.2	607032		20887 19,7 +/Zub VW
	2.0 2.2	85		08.84 08.85	03.88 03.88		13.0460-7033.2	607033		20887 15,3 +/Zub VW
	1.8 Syncro 2.0 Syncro 2.2 2.2 Syncro	100		01.86 08.84 01.85 08.84	07.88 07.88 03.88 07.88		13.0460-2957.2	602957		20168 16,0 /S TRW
	1.3 1.6 1.6 D 1.6 TD 1.8			08.84 08.84 08.84 08.84 08.84	07.86 03.88 03.88 03.88 03.88		24.0112-0106.1 24.0312-0106.1	412106 512106		239 12,0 10,0 +S +B 239 12,0 10,0 +S +B PD
	2.0 2.2	85		08.84 08.85	03.88 03.88		24.0120-0123.1 24.0320-0123.1	420123 520123		239 20,0 18,0 V L +S +B 239 20,0 18,0 V L +S +B PD
	1.8 Syncro 2.0 Syncro 2.2	100		01.86 08.84 01.85	07.88 07.88 03.88		24.0120-0128.1 24.0320-0128.1	420128 520128		256 20,0 18,0 V L +S +B 256 20,0 18,0 V L +S +B PD

1) without sensor ring / senza sensori / sans secours ABS / sin anillo sensor ABS



VOLKSWAGEN PASSAT Variant (85-88)

	2.2 Syncro			08.84	07.88		24.0120-0128.1	420128			256 20,0 18,0 V L +S +B
							24.0320-0128.1	520128			256 20,0 18,0 V L +S +B PD
	1.3			08.84	07.86		24.5170-0315.3	331309	2		L=315
	1.6			08.84	03.88						
	1.6 D			08.84	03.88						
	1.6 TD			08.84	03.88						
	1.8			08.84	03.88						
	1.8 Syncro			01.86	07.88						
	2.0			08.84	03.88						
	2.0 Syncro			08.84	07.88						
	2.2			01.85	03.88						
	2.2 Syncro			08.84	07.88						
	2.2	100		01.85	03.88		24.3364-1605.5	240011	<input type="checkbox"/>		D=36, - Halter
							24.3364-1606.5	240012	<input type="checkbox"/>		TRW
							24.0101-3601.2	260044			Bremssattel-Zubehör
							11.0101-5403.2	260010			Faltenbalgsatz
	1.8 Syncro			01.86	07.88		24.3384-1603.5	240015	<input type="checkbox"/>		D=38, - Halter
	2.0 Syncro			08.84	07.88		24.3384-1604.5	240016	<input type="checkbox"/>		TRW
	2.2 Syncro			08.84	07.88		24.0101-3601.2	260044			Bremssattel-Zubehör
	1.8 Syncro			01.86	07.88		13.0460-2937.2	602937			20961 15,2 /Zub/S
	2.0 Syncro			08.84	07.88		13.0460-0419.2	610419			TRW
	2.2	100		01.85	03.88						Belagsatz-Zubehör
	2.2 Syncro			08.84	07.88						TRW
	2.2	100		01.85	03.88		24.0110-0111.1	410111		ohne Sensorring ¹⁾	226 10,0 8,0 +B
							24.0110-0275.2	410275		mit Sensorring ²⁾	226 10,0 8,0 +B
	1.8 Syncro			01.86	07.88		24.0110-0151.1	410151			239 10,0 8,0 +S +B
	2.0 Syncro			08.84	07.88						
	2.2 Syncro			08.84	07.88						
	1.3			08.84	07.86		24.5204-0180.3	331461	<input type="checkbox"/>		L=180
	1.6			08.84	03.88		24.5201-0164.3	331414	<input type="checkbox"/>		L=164
	1.6 D			08.84	03.88						
	1.6 TD			08.84	03.88						
	1.8			08.84	03.88						
	2.0			08.84	03.88						
	2.2	85		08.85	03.88						
	2.2	100		01.85	03.88		24.5170-0161.3	331308	2		L=161
	1.8 Syncro			01.86	07.88		83.6204-0240.3	330718	2		L=240
	2.0 Syncro			08.84	07.88		24.5170-0161.3	331308	2	am Bremssattel ³⁾	L=161
	2.2 Syncro			08.84	07.88						
	1.3			08.84	07.86		03.3217-2112.3	020027		+ GG ⁴⁾	Rz 17,46
	1.6			08.84	03.88		24.3217-0908.3	020167		+ ALU ⁵⁾	Rz 17,46
	1.6 D			08.84	03.88						
	1.6 TD			08.84	03.88						
	1.8			08.84	03.88						
	2.0			08.84	03.88						
	2.2	85		08.85	03.88						
	1.3			08.84	07.86		03.0137-0146.2	650146			200 x 40 HEB
	1.6			08.84	03.88		03.0137-9041.2	669041			Bremssack-Zubehör
	1.6 D			08.84	03.88						
	1.6 TD			08.84	03.88						
	1.8			08.84	03.88						
	2.0			08.84	03.88						
	2.2	85		08.85	03.88						
	1.3			08.84	07.86		24.0220-0018.1	480019		ohne Sensorring ¹⁾	200/201 x 50 - Lager
	1.6			08.84	03.88		24.0220-0718.2	480209		ohne Sensorring ¹⁾	200/201 x 50 + Lager
	1.6 D			08.84	03.88						
	1.6 TD			08.84	03.88						
	1.8			08.84	03.88						
	2.0			08.84	03.88						
	2.2	85		08.85	03.88						
	1.3			08.84	07.86		03.0420-0417.3	680417			17,46/200x40 Kit
	1.6			08.84	03.88						
	1.6 D			08.84	03.88						
	1.6 TD			08.84	03.88						
	1.8			08.84	03.88						
	2.0			08.84	03.88						
	2.2	85		08.85	03.88						
	1.3			08.84	07.86		24.3727-0108.2	580108	1	<input type="checkbox"/>	L=2565
	1.6			08.84	03.88						
	1.6 D			08.84	03.88						
	1.6 TD			08.84	03.88						
	1.8			08.84	03.88						
	2.0			08.84	03.88						
	2.2	85		08.85	03.88						
	1.8 Syncro			01.86	07.88		03.6058-0301.3	320072			BR 25/5 (3)
	2.0 Syncro			08.84	07.88						ATE
	2.2 Syncro			08.84	07.88						
	1.8 Syncro			01.86	07.88		03.2419-8150.3	030019			Gz 19,05
	2.0			08.84	03.88						
	2.0 Syncro			08.84	07.88						
	2.2			08.85	03.88						
	2.2 Syncro			08.84	07.88						

¹⁾ without sensor ring / senza sensori / sans secours ABS / sin anillo sensor ABS
²⁾ with sensor ring / con sensori / avec secours ABS / con anillo sensor ABS
³⁾ on the brake caliper / sulla pinza freno / sur l'étrier de frein / a la pinza de freno
⁴⁾ + cast iron / + ghisa / + fonte grise / + fundición de gris
⁵⁾ + aluminium / + alluminio / + aluminium / + aluminio



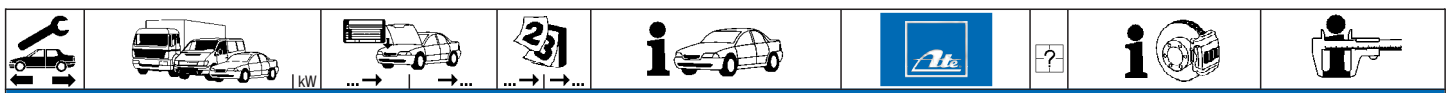

VOLKSWAGEN PASSAT Variant (85-88)

	1.8 Syncro 2.0 2.0 Syncro 2.2 2.2 Syncro			01.86 07.88 08.84 03.88 08.84 07.88 08.85 03.88 08.84 07.88		03.2522-4211.3	040017			Nz 22,20
	1.3 1.6 1.8	◀ ◀ ◀		08.84 07.86 08.84 03.88 08.84 03.88		24.3728-0114.2	590114			L=944

VOLKSWAGEN PASSAT/SANTANA Limousine (73-84)

	1.3 1.5 1.6			05.73 07.79 + Bremsgerät ¹⁾ 05.73 08.75 + Bremsgerät/ + Schaltgetriebe ²⁾ 09.75 07.79 + Bremsgerät/ + Schaltgetriebe ²⁾		03.2120-1531.3 03.3526-2002.3 24.3526-1900.0	010092 340010 340038			THz 20,64 Bremslichtschalter Bremslichtschalter	ATE
	1.3 1.6			08.79 07.83 + Bremsgerät ¹⁾ 08.79 07.83 + Bremsgerät/ + Schaltgetriebe ²⁾		03.2120-1531.3 03.3526-2002.3	010092 340010	1		THz 20,64 Bremslichtschalter	ATE
	1.3 1.6			08.79 07.83 + Bremsgerät ¹⁾ 08.79 07.83 + Bremsgerät/ + Schaltgetriebe ²⁾		03.2120-1491.3 03.3526-2002.3	010089 340010	2		THz 20,64 + WE Bremslichtschalter	ATE
	1.3 1.6	◀ ◀		08.83 07.84 + Bremsgerät ¹⁾ 08.83 07.84 + Bremsgerät/ + Schaltgetriebe ²⁾		03.3526-2002.3	340010	2		Bremslichtschalter	
	1.5 1.5 D 1.6 1.6 1.6 i 1.6 i			05.73 08.75 + Automatikgetriebe ³⁾ 08.77 07.80 09.75 07.80 + Automatikgetriebe ³⁾ 08.78 01.80 + A CH 08.76 07.77 + S J 02.79 07.80		03.3526-2002.3 24.3526-1900.0	340010 340038	1 2		Bremslichtschalter Bremslichtschalter	
	1.6 1.6 D 1.6 TD	◀ ◀ ◀		08.80 07.81 + Automatikgetriebe ³⁾ 08.80 07.83 + Automatikgetriebe ³⁾ 12.81 07.83 + Automatikgetriebe ³⁾		03.3526-2002.3	340010	1		Bremslichtschalter	
	1.6 1.6 D 1.6 TD	◀ ◀ ◀		08.80 07.81 + Automatikgetriebe ³⁾ 08.80 07.83 + Automatikgetriebe ³⁾ 12.81 07.83 + Automatikgetriebe ³⁾		03.3526-2002.3	340010	2		Bremslichtschalter	
	1.6 1.6 D 1.8 i	◀ ◀ ◀		08.81 07.83 + Automatikgetriebe ³⁾ 08.80 07.83 + Schaltgetriebe ⁴⁾ 01.83 07.83 + Schaltgetriebe ⁴⁾		03.2120-1531.3 03.3526-2002.3 03.2120-1491.3	010092 340010 010089	1		THz 20,64 Bremslichtschalter THz 20,64 + WE	ATE ATE
	1.6 1.6 D 1.6 TD 1.8 i 1.8 i 2.0 2.2	◀ ◀ ◀ ◀ ◀ ◀ ◀		08.83 07.84 + Automatikgetriebe ³⁾ 08.83 07.84 08.83 07.84 08.83 07.84 01.83 07.84 + Automatikgetriebe ³⁾ 08.83 07.84 01.81 07.83 + S		03.3526-2002.3	340010	2		Bremslichtschalter	
	1.9	◀		08.81 07.83		03.2120-1531.3 03.3526-2002.3	010092 340010	1		THz 20,64 Bremslichtschalter	ATE
	1.9	◀		08.81 07.83		03.3526-2002.3	340010	2		Bremslichtschalter	
	1.5 1.6	◀ ◀		08.73 08.75 + S / -Bremsgerät/+Schaltgetr. ⁵⁾ 09.75 07.78 + S / -Bremsgerät/+Schaltgetr. ⁵⁾		24.3526-1900.0	340038	2		Bremslichtschalter	
	1.3 1.6	▶ ▶		08.83 07.84 + Bremsgerät/ + Schaltgetriebe ²⁾ 08.83 07.84 + Bremsgerät/ + Schaltgetriebe ²⁾		03.2120-2331.3	010110			THz 20,64	ATE
	1.6 1.6 D 1.6 TD 1.8 i 1.9 2.0	▶ ▶ ▶ ▶ ▶ ▶		08.81 07.83 + Automatikgetriebe ³⁾ 08.80 07.84 12.81 07.84 01.83 07.84 + Automatikgetriebe ³⁾ 01.81 07.83 08.83 07.84		03.2120-2331.3	010110			THz 20,64	ATE
	1.3 1.5 1.6 1.6 i			05.73 07.77 05.73 08.75 09.75 07.77 08.76 07.80		03.3508-7504.3	310045		ohne Warneinrichtung	Behälter	ATE
	1.3 1.5 D 1.6 D			05.73 07.82 08.77 07.80 08.80 08.81		11.0441-4402.2	250014			Dichtungssatz	ATE
	1.5 1.6 1.6 1.6 i			05.73 08.75 09.75 07.78 08.78 01.80 + Schaltgetriebe ⁴⁾ 10.76 01.80 + S J		11.0441-4402.2	250014			Dichtungssatz	ATE
	1.3 1.6 1.6 D 1.6 i 1.6 TD 1.8 i 1.9 2.0			08.82 11.83 02.80 11.83 09.81 11.83 02.79 07.80 12.81 11.83 01.83 11.83 01.81 07.83 08.83 11.83 01.81 07.83 + S		11.0441-4808.2 11.0441-4804.2 11.0101-4801.2 24.0102-4801.2	250022 250019 260006 260085		f.Vornr.-8007/8008-8503/8504 ⁶⁾	Dichtungssatz Dichts.a.(+Sich.Ring) Hülsensatz Hülsensatz+Schrauben	ATE ATE ATE ATE
	1.3 1.6 1.6 D 1.6 TD 1.8 i 2.0			12.83 07.84 12.83 07.84 12.83 07.84 12.83 07.84 12.83 07.84 12.83 07.84		11.0441-4808.2 11.0101-4801.2 24.0102-4801.2	250022 260006 260085			Dichtungssatz Hülsensatz Hülsensatz+Schrauben	ATE ATE ATE

1) + booster unit / + servofreno / + servo-frein / + servofreno
2) + booster unit / + manual transm. / + servofreno/+ scatola camb.velocità / + servo-frein/ + transm.mécanique / + servofreno/ + camb.de velocidad
3) + autom.transmission / + scatola cambio automatico / + transmission automatique / + cambio automático
4) + manual transmission / + scatola cambio velocità / + transmission mécanique / + cambio de velocidad
5) + S / - booster unit/+man.transm. / + S / - servofr./+ scatola camb.velocità / + S / - servofr./ + transm.mécan. / + S / - servofr./ + camb.de velocidad
6) f.p.artno.-8007/8008-8503/8504 / p.no.codice -8007/8008-8503/8504 / p.Av.ref.-8007/8008-8503/8504 / p.antes ref.-8007/8008-8503/8504













VOLKSWAGEN PASSAT/SANTANA Limousine (73-84)

	1.3	05.73	02.78	+ Schaltgetriebe 1)	13.0460-4028.2	604028		20228 15,3	ATE	
	1.5 D	08.77	07.78		13.0460-0029.2	610029		Belagsatz-Zubehör	ATE	
	1.3	03.78	07.82	+ Schaltgetriebe 1)	13.0460-4028.2	604028		20228 15,3	ATE	
	1.5	05.73	08.75		13.0460-0115.2	610115		Belagsatz-Zubehör	ATE	
	1.5 D	08.78	07.80	+ Schaltgetriebe 1)	13.0460-0905.2	610905		Belagsatz-Zubehör	TRW	
	1.6 D	08.80	08.81	+ Schaltgetriebe 1)						
	1.5	05.73	08.75	+ Automatikgetriebe 2)	13.0460-4029.2	604029		20228 18,5	ATE	
	1.5 D	08.77	07.78	+ Automatikgetriebe 2)						
	1.6	09.75	07.78	+ Automatikgetriebe 2)						
	1.6	09.75	01.80	+ Schaltgetriebe 1)						
1.6 i	09.75	07.78	+ Automatikgetriebe 2)							
1.3	08.82	07.84	- GT	13.0460-7032.2	607032		20887 19,7 +/Zub	VW		
1.6 D	09.81	07.84		+ Schaltgetriebe 1)						
1.6 TD	12.81	07.84								
1.8 i	01.83	07.84								
1.5 D	02.80	07.80	+ Automatikgetriebe 2)	13.0460-7032.2	607032		20887 19,7 +/Zub	VW		
1.6	02.80	07.84	+ Schaltgetriebe 1)							
1.6	02.80	07.84	+ Automatikgetriebe 2)							
1.6 D	08.80	07.84	+ Automatikgetriebe 2)							
1.6 i	02.80	07.80	+ Automatikgetriebe 2)							
1.6 TD	12.81	07.84	+ Automatikgetriebe 2)							
1.8 GT	12.83	07.84	+ Automatikgetriebe 2)							
1.8 i	01.83	07.84	+ Automatikgetriebe 2)							
1.9	01.81	07.83	+ Automatikgetriebe 2)							
2.0	08.83	07.84	+ Automatikgetriebe 2)							
1.6 i	09.75	07.80	+ S ⊕ ⊖	13.0460-7033.2	607033		20887 15,3 +/Zub	VW		
1.6 i	02.79	07.80								
1.8 GT	12.83	07.84								
1.9	01.81	07.83								
2.0	08.83	07.84								
2.2	01.81	07.83	+ S							
	1.3	05.73	07.82		24.0110-0151.1	410151		239 10,0 8,0 +S +B		
	1.5 D	08.77	07.80		24.0310-0151.1	510151		239 10,0 8,0 +S +B PD		
	1.6 D	08.80	08.81							
	1.3	08.82	07.84		24.0112-0106.1	412106		239 12,0 10,0 +S +B		
	1.5	05.73	08.75		24.0312-0106.1	512106		239 12,0 10,0 +S +B PD		
	1.6	09.75	07.84							
	1.6 D	09.81	07.84							
	1.6 TD	12.81	07.84							
	1.8 i	01.83	07.84		- GT					
	1.6 i	09.75	07.80	+ S ⊕ ⊖	24.0120-0123.1	420123		239 20,0 18,0 V L +S +B		
1.6 i	02.79	07.80		24.0320-0123.1	520123	239 20,0 18,0 V L +S +B PD				
1.8 GT	12.83	07.84								
1.9	01.81	07.83								
2.0	08.83	07.84								
2.2	01.81	07.83	+ S							
	1.3	05.73	07.84		24.5170-0315.3	331309	2	L=315	TRW	
	1.5	05.73	08.75		24.5108-0266.3	330038		L=266		
	1.5 D	08.77	07.80							
	1.6	09.75	07.84							
	1.6 D	08.80	07.84							
	1.6 i	09.75	07.80							
	1.6 TD	12.81	07.84							
	1.8 GT	12.83	07.84							
	1.8 i	01.83	07.84							
	1.9	01.81	07.83							
2.0	08.83	07.84								
	1.3	05.73	07.80		24.5204-0180.3	331461	2	L=180		
	1.5	05.73	08.75							
	1.5 D	08.77	07.80							
	1.6	09.75	07.80							
	1.6 i	09.75	07.80							
	1.3	08.80	07.84		24.5201-0164.3	331414	2	L=164		
	1.6	08.80	07.84		+ Schaltgetriebe 1)					
	1.6 D	08.80	07.84		+ Schaltgetriebe 1)					
	1.6	08.80	07.84	+ Automatikgetriebe 2)	24.5204-0180.3	331461		L=180		
	1.6 D	08.80	07.84	+ Automatikgetriebe 2)	24.5201-0164.3	331414		L=164		
1.6 TD	12.81	07.84								
1.9	01.81	07.83								
2.0	08.83	07.84								
2.2	01.81	07.83	+ S							
	1.3	05.73	07.84		03.3214-0812.3	020011		Rz 14,29		
	1.5	05.73	08.75		+ Schaltgetriebe 1)	24.3214-0902.3		020147		+ ALU 4)
	1.5 D	08.77	07.80	+ Schaltgetriebe 1)						
	1.6	09.75	07.81	+ Schaltgetriebe 1)						
	1.6 D	08.80	07.81	+ Schaltgetriebe 1)						
	1.6	08.81	07.84	+ Schaltgetriebe 1)	03.3215-2311.3	020018		Rz 15,87		
	1.6 D	08.81	07.84	+ Schaltgetriebe 1)	24.3215-0903.3	020154		+ ALU 4)		Rz 15,87
	1.8 i	01.83	07.84	- GT/ + Schaltgetriebe 5)						
	1.9	01.81	07.81							
	2.2	01.81	07.81	+ S						
1.5	05.73	08.75	+ Automatikgetriebe 2)	03.3217-2112.3	020027		Rz 17,46			
1.5 D	08.77	07.80	+ Automatikgetriebe 2)	24.3217-0908.3	020167		+ ALU 4)		Rz 17,46	
1.6	09.75	07.84	+ Automatikgetriebe 2)							
1.6 D	08.80	07.84	+ Automatikgetriebe 2)							

1) + manual transmission / + scatola cambio velocità / + transmission mécanique / + cambio de velocidad
 2) + autom.transmission / + scatola cambio automatico / + transmission automatique / + cambio automático
 3) + cast iron / + ghisa / + fonte grise / + fundición de gris
 4) + aluminium / + alluminio / + aluminium / + aluminio
 5) - GT/ + manual transm. / - GT/ + scatola cambio velocità / - GT/ + transmission mécanique / - GT/ + cambio de velocidad



VOLKSWAGEN PASSAT/SANTANA Limousine (73-84)									
	1.6 i 1.6 TD 1.8 i 1.9 2.0 2.2			09.75 07.80 12.81 07.84 01.83 07.84 - GT/ + Automatikgetriebe 3) 08.81 07.83 08.83 07.84 08.81 07.83 + (S)		03.3217-2112.3 020027 24.3217-0908.3 020167		+ GG 1) + ALU 2)	Rz 17,46 Rz 17,46
	1.3 1.5 1.5 D 1.6			05.73 07.78 05.73 08.75 + Schaltgetriebe 4) 08.77 07.78 + Schaltgetriebe 4) 09.75 07.78 + Schaltgetriebe 4)		03.0137-9006.2 669006			Bremsbacken-Zubehör
	1.3 1.5 D 1.6 1.6 D			08.78 07.84 08.78 07.80 + Schaltgetriebe 4) 08.78 07.84 + Schaltgetriebe 4) 08.80 07.84 + Schaltgetriebe 4)		03.0137-0126.2 650126 03.0137-9008.2 669008			180 x 31 HEB Bremsbacken-Zubehör
	1.5 D 1.6 1.6 D 1.6 i 1.6 TD 1.8 i 1.9 2.0 2.2			08.78 07.80 + Automatikgetriebe 5) 08.78 07.84 + Automatikgetriebe 5) 08.80 07.84 + Automatikgetriebe 5) 02.79 07.80 12.81 07.84 01.83 07.84 01.81 07.83 08.83 07.84 01.81 07.83 + (S)		03.0137-0146.2 650146 03.0137-9041.2 669041			200 x 40 HEB Bremsbacken-Zubehör
	1.3 1.5 1.5 D 1.6 1.6 D			05.73 07.84 05.73 08.75 + Schaltgetriebe 4) 08.77 07.80 + Schaltgetriebe 4) 09.75 07.84 + Schaltgetriebe 4) 08.80 07.84 + Schaltgetriebe 4)		24.0218-0007.1 480003 24.0218-0707.2 480211			180/181 x 38,5 - Lager 180/181 x 38,5 + Lager
	1.5 1.5 D 1.6 1.6 D 1.6 i 1.6 TD 1.8 i 1.9 2.0 2.2			05.73 08.75 + Automatikgetriebe 5) 08.77 07.80 + Automatikgetriebe 5) 09.75 07.84 + Automatikgetriebe 5) 08.80 07.84 + Automatikgetriebe 5) 02.79 07.80 12.81 07.84 01.83 07.84 01.81 07.83 08.83 07.84 01.81 07.83 + (S)		24.0220-0018.1 480019 24.0220-0718.2 480209		ohne Sensorring 6) ohne Sensorring 6)	200/201 x 50 - Lager 200/201 x 50 + Lager
	1.3 1.5 D 1.6 1.6 D			08.78 07.84 08.78 07.80 + Schaltgetriebe 4) 08.78 07.81 + Schaltgetriebe 4) 08.80 07.81 + Schaltgetriebe 4)		03.0520-0114.3 690114			14,29/180x31 TopKit VW
	1.6 1.6 D			08.81 07.84 + Schaltgetriebe 4) 08.81 07.84 + Schaltgetriebe 4)		03.0520-0215.3 690215			15,87/180x31 TopKit VW
	1.5 D 1.6 1.6 D 1.6 i 1.6 TD 1.8 i 1.9 2.0 2.2			08.78 07.80 + Automatikgetriebe 5) 08.78 07.84 + Automatikgetriebe 5) 08.80 07.84 + Automatikgetriebe 5) 02.79 07.80 12.81 07.84 01.83 07.84 - GT/ + Automatikgetriebe 3) 08.81 07.83 08.83 07.84 08.81 07.83 + (S)		03.0420-0417.3 680417			17,46/200x40 Kit VW
	1.3 1.6 1.6 D 1.6 TD 1.8 GT 1.8 i 1.9 2.0			08.80 07.84 08.80 07.84 08.80 07.84 12.81 07.84 12.83 07.84 01.83 07.84 01.81 07.83 08.83 07.84		24.3727-0108.2 580108	1		L=2565
	1.3 1.5 1.5 D 1.6 1.6 i	32-42143626 32-42143626 32-42143626 32-42143626 32-42143626		07.80 08.75 07.80 07.80 07.80		03.6565-0101.3 320097			BRL 6/5 (4) ATE
	1.3 1.6 1.8	◀ ◀ ◀ 66		08.83 07.84 08.83 07.84 08.83 07.84		24.3728-0114.2 590114			L=944
VOLKSWAGEN PASSAT (88-93)									
	1.6 1.6 TD 1.8 1.8 16V 1.9 D 1.9 TD 2.0 2.0 16V 2.8 VR6	◀ ◀ ◀ ◀ ◀ ◀ ◀ ◀ ◀		04.88 10.93 - ABS 08.88 10.93 - ABS 04.88 10.93 - ABS 04.88 07.92 - ABS 05.89 10.93 - ABS 03.91 10.93 - ABS 03.90 10.93 - ABS 04.88 10.93 - ABS 06.91 10.93 - ABS		03.7750-4302.4 300076			9" ATE
	1.6 1.6 TD 1.8 1.8 16V 1.9 D	▶ ▶ ▶ ▶ ▶		04.88 10.93 - ABS 08.88 10.93 - ABS 04.88 10.93 - ABS 04.88 07.92 - ABS 05.89 10.93 - ABS		03.7750-4902.4 300079			9" ATE

1) + cast iron / + ghisa / + fonte grise / + fundición de gris



































2) + aluminium / + alluminio / + aluminio / + aluminium / + aluminio













3) - GT/ + autom.transmission / - GT/+ scatola cambio autom. / - GT/ + transmission automatique / - GT/ + cambio automático

4) + manual transmission / + scatola cambio velocità / + transmission mécanique / + cambio de velocidad

5) + autom.transmission / + scatola cambio automatico / + transmission automatique / + cambio automático

6) without sensor ring / senza sensori / sans secours ABS / sin anillo sensor ABS









									
VOLKSWAGEN PASSAT (88-93)									
	1.9 TD 2.0 2.0 16V 2.8 VR6			03.91 03.90 04.88 06.91	10.93 10.93 10.93 10.93	- ABS - ABS - ABS - ABS	03.7750-4902.3 300079	9° ATE	
	1.6 1.6 TD 1.8 1.9 D 1.9 TD 2.0	55		04.88 08.88 08.90 05.89 03.91 03.90	07.91 07.91 07.91 07.91 07.91 07.91	- ABS - ABS - ABS - ABS - ABS - ABS	03.2120-3943.3 010532 03.3517-0101.2 390322	THz 20,64 Verschlußschraube ATE	
	1.6 1.6 TD 1.8 1.8 1.8 1.8 16V 1.9 D 1.9 TD 2.0 2.0 16V	55 66 79 82		08.91 08.91 08.91 04.88 04.88 04.88 08.91 08.91 08.91 08.88	10.93 10.93 10.93 10.93 07.90 07.91 10.93 10.93 10.93 07.91	- ABS - ABS - ABS - ABS - ABS - ABS - ABS - ABS - ABS - ABS	03.2122-1042.3 010137 03.3517-0101.2 390322	THz 22,20 Verschlußschraube ATE	
	1.6 Limousine			04.88	09.89	- ABS	24.3541-1609.5 240039 24.3541-1610.5 240040 11.0441-4808.2 250022 11.0101-4801.2 260006 24.0102-4801.2 260085 24.0101-4301.2 260047 11.0101-5403.2 260010	 	D=54, - Halter D=54, - Halter Dichtungssatz Hülensatz Hülensatz+Schrauben Bremsattel-Zubehör Fallenbalsatz TRW ATE ATE ATE TRW TRW
	1.6 1.6 Limousine 1.6 TD 1.6 Variant 1.8 1.8 16V 1.9 D 1.9 TD 2.0 2.0 16V 2.0 Syncro			10.89 04.88 08.88 04.88 04.88 04.88 05.89 03.91 03.90 08.88 10.90	10.93 09.89 10.93 09.89 10.93 07.92 10.93 10.93 10.93 10.93 10.93	+ ABS	24.3541-1609.5 240039 24.3541-1610.5 240040 24.0101-4301.2 260047 11.0101-5403.2 260010	 	D=54, - Halter D=54, - Halter Bremsattel-Zubehör Fallenbalsatz TRW TRW TRW TRW
	1.8 Syncro G60 2.8 VR6			08.88 06.91	10.93 10.93		24.3541-1731.5 240061 24.3541-1732.5 240062	 	D=54, - Halter D=54, - Halter TRW TRW
	1.6 Limousine			04.88	09.89	- ABS	13.0460-7032.2 607032 13.0460-2958.2 602958	 	20887 19,7 +/Zub 20168 19,3 /S VW TRW
	1.6 Limousine 1.6 Limousine 1.6 TD 1.6 Variant 1.8 1.8 1.8 Syncro G60 1.9 D 1.9 TD 2.8 VR6	55 66		10.89 04.88 08.88 04.88 04.88 04.88 08.88 05.89 03.91 06.91	10.93 10.93 10.93 10.93 10.93 10.93 10.93 10.93 10.93 10.93	- ABS - ABS + ABS	13.0460-2958.2 602958	 	20168 19,3 /S TRW
	1.8 1.8 1.8 16V 2.0 2.0 16V 2.0 Syncro	79 82		04.88 04.88 04.88 03.90 08.88 10.90	07.90 07.90 07.92 10.93 10.93 10.93		13.0460-2957.2 602957	 	20168 16,0 /S TRW
	1.6 1.6 TD 1.8 1.8 1.9 D 1.9 TD	55 66		04.88 08.88 04.88 04.88 05.89 03.91	10.93 10.93 10.93 10.93 10.93 10.93		24.0113-0178.1 413178 24.0313-0178.1 513178	 	256 12,9 11,0 +S +B 256 12,9 11,0 +S +B PD
	1.8 1.8 1.8 16V 2.0 2.0 16V 2.0 Syncro	79 82		04.88 04.88 04.88 03.90 08.88 10.90	07.90 07.90 07.92 10.93 10.93 10.93		24.0120-0128.1 420128 24.0320-0128.1 520128	 	256 20,0 18,0 V L +S +B 256 20,0 18,0 V L +S +B PD
	1.8 Syncro G60 2.8 VR6	31-N-255990		08.88 10.93	10.93 10.93		24.0122-0101.1 422101 24.0122-0100.1 422100 24.0322-0100.1 522100	 	280 22,0 20,0 V L +B 280 22,0 20,0 V L +B 280 22,0 20,0 V L +B PD
	1.6 1.6 TD 1.8 1.8 16V 1.8 Syncro G60 1.9 D 1.9 TD 2.0 2.0 16V 2.0 Syncro 2.8 VR6			04.88 08.88 04.88 04.88 08.88 05.89 03.91 03.90 08.88 10.90 06.91	10.93 10.93 10.93 07.92 10.93 10.93 10.93 10.93 10.93 10.93 10.93		24.5237-0333.3 331425 2	 	L=333

VOLKSWAGEN PASSAT (88-93)												
	1.6 1.6 TD 1.8 1.8 16V 1.8 Syncro G60 1.9 D 1.9 TD 2.0 2.0 16V 2.0 Syncro 2.8 VR6			04.88 08.88 04.88 04.88 09.89 05.89 03.91 03.90 04.88 10.90 06.91	10.93 10.93 10.93 07.92 10.93 10.93 10.93 10.93 10.93 10.93 10.93		24.0711-1313.3	360016	2		Radsensor L=1130	
	1.8 1.8 1.8 16V 1.8 Syncro G60 2.0 2.0 2.0 16V 2.0 16V 2.0 Syncro 2.8 VR6 2.8 VR6	79 82		04.88 04.88 04.88 08.88 03.90 03.90 08.88 08.88 10.90 06.91 06.91	07.90 07.90 07.92 08.88 03.90 03.90 08.88 08.88 10.90 06.91 06.91		24.3384-1603.5 24.3384-1604.5 24.0101-3601.2	240015 240016 260044	 	D=38, - Halter D=38, - Halter Bremsattel-Zubehör	TRW TRW TRW	
	1.8 Syncro G60 2.0 2.0 2.0 16V 2.0 16V 2.0 Syncro 2.8 VR6 2.8 VR6		31-P-080001 31-PE080001 31-PB080001 31-PE080001 31-PB080001 31-P-080001 31-PE080001 31-PB080001	10.93 10.93 10.93 10.93 10.93 10.93 10.93 10.93			24.3384-1707.5 24.3384-1708.5 24.0101-3601.2 11.0101-5403.2	240171 240172 260044 260010	 	D=38, - Halter D=38, - Halter Bremsattel-Zubehör Falltenbalsatz	TRW TRW TRW TRW	
	1.8 1.8 1.8 16V 1.8 Syncro G60 2.0 2.0 2.0 16V 2.0 16V 2.0 Syncro 2.8 VR6 2.8 VR6	79 82		04.88 04.88 04.88 08.88 03.90 03.90 08.88 08.88 10.90 06.91 06.91	07.90 07.90 07.92 08.88 03.90 03.90 08.88 08.88 10.90 06.91 06.91		13.0460-2937.2 13.0460-0419.2	602937 610419		20961 15,2 /Zub/S Belagsatz-Zubehör	TRW TRW	
	1.8 Syncro G60 2.0 2.0 2.0 16V 2.0 16V 2.0 Syncro 2.8 VR6 2.8 VR6		31-P-080001 31-PE080001 31-PB080001 31-PE080001 31-PB080001 31-P-080001 31-PE080001 31-PB080001	10.93 10.93 10.93 10.93 10.93 10.93 10.93 10.93			13.0460-2984.2 13.0460-0072.2	602984 610072		20961 17,2 /Zub/S Belagsatz-Zubehör	TRW TRW	
	1.8 1.8 1.8 16V 2.0 2.0 16V 1.8 Syncro G60 2.0 Syncro 2.8 VR6	79 82		04.88 04.88 04.88 03.90 08.88 08.88 10.93 10.93 06.91	07.90 07.90 07.92 10.93 10.93 10.93 10.93 10.93		24.0110-0111.1 24.0110-0275.2	410111 410275	ohne Sensorring ¹⁾ mit Sensorring ²⁾	226 10,0 8,0 +B 226 10,0 8,0 +B		
	1.8 Syncro G60 2.0 Syncro 2.8 VR6			08.88 10.90 06.91	10.93 10.93 10.93		24.0110-0151.1	410151			239 10,0 8,0 +S +B	
	1.8 1.8 1.8 16V 2.0 2.0 16V 1.8 Syncro G60 2.0 Syncro 2.8 VR6	79 82		04.88 04.88 04.88 03.90 08.88 08.88 10.93 10.93 06.91	07.90 07.90 07.92 10.93 10.93 10.93 10.93 10.93		24.0110-0203.1 24.0110-0276.2	410203 410276	mit Sensorring ²⁾	226 10,0 8,0 +B 226 10,0 8,0 +B		
	1.6 1.6 TD 1.8 1.8 1.9 D 1.9 TD	55 66		04.88 08.88 04.88 04.88 05.89 03.91	10.93 10.93 10.93 10.93 10.93 10.93		24.5204-0180.3	331461	2		L=180	
	1.8 1.8 2.0 2.0 16V 2.8 VR6 1.8 Syncro G60 2.0 Syncro	79 82		04.88 04.88 03.90 08.88 06.91 08.88 10.90	07.90 07.90 10.93 10.93 10.93 10.93 10.93		24.5204-0180.3 24.5170-0161.3	331461 331308	2 2	am Bremsattel ³⁾	L=180 L=161	
	1.8 Syncro G60 2.0 Syncro			08.88 10.90	10.93 10.93		24.5201-0164.3 24.5170-0161.3	331414 331308	2 2	am Bremsattel ³⁾	L=164 L=161	
	1.6 1.6 TD 1.8 1.8 16V 1.9 D 1.9 TD 2.0 2.0 16V 2.8 VR6			04.88 08.88 04.88 04.88 05.89 03.91 03.90 04.88 06.91	10.93 10.93 10.93 07.92 10.93 10.93 10.93 10.93 10.93		24.0721-1925.1	360039	2		Radsensor L=1220	
	1.6 Limousine 1.6 Limousine 1.6 TD 1.6 Variant 1.8		31-L-085001	04.88 08.88 04.88 04.88	10.93 10.93 10.93 10.93		24.3219-0909.3 24.3220-0909.3	020188 020210			Rz 19,05 Rz 20,64	













¹⁾ without sensor ring / senza sensori / sans secours ABS / sin anillo sensor ABS

²⁾ with sensor ring / con sensori / avec secours ABS / con anillo sensor ABS

³⁾ on the brake caliper / sulla pinza freno / sur l'étrier de frein / a la pinza de freno

VOLKSWAGEN PASSAT (88-93)										
	1.8 1.9 D 1.9 TD	66		04.88 05.89 03.91	10.93 10.93 10.93		24.3220-0909.3	020210		Rz 20,64
	1.6 Limousine		31-L-085000	04.88			03.0137-0268.2 03.0137-9168.2	650268 669168		200 x 40 HEB Bremsbacken-Zubehör VW
	1.6 Limousine 1.6 TD 1.6 Variant 1.8 1.8 1.9 D	31-L-085001 55 66	31-M-280000 31-M-280000 31-M-280000 31-M-280000 31-M-280000	08.88 04.88 04.88 04.88 05.89			03.0137-0264.2 03.0137-9164.2	650264 669164		230 x 40 HEB Bremsbacken-Zubehör VW
	1.6 Limousine 1.6 TD 1.6 Variant 1.8 1.8 1.9 D 1.9 TD	31-M-280001 31-M-280001 31-M-280001 55 66 31-M-280001			10.93 10.93 10.93 10.93 10.93 10.93 03.91		03.0137-0264.2 03.0137-9149.2	650264 669149		230 x 40 HEB Bremsbacken-Zubehör VW
	1.6 Limousine		31-L-085000	04.88			24.0220-0018.1 24.0220-0718.2	480019 480209	ohne Sensorring ¹⁾ ohne Sensorring ¹⁾	200/201 x 50 - Lager 200/201 x 50 + Lager
	1.6 Limousine 1.6 TD 1.8 1.8 1.9 D 1.9 TD	31-L-085001 55 66		08.88 04.88 04.88 05.89 03.91	10.93 10.93 10.93 10.93 10.93		24.0223-0012.1	480042	ohne Sensorring ¹⁾	230/231,5 x 53,4
	1.6 Limousine		31-L-085000	04.88			03.0420-4219.3 03.0520-4219.3	684219 694219		19,05/200x40 Kit VW 19,05/200x40 TopKit VW
	1.6 Limousine 1.6 TD 1.6 Variant 1.8 1.8 1.9 D	31-L-085001 55 66	31-M-280000 31-M-280000 31-M-280000 31-M-280000 31-M-280000	08.88 04.88 04.88 04.88 05.89			03.0520-6120.3	696120		20,64/230x40 TopKit VW
	1.6 Limousine 1.6 TD 1.6 Variant 1.8 1.8 1.9 D 1.9 TD	31-M-280001 31-M-280001 31-M-280001 55 66 31-M-280001			10.93 10.93 10.93 10.93 10.93 10.93 03.91		03.0520-6120.3	696120		20,64/230x40 TopKit VW
	1.6 1.6 TD 1.8 1.8 1.9 D 1.9 TD	55 66		04.88 08.88 04.88 04.88 05.89 03.91	10.93 10.93 10.93 10.93 10.93 10.93		24.3727-0125.2	580125	2 ↓	L=1628
	1.8 1.8 1.8 16V 2.0 2.0 16V 2.8 VR6	79 82		04.88 04.88 04.88 03.90 08.88 06.91	07.90 07.90 07.92 10.93 10.93 10.93		24.3727-0126.2	580126	2 ↓	L=1749
	1.8 Syncro G60 2.0 Syncro			08.88 10.90	10.93 10.93		24.3727-0167.2	580167	2 ↓	L=1718
	1.6 1.6 TD 1.8 1.8 16V 1.8 Syncro G60 1.9 D 1.9 TD 2.0 2.0 16V 2.0 Syncro 2.8 VR6			04.88 08.88 04.88 04.88 08.88 05.89 03.91 03.90 08.88 10.90 06.91	10.93 10.93 10.93 07.92 10.93 10.93 10.93 10.93 10.93 10.93 10.93		03.6584-0015.3	320109		BRL 8/4 (4) ATE
	1.6 TD 1.8 1.8 1.8 16V 1.8 Syncro G60 1.9 D 1.9 TD 2.0 2.0 16V 2.0 Syncro 2.8 VR6	79 82		08.88 04.88 04.88 04.88 08.88 05.89 03.91 03.90 08.88 10.90 06.91	10.93 07.90 07.90 07.92 10.93 10.93 10.93 10.93 10.93 10.93 10.93		03.2419-9310.3	030027		Gz 19,05
	1.6 TD 1.8 1.8 1.8 16V 1.8 Syncro G60 1.9 D 1.9 TD 2.0	79 82		08.88 04.88 04.88 04.88 08.88 05.89 03.91 03.90	10.93 07.90 07.90 07.92 10.93 10.93 10.93 10.93		24.2523-0908.3	040049		Nz 23,81

¹⁾ without sensor ring / senza sensori / sans secours ABS / sin anillo sensor ABS

VOLKSWAGEN PASSAT (88-93)									
	2.0 16V 2.0 Syncro 2.8 VR6		08.88 10.90 06.91	10.93 10.93 10.93	24.2523-0908.3	040049		Nz 23,81	
	1.6 1.6 TD 1.8 1.8 1.9 D 1.9 TD	◀ ◀ ◀ 55 ◀ 66 ◀ ◀	04.88 08.88 04.88 04.88 05.89 03.91	10.93 10.93 10.93 10.93 10.93 10.93	24.3728-0124.2	590124		L=1295, + AUT	
VOLKSWAGEN PASSAT (94-96)									
	1.6 1.8 1.9 TD 1.9 TDI 2.0 2.0 16V 2.8 VR6	◀ ◀ ◀ 55 ◀ ◀ ◀ ◀	10.94 10.93 10.93 10.93 10.93 01.94 10.93	12.96 - ABS 12.96 - ABS 12.96 - ABS 12.96 - ABS 12.96 - ABS 12.96 - ABS 12.96 - ABS	03.7750-4302.4	300076		9"	ATE
	1.6 1.8 1.9 TD 1.9 TDI 2.0 2.0 16V 2.8 VR6	▶ ▶ ▶ 55 ▶ ▶ ▶ ▶	10.94 10.93 10.93 10.93 10.93 01.94 10.93	12.95 - ABS 12.95 - ABS 12.95 - ABS 12.95 - ABS 12.95 - ABS 12.95 - ABS 12.95 - ABS	03.7750-4902.4	300079		9"	ATE
	1.6 1.8 1.9 TD 1.9 TDI 2.0 2.0 16V 2.8 VR6	55	10.94 10.93 10.93 10.93 10.93 01.94 10.93	12.96 - ABS 12.96 - ABS 12.96 - ABS 12.96 - ABS 12.96 - ABS 12.96 - ABS 12.96 - ABS	03.2122-1042.3 03.3517-0101.2	010137 390322		THz 22,20 Verschlußschraube	ATE
	1.6 1.8 1.9 TD 1.9 TDI 2.0 2.0 16V 2.0 Syncro 2.8 VR6 2.9 VR6 Syncro	◀ ◀ ◀ 55 ◀ ◀ ◀ ◀ ◀ ◀	10.94 10.93 10.93 10.93 10.93 01.94 01.94 10.93 10.94	+ ABS + ABS + ABS + ABS + ABS + ABS + ABS + ABS + ABS	10.6123-0674.3	010639		THz 23,81	ATE
	1.6 1.8 1.9 TD 1.9 TDI 2.0 2.0 16V 2.0 Syncro 2.8 VR6 2.9 VR6 Syncro	◀ 3A-T-000001 ◀ 3A-T-000001 ◀ 55 3A-T-000001 ◀ 3A-T-000001 ◀ 3A-T-000001 ◀ 3A-T-000001 ◀ 3A-T-000001 ◀ 3A-T-000001 ◀ 3A-T-000001	12.96 12.96 12.96 12.96 12.96 12.96 12.96 12.96 12.96	+ ABS + ABS + ABS + ABS + ABS + ABS + ABS + ABS + ABS	03.2123-1424.3	010637		THz 23,81	ATE
	1.6 1.8 1.9 TD 1.9 TDI 2.0 2.0 16V 2.8 VR6	▶ 3A-T-000001 ▶ 3A-T-000001 ▶ 55 3A-T-000001 ▶ 3A-T-000001 ▶ 3A-T-000001 ▶ 3A-T-000001 ▶ 3A-T-000001	12.96 12.96 12.96 12.96 12.96 12.96 12.96	+ ABS + ABS + ABS + ABS + ABS + ABS + ABS	03.2123-1484.3	010595		THz 23,81	ATE
	1.6 1.8 1.9 TD 1.9 TDI 2.0 2.0 Syncro	55 66	10.94 10.93 10.93 10.93 10.93 01.94	12.96 12.96 12.96 12.96 12.96 12.96	24.3541-1609.5 24.3541-1610.5 24.0101-4301.2 11.0101-5403.2	240039 240040 260047 260010	<input type="checkbox"/> <input type="checkbox"/>	D=54, - Halter D=54, - Halter Bremsattel-Zubehör Falltenbalgsatz	TRW TRW TRW TRW
	1.9 TDI 2.0 16V 2.8 VR6 2.9 VR6 Syncro	81	03.96 01.94 10.93 10.94	12.96 12.96 12.96 12.96	24.3541-1731.5 24.3541-1732.5 24.3541-8523.5 24.3541-8524.5 11.8170-0306.1 11.0441-5409.2 11.0101-5409.2 11.8171-0008.1 11.8116-0143.1	240061 240062 240551 240552 260102 250031 260035 990049 390513	<input type="checkbox"/> <input type="checkbox"/> <input type="checkbox"/> <input type="checkbox"/> <input type="checkbox"/> <input type="checkbox"/> <input type="checkbox"/> <input type="checkbox"/> <input type="checkbox"/> <input type="checkbox"/> 2 2	D=54, - Halter D=54, - Halter D=54, - Halter D=54, - Halter Halter Dichtungssatz Hülensatz Führungsbolzen Haltefeder	TRW TRW ATE ATE ATE ATE ATE ATE ATE ATE
	1.6 1.8 1.9 TD 1.9 TDI 1.9 TDI	55 66 81	10.94 10.93 10.93 10.93 03.96	12.96 12.96 12.96 12.96 12.96	13.0460-2958.2	602958		20168 19,3 /S	TRW
	1.6 1.9 TDI 2.0 2.0 Syncro	66 3A-T-130757 66 3A-T-000001	12.96 12.96 10.93 01.94	12.96 12.96 12.96 12.96	13.0460-2957.2	602957		20168 16,0 /S	TRW
	2.0 16V 2.8 VR6 2.9 VR6 Syncro		01.94 10.93 10.94	12.96 12.96 12.96	13.0460-7081.2 13.0470-7081.2	607081 LD7081		21911 20,3 + 21911 20,3 +	ATE ATE



VOLKSWAGEN PASSAT (94-96)

	1.6		3A-T-130756	10.94	12.96	24.0113-0178.1	413178		256 12,9 11,0 +S +B	
	1.8			10.93	12.96	24.0313-0178.1	513178		256 12,9 11,0 +S +B PD	
	1.9 TD	55		10.93	12.96					
	1.9 TDI	66	3A-S-300000	10.93	12.96					
	1.6		3A-T-130757		12.96	24.0120-0128.1	420128		256 20,0 18,0 V L +S +B	
	1.9 TDI	66	3A-T-000001		12.96	24.0320-0128.1	520128		256 20,0 18,0 V L +S +B PD	
	2.0			10.93	12.96					
	2.0 Syncro			01.94	12.96					
	1.9 TDI	81		03.96	12.96	24.0122-0100.1	422100		280 22,0 20,0 V L +B	
						24.0322-0100.1	522100		280 22,0 20,0 V L +B PD	
	2.0 16V			01.94	12.96	24.0125-0108.1	425108		288 25,0 23,0 V L +B	
	2.8 VR6			10.93	12.96					
	2.9 VR6 Syncro			10.94	12.96					
		1.6			10.94	12.96	24.5237-0333.3	331425	2	L=333
		1.8			10.93	12.96				
		1.9 TD	55		10.93	12.96				
		1.9 TDI			10.93	12.96				
		2.0			10.93	12.96				
2.0 Syncro				01.94	12.96					
	2.0 16V			01.94	12.96	24.5147-0385.3	331427	2	L=384	
	2.8 VR6			10.93	12.96					
	2.9 VR6 Syncro			10.94	12.96					
		1.6			10.94	12.96	24.0711-1361.3	360022	<input type="checkbox"/>	Radsensor
		1.8			10.93	12.96	24.0711-1362.3	360023	<input type="checkbox"/>	Radsensor
		1.9 TD	55		10.93	12.96				
1.9 TDI				10.93	12.96					
2.0				10.93	12.96					
2.0 16V				01.94	12.96					
	2.0 Syncro			01.94	12.96					
	2.8 VR6			10.93	12.96					
	2.9 VR6 Syncro			10.94	12.96					
		1.9 TDI	66	3A-T-000001		12.96	24.3384-1707.5	240171	<input type="checkbox"/>	D=38, - Halter
		1.9 TDI	81		03.96	12.96	24.3384-1708.5	240172	<input type="checkbox"/>	D=38, - Halter
		2.0			10.93	12.96	11.0101-5403.2	260010		Faltenbalgsatz
2.0 16V				01.94	12.96					
2.0 Syncro				01.94	12.96					
2.8 VR6				10.93	12.96					
	2.9 VR6 Syncro			10.94	12.96					
		1.9 TDI	66	3A-T-000001		12.96	13.0460-2984.2	602984		20961 17,2 /Zub/S
		1.9 TDI	81		03.96	12.96	13.0460-0072.2	610072		Belagsatz-Zubehör
		2.0			10.93	12.96				
		2.0 16V			01.94	12.96				
		2.0 Syncro			01.94	12.96				
2.8 VR6				10.93	12.96					
	2.9 VR6 Syncro			10.94	12.96					
		1.9 TDI	66	3A-T-000001		12.96	24.0110-0111.1	410111		ohne Sensorring ¹⁾
		2.0			10.93	12.96	24.0110-0275.2	410275		mit Sensorring ²⁾
		1.9 TDI	81		03.96	12.96	24.0110-0203.1	410203		
		2.0 16V			01.94	12.96	24.0110-0276.2	410276		mit Sensorring ²⁾
		2.8 VR6			10.93	12.96				
2.0 Syncro				01.94	12.96	24.0110-0151.1	410151		226 10,0 8,0 +B	
									226 10,0 8,0 +B	
		1.6			10.94	12.96	24.5201-0164.3	331414	2	L=164
		1.8			10.93	12.96				
		1.9 TD	55		10.93	12.96				
		1.9 TDI	66	3A-S-300000	10.93	12.96				
		1.9 TDI	66	3A-T-000001		12.96	24.5201-0164.3	331414	2	L=164
1.9 TDI		81		03.96	12.96	24.5170-0161.3	331308	2	L=161	
	2.0			10.93	12.96					
	2.0 16V			01.94	12.96					
	2.0 Syncro			01.94	12.96					
	2.8 VR6			10.93	12.96					
	2.9 VR6 Syncro			10.94	12.96					
		1.6		3A-S-300000	10.94	12.96	24.0721-1925.1	360039	2 <input type="checkbox"/>	Radsensor L=1220
1.8			3A-S-300000	10.93	12.96					
1.9 TD		55	3A-S-300000	10.93	12.96					
1.9 TDI			3A-S-300000	10.93	12.96					
2.0			3A-S-300000	10.93	12.96					
2.0 16V			3A-S-300000	01.94	12.96					
	2.8 VR6		3A-S-300000	10.93	12.96					
	1.6		3A-T-000001		12.96	24.0721-1193.3	360092	2 <input type="checkbox"/>	Radsensor L=870	
	1.8		3A-T-000001		12.96					
	1.9 TD	55	3A-T-000001		12.96					
	1.9 TDI		3A-T-000001		12.96					
	2.0		3A-T-000001		12.96					
	2.0 16V		3A-T-000001		12.96					
	2.8 VR6		3A-T-000001		12.96					
		1.6			10.94	12.96	24.3220-0909.3	020210		Rz 20,64
		1.8			10.93	12.96				
		1.9 TD	55		10.93	12.96				
		1.9 TDI	66	3A-S-300000	06.95	12.96				
1.6				10.94	12.96	03.0137-0264.2	650264		230 x 40 HEB	
1.8				10.93	12.96	03.0137-9149.2	669149		Bremsbacken-Zubehör	
	1.9 TD	55		10.93	12.96					
	1.9 TDI	66	3A-S-300000	10.93	12.96					

¹⁾ without sensor ring / senza sensori / sans secours ABS / sin anillo sensor ABS
²⁾ with sensor ring / con sensori / avec secours ABS / con anillo sensor ABS
³⁾ on the brake caliper / sulla pinza freno / sur l'étrier de frein / a la pinza de freno





VOLKSWAGEN PASSAT (94-96)

	1.6 1.8 1.9 TD 1.9 TDI	55 66		10.94 12.96 10.93 10.93	12.96 12.96 12.96 10.93	24.0223-0012.1	480042		ohne Sensorring ¹⁾	230/231,5 x 53,4
	1.6 1.8 1.9 TD 1.9 TDI	55 66	3A-S-300000	10.94 10.93 10.93 10.93	12.96 12.96 12.96 10.93	03.0520-6120.3	696120			20,64/230x40 TopKit VW
	1.6 1.8 1.9 TD 1.9 TDI	55 66	3A-S-300000	10.94 10.93 10.93 10.93	12.96 12.96 12.96 10.93	24.3727-0153.2	580153	2	↕	L=1624
	1.9 TDI 1.9 TDI 2.0 2.0 16V 2.8 VR6	66 81	3A-T-000001	10.94 03.96 10.93 01.94 10.93	12.96 12.96 12.96 12.96 12.96	24.3727-0152.2	580152	2	↕	L=1721
	2.0 Syncro 2.9 VR6 Syncro			01.94 10.94	12.96 12.96	24.3727-0167.2	580167	2	↕	L=1718
	1.6 1.8 1.9 TD 1.9 TDI 2.0 2.0 16V 2.0 Syncro 2.8 VR6 2.9 VR6 Syncro	55		10.94 10.93 10.93 10.93 10.93 01.94 01.94 10.93 10.94	12.96 12.96 12.96 12.96 12.96 12.96 12.96 12.96 12.96	03.6584-0015.3	320109			BRL 8/4 (4) ATE
	1.6 1.8 1.9 TD 1.9 TDI 2.0 2.0 16V 2.0 Syncro 2.8 VR6 2.9 VR6 Syncro	55		10.94 10.93 10.93 10.93 10.93 01.94 01.94 10.93 10.94	12.96 12.96 12.96 12.96 12.96 12.96 12.96 12.96 12.96	03.2419-1206.3	030074			Gz 19,05
	1.6 1.8 1.9 TD 1.9 TDI 2.0 2.0 16V 2.0 Syncro 2.8 VR6 2.9 VR6 Syncro	55		10.94 10.93 10.93 10.93 10.93 01.94 01.94 10.93 10.94	12.96 12.96 12.96 12.96 12.96 12.96 12.96 12.96 12.96	24.2523-0908.3	040049			Nz 23,81

VOLKSWAGEN POLO I (75-81)

	0.9 1.1 1.3			04.75 04.75 12.76	09.81 09.81 + Bremsgerät ²⁾ 09.81 + Bremsgerät ²⁾	03.2117-3311.3 03.3526-2002.3	010040 340010	1		THz 17,46 Bremslichtschalter	ATE
	1.1 1.3			04.75 12.76	09.81 09.81	03.2120-1531.3 03.3526-2002.3	010092 340010	1		THz 20,64 Bremslichtschalter	ATE
	1.1 1.3			04.75 12.76	09.81 09.81	03.3508-7504.3	310045		ohne Warneinrichtung	Behälter	ATE
	0.9 1.1 1.3			04.75 04.75 12.76	09.81 09.81 09.81	11.0441-4402.2	250014			Dichtungssatz	ATE
	0.9 1.1 1.3			04.75 04.75 12.76	09.81 09.81 09.81	13.0460-4028.2	604028			20228 15,3	ATE
	0.9 1.1 1.3			04.75 04.75 12.76	09.81 09.81 09.81	24.0108-0100.1	408100			239 8,0 7,0	
	0.9 1.1 1.3			04.75 04.75 12.76	09.81 09.81 09.81	24.5170-0296.3	331451	2		L=296	
	0.9 1.1 1.3			04.75 04.75 12.76	09.81 09.81 09.81	24.5204-0180.3	331461	2		L=180	
	0.9 1.1 1.3			04.75 04.75 12.76	09.81 09.81 09.81	03.3214-0812.3 24.3214-0902.3	020011 020147		+ GG ⁴⁾ + ALU ⁵⁾	Rz 14,29 Rz 14,29	
	0.9 1.1 1.3			04.75 04.75 12.76	09.81 09.81 09.81	03.3217-2112.3 24.3217-0908.3	020027 020167		+ GG ⁴⁾ + ALU ⁵⁾	Rz 17,46 Rz 17,46	
	0.9 1.1 1.3			04.75 04.75 12.76	07.78 07.78 07.78	03.0137-9006.2	669006		- autom. Nachstellung ⁷⁾	Bremsbacken-Zubehör	
	0.9 1.1 1.3			08.78 08.78 08.78	09.81 09.81 09.81	03.0137-0126.2 03.0137-9008.2	650126 669008			180 x 31 HEB Bremsbacken-Zubehör	

¹⁾ without sensor ring / senza sensori / sans secours ABS / sin anillo sensor ABS
²⁾ + booster unit / + servofreno / + servo-frein / + servofreno
³⁾ - brake pressure regulator / - correttore di frenata / - correcteur de freinage / - corrector de frenado
⁴⁾ + cast iron / + ghisa / + fonte grise / + fundición de gris
⁵⁾ + aluminium / + alluminio / + aluminium / + aluminio
⁶⁾ + brake pressure regulator / + correttore di frenata / + correcteur de freinage / + corrector de frenado
⁷⁾ - automatic adjustment / - correzione automatica / - ajustage automatique / - reajuste automatico



VOLKSWAGEN POLO I (75-81)

	0.9 1.1 1.3			04.75 04.75 12.76	09.81 09.81 09.81		24.0218-0007.1 24.0218-0707.2	480003 480211			180/181 x 38,5 - Lager 180/181 x 38,5 + Lager	
	0.9 1.1 1.3			08.78 08.78 08.78	09.81 09.81 09.81	+ Bremskraftregler ¹⁾ + Bremskraftregler ¹⁾ + Bremskraftregler ¹⁾	03.0420-0617.3 03.0520-3917.3	680617 693917	+ Rz GG ²⁾ + Rz ALU ³⁾		17,46/180x31 Kit 17,46/180x31 TopKit	VW VW
	0.9 1.1 1.3			04.75 04.75 12.76	09.81 09.81 09.81		24.3727-0146.2 24.3727-0103.2	580146 580103		1 1	L=794 L=1960	
	0.9 1.1 1.3			04.75 04.75 12.76	09.81 09.81 09.81		24.3728-0101.2	590101			L=607	

VOLKSWAGEN POLO II (81-94)

	1.0 1.0			10.81 10.90	09.90 09.94	- Bremsgerät ⁴⁾ - Bremsgerät ⁴⁾	03.2117-3311.3 03.3526-2002.3 03.3517-0101.2	010040 340010 390322		1	THz 17,46 Bremslichtschalter Verschlusschraube	ATE
	1.0 1.1 1.3		..-F-127903	10.81 10.81 10.81	07.83	+ Bremsgerät ⁵⁾	03.2120-1531.3 03.3526-2002.3	010092 340010		1	THz 20,64 Bremslichtschalter	ATE
	1.0 1.3 1.3 D 1.3 G40 1.4 D		..-F-127904 ..-F-127904		09.94 09.94 08.86 01.87 08.90	+ Bremsgerät ⁵⁾	03.2120-2031.3	010106			THz 20,64	ATE
	1.1 1.3			10.81 10.81	07.83 02.85		03.3508-7504.3	310045	ohne Warneinrichtung		Behälter	ATE
	1.0 1.1 1.3			10.81 10.81 10.81	02.85 07.83 02.85		11.0441-4402.2	250014			Dichtungssatz	ATE
	1.0 1.3 1.3 D 1.4 D			03.85 03.85 08.86 08.90	09.94 09.94 09.94 09.94		24.3481-1745.5 24.3481-1746.5 11.0441-4808.2 11.0101-4803.2 24.0102-4803.2	240277 240278 250022 260008 260086			D=48, - Halter D=48, - Halter Dichtungssatz Hülensatz Hülensatz+Schrauben	ATE ATE ATE ATE ATE
	1.3 G40			01.87	09.94		11.0441-4808.2 11.0101-4801.2 24.0102-4801.2	250022 260006 260085			Dichtungssatz Hülensatz Hülensatz+Schrauben	ATE ATE ATE
	1.0 1.1 1.3			10.81 10.81 10.81	02.85 07.83 02.85		13.0460-4028.2 13.0460-0115.2	604028 610115			20228 15,3 Belagsatz-Zubehör	ATE ATE
	1.0 1.3 1.3 D 1.4 D 1.3 G40			03.85 03.85 08.86 08.90 01.87	09.94 09.94 09.94 09.94 09.94		13.0460-7059.2 13.0460-0184.2 13.0460-7033.2	607059 610184 607033			20887 17,3 +/Zub Belagsatz-Zubehör 20887 15,3 +/Zub	VW VW VW
	1.0 1.1 1.3 1.3 D 1.4 D 1.3 G40			10.81 10.81 10.81 08.86 08.90 01.87	09.94 07.83 09.94 09.94 09.94 09.94		24.0110-0151.1 24.0310-0151.1	410151 510151			239 10,0 8,0 +S +B 239 10,0 8,0 +S +B PD	
	1.0 1.1 1.3 1.3 D 1.3 G40 1.4 D			10.81 10.81 10.81 08.86 01.87 08.90	09.94 07.83 09.94 09.94 09.94 09.94		24.0120-0123.1 24.0320-0123.1	420123 520123			239 20,0 18,0 V L +S +B 239 20,0 18,0 V L +S +B PD	
	1.0 1.1 1.3 1.3 D 1.3 G40 1.4 D			10.81 10.81 10.81 08.86 01.87 08.90	09.94 07.83 09.94 09.94 09.94 09.94		24.5170-0296.3	331451		2	L=296	
	1.0 1.1 1.3 1.3 D 1.3 G40 1.4 D			10.81 10.81 10.81 08.86 01.87 08.90	09.94 07.83 09.94 09.94 09.94 09.94		24.5204-0180.3	331461		2	L=180	
	1.0 1.1 1.3		..-F-127903	10.81 10.81 10.81	07.83	- Bremskraftregler ⁶⁾ - Bremskraftregler ⁶⁾ - Bremskraftregler ⁶⁾	03.3214-0812.3 24.3214-0902.3	020011 020147	+ GG ⁷⁾ + ALU ⁸⁾		Rz 14,29 Rz 14,29	
	1.0 1.3 1.3 D 1.3 G40 1.4 D		..-F-127904 ..-F-127904	09.94 09.94 08.86 01.87 08.90	09.94 09.94 09.94 09.94 09.94	- Bremskraftregler ⁶⁾ - Bremskraftregler ⁶⁾ - Bremskraftregler ⁶⁾ - Bremskraftregler ⁶⁾ - Bremskraftregler ⁶⁾	03.3215-2311.3 24.3215-0903.3	020018 020154	+ GG ⁷⁾ + ALU ⁸⁾		Rz 15,87 Rz 15,87	
	1.0 1.1 1.3		..-F-127903	10.81 10.81 10.81	07.83	+ Bremskraftregler ¹⁾ + Bremskraftregler ¹⁾ + Bremskraftregler ¹⁾	03.3217-2112.3 24.3217-0908.3	020027 020167	+ GG ⁷⁾ + ALU ⁸⁾		Rz 17,46 Rz 17,46	
	1.0 1.3 1.3 D 1.3 G40 1.4 D		..-F-127904 ..-F-127904	09.94 09.94 08.86 01.87 08.90	09.94 09.94 09.94 09.94 09.94	+ Bremskraftregler ¹⁾ + Bremskraftregler ¹⁾ + Bremskraftregler ¹⁾ + Bremskraftregler ¹⁾ + Bremskraftregler ¹⁾	24.3219-0909.3	020188			Rz 19,05	

1) + brake pressure regulator / + correttore di frenata / correcteur de freinage / corrector de frenado
2) + WC cast iron / + CR ghisa / + CR fontegrise / + CR fundición de gris
3) + WC aluminium / + CR alluminio / + CR aluminium / + CR aluminio
4) - booster unit / - servofreno / - servo-frein / - servofreno
5) + booster unit / + servofreno / + servo-frein / + servofreno
6) - brake pressure regulator / - correttore di frenata / - correcteur de freinage / - corrector de frenado
7) + cast iron / + ghisa / + fonte grise / + fundición de gris
8) + aluminium / + aluminio / + aluminium / + aluminio





VOLKSWAGEN POLO II (81-94)

	1.0			10.81	09.94	03.0137-0126.2	650126			180 x 31 HEB	
	1.1			10.81	07.83	03.0137-9008.2	669008			Bremsbacken-Zubehör	
	1.3			10.81	09.94						
	1.3 D			08.86	09.90						
	1.3 G40			01.87	09.94						
1.4 D			08.90	09.94							
	1.0			10.81	09.94	24.0218-0007.1	480003			180/181 x 38,5 - Lager	
	1.1			10.81	07.83	24.0218-0707.2	480211			180/181 x 38,5 + Lager	
	1.3			10.81	09.94						
	1.3 D			08.86	09.90						
	1.3 G40			01.87	09.94						
1.4 D			08.90	09.94							
	1.0		..-F-127903	10.81		03.0520-0114.3	690114			14,29/180x31 TopKit	VW
	1.1			10.81	07.83						
	1.3		..-F-127903	10.81							
	1.0		..-F-127903	10.81		03.0420-0617.3	680617		+ Rz GG ³⁾	17,46/180x31 Kit	VW
	1.1			10.81	07.83	03.0520-3917.3	693917		+ Rz ALU ⁴⁾	17,46/180x31 TopKit	VW
1.3		..-F-127903	10.81								
	1.0		..-F-127904		09.94	03.0520-0215.3	690215			15,87/180x31 TopKit	VW
	1.3		..-F-127904		09.94						
	1.3 D			08.86	09.90						
	1.3 G40			01.87	09.94						
	1.4 D			08.90	09.94						
	1.0		..-F-127904		09.94	03.0520-1719.3	691719			19,05/180x31 TopKit	VW
	1.3		..-F-127904		09.94						
	1.3 D			08.86	09.90						
	1.3 G40			01.87	09.94						
	1.4 D			08.90	09.94						
	1.0		..-E-200000	10.81		24.3727-0146.2	580146	1	↑	L=794	
	1.1			10.81	07.83	24.3727-0103.2	580103	1	↓	L=1960	
	1.3		..-E-200000	10.81							
	1.0		..-F-000001		09.94	24.3727-0137.2	580137	1	↑	L=1594	
	1.3		..-F-000001		09.94	24.3727-0129.2	580129	2	↓	L=633	
1.3 D			08.86	09.90							
1.3 G40			01.87	09.94							
1.4 D			08.90	09.94							
	1.0		..-F-000001		09.94	03.6584-0015.3	320109			BRL 8/4 (4)	ATE
	1.3		..-F-000001		09.94						
	1.3 D			08.86	09.90						
	1.3 G40			01.87	09.94						
	1.4 D			08.90	09.94						
	1.0			10.81	02.85	24.3728-0101.2	590101			L=607	
	1.1			10.81	07.83						
	1.3			10.81	02.85						
	1.0			03.85	09.94	24.3728-0118.2	590118			L=607	
	1.3			03.85	09.94						
1.3 G40			01.87	09.94							

VOLKSWAGEN SCIROCCO I (74-83)

	1.1			01.74	07.77	03.3526-2002.3	340010			Bremslichtschalter		
						24.3526-1900.0	340038	1		Bremslichtschalter		
	1.1			08.77	07.79	03.2120-1531.3	010092			THz 20,64	ATE	
	1.5			01.74	07.79	03.3526-2002.3	340010	1		Bremslichtschalter		
	1.6			01.75	07.79	24.3526-1900.0	340038	2		Bremslichtschalter		
	1.1			08.79	07.80	03.2120-1531.3	010092			THz 20,64	ATE	
	1.3			08.79	07.83	03.3526-2002.3	340010	1		Bremslichtschalter		
	1.5			08.79	07.83							
	1.6			08.79	07.83							
	1.1			08.79	07.80	03.2120-1491.3	010089			THz 20,64 + WE	ATE	
	1.3			08.79	07.83	03.3526-2002.3	340010	2		Bremslichtschalter		
	1.5			08.79	07.83							
	1.6			08.79	07.83							
	1.5		◀	01.74	07.77		24.3526-1900.0	340038	1		Bremslichtschalter	
	1.6		◀	01.75	07.77							
1.5			01.74	07.78		24.3526-1900.0	340038	2		Bremslichtschalter		
1.6			01.75	07.78								
1.6 i			08.79	07.82								
1.8			08.82	07.83	03.2120-1491.3	010089			THz 20,64 + WE	ATE		
					03.3526-2002.3	340010	2		Bremslichtschalter			
	1.1			01.74	07.79	03.3508-7504.3	310045			Behälter	ATE	
	1.5			01.74	07.79							
	1.6			01.75	07.77							
	1.6			01.75	07.79							
	1.6 i			01.76	07.79							
	1.1			01.74	07.80	11.0441-4402.2	250014			Dichtungssatz	ATE	
	1.3			08.79	07.80							
	1.5			01.74	07.80							
	1.6			01.75	07.80							
	1.7			08.80	07.83							
	1.6 i			01.76	07.80							
	1.1			08.78	07.80							
1.3			08.79	07.83								
1.5			08.78	07.83								
1.6			08.78	07.83								
			08.78	07.83								

1) - brake pressure regulator / - correttore di frenata / - correcteur de freinage / - corrector de frenado
 2) + brake pressure regulator / + correttore di frenata / + correcteur de freinage / + corrector de frenado
 3) + WC cast iron / + CR ghisa / + CR fontegrise / + CR fundición de gris
 4) + WC aluminium / + CR alluminio / + CR aluminium / + CR aluminio
 5) - booster unit/ + (S) / - servofreno/ + (S) / - servo-frein/ + (S) / - servofreno/ + (S)
 6) + (S) / + booster unit / + (S) / + servofreno / + (S) / + servo-frein / + (S) / + servofreno
 7) + floating calipers / + pinze flottante / + étriers flottant / + pinzas flotante
 8) + (D) / + floating calipers / + (D) / + pinze flottanti / + (D) / + étriers flottant / + (D) / + pinza flotante





VOLKSWAGEN SCIROCCO I (74-83)

	1.6 i 1.7 1.8		04.79 07.82 + Faustsättel ¹⁾ 08.80 07.83 + ☉ / + Faustsättel ²⁾ 08.82 07.83 + Faustsättel ¹⁾	11.0441-4808.2 250022 11.0101-4801.2 260006 24.0102-4801.2 260085		Dichtungssatz Hülensatz Hülensatz+Schrauben	ATE ATE ATE
	1.1 1.3 1.5 1.6 1.7		01.74 07.80 + Schwimmsättel ³⁾ 08.79 07.80 + Schwimmsättel ³⁾ 01.74 07.80 + Schwimmsättel ³⁾ 01.75 07.80 + Schwimmsättel ³⁾ 08.80 07.83 + ☉ / + Schwimmsättel ⁴⁾	13.0460-4029.2 604029		20228 18,5	ATE
	1.6 i		01.76 07.80 + Schwimmsättel ³⁾	13.0460-4028.2 604028		20228 15,3	ATE
	1.1 1.3 1.5 1.6 1.7		08.78 07.80 + Faustsättel ¹⁾ 08.79 07.83 + Faustsättel ¹⁾ 08.78 07.83 + Faustsättel ¹⁾ 08.78 07.83 + Faustsättel ¹⁾ 08.80 07.83 + ☉ / + Faustsättel ²⁾	13.0460-7032.2 607032		20887 19,7 +/Zub	VW
	1.6 i 1.8		04.79 07.82 + Faustsättel ¹⁾ 08.82 07.83	13.0460-7033.2 607033		20887 15,3 +/Zub	VW
	1.1 1.3 1.5 1.6 1.7		01.74 07.80 08.79 07.83 01.74 07.83 01.75 07.83 08.80 07.83 + ☉	24.0112-0106.1 412106 24.0312-0106.1 512106		239 12,0 10,0 +S +B 239 12,0 10,0 +S +B PD	
	1.6 i 1.8		01.76 07.82 08.82 07.83	24.0120-0123.1 420123 24.0320-0123.1 520123		239 20,0 18,0 V L +S +B 239 20,0 18,0 V L +S +B PD	
	1.1 1.5 1.6		01.74 10.78 01.74 10.78 01.75 10.78	83.6104-0325.3 330246	2	L=325	ATE
	1.1 1.3 1.5 1.6 1.7 1.8		11.78 07.80 08.79 07.83 11.78 07.83 11.78 07.83 08.80 07.83 + ☉ 08.82 07.83	24.5170-0315.3 331309 24.5108-0266.3 330038	2 2	L=315 L=266	TRW
	1.1 1.3 1.5 1.6 1.7 1.8		01.74 07.80 08.79 07.83 01.74 07.83 01.75 07.83 08.80 07.83 + ☉ 08.82 07.83	24.5201-0164.3 331414	2	L=164	
	1.1 1.3 1.5 1.6		01.74 07.80 08.79 07.81 01.74 07.81 + Schaltgetriebe ⁷⁾ 01.75 07.81 + Schaltgetriebe ⁷⁾	03.3214-0812.3 020011 24.3214-0902.3 020147	+ GG ⁵⁾ + ALU ⁶⁾	Rz 14,29 Rz 14,29	
	1.3 1.5 1.6 1.6 i 1.7 1.8		08.81 07.83 01.74 07.81 + Automatikgetriebe ⁸⁾ 01.75 07.81 + Automatikgetriebe ⁸⁾ 01.76 07.82 08.80 07.83 + ☉ 08.82 07.83	03.3217-2112.3 020027 24.3217-0908.3 020167	+ GG ⁵⁾ + ALU ⁶⁾	Rz 17,46 Rz 17,46	
	1.1 1.5 1.6 1.6 i		01.74 07.78 01.74 07.78 01.75 07.78 - ☉ 01.76 07.78	03.0137-9006.2 669006	- autom. Nachstellung ⁹⁾	Bremsbacken-Zubehör	
	1.1 1.3 1.5 1.6 1.6 i 1.7 1.8		08.78 07.80 08.79 07.83 08.78 07.83 01.77 07.83 + ☉ 08.78 07.82 08.80 07.83 + ☉ 08.82 07.83	03.0137-0126.2 650126 03.0137-9008.2 669008		180 x 31 HEB Bremsbacken-Zubehör	
	1.1 1.3 1.5 1.6 1.7 1.8		01.74 07.80 08.79 07.83 01.74 07.83 01.74 07.83 08.80 07.83 + ☉ 08.82 07.83	24.0218-0007.1 480003 24.0218-0707.2 480211		180/181 x 38,5 - Lager 180/181 x 38,5 + Lager	
	1.1 1.3 1.5 1.6		08.78 07.80 08.79 07.81 08.78 07.81 + Schaltgetriebe ⁷⁾ 08.78 07.81 + Schaltgetriebe ⁷⁾	03.0520-0114.3 690114		14,29/180x31 TopKit	VW
	1.3 1.5 1.6 1.6 i 1.7 1.8		08.81 07.83 08.78 07.81 + Automatikgetriebe ⁸⁾ 08.78 07.81 + Automatikgetriebe ⁸⁾ 08.78 07.82 08.80 07.83 + ☉ 08.82 07.83	03.0420-0617.3 680617 03.0520-3917.3 693917	+ Rz GG ¹⁰⁾ + Rz ALU ¹¹⁾	17,46/180x31 Kit 17,46/180x31 TopKit	VW VW
	1.1 1.3 1.5 1.6 1.7 1.8		01.74 07.80 08.79 07.83 01.74 07.83 01.75 07.83 08.80 07.83 + ☉ 08.82 07.83	24.3727-0102.2 580102	2	L=1690	

1) + fist type calipers / + pinza freno flottante / + étriers à griffe / + pinza de puno
 2) + ☉ / + fist type calipers / + ☉ / + pinza flottante / + ☉ / + étriers à griffe / + ☉ / + pinza de puno
 3) + floating calipers / + pinze flottante / + étriers flottants / + pinzas flotante
 4) + ☉ / + floating calipers / + ☉ / + pinze flottanti / + ☉ / + étriers flottant / + ☉ / + pinza flotante
 5) + cast iron / + ghisa / + fonte grise / + fundición de gris
 6) + aluminium / + alluminio / + aluminium / + aluminio
 7) + manual transmission / + scatola cambio velocità / + transmission mécanique / + cambio de velocidad
 8) + autom. transmission / + scatola cambio automatico / + transmission automatique / + cambio automático

9) - automatic adjustment / - correzione automatica / - ajustage automatique / - reajuste automatico
 10) + WC cast iron / + CR ghisa / + CR fontgrise / + CR fundición de gris
 11) + WC aluminium / + CR alluminio / + CR aluminium / + CR aluminio





VOLKSWAGEN SCIROCCO I (74-83)

	1.1 1.3 1.5 1.6 1.7 1.8			08.76 08.79 08.76 08.76 08.80 08.82	07.80 07.83 07.83 07.83 07.83 + ① 07.83		03.6565-0101.3	320097			BRL 6/5 (4)	ATE
	1.1 1.3 1.5 1.6 1.7 1.8			09.75 08.79 09.75 09.75 01.76 08.80 08.82	07.80 07.83 07.83 07.83 07.82 07.83 + ① 07.83		24.3728-0107.2	590107			L=1055	
				09.75 09.75 01.76 08.80 08.82	07.83 07.83 07.82 07.83 + ① 07.83		24.3728-0109.2	590109			L=874	

VOLKSWAGEN SCIROCCO II (84-92)

	1.3 1.3 1.6 1.6 1.8 1.8 1.8 16V	53-E-022075 53-E-022075 53-E-022075 53-E-022075 53-E-022075 53-E-022075	53-E-022074 53-E-022074 53-E-022074 53-L-010000 53-L-010000	08.83 08.83 08.83 08.83 07.92 07.92	07.84 07.92 07.92 07.84 07.92		03.2120-1491.3 03.3526-2002.3 03.3517-0101.2	010089 340010 390322	2		Thz 20,64 + WE Bremslichtschalter Verschlußschraube	ATE
	1.3 1.6 1.8 1.8 16V	53-E-022075 53-E-022075 53-E-022075 53-L-010001	53-L-010000 53-L-010000	08.83 08.83 07.92 07.92	07.84 07.92 07.92 07.92		03.2120-2031.3 03.2120-3943.3	010106 010532			Thz 20,64 Thz 20,64	ATE ATE
	1.3 1.6 1.8 1.8 16V	53-E-022075 53-E-022075 53-E-022075	53-E-022074 53-E-022074 53-E-022074	08.83 08.83 08.83	07.84 07.92 07.92		11.0441-4808.2 11.0101-4801.2 24.0102-4801.2	250022 260006 260085			Dichtungssatz Hülssensatz Hülssensatz+Schrauben	ATE ATE ATE
	1.3 1.6 1.8 1.8 16V	53-E-022075 53-E-022075 53-E-022075		08.83 08.83 08.83	07.84 07.92 07.92		11.0441-4808.2 11.0101-4801.2 24.0102-4801.2	250022 260006 260085			Dichtungssatz Hülssensatz Hülssensatz+Schrauben	ATE ATE ATE
	1.3 1.6 1.8 1.8 16V			08.83 08.83 08.83	07.84 07.92 07.92		24.3541-1609.5 24.3541-1610.5 24.0101-4301.2 11.0101-5403.2	240039 240040 260047 260010	<input type="checkbox"/> <input type="checkbox"/>		D=54, - Halter D=54, - Halter Bremsattel-Zubehör Fallenbalgsatz	TRW TRW TRW TRW
	1.3 1.6 1.8 1.8 16V			08.83 08.83 08.83	07.84 07.92 07.92		13.0460-7032.2	607032			20887 19,7 +/Zub	VW
	1.3 1.6 1.8 1.8 16V			08.83 08.83 08.83	07.84 07.92 07.92		13.0460-7033.2	607033			20887 15,3 +/Zub	VW
	1.3 1.6 1.8 1.8 16V			08.83 08.83 08.83	07.84 07.92 07.92		13.0460-2957.2	602957			20168 16,0 /S	TRW
	1.3 1.6 1.8 1.8 16V			08.83 08.83 08.83	07.84 07.92 07.92		24.0112-0106.1 24.0312-0106.1	412106 512106			239 12,0 10,0 +S +B 239 12,0 10,0 +S +B PD	
	1.3 1.6 1.8 1.8 16V			08.83 08.83 08.83	07.84 07.92 07.92		24.0120-0123.1 24.0320-0123.1	420123 520123			239 20,0 18,0 V L +S +B 239 20,0 18,0 V L +S +B PD	
	1.3 1.6 1.8 1.8 16V			08.83 08.83 08.83	07.84 07.92 07.92		24.0120-0128.1 24.0320-0128.1	420128 520128			256 20,0 18,0 V L +S +B 256 20,0 18,0 V L +S +B PD	
	1.3 1.6 1.8 1.8 16V			08.83 08.83 08.83	07.84 07.92 07.92		24.5170-0315.3	331309	2		L=315	
	1.3 1.6 1.8 1.8 16V			08.83 08.83 08.83	07.84 07.92 07.92		24.3364-1605.5 24.3364-1606.5 24.0101-3601.2 11.0101-5403.2	240011 240012 260044 260010	<input type="checkbox"/> <input type="checkbox"/>		D=36, - Halter D=36, - Halter Bremsattel-Zubehör Fallenbalgsatz	TRW TRW TRW TRW
	1.3 1.6 1.8 1.8 16V			08.83 08.83 08.83	07.84 07.92 07.92		13.0460-2937.2 13.0460-0419.2	602937 610419			20961 15,2 /Zub/S Belagsatz-Zubehör	TRW TRW
	1.3 1.6 1.8 1.8 16V			08.83 08.83 08.83	07.84 07.92 07.92		24.0110-0111.1 24.0110-0275.2	410111 410275		ohne Sensorring ¹⁾ mit Sensorring ²⁾	226 10,0 8,0 +B 226 10,0 8,0 +B	
	1.3 1.6 1.8 1.8 16V			08.83 08.83 08.83	07.84 07.92 07.92		24.5204-0180.3	331461	2		L=180	
	1.3 1.6 1.8 1.8 16V			08.83 08.83 08.83	07.84 07.92 07.92		24.5170-0161.3	331308	2		L=161	
	1.3 1.6 1.8 1.3 1.6 1.8	53-E-022074 53-E-022074 53-E-022074	08.83 08.83 08.83	- Bremskraftregler ³⁾ - Bremskraftregler ³⁾ - Bremskraftregler ³⁾	07.84 07.92 07.92		03.3214-0812.3 24.3214-0902.3	020011 020147		+ GG ⁴⁾ + ALU ⁵⁾	Rz 14,29 Rz 14,29	
	1.3 1.6 1.8			+ Bremskraftregler ⁶⁾ + Bremskraftregler ⁶⁾ + Bremskraftregler ⁶⁾	07.84 07.92 07.92		03.3217-2112.3 24.3217-0908.3	020027 020167		+ GG ⁴⁾ + ALU ⁵⁾	Rz 17,46 Rz 17,46	
	1.3 1.6 1.8			08.83 08.83 08.83	07.84 07.92 07.92		03.0137-0126.2 03.0137-9008.2	650126 669008			180 x 31 HEB Bremsbacken-Zubehör	
	1.3 1.6 1.8			08.83 08.83 08.83	07.84 07.92 07.92		24.0218-0007.1 24.0218-0707.2	480003 480211			180/181 x 38,5 - Lager 180/181 x 38,5 + Lager	
	1.3 1.6 1.8 1.3 1.6	53-E-022074 53-E-022074 53-E-022074	08.83 08.83 08.83	- Bremskraftregler ³⁾ - Bremskraftregler ³⁾ - Bremskraftregler ³⁾	07.84 07.92 07.92		03.0520-0114.3	690114			14,29/180x31 TopKit	VW
	1.3 1.6			+ Bremskraftregler ⁶⁾ + Bremskraftregler ⁶⁾	07.84 07.92		03.0420-0617.3 03.0520-3917.3	680617 693917		+ Rz GG ⁷⁾ + Rz ALU ⁸⁾	17,46/180x31 Kit 17,46/180x31 TopKit	VW VW

1) without sensor ring / senza sensori / sans secours ABS / sin anillo sensor ABS
 2) with sensor ring / con sensori / avec secours ABS / con anillo sensor ABS
 3) - brake pressure regulator / - correttore di frenata / - correcteur de freinage / - corrector de frenado
 4) + cast iron / + ghisa / + fonte grise / + fundición de gris
 5) + aluminium / + alluminio / + aluminium / + aluminio
 6) + brake pressure regulator / + correttore di frenata / + correcteur de freinage / + corrector de frenado
 7) + WC cast iron / + CR ghisa / + CR fontegrise / + CR fundición de gris
 8) + WC aluminium / + CR alluminio / + CR aluminium / + CR aluminio



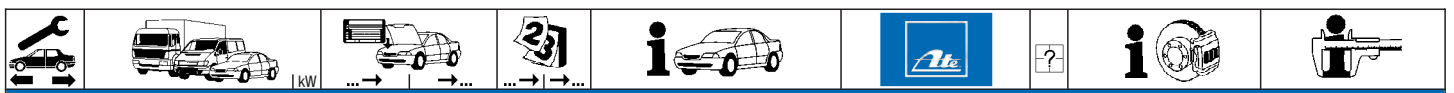

VOLKSWAGEN SCIROCCO II (84-92)

	1.8			08.83	07.92	+ Bremskraftregler ¹⁾	03.0420-0617.3 03.0520-3917.3	680617 693917		+ Rz GG ²⁾ + Rz ALU ³⁾	17,46/180x31 Kit 17,46/180x31 TopKit	VW VW
	1.3 1.6 1.8			08.83 08.83 08.83	07.84 07.92 07.92		24.3727-0102.2	580102	2		L=1690	
	1.3 1.6 1.8		53-E-060000	08.83 08.83 08.83	07.92 07.92 07.92		24.3728-0107.2 24.3728-0109.2	590107 590109			L=1055 L=874	

VOLKSWAGEN TARO (89-97)

	1.8 2.2 2.4 D			04.89 06.89 04.89	09.94 07.94 03.97		13.0460-5938.2	605938			21158 15,5	AKE
	1.8 2.2 2.4 D			04.89 06.89 04.89	09.94 07.94 03.97		24.0125-0118.1	425118			257 25,0 23,0 V	
	2.4 D 4x4 2.4i 4x4			07.94 06.89	03.97 03.97		24.0120-0168.1	420168		+ Einzelnradaufhängung ⁴⁾	289 20,0 18,0 V	
	1.8 2.2 2.4 D		7A-RH010000 7A-RH010000 7A-RH010000	04.89 06.89 04.89			24.3222-1740.3	020566			Rz 22,20	
	1.8 2.2 2.4 D		7A-RH010000 7A-RH010000 7A-RH010000	04.89 06.89 04.89			03.0137-0226.2	650226			254 x 58	

VOLKSWAGEN TRANSPORTER (Typ 2) (60-79)

	1.6 Bus + Kasten 1.8 Bus + Kasten 2.0 Bus + Kasten	2142110466		08.73 08.75	04.79 07.75 04.79		03.6850-0502.4	300044			9"	ATE
	1.6 Bus + Kasten 2.0 Bus + Kasten			05.79 05.79	09.79 07.79		03.6850-5402.4	300055			9"	ATE
	1.1 (44593) 1.2 (21.23)	217072465	217072465	01.60 01.60		- Bremsgerät/ - (S) ⁵⁾ - Bremsgerät/ - (S) ⁵⁾	03.3526-2002.3	340010	1		Bremslichtschalter	
	1.1 (44593) 1.2 (21.23)	227019488 227019488	227072465		12.62	- Bremsgerät/ - (S) ⁵⁾ - Bremsgerät/ - (S) ⁵⁾	03.2122-0704.3 03.3526-2002.3	010134 340010	2		THz 22,20 Bremslichtschalter	ATE
	1.2 (21.23) 1.2 (22.24.25.28) 1.5 (21.23) 1.5 (22.24.25.28) 1.5 (26) 1.6 (21.23) 1.6 (22.24.25.28)	227072466		11.62 02.62 11.62 06.66 08.64 06.66	07.69 07.69 07.69 07.69 12.68 07.69	- Bremsgerät/ - (S) ⁵⁾ - Bremsgerät/ - (S) ⁵⁾ - Bremsgerät/ - (S) ⁵⁾ - Bremsgerät/ - (S) ⁵⁾ - Bremsgerät/ - (S) ⁵⁾ - Bremsgerät/ - (S) ⁵⁾	03.2122-0903.3 03.3526-2002.3	010136 340010	2		THz 22,20 Bremslichtschalter	ATE
	1.5 (26)			08.69	07.70	- Bremsgerät/ - (S) ⁵⁾	03.2122-2905.3 03.3526-2002.3	010141 340010	2	- Bremslichtschalter ⁶⁾	THz 22,20 Bremslichtschalter	ATE
	1.6 Bus + Kasten 1.7 Bus + Kasten 1.8 Bus + Kasten 2.0 Bus + Kasten			08.70 08.71 08.73 08.75	07.79 12.73 07.75 07.79	- Bremsgerät/ - (S) ⁵⁾ - Bremsgerät/ - (S) ⁵⁾ - Bremsgerät/ - (S) ⁵⁾ - Bremsgerät/ - (S) ⁵⁾	03.2120-8411.3 03.3526-2002.3 24.3526-1900.0	010125 340010 340038	1 2		THz 20,64 Bremslichtschalter Bremslichtschalter	ATE
	1.6 Bus + Kasten 1.7 Bus + Kasten			08.73 08.73	07.79 12.73	- Bremsgerät/ + (S) ⁷⁾ - Bremsgerät/ + (S) ⁷⁾	24.3526-1900.0	340038	2		Bremslichtschalter	
	1.6 Bus + Kasten 1.7 Bus + Kasten 1.8 Bus + Kasten 2.0 Bus + Kasten			08.70 08.70 08.73 08.75	07.79 12.73 07.75 07.79	+ Bremsgerät ⁸⁾ + Bremsgerät ⁸⁾ + Bremsgerät ⁸⁾ + Bremsgerät ⁸⁾	03.2123-2604.3 24.3526-1900.0	010178 340038	2		THz 23,81 + WE Bremslichtschalter	ATE
	1.6 Bus + Kasten 1.7 Bus + Kasten 1.8 Bus + Kasten 2.0 Bus + Kasten			08.70 08.70 08.73 08.75	07.79 12.73 07.75 07.79	+ Bremsgerät ⁸⁾ + Bremsgerät ⁸⁾ + Bremsgerät ⁸⁾ + Bremsgerät ⁸⁾	24.3526-1900.0	340038	2		Bremslichtschalter	
	1.6 Bus + Kasten 1.7 Bus + Kasten			08.70 08.71	07.72 07.72		13.0441-5415.2	250116			Dichtungssatz	ATE
	1.6 Bus + Kasten 1.7 Bus + Kasten 1.8 Bus + Kasten 2.0 Bus + Kasten			08.72 08.72 08.73 08.75	07.79 12.73 07.75 07.79		13.2541-8002.2 13.2541-8001.2 13.0441-5416.2	210111 210110 250117		<input type="checkbox"/> <input type="checkbox"/>	D=54 D=54 Dichtungssatz	ATE ATE ATE
	1.6 Bus + Kasten 1.7 Bus + Kasten			08.70 08.71	07.72 07.72		13.0460-6027.2	606027			20011 15,0	ATE
	1.6 Bus + Kasten 1.7 Bus + Kasten 1.8 Bus + Kasten 2.0 Bus + Kasten			08.72 08.72 08.73 08.75	07.79 12.73 07.75 07.79		13.0460-6028.2 13.0460-0157.2	606028 610157			20011 18,5 Belagsatz-Zubehör	ATE ATE
	1.6 Bus + Kasten 1.7 Bus + Kasten 1.8 Bus + Kasten 2.0 Bus + Kasten			08.72 08.72 08.73 08.75	07.79 12.73 07.75 07.79		24.0113-0132.1	413132			278 13,0 11,0	
	1.5 (26) 1.6 Bus + Kasten 1.7 Bus + Kasten 1.8 Bus + Kasten 2.0 Bus + Kasten			08.68 08.70 08.71 08.73 08.75	10.70 07.79 12.73 07.75 07.79		24.5224-0295.3	331261	2		L=295	

¹⁾ + brake pressure regulator / + correttore di frenata / + correcteur de freinage / + corrector de frenado

²⁾ + WC cast iron / + CR ghisa / + CR fontegrise / + CR fundición de gris

³⁾ + WC aluminium / + CR alluminio / + CR aluminium / + CR aluminio

⁴⁾ + independent suspension / + sospens. ruote indipendenti / + suspension indépendante / + suspensión independiente

⁵⁾ - booster unit/ - (S) / - servofreno/ - (S) / - servo-frein/ - (S) / - servofreno/ - (S)

⁶⁾ - stop light switch / - interruttore luce di arresto / - contacteur stop / - interruptor de luz de freno

⁷⁾ - booster unit/ + (S) / - servofreno/ + (S) / - servo-frein/ + (S) / - servofreno/ + (S)

⁸⁾ + booster unit / + servofreno / + servo-frein / + servofreno





VOLKSWAGEN TRANSPORTER (Typ 2) (60-79)

	1.2 (21.23) 1.2 (22.24.25.28) 1.5 (21.23) 1.5 (22.24.25.28) 1.5 (26) 1.6 (21.23) 1.6 (22.24.25.28)			08.63 07.67 08.63 08.66 08.63 12.68 08.63 07.67 06.66 07.70 08.64 12.68 06.66 07.67		24.2725-0903.3 020145 24.2725-0904.3 020146	2 2		Rz 25,40 Rz 25,40
	1.5 (26) 1.6 Bus + Kasten 1.7 Bus + Kasten 1.8 Bus + Kasten 2.0 Bus + Kasten			08.68 10.70 08.70 07.79 08.71 12.73 08.73 07.75 08.75 07.79		83.6101-0250.3 330203 24.5224-0240.3 331260	 		L=250 L=240
	1.1 (44593) 1.2 (21.23) 1.2 (22.24.25.28) 1.5 (21.23) 1.5 (22.24.25.28) 1.5 (26) 1.6 (21.23) 1.6 (22.24.25.28) 1.6 Bus + Kasten			01.60 12.62 01.60 07.67 11.62 08.66 02.62 12.68 11.62 07.67 06.66 10.70 08.64 12.68 06.66 07.67 08.70 07.71		03.3222-0801.3 020067			Rz 22,20
	1.6 Bus + Kasten 1.7 Bus + Kasten 1.8 Bus + Kasten 2.0 Bus + Kasten			08.71 07.79 08.71 12.73 08.73 07.75 08.75 07.79		03.3223-1112.3 020092			Rz 23,81
	1.6 Bus + Kasten 1.7 Bus + Kasten 1.8 Bus + Kasten 2.0 Bus + Kasten			08.73 07.79 08.73 12.73 08.73 07.75 08.75 07.79		03.0137-0055.2 650055 03.0137-9024.2 669024		+ autom. Nachstellung ¹⁾	252 x 56 Bremsbacken-Zubehör
	1.6 Bus + Kasten 1.7 Bus + Kasten 1.8 Bus + Kasten 2.0 Bus + Kasten			08.70 04.79 08.71 12.73 08.73 07.75 08.75 04.79		24.0225-2001.2 480045			252/253,5 x 64
	1.6 Bus + Kasten 2.0 Bus + Kasten			05.79 07.79 05.79 07.79		24.0225-2002.2 480046			252/253,5 x 64
	1.6 Bus + Kasten 1.7 Bus + Kasten 1.8 Bus + Kasten 2.0 Bus + Kasten			08.71 05.79 08.71 12.73 08.73 07.75 08.75 05.79		24.3727-0107.2 580107	2		L=2958
	1.6 Bus + Kasten 2.0 Bus + Kasten			06.79 07.79 06.79 07.79		24.3727-0109.2 580109	2		L=1455
	1.6 Bus 2.0 Bus + Kasten	34		05.79 07.79 05.79 07.79	- luftgekühlt ²⁾	03.2419-8212.3 030020			Gz 19,05
	1.6 Bus 2.0 Bus + Kasten	34		05.79 07.79 05.79 07.79	- luftgekühlt ²⁾	03.2525-2711.3 040030 03.0450-2510.2 082510			Nz 25,40 Nz Reparatursatz
	1.6 Bus 2.0 Bus + Kasten	34		05.79 07.79 05.79 07.79	- luftgekühlt ²⁾	24.5803-0325.3 330051			L=325
	1.6 Bus 1.6 Kasten 2.0 Bus + Kasten	37 37 37		05.79 07.79 05.79 07.79 05.79 07.79	+ luftgekühlt ³⁾	24.3728-0123.2 590123			L=3852

VOLKSWAGEN TRANSPORTER (Typ 2) (79-92)

	1.6 1.6 D 1.6 TD 1.6 TD Syncro 1.7 D 1.9 1.9 Syncro 2.0 2.1 2.1 Syncro			07.79 12.82 01.81 07.87 08.84 09.92 03.86 09.92 10.86 09.92 08.82 09.92 11.84 09.92 05.79 04.86 08.85 09.92 08.85 09.92		03.6850-5402.4 300055			9" ATE
	1.6 1.6 D 1.9 2.0		24-D-200000 24-D-200000 24-D-200000 24-D-200000	07.79 01.81 08.82 05.79	- Bremsgerät ⁴⁾ - Bremsgerät ⁴⁾ - Bremsgerät ⁴⁾ - Bremsgerät ⁴⁾	03.2120-0851.3 010082 03.3526-2002.3 340010	1		THz 20,64 Bremslichtschalter ATE
	1.6 1.6 D 1.6 TD 1.6 TD Syncro 1.7 D 1.9 1.9 Syncro 2.0 2.1 2.1 Syncro			07.79 12.82 01.81 07.87 08.84 09.92 03.86 09.92 10.86 09.92 08.82 09.92 11.84 09.92 05.79 04.86 08.85 09.92 08.85 09.92	- ABS/ + Bremsgerät ⁵⁾ - ABS/ + Bremsgerät ⁵⁾ - ABS/ + Bremsgerät ⁵⁾ - ABS - ABS/ + Bremsgerät ⁵⁾ - ABS/ + Bremsgerät ⁵⁾ - ABS - ABS/ + Bremsgerät ⁵⁾ - ABS/ + Bremsgerät ⁵⁾ - ABS	03.2123-0291.3 010165 03.3526-2002.3 340010	1		THz 23,81 Bremslichtschalter ATE
	1.6 1.6 D 1.6 TD 1.6 TD Syncro 1.7 D 1.9			07.79 12.82 01.81 07.87 08.84 09.92 03.86 09.92 10.86 09.92 08.82 09.92	- ABS/ + Bremsgerät ⁵⁾ - ABS/ + Bremsgerät ⁵⁾ - ABS/ + Bremsgerät ⁵⁾ - ABS - ABS/ + Bremsgerät ⁵⁾ - ABS/ + Bremsgerät ⁵⁾	03.2123-0271.3 010164 24.3526-1900.0 340038 03.3526-2002.3 340010	2 2		THz 23,81 + WE Bremslichtschalter Bremslichtschalter ATE

¹⁾ + automatic adjustment / + correzione automatica / + ajustage automatique / + reajuste automático

²⁾ - air cooled / - raffreddato ad aria / - refroidi par air / - refrigeración por aire

³⁾ + air cooled / + raffreddato ad aria / + refroidi par air / + refrigeración por aire

⁴⁾ - booster unit / - servofreno / - servo-frein / - servofreno

⁵⁾ - ABS/ + booster unit / - ABS/ + servofreno / - ABS/ + servo-frein / - ABS/ + servofreno

VOLKSWAGEN TRANSPORTER (Typ 2) (79-92)



















	1.9 Syncro 2.0 2.1 2.1 Syncro		11.84 05.79 08.85 08.85	09.92 04.86 09.92 09.92	- ABS - ABS/ + Bremsgerät ¹⁾ - ABS/ + Bremsgerät ¹⁾ - ABS	03.2123-0271.3 24.3526-1900.0 03.3526-2002.3	010164 340038 340010	2 2		THz 23,81 + WE Bremslichtschalter Bremslichtschalter	ATE
	1.6 D 1.6 TD 1.6 TD Syncro 1.7 D 1.9 1.9 Syncro 2.0 2.1 2.1 Syncro		08.85 08.85 03.86 08.85 08.85 11.84 08.85 08.85	07.87 + ABS + ABS + ABS + ABS + ABS + ABS + ABS		03.3526-2002.3	340010	2		Bremslichtschalter	
	1.6 1.6 D 1.6 TD 1.9 2.0		24-G-200000 24-G-200000 24-G-200000 24-G-200000 24-G-200000	07.79 01.81 08.84 08.82 05.79	+ Festsättel ²⁾ + Festsättel ²⁾ + Festsättel ²⁾ + Festsättel ²⁾ + Festsättel ²⁾	13.2541-8002.2 13.2541-8001.2 13.0441-5416.2	210111 210110 250117		D=54 D=54 Dichtungssatz	ATE ATE ATE	
	1.6 D 1.6 TD 1.6 TD Syncro 1.7 D 1.9 1.9 Syncro 2.0 2.1 2.1 Syncro		08.85 08.85 03.86 08.85 08.85 11.84 08.85 08.85	07.87 + Faustsättel ³⁾ + Faustsättel ³⁾ 09.92 + Faustsättel ³⁾ + Faustsättel ³⁾ 09.92 + Faustsättel ³⁾ + Faustsättel ³⁾ 09.92		24.3601-1601.5 24.3601-1602.5 11.0101-5403.2	240203 240204 260010		D=60, - Halter D=60, - Halter Faltenbalgsatz	TRW TRW TRW	
	1.6 TD 1.6 TD Syncro 1.7 D 1.9 1.9 Syncro 2.1 2.1 Syncro	24-K-000001 24-J-105001 24-K-000001 24-K-000001 24-J-105001 24-K-000001 24-J-105001		09.92 09.92 09.92 09.92 09.92 09.92 09.92	+ Faustsättel ³⁾ + Faustsättel ³⁾ + Faustsättel ³⁾ + Faustsättel ³⁾ + Faustsättel ³⁾ + Faustsättel ³⁾ + Faustsättel ³⁾	24.3601-1710.5 11.0441-6003.2 11.0101-6004.2 11.8171-0008.1	240276 250037 260014 990049		D=60, - Halter Dichtungssatz Hülzensatz Führungsbolzen	TRW ATE ATE	
	1.6 1.6 D 1.6 TD 1.9 2.0		24-G-200000 24-G-200000 24-G-200000 24-G-200000 24-G-200000	07.79 01.81 08.84 08.82 05.79	+ Festsättel ²⁾ + Festsättel ²⁾ + Festsättel ²⁾ + Festsättel ²⁾ + Festsättel ²⁾	13.0460-6028.2 13.0460-0157.2	606028 610157		20011 18,5 Belagsatz-Zubehör	ATE ATE	
	1.6 D 1.6 TD 1.6 TD Syncro 1.7 D 1.9 1.9 Syncro 2.0 2.1 2.1 Syncro		08.85 08.85 03.86 08.85 08.85 11.84 08.85 08.85	07.87 + Faustsättel ³⁾ + Faustsättel ³⁾ 09.92 + Faustsättel ³⁾ + Faustsättel ³⁾ 09.92 + Faustsättel ³⁾ + Faustsättel ³⁾ 09.92		13.0460-2903.2	602903		20979 19,4 /S	TRW	
	1.6 1.6 D 1.6 TD 1.9 2.0		24-G-200000 24-G-200000 24-G-200000 24-G-200000 24-G-200000	07.79 01.81 08.84 08.82 05.79	+ Festsättel ²⁾ + Festsättel ²⁾ + Festsättel ²⁾ + Festsättel ²⁾ + Festsättel ²⁾	24.0113-0142.1	413142		278 13,0 11,0		
	1.6 D 1.6 TD 1.7 D 1.9 2.0 2.1		08.85 08.85 08.85 08.85 08.85 08.85	07.87 + Faustsättel ³⁾ + Faustsättel ³⁾ + Faustsättel ³⁾ + Faustsättel ³⁾ + Faustsättel ³⁾ + Faustsättel ³⁾		24.0116-0104.1	416104		258 16,0 13,0 +B		
	1.6 TD Syncro 1.9 Syncro 2.1 Syncro		03.86 11.84 08.85	09.92 + 14" Rad ⁴⁾ + 14" Rad ⁴⁾ + 14" Rad ⁴⁾		24.0116-0109.1	416109		258 16,0 13,0		
	1.6 1.6 D 1.6 TD 1.9 2.0		07.79 01.81 08.84 08.82 05.79	12.82 07.85 07.85 07.85 07.85		83.7824-0383.3	330856	2	L=380		
	1.6 D 1.6 TD 1.7 D 1.9 2.0 2.1		24-G-200000 24-G-200000 24-G-200000 24-G-200000 24-G-200000 24-G-200000	08.85 08.85 08.85 08.85 08.85 08.85	+ Festsättel ²⁾ + Festsättel ²⁾ + Festsättel ²⁾ + Festsättel ²⁾ + Festsättel ²⁾ + Festsättel ²⁾	24.5224-0295.3	331261	2	L=295		
	1.6 D 1.6 TD 1.6 TD Syncro 1.7 D 1.9 1.9 Syncro 2.0 2.1 2.1 Syncro		08.85 08.85 03.86 08.85 08.85 11.84 08.85 08.85	07.87 + Faustsättel ³⁾ + Faustsättel ³⁾ 09.92 + Faustsättel ³⁾ + Faustsättel ³⁾ 09.92 + Faustsättel ³⁾ + Faustsättel ³⁾ 09.92		24.5224-0440.3	331378	2	L=445		

¹⁾ - ABS/ + booster unit / - ABS/ + servofreno / - ABS/ + servo-frein / - ABS/ + servofreno

²⁾ + fixed calipers / + pinze freno fisse / + étriers fixes / + pinza de fija

³⁾ + fist type calipers / + pinza freno flottante / + étriers à griffe / + pinza de puno























⁴⁾ + 14" wheel / + ruota 14" / + roue 14" / + rueda 14"

									
VOLKSWAGEN TRANSPORTER (Typ 2) (79-92)									
	1.6 1.6 D 1.6 TD 1.6 TD Syncro 1.7 D 1.9 1.9 Syncro 2.0 2.1 2.1 Syncro			07.79 12.82 01.81 07.87 08.84 09.92 03.86 09.92 10.86 09.92 08.82 09.92 11.84 09.92 05.79 04.86 08.85 09.92 08.85 09.92		24.5204-0180.3	331461	2	L=180
	1.6 1.6 D 1.6 TD 1.6 TD Syncro 1.7 D 1.9 1.9 Syncro 2.0 2.1 2.1 Syncro			07.79 12.82 01.81 07.87 08.84 09.92 03.86 09.92 + 14" Rad ¹⁾ 10.86 09.92 08.82 09.92 11.84 09.92 + 14" Rad ¹⁾ 05.79 04.86 08.85 09.92 08.85 09.92 + 14" Rad ¹⁾		03.3223-1112.3	020092		Rz 23,81
	1.6 1.6 D 1.6 TD 1.6 TD Syncro 1.7 D 1.9 1.9 Syncro 2.0 2.1 2.1 Syncro			07.79 12.82 01.81 07.87 08.84 09.92 03.86 09.92 + 14" Rad ¹⁾ 10.86 09.92 08.82 09.92 11.84 09.92 + 14" Rad ¹⁾ 05.79 04.86 08.85 09.92 08.85 09.92 + 14" Rad ¹⁾		03.0137-0148.2 03.0137-9035.2	650148 669035		252 x 56 HEB Bremsbacken-Zubehör
	1.6 TD Syncro 1.9 Syncro 2.1 Syncro	24-J-000001 24-J-000001 24-J-000001		09.92 + 16" Rad ²⁾ 09.92 + 16" Rad ²⁾ 09.92 + 16" Rad ²⁾		03.0137-0252.2 03.0137-9152.2	650252 669152		270 x 66 HEB Bremsbacken-Zubehör
	1.6 1.6 D 1.6 TD 1.6 TD Syncro 1.7 D 1.9 1.9 Syncro 2.0 2.1 2.1 Syncro			07.79 12.82 01.81 07.87 08.84 09.92 03.86 09.92 + 14" Rad ¹⁾ 10.86 09.92 08.82 09.92 11.84 09.92 + 14" Rad ¹⁾ 05.79 04.86 08.85 09.92 08.85 09.92 + 14" Rad ¹⁾		24.0225-2002.2	480046		252/253,5 x 64
	1.6 1.6 D 1.6 TD 1.6 TD Syncro 1.7 D 1.9 1.9 Syncro 2.0 2.1 2.1 Syncro			07.79 12.82 01.81 07.87 08.84 09.92 03.86 09.92 + 14" Rad ¹⁾ 10.86 09.92 08.82 09.92 11.84 09.92 + 14" Rad ¹⁾ 05.79 04.86 08.85 09.92 08.85 09.92 + 14" Rad ¹⁾		03.0420-0423.3	680423		23,81/252x56 Kit ATE
	1.6 1.6 D 1.6 TD 1.7 D 1.9 2.0 2.1			07.79 12.82 01.81 07.87 08.84 09.92 10.86 09.92 08.82 09.92 05.79 04.86 08.85 09.92		24.3727-0109.2	580109	2 	L=1455
	1.6 D 1.6 TD 1.6 TD Syncro 1.7 D 1.9 1.9 Syncro 2.0 2.1 2.1 Syncro			01.81 07.87 08.84 09.92 03.86 09.92 10.86 09.92 08.82 09.92 11.84 09.92 05.79 04.86 - luftgekühlt ³⁾ 08.85 09.92 08.85 09.92		03.2419-8212.3	030020		Gz 19,05
	1.6 D 1.6 TD 1.6 TD Syncro 1.7 D 1.9 1.9 Syncro 2.0 2.1 2.1 Syncro			01.81 07.87 08.84 09.92 03.86 09.92 10.86 09.92 08.82 09.92 11.84 09.92 05.79 04.86 - luftgekühlt ³⁾ 08.85 09.92 08.85 09.92		03.2525-2711.3 03.0450-2510.2	040030 082510		Nz 25,40 Nz Reparatursatz
	1.6 D 1.6 TD 1.7 D 1.9 2.0 2.1			01.81 07.87 08.84 09.92 10.86 09.92 08.82 09.92 05.79 04.86 - luftgekühlt ³⁾ 08.85 09.92		24.5803-0325.3	330051		L=325

¹⁾ + 14" wheel / + ruota 14" / + roue 14" / + rueda 14"

²⁾ + 16" wheel / + ruota 16" / + roue 16" / + rueda 16"

³⁾ - air cooled / - raffreddato ad aria / - refroidi par air / - refrigeración por aire

VOLKSWAGEN TRANSPORTER (Typ 2) (79-92)											
	1.6 2.0	37	07.79 05.79	12.82 12.82	+ luftgekühlt ¹⁾	24.3728-0123.2	590123			L=3852	
VOLKSWAGEN TYP 181 (69-79)											
	1.5 1.6		08.69 08.70	07.70 07.72		03.2119-8511.3 03.3526-2002.3	010062 340010	1		THz 19,05 Bremslichtschalter	ATE
	1.6		08.72	02.79		03.2119-8711.3 24.3526-1900.0	010064 340038	2		THz 19,05 + WE Bremslichtschalter	ATE
	1.5 1.6		08.69 08.70	07.70 07.72		03.2119-8611.3 03.3526-2002.3	010063 340010	1		THz 19,05 Bremslichtschalter	ATE
	1.5 1.6		08.69 08.70	07.70 02.79		24.5171-0393.3	331311	2		L=393	
	1.5 1.6		08.69 08.70	07.70 02.79		03.3222-5211.3	020081			Rz 22,20	
	1.5 1.6		08.69 08.70	07.70 02.79		03.0137-0041.2 03.0137-9229.2	650041 669229			230 x 40 Bremsbacken-Zubehör	ATE
	1.5 1.6		08.69 08.70	07.70 02.79		24.5224-0240.3	331260	2		L=240	
	1.6		03.73	02.79		03.3217-1811.3	020026			Rz 17,46	
	1.6	1832346255		02.79		03.0137-0041.2	650041			230 x 40	ATE
	1.6	1832346255		02.79		03.0420-2917.3	682917			17,46/230x40 Kit	ATE
VOLVO 66 (75-80)											
	1.1 L/DL 1.3 DL/GL		07.75 07.75	12.80 12.80		13.0460-3010.2	603010			20009 15,0	ATE
	1.1 L/DL 1.3 DL/GL		07.75 07.75	12.80 12.80		83.6104-0220.3	330474	2		L=220	
	1.1 L/DL 1.3 DL/GL		07.75 07.75	12.80 12.80		03.0137-9173.2	669173			Bremsbacken-Zubehör	
VOLVO 140 Limousine (68-75)											
	1.8 (142) 1.8 (144) 2.0 (142) 2.0 (144)	358188 381525 358188 381525		08.75 08.75 08.75 08.75	+ E+F-Motor/ + Servolenkung ²⁾	03.2122-1906.3	010761			THz 22,20 - Behälter	ATE
	1.8 2.0		01.68 01.68	08.75 08.75		13.0460-2953.2 13.0460-0422.2	602953 610422			20200 16,0 Belagsatz-Zubehör	TRW
	1.8 2.0		01.69 01.69	08.75 08.75		13.0460-2954.2 13.0460-0088.2	602954 610088			20088 14,3 Belagsatz-Zubehör	TRW ATE
VOLVO 145 Kombi (68-75)											
	2.0	179797		02.75	+ E+F-Motor/ + Servolenkung ²⁾	03.2122-1906.3	010761			THz 22,20 - Behälter	ATE
	2.0		08.68	02.75		13.0460-2953.2 13.0460-0422.2	602953 610422			20200 16,0 Belagsatz-Zubehör	TRW TRW
	2.0		01.69	02.75		13.0460-2954.2 13.0460-0088.2	602954 610088			20088 14,3 Belagsatz-Zubehör	TRW ATE
VOLVO 164 (68-74)											
	2.9	079022		07.74	+ Bremsgerät ³⁾	03.2122-1906.3	010761			THz 22,20 - Behälter	ATE
	2.9		08.68	07.74		13.0460-2953.2 13.0460-0422.2	602953 610422			20200 16,0 Belagsatz-Zubehör	TRW TRW
	2.9	105782		07.74		13.0460-0088.2	610088			Belagsatz-Zubehör	ATE
	2.9	132567		07.74		83.6383-0300.3	330371	2		L=300	

¹⁾ + air cooled / + raffreddato ad aria / + refroidi par air / + refrigeración por aire

²⁾ + E+F-engine/ + power steering / + motore E+F/ + servosterzo / + moteur E+F/+ direct.assistée / + motor E+F/ + direcc.asistida

³⁾ + booster unit / + servofreno / + servo-frein / + servofreno

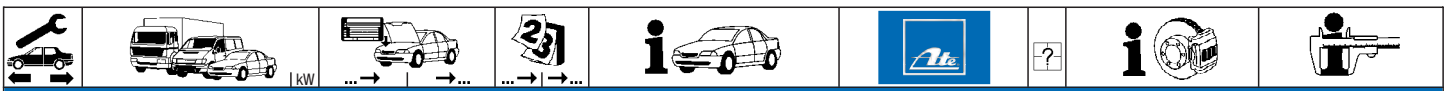





VOLVO 240 Limousine (74-93)

	2.0	60		08.74	07.76	- (USA)	03.2022-0111.3	010004		THz 22,30/15,75 - B.	ATE
	2.0	66	274964	08.76		- (USA) / + 4 türig ¹⁾					
	2.0	66	122894	08.76		- (USA) / + 2 türig ²⁾					
	2.1	71		08.74	07.75	- (USA)					
	2.1	74	274964	08.75		- (USA) / + 4 türig ¹⁾					
	2.1	74	122894	08.75		- (USA) / + 2 türig ²⁾					
	2.1	90	274894	08.74		- (USA) / + 4 türig ¹⁾					
	2.1	90	122894	08.74		- (USA) / + 2 türig ²⁾					
	2.0	66	122895		08.78	- (USA) / + 2 türig ²⁾					
	2.0	66	274965		08.78	- (USA) / + 4 türig ¹⁾					
	2.1	74	122895		08.78	- (USA) / + 2 türig ²⁾					
	2.1	74	274965		08.78	- (USA) / + 4 türig ¹⁾					
	2.1	90	122895		08.78	- (USA) / + 2 türig ²⁾					
	2.1	90	274895		08.78	- (USA) / + 4 türig ¹⁾					
	2.0	60		08.74	07.76	+ (USA)					
2.0	66		08.76	08.78	+ (USA)						
2.1	71		08.74	07.75	+ (USA)						
2.1	74		08.75	08.78	+ (USA)						
2.1	90		08.74	08.78	+ (USA)						
2.0	66		09.78	07.79		03.2022-0111.3	010004	Auslaß seitlich links ³⁾	THz 22,30/15,75 - B.	ATE	
2.0	71		09.78	08.83							03.2022-0112.3
2.0	76		08.84	07.85							
2.0	100		10.82	08.84							
2.1	74		09.78	07.80							
2.1	79		08.80	07.84							
2.1	90		09.78	07.80							
2.1 T	114		08.80	07.84							
2.3	81		08.84	07.86							
2.3	82		08.80	07.84							
2.3	83		08.86	07.87							
2.3	85		08.86	08.87							
2.3	96		08.83	07.85							
2.3	98		08.84	12.89							
2.3	100		08.80	07.83							
2.3	103		08.78	07.80							
2.3 i Katalysator	85		08.86	08.87							
2.4 D	60		08.78	07.85							
2.7	104		08.79	07.80							
2.3	◀ 85		09.87	12.88	- ABS	03.2022-0112.3	010005		THz 22,30/15,75	ATE	
2.3 i Katalysator	◀ 85		09.87	07.93	- ABS						
2.4 D	◀ 58		09.87	08.93	- ABS						
2.3	▶ 85		09.87	12.88	- ABS	03.2022-0111.3	010004		THz 22,30/15,75 - B.	ATE	
2.3 i Katalysator	▶ 85		09.87	07.93	- ABS						
2.4 D	▶ 58		09.87	08.93	- ABS						
	2.0	60		08.74	07.76		13.0460-2953.2	602953		20200 16,0	TRW
	2.0	66		08.76	07.79						
	2.0	71		09.78	08.83						
	2.0	76		08.84	07.85						
	2.0	100		10.82	08.84						
	2.1	71		08.74	07.75						
	2.1	74		08.75	07.80						
	2.1	79		08.80	07.84						
	2.1	90		08.74	07.80						
	2.1 T	114		08.80	07.84						
	2.3	81		08.84	07.86						
	2.3	82		08.80	07.84						
	2.3	83		08.86	07.87						
	2.3	85		08.86	12.88						
	2.3	96		08.83	07.85						
2.3	98		08.84	12.89							
2.3	100		08.80	07.83							
2.3	103		08.78	07.80							
2.3 i Katalysator	85		08.86	07.93							
2.4 D	58		08.87	08.93							
2.4 D	60		08.78	07.85							
2.7	104		08.79	07.80							
	2.0	60		08.74	07.76		24.0114-0101.1	414101		263 14,3 12,7	
	2.0	66		08.76	07.79						
	2.0	71		08.74	08.83						
	2.0	76		08.84	07.85						
	2.0	100		10.82	08.84						
	2.1	71		08.74	07.75						
	2.1	74		08.75	07.80						
	2.1	79		08.80	07.84						
	2.1	90		08.74	07.80						
	2.1 T	114		08.80	07.84						
	2.3	81		08.84	07.86						
	2.3	82		08.80	07.84						
	2.3	83		08.86	07.87						
	2.3	85		08.86	08.87						
	2.3	96		08.83	07.85						
2.3	98		08.84	08.87							
2.3	100		08.80	07.83							
2.3	103		08.78	07.80							
2.3 i Katalysator	85		08.86	08.87							
2.4 D	60		08.78	07.85							

¹⁾ - (USA) / + 4 door / - (USA) / + 4 porte / - (USA) / + 4 portes / - (USA) / + 4 puertas
²⁾ - (USA) / + 2 door / - (USA) / + 2 porte / - (USA) / + 2 portes / - (USA) / + 2 puertas
³⁾ outlet lateral left hand / scarico laterale sinistro / sortie latérale gauche / salida lateral izquierda
⁴⁾ outlet lateral right hand / scarico laterale destro / sortie latérale droite / salida lateral derecha
⁵⁾ - ventilated discs / - dischi ventilati / - disques ventilés / - disco ventilado







VOLVO 240 Limousine (74-93)										
	2.7	104		08.79	07.80	24.0114-0101.1	414101			263 14,3 12,7
	2.0	60		08.74	07.76	24.0122-0127.1	422127			263 22,0 20,4 V
	2.0	66		08.76	07.79					
	2.0	71		09.78	08.83					
	2.0	76		08.84	07.85					
	2.0	100		10.82	08.84					
	2.1	71		08.74	07.75					
	2.1	74		08.75	07.80					
	2.1	79		08.80	07.84					
	2.1	90		08.74	07.80					
	2.1 T	114		08.80	07.84					
	2.3	81		08.84	07.86					
	2.3	82		08.80	07.84					
	2.3	83		08.86	07.87					
	2.3	85		08.86	12.88					
	2.3	96		08.83	07.85					
	2.3	98		08.84	12.89					
	2.3	100		08.80	07.83					
	2.3	103		08.78	07.80					
	2.3 i Katalysator	85		08.86	07.93					
	2.4 D	58		08.87	08.93					
	2.4 D	60		08.78	07.85					
	2.7	104		08.79	07.80					
	2.0	66		09.78	07.79	83.6204-0286.3	330733	4		L=285
	2.0	71		09.78	08.83					
	2.0	76		08.84	07.85					
	2.0	100		10.82	08.84					
	2.1	74		09.78	07.80					
	2.1	79		08.80	07.84					
	2.1	90		09.78	07.80					
	2.1 T	114		08.80	07.84					
	2.3	81		08.84	07.86					
	2.3	82		08.80	07.84					
	2.3	83		08.86	07.87					
	2.3	85		08.86	08.87					
	2.3	96		08.83	07.85					
	2.3	98		08.84	12.89					
	2.3	100		08.80	07.83					
	2.3	103		08.78	07.80					
	2.3 i Katalysator	85		08.86	07.93					
	2.4 D	58		08.87	08.93					
	2.4 D	60		08.78	07.85					
	2.7	104		08.79	07.80					
	2.0	60		08.74	07.76	13.2381-0039.2	210020	<input type="checkbox"/>		D=38 ATE
	2.0	66		08.76	07.79	13.2381-0040.2	210021	<input type="checkbox"/>		D=38 ATE
	2.0	71		09.78	08.83	13.0441-3812.2	250068			Dichtungssatz ATE
	2.0	76		08.84	07.85					
	2.0	100		10.82	08.84					
	2.1	71		08.74	07.75					
	2.1	74		08.75	07.80					
	2.1	79		08.80	07.84					
	2.1	90		08.74	07.80					
	2.1 T	114		08.80	07.84					
	2.3	81		08.84	07.86					
	2.3	82		08.80	07.84					
	2.3	83		08.86	07.87					
	2.3	85		08.86	12.88					
	2.3	96		08.83	07.85					
	2.3	98		08.84	12.89					
	2.3	100		08.80	07.83					
	2.3	103		08.78	07.80					
	2.3 i Katalysator	85		08.86	07.93					
	2.4 D	58		08.87	08.93					
	2.4 D	60		08.78	07.85					
	2.7	104		08.79	07.80					
	2.0	60		08.74	07.76	13.0460-2954.2	602954			20088 14,3 TRW
	2.0	66		08.76	07.79	13.0460-0088.2	610088			Belagsatz-Zubehör ATE
	2.0	71		09.78	08.83					
	2.0	76		08.84	07.85					
	2.0	100		10.82	08.84					
	2.1	71		08.74	07.75					
	2.1	74		08.75	07.80					
	2.1	79		08.80	07.84					
	2.1	90		08.74	07.80					
	2.1 T	114		08.80	07.84					
	2.3	81		08.84	07.86					
	2.3	82		08.80	07.84					
	2.3	83		08.86	07.87					
	2.3	85		08.86	12.88					
	2.3	96		08.83	07.85					
	2.3	98		08.84	12.89					
	2.3	100		08.80	07.83					
	2.3	103		08.78	07.80					
	2.3 i Katalysator	85		08.86	07.93					
	2.4 D	58		08.87	08.93					
	2.4 D	60		08.78	07.85					
	2.7	104		08.79	07.80					





VOLVO 240 Limousine (74-93)

	2.0	60		08.74	07.76	24.0110-0189.1	410189		281 9,6 8,4 +B
	2.0	66		08.76	07.79				
	2.0	71		09.78	08.83				
	2.0	76		08.84	07.85				
	2.0	100		10.82	08.84				
	2.1	71		08.74	07.75				
	2.1	74		08.75	07.80				
	2.1	79		08.80	07.84				
	2.1	90		08.74	07.80				
	2.1 T	114		08.80	07.84				
	2.3	81		08.84	07.86				
	2.3	82		08.80	07.84				
	2.3	83		08.86	07.87				
	2.3	85		08.86	12.88				
	2.3	96		08.83	07.85				
	2.3	98		08.84	12.89				
	2.3	100		08.80	07.83				
	2.3	103		08.78	07.80				
	2.3 i Katalysator	85		08.86	07.93				
	2.4 D	58		08.87	08.93				
	2.4 D	60		08.78	07.85				
	2.7	104		08.79	07.80				
	2.0	60		08.74	07.76	83.6383-0300.3	330371	2	L=300
	2.0	66		08.76	07.79				
	2.0	71		09.78	08.83				
	2.0	76		08.84	07.85				
	2.0	100		10.82	08.84				
	2.1	71		08.74	07.75				
	2.1	74		08.75	07.80				
	2.1	79		08.80	07.84				
	2.1	90		08.74	07.80				
	2.1 T	114		08.80	07.84				
	2.3	81		08.84	07.86				
	2.3	82		08.80	07.84				
	2.3	83		08.86	07.87				
	2.3	85		08.86	12.88				
	2.3	96		08.83	07.85				
	2.3	98		08.84	12.89				
	2.3	100		08.80	07.83				
	2.3	103		08.78	07.80				
	2.3 i Katalysator	85	471317	08.86					
	2.4 D	58	471317	08.87					
	2.4 D	60		08.78	07.85				
	2.7	104		08.79	07.80				
	2.3 i Katalysator	85	471318	07.93		83.6124-0305.3	330723	2	L=305
	2.4 D	58	471318	08.93					
	2.0	60		08.74	07.76	03.0137-0169.2	650169		160 x 25
	2.0	66		08.76	07.79	03.0137-9065.2	669065		Bremsbacken-Zubehör
	2.0	71		09.78	08.83				
	2.0	76		08.84	07.85				
	2.0	100		10.82	08.84				
	2.1	71		08.74	07.75				
	2.1	74		08.75	07.80				
	2.1	79		08.80	07.84				
	2.1	90		08.74	07.80				
	2.1 T	114		08.80	07.84				
	2.3	81		08.84	07.86				
	2.3	82		08.80	07.84				
	2.3	83		08.86	07.87				
	2.3	85		08.86	12.88				
	2.3	96		08.83	07.85				
	2.3	98		08.84	12.89				
	2.3	100		08.80	07.83				
	2.3	103		08.78	07.80				
	2.3 i Katalysator	85		08.86	07.93				
	2.4 D	58		08.87	08.93				
	2.4 D	60		08.78	07.85				
	2.7	104		08.79	07.80				
	2.0	60		08.74	07.76	24.3727-1313.2	581313	2	L=1932
	2.0	66		08.76	07.79				
	2.0	71		09.78	08.83				
	2.0	76		08.84	07.85				
	2.0	100		10.82	08.84				
	2.1	71		08.74	07.75				
	2.1	74		08.75	07.80				
	2.1	79		08.80	07.84				
	2.1	90		08.74	07.80				
	2.1 T	114		08.80	07.84				
	2.3	81		08.84	07.86				
	2.3	82		08.80	07.84				
	2.3	83		08.86	07.87				
	2.3	85		08.86	12.88				
	2.3	96		08.83	07.85				
	2.3	98		08.84	12.89				
	2.3	100		08.80	07.83				
	2.3	103		08.78	07.80				
	2.3 i Katalysator	85		08.86	07.93				



VOLVO 240 Limousine (74-93)						
	2.4 D 58 2.4 D 60 2.7 104		08.87 08.93 08.78 07.85 08.79 07.80	24.3727-1313.2 581313	2	L=1932
	2.4 D 58 2.4 D 60		08.87 08.93 08.78 07.85	24.3728-1301.2 591301		L=1100
VOLVO 240 Kombi (74-93)						
	2.0 60 2.0 66 2.1 71 2.1 74 2.1 90	163834 163834 163834	08.74 07.76 - USA 08.76 - USA 08.74 07.75 - USA 08.75 - USA 08.74 - USA	03.2022-0111.3 010004		THz 22,30/15,75 - B. ATE
	2.0 66 2.1 74 2.1 90	163835 163835 163835	08.78 - USA 08.78 - USA 08.78 - USA	03.2022-0112.3 010005		THz 22,30/15,75 ATE
	2.0 60 2.0 66 2.1 71 2.1 74 2.1 90		08.74 07.76 + USA 08.76 08.78 + USA 08.74 07.75 + USA 08.75 08.78 + USA 08.74 08.78 + USA	03.2022-0109.3 010003		THz 22,30/15,75 ATE
	2.0 66 2.0 71 2.0 76 2.0 86 2.0 100 2.1 74 2.1 79 2.1 80 2.1 90 2.1 T 114 2.3 81 2.3 82 2.3 83 2.3 85 2.3 96 2.3 98 2.3 100 2.3 i Katalysator 85 2.4 D 60 2.7 104 2.8 95 2.8 114		09.78 01.82 08.80 12.84 08.84 07.85 08.83 08.87 10.82 08.84 09.78 07.80 08.80 07.84 08.80 07.84 09.78 07.79 08.80 07.85 08.84 07.86 08.80 07.84 08.86 07.87 08.86 08.87 08.84 07.85 08.84 08.87 01.83 12.84 08.86 08.87 04.79 08.87 08.79 07.80 10.81 09.82 10.80 09.82	03.2022-0111.3 010004 03.2022-0112.3 010005		Auslaß seitlich links ¹⁾ Auslaß seitlich rechts ²⁾ THz 22,30/15,75 - B. ATE THz 22,30/15,75 ATE
	2.0 86 2.3 85 2.3 98 2.3 i Katalysator 85 2.3 i Katalysator 100 2.4 D 58 2.4 D 60		09.87 07.93 - ABS 09.87 12.88 - ABS 09.87 12.88 - ABS 09.87 07.93 - ABS 08.91 07.92 - ABS 08.88 08.93 - ABS 09.87 08.93 - ABS	03.2022-0112.3 010005		THz 22,30/15,75 ATE
	2.0 86 2.3 85 2.3 98 2.3 i Katalysator 85 2.3 i Katalysator 100 2.4 D 58 2.4 D 60		09.87 07.93 - ABS 09.87 12.88 - ABS 09.87 12.88 - ABS 09.87 07.93 - ABS 08.91 07.92 - ABS 08.88 08.93 - ABS 09.87 08.93 - ABS	03.2022-0111.3 010004		THz 22,30/15,75 - B. ATE
	2.0 60 2.0 66 2.0 71 2.0 76 2.0 86 2.0 100 2.1 71 2.1 74 2.1 79 2.1 80 2.1 90 2.1 T 114 2.3 81 2.3 82 2.3 83 2.3 85 2.3 96 2.3 98 2.3 100 2.3 i Katalysator 85 2.3 i Katalysator 100 2.4 D 58 2.4 D 60 2.7 104 2.8 95 2.8 114		08.74 07.76 08.76 01.82 08.80 12.84 08.84 07.85 08.83 07.93 10.82 08.84 08.74 07.75 08.75 07.80 08.80 07.84 08.80 07.84 08.74 07.79 08.80 07.85 08.84 07.86 08.80 07.84 08.86 07.87 08.86 12.88 08.84 07.85 08.84 12.88 01.83 12.84 08.86 07.93 08.91 07.92 08.88 08.93 04.79 08.93 08.79 07.80 10.81 09.82 10.80 09.82	13.0460-2953.2 602953 13.0460-0422.2 610422		- belüftete Scheiben ³⁾ 20200 16,0 Belagsatz-Zubehör TRW TRW















¹⁾ outlet lateral left hand / scarico laterale sinistro / sortie latérale gauche / salida lateral izquierda

²⁾ outlet lateral right hand / scarico laterale destro / sortie latérale droite / salida lateral derecha















³⁾ - ventilated discs / - dischi ventilati / - disques ventilés / - disco ventilado

VOLVO 240 Kombi (74-93)

	2.0	60		08.74	07.76	24.0114-0101.1	414101		263 14,3 12,7	
	2.0	66		08.76	01.82					
	2.0	71		08.80	12.84					
	2.0	76		08.84	07.85					
	2.0	86		08.83	07.93					
	2.0	100		10.82	08.84					
	2.1	71		08.74	07.75					
	2.1	74		08.75	07.80					
	2.1	79		08.80	07.84					
	2.1	80		08.80	07.84					
	2.1	90		08.74	07.79					
	2.1 T	114		08.80	07.85					
	2.3	81		08.84	07.86					
	2.3	82		08.80	07.84					
	2.3	83		08.86	07.87					
	2.3	85		08.86	12.88					
	2.3	96		08.84	07.85					
	2.3	98		08.84	12.88					
	2.3	100		01.83	12.84					
	2.3 i Katalysator	85		08.86	07.93					
	2.3 i Katalysator	100		08.91	07.92					
	2.4 D	58		08.88	08.93					
	2.4 D	60		04.79	08.93					
	2.7	104		08.79	07.80					
	2.8	95		10.81	09.82					
	2.8	114		10.80	09.82					
	2.0	60		08.74	07.76	24.0122-0127.1	422127		263 22,0 20,4 V	
	2.0	66		08.76	01.82					
	2.0	71		08.80	12.84					
	2.0	76		08.84	07.85					
	2.0	86		08.83	07.93					
	2.0	100		10.82	08.84					
	2.1	71		08.74	07.75					
	2.1	74		08.75	07.80					
	2.1	79		08.80	07.84					
	2.1	80		08.80	07.84					
	2.1	90		08.74	07.79					
	2.1 T	114		08.80	07.85					
	2.3	81		08.84	07.86					
	2.3	82		08.80	07.84					
	2.3	83		08.86	07.87					
	2.3	85		08.86	12.88					
	2.3	96		08.84	07.85					
	2.3	98		08.84	12.88					
	2.3	100		01.83	12.84					
	2.3 i Katalysator	85		08.86	07.93					
	2.3 i Katalysator	100		08.91	07.92					
	2.4 D	58		08.88	08.93					
	2.4 D	60		04.79	08.93					
	2.7	104		08.79	07.80					
	2.8	95		10.81	09.82					
	2.8	114		10.80	09.82					
	2.0	66		09.78	01.82	83.6204-0286.3	330733	4	L=285	
	2.0	71		08.80	12.84					
	2.0	76		08.84	07.85					
	2.0	86		08.83	07.93					
	2.0	100		10.82	08.84					
	2.1	74		09.78	07.80					
	2.1	79		08.80	07.84					
	2.1	80		08.80	07.84					
	2.1	90		09.78	07.79					
	2.1 T	114		08.80	07.85					
	2.3	81		08.84	07.86					
	2.3	82		08.80	07.84					
	2.3	83		08.86	07.87					
	2.3	85		08.86	12.88					
	2.3	96		08.84	07.85					
	2.3	98		08.84	12.88					
	2.3	100		01.83	12.84					
	2.3 i Katalysator	85		08.86	07.93					
	2.3 i Katalysator	100		08.91	07.92					
	2.4 D	58		08.88	08.93					
	2.4 D	60		04.79	08.93					
	2.7	104		08.79	07.80					
	2.8	95		10.81	09.82					
	2.8	114		10.80	09.82					
	2.0	60		08.74	07.76	13.2381-0039.2	210020	<input type="checkbox"/>	D=38	ATE
	2.0	66		08.76	01.82	13.2381-0040.2	210021	<input type="checkbox"/>	D=38	ATE
	2.0	71		08.80	12.84	13.0441-3812.2	250068		Dichtungssatz	ATE
	2.0	76		08.84	07.85					
	2.0	86		08.83	07.93					
	2.0	100		10.82	08.84					
	2.1	71		08.74	07.75					
	2.1	74		08.75	07.80					
	2.1	79		08.80	07.84					
	2.1	80		08.80	07.84					
	2.1	90		08.74	07.79					

	 kW							
VOLVO 240 Kombi (74-93)								
	2.1 T 114		08.80	07.85	13.2381-0039.2	210020		D=38 ATE
	2.3 81		08.84	07.86	13.2381-0040.2	210021		D=38 ATE
	2.3 82		08.80	07.84	13.0441-3812.2	250068		Dichtungssatz ATE
	2.3 83		08.86	07.87				
	2.3 85		08.86	12.88				
	2.3 96		08.84	07.85				
	2.3 98		08.84	12.88				
	2.3 100		01.83	12.84				
	2.3 i Katalysator 85		08.86	07.93				
	2.3 i Katalysator 100		08.91	07.92				
	2.4 D 58		08.88	08.93				
	2.4 D 60		04.79	08.93				
	2.7 104		08.79	07.80				
	2.8 95		10.81	09.82				
	2.8 114		10.80	09.82				
	2.0 60		08.74	07.76	13.0460-2954.2	602954		20088 14,3 TRW
	2.0 66		08.76	01.82	13.0460-0088.2	610088		Belagsatz-Zubehör ATE
	2.0 71		08.80	12.84				
	2.0 76		08.84	07.85				
	2.0 86		08.83	07.93				
	2.0 100		10.82	08.84				
	2.1 71		08.74	07.75				
	2.1 74		08.75	07.80				
	2.1 79		08.80	07.84				
	2.1 80		08.80	07.84				
	2.1 90		08.74	07.79				
	2.1 T 114		08.80	07.85				
	2.3 81		08.84	07.86				
	2.3 82		08.80	07.84				
	2.3 83		08.86	07.87				
	2.3 85		08.86	12.88				
	2.3 96		08.84	07.85				
	2.3 98		08.84	12.88				
	2.3 100		01.83	12.84				
	2.3 i Katalysator 85		08.86	07.93				
	2.3 i Katalysator 100		08.91	07.92				
	2.4 D 58		08.88	08.93				
	2.4 D 60		04.79	08.93				
	2.7 104		08.79	07.80				
	2.8 95		10.81	09.82				
	2.8 114		10.80	09.82				
	2.0 60		08.74	07.76	24.0110-0189.1	410189		281 9,6 8,4 +B
	2.0 66		08.76	01.82				
	2.0 71		08.80	12.84				
	2.0 76		08.84	07.85				
	2.0 86		08.83	07.93				
	2.0 100		10.82	08.84				
	2.1 71		08.74	07.75				
	2.1 74		08.75	07.80				
	2.1 79		08.80	07.84				
	2.1 80		08.80	07.84				
	2.1 90		08.74	07.79				
	2.1 T 114		08.80	07.85				
	2.3 81		08.84	07.86				
	2.3 82		08.80	07.84				
	2.3 83		08.86	07.87				
	2.3 85		08.86	12.88				
	2.3 96		08.84	07.85				
	2.3 98		08.84	12.88				
	2.3 100		01.83	12.84				
	2.3 i Katalysator 85		08.86	07.93				
	2.3 i Katalysator 100		08.91	07.92				
	2.4 D 58		08.88	08.93				
	2.4 D 60		04.79	08.93				
	2.7 104		08.79	07.80				
	2.8 95		10.81	09.82				
	2.8 114		10.80	09.82				
	2.0 60		08.74	07.76	83.6383-0300.3	330371	2	L=300
	2.0 66		08.76	01.82				
	2.0 71		08.80	12.84				
	2.0 76		08.84	07.85				
	2.0 86	928357	08.83					
	2.0 100		10.82	08.84				
	2.1 71		08.74	07.75				
	2.1 74		08.75	07.80				
	2.1 79		08.80	07.84				
	2.1 80		08.80	07.84				
	2.1 90		08.74	07.79				
	2.1 T 114		08.80	07.85				
	2.3 81		08.84	07.86				
	2.3 82		08.80	07.84				
	2.3 83		08.86	07.87				
	2.3 85		08.86	12.88				
	2.3 96		08.84	07.85				
	2.3 98		08.84	12.88				
	2.3 100		01.83	12.84				
	2.3 i Katalysator 85	928357	08.86					



									
VOLVO 240 Kombi (74-93)									
	2.3 i Katalysator	100		08.91	07.92	83.6383-0300.3	330371	2	L=300
	2.4 D	58	928357	08.88					
	2.4 D	60	928357	04.79					
	2.7	104		08.79	07.80				
	2.8	95		10.81	09.82				
	2.8	114		10.80	09.82				
	2.0	86	928358		07.93	83.6124-0305.3	330723	2	L=305
	2.3 i Katalysator	85	928358		07.93				
	2.4 D	58	928358		08.93				
	2.4 D	60	928358		08.93				
	2.0	60		08.74	07.76	03.0137-0169.2	650169		160 x 25
	2.0	66		08.76	01.82	03.0137-9065.2	669065		Bremsbacken-Zubehör
	2.0	71		08.80	12.84				
	2.0	76		08.84	07.85				
	2.0	86		08.83	07.93				
	2.0	100		10.82	08.84				
	2.1	71		08.74	07.75				
	2.1	74		08.75	07.80				
	2.1	79		08.80	07.84				
	2.1	80		08.80	07.84				
	2.1	90		08.74	07.79				
	2.1 T	114		08.80	07.85				
	2.3	81		08.84	07.86				
	2.3	82		08.80	07.84				
	2.3	83		08.86	07.87				
	2.3	85		08.86	12.88				
	2.3	96		08.84	07.85				
	2.3	98		08.84	12.88				
	2.3	100		01.83	12.84				
	2.3 i Katalysator	85		08.86	07.93				
	2.3 i Katalysator	100		08.91	07.92				
	2.4 D	58		08.88	08.93				
	2.4 D	60		04.79	08.93				
	2.7	104		08.79	07.80				
	2.8	95		10.81	09.82				
	2.8	114		10.80	09.82				
	2.0	66		09.78	01.82	24.3727-1313.2	581313	2	L=1932
	2.0	71		08.80	12.84				
	2.0	76		08.84	07.85				
	2.0	86		08.83	07.93				
	2.0	100		10.82	08.84				
	2.1	74		09.78	07.80				
	2.1	79		08.80	07.84				
	2.1	80		08.80	07.84				
	2.1	90		09.78	07.79				
	2.1 T	114		08.80	07.85				
	2.3	81		08.84	07.86				
	2.3	82		08.80	07.84				
	2.3	83		08.86	07.87				
	2.3	85		08.86	12.88				
	2.3	96		08.84	07.85				
	2.3	98		08.84	12.88				
	2.3	100		01.83	12.84				
	2.3 i Katalysator	85		08.86	07.93				
	2.3 i Katalysator	100		08.91	07.92				
	2.4 D	58		08.88	08.93				
	2.4 D	60		04.79	08.93				
	2.7	104		08.79	07.80				
	2.8	95		10.81	09.82				
	2.8	114		10.80	09.82				
	2.4 D	58		08.88	08.93	24.3728-1301.2	591301		L=1100
	2.4 D	60		04.79	08.93				
VOLVO 260 Limousine (74-82)									
	2.7	92	046514	08.76	- (USA) / + 4 türig ¹⁾	03.2022-0111.3	010004		THz 22,30/15,75 - B. ATE
	2.7	103	046514	08.74	- (USA) / + 4 türig ¹⁾				
	2.7	92	046515	08.78	- (USA) / + 4 türig ¹⁾	03.2022-0112.3	010005		THz 22,30/15,75 ATE
	2.7	103	046515	08.78	- (USA) / + 4 türig ¹⁾				
	2.7	92		08.76	08.78 + (USA) / + 2 türig ²⁾	03.2022-0109.3	010003		THz 22,30/15,75 ATE
	2.7	92		08.76	08.78 + (USA) / + 4 türig ³⁾				
	2.7	103		08.74	08.78 + (USA) / + 2 türig ²⁾				
	2.7	103		08.74	08.78 + (USA) / + 4 türig ³⁾				
	2.7	92		09.78	07.82	03.2022-0111.3	010004		Auslaß seitlich links ⁴⁾
	2.7	103		09.78	07.80	03.2022-0112.3	010005		Auslaß seitlich rechts ⁵⁾
	2.7	109		08.78	07.82				
	2.8	95		08.80	07.82				
	2.8	114		08.80	07.82				
	2.7	92		08.76	07.82	13.0460-2953.2	602953		20200 16,0
	2.7	103		01.75	07.80	13.0460-0422.2	610422		Belagsatz-Zubehör
	2.7	109		08.78	07.82				
	2.8	95		08.80	07.82				
	2.8	114		08.80	07.82				

1) - (USA) / + 4 door / - (USA) / + 4 porte / - (USA) / + 4 portes / - (USA) / + 4 puertas
2) + (USA) / + 2 door / + (USA) / + 2 porte / + (USA) / + 2 portes / + (USA) / + 2 puertas
3) + (USA) / + 4 door / + (USA) / + 4 porte / + (USA) / + 4 portes / + (USA) / + 4 puertas
4) outlet lateral left hand / scarico laterale sinistro / sortie latérale gauche / salida lateral izquierda
5) outlet lateral right hand / scarico laterale destro / sortie latérale droite / salida lateral derecha



VOLVO 260 Limousine (74-82)





































	2.7	92		08.76	08.78	24.0114-0101.1	414101		263 14,3 12,7						
	2.7	103		08.74	08.78										
	2.7	92		09.78	07.82					24.0122-0127.1	422127		263 22,0 20,4 V		
	2.7	103		09.78	07.80										
	2.7	109		08.78	07.82										
2.8	95		08.80	07.82											
2.8	114		08.80	07.82											
	2.7	92		09.78	07.82	83.6204-0286.3	330733	4	L=285						
	2.7	103		09.78	07.80										
	2.7	109		08.78	07.82										
	2.8	95		08.80	07.82										
	2.8	114		08.80	07.82										
	2.7	92		08.76	07.82	13.2381-0039.2	210020	<input type="checkbox"/>	D=38	ATE					
	2.7	103		08.74	07.80										
	2.7	109		08.78	07.82						13.2381-0040.2	210021	<input type="checkbox"/>	D=38	ATE
	2.8	95		08.80	07.82										
	2.8	114		08.80	07.82										
2.8	95		08.80	07.82											
2.8	114		08.80	07.82											
	2.7	92		08.76	07.82	13.0460-2954.2	602954		20088 14,3	TRW					
	2.7	103		08.74	07.80										
	2.7	109		08.78	07.82						13.0460-0088.2	610088		Belagsatz-Zubehör	ATE
	2.8	95		08.80	07.82										
	2.8	114		08.80	07.82										
	2.7	92		08.76	07.82	24.0110-0189.1	410189		281 9,6 8,4 +B						
	2.7	103		08.74	07.80										
	2.7	109		08.78	07.82										
	2.8	95		08.80	07.82										
	2.8	114		08.80	07.82										
	2.7	92		08.76	07.82	83.6383-0300.3	330371	2	L=300						
	2.7	103		08.74	07.80										
	2.7	109		08.78	07.82										
	2.8	95		08.80	07.82										
	2.8	114		08.80	07.82										
	2.7	92		08.76	07.82	03.0137-0169.2	650169		160 x 25						
	2.7	103		08.74	07.80										
	2.7	109		08.78	07.82						03.0137-9065.2	669065		Bremsbacken-Zubehör	
	2.8	95		08.80	07.82										
	2.8	114		08.80	07.82										
	2.7	92		08.76	07.82	24.3727-1313.2	581313	2	L=1932						
	2.7	103		08.74	07.80										
	2.7	109		08.78	07.82										
	2.8	95		08.80	07.82										
	2.8	114		08.80	07.82										

VOLVO 260 Kombi (75-82)







	2.7	92		08.75	07.77	03.2022-0111.3	010004		THz 22,30/15,75 - B.	ATE					
	2.7	103	010919	07.75	- (USA)						03.2022-0112.3	010005		THz 22,30/15,75	ATE
	2.7	103	010920	08.78	- (USA)										
	2.7	103		07.75	08.78 + (USA)						03.2022-0109.3	010003		THz 22,30/15,75	ATE
	2.7	103		09.78	07.82						03.2022-0111.3	010004	Auslaß seitlich links ¹⁾	THz 22,30/15,75 - B.	ATE
2.7	109		10.78	07.82	03.2022-0112.3	010005	Auslaß seitlich rechts ²⁾	THz 22,30/15,75	ATE						
2.8	114		08.80	07.82											
	2.7	92		08.75	07.77	13.0460-2953.2	602953		20200 16,0	TRW					
	2.7	103		07.75	07.82										
	2.7	109		10.78	07.82						13.0460-0422.2	610422		Belagsatz-Zubehör	TRW
	2.8	114		08.80	07.82										
	2.8	114		08.80	07.82										
	2.7	92		08.75	07.77	24.0114-0101.1	414101		263 14,3 12,7						
	2.7	103		07.75	08.78										
	2.7	103		09.78	07.82					24.0122-0127.1	422127		263 22,0 20,4 V		
	2.7	109		10.78	07.82										
	2.8	114		08.80	07.82										
	2.7	103		09.78	07.82	83.6204-0286.3	330733	4	L=285						
	2.7	109		10.78	07.82										
	2.8	114		08.80	07.82										
		2.7	92		08.75					07.77	13.2381-0039.2	210020	<input type="checkbox"/>	D=38	ATE
		2.7	103		07.75					07.82					
2.7		109		10.78	07.82	13.2381-0040.2	210021	<input type="checkbox"/>	D=38	ATE					
2.8		114		08.80	07.82										
2.8		114		08.80	07.82										
2.8	114		08.80	07.82											
2.8	114		08.80	07.82											
	2.7	92		08.75	07.77	13.0460-2954.2	602954		20088 14,3	TRW					
	2.7	103		07.75	07.82										
	2.7	109		10.78	07.82						13.0460-0088.2	610088		Belagsatz-Zubehör	ATE
	2.8	114		08.80	07.82										
	2.8	114		08.80	07.82										
	2.7	92		08.75	07.77	24.0110-0189.1	410189		281 9,6 8,4 +B						
	2.7	103		07.75	07.82										
	2.7	109		10.78	07.82										
	2.8	114		08.80	07.82										
		2.7	92		08.75					07.77	83.6383-0300.3	330371	2	L=300	
2.7		103		07.75	07.82										
2.7		109		10.78	07.82										
2.8		114		08.80	07.82										
		2.7	92		08.75	07.77	03.0137-0169.2	650169		160 x 25					
	2.7	103		07.75	07.82										
	2.7	109		10.78	07.82	03.0137-9065.2					669065		Bremsbacken-Zubehör		
	2.8	114		08.80	07.82										
	2.8	114		08.80	07.82										

¹⁾ outlet lateral left hand / scarico laterale sinistro / sortie latérale gauche / salida lateral izquierda
²⁾ outlet lateral right hand / scarico laterale destro / sortie latérale droite / salida lateral derecha



									
VOLVO 260 Kombi (75-82)									
	2.7 2.7 2.8	103 109 114		09.78 10.78 08.80	07.82 07.82 07.82	24.3727-1313.2	581313	2	L=1932
VOLVO 260 Coupe (77-78)									
	2.7	103		08.77	07.78	03.2022-0109.3	010003		THz 22,30/15,75 ATE
	2.7	103		08.77	07.78	13.0460-2953.2 13.0460-0422.2	602953 610422		20200 16,0 Belagsatz-Zubehör TRW TRW
	2.7	103		08.77	07.78	24.0114-0101.1	414101		263 14,3 12,7
	2.7	103		08.77	07.78	13.2381-0039.2 13.2381-0040.2 13.0441-3812.2	210020 210021 250068	 	D=38 D=38 Dichtungssatz ATE ATE ATE
	2.7	103		08.77	07.78	13.0460-2954.2 13.0460-0088.2	602954 610088		20088 14,3 Belagsatz-Zubehör TRW ATE
	2.7	103		08.77	07.78	24.0110-0189.1	410189		281 9,6 8,4 +B
	2.7	103		08.77	07.78	83.6383-0300.3	330371	2	L=300
	2.7	103		08.77	07.78	03.0137-0169.2 03.0137-9065.2	650169 669065		160 x 25 Bremsbacken-Zubehör
	2.7	103		08.77	07.78	24.3727-1313.2	581313	2	L=1932
VOLVO 340 (76-90)									
	1.4 1.6 D 1.7			09.79 01.84 07.85	08.90 08.90 08.90	24.0113-0172.1	413172		239 12,8 11,4
	1.4 1.4 1.4 1.6 D 1.7	451743 451743	451742	02.76	08.79	83.6104-0241.3	330731	2	L=240
	1.4 1.6 D 1.7			02.76 01.84 07.85	08.90 08.90 08.90	24.5113-0280.3	330393	2	L=280
	1.4 1.6 D 1.7			02.76 01.84 07.85	08.90 08.90 08.90	83.6204-0240.3	330718	2	L=240
	1.4 1.6 D 1.7			02.76 01.84 07.85	08.90 08.90 08.90	24.3219-0903.3	020184		Rz 19,05
	1.4 1.6 D 1.7			02.76 01.84 07.85	08.90 08.90 08.90	03.0137-9173.2	669173		Bremsbacken-Zubehör
	1.4 1.4	121000	120999	02.76	+ Automatikgetriebe ¹⁾	03.6058-0501.3	320074		BR 25/5 (4) ATE
				08.90	+ Automatikgetriebe ¹⁾	03.6055-0303.3	320064		BR 25/5 (4) ATE
VOLVO 345 (80-89)									
	2.0			08.80	07.89	24.0113-0172.1	413172		239 12,8 11,4
	2.0			08.80	07.89	24.5113-0280.3	330393	2	L=280
	2.0			08.80	07.89	83.6204-0240.3	330718	2	L=240
	2.0			08.80	07.89	03.0137-0271.2 03.0137-9027.2	650271 669027		229 x 42 HEB Bremsbacken-Zubehör TRW TRW
VOLVO 360 (82-90)									
	2.0			08.82	07.90	24.0113-0172.1	413172		239 12,8 11,4
	2.0			08.82	07.90	24.5113-0280.3	330393	2	L=280
	2.0			08.82	07.90	83.6204-0240.3	330718	2	L=240
	2.0			08.82	07.90	03.0137-0271.2 03.0137-9027.2	650271 669027		229 x 42 HEB Bremsbacken-Zubehör TRW TRW

¹⁾ + autom.transmission / + scatola cambio automatico / + transmission automatique / + cambio automático

VOLVO 360 (82-90)		08.82		07.90		03.0137-0271.2 650271 03.0137-9027.2 669027		229 x 42 HEB Bremsbacken-Zubehör		TRW TRW					
VOLVO 440 (88-96)															
	1.6	61		09.92	12.96 + ABS	10.6120-0287.3	010334		THz 20,64	ATE					
	1.7	64		09.92	12.96 + ABS										
	1.7	75		09.92	12.96 + ABS										
	1.7	78		09.92	12.96 + ABS										
	1.7 T	88		09.92	07.96 + ABS										
	1.7 T	90		09.92	12.96 + ABS										
	1.8	66		09.92	12.96 + ABS										
	1.9 TD	66		07.94	12.96 + ABS										
	2.0	80		08.93	07.96 + ABS										
	2.0	81		09.92	07.95 + ABS										
	1.6	61 EKC 006387		12.96		24.0101-3601.2	260044		Bremsattel-Zubehör	TRW					
	1.7	64 EKC 006387		12.96											
	1.7	70 EKC 006387		07.89											
	1.7	75 EKC 006387		12.96											
	1.7	78 EKC 006387		12.96											
	1.8	66	08.91	12.96											
	1.9 TD	66	07.94	12.96											
	2.0	80 EKC 006387		07.96											
	1.7 T	88	08.88	07.96	11.9541-9806.2						220504	2		D=54, - Halter Haltefeder Führungsbolzen Hülzensatz	ATE ATE ATE ATE
	1.7 T	90	01.91	12.96	11.8116-0073.1						390498				
2.0	80	08.93	07.96	11.8171-0008.1	990049										
2.0	81	08.92	07.95	11.0101-5407.2	260011										
	1.6	61	EKC 006386	09.88		13.0460-2846.2	602846		21010 15,8 /S	TRW					
	1.7	64	EKC 006386	09.88											
	1.7	70	EKC 006386	08.88											
	1.7	75	EKC 006386	08.89											
	1.7	78	EKC 006386	09.88											
	1.6	61 EKC 006387		12.96	13.0460-2812.2						602812		21217 18,0 /S	TRW	
	1.7	64 EKC 006387		12.96											
	1.7	70 EKC 006387		07.89											
	1.7	75 EKC 006387		12.96											
	1.7	78 EKC 006387		12.96											
1.8	66	08.91	12.96												
1.9 TD	66	07.94	12.96												
2.0	80 EKC 006387		07.96												
1.7 T	88	08.88	07.96	13.0460-7146.2	607146	20147 17,0 +	ATE								
1.7 T	90	01.91	12.96												
2.0	80	08.93	07.96												
2.0	81	08.92	07.95												
	1.6	61		09.88	12.96	24.0112-0135.1	412135		260 12,0 10,8						
	1.7	64		09.88	12.96										
	1.7	70		08.88	07.89										
	1.7	75		08.89	12.96										
	1.7	78		09.88	12.96										
	1.8	66		08.91	12.96										
	1.9 TD	66		07.94	12.96										
	2.0	80 EKC 006387		07.96											
	1.7 T	88		08.88	07.96						24.0122-0164.1	422164	256 22,0 20,0 V		
	1.7 T	90		01.91	12.96										
2.0	80		08.93	07.96											
2.0	81		08.92	07.95											
	1.6	61		09.88	12.96	24.5170-0465.3	331331	2	L=465						
	1.7	64		09.88	12.96										
	1.7	70		08.88	07.89										
	1.7	75		08.89	12.96										
	1.7	78		09.88	12.96										
	1.7 T	88		08.88	07.96										
	1.7 T	90		01.91	12.96										
	1.8	66		08.91	12.96										
	1.9 TD	66		07.94	12.96										
	2.0	80		08.93	07.96										
2.0	81		08.92	07.95											
	1.6	61		09.88	12.96	11.0101-5402.2	260009		Hülzensatz Führungsbolzen	ATE ATE					
	1.7	75		08.89	12.96										
	1.7	78		09.88	12.96										
	1.7 T	88		08.88	07.96										
	1.7 T	90		01.91	12.96										
	1.8	66		08.91	12.96										
	1.9 TD	66		07.94	12.96										
	2.0	81		08.92	07.95										
	1.6	61		09.88	12.96						13.0460-3306.2	603306		21089 15,0 +	ATE
	1.7	75		08.89	12.96										
1.7	78		09.88	12.96											
1.7 T	88		08.88	07.96											
1.7 T	90		01.91	12.96											
1.8	66		08.91	12.96											
1.9 TD	66		07.94	12.96											
2.0	81		08.92	07.95											



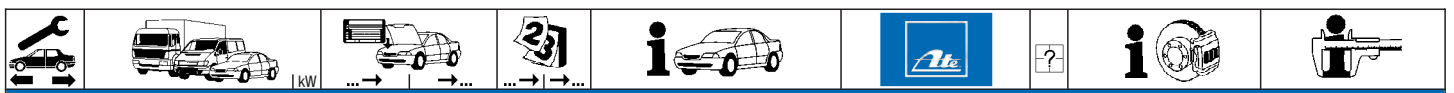

VOLVO 440 (88-96)										
	1.7 T	88	EMC 165501		07.96	+ HA-Scheibenbremse ¹⁾	24.3727-1309.2	581309	2	L=1428
	1.7 T	90	EMC 165501		12.96	+ HA-Scheibenbremse ¹⁾				
	1.8	66		08.91	12.96	+ HA-Scheibenbremse ¹⁾				
	1.9 TD	66		07.94	12.96	+ HA-Scheibenbremse ¹⁾				
	2.0	81		08.92	07.95	+ HA-Scheibenbremse ¹⁾				
	1.6	61		09.88	08.92	- ABS	03.0101-0014.2	320004		BRES 3/25 ATE
	1.7	64		09.88	08.92	- ABS				
	1.7	70		08.88	07.89	- ABS				
	1.7	75		08.89	08.92	- ABS				
	1.7	78		09.88	08.92	- ABS				
	1.7 T	88		08.88	08.92	- ABS				
	1.7 T	90		01.91	08.92	- ABS				
	1.8	66		08.91	08.92	- ABS				
	1.6	61		09.88	12.96		24.3728-1303.2	591303		L=782
	1.7	75	EMC 185081		12.96					
	1.7 T	88	EMC 185081		07.96					
	1.7 T	90		01.91	12.96					
	1.8	66		08.91	12.96					
	2.0	80		08.93	07.96					
	2.0	81		08.92	07.95					

VOLVO 460 (88-96)										
	1.6	61		09.92	07.96	+ ABS	10.6120-0287.3	010334		THz 20,64 ATE
	1.7	64		09.92	07.96	+ ABS				
	1.7	66		09.92	07.96	+ ABS				
	1.7 T	88		09.92	07.96	+ ABS				
	1.7 T	90		09.92	07.96	+ ABS				
	1.8	66		09.92	07.96	+ ABS				
	1.9 TD	66		07.94	07.96	+ ABS				
	2.0	80		08.93	07.96	+ ABS				
	2.0	81		09.92	07.95	+ ABS				
	1.6	61		07.92	07.96		24.0101-3601.2	260044		Bremssattel-Zubehör TRW
	1.7	64	EKC 006387		07.96					
	1.7	66	EKC 006387		07.96					
	1.7	75	EKC 006387		07.92					
	1.7	80	EKC 006387		07.92					
	1.8	66		08.91	07.96					
	1.9 TD	66		07.94	07.96					
	2.0	80	EKC 006387		07.96					
	2.0	81		08.92	07.95					
	1.7 T	88		08.89	07.96		11.9541-9806.2	220504	2	D=54, - Halter ATE
	1.7 T	90		01.91	07.96		11.8116-0073.1	390498		Haltefeder ATE
	2.0	80		08.93	07.96		11.8171-0008.1	990049		Führungsbolzen ATE
	2.0	81		08.92	07.95		11.0101-5407.2	260011		Hülzensatz ATE
	1.7	64	EKC 006386	09.88			13.0460-2846.2	602846		21010 15,8 / S TRW
	1.7	66	EKC 006386	09.90						
	1.7	75	EKC 006386	08.89						
	1.7	80	EKC 006386	08.89						
	1.6	61		07.92	07.96		13.0460-2812.2	602812		21217 18,0 / S TRW
	1.7	64	EKC 006387		07.96					
	1.7	66	EKC 006387		07.96					
	1.7	75	EKC 006387		07.92					
	1.7	80	EKC 006387		07.92					
	1.8	66		08.91	07.96					
	1.9 TD	66		07.94	07.96					
	2.0	80	EKC 006387		07.96					
	2.0	81		08.92	07.95					
	1.7 T	88		08.89	07.96		13.0460-7146.2	607146		20147 17,0 + ATE
	1.7 T	90		01.91	07.96					
	2.0	80		08.93	07.96					
	2.0	81		08.92	07.95					
	1.6	61		07.92	07.96		24.0112-0135.1	412135		nur für TRW-Sättel 260 12,0 10,8
	1.7	64		09.88	07.96					
	1.7	66		09.90	07.96					
	1.7	75		08.89	07.92					
	1.7	80		08.89	07.92					
	1.8	66		08.91	07.96					
	1.9 TD	66		07.94	07.96					
	2.0	80	EKC 006387		07.96					
	2.0	81		08.92	07.95					
	1.7 T	88		08.89	07.96		24.0122-0164.1	422164		nur für ATE-Sättel ²⁾ 256 22,0 20,0 V
	1.7 T	90		01.91	07.96					
	2.0	80		08.93	07.96					
	2.0	81		08.92	07.95					
	1.6	61		07.92	07.96		24.5170-0465.3	331331	2	L=465
	1.7	64		09.88	07.96					
	1.7	66		09.90	07.96					
	1.7	75		08.89	07.92					
	1.7	80		08.89	07.92					
	1.7 T	88		08.89	07.96					
	1.7 T	90		01.91	07.96					
	1.8	66		08.91	07.96					
	1.9 TD	66		07.94	07.96					
	2.0	80		08.93	07.96					
	2.0	81		08.92	07.95					

¹⁾ + RA disc brake / + P disco freno / + frein à disque essieu AR / + ET-disco de freno
²⁾ only for ATE callipers / solo per pinze ATE / seules pour étriers ATE / solo para pinzas ATE



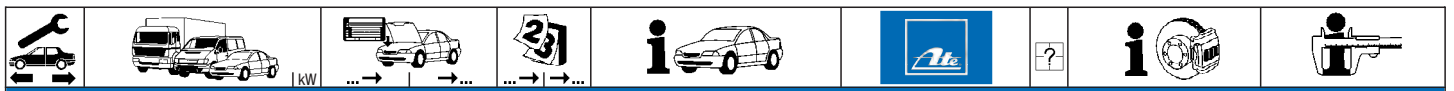

VOLVO 460 (88-96)

	1.7 1.7 1.7 T 1.7 T 1.8 1.9 TD 2.0	75 80 88 90 66 66 81		08.89 08.89 08.89 01.91 08.91 07.94 08.92	07.92 07.92 07.96 07.96 07.96 07.96 07.95	11.0101-5402.2 11.8171-0008.1	260009 990049		Hülsensatz Führungsbolzen	ATE ATE	
	1.7 1.7 1.7 T 1.7 T 1.8 1.9 TD 2.0	75 80 88 90 66 66 81		08.89 08.89 08.89 01.91 08.91 07.94 08.92	07.92 07.92 07.96 07.96 07.96 07.96 07.95	13.0460-3306.2	603306		21089 15,0 +	ATE	
	1.7 1.7 1.7 T 1.7 T 1.8 1.9 TD 2.0	75 80 88 90 66 66 81		08.89 08.89 08.89 01.91 08.91 07.94 08.92	07.92 07.92 07.96 07.96 07.96 07.96 07.95	24.0109-0125.1	409125		228 9,0 8,0		
	1.6 1.7 1.7 1.7 1.7 1.7 1.8 1.9 TD 2.0	61 64 66 75 80 66 66 80		07.92 09.88 09.90 08.89 08.89 08.91 07.94 08.93	07.96 07.96 07.96 07.92 07.92 07.96 07.96 07.96	- ABS - ABS - ABS - ABS/ + HA-Trommelbremse 1) - ABS/ + HA-Trommelbremse 1) - ABS/ + HA-Trommelbremse 1) - ABS/ + HA-Trommelbremse 1) - ABS	83.6104-0336.3	330451	2	L=335	
	1.6 1.7 1.7 1.7 1.7 1.7 1.7 1.8 1.8 1.9 TD	61 64 66 75 75 80 80 66 66 66		07.92 09.88 09.90 08.89 08.89 08.89 08.91 08.91 07.94	08.92 08.92 08.92 07.92 07.92 07.92 07.96 08.92 07.96	+ ABS + ABS + ABS - ABS/ + HA-Scheibenbremse 2) + ABS - ABS/ + HA-Scheibenbremse 2) + ABS - ABS/ + HA-Scheibenbremse 2) + ABS - ABS/ + HA-Scheibenbremse 2)	83.6104-0295.3	330244	2	L=295	
	1.6 1.7 1.7 1.7 T 1.7 T 1.8 1.9 TD 2.0 2.0	61 64 66 88 90 66 66 80 81		09.92 09.92 09.92 08.92 09.92 07.94 08.93 09.92	07.96 07.96 07.96 07.96 07.96 07.96 07.96 07.95	+ ABS + ABS + ABS + ABS + ABS + ABS + ABS	83.6124-0285.3	330722	2	L=285	
	1.6 1.7 1.7 1.7 1.7 1.7 T 1.7 T 1.8 1.9 TD 2.0 2.0	61 64 66 75 80 88 90 66 66 80 81		07.92 09.88 09.90 08.89 08.89 08.89 08.91 07.94 08.93 08.92	07.96 07.96 07.96 07.92 07.92 07.96 07.96 07.96 07.96 07.95		24.0721-1915.3 24.0721-1916.3	360149 360150	<input type="checkbox"/> <input type="checkbox"/>	Radsensor L=847 Radsensor L=847	
	1.6 1.7 1.7 1.7 1.7 1.8 1.9 TD 2.0	61 64 66 75 80 66 66 80		07.92 09.88 09.90 08.89 08.89 08.91 07.94 08.93	07.96 07.96 07.96 07.92 07.92 07.96 07.96 07.96		24.3220-1113.3	020224	<input type="checkbox"/>	Rz 20,64	
	1.6 1.7 1.7 1.7 1.7 1.8 1.9 TD 2.0	61 64 66 75 80 66 66 80		07.92 09.88 09.90 08.89 08.89 08.91 07.94 08.93	07.96 07.96 07.96 07.92 07.92 07.96 07.96 07.96		03.0137-0258.2 03.0137-9158.2	650258 669158		203 x 38 HEB Bremsbacken-Zubehör	TRW TRW
	1.6 1.7 1.7 1.7 1.8 1.9 TD 2.0	61 64 66 75 80 66 80		07.92 09.88 09.90 08.89 08.89 08.91 07.94 08.93	07.96 07.96 07.96 07.92 07.92 07.96 07.96 07.96		24.0220-3015.1	480091		203/204,5 x 46,5	

1) - ABS/ + RA drum brake / - ABS/ + P freno a tamburo / - ABS/ + fr. à tambour essieu AR / - ABS/ + ET tambores de freno

2) - ABS/ + RA disc brake / - ABS/ + P disco freno / - ABS/ + fr. à disque essieu AR / - ABS/ + ET disco de freno

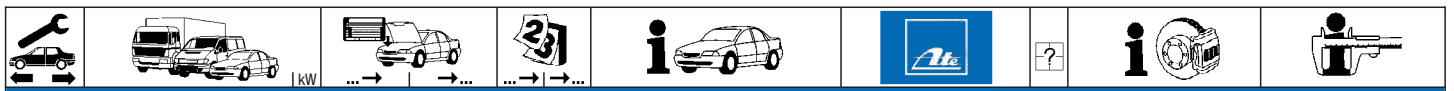

VOLVO 460 (88-96)

	1.7	64	ELC 165500	09.88		24.3727-1307.2	581307	2		L=1365
	1.7	66	ELC 165500	09.90						
	1.7	75	ELC 165500	08.89	+ HA-Trommelbremse 1)					
	1.7	80	ELC 165500	08.89	+ HA-Trommelbremse 1)					
	1.6	61		07.92	07.96	24.3727-1310.2	581310	2		L=1338
	1.7	64 ELC 165501		07.96	07.96					
	1.7	66 ELC 165501		07.96	07.96					
	1.7	75 ELC 165501		07.92	+ HA-Trommelbremse 1)					
	1.7	80 ELC 165501		07.92	+ HA-Trommelbremse 1)					
	1.8	66		08.91	07.96 + HA-Trommelbremse 1)					
1.9 TD	66		07.94	07.96 + HA-Trommelbremse 1)						
2.0	80		08.93	07.96						
	1.7	75 ELC 165501		07.92	+ HA-Scheibenbremse 2)	24.3727-1309.2	581309	2		L=1428
	1.7	80 ELC 165501		07.92	+ HA-Scheibenbremse 2)					
	1.7 T	88 ELC 165501		07.96	07.96					
	1.7 T	90		01.91	07.96					
	1.8	66		08.91	07.96 + HA-Scheibenbremse 2)					
	1.9 TD	66		07.94	07.96 + HA-Scheibenbremse 2)					
	2.0	81		08.92	07.95					
	2.0	81		08.92	07.95					
	1.6	61		07.92	08.92 - ABS	03.0101-0014.2	320004			BRES 3/25 ATE
	1.7	64		09.88	08.92 - ABS					
	1.7	66		09.90	08.92 - ABS					
	1.7	75		08.89	07.92 - ABS					
	1.7	80		08.89	07.92 - ABS					
	1.7 T	88		08.89	08.92 - ABS					
	1.7 T	90		01.91	08.92 - ABS					
	1.8	66		08.91	08.92 - ABS					
	2.0	80		08.93	07.96					
	2.0	81		08.92	07.95					
	1.6	61		07.92	07.96	24.3728-1303.2	591303			L=782
	1.7	64 EMC 185081		07.96	07.96					
	1.7	66 EMC 185081		07.96	07.96					
	1.7	75 EMC 185081		07.92	07.92					
	1.7	80 EMC 185081		07.92	07.92					
	1.7 T	88 EMC 185081		07.96	07.96					
	1.7 T	90		01.91	07.96					
	1.8	66		08.91	07.96					
	2.0	80		08.93	07.96					
	2.0	81		08.92	07.95					

VOLVO 480 (86-96)

	1.7	75		09.92	07.96 + ABS	10.6120-0287.3	010334			Thz 20,64 ATE
	1.7 T	88		09.92	07.96 + ABS					
	1.7 T	90		09.92	07.96 + ABS					
	2.0	81		09.92	09.95 + ABS					
	1.7	70 EKC 538520		08.89	07.89	24.0101-3601.2	260044			Bremssattel-Zubehör TRW
	1.7	75		08.89	07.96					
	1.7	78 EKC 538520		08.89	07.89					
	1.7 T	88		08.87	07.96	11.9541-9806.2	220504	2		D=54, - Halter ATE
	1.7 T	90		01.91	07.96	11.8116-0073.1	390498			Haltefeder ATE
	2.0	81		08.92	09.95	11.8171-0008.1	990049			Führungsbolzen ATE
	1.7	70	EKC 538519	08.87	07.89	13.0460-2846.2	602846			Hülzensatz ATE
	1.7	78	EKC 538519	04.86	07.88					
	1.7	80		08.86	07.88					
	1.7	70 EKC 538520		08.89	07.89	13.0460-2812.2	602812			21217 18,0 /S TRW
	1.7	75		08.89	07.96					
	1.7	78 EKC 538520		08.89	07.89					
	1.7 T	88		08.87	07.96	13.0460-7146.2	607146			20147 17,0 + ATE
	1.7 T	90		01.91	07.96					
	2.0	81		08.92	09.95					
	1.7	70		08.87	07.89	24.0112-0135.1	412135			260 12,0 10,8
	1.7	75		08.89	07.96					
	1.7	78		04.86	07.89					
	1.7	80		08.86	07.88					
	1.7 T	88		08.87	07.96	24.0112-0135.1	412135			260 12,0 10,8
	1.7 T	90		01.91	07.96	24.0122-0164.1	422164			256 22,0 20,0 V
	2.0	81		08.92	09.95	24.0122-0164.1	422164			256 22,0 20,0 V
	1.7	70		08.87	07.89	24.5170-0465.3	331331	2		L=465
	1.7	75		08.89	07.96					
	1.7	78		09.86	07.89					
	1.7	80		08.86	07.88					
	1.7 T	88		08.86	07.96					
	1.7 T	90		01.91	07.96					
	2.0	81		08.92	09.95					
	1.7	70		08.87	07.89	11.0101-5402.2	260009			Hülzensatz ATE
	1.7	75		08.89	07.96	11.8171-0008.1	990049			Führungsbolzen ATE
	1.7	78		04.86	07.89					
1.7	80		08.86	07.88						
1.7 T	88		08.87	07.96						
1.7 T	90		01.91	07.96						
2.0	81		08.92	09.95						

1) + RA drum brake / + P freno a tamburo / + frein à tambour essieu AR / + ET-tambores de freno
 2) + RA disc brake / + P disco freno / + frein à disque essieu AR / + ET-disco de freno



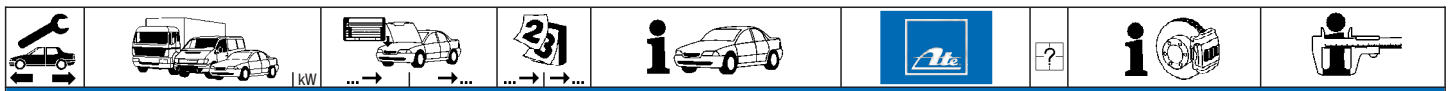

VOLVO 480 (86-96)										
	1.7 1.7 1.7 1.7 1.7 T 1.7 T 2.0	70 75 78 80 88 90 81		08.87 08.89 04.86 08.86 08.87 01.91 08.92	07.89 07.96 07.89 07.88 07.96 07.96 09.95		13.0460-3306.2	603306		21089 15,0 + ATE
	1.7 1.7 1.7 1.7 1.7 T 1.7 T 2.0	70 75 78 80 88 90 81		08.87 08.89 04.86 08.86 08.87 01.91 08.92	07.89 07.96 07.89 07.88 07.96 07.96 09.95		24.0109-0125.1	409125		228 9,0 8,0
	1.7 1.7 1.7 1.7 1.7 1.7 T 1.7 T 1.7 T 2.0	70 70 75 78 80 80 88 88 90 81	EJC 522771 EJC 522771 EJC 522771 EJC 522771	08.87 08.87 08.89 04.86 08.86 08.86 08.87 08.87 01.91 08.92	- ABS + ABS + ABS - ABS + ABS - ABS + ABS - ABS + ABS + ABS		83.6124-0285.3	330722	2	L=285
	1.7 1.7 1.7 1.7 1.7 T 1.7 T 2.0	70 75 78 80 88 90 81	EJC 522772 EJC 522772 EJC 522772 EJC 522772	08.89 08.89 07.89 07.88 07.96 01.91 08.92	- ABS - ABS - ABS - ABS - ABS - ABS - ABS		83.6104-0295.3	330244	2	L=295
	1.7 1.7 1.7 1.7 1.7 T 1.7 T 2.0	70 75 78 80 88 90 81		08.87 08.89 04.86 08.86 08.87 01.91 08.92	07.89 07.96 07.89 07.88 07.96 07.96 09.95		24.0721-1915.3 24.0721-1916.3	360149 360150	<input type="checkbox"/> <input type="checkbox"/>	Radsensor L=847 Radsensor L=847
	1.7 1.7 T 1.7 T 2.0	75 88 90 81		09.90 09.90 01.91 08.92	07.96 07.96 07.96 09.95		24.3727-1309.2	581309	2	L=1428
	1.7 1.7 1.7 1.7 1.7 T 1.7 T	70 75 78 80 88 90		08.87 08.89 04.86 08.86 08.87 01.91	08.92 - ABS 08.92 - ABS 07.89 - ABS 07.88 - ABS 08.92 - ABS 08.92 - ABS		03.0101-0014.2	320004		BRES 3/25 ATE
	1.7 1.7 T 1.7 T 2.0	75 88 90 81	EMC 565117 EMC 565117	07.96 07.96 01.91 08.92			24.3728-1303.2	591303		L=782

VOLVO 740 Limousine (83-92)										
	2.0 2.0 2.0 2.3 2.3 2.3 2.3 2.3 2.3 2.3 2.3 T 2.3 T 2.3 T 2.4 D 2.4 TD	76 294100 89 294100 118 294100 83 294100 84 294100 85 294100 100 294100 111 294100 114 294100 117 294100 115 294100 121 140 60 294100 83 294100		08.90 08.91 08.90 12.89 07.90 08.91 07.90 08.91 07.91 07.89 07.89 08.89 08.89 08.91 07.90	- ABS - ABS - ABS - ABS - ABS - ABS - ABS - ABS - ABS - ABS - ABS - ABS - ABS - ABS - ABS		03.2023-0503.3 03.3517-5100.1	010022 390326		THz 23,81/16,84 + B. ATE Verschlußschraube ATE
	2.0 2.0 2.0 2.3 2.3 2.3 2.3 2.3 2.3 2.3 T 2.3 T 2.3 T 2.4 D 2.4 TD	76 89 118 83 84 85 100 111 114 117 115 121 134 140 60 83		09.88 08.91 09.87 09.87 09.87 09.87 08.88 08.88 08.88 08.89 08.89 08.89 09.87 09.87 09.87 09.87	+ ABS + ABS + ABS + ABS + ABS + ABS + ABS + ABS + ABS + ABS + ABS + ABS + ABS + ABS + ABS + ABS		03.2023-0164.3	010014		THz 23,81/19,05 + B. ATE



VOLVO 740 Limousine (83-92)

	2.0	89	09.91	07.92	03.2023-0875.3	010890		THz 23,81/20,64 - B.	ATE
	2.3	85	09.91	07.92					
	2.3	111	09.91	07.92					
	2.4 D	60	09.91	07.92					
	2.0	76	09.88	08.90	24.0101-3401.2	260043		Bremssattel-Zubehör	TRW
	2.0	86	01.87	08.88					
	2.0	89	08.85	08.90					
	2.0	110	12.83	07.84					
	2.0	118	01.86	08.90					
	2.0	120	01.85	12.85					
	2.3	82	08.84	07.86					
	2.3	83	09.85	12.89					
	2.3	84	08.84	07.90					
	2.3	85	08.87	08.90					
	2.3	86	08.86	07.88					
	2.3	95	08.83	07.84					
	2.3	96	08.84	07.88					
	2.3	100	08.88	07.90					
	2.3	111	08.88	08.90					
	2.3	114	08.88	08.90					
	2.3	117	08.87	07.89					
	2.3 T	115	08.86	07.89					
	2.3 T	121	08.89	07.90					
	2.3 T	134	08.85	12.88					
	2.3 T	140	08.89	07.90					
	2.4 D	60	08.84	08.90					
	2.4 TD	80	08.85	07.87					
	2.4 TD	83	08.84	07.90					
	2.4 TD	90	08.86	10.88					
	2.0	86	09.87	08.88	24.0101-3401.2	260043		Bremssattel-Zubehör	TRW
	2.0	89	09.87	08.90					
	2.0	118	09.87	08.90					
	2.3	83	09.87	12.89					
	2.3	84	09.87	07.90					
	2.3	85	09.87	08.90					
	2.3	86	09.87	07.88					
	2.3	96	09.87	07.88					
	2.3	100	08.88	07.90					
	2.3	111	08.88	08.90					
	2.3	114	08.88	08.90					
	2.3	117	09.87	07.89					
	2.3 T	115	09.87	07.89					
	2.3 T	121	08.89	07.90					
	2.3 T	134	09.87	12.88					
	2.3 T	140	08.89	07.90					
	2.4 D	60	08.84	08.90					
	2.4 TD	83	08.84	07.90					
	2.4 TD	90	08.86	10.88					
	2.0	89	09.90	07.92	24.3571-1707.5	240079		D=57, - Halter	TRW
	2.3	85	09.90	07.92	24.3571-1708.5	240080		D=57, - Halter	TRW
	2.3	111	09.90	07.92	24.0101-3601.2	260044		Bremssattel-Zubehör	TRW
	2.3	114	09.90	07.91					
	2.4 D	60	09.90	07.92					
	2.0	76	09.88	08.90	13.0460-3914.2	603914		21233 16,7	BDX
	2.0	86	01.87	08.88	13.0460-2943.2	602943		21266 17,0 /S	TRW
	2.0	89	08.85	08.90	13.0460-0429.2	610429		Belagsatz-Zubehör	BDX
	2.0	89	09.90	07.92					
	2.0	110	12.83	07.84					
	2.0	118	01.86	08.90					
	2.0	120	01.85	12.85					
	2.3	82	08.84	07.86					
	2.3	83	09.85	12.89					
	2.3	84	08.84	07.90					
	2.3	85	08.87	08.90					
	2.3	85	09.90	07.92					
	2.3	86	08.86	07.88					
	2.3	95	08.83	07.84					
	2.3	96	08.84	07.88					
	2.3	100	08.88	07.90					
	2.3	111	08.88	08.90					
	2.3	111	09.90	07.92					
	2.3	114	08.88	08.90					
	2.3	114	09.90	07.91					
	2.3	117	08.87	07.89					
	2.3 T	115	08.86	07.89					
	2.3 T	121	08.89	07.90					
	2.3 T	134	08.85	12.88					
	2.3 T	140	08.89	07.90					
	2.4 D	60	08.84	08.90					
	2.4 D	60	09.90	07.92					
	2.4 TD	80	08.85	07.87					
	2.4 TD	83	08.84	07.90					
	2.4 TD	90	08.86	10.88					
	2.0	89	09.90	07.92	13.0460-2985.2	602985		20164 18,2	TRW
	2.3	85	09.90	07.92					
	2.3	111	09.90	07.92					
	2.3	114	09.90	07.91					





VOLVO 740 Limousine (83-92)

	2.4 D	60		09.90	07.92 + ABS	13.0460-2985.2	602985		20164 18,2	TRW
	2.0	86		01.87	07.87	24.0122-0217.2	422217	+ 14" Rad ¹⁾	263 22,0 20,0 V	
	2.0	89		08.85	07.87					
	2.0	110		12.83	07.84					
	2.0	118		01.86	07.87					
	2.0	120		01.85	12.85					
	2.3	82		08.84	07.86					
	2.3	83		09.85	07.87					
	2.3	84		08.84	07.87					
	2.3	86		08.86	07.87					
	2.3	95		08.83	07.84					
	2.3	96		08.84	07.87					
	2.3 T	115		08.86	07.87					
	2.3 T	134		08.85	07.87					
	2.4 D	60		08.84	07.87					
	2.4 TD	80		08.85	07.87					
	2.4 TD	83		08.84	07.87					
	2.4 TD	90		08.86	07.87					
	2.0	76		09.88	08.90	24.0122-0138.1	422138	+ 14" Rad ¹⁾	263 22,0 20,0 V	
	2.0	86		08.87	08.88	24.0122-0137.1	422137	+ 15" Rad ²⁾	287 22,0 20,0 V	
	2.0	89		08.87	08.90					
	2.0	118		08.87	08.90					
	2.3	83		08.87	12.89					
	2.3	84		08.87	07.90					
	2.3	85		08.87	08.90					
	2.3	86		08.87	07.88					
	2.3	96		08.87	07.88					
	2.3	100		08.88	07.90					
	2.3	111		08.88	08.90					
	2.3	114		08.88	08.90					
	2.3	117		08.87	07.89					
	2.3 T	115		08.86	07.89					
	2.3 T	121		08.89	07.90					
	2.3 T	134		08.87	12.88					
	2.3 T	140		08.89	07.90					
	2.4 D	60		08.87	08.90					
	2.4 TD	80		08.85	07.87					
	2.4 TD	83		08.87	07.90					
	2.4 TD	90		08.87	10.88					
	2.0	89		09.90	07.92 - ABS	24.0122-0137.1	422137		287 22,0 20,0 V	
	2.3	85		09.90	07.92 - ABS					
	2.3	111		09.90	07.92 - ABS					
	2.3	114		09.90	07.91 - ABS					
	2.4 D	60		09.90	07.92 - ABS					
	2.0	89		09.90	07.92 + ABS	24.0126-0105.1	426105		280 26,0 23,0 V +B	
	2.3	85		09.90	07.92 + ABS					
	2.3	111		09.90	07.92 + ABS					
	2.3	114		09.90	07.91 + ABS					
	2.4 D	60		09.90	07.92 + ABS					
	2.0	76		09.88	08.90 - ABS	83.6134-0335.3	330277	4	L=335	
	2.0	86		01.87	08.88 - ABS					
	2.0	89		08.85	08.90 - ABS					
	2.0	110		12.83	07.84					
	2.0	118		01.86	08.90 - ABS					
	2.0	120		01.85	12.85					
	2.3	82		08.84	07.86					
	2.3	83		09.85	12.89 - ABS					
	2.3	84		08.84	07.90 - ABS					
	2.3	85		08.87	07.92 - ABS					
	2.3	86		08.86	07.88 - ABS					
	2.3	95		08.83	07.84					
	2.3	96		08.84	07.88 - ABS					
	2.3	100		08.88	07.90 - ABS					
	2.3	111		08.88	07.92 - ABS					
	2.3	114		08.88	07.91 - ABS					
	2.3	117		08.87	07.89 - ABS					
	2.3 T	115		08.86	07.89 - ABS					
	2.3 T	121		08.89	07.90 - ABS					
	2.3 T	134		08.85	12.88 - ABS					
	2.3 T	140		08.89	07.90 - ABS					
	2.4 D	60		08.84	07.92 - ABS					
	2.4 TD	80		08.85	07.87					
	2.4 TD	83		08.84	07.90 - ABS					
	2.4 TD	90		08.86	10.88 - ABS					
	2.0	76		09.88	08.90 + ABS	83.6134-0335.3	330277	2	L=335	
	2.0	86		01.87	08.88 + ABS					
	2.0	89		08.85	08.90 + ABS					
	2.0	118		01.86	08.90 + ABS					
	2.3	83		09.85	12.89 + ABS					
	2.3	84		08.84	07.90 + ABS					
	2.3	85		08.87	07.92 + ABS					
	2.3	86		08.86	07.88 + ABS					
	2.3	96		08.84	07.88 + ABS					
	2.3	100		08.88	07.90 + ABS					

1) + 14" wheel / + ruota 14" / + roue 14" / + rueda 14"
 2) + 15" wheel / + ruota 15" / + roue 15" / + rueda 15"

VOLVO 740 Limousine (83-92)

	2.3 2.3 2.3 2.3 T 2.3 T 2.3 T 2.3 T 2.4 D 2.4 TD 2.4 TD	111 114 117 115 121 134 140 60 83 90		08.88 07.92 + ABS 08.88 07.91 + ABS 08.87 07.89 + ABS 08.86 07.89 + ABS 08.89 07.90 + ABS 08.85 12.88 + ABS 08.89 07.90 + ABS 08.84 07.92 + ABS 08.84 07.90 + ABS 08.86 10.88 + ABS	83.6134-0335.3 330277	2			L=335	
	2.0 2.0 2.0 2.0 2.0 2.3 2.3 2.3 2.3 2.3 T 2.3 T 2.4 D 2.4 TD 2.4 TD	86 89 110 118 120 82 83 84 86 95 96 115 134 60 80 83 90		01.87 07.87 08.85 07.87 12.83 07.84 01.86 07.87 01.85 12.85 08.84 07.86 09.85 07.87 08.84 07.87 08.86 07.87 08.83 07.84 08.84 07.87 08.86 07.87 08.85 07.87 08.84 07.87 08.85 07.87 08.84 07.87	24.9236-0001.5 24.9236-0002.5 24.9238-0087.5 24.9238-0088.5 13.2401-0028.2 13.0441-3815.2 13.0441-3819.2 13.0441-4014.2	230005 230006 230035 230036 210046 250069 250072 250079	 	für Vorg. 13.2381-0067/-0068.2 ¹⁾ D=38 für Vorg. 13.2401-0023/-0024.2 ²⁾	D=36 D=36 D=38 D=38 D=40 Dichtungssatz Dichtungssatz Dichtungssatz	ATE ATE ATE ATE ATE ATE ATE ATE
	2.0 2.0 2.0 2.0 2.0 2.3 2.3 2.3 2.3 2.3 2.3 2.3 2.3 2.3 2.3 T 2.3 T 2.3 T 2.3 T 2.4 D 2.4 D 2.4 TD 2.4 TD 2.4 TD	76 86 89 89 89 118 83 84 85 85 86 96 100 111 111 111 114 114 117 115 121 134 140 60 60 80 83 90		09.88 08.90 + Starrachse ³⁾ 08.87 08.88 + Starrachse ³⁾ 08.87 08.90 + Starrachse ³⁾ 09.90 07.92 08.87 08.90 + Starrachse ³⁾ 08.87 12.89 + Starrachse ³⁾ 08.87 07.90 + Starrachse ³⁾ 08.87 08.90 + Starrachse ³⁾ 09.90 07.92 08.87 07.88 + Starrachse ³⁾ 08.87 07.88 + Starrachse ³⁾ 08.88 07.90 + Starrachse ³⁾ 08.88 08.90 + Starrachse ³⁾ 09.90 07.92 08.87 07.89 + Starrachse ³⁾ 08.86 07.89 + Starrachse ³⁾ 08.89 07.90 + Starrachse ³⁾ 08.87 12.88 + Starrachse ³⁾ 08.89 07.90 + Starrachse ³⁾ 08.87 08.90 + Starrachse ³⁾ 09.90 07.92 08.86 07.88 + Starrachse ³⁾ 08.83 07.84 08.84 07.88 + Starrachse ³⁾ 08.88 07.90 + Starrachse ³⁾ 08.88 08.90 + Starrachse ³⁾ 09.90 07.92 08.87 07.89 + Starrachse ³⁾ 08.86 07.89 + Starrachse ³⁾ 08.89 07.90 + Starrachse ³⁾ 08.89 07.90 + Starrachse ³⁾ 08.84 08.90 + Starrachse ³⁾ 09.90 07.92 08.85 07.87 + Starrachse ³⁾ 08.87 07.90 + Starrachse ³⁾ 08.86 10.88 + Starrachse ³⁾	24.9238-0087.5 24.9238-0088.5 13.2401-0028.2 13.0441-3815.2 13.0441-3819.2 13.0441-4014.2	230035 230036 210046 250069 250072 250079	 	für Vorg. 13.2381-0067/-0068.2 ¹⁾ D=38 für Vorg. 13.2401-0023/-0024.2 ²⁾	D=38 D=38 D=40 Dichtungssatz Dichtungssatz Dichtungssatz	ATE ATE ATE ATE ATE ATE
	2.0 2.0 2.0 2.0 2.0 2.0 2.3 2.3 2.3 2.3 2.3 2.3 2.3 2.3 2.3 2.3 T 2.3 T 2.3 T 2.3 T 2.4 D 2.4 D 2.4 TD 2.4 TD 2.4 TD	76 86 89 89 110 118 120 82 83 84 85 85 86 95 96 100 111 111 111 114 114 117 115 121 134 140 60 60 80 83 90		09.88 08.90 + Starrachse ³⁾ 01.87 08.88 + Starrachse ³⁾ 08.85 08.90 + Starrachse ³⁾ 09.90 07.92 12.83 07.84 01.86 08.90 + Starrachse ³⁾ 08.84 07.86 09.85 12.89 + Starrachse ³⁾ 08.84 07.90 + Starrachse ³⁾ 08.87 08.90 + Starrachse ³⁾ 09.90 07.92 08.86 07.88 + Starrachse ³⁾ 08.83 07.84 08.84 07.88 + Starrachse ³⁾ 08.88 07.90 + Starrachse ³⁾ 08.88 08.90 + Starrachse ³⁾ 09.90 07.92 08.87 07.89 + Starrachse ³⁾ 08.86 07.89 + Starrachse ³⁾ 08.89 07.90 + Starrachse ³⁾ 08.89 07.90 + Starrachse ³⁾ 08.84 08.90 + Starrachse ³⁾ 09.90 07.92 08.85 07.87 + Starrachse ³⁾ 08.84 07.90 + Starrachse ³⁾ 08.86 10.88 + Starrachse ³⁾	13.0460-3401.2 13.0460-0088.2	603401 610088			20755 14,4 Belagsatz-Zubehör	ATE ATE
	2.0 2.0 2.0 2.0	76 86 89 118		09.88 08.90 + Multi-Link-Achse ⁴⁾ 08.87 08.88 + Multi-Link-Achse ⁴⁾ 08.87 08.90 + Multi-Link-Achse ⁴⁾ 08.87 08.90 + Multi-Link-Achse ⁴⁾	13.0460-2935.2	602935			21385 13,8 /S	TRW

¹⁾ f.predec.13.2381-0067/-0068.2 / p.prece.13.2381-0067.2/-0068.2 / p.préd.13.2381-0067.2/-0068.2 / p.prede.13.2381-0067.2/-0068.2
²⁾ f.predec.13.2401-0023/-0024.2 / p.prece.13.2401-0023.2/-0024.2 / p.préd.13.2401-0023.2/-0024.2 / p.prede.13.2401-0023.2/-0024.2
³⁾ + rigid axle / + assale rigido / + essieu rigide / + eje rigido
⁴⁾ + multi link axle / + assale Multi-link / + essieu multi-link / + eje Multi-Link



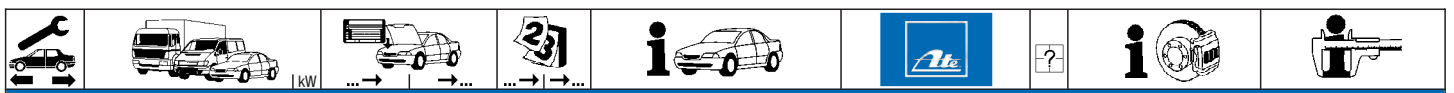

VOLVO 740 Limousine (83-92)

	2.3 T	134		08.85	12.88	83.6124-0305.3	330723	2		L=305
	2.3 T	140		08.89	07.90					
	2.4 D	60		08.84	07.92					
	2.4 TD	80		08.85	07.87 - ABS					
	2.4 TD	83		08.84	07.90 - ABS					
	2.4 TD	90		08.86	10.88 - ABS					
	2.4 TD	◀ 80		08.85	07.87 + ABS	83.6134-0300.3	330725	2		L=300
	2.4 TD	◀ 83		08.84	07.90 + ABS					
	2.4 TD	◀ 90		08.86	10.88 + ABS					
	2.0	76		09.88	08.90 + Starrachse ¹⁾	03.0137-0169.2	650169			160 x 25 Bremsbacken-Zubehör
	2.0	86		01.87	08.88 + Starrachse ¹⁾					
	2.0	89		08.85	08.90 + Starrachse ¹⁾					
	2.0	89		09.90	07.92					
	2.0	110		12.83	07.84					
	2.0	118		01.86	08.90 + Starrachse ¹⁾					
	2.0	120		01.85	12.85					
	2.3	82		08.84	07.86					
	2.3	83		09.85	12.89 + Starrachse ¹⁾					
	2.3	84		08.84	07.90 + Starrachse ¹⁾					
	2.3	85		08.87	08.90 + Starrachse ¹⁾					
	2.3	85		09.90	07.92 + Starrachse ¹⁾					
	2.3	86		08.86	07.88 + Starrachse ¹⁾					
	2.3	95		08.83	07.84					
	2.3	96		08.84	07.88 + Starrachse ¹⁾					
	2.3	100		08.88	07.90 + Starrachse ¹⁾					
	2.3	111		08.88	08.90 + Starrachse ¹⁾					
	2.3	111		09.90	07.92 + Starrachse ¹⁾					
	2.3	114		08.88	08.90 + Starrachse ¹⁾					
	2.3	114		09.90	07.91					
	2.3	117		08.87	07.89 + Starrachse ¹⁾					
	2.3 T	115		08.86	07.89 + Starrachse ¹⁾					
	2.3 T	121		08.89	07.90 + Starrachse ¹⁾					
	2.3 T	134		08.85	12.88 + Starrachse ¹⁾					
	2.3 T	140		08.89	07.90 + Starrachse ¹⁾					
	2.4 D	60		08.84	08.90 + Starrachse ¹⁾					
	2.4 D	60		09.90	07.92					
2.4 TD	80		08.85	07.87 + Starrachse ¹⁾						
2.4 TD	83		08.84	07.90 + Starrachse ¹⁾						
2.4 TD	90		08.86	10.88 + Starrachse ¹⁾						
	2.0	76		09.88	08.90 + Multi-Link-Achse ²⁾	03.0137-0299.2	650299			160 x 25 Bremsbacken-Zubehör
	2.0	86		08.87	08.88 + Multi-Link-Achse ²⁾					
	2.0	89		08.87	08.90 + Multi-Link-Achse ²⁾					
	2.0	118		08.87	08.90 + Multi-Link-Achse ²⁾					
	2.3	83		08.87	12.89 + Multi-Link-Achse ²⁾					
	2.3	84		08.87	07.90 + Multi-Link-Achse ²⁾					
	2.3	85		08.87	08.90 + Multi-Link-Achse ²⁾					
	2.3	86		08.87	07.88 + Multi-Link-Achse ²⁾					
	2.3	96		08.87	07.88 + Multi-Link-Achse ²⁾					
	2.3	100		08.88	07.90 + Multi-Link-Achse ²⁾					
	2.3	111		08.88	08.90 + Multi-Link-Achse ²⁾					
	2.3	114		08.88	08.90 + Multi-Link-Achse ²⁾					
	2.3	117		08.87	07.89 + Multi-Link-Achse ²⁾					
	2.3 T	115		08.86	07.89 + Multi-Link-Achse ²⁾					
	2.3 T	121		08.89	07.90 + Multi-Link-Achse ²⁾					
	2.3 T	134		08.87	12.88 + Multi-Link-Achse ²⁾					
	2.3 T	140		08.89	07.90 + Multi-Link-Achse ²⁾					
	2.4 D	60		08.87	08.90 + Multi-Link-Achse ²⁾					
2.4 TD	80		08.85	07.87 + Multi-Link-Achse ²⁾						
2.4 TD	83		08.87	07.90 + Multi-Link-Achse ²⁾						
2.4 TD	90		08.87	10.88 + Multi-Link-Achse ²⁾						
	2.0	86		01.87	07.87	24.3727-1306.2	581306	<input type="checkbox"/>		L=830
	2.0	89		08.85	07.87					
	2.0	110		12.83	07.84					
	2.0	118		01.86	07.87					
	2.0	120		01.85	12.85					
	2.3	82		08.84	07.86					
	2.3	83		09.85	07.87					
	2.3	84		08.84	07.87					
	2.3	86		08.86	07.87					
	2.3	95		08.83	07.84					
	2.3	96		08.84	07.87					
	2.3 T	115		08.86	07.87					
	2.3 T	134		08.85	07.87					
	2.4 D	60		08.84	07.87					
	2.4 TD	80		08.85	07.87					
2.4 TD	83		08.84	07.87						
2.4 TD	90		08.86	07.87						
	2.0	76		09.88	08.90	03.6055-0431.3	320142			BR 5/35 (4) ATE
	2.0	86		01.87	08.88					
	2.0	89		08.85	07.92					
	2.0	110		12.83	07.84					
	2.0	118		01.86	08.90					
	2.0	120		01.85	12.85					

¹⁾ + rigid axle / + assale rigido / + essieu rigide / + eje rígido

²⁾ + multi link axle / + assale Multi-link / + essieu multi-link / + eje Multi-Link





VOLVO 740 Limousine (83-92)

	2.0	86	01.87	07.87	24.2419-0928.3	030056		Gz 19,05					
	2.0	89	08.85	07.87									
	2.0	110	12.83	07.84									
	2.0	118	01.86	07.87									
	2.0	120	01.85	12.85									
	2.3	82	08.84	07.86									
	2.3	83	09.85	07.87									
	2.3	84	08.84	07.87									
	2.3	86	08.86	07.87									
	2.3	95	08.83	07.84									
	2.3	96	08.84	07.87									
	2.3 T	115	08.86	07.87									
	2.3 T	134	08.85	07.87									
	2.4 D	60	08.84	07.87									
	2.4 TD	80	08.85	07.87									
	2.4 TD	83	08.84	07.87									
2.4 TD	90	08.86	07.87										
	2.0	76	09.88	08.90	24.2419-0941.3	030067		Gz 19,05					
	2.0	86	08.87	08.88									
	2.0	89	08.85	07.92									
	2.0	110	12.83	07.84									
	2.0	118	01.86	08.90									
	2.0	120	01.85	12.85									
	2.3	82	08.84	07.86									
	2.3	83	09.85	12.89									
	2.3	84	08.84	07.90									
	2.3	85	08.87	07.92									
	2.3	86	08.86	07.88									
	2.3	95	08.83	07.84									
	2.3	96	08.84	07.88									
	2.3	100	08.88	07.90									
	2.3	111	08.88	07.92									
	2.3	114	08.88	07.91									
	2.3	117	08.87	07.89									
	2.3 T	115	08.86	07.89									
	2.3 T	121	08.89	07.90									
	2.3 T	134	08.85	12.88									
	2.3 T	140	08.89	07.90									
	2.4 D	60	08.84	07.92									
	2.4 TD	80	08.85	07.87									
	2.4 TD	83	08.84	07.90									
	2.4 TD	90	08.86	10.88									
		2.0	86	01.87					07.87	03.2522-0420.3	040086		Nz 22,20
		2.0	89	08.85					07.87				
		2.0	110	12.83					07.84				
2.0		118	01.86	07.87									
2.0		120	01.85	12.85									
2.3		82	08.84	07.86									
2.3		83	09.85	07.87									
2.3		84	08.84	07.87									
2.3		86	08.86	07.87									
2.3		95	08.83	07.84									
2.3		96	08.84	07.87									
2.3 T		115	08.86	07.87									
2.3 T		134	08.85	07.87									
2.4 D		60	08.84	07.87									
2.4 TD		80	08.85	07.87									
2.4 TD		83	08.84	07.87									
2.4 TD	90	08.86	07.87										
	2.0	76	09.88	08.90	24.2520-0905.3	040057		Nz 20,64					
	2.0	86	08.87	08.88									
	2.0	89	08.85	07.92									
	2.0	110	12.83	07.84									
	2.0	118	01.86	08.90									
	2.0	120	01.85	12.85									
	2.3	82	08.84	07.86									
	2.3	83	09.85	12.89									
	2.3	84	08.84	07.90									
	2.3	85	08.87	07.92									
	2.3	86	08.86	07.88									
	2.3	95	08.83	07.84									
	2.3	96	08.84	07.88									
	2.3	100	08.88	07.90									
	2.3	111	08.88	07.92									
	2.3	114	08.88	07.91									
	2.3	117	08.87	07.89									
	2.3 T	115	08.86	07.89									
	2.3 T	121	08.89	07.90									
	2.3 T	134	08.85	12.88									
	2.3 T	140	08.89	07.90									
	2.4 D	60	08.84	07.92									
	2.4 TD	80	08.85	07.87									
	2.4 TD	83	08.84	07.90									
	2.4 TD	90	08.86	10.88									

VOLVO 740 Limousine (83-92)

	2.4 D	60		08.84	08.90	24.3728-1301.2	591301		L=1100
	2.4 TD	80		08.85	07.87				
	2.4 TD	83		08.84	07.90				
	2.4 TD	90		08.86	10.88				

VOLVO 740 Kombi (85-92)

	2.0	76 176800		08.89	08.90 - ABS	03.2023-0503.3	010022		THz 23,81/16,84 + B. ATE
	2.0	82		08.89	07.91 - ABS	03.3517-5100.1	390326		Verschlußschraube ATE
	2.0	86 176800			08.88 - ABS				
	2.0	89 176800			08.91 - ABS				
	2.3	83 176800			12.89 - ABS				
	2.3	84 176800			07.90 - ABS				
	2.3	85 176800			08.91 - ABS				
	2.3	96 176800			07.88 - ABS				
	2.3	100		08.89	07.90 - ABS				
	2.3	111		07.89	08.91 - ABS				
	2.3	114 176800			07.90 - ABS				
	2.3	117 176800			07.89 - ABS				
	2.3 T	115 176800			07.89 - ABS				
	2.3 T	121		08.89	07.90 - ABS				
	2.3 T	134 176800			07.88 - ABS				
	2.3 T	140		08.89	07.90 - ABS				
	2.4 D	60 176800			07.88 - ABS				
	2.4 TD	80 176800			08.91 - ABS				
	2.4 TD Intercooler	90 176800			07.88 - ABS				
	2.0	76		09.88	08.90 + ABS	03.2023-0164.3	010014		THz 23,81/19,05 + B. ATE
	2.0	82		08.89	07.91 + ABS				
	2.0	86		09.87	08.88 + ABS				
	2.0	89		09.87	08.91 + ABS				
	2.3	83		09.87	12.89 + ABS				
	2.3	84		09.87	07.90 + ABS				
	2.3	85		09.87	08.91 + ABS				
	2.3	96		09.87	07.88 + ABS				
	2.3	100		08.89	07.90 + ABS				
	2.3	111		07.89	08.91 + ABS				
	2.3	114		08.88	07.90 + ABS				
	2.3	117		09.87	07.89 + ABS				
	2.3 T	115		09.87	07.89 + ABS				
	2.3 T	121		08.89	07.90 + ABS				
	2.3 T	134		09.87	07.88 + ABS				
	2.3 T	140		08.89	07.90 + ABS				
	2.4 D	60		09.87	07.88 + ABS				
	2.4 TD	80		09.87	08.91 + ABS				
	2.4 TD Intercooler	90		09.87	07.88 + ABS				
	2.0	89		09.91	07.92	03.2023-0875.3	010890		THz 23,81/20,64 - B. ATE
	2.3	85		09.91	07.92				
	2.3	111		07.89	07.92				
	2.4 TD	80		09.91	07.92				
	2.0	76		09.88	08.90 - ABS	24.0101-3401.2	260043		Bremssattel-Zubehör TRW
	2.0	82		08.89	08.90 - ABS				
	2.0	86		01.87	08.88 - ABS				
	2.0	89		08.85	08.90 - ABS				
	2.3	82		08.85	07.86				
	2.3	83		08.85	12.89 - ABS				
	2.3	84		09.85	07.90 - ABS				
	2.3	85		08.87	08.90 - ABS				
	2.3	96		08.85	07.88 - ABS				
	2.3	100		08.89	07.90 - ABS				
	2.3	111		07.89	08.90 - ABS				
	2.3	114		08.88	07.90 - ABS				
	2.3	117		08.87	07.89 - ABS				
	2.3 T	115		08.86	07.89 - ABS				
	2.3 T	121		08.89	07.90 - ABS				
	2.3 T	134		08.85	07.88 - ABS				
	2.3 T	140		08.89	07.90 - ABS				
	2.4 D	60		08.85	07.88 - ABS				
	2.4 TD	80		09.85	08.90 - ABS				
	2.4 TD Intercooler	90		08.86	07.88 - ABS				
	2.0	82		09.90	07.91 + ABS	24.3571-1707.5	240079		D=57, - Halter TRW
	2.0	89		09.90	07.92 + ABS	24.3571-1708.5	240080		D=57, - Halter TRW
	2.3	85		09.90	07.92 + ABS	24.0101-3601.2	260044		Bremssattel-Zubehör TRW
	2.3	111		09.90	07.92 + ABS				
	2.4 TD	80		09.90	07.92 + ABS				
	2.0	76		09.88	08.90	13.0460-3914.2	603914		21233 16,7 BDX
	2.0	82		08.89	08.90	13.0460-2943.2	602943		21266 17,0 /S TRW
	2.0	86		01.87	08.88	13.0460-0429.2	610429		Belagsatz-Zubehör BDX
	2.0	89		08.85	08.90				
	2.0	89		09.90	07.92 - ABS				
	2.3	82		09.90	07.91 - ABS				
	2.3	82		08.85	07.86				
	2.3	83		08.85	12.89				
	2.3	84		09.85	07.90				
	2.3	85		08.87	08.90				
	2.3	85		09.90	07.92 - ABS				
	2.3	96		08.85	07.88				
	2.3	100		08.89	07.90				
	2.3	111		07.89	08.90				



VOLVO 740 Kombi (85-92)

	2.3	111		09.90	07.92	- ABS	13.0460-3914.2	603914		21233	16,7	BDX
	2.3	114		08.88	07.90		13.0460-2943.2	602943		21266	17,0 / S	TRW
	2.3	117		08.87	07.89		13.0460-0429.2	610429				BDX
	2.3 T	115		08.86	07.89							
	2.3 T	121		08.89	07.90							
	2.3 T	134		08.85	07.88							
	2.3 T	140		08.89	07.90							
	2.4 D	60		08.85	07.88							
	2.4 TD	80		09.85	08.90							
	2.4 TD	80		09.90	07.92	- ABS						
2.4 TD Intercooler	90		08.86	07.88								
	2.0	82		09.90	07.91	+ ABS	13.0460-2985.2	602985		20164	18,2	TRW
	2.0	89		09.90	07.92	+ ABS						
	2.3	85		09.90	07.92	+ ABS						
	2.3	111		09.90	07.92	+ ABS						
	2.4 TD	80		09.90	07.92	+ ABS						
	2.0	86		01.87	07.87		24.0122-0217.2	422217		+ 14" Rad ¹⁾	263	22,0 20,0 V
	2.0	89		08.85	07.87							
	2.3	82		08.85	07.86							
	2.3	83		08.85	07.87							
	2.3	84		09.85	07.87							
	2.3	96		08.85	07.87							
	2.3 T	115		08.86	07.87							
	2.3 T	134		08.85	07.87							
	2.4 D	60		08.85	07.87							
	2.4 TD	80		09.85	07.87							
2.4 TD Intercooler	90		08.86	07.87								
	2.0	76		09.88	08.90		24.0122-0138.1	422138		+ 14" Rad ¹⁾	263	22,0 20,0 V
	2.0	82		08.89	08.90		24.0122-0137.1	422137		+ 15" Rad ²⁾	287	22,0 20,0 V
	2.0	86		08.87	08.88							
	2.0	89		08.87	08.90							
	2.3	83		08.87	12.89							
	2.3	84		08.87	07.90							
	2.3	85		08.87	08.90							
	2.3	96		08.87	07.88							
	2.3	100		08.89	07.90							
	2.3	111		07.89	08.90							
	2.3	114		08.88	07.90							
	2.3	117		08.87	07.89							
	2.3 T	115		08.87	07.89							
	2.3 T	121		08.89	07.90							
	2.3 T	134		08.87	07.88							
2.3 T	140		08.89	07.90								
2.4 D	60		08.87	07.88								
2.4 TD	80		08.87	08.90								
2.4 TD Intercooler	90		08.87	07.88								
	2.0	82		09.90	07.91	- ABS	24.0122-0137.1	422137			287	22,0 20,0 V
	2.0	89		09.90	07.92	- ABS						
	2.3	85		09.90	07.92	- ABS						
	2.3	111		09.90	07.92	- ABS						
	2.4 TD	80		09.90	07.92	- ABS						
	2.0	82		09.90	07.91	+ ABS	24.0126-0105.1	426105			280	26,0 23,0 V +B
	2.0	89		09.90	07.92	+ ABS						
	2.3	85		09.90	07.92	+ ABS						
	2.3	111		09.90	07.92	+ ABS						
	2.4 TD	80		09.90	07.92	+ ABS						
	2.0	76		09.88	08.90		83.6134-0335.3	330277	4		L=335	
	2.0	82		08.89	08.90							
	2.0	86		01.87	08.88							
	2.0	89		08.85	07.92	- ABS						
	2.3	82		08.85	07.86							
	2.3	83		08.85	12.89							
	2.3	84		09.85	07.90							
	2.3	85		08.87	07.92	- ABS						
	2.3	96		08.85	07.88							
	2.3	100		08.89	07.90							
2.3	111		07.89	07.92	- ABS							
2.3	114		08.88	07.90								
2.3	117		08.87	07.89								
2.3 T	115		08.86	07.89								
2.3 T	121		08.89	07.90								
2.3 T	134		08.85	07.88								
2.3 T	140		08.89	07.90								
2.4 D	60		08.85	07.88								
2.4 TD	80		09.85	07.92	- ABS							
2.4 TD Intercooler	90		08.86	07.88								
	2.0	76		09.88	08.90	+ ABS	83.6134-0335.3	330277	2		L=335	
	2.0	82		08.89	07.91	+ ABS						
	2.0	86		09.87	08.88	+ ABS						
	2.0	89		09.87	07.92	+ ABS						
	2.3	83		09.87	12.89	+ ABS						
	2.3	84		09.87	07.90	+ ABS						
	2.3	85		09.87	07.92	+ ABS						
	2.3	96		09.87	07.88	+ ABS						
	2.3	100		08.89	07.90	+ ABS						
	2.3	111		07.89	07.92	+ ABS						

¹⁾ + 14" wheel / + ruota 14" / + roue 14" / + rueda 14"

²⁾ + 15" wheel / + ruota 15" / + roue 15" / + rueda 15"

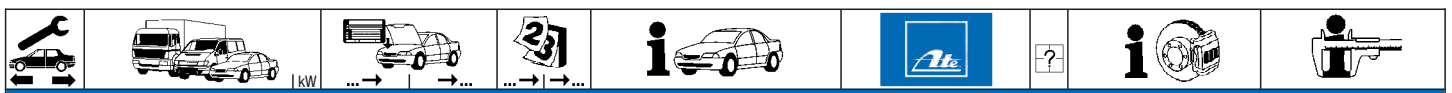

VOLVO 740 Kombi (85-92)

	2.3 2.3 2.3 T 2.3 T 2.3 T 2.3 T 2.4 D 2.4 TD 2.4 TD Intercooler	114 117 115 121 134 140 60 80 90	08.88 07.90 + ABS 09.87 07.89 + ABS 09.87 07.89 + ABS 08.89 07.90 + ABS 09.87 07.88 + ABS 08.89 07.90 + ABS 09.87 07.88 + ABS 09.87 07.92 + ABS 09.87 07.88 + ABS	83.6134-0335.3 330277	2		L=335	
	2.0 2.0 2.3 2.3 2.3 2.3 2.3 T 2.3 T 2.4 D 2.4 TD 2.4 TD Intercooler	86 89 82 83 84 96 115 134 60 80 90	01.87 07.87 08.85 07.87 08.85 07.86 08.85 07.87 09.85 07.87 08.85 07.87 08.86 07.87 08.85 07.87 08.85 07.87 09.85 07.87 08.86 07.87	24.9236-0001.5 24.9236-0002.5 24.9238-0087.5 24.9238-0088.5 13.2401-0028.2 13.0441-3815.2 13.0441-3819.2 13.0441-4014.2	230005 230006 230035 230036 210046 250069 250072 250079	 für Vorg. 13.2381-0067/-0068.2 ¹⁾ D=38 für Vorg. 13.2401-0023/-0024.2 ²⁾	D=36 D=36 D=38 D=38 D=40 Dichtungssatz Dichtungssatz Dichtungssatz	ATE ATE ATE ATE ATE ATE ATE ATE
	2.0 2.0 2.0 2.0 2.0 2.0 2.3 2.3 2.3 2.3 2.3 2.3 2.3 2.3 2.3 2.3 2.3 2.3 2.3 2.3 2.3 2.3 2.3 2.3 2.3 T 2.3 T 2.3 T 2.3 T 2.4 D 2.4 TD 2.4 TD Intercooler	76 82 82 86 89 89 83 84 85 85 96 100 111 111 114 117 115 121 134 140 60 80 80 90	09.88 08.90 + Starrachse ³⁾ 08.89 08.90 + Starrachse ³⁾ 09.90 07.91 08.87 08.88 + Starrachse ³⁾ 08.87 08.90 + Starrachse ³⁾ 09.90 07.92 08.87 12.89 + Starrachse ³⁾ 08.87 07.90 + Starrachse ³⁾ 08.87 08.90 + Starrachse ³⁾ 09.90 07.92 08.87 07.88 + Starrachse ³⁾ 08.89 07.90 + Starrachse ³⁾ 07.89 08.90 + Starrachse ³⁾ 09.90 07.92 08.88 07.90 + Starrachse ³⁾ 08.87 07.89 + Starrachse ³⁾ 08.87 07.89 + Starrachse ³⁾ 08.89 07.90 + Starrachse ³⁾ 08.89 07.90 + Starrachse ³⁾ 08.87 07.88 + Starrachse ³⁾ 08.87 07.88 + Starrachse ³⁾ 09.90 07.92 08.87 07.88 + Starrachse ³⁾	24.9238-0087.5 24.9238-0088.5 13.2401-0028.2 13.0441-3815.2 13.0441-3819.2 13.0441-4014.2	230035 230036 210046 250069 250072 250079	 für Vorg. 13.2381-0067/-0068.2 ¹⁾ D=38 für Vorg. 13.2401-0023/-0024.2 ²⁾	D=38 D=38 D=40 Dichtungssatz Dichtungssatz Dichtungssatz	ATE ATE ATE ATE ATE ATE
	2.0 2.0 2.0 2.0 2.0 2.0 2.3 T 2.3 T 2.3 T 2.3 T 2.4 D 2.4 TD 2.4 TD Intercooler	76 82 82 86 89 89 83 84 85 85 96 100 111 111 114 117 115 121 134 140 60 80 80 90	09.88 08.90 + Starrachse ³⁾ 08.89 08.90 + Starrachse ³⁾ 09.90 07.91 08.87 08.88 + Starrachse ³⁾ 08.87 08.90 + Starrachse ³⁾ 09.90 07.92 08.87 12.89 + Starrachse ³⁾ 08.87 07.90 + Starrachse ³⁾ 08.87 08.90 + Starrachse ³⁾ 09.90 07.92 08.87 07.88 + Starrachse ³⁾ 08.89 07.90 + Starrachse ³⁾ 07.89 08.90 + Starrachse ³⁾ 09.90 07.92 08.88 07.90 + Starrachse ³⁾ 08.87 07.89 + Starrachse ³⁾ 08.87 07.89 + Starrachse ³⁾ 08.89 07.90 + Starrachse ³⁾ 08.89 07.90 + Starrachse ³⁾ 08.87 07.88 + Starrachse ³⁾ 08.87 07.88 + Starrachse ³⁾ 09.90 07.92 08.87 07.88 + Starrachse ³⁾	13.0460-3401.2 13.0460-0088.2	603401 610088		20755 14,4 Belagsatz-Zubehör	ATE ATE
	2.0 2.0 2.0 2.0 2.3 T 2.3 T 2.3 T 2.3 T 2.4 D 2.4 TD 2.4 TD Intercooler	76 82 86 89 83 84 85 85 96 100 111 111 114 117 115 121 134 140 60 80 80 90	09.88 08.90 + Multi-Link-Achse ⁴⁾ 08.89 08.90 + Multi-Link-Achse ⁴⁾ 09.87 08.88 + Multi-Link-Achse ⁴⁾ 09.87 08.90 + Multi-Link-Achse ⁴⁾ 09.87 12.89 + Multi-Link-Achse ⁴⁾ 09.87 07.90 + Multi-Link-Achse ⁴⁾ 09.87 08.90 + Multi-Link-Achse ⁴⁾ 09.87 07.88 + Multi-Link-Achse ⁴⁾ 08.89 07.90 + Multi-Link-Achse ⁴⁾ 07.89 08.90 + Multi-Link-Achse ⁴⁾ 08.88 07.90 + Multi-Link-Achse ⁴⁾ 09.87 07.89 + Multi-Link-Achse ⁴⁾ 08.87 07.89 + Multi-Link-Achse ⁴⁾ 08.89 07.90 + Multi-Link-Achse ⁴⁾ 08.89 07.90 + Multi-Link-Achse ⁴⁾ 08.87 07.88 + Multi-Link-Achse ⁴⁾ 08.87 07.88 + Multi-Link-Achse ⁴⁾ 09.90 07.92 08.87 07.88 + Multi-Link-Achse ⁴⁾	13.0460-2935.2	602935		21385 13,8 /S	TRW

¹⁾ f.predec.13.2381-0067/-0068.2 / p.prece.13.2381-0067.2/-0068.2 / p.préd.13.2381-0067.2/-0068.2 / p.prede.13.2381-0067.2/-0068.2

²⁾ f.predec.13.2401-0023/-0024.2 / p.prece.13.2401-0023.2/-0024.2 / p.préd.13.2401-0023.2/-0024.2 / p.prede.13.2401-0023.2/-0024.2

³⁾ + rigid axle / + assale rigido / + essieu rigide / + eje rígido

⁴⁾ + multi link axle / + assale Multi-link / + essieu multi-link / + eje Multi-Link









VOLVO 740 Kombi (85-92)

	2.0	76	09.88	08.90	+ Starrachse ¹⁾	24.0110-0189.1	410189		281 9,6 8,4 +B
	2.0	82	08.89	08.90	+ Starrachse ¹⁾				
	2.0	82	09.90	07.91					
	2.0	86	08.87	08.88	+ Starrachse ¹⁾				
	2.0	89	08.87	08.90	+ Starrachse ¹⁾				
	2.0	89	09.90	07.92					
	2.3	83	08.87	12.89	+ Starrachse ¹⁾				
	2.3	84	08.87	07.90	+ Starrachse ¹⁾				
	2.3	85	08.87	08.90	+ Starrachse ¹⁾				
	2.3	85	09.90	07.92					
	2.3	96	08.87	07.88	+ Starrachse ¹⁾				
	2.3	100	08.89	07.90	+ Starrachse ¹⁾				
	2.3	111	07.89	08.90	+ Starrachse ¹⁾				
	2.3	111	09.90	07.92					
	2.3	114	08.88	07.90	+ Starrachse ¹⁾				
	2.3	117	08.87	07.89	+ Starrachse ¹⁾				
	2.3 T	115	08.87	07.89	+ Starrachse ¹⁾				
	2.3 T	121	08.89	07.90	+ Starrachse ¹⁾				
	2.3 T	134	08.87	07.88	+ Starrachse ¹⁾				
	2.3 T	140	08.89	07.90	+ Starrachse ¹⁾				
2.4 D	60	08.87	07.88	+ Starrachse ¹⁾					
2.4 TD	80	08.87	08.90	+ Starrachse ¹⁾					
2.4 TD	80	09.90	07.92						
2.4 TD Intercooler	90	08.87	07.88	+ Starrachse ¹⁾					
	2.0	76	09.88	08.90	+ Multi-Link-Achse ²⁾	24.0110-0206.1	410206		265 10,0 8,0
	2.0	82	08.89	08.90	+ Multi-Link-Achse ²⁾				
	2.0	86	09.87	08.88	+ Multi-Link-Achse ²⁾				
	2.0	89	09.87	08.90	+ Multi-Link-Achse ²⁾				
	2.3	83	09.87	12.89	+ Multi-Link-Achse ²⁾				
	2.3	84	09.87	07.90	+ Multi-Link-Achse ²⁾				
	2.3	85	09.87	08.90	+ Multi-Link-Achse ²⁾				
	2.3	96	09.87	07.88	+ Multi-Link-Achse ²⁾				
	2.3	100	08.89	07.90	+ Multi-Link-Achse ²⁾				
	2.3	111	07.89	08.90	+ Multi-Link-Achse ²⁾				
	2.3	114	08.88	07.90	+ Multi-Link-Achse ²⁾				
	2.3	117	09.87	07.89	+ Multi-Link-Achse ²⁾				
	2.3 T	115	09.87	07.89	+ Multi-Link-Achse ²⁾				
	2.3 T	121	08.89	07.90	+ Multi-Link-Achse ²⁾				
	2.3 T	134	09.87	07.88	+ Multi-Link-Achse ²⁾				
	2.3 T	140	08.89	07.90	+ Multi-Link-Achse ²⁾				
	2.4 D	60	09.87	07.88	+ Multi-Link-Achse ²⁾				
	2.4 TD	80	09.87	08.90	+ Multi-Link-Achse ²⁾				
	2.4 TD Intercooler	90	09.87	07.88	+ Multi-Link-Achse ²⁾				
		2.0	76	09.88	08.90				
2.0		82	08.89	08.90					
2.0		86	01.87	08.88					
2.0		89	08.85	07.92					
2.3		82	08.85	07.86					
2.3		83	08.85	12.89					
2.3		84	09.85	07.90					
2.3		85	08.87	07.92					
2.3		96	08.85	07.88					
2.3		100	08.89	07.90					
2.3		111	07.89	07.92					
2.3		114	08.88	07.90					
2.3		117	08.87	07.89					
2.3 T		115	08.86	07.89					
2.3 T		121	08.89	07.90					
2.3 T		134	08.85	07.88					
2.3 T		140	08.89	07.90					
2.4 D		60	08.85	07.88					
2.4 TD		80	09.85	07.92	- ABS				
2.4 TD Intercooler		90	08.86	07.88					
2.4 TD	80	09.85	07.92	+ ABS					
	2.0	76	09.88	08.90	+ Starrachse ¹⁾	03.0137-0169.2	650169		160 x 25 Bremsbacken-Zubehör
	2.0	82	08.89	08.90	+ Starrachse ¹⁾				
	2.0	82	09.90	07.91					
	2.0	86	08.87	08.88	+ Starrachse ¹⁾				
	2.0	89	08.87	08.90	+ Starrachse ¹⁾				
	2.0	89	09.90	07.92					
	2.3	83	08.87	12.89	+ Starrachse ¹⁾				
	2.3	84	08.87	07.90	+ Starrachse ¹⁾				
	2.3	85	08.87	08.90	+ Starrachse ¹⁾				
	2.3	85	09.90	07.92					
	2.3	96	08.87	07.88	+ Starrachse ¹⁾				
	2.3	100	08.89	07.90	+ Starrachse ¹⁾				
	2.3	111	07.89	08.90	+ Starrachse ¹⁾				
	2.3	111	09.90	07.92					
	2.3	114	08.88	07.90	+ Starrachse ¹⁾				
	2.3	117	08.87	07.89	+ Starrachse ¹⁾				
	2.3 T	115	08.87	07.89	+ Starrachse ¹⁾				
	2.3 T	121	08.89	07.90	+ Starrachse ¹⁾				
	2.3 T	134	08.87	07.88	+ Starrachse ¹⁾				
	2.3 T	140	08.89	07.90	+ Starrachse ¹⁾				
2.4 D	60	08.87	07.88	+ Starrachse ¹⁾					
2.4 TD	80	08.87	08.90	+ Starrachse ¹⁾					
2.4 TD	80	09.90	07.92						

¹⁾ + rigid axle / + assale rigido / + essieu rigide / + eje rígido
²⁾ + multi link axle / + assale Multi-link / + essieu multi-link / + eje Multi-Link

VOLVO 740 Kombi (85-92)

	2.4 TD Intercooler	90		08.87	07.88	+ Starrachse ¹⁾	03.0137-0169.2	650169		160 x 25
							03.0137-9065.2	669065		Bremsbacken-Zubehör
	2.0	76		09.88	08.90	+ Multi-Link-Achse ²⁾	03.0137-0299.2	650299		160 x 25
	2.0	82		08.89	08.90	+ Multi-Link-Achse ²⁾	03.0137-9199.2	669199		Bremsbacken-Zubehör
	2.0	86		09.87	08.88	+ Multi-Link-Achse ²⁾				
	2.0	89		09.87	08.90	+ Multi-Link-Achse ²⁾				
	2.3	83		09.87	12.89	+ Multi-Link-Achse ²⁾				
	2.3	84		09.87	07.90	+ Multi-Link-Achse ²⁾				
	2.3	85		09.87	08.90	+ Multi-Link-Achse ²⁾				
	2.3	96		09.87	07.88	+ Multi-Link-Achse ²⁾				
	2.3	100		08.89	07.90	+ Multi-Link-Achse ²⁾				
	2.3	111		07.89	08.90	+ Multi-Link-Achse ²⁾				
	2.3	114		08.88	07.90	+ Multi-Link-Achse ²⁾				
	2.3	117		09.87	07.89	+ Multi-Link-Achse ²⁾				
	2.3 T	115		09.87	07.89	+ Multi-Link-Achse ²⁾				
	2.3 T	121		08.89	07.90	+ Multi-Link-Achse ²⁾				
	2.3 T	134		09.87	07.88	+ Multi-Link-Achse ²⁾				
	2.3 T	140		08.89	07.90	+ Multi-Link-Achse ²⁾				
	2.4 D	60		09.87	07.88	+ Multi-Link-Achse ²⁾				
	2.4 TD	80		09.87	08.90	+ Multi-Link-Achse ²⁾				
	2.4 TD Intercooler	90		09.87	07.88	+ Multi-Link-Achse ²⁾				
	2.0	86		01.87	07.87		24.3727-1306.2	581306	<input type="checkbox"/>	L=830
	2.0	89		08.85	07.87					
	2.3	82		08.85	07.86					
	2.3	83		08.85	07.87					
	2.3	84		09.85	07.87					
	2.3	96		08.85	07.87					
	2.3 T	115		08.86	07.87					
	2.3 T	134		08.85	07.87					
	2.4 D	60		08.85	07.87					
	2.4 TD	80		09.85	07.87					
	2.4 TD Intercooler	90		08.86	07.87					
	2.0	89		09.91	07.92		03.6055-0431.3	320142		BR 5/35 (4) ATE
	2.0	86		01.87	07.87		24.2419-0928.3	030056		Gz 19,05
	2.0	89		08.85	07.87					
	2.3	82		08.85	07.86					
	2.3	83		08.85	07.87					
	2.3	84		09.85	07.87					
	2.3	96		08.85	07.87					
	2.3 T	115		08.86	07.87					
	2.3 T	134		08.85	07.87					
	2.4 D	60		08.85	07.87					
	2.4 TD	80		09.85	07.87					
	2.4 TD Intercooler	90		08.86	07.87					
	2.0	76		09.88	08.90		24.2419-0941.3	030067		Gz 19,05
	2.0	82		08.89	07.91					
	2.0	86		08.87	08.88					
	2.0	89		08.87	07.92					
	2.3	83		08.87	12.89					
	2.3	84		08.87	07.90					
	2.3	85		08.87	07.92					
	2.3	96		08.87	07.88					
	2.3	100		08.89	07.90					
	2.3	111		07.89	07.92					
	2.3	114		08.88	07.90					
	2.3	117		08.87	07.89					
	2.3 T	115		08.87	07.89					
	2.3 T	121		08.89	07.90					
	2.3 T	134		08.87	07.88					
	2.3 T	140		08.89	07.90					
	2.4 D	60		08.87	07.88					
	2.4 TD	80		08.87	07.92					
	2.4 TD Intercooler	90		08.87	07.88					
	2.0	86		01.87	07.87		03.2522-0420.3	040086		Nz 22,20
	2.0	89		08.85	07.87					
	2.3	82		08.85	07.86					
	2.3	83		08.85	07.87					
	2.3	84		09.85	07.87					
	2.3	96		08.85	07.87					
	2.3 T	115		08.86	07.87					
	2.3 T	134		08.85	07.87					
	2.4 D	60		08.85	07.87					
	2.4 TD	80		09.85	07.87					
	2.4 TD Intercooler	90		08.86	07.87					
	2.0	76		09.88	08.90		24.2520-0905.3	040057		Nz 20,64
	2.0	82		08.89	07.91					
	2.0	86		08.87	08.88					
	2.0	89		08.87	07.92					
	2.3	83		08.87	12.89					
	2.3	84		08.87	07.90					
	2.3	85		08.87	07.92					
	2.3	96		08.87	07.88					
	2.3	100		08.89	07.90					
	2.3	111		07.89	07.92					

¹⁾ + rigid axle / + assale rigido / + essieu rigide / + eje rígido

²⁾ + multi link axle / + assale Multi-link / + essieu multi-link / + eje Multi-Link



VOLVO 740 Kombi (85-92)

	2.3	114		08.88	07.90	24.2520-0905.3	040057			Nz 20,64
	2.3	117		08.87	07.89					
	2.3 T	115		08.87	07.89					
	2.3 T	121		08.89	07.90					
	2.3 T	134		08.87	07.88					
	2.3 T	140		08.89	07.90					
	2.4 D	60		08.87	07.88					
	2.4 TD	80		08.87	07.92					
	2.4 TD Intercooler	90		08.87	07.88					
	2.4 D	◀ 60		08.87	07.88	24.3728-1301.2	591301			L=1100
	2.4 TD	◀ 80		08.87	08.90					
	2.4 TD Intercooler	◀ 90		08.87	07.88					

VOLVO 760 Limousine (82-92)

	2.3	84		08.84	08.87 + ABS	03.2023-0164.3	010014			THz 23,81/19,05 + B. ATE						
	2.3	119		01.88	07.92											
	2.3 T	134		09.85	10.88 + ABS											
	2.4 D	60		09.85	07.92 + ABS											
	2.4 TD	80		04.85	07.92 + ABS											
	2.4 TD	82		09.85	07.87 + ABS											
	2.4 TD Intercooler	85		08.87	07.92											
	2.8	95		09.85	12.87 + ABS											
	2.8	105		05.86	08.91 + ABS											
	2.8	108		08.86	07.90 + ABS											
	2.8	115		09.85	07.88 + ABS											
2.8	125		09.87	08.90 + ABS												
	2.3	84		08.84	08.87 - ABS	24.0101-3401.2	260043			Bremsattel-Zubehör TRW						
	2.3 T	134		09.84	08.87 - ABS											
	2.4 D	60		09.84	08.87 - ABS											
	2.4 TD	80		04.87	08.87 - ABS											
	2.4 TD	82		09.84	07.87 - ABS											
	2.8	95		09.84	08.87 - ABS											
	2.8	105		05.86	08.87 - ABS											
	2.8	108		08.86	08.87 - ABS											
	2.8	115		09.84	08.87 - ABS											
	2.8	125		09.84	08.87 - ABS											
	2.3 T	127		08.82	07.84	13.0460-2943.2	602943			21266 17,0 / S TRW						
	2.4 D	60		01.82	08.84											
	2.4 TD	82		08.82	08.84											
	2.8	95		01.82	08.84											
	2.8	115		08.81	08.84											
	2.8	125		09.87	08.90											
	2.3	84		08.84	08.87	13.0460-3914.2	603914			21233 16,7 BDX						
	2.3	119		08.84	08.87											
	2.3	119		01.88	07.92											
	2.3 T	134		09.84	10.88											
	2.4 D	60		09.84	07.92											
	2.4 TD	80		04.87	07.92											
	2.4 TD	82		09.84	07.87											
	2.4 TD Intercooler	85		08.87	07.92											
	2.8	95		09.84	12.87											
	2.8	105		05.86	08.91											
	2.8	108		08.86	07.90											
	2.8	115		09.84	07.88											
	2.8	125		09.87	08.90											
		2.3 T	127		08.82						08.87	24.0122-0217.2	422217		+ 14" Rad ¹⁾	263 22,0 20,0 V
		2.3 T	134		09.84						08.87					
		2.4 D	60		09.84						08.87					
		2.4 TD	80		04.87						08.87					
2.4 TD		82		09.84	07.87											
2.8		95		09.84	08.87											
2.8		105		05.86	08.87											
2.8		108		08.86	08.87											
2.8		115		09.84	08.87											
2.3		84		08.84	08.87	24.0122-0137.1	422137			287 22,0 20,0 V						
2.3		119		01.88	07.92											
2.3 T		134		09.87	10.88											
2.4 D		60		09.87	07.92											
2.4 TD		80		09.87	07.92											
2.4 TD Intercooler		85		08.87	07.92											
2.8		95		09.87	12.87											
2.8		105		09.87	08.91											
2.8	108		09.87	07.90												
2.8	115		09.87	07.88												
2.8	125		09.87	08.90												
	2.3 T	127		08.82	07.84 - ABS	83.6134-0335.3	330277	4		L=335						
	2.3 T	134		08.84	08.87 - ABS											
	2.4 D	60		01.82	08.87 - ABS											
	2.4 TD	80		04.87	08.87 - ABS											
	2.4 TD	82		08.82	07.87 - ABS											
	2.8	95		01.82	08.87 - ABS											
	2.8	105		05.86	08.87 - ABS											
	2.8	108		08.86	08.87 - ABS											
	2.8	115		08.81	08.87 - ABS											
	2.8	125		09.87	08.90											
	2.3 T	127		09.82	07.84 + ABS	83.6124-0305.3	330723	2		L=305						
	2.3 T	134		09.85	08.87 + ABS											
	2.4 D	60		09.85	08.87 + ABS											
	2.4 TD	80		04.87	08.87 + ABS											

¹⁾ + 14" wheel / + ruota 14" / + roue 14" / + rueda 14"

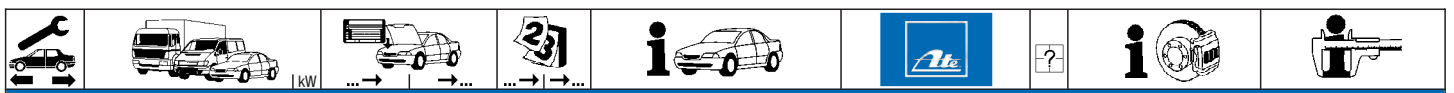

VOLVO 760 Limousine (82-92)

	2.4 TD	82		09.85	07.87	+ ABS	83.6124-0305.3	330723	2			L=305						
	2.8	95		09.85	08.87	+ ABS												
	2.8	105		05.86	08.87	+ ABS												
	2.8	108		08.86	08.87	+ ABS												
	2.8	115		09.85	08.87	+ ABS												
	2.3	84		08.84	08.87								83.6134-0335.3	330277	2			L=335
	2.3	119		01.88	07.92													
	2.3 T	134		09.87	10.88													
	2.4 D	60		09.87	07.92													
	2.4 TD	80		09.87	07.92													
2.4 TD Intercooler	85		08.87	07.92														
2.8	95		09.87	12.87														
2.8	105		09.87	08.91														
2.8	108		09.87	07.90														
2.8	115		09.87	07.88														
2.8	125		09.87	08.90														
	2.3 T	134		09.84	08.87		24.9236-0001.5	230005	<input type="checkbox"/>			D=36	ATE					
	2.4 D	60		09.84	08.87													
	2.4 TD	80		04.87	08.87													
	2.4 TD	82		09.84	07.87													
	2.8	95		09.84	08.87													
	2.8	105		05.86	08.87													
	2.8	108		08.86	08.87													
	2.8	115		09.84	08.87													
	2.8	125		09.84	08.87													
	2.8	115		09.84	08.87													
	2.3 T	127		08.82	07.84		13.0460-3401.2	603401	<input type="checkbox"/>			20755 14,4	ATE					
	2.3 T	134		08.84	08.87													
	2.4 D	60		01.82	08.87													
	2.4 TD	80		04.87	08.87													
	2.4 TD	82		08.82	07.87													
	2.8	95		01.82	08.87													
	2.8	105		05.86	08.87													
	2.8	108		08.86	08.87													
	2.8	115		08.81	08.87													
	2.8	115		08.81	08.87													
	2.3	84		08.84	08.87		13.0460-2935.2	602935	<input type="checkbox"/>			21385 13,8 /S	TRW					
	2.3	119		01.88	07.92													
	2.3 T	134		09.87	10.88													
	2.4 D	60		09.87	07.92													
	2.4 TD	80		09.87	07.92													
	2.4 TD Intercooler	85		08.87	07.92													
	2.8	95		09.87	12.87													
	2.8	105		09.87	08.91													
	2.8	108		09.87	07.90													
	2.8	115		09.87	07.88													
2.8	125		09.87	08.90														
	2.3	84		08.84	08.87		24.0110-0189.1	410189	<input type="checkbox"/>			281 9,6 8,4 +B						
	2.3 T	127		08.82	07.84													
	2.3 T	134		08.84	08.87													
	2.4 D	60		01.82	08.87													
	2.4 TD	80		04.87	08.87													
	2.4 TD	82		08.82	07.87													
	2.8	95		01.82	08.87													
	2.8	105		05.86	08.87													
	2.8	108		08.86	08.87													
	2.8	115		08.81	08.87													
	2.3	119		08.84	08.87		24.0110-0206.1	410206	<input type="checkbox"/>			265 10,0 8,0						
	2.3	119		01.88	07.92													
	2.3 T	134		09.87	10.88													
	2.4 D	60		09.87	07.92													
	2.4 TD	80		09.87	07.92													
	2.4 TD Intercooler	85		08.87	07.92													
	2.8	95		09.87	12.87													
	2.8	105		09.87	08.91													
	2.8	108		09.87	07.90													
	2.8	115		09.87	07.88													
2.8	125		09.87	08.90														
	2.3 T	127		08.82	07.84		83.6124-0305.3	330723	2			L=305						
	2.3 T	134		08.84	08.87													
	2.4 D	60		01.82	08.87													
	2.4 TD	80		04.87	08.87													
	2.4 TD	82		08.82	07.87													
	2.8	95		01.82	08.87													
	2.8	105		05.86	08.87													
	2.8	108		08.86	08.87													
	2.8	115		08.81	08.87													
	2.8	115		08.81	08.87													
	2.3	84		08.84	08.87		83.6134-0300.3	330725	2			L=300						
	2.3	119		01.88	07.92													
	2.3 T	134		09.87	10.88													
	2.4 D	60		09.87	07.92													
	2.4 TD	80		09.87	07.92													
	2.4 TD Intercooler	85		08.87	07.92													
	2.8	95		09.87	12.87													
	2.8	105		09.87	08.91													
	2.8	108		09.87	07.90													
	2.8	115		09.87	07.88													
2.8	125		09.87	08.90														

¹⁾ f.predec.13.2381-0067/-0068.2 / p.prece.13.2381-0067.2/-0068.2 / p.préd.13.2381-0067.2/-0068.2 / p.prede.13.2381-0067.2/-0068.2

²⁾ f.predec.13.2401-0023/-0024.2 / p.prece.13.2401-0023.2/-0024.2 / p.préd.13.2401-0023.2/-0024.2 / p.prede.13.2401-0023.2/-0024.2





VOLVO 760 Limousine (82-92)

	2.3 T	127		08.82	07.84	03.0137-0169.2	650169		160 x 25			
	2.3 T	134		08.84	08.87					03.0137-9065.2	669065	Bremsbacken-Zubehör
	2.4 D	60		01.82	08.87							
	2.4 TD	80		04.87	08.87							
	2.4 TD	82		08.82	07.87							
	2.8	95		01.82	08.87							
	2.8	105		05.86	08.87							
	2.8	108		08.86	08.87							
	2.8	115		08.81	08.87							
	2.3	84		08.84	08.87							
2.3	119		01.88	07.92	03.0137-9199.2	669199	Bremsbacken-Zubehör					
2.3 T	134		09.87	10.88								
2.4 D	60		09.87	07.92								
2.4 TD	80		09.87	07.92								
2.4 TD Intercooler	85		08.87	07.92								
2.8	95		09.87	12.87								
2.8	105		09.87	08.91								
2.8	108		09.87	07.90								
2.8	115		09.87	07.88								
2.8	125		09.87	08.90								
	2.3 T	127		08.82	07.84	24.3727-1306.2	581306	<input type="checkbox"/>	L=830			
	2.3 T	134		08.84	08.87							
	2.4 D	60		01.82	08.87							
	2.4 TD	80		04.87	08.87							
	2.4 TD	82		08.82	07.87							
	2.8	95		01.82	08.87							
	2.8	105		05.86	08.87							
	2.8	108		08.86	08.87							
	2.8	115		08.81	08.87							
	2.8	125		09.87	08.90							
	2.3 T	134		09.85	10.88	24.2419-0928.3	030056		Gz 19,05			
	2.4 TD	80		04.87	07.92							
	2.4 TD	82		09.85	07.87							
	2.4 TD Intercooler	85		08.87	07.92							
	2.8	95		01.82	12.87							
	2.8	105		05.86	08.91							
	2.8	108		08.86	07.90							
2.8	115		08.81	07.88								
2.8	125		09.87	08.90								
	2.3 T	134		09.85	10.88	03.2522-0420.3	040086		Nz 22,20			
	2.4 TD	80		04.87	07.92							
	2.4 TD	82		09.85	07.87							
	2.4 TD Intercooler	85		08.87	07.92							
	2.4 TD	◀ 80		04.87	07.92	24.3728-1301.2	591301		L=1100			
	2.4 TD	◀ 82		09.85	07.87							
	2.4 TD Intercooler	◀ 85		08.87	07.92							

VOLVO 760 Kombi (82-92)

	2.3	84		08.84	08.87 + ABS	03.2023-0164.3	010014		1Hz 23,81/19,05 + B.	ATE																		
	2.3 T	134		09.85	08.90 + ABS																							
	2.4 D	60		09.85	07.92 + ABS																							
	2.4 TD Intercooler	85		08.87	07.92																							
	2.8	95		05.86	12.87 + ABS																							
	2.8	105		05.86	08.91 + ABS																							
	2.8	115		08.86	08.90 + ABS																							
	2.3	84		08.84	08.87 - ABS	24.0101-3401.2	260043		Bremsattel-Zubehör	TRW																		
	2.3 T	134		08.84	08.87 - ABS																							
	2.4 D	60		09.84	08.87 - ABS																							
	2.8	95		05.86	08.87 - ABS																							
	2.8	105		05.86	08.87 - ABS																							
	2.8	115		08.86	08.87 - ABS																							
	2.4 D	60		01.82	08.84	13.0460-2943.2	602943		21266 17,0 /S	TRW																		
	2.3	84		08.84	08.87						13.0460-3914.2	603914	21233 16,7	BDX														
	2.3 T	134		09.85	08.90										13.0460-2943.2	602943	21266 17,0 /S	TRW										
	2.4 D	60		09.84	07.92														13.0460-0429.2	610429	Belagsatz-Zubehör	BDX						
	2.4 TD Intercooler	85		08.87	07.92																							
	2.8	95		05.86	12.87																							
	2.8	105		05.86	08.91																							
	2.8	115		08.86	08.90																							
		2.3	84		08.84																		08.87	24.0122-0217.2	422217	+ 14" Rad ¹⁾	263 22,0 20,0 V	
		2.3 T	134		08.84																		08.87					
2.4 D		60		09.84	08.87																							
2.8		95		05.86	08.87																							
2.8		105		05.86	08.87																							
2.8		115		08.86	08.87																							
	2.3 T	134		09.87	08.90	24.0122-0137.1	422137		287 22,0 20,0 V																			
	2.4 D	60		09.87	07.92																							
	2.4 TD Intercooler	85		08.87	07.92																							
	2.8	95		09.87	12.87																							
	2.8	105		09.87	08.91																							
	2.8	115		09.87	08.90																							
	2.3	84		08.84	08.87 - ABS	83.6134-0335.3	330277	4	L=335																			
	2.3 T	134		08.84	08.87 - ABS																							
	2.4 D	60		01.82	08.87 - ABS																							
	2.8	95		05.86	08.87 - ABS																							
	2.8	105		05.86	08.87 - ABS																							

¹⁾ + 14" wheel / + ruota 14" / + roue 14" / + rueda 14"

VOLVO 760 Kombi (82-92)											
	2.8	115		08.86	08.87	- ABS	83.6134-0335.3	330277	4	L=335	
	2.3	84		08.84	08.87	+ ABS	83.6124-0305.3	330723	2	L=305	
	2.3 T	134		09.85	08.87	+ ABS					
	2.4 D	60		09.85	08.87	+ ABS					
	2.8	95		05.86	08.87	+ ABS					
	2.8	105		05.86	08.87	+ ABS					
	2.8	115		08.86	08.87	+ ABS					
	2.3 T	134		09.87	08.90		83.6134-0335.3	330277	2	L=335	
	2.4 D	60		09.87	07.92						
	2.4 TD Intercooler	85		08.87	07.92						
	2.8	95		09.87	12.87						
	2.8	105		09.87	08.91						
	2.8	115		09.87	08.90						
	2.3	84		08.84	08.87		24.9236-0001.5	230005	<input type="checkbox"/>	D=36	ATE
	2.3 T	134		08.84	08.87		24.9236-0002.5	230006	<input type="checkbox"/>	D=36	ATE
	2.4 D	60		09.84	08.87		24.9238-0087.5	230035	<input type="checkbox"/>	D=38	ATE
	2.8	95		05.86	08.87		24.9238-0088.5	230036	<input type="checkbox"/>	D=38	ATE
	2.8	105		05.86	08.87		13.2401-0028.2	210046	<input type="checkbox"/>	D=40	ATE
	2.8	115		08.86	08.87		13.0441-3815.2	250069	<input type="checkbox"/>	D=38	ATE
							13.0441-3819.2	250072	<input type="checkbox"/>	D=38	ATE
							13.0441-4014.2	250079	<input type="checkbox"/>	D=38	ATE
	2.3 T	134		09.87	08.90		24.9238-0087.5	230035	<input type="checkbox"/>	D=38	ATE
	2.4 D	60		09.87	07.92		24.9238-0088.5	230036	<input type="checkbox"/>	D=38	ATE
	2.4 TD Intercooler	85		08.87	07.92		13.2401-0028.2	210046	<input type="checkbox"/>	D=40	ATE
	2.8	95		09.87	12.87		13.0441-3815.2	250069	<input type="checkbox"/>	D=38	ATE
	2.8	105		09.87	08.91		13.0441-3819.2	250072	<input type="checkbox"/>	D=38	ATE
	2.8	115		09.87	08.90		13.0441-4014.2	250079	<input type="checkbox"/>	D=38	ATE
	2.3	84		08.84	08.87		13.0460-3401.2	603401		20755 14,4	ATE
	2.3 T	134		08.84	08.87		13.0460-0088.2	610088		Belagsatz-Zubehör	ATE
	2.4 D	60		01.82	07.87						
	2.8	95		05.86	08.87						
	2.8	105		05.86	08.87						
	2.8	115		08.86	08.87						
	2.3 T	134		09.87	08.90		13.0460-2935.2	602935		21385 13,8 /S	TRW
	2.4 D	60		09.87	07.92						
	2.4 TD Intercooler	85		08.87	07.92						
	2.8	95		09.87	12.87						
	2.8	105		09.87	08.91						
	2.8	115		09.87	08.90						
	2.3	84		08.84	08.87		24.0110-0189.1	410189		281 9,6 8,4 +B	
	2.3 T	134		08.84	08.87						
	2.4 D	60		01.82	08.87						
	2.8	95		05.86	08.87						
	2.8	105		05.86	08.87						
	2.8	115		08.86	08.87						
	2.3 T	134		09.87	08.90		24.0110-0206.1	410206		265 10,0 8,0	
	2.4 D	60		09.87	07.92						
	2.4 TD Intercooler	85		08.87	07.92						
	2.8	95		09.87	12.87						
	2.8	105		09.87	08.91						
	2.8	115		09.87	08.90						
	2.3	84		08.84	08.87		83.6124-0305.3	330723	2	L=305	
	2.3 T	134		08.84	08.90						
	2.4 D	60		01.82	07.92						
	2.4 TD Intercooler	85		08.87	07.92						
	2.8	95		05.86	12.87						
	2.8	105		05.86	08.91						
	2.8	115		08.86	08.90						
	2.3	84		08.84	08.87		03.0137-0169.2	650169		160 x 25	
	2.3 T	134		08.84	08.90		03.0137-9065.2	669065		Bremsbacken-Zubehör	
	2.4 D	60		01.82	07.92						
	2.4 TD Intercooler	85		08.87	07.92						
	2.8	95		05.86	12.87						
	2.8	105		05.86	08.91						
	2.8	115		08.86	08.90						
	2.3	84	022134	08.84			24.3727-1306.2	581306	<input type="checkbox"/>	L=830	
	2.3 T	134	022134	08.84							
	2.4 D	60	022134	01.82							
	2.4 TD Intercooler	85	022134	08.87							
	2.8	95		05.86	12.87						
	2.8	105	022134	05.86							
	2.8	115	022134	08.86							
	2.3 T	134		09.85	08.90		24.2419-0928.3	030056		Gz 19,05	
	2.4 TD Intercooler	85		08.87	07.92						
	2.8	95		05.86	08.87						
	2.8	105		05.86	08.87						
	2.8	115		08.86	08.87						
	2.3 T	134		08.84	08.90		03.2522-0420.3	040086		Nz 22,20	
	2.4 TD Intercooler	85		08.87	07.92						

1) f.predec.13.2381-0067/-0068.2 / p.prece.13.2381-0067.2/-0068.2 / p.préd.13.2381-0067.2/-0068.2 / p.prede.13.2381-0067.2/-0068.2











































































2) f.predec.13.2401-0023/-0024.2 / p.prece.13.2401-0023.2/-0024.2 / p.préd.13.2401-0023.2/-0024.2 / p.prede.13.2401-0023.2/-0024.2





VOLVO 850 Limousine (91-96)

	2.0	◀ 93		08.94	08.95	03.0655-0003.2	370003			Wegsensor	ATE
	2.0	◀105		06.91	08.95						
	2.0 T	◀155		08.93	08.95						
	2.3 T5	◀166		08.93	08.95						
	2.3 T5 R	◀184		08.95	08.95						
	2.5	◀103		09.93	07.94						
	2.5	◀106		08.94	08.95						
	2.5	◀125		09.93	08.95						
	2.5 TDI	◀103		08.95	08.95						
	2.0	◀ 93		09.95	12.96	03.7760-3602.4	300176			10"	ATE
	2.0	◀105		09.95	12.96						
	2.0 T	◀155		09.95	12.96						
	2.3 T5	◀166		09.95	07.96						
	2.3 T5 R	◀184		09.95	12.96						
	2.5	◀106		09.95	12.96						
	2.5	◀125		09.95	12.96						
	2.5 TDI	◀103		09.95	12.96						
		2.0	▶ 93		08.94						
2.0		▶105		06.91	08.95						
2.0 T		▶155		08.93	08.95						
2.3 T5		▶166		08.93	08.95						
2.3 T5 R		▶184		08.95	08.95						
2.5		▶103		09.93	07.94						
2.5		▶106		08.94	08.95						
2.5		▶125		09.93	08.95						
2.5 TDI		▶103		08.95	08.95						
	2.0	◀ 93		08.94	08.95	10.6123-0445.3	010957			THz 23,81 - Behälter	ATE
	2.0	◀105		06.91	08.95						
	2.0 T	◀155		08.93	08.95						
	2.3 T5	◀166		08.93	08.95						
	2.3 T5 R	◀184		08.95	08.95						
	2.5	◀103		06.91	07.94						
	2.5	◀106		08.94	08.95						
	2.5	◀125		08.91	08.95						
	2.5 TDI	◀103		08.95	08.95						
	2.0	93		09.95	12.96	03.2023-1084.3	010591		- ASR	THz 23,81/20,64	ATE
	2.0	105		09.95	12.96						
	2.0 T	155		09.95	12.96						
	2.3 T5	166		09.95	07.96						
	2.3 T5 R	184		09.95	12.96						
	2.5	106		09.95	12.96						
	2.5	125		09.95	12.96						
	2.5 TDI	103		09.95	12.96						
		2.0	93		08.94						
2.0		105		06.91	12.96						
2.0 T		155		08.93	12.96						
2.3 T5		166		08.93	07.96						
2.3 T5 R		184		08.95	12.96						
2.5		103		06.91	07.94						
2.5		106		08.94	12.96						
2.5		125		08.91	12.96						
2.5 TDI		103		08.95	12.96						
	2.0	93		08.94	12.96	13.0460-7053.2	607053			21273 19,5 +/WE	ATE
	2.0	105		06.91	12.96						
	2.0 T	155		08.93	12.96						
	2.5	103		06.91	07.94						
	2.5	106		08.94	12.96						
	2.5	125		08.91	12.96						
	2.5 TDI	103		08.95	12.96						
	2.3 T5	166		08.93	07.96						
	2.3 T5 R	184		08.95	12.96						
	2.0	93		08.94	12.96	13.0460-7053.2	607053			21273 19,5 +/WE	ATE
	2.0	105		06.91	12.96						
	2.0 T	155		08.93	12.96						
	2.3 T5	166		08.93	07.96						
	2.3 T5 R	184		08.95	12.96						
	2.5	103		09.93	07.94						
	2.5	106		08.94	12.96						
	2.5	125		09.93	12.96						
	2.5 TDI	103		08.95	12.96						
	2.0	93		08.94	12.96	24.0126-0102.1	426102			280 26,0 23,0 V +B	
	2.0	105		06.91	12.96						
	2.0 T	155		08.93	12.96						
	2.3 T5	166		08.93	07.96						
	2.3 T5 R	184		08.95	12.96						
	2.5	103		09.93	07.94						
	2.5	106		08.94	12.96						
	2.5	125		09.93	12.96						
	2.5 TDI	103		08.95	12.96						
	2.5	103		06.91	08.93	24.0126-0101.1	426101			280 26,0 23,0 V	
	2.5	125		08.91	08.93						
	2.0	93		08.94	12.96	83.6134-0335.3	330277	2		L=335	
	2.0	105		06.91	12.96						
	2.0 T	155		08.93	12.96						
	2.3 T5	166		08.93	07.96						
	2.3 T5 R	184		08.95	12.96						
	2.5	103		06.91	07.94						
	2.5	106		08.94	12.96						
	2.5	125		08.91	12.96						
	2.5 TDI	103		08.95	12.96						
	2.0	93		08.94	12.96	24.0711-1146.1	360060	2	☐	Radsensor	
	2.0	105		06.91	12.96						
	2.0 T	155		08.93	12.96						
	2.3 T5	166		08.93	07.96						
	2.3 T5 R	184		08.95	12.96						

										
VOLVO 850 Limousine (91-96)										
	2.5 2.5 2.5 2.5 TDI	103 106 125 103		06.91 08.94 06.91 08.95	07.94 12.96 12.96 12.96	24.0711-1146.1	360060	2 	Radsensor	
	2.0 2.0 2.0 T 2.3 T5 2.3 T5 R 2.5 2.5 2.5 2.5 TDI 2.3 T5 R	93 105 155 166 184 103 106 125 103 184		08.94 06.91 08.93 08.93 08.95 06.91 08.94 08.91 08.95	12.96 12.96 12.96 07.96 12.96 07.94 12.96 12.96 12.96 12.96	13.2381-0097.2 13.2381-0098.2 24.9238-0097.5 24.9238-0098.5 13.0441-3815.2 13.0441-3819.2	210239 210240 230037 230038 250069 250072	         	D=38 D=38 D=38 D=38 Dichtungssatz Dichtungssatz	ATE ATE ATE ATE ATE ATE ATE ATE ATE ATE
	2.0 2.0 2.0 T 2.3 T5 2.3 T5 R 2.5 2.5 2.5 2.5 TDI	93 105 155 166 184 103 106 125 103		08.94 06.91 08.93 08.93 08.95 06.91 08.94 08.91 08.95	12.96 12.96 12.96 07.96 12.96 07.94 12.96 12.96 12.96	13.0460-3403.2 13.0460-0088.2	603403 610088	        	20755 14,4 /Zub Belagsatz-Zubehör	ATE ATE ATE ATE ATE ATE ATE ATE ATE ATE
	2.0 2.0 2.0 T 2.3 T5 2.3 T5 R 2.5 2.5 2.5 2.5 TDI	93 105 155 166 184 103 106 125 103		08.94 06.91 08.93 08.93 08.95 09.93 08.94 09.93 08.95	12.96 12.96 12.96 07.96 12.96 07.94 12.96 12.96 12.96	24.0110-0214.1	410214	        	295 9,6 8,4 +B	
	2.5 2.5	103 125		06.91 08.91	08.93 08.93	24.0110-0216.1	410216	 	295 9,6 8,4	
	2.0 2.0 2.0 T 2.3 T5 2.3 T5 R 2.5 2.5 2.5 2.5 TDI	93 105 155 166 184 103 106 125 103		08.94 06.91 08.93 08.93 08.95 06.91 08.94 08.91 08.95	12.96 12.96 12.96 07.96 12.96 07.94 12.96 12.96 12.96	24.5201-0204.3	331400	2 	L=204	
	2.0 2.0 2.0 T 2.3 T5 2.3 T5 R 2.5 2.5 2.5 2.5 TDI	93 105 155 166 184 103 106 125 103		08.94 06.91 08.93 08.93 08.95 09.93 08.94 09.93 08.95	12.96 12.96 12.96 07.96 12.96 07.94 12.96 12.96 12.96	24.0741-1105.1	360195	1 	Radsensor L=1220/1840	
	2.5 2.5	103 125		06.91 08.91	08.93 08.93	24.0721-1113.1	360193	2  	Radsensor	
	2.0 2.0 2.0 T 2.3 T5 2.3 T5 R 2.5 2.5 2.5 2.5 TDI	93 105 155 166 184 103 106 125 103		08.94 06.91 08.93 08.93 08.95 06.91 08.94 08.91 08.95	12.96 12.96 12.96 07.96 12.96 07.94 12.96 12.96 12.96	03.0137-0260.2 03.0137-9176.2	650260 669176	        	178 x 25 Bremsbacken-Zubehör	
	2.0 2.0 2.0 T 2.3 T5 2.3 T5 R 2.5 2.5 2.5 2.5 TDI	93 105 155 166 184 103 106 125 103		08.94 06.91 08.93 08.93 08.95 08.95 08.94 08.91 08.95	12.96 12.96 12.96 12.96 04.96 07.94 12.96 12.96 12.96	24.3727-1308.2	581308	2  	L=1670	
	2.0 2.0 2.0 T 2.3 T5 2.3 T5 R 2.5 2.5 2.5 2.5 TDI	93 105 155 166 184 103 106 125 103		08.94 06.91 08.93 08.93 08.95 06.91 08.94 08.91 08.95	08.95 08.95 08.95 08.95 08.95 07.94 08.95 08.95 08.95	03.6055-0430.3	320065	        	BR 5/25 (4)	ATE

¹⁾ f.predec.13.2381-0065/-0066.2 / p.prece.13.2381-0065.2/-0066.2 / p.préd.13.2381-0065.2/-0066.2 / p.prede.13.2381-0065.2/-0066.2



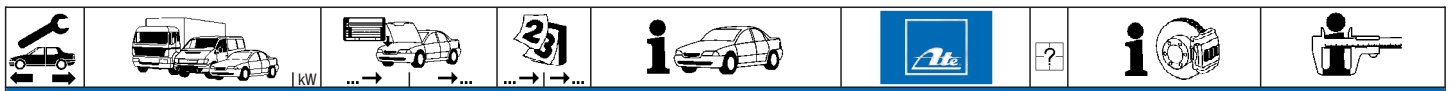

VOLVO 850 Limousine (91-96)

	2.0	◀ 93	08.94	12.96	24.2419-0939.3	030065			Gz 19,05
	2.0	◀105	06.91	12.96					
	2.0 T	◀155	08.93	12.96					
	2.3 T5	◀166	08.93	07.96					
	2.3 T5 R	◀184	08.95	12.96					
	2.5	◀103	06.91	07.94					
	2.5	◀106	08.94	12.96					
	2.5 TDI	◀103	08.91	12.96					
2.5 TDI	◀103	08.95	12.96						

VOLVO 850 Kombi (92-96)

	2.0	◀ 93	08.94	08.95	03.0655-0003.2	370003			Wegsensor	ATE
	2.0	◀105	02.93	08.95						
	2.0 T	◀155	02.93	08.95						
	2.3 T5	◀166	02.93	08.95						
	2.3 T5 R	◀184	08.95	08.95						
	2.5	◀103	09.93	07.94						
	2.5	◀106	08.94	08.95						
	2.5	◀125	09.93	08.95						
	2.5 TDI	◀103	08.95	08.95						
	2.5 TDI	◀103	08.95	08.95						
	2.0	◀ 93	09.95	12.96	03.7760-3602.4	300176			10"	ATE
	2.0	◀105	09.95	12.96						
	2.0 T	◀155	09.95	12.95						
	2.3 T5	◀166	09.95	12.96						
	2.3 T5 R	◀184	09.95	12.96						
	2.5	◀106	09.95	12.96						
	2.5	◀125	09.85	12.96						
	2.5 AWD	◀142	04.96	12.96						
	2.5 TDI	◀103	09.95	12.96						
	2.5 TDI	◀103	09.95	12.96						
	2.0	▶ 93	08.94	08.95	03.0655-0003.2	370003			Wegsensor	ATE
	2.0	▶105	02.93	08.95						
	2.0 T	▶155	02.93	08.95						
	2.3 T5	▶166	02.93	08.95						
	2.3 T5 R	▶184	08.95	08.95						
	2.5	▶103	09.93	07.94						
	2.5	▶106	08.94	08.95						
	2.5	▶125	09.93	08.95						
	2.5 TDI	▶103	08.95	08.95						
	2.5 TDI	▶103	08.95	08.95						
	2.0	93	08.94	08.95	10.6123-0445.3	010957			Thz 23,81 - Behälter	ATE
	2.0	105	02.93	08.95						
	2.0 T	155	02.93	08.95						
	2.3 T5	166	02.93	08.95						
	2.3 T5 R	184	08.95	08.95						
	2.5	103	08.92	07.94						
	2.5	106	08.94	08.95						
	2.5	125	09.92	08.95						
	2.5 TDI	103	08.95	08.95						
	2.5 TDI	103	08.95	08.95						
	2.0	93	09.95	12.96	03.2023-1084.3	010591		- ASR	Thz 23,81/20,64	ATE
	2.0	105	09.95	12.96						
	2.0 T	155	09.95	12.96						
	2.3 T5	166	09.95	12.96						
	2.3 T5 R	184	09.95	12.96						
	2.5	106	09.95	12.96						
	2.5 AWD	142	04.96	12.96						
	2.5 TDI	103	09.95	12.96						
	2.5 TDI	103	09.95	12.96						
	2.5 TDI	103	09.95	12.96						
	2.0	93	08.94	12.96	11.9571-9972.2	220606	<input type="checkbox"/>	D=57, - Halter	ATE	
	2.0	105	02.93	12.96						
	2.0 T	155	02.93	12.96						
	2.3 T5	166	02.93	12.96						
	2.3 T5 R	184	08.95	12.96						
	2.5	103	08.92	07.94						
	2.5	106	08.94	12.96						
	2.5	125	09.92	12.96						
	2.5 AWD	142	04.96	12.96						
	2.5 TDI	103	08.95	12.96						
2.5 TDI	103	08.95	12.96							
	2.0	93	08.94	12.96	13.0460-7053.2	607053			21273 19,5 +/WE	ATE
	2.0	105	02.93	12.96						
	2.0 T	155	02.93	12.96						
	2.5	103	08.92	07.94						
	2.5	106	08.94	12.96						
	2.5	125	09.92	12.96						
	2.5 AWD	142	04.96	12.96						
	2.5 TDI	103	08.95	12.96						
	2.5 TDI	103	08.95	12.96						
	2.5 TDI	103	08.95	12.96						
	2.3 T5	166	02.93	12.96	13.0460-7053.2	607053			21273 19,5 +/WE	ATE
	2.3 T5 R	184	08.95	12.96						



VOLVO 850 Kombi (92-96)

	2.0	93	08.94	12.96	24.0126-0102.1	426102			280 26,0 23,0 V +B
	2.0	105	02.93	12.96					
	2.0 T	155	02.93	12.96					
	2.3 T5	166	02.93	12.96					
	2.3 T5 R	184	08.95	12.96					
	2.5	103	09.93	07.94					
	2.5	106	08.94	12.96					
	2.5	125	08.93	12.96					
	2.5 AWD	142	04.96	12.96					
	2.5 TDI	103	08.95	12.96					
	2.5	103	08.92	08.93	24.0126-0101.1	426101			280 26,0 23,0 V
	2.5	125	09.92	08.93					
	2.0	93	08.94	12.96	83.6134-0335.3	330277	2		L=335
	2.0	105	02.93	12.96					
	2.0 T	155	02.93	12.96					
	2.3 T5	166	02.93	12.96					
	2.3 T5 R	184	08.95	12.96					
	2.5	103	08.92	07.94					
	2.5	106	08.94	12.96					
	2.5	125	09.92	12.96					
	2.5 AWD	142	04.96	12.96					
	2.5 TDI	103	08.95	12.96					
	2.0	93	08.94	12.96	24.0711-1146.1	360060	2		Radsensor
	2.0	105	02.93	12.96					
	2.0 T	155	02.93	12.96					
	2.3 T5	166	02.93	12.96					
	2.3 T5 R	184	08.95	12.96					
	2.5	103	08.92	07.94					
	2.5	106	08.94	12.96					
	2.5	125	09.92	12.96					
	2.5 AWD	142	04.96	12.96					
	2.5 TDI	103	08.95	12.96					
	2.0	93	08.94	12.96	13.2381-0097.2	210239	<input type="checkbox"/> <input type="checkbox"/> <input type="checkbox"/> <input type="checkbox"/> für Vorg. 13.2381-0065/-0066.2 ¹⁾	D=38 D=38 D=38 D=38 Dichtungssatz Dichtungssatz	ATE ATE ATE ATE ATE
	2.0	105	02.93	12.96					
	2.0 T	155	02.93	12.96					
	2.3 T5	166	02.93	12.96					
	2.3 T5 R	184	08.95	12.96					
	2.5	103	08.92	07.94					
	2.5	106	08.94	12.96					
	2.5	125	09.92	12.96					
	2.5 AWD	142	04.96	12.96					
	2.5 TDI	103	08.95	12.96					
	2.3 T5 R	184	08.95	12.96	13.2381-0097.2	210239	<input type="checkbox"/> <input type="checkbox"/>	D=38 D=38 Dichtungssatz	ATE ATE ATE
	2.0	93	08.94	12.96	13.0460-3403.2	603403			20755 14,4 /Zub Belagsatz-Zubehör
	2.0	105	02.93	12.96					
	2.0 T	155	02.93	12.96					
	2.3 T5	166	02.93	12.96					
	2.3 T5 R	184	08.95	12.96					
	2.5	103	08.92	07.94					
	2.5	106	08.94	12.96					
	2.5	125	09.92	12.96					
	2.5 TDI	103	08.95	12.96					
	2.5 AWD	142	04.96	12.96					
					13.0460-2935.2	602935			21385 13,8 /S
	2.0	93	08.94	12.96	24.0110-0214.1	410214			295 9,6 8,4 +B
	2.0	105	02.93	12.96					
	2.0 T	155	02.93	12.96					
	2.3 T5	166	02.93	12.96					
	2.3 T5 R	184	08.95	12.96					
	2.5	103	09.93	07.94					
	2.5	106	08.94	12.96					
	2.5	125	09.93	12.96					
	2.5 TDI	103	08.95	12.96					
	2.5 AWD	142	04.96	12.96					
	2.5	103	08.92	08.93	24.0110-0216.1	410216			295 9,6 8,4
	2.5	125	09.92	08.93					
	2.0	93	08.94	12.96	24.5201-0204.3	331400	2		L=204
	2.0	105	02.93	12.96					
	2.0 T	155	02.93	12.96					
	2.3 T5	166	02.93	12.96					
	2.3 T5 R	184	08.95	12.96					
	2.5	103	08.92	07.94					
	2.5	106	08.94	12.96					
	2.5	125	09.92	12.96					
	2.5 TDI	103	08.95	12.96					
	2.5 AWD	142	04.96	12.96					
					83.6134-0300.3	330725	2		L=300
	2.0	93	08.94	12.96	24.0741-1105.1	360195	1		Radsensor L=1220/1840
	2.0	105	02.93	12.96					
	2.0 T	155	02.93	12.96					
	2.3 T5	166	02.93	12.96					
	2.3 T5 R	184	08.95	12.96					
	2.5	103	09.93	07.94					
	2.5	106	08.94	12.96					
	2.5	125	09.93	12.96					
	2.5 TDI	103	08.95	12.96					
	2.5 AWD	142	04.96	12.96					

¹⁾ f.predec.13.2381-0065/-0066.2 / p.prece.13.2381-0065.2/-0066.2 / p.préd.13.2381-0065.2/-0066.2 / p.prede.13.2381-0065.2/-0066.2





VOLVO 850 Kombi (92-96)

	2.5 2.5	103 125		08.92 09.92	08.93 08.93		24.0721-1113.1	360193	2		Radsensor
	2.0 2.0 T 2.3 T5 2.3 T5 R 2.5 2.5 2.5 2.5 TDI 2.5 AWD	93 105 155 166 184 103 106 125 103 142		08.94 02.93 02.93 08.95 08.92 08.94 09.92 08.95 04.96	12.96 12.96 12.96 12.96 07.94 12.96 12.96 12.96 12.96		03.0137-0260.2 03.0137-9176.2	650260 669176			178 x 25 Bremsbacken-Zubehör
	2.0 2.0 2.0 T 2.3 T5 2.3 T5 R 2.5 2.5 2.5 2.5 TDI	93 105 155 166 184 103 106 125 103		08.94 02.93 02.93 08.95 08.92 08.94 09.92 08.95	12.96 12.96 12.96 12.96 12.96 07.94 12.96 12.96		24.3727-1308.2	581308	2		L=1670
	2.0 2.0 2.0 T 2.3 T5 2.3 T5 R 2.5 2.5 2.5 2.5 TDI	93 105 155 166 184 103 106 125 103		08.94 02.93 02.93 08.95 08.92 08.94 09.92 08.95	08.95 08.95 08.95 08.95 07.94 08.95 08.95 08.95		03.6055-0431.3	320142			BR 5/35 (4) ATE
	2.0 2.0 2.0 T 2.3 T5 2.3 T5 R 2.5 2.5 2.5 2.5 AWD 2.5 TDI	93 105 155 166 184 103 106 125 142 103		08.94 02.93 02.93 08.95 08.92 08.94 09.92 04.96 08.95	12.96 12.96 12.96 12.96 12.96 07.94 12.96 12.96 12.96		24.2419-0939.3	030065		- Rohrleitung ¹⁾	Gz 19,05
	2.0 2.0 2.0 T 2.3 T5 2.5 2.5 2.5 2.5 AWD 2.5 TDI	93 105 155 166 103 106 125 142 103		08.94 02.93 02.93 02.93 08.92 08.94 09.92 04.96 08.95	12.96 12.96 12.96 12.96 07.94 12.96 12.96 12.96 12.96		24.2522-0907.3	040043			Nz 22,20

VOLVO 940 I Limousine (90-95)

	2.0 T 2.3 2.3 2.3 T 2.3 T 2.4 D 2.4 TD 2.4 TD Intercooler	114 140 114 121 140 60 80 90		01.91 08.90 08.90 08.90 08.91 08.90 08.90 08.90	12.91 12.91 07.91 12.91 12.91 12.91 12.91 12.91	- ABS - ABS - ABS - ABS - ABS - ABS - ABS - ABS	03.2023-0503.3 03.3517-5100.1	010022 390326			THz 23,81/16,84 + B. Verschlusschraube	ATE ATE
	2.0 T 2.3 2.3 2.3 T 2.3 T 2.4 D 2.4 TD 2.4 TD Intercooler	114 114 114 121 140 60 80 90		01.91 08.90 08.90 08.90 08.91 08.90 08.90 08.90	12.91 12.91 07.91 12.91 12.91 12.91 12.91 12.91	+ ABS + ABS + ABS + ABS + ABS + ABS + ABS + ABS	03.2023-0164.3	010014			THz 23,81/19,05 + B.	ATE
	2.0 2.0 T 2.3 2.3 2.3 T 2.3 T 2.4 D 2.4 TD 2.4 TD Intercooler	82 114 85 121 140 60 80 90		01.92 01.92 01.92 01.92 01.92 01.92 01.92 01.92	07.94 07.95 12.94 07.94 07.94 07.93 12.94 12.94 12.94		03.2023-0875.3	010890			THz 23,81/20,64 - B.	ATE
	2.0 T 2.3 2.3 2.3 T 2.3 T 2.4 D 2.4 TD 2.4 TD Intercooler	114 114 114 121 140 60 80 90		01.91 08.90 08.90 08.90 08.91 08.90 08.90 08.90	12.91 12.91 07.91 12.91 12.91 12.91 12.91 12.91		24.3571-1707.5 24.3571-1708.5 24.0101-3401.2 24.0101-3601.2	240079 240080 260043 260044	<input checked="" type="checkbox"/> + ABS <input checked="" type="checkbox"/> + ABS <input type="checkbox"/> - ABS <input type="checkbox"/> + ABS		D=57, - Halter D=57, - Halter Bremsattel-Zubehör Bremsattel-Zubehör	TRW TRW TRW TRW

¹⁾ - pipe line / - tubazione / - conduite rigide / - latiguillo

VOLVO 940 I Limousine (90-95)									
	2.0	82		01.92	07.94	24.3571-1707.5	240079	D=57, - Halter D=57, - Halter Bremsattel-Zubehör	TRW
	2.0 T	114		01.92	07.95	24.3571-1708.5	240080		TRW
	2.3			01.92	12.94	24.0101-3601.2	260044		TRW
	2.3	85		08.92	07.94				
	2.3 T	121		01.92	07.94				
	2.3 T	140		01.92	07.93				
	2.4 D	60		01.92	12.94				
	2.4 TD	80		01.92	12.94				
	2.4 TD Intercooler	90		01.92	12.94				
	2.0 T	114		01.91	12.91	13.0460-3914.2	603914	- ABS	21233 16,7
	2.3			08.90	12.91	13.0460-2943.2	602943	- ABS	21266 17,0 /S
	2.3	114		08.90	07.91	13.0460-2985.2	602985	+ ABS	20164 18,2
	2.3 T	121		08.90	12.91	13.0460-0429.2	610429		Belagsatz-Zubehör
	2.3 T	140		08.91	12.91				BDX
	2.4 D	60		08.90	12.91				TRW
	2.4 TD	80		08.90	12.91				BDX
	2.4 TD Intercooler	90		08.90	12.91				
	2.0	82		01.92	07.94	13.0460-3914.2	603914		21233 16,7
	2.0 T	114		01.92	07.95	13.0460-2985.2	602985		20164 18,2
	2.3			01.92	12.94	13.0460-0429.2	610429		Belagsatz-Zubehör
	2.3	85		08.92	07.94				BDX
	2.3 T	121		01.92	07.94				TRW
	2.3 T	140		01.92	07.93				BDX
	2.4 D	60		01.92	12.94				
	2.4 TD	80		01.92	12.94				
	2.4 TD Intercooler	90		01.92	12.94				
	2.0 T	114		01.91	12.91	24.0122-0137.1	422137	- ABS	287 22,0 20,0 V
	2.3			08.90	12.91	24.0126-0105.1	426105	+ ABS	280 26,0 23,0 V +B
	2.3	114		08.90	07.91				
	2.3 T	121		08.90	12.91				
	2.3 T	140		08.91	12.91				
	2.4 D	60		08.90	12.91				
	2.4 TD	80		08.90	12.91				
	2.4 TD Intercooler	90		08.90	12.91				
	2.0	82		01.92	07.94	24.0126-0105.1	426105		280 26,0 23,0 V +B
	2.0 T	114		01.92	07.95				
	2.3			01.92	12.94				
	2.3	85		08.92	07.94				
	2.3 T	121		01.92	07.94				
	2.3 T	140		01.92	07.93				
	2.4 D	60		01.92	12.94				
	2.4 TD	80		01.92	12.94				
	2.4 TD Intercooler	90		01.92	12.94				
	2.0 T	114		01.91	12.91	83.6134-0335.3	330277	2	L=335
	2.3			08.90	12.91				
	2.3	114		08.90	07.91				
	2.3 T	121		08.90	12.91				
	2.3 T	140		08.91	12.91				
	2.4 D	60		08.90	12.91				
	2.4 TD	80		08.90	12.91				
	2.4 TD Intercooler	90		08.90	12.91				
	2.0	82		01.92	07.94	83.6134-0335.3	330277	2	L=335
	2.0 T	114		01.91	12.91				
	2.0 T	114		01.92	07.95				
	2.3			08.90	12.91				
	2.3	85		01.92	12.94				
	2.3	114		08.92	07.94				
	2.3	114		08.90	07.91				
	2.3 T	121		08.90	12.91				
	2.3 T	121		01.92	07.94				
	2.3 T	140		08.91	12.91				
	2.3 T	140		01.92	07.93				
	2.4 D	60		08.90	12.91				
	2.4 D	60		01.92	12.94				
	2.4 TD	80		08.90	12.91				
	2.4 TD	80		01.92	12.94				
	2.4 TD Intercooler	90		08.90	12.91				
	2.4 TD Intercooler	90		01.92	12.94				
	2.0	82		01.92	07.94	24.9238-0087.5	230035	für 13.2381-0087/-0088.2 ²⁾ für 13.2401-0027/-0028.2 ³⁾	D=38
	2.0 T	114		01.91	07.95	24.9238-0088.5	230036		D=38
	2.3			08.90	12.94	13.2401-0028.2	210046		D=40
	2.3	85		08.92	07.94	13.0441-3815.2	250069		Dichtungssatz
	2.3	114		08.90	07.91	13.0441-3819.2	250072		Dichtungssatz
	2.3 T	121		08.90	07.94	13.0441-4014.2	250079		Dichtungssatz
	2.3 T	140		08.91	07.93				
	2.4 D	60		08.90	12.94				
	2.4 TD	80		08.90	12.94				
	2.4 TD Intercooler	90		08.90	12.94				
	2.0	82		01.92	07.94	13.0460-3401.2	603401		
	2.0 T	114		01.91	07.95	13.0460-0088.2	610088		Belagsatz-Zubehör
	2.3			08.90	12.94				ATE
	2.3	85		08.92	07.94				ATE
	2.3	114		08.90	07.91				ATE
	2.3 T	121		08.90	07.94				ATE
	2.3 T	140		08.91	07.93				ATE
	2.4 D	60		08.90	12.94				
	2.4 D	60		08.90	12.94				

1) - multi link axle / - assale Multi-link / - essieu multi-link / - eje Multi-Link
2) for 13.2381-0087/-0088.2 / per 13.2381-0087/-0088.2 / pour 13.2381-0087/-0088.2 / para 13.2381-0087/-0088.2
3) for 13.2401-0027/-0028.2 / per 13.2401-0027/-0028.2 / pour 13.2401-0027/-0028.2 / para 13.2401-0027/-0028.2



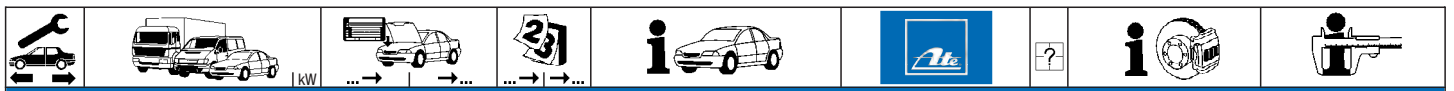















VOLVO 940 I Limousine (90-95)

	2.4 TD	80	08.90	12.94	- Multi-Link-Achse ¹⁾	13.0460-3401.2	603401		20755 14,4	ATE
	2.4 TD Intercooler	90	08.90	12.94	- Multi-Link-Achse ¹⁾	13.0460-0088.2	610088		Belagsatz-Zubehör	ATE
	2.0	82	01.92	07.94	+ Multi-Link-Achse ²⁾	13.0460-2935.2	602935		21385 13,8 /S	TRW
	2.0 T	114	01.91	07.95	+ Multi-Link-Achse ²⁾					
	2.3		08.90	12.94	+ Multi-Link-Achse ²⁾					
	2.3	85	08.92	07.94	+ Multi-Link-Achse ²⁾					
	2.3	114	08.90	07.91	+ Multi-Link-Achse ²⁾					
	2.3 T	121	08.90	07.94	+ Multi-Link-Achse ²⁾					
	2.3 T	140	08.91	07.93	+ Multi-Link-Achse ²⁾					
	2.4 D	60	08.90	12.94	+ Multi-Link-Achse ²⁾					
2.4 TD	80	08.90	12.94	+ Multi-Link-Achse ²⁾						
2.4 TD Intercooler	90	08.90	12.94	+ Multi-Link-Achse ²⁾						
	2.0	82	01.92	07.94	- Multi-Link-Achse ¹⁾	24.0110-0189.1	410189		281 9,6 8,4 +B	
	2.0 T	114	01.91	07.95	- Multi-Link-Achse ¹⁾					
	2.3		08.90	12.94	- Multi-Link-Achse ¹⁾					
	2.3	85	08.92	07.94	- Multi-Link-Achse ¹⁾					
	2.3	114	08.90	07.91	- Multi-Link-Achse ¹⁾					
	2.3 T	121	08.90	07.94	- Multi-Link-Achse ¹⁾					
	2.3 T	140	08.91	07.93	- Multi-Link-Achse ¹⁾					
	2.4 D	60	08.90	12.94	- Multi-Link-Achse ¹⁾					
	2.4 TD	80	08.90	12.94	- Multi-Link-Achse ¹⁾					
	2.4 TD Intercooler	90	08.90	12.94	- Multi-Link-Achse ¹⁾					
	2.0	82	01.92	07.94	+ Multi-Link-Achse ²⁾	24.0110-0206.1	410206		265 10,0 8,0	
	2.0 T	114	01.91	07.95	+ Multi-Link-Achse ²⁾					
	2.3		08.90	12.94	+ Multi-Link-Achse ²⁾					
	2.3	85	08.92	07.94	+ Multi-Link-Achse ²⁾					
	2.3	114	08.90	07.91	+ Multi-Link-Achse ²⁾					
	2.3 T	121	08.90	07.94	+ Multi-Link-Achse ²⁾					
	2.3 T	140	08.91	07.93	+ Multi-Link-Achse ²⁾					
	2.4 D	60	08.90	12.94	+ Multi-Link-Achse ²⁾					
	2.4 TD	80	08.90	12.94	+ Multi-Link-Achse ²⁾					
	2.4 TD Intercooler	90	08.90	12.94	+ Multi-Link-Achse ²⁾					
	2.0	82	01.92	07.94		83.6124-0305.3	330723	2	L=305	
	2.0 T	114	01.91	07.95						
	2.3		08.90	12.94						
	2.3	85	08.92	07.94						
	2.3	114	08.90	07.91						
	2.3 T	121	08.90	07.94						
	2.3 T	140	08.91	07.93						
	2.4 D	60	08.90	12.94						
	2.4 TD	80	08.90	12.94						
	2.4 TD Intercooler	90	08.90	12.94						
	2.0	82	01.92	07.94	- Multi-Link-Achse ¹⁾	03.0137-0169.2	650169		160 x 25	
	2.0 T	114	01.91	07.95	- Multi-Link-Achse ¹⁾	03.0137-9065.2	669065		Bremsbacken-Zubehör	
	2.3		08.90	12.94	- Multi-Link-Achse ¹⁾					
	2.3	85	08.92	07.94	- Multi-Link-Achse ¹⁾					
	2.3	114	08.90	07.91	- Multi-Link-Achse ¹⁾					
	2.3 T	121	08.90	07.94	- Multi-Link-Achse ¹⁾					
	2.3 T	140	08.91	07.93	- Multi-Link-Achse ¹⁾					
	2.4 D	60	08.90	12.94	- Multi-Link-Achse ¹⁾					
	2.4 TD	80	08.90	12.94	- Multi-Link-Achse ¹⁾					
	2.4 TD Intercooler	90	08.90	12.94	- Multi-Link-Achse ¹⁾					
	2.0	82	01.92	07.94	+ Multi-Link-Achse ²⁾	03.0137-0299.2	650299		160 x 25	
	2.0 T	114	01.91	07.95	+ Multi-Link-Achse ²⁾	03.0137-9199.2	669199		Bremsbacken-Zubehör	
	2.3		08.90	12.94	+ Multi-Link-Achse ²⁾					
	2.3	85	08.92	07.94	+ Multi-Link-Achse ²⁾					
	2.3	114	08.90	07.91	+ Multi-Link-Achse ²⁾					
	2.3 T	121	08.90	07.94	+ Multi-Link-Achse ²⁾					
	2.3 T	140	08.91	07.93	+ Multi-Link-Achse ²⁾					
	2.4 D	60	08.90	12.94	+ Multi-Link-Achse ²⁾					
	2.4 TD	80	08.90	12.94	+ Multi-Link-Achse ²⁾					
	2.4 TD Intercooler	90	08.90	12.94	+ Multi-Link-Achse ²⁾					
	2.0	82	01.92	07.94		03.6055-0430.3	320065		BR 5/25 (4)	ATE
	2.0 T	114	01.91	07.95						
	2.3		08.90	12.94						
	2.3	85	08.92	07.94						
	2.3	114	08.90	07.91						
	2.3 T	121	08.90	07.94						
	2.3 T	140	08.91	07.93						
	2.4 D	60	08.90	12.94						
	2.4 TD	80	08.90	12.94						
	2.4 TD Intercooler	90	08.90	12.94						
	2.0	82	01.92	07.94		24.2419-0941.3	030067		Gz 19,05	
	2.0 T	114	01.91	07.95						
	2.3		08.90	12.94						
	2.3	85	08.92	07.94						
	2.3	114	08.90	07.91						
	2.4 D	60	08.90	12.94						
	2.3 T	121	08.90	07.94		24.2419-0928.3	030056		Gz 19,05	
	2.3 T	140	08.91	07.93						
	2.4 TD	80	08.90	12.94						
	2.4 TD Intercooler	90	08.90	12.94						

¹⁾ - multi link axle / - assale Multi-link / - essieu multi-link / - eje Multi-Link
²⁾ + multi link axle / + assale Multi-link / + essieu multi-link / + eje Multi-Link

											
VOLVO 940 I Limousine (90-95)											
	2.0	82		01.92	07.94		24.2520-0905.3	040057		Nz 20,64	
	2.0 T	114		08.90	12.91	- ABS					
	2.3			08.90	12.94						
	2.3	85		08.92	07.94						
	2.3	114		08.90	07.91						
	2.4 D	60		08.90	12.94						
	2.3 T	121		08.90	07.94		03.2522-0420.3	040086		Nz 22,20	
	2.3 T	140		08.91	07.93						
	2.4 TD	80		08.90	12.94						
	2.4 TD Intercooler	90		08.90	12.94						
VOLVO 940 I Kombi (90-95)											
	2.0 T	114		01.91	12.91	- ABS	03.2023-0503.3	010022		THz 23,81/16,84 + B. ATE	
	2.3	96		08.90	12.91	- ABS	03.3517-5100.1	390326		Verschlußschraube ATE	
	2.3	114		08.90	07.91	- ABS					
	2.3 T	121		08.90	12.91	- ABS					
	2.3 T	140		08.91	12.91	- ABS					
	2.4 D	60		08.90	12.91	- ABS					
	2.4 TD	80		08.90	12.91	- ABS					
	2.4 TD Intercooler	90		08.90	12.91	- ABS					
		2.0 T	114		01.91	12.91	+ ABS	03.2023-0164.3	010014		THz 23,81/19,05 + B. ATE
		2.3	96		08.90	12.91	+ ABS				
2.3		114		08.90	07.91	+ ABS					
2.3 T		121		08.90	12.91	+ ABS					
2.3 T		140		08.91	12.91	+ ABS					
2.4 D		60		08.90	12.91	+ ABS					
2.4 TD		80		08.90	12.91	+ ABS					
2.4 TD Intercooler		90		08.90	12.91	+ ABS					
		2.0	82		01.92	07.94		03.2023-0875.3	010890		THz 23,81/20,64 - B. ATE
		2.0 T	114		01.92	07.95					
	2.3	85		08.92	07.94						
	2.3	96		01.92	07.94						
	2.3 T	121		01.92	07.94						
	2.3 T	140		01.92	07.93						
	2.4 D	60		01.92	07.95						
	2.4 TD	80		01.92	07.94						
	2.4 TD Intercooler	90		01.92	07.94						
		2.0 T	114		01.91	12.91		24.3571-1707.5	240079	<input type="checkbox"/> + ABS	D=57, - Halter TRW
2.3		96		08.90	12.91		24.3571-1708.5	240080	<input type="checkbox"/> + ABS	D=57, - Halter TRW	
2.3		114		08.90	07.91		24.0101-3401.2	260043	- ABS	Bremssattel-Zubehör TRW	
2.3 T		121		08.90	12.91		24.0101-3601.2	260044	+ ABS	Bremssattel-Zubehör TRW	
2.3 T		140		08.91	12.91						
2.4 D		60		08.90	12.91						
2.4 TD		80		08.90	12.91						
2.4 TD Intercooler		90		08.90	12.91						
		2.0 T	114		01.91	12.91		13.0460-3914.2	603914	- ABS	21233 16,7 BDX
		2.3	96		08.90	12.91		13.0460-2943.2	602943	- ABS	21266 17,0 /S TRW
	2.3	114		08.90	07.91		13.0460-2985.2	602985	+ ABS	20164 18,2 TRW	
	2.3 T	121		08.90	12.91		13.0460-0429.2	610429	- ABS	Belagsatz-Zubehör BDX	
	2.3 T	140		08.91	12.91						
	2.4 D	60		08.90	12.91						
	2.4 TD	80		08.90	12.91						
	2.4 TD Intercooler	90		08.90	12.91						
		2.0	82		01.92	07.94		13.0460-3914.2	603914	- ABS	21233 16,7 BDX
		2.0 T	114		01.92	07.95		13.0460-2943.2	602943	- ABS	21266 17,0 /S TRW
2.3		85		08.92	07.94		13.0460-0429.2	610429		Belagsatz-Zubehör BDX	
2.3		96		01.92	07.94		13.0460-2985.2	602985	+ ABS	20164 18,2 TRW	
2.3 T		121		01.92	07.94						
2.3 T		140		01.92	07.93						
2.4 D		60		01.92	07.95						
2.4 TD		80		01.92	07.94						
2.4 TD Intercooler		90		01.92	07.94						
		2.0	82		01.92	12.92		24.0122-0137.1	422137	- ABS	287 22,0 20,0 V
	2.0 T	114		01.91	12.91		24.0126-0105.1	426105	+ ABS	280 26,0 23,0 V +B	
	2.3	96		08.90	12.91						
	2.3	114		08.90	07.91						
	2.3 T	121		08.90	12.91						
	2.3 T	140		08.91	12.91						
	2.4 D	60		08.90	12.91						
	2.4 TD	80		08.90	12.91						
	2.4 TD Intercooler	90		08.90	12.91						
		2.0	82		01.93	07.94		24.0126-0105.1	426105	+ ABS	280 26,0 23,0 V +B
2.0 T		114		01.92	07.95						
2.3		85		08.92	07.94						
2.3		96		01.92	07.94						
2.3 T		121		01.92	07.94						
2.3 T		140		01.92	07.93						
2.4 D		60		01.92	07.95						
2.4 TD		80		01.92	07.94						
2.4 TD Intercooler		90		01.92	07.94						
		2.0 T	114		01.91	12.91	- ABS	83.6134-0335.3	330277	2	L=335
	2.3	96		08.90	12.91	- ABS					
	2.3	114		08.90	07.91	- ABS					
	2.3 T	121		08.90	12.91	- ABS					
	2.3 T	140		08.91	12.91	- ABS					
	2.4 D	60		08.90	12.91	- ABS					













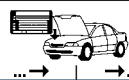









VOLVO 940 I Kombi (90-95)













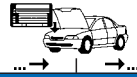













	2.4 TD	80	08.90	12.91	- ABS	83.6134-0335.3	330277	2		L=335										
	2.4 TD Intercooler	90	08.90	12.91	- ABS															
	2.0	82	01.92	07.94		83.6134-0335.3	330277	2				L=335								
	2.0 T	114	01.91	12.91	+ ABS															
	2.0 T	114	01.92	07.95																
	2.3	85	08.92	07.94	+ ABS															
	2.3	96	08.90	12.91	+ ABS															
	2.3	96	01.92	07.94																
	2.3	114	08.90	07.91	+ ABS															
	2.3 T	121	08.90	12.91	+ ABS															
	2.3 T	121	01.92	07.94																
	2.3 T	140	08.91	12.91	+ ABS															
	2.3 T	140	01.92	07.93																
	2.4 D	60	08.90	12.91	+ ABS															
	2.4 D	60	01.92	07.95																
	2.4 TD	80	08.90	12.91	+ ABS															
2.4 TD	80	01.92	07.94																	
2.4 TD Intercooler	90	08.90	12.91	+ ABS																
2.4 TD Intercooler	90	01.92	07.94																	
	2.0	82	01.92	07.94	- Multi-Link-Achse 1)	24.9238-0087.5	230035	für 13.2381-0087/-0088.2 2)	D=38	ATE										
	2.0 T	114	01.91	07.95	- Multi-Link-Achse 1)						24.9238-0088.5	230036	D=38	ATE						
	2.3	85	08.92	07.94	- Multi-Link-Achse 1)						13.2401-0028.2	210046	D=40	ATE						
	2.3	96	08.90	07.94	- Multi-Link-Achse 1)						13.0441-3815.2	250069	Dichtungssatz	ATE						
	2.3	114	08.90	07.91	- Multi-Link-Achse 1)						13.0441-3819.2	250072	Dichtungssatz	ATE						
	2.3 T	121	08.90	07.94	- Multi-Link-Achse 1)						13.0441-4014.2	250079	für 13.2401-0027/-0028.2 3)	Dichtungssatz	ATE					
	2.3 T	140	08.91	07.93	- Multi-Link-Achse 1)															
	2.4 D	60	08.90	07.95	- Multi-Link-Achse 1)															
	2.4 TD	80	08.90	07.94	- Multi-Link-Achse 1)															
	2.4 TD Intercooler	90	08.90	07.94	- Multi-Link-Achse 1)															
		2.0	82	01.92	07.94						- Multi-Link-Achse 1)	13.0460-3401.2	603401		20755 14,4	ATE				
		2.0 T	114	01.91	07.95						- Multi-Link-Achse 1)						13.0460-0088.2	610088	Belagsatz-Zubehör	ATE
		2.3	85	08.92	07.94						- Multi-Link-Achse 1)									
		2.3	96	08.90	07.94						- Multi-Link-Achse 1)									
		2.3	114	08.90	07.91						- Multi-Link-Achse 1)									
		2.3 T	121	08.90	07.94						- Multi-Link-Achse 1)									
2.3 T		140	08.91	07.93	- Multi-Link-Achse 1)															
2.4 D		60	08.90	07.95	- Multi-Link-Achse 1)															
2.4 TD		80	08.90	07.94	- Multi-Link-Achse 1)															
2.4 TD Intercooler		90	08.90	07.94	- Multi-Link-Achse 1)															
		2.0	82	01.92	07.94	+ Multi-Link-Achse 4)	13.0460-2935.2	602935		21385 13,8 /S	TRW									
		2.0 T	114	01.91	07.95	+ Multi-Link-Achse 4)														
		2.3	85	08.92	07.94	+ Multi-Link-Achse 4)														
		2.3	96	08.90	07.94	+ Multi-Link-Achse 4)														
		2.3	114	08.90	07.91	+ Multi-Link-Achse 4)														
		2.3 T	121	08.90	07.94	+ Multi-Link-Achse 4)														
	2.3 T	140	08.91	07.93	+ Multi-Link-Achse 4)															
	2.4 D	60	08.90	07.95	+ Multi-Link-Achse 4)															
	2.4 TD	80	08.90	07.94	+ Multi-Link-Achse 4)															
	2.4 TD Intercooler	90	08.90	07.94	+ Multi-Link-Achse 4)															
		2.0	82	01.92	07.94	- Multi-Link-Achse 1)						24.0110-0189.1	410189		281 9,6 8,4 +B					
		2.0 T	114	01.91	07.95	- Multi-Link-Achse 1)														
		2.3	85	08.92	07.94	- Multi-Link-Achse 1)														
		2.3	96	08.90	07.94	- Multi-Link-Achse 1)														
		2.3	114	08.90	07.91	- Multi-Link-Achse 1)														
		2.3 T	121	08.90	07.94	- Multi-Link-Achse 1)														
2.3 T		140	08.91	07.93	- Multi-Link-Achse 1)															
2.4 D		60	08.90	07.95	- Multi-Link-Achse 1)															
2.4 TD		80	08.90	07.94	- Multi-Link-Achse 1)															
2.4 TD Intercooler		90	08.90	07.94	- Multi-Link-Achse 1)															
		2.0	82	01.92	07.94	+ Multi-Link-Achse 4)	24.0110-0206.1	410206		265 10,0 8,0										
		2.0 T	114	01.91	07.95	+ Multi-Link-Achse 4)														
		2.3	85	08.92	07.94	+ Multi-Link-Achse 4)														
		2.3	96	08.90	07.94	+ Multi-Link-Achse 4)														
		2.3	114	08.90	07.91	+ Multi-Link-Achse 4)														
		2.3 T	121	08.90	07.94	+ Multi-Link-Achse 4)														
	2.3 T	140	08.91	07.93	+ Multi-Link-Achse 4)															
	2.4 D	60	08.90	07.95	+ Multi-Link-Achse 4)															
	2.4 TD	80	08.90	07.94	+ Multi-Link-Achse 4)															
	2.4 TD Intercooler	90	08.90	07.94	+ Multi-Link-Achse 4)															
		2.0	82	01.92	07.94							83.6124-0305.3	330723	2		L=305				
		2.0 T	114	01.91	07.95															
		2.3	85	08.92	07.94															
		2.3	96	08.90	07.94															
		2.3	114	08.90	07.91															
		2.3 T	121	08.90	07.94															
2.3 T		140	08.91	07.93																
2.4 D		60	08.90	07.95																
2.4 TD		80	08.90	07.94																
2.4 TD Intercooler		90	08.90	07.94																
		2.0	82	01.92	07.94	- Multi-Link-Achse 1)	03.0137-0169.2	650169		160 x 25	Bremsbacken-Zubehör									
		2.0 T	114	01.91	07.95	- Multi-Link-Achse 1)											03.0137-9065.2	669065		
		2.3	85	08.92	07.94	- Multi-Link-Achse 1)														
		2.3	96	08.90	07.94	- Multi-Link-Achse 1)														
		2.3	114	08.90	07.91	- Multi-Link-Achse 1)														
		2.3 T	121	08.90	07.94	- Multi-Link-Achse 1)														
	2.3 T	140	08.91	07.93	- Multi-Link-Achse 1)															

1) - multi link axle / - assale Multi-link / - essieu multi-link / - eje Multi-Link
 2) for 13.2381-0087/-0088.2 / per 13.2381-0087/-0088.2 / pour 13.2381-0087/-0088.2 / para 13.2381-0087/-0088.2
 3) for 13.2401-0027/-0028.2 / per 13.2401-0027/-0028.2 / pour 13.2401-0027/-0028.2 / para 13.2401-0027/-0028.2
 4) + multi link axle / + assale Multi-link / + essieu multi-link / + eje Multi-Link

									
VOLVO 940 I Kombi (90-95)									
	2.4 D	60	08.90	07.95	- Multi-Link-Achse ¹⁾	03.0137-0169.2	650169		160 x 25
	2.4 TD	80	08.90	07.94	- Multi-Link-Achse ¹⁾	03.0137-9065.2	669065		Bremsbacken-Zubehör
	2.4 TD Intercooler	90	08.90	07.94	- Multi-Link-Achse ¹⁾				
	2.0	82	01.92	07.94	+ Multi-Link-Achse ²⁾	03.0137-0299.2	650299		160 x 25
	2.0 T	114	01.91	07.95	+ Multi-Link-Achse ²⁾	03.0137-9199.2	669199		Bremsbacken-Zubehör
	2.3	85	08.92	07.94	+ Multi-Link-Achse ²⁾				
	2.3	96	08.90	07.94	+ Multi-Link-Achse ²⁾				
	2.3	114	08.90	07.91	+ Multi-Link-Achse ²⁾				
	2.3 T	121	08.90	07.94	+ Multi-Link-Achse ²⁾				
	2.3 T	140	08.91	07.93	+ Multi-Link-Achse ²⁾				
2.4 D	60	08.90	07.95	+ Multi-Link-Achse ²⁾					
2.4 TD	80	08.90	07.94	+ Multi-Link-Achse ²⁾					
2.4 TD Intercooler	90	08.90	07.94	+ Multi-Link-Achse ²⁾					
	2.0	82	01.92	07.94		03.6055-0431.3	320142		BR 5/35 (4)
	2.0 T	114	01.91	07.95					ATE
	2.3	85	08.92	07.94					
	2.3	96	08.90	07.94					
	2.3	114	08.90	07.91					
	2.3 T	121	08.90	07.94					
	2.3 T	140	08.91	07.93					
	2.4 D	60	08.90	07.95					
	2.4 TD	80	08.90	07.94					
	2.4 TD Intercooler	90	08.90	07.94					
	2.0	82	01.92	07.94		24.2419-0941.3	030067		Gz 19,05
	2.0 T	114	01.91	07.95					
	2.3	85	08.92	07.94					
	2.3	96	08.90	07.94					
	2.3	114	08.90	07.91					
	2.4 D	60	08.90	07.95					
	2.3 T	121	08.90	07.94		24.2419-0928.3	030056		Gz 19,05
	2.3 T	140	08.91	07.93					
	2.4 TD	80	08.90	07.94					
	2.4 TD Intercooler	90	08.90	07.94					
	2.0	82	01.92	07.94		24.2520-0905.3	040057		Nz 20,64
	2.0 T	114	01.91	07.95					
	2.3	85	08.92	07.94					
	2.3	96	08.90	07.94					
	2.3	114	08.90	07.91					
	2.4 D	60	08.90	07.95					
	2.3 T	121	08.90	07.94		03.2522-0420.3	040086		Nz 22,20
	2.3 T	140	08.91	07.93					
	2.4 TD	80	08.90	07.94					
	2.4 TD Intercooler	90	08.90	07.94					
VOLVO 960 I Limousine (90-94)									
	2.0	103	09.90	12.91		03.2023-0164.3	010014		THz 23,81/19,05 + B. ATE
	2.0	140	08.90	12.91					
	2.4 TD Intercooler	85	09.91	12.91					
	2.9	150	08.90	12.91					
	2.0	103	01.92	08.93		03.2023-0875.3	010890		THz 23,81/20,64 - B. ATE
2.0	140	01.92	09.93						
2.4 TD Intercooler	85	01.92	07.94						
2.9	150	01.92	07.94						
	2.0	103	09.90	08.93		24.3571-1707.5	240079	<input type="checkbox"/>	D=57, - Halter TRW
	2.0	140	08.90	09.93		24.3571-1708.5	240080	<input type="checkbox"/>	D=57, - Halter TRW
	2.4 TD Intercooler	85	09.91	07.94		24.0101-3601.2	260044		Bremssattel-Zubehör TRW
	2.9	150	08.90	07.94					
	2.0	103	09.90	08.93		13.0460-2985.2	602985		20164 18,2 TRW
2.0	140	08.90	09.93						
2.4 TD Intercooler	85	09.91	07.94						
2.9	150	08.90	07.94						
	2.0	103	09.90	08.93		24.0126-0105.1	426105		280 26,0 23,0 V +B
	2.0	140	08.90	09.93					
	2.4 TD Intercooler	85	09.91	07.94					
	2.9	150	08.90	07.94					
	2.0	103	09.90	08.93		83.6134-0335.3	330277	2	L=335
2.0	140	08.90	09.93						
2.4 TD Intercooler	85	09.91	07.94						
2.9	150	08.90	07.94						
	2.0	103	09.90	08.93	- Multi-Link-Achse ¹⁾	24.9238-0087.5	230035	<input type="checkbox"/>	D=38 ATE
	2.0	140	08.90	09.93	- Multi-Link-Achse ¹⁾	24.9238-0088.5	230036	<input type="checkbox"/>	D=38 ATE
	2.4 TD Intercooler	85	09.91	07.94	- Multi-Link-Achse ¹⁾	13.2401-0028.2	210046	<input type="checkbox"/>	D=40 ATE
	2.9	150	08.90	07.94	- Multi-Link-Achse ¹⁾	13.0441-4014.2	250079	<input type="checkbox"/>	Dichtungssatz ATE
	2.0	103	09.90	08.93	- Multi-Link-Achse ¹⁾	13.0460-3401.2	603401		20755 14,4 ATE
2.0	140	08.90	09.93	- Multi-Link-Achse ¹⁾	13.0460-0088.2	610088		Belagsatz-Zubehör ATE	
2.4 TD Intercooler	85	09.91	07.94	- Multi-Link-Achse ¹⁾					
2.9	150	08.90	07.94	- Multi-Link-Achse ¹⁾					
	2.0	103	09.90	08.93	+ Multi-Link-Achse ²⁾	13.0460-2935.2	602935		21385 13,8 /S TRW
	2.0	140	08.90	09.93	+ Multi-Link-Achse ²⁾				
	2.4 TD Intercooler	85	09.91	07.94	+ Multi-Link-Achse ²⁾				
	2.9	150	08.90	07.94	+ Multi-Link-Achse ²⁾				
	2.0	103	09.90	08.93	+ Multi-Link-Achse ²⁾				

¹⁾ - multi link axle / - assale Multi-link / - essieu multi-link / - eje Multi-Link
²⁾ + multi link axle / + assale Multi-link / + essieu multi-link / + eje Multi-Link































										
VOLVO 960 I Limousine (90-94)										
	2.0	103		09.90	08.93	- Multi-Link-Achse ¹⁾	24.0110-0189.1	410189		281 9,6 8,4 +B
	2.0	140		08.90	09.93	- Multi-Link-Achse ¹⁾				
	2.4 TD Intercooler	85		09.91	07.94	- Multi-Link-Achse ¹⁾				
	2.9	150		08.90	07.94	- Multi-Link-Achse ¹⁾				
	2.0	103		09.90	08.93	+ Multi-Link-Achse ²⁾	24.0110-0206.1	410206		265 10,0 8,0
2.0	140		08.90	09.93	+ Multi-Link-Achse ²⁾					
2.4 TD Intercooler	85		09.91	07.94	+ Multi-Link-Achse ²⁾					
2.9	150		08.90	07.94	+ Multi-Link-Achse ²⁾					
	2.0	103		09.90	12.91		83.6134-0300.3	330725	2	L=300
	2.0	140		08.90	12.91					
	2.4 TD Intercooler	85		09.91	12.91					
	2.9	150		08.90	12.91					
	2.0	103		01.92	08.93		83.6124-0305.3	330723	2	L=305
2.0	140		01.92	09.93						
2.4 TD Intercooler	85		01.92	07.94						
2.9	150		01.92	07.94						
	2.0	103		09.90	08.93	- Multi-Link-Achse ¹⁾	03.0137-0169.2	650169		160 x 25
	2.0	140		08.90	09.93	- Multi-Link-Achse ¹⁾	03.0137-9065.2	669065		Bremsbacken-Zubehör
	2.4 TD Intercooler	85		09.91	07.94	- Multi-Link-Achse ¹⁾				
	2.9	150		08.90	07.94	- Multi-Link-Achse ¹⁾				
	2.0	103		09.90	08.93	+ Multi-Link-Achse ²⁾	03.0137-0299.2	650299		160 x 25
2.0	140		08.90	09.93	+ Multi-Link-Achse ²⁾	03.0137-9199.2	669199		Bremsbacken-Zubehör	
2.4 TD Intercooler	85		09.91	07.94	+ Multi-Link-Achse ²⁾					
2.9	150		08.90	07.94	+ Multi-Link-Achse ²⁾					
	2.0	103		09.90	08.93		03.6055-0430.3	320065		BR 5/25 (4) ATE
	2.0	140		08.90	09.93					
	2.9	150		08.90	07.94					
2.4 TD Intercooler	85		09.91	07.94		03.6055-0431.3	320142		BR 5/35 (4) ATE	
	2.0	103		09.90	08.93		24.2419-0928.3	030056		Gz 19,05
	2.0	140		08.90	09.93					
	2.4 TD Intercooler	85		09.91	07.94					
	2.0	103		09.90	08.93		03.2522-0420.3	040086		Nz 22,20
	2.0	140		08.90	09.93					
	2.4 TD Intercooler	85		09.91	07.94					
VOLVO 960 I Kombi (90-94)										
	2.0	103		09.90	12.91		03.2023-0164.3	010014		ThZ 23,81/19,05 + B. ATE
	2.0	140		08.90	12.91					
	2.4 TD Intercooler	85		09.91	12.91					
	2.8	108		09.90	12.91					
	2.8	115		09.90	12.91					
	2.9	150		08.90	12.91					
	2.0	103		01.92	08.93		03.2023-0875.3	010890		ThZ 23,81/20,64 - B. ATE
	2.0	140		01.92	09.93					
	2.4 TD Intercooler	85		01.92	07.94					
	2.8	108		01.92	05.92					
	2.8	115		01.92	05.92					
	2.9	150		01.92	07.94					
	2.0	103		09.90	08.93		24.3571-1707.5	240079		D=57, - Halter TRW D=57, - Halter TRW Bremsattel-Zubehör TRW
	2.0	140		08.90	09.93		24.3571-1708.5	240080		
	2.4 TD Intercooler	85		09.91	07.94		24.0101-3601.2	260044		
	2.8	108		09.90	05.92					
	2.8	115		09.90	05.92					
	2.9	150		08.90	07.94					
	2.0	103		09.90	08.93		13.0460-2985.2	602985		20164 18,2 TRW
	2.0	140		08.90	09.93					
	2.4 TD Intercooler	85		09.91	07.94					
	2.8	108		09.90	05.92					
	2.8	115		09.90	05.92					
	2.9	150		08.90	07.94					
	2.0	103		09.90	08.93		24.0126-0105.1	426105		280 26,0 23,0 V +B
	2.0	140		08.90	09.93					
	2.4 TD Intercooler	85		09.91	07.94					
	2.8	108		09.90	05.92					
	2.8	115		09.90	05.92					
	2.9	150		08.90	07.94					
	2.0	103		09.90	08.93		83.6134-0335.3	330277	2	L=335
	2.0	140		08.90	09.93					
	2.4 TD Intercooler	85		09.91	07.94					
	2.8	108		09.90	05.92					
	2.8	115		09.90	05.92					
	2.9	150		08.90	07.94					
	2.0	103		09.90	08.93	- Multi-Link-Achse ¹⁾	24.9238-0087.5	230035		D=38 ATE D=38 ATE D=40 ATE Dichtungssatz ATE Dichtungssatz ATE Dichtungssatz ATE
	2.0	140		08.90	09.93	- Multi-Link-Achse ¹⁾	24.9238-0088.5	230036		
	2.4 TD Intercooler	85		09.91	07.94	- Multi-Link-Achse ¹⁾	13.2401-0028.2	210046		
	2.8	108		09.90	05.92	- Multi-Link-Achse ¹⁾	13.0441-3815.2	250069		
	2.8	115		09.90	05.92	- Multi-Link-Achse ¹⁾	13.0441-3819.2	250072		
	2.9	150		08.90	07.94	- Multi-Link-Achse ¹⁾	13.0441-4014.2	250079		
	2.0	103		09.90	08.93	- Multi-Link-Achse ¹⁾	13.0460-3401.2	603401		20755 14,4 ATE Belagsatz-Zubehör ATE
	2.0	140		08.90	09.93	- Multi-Link-Achse ¹⁾	13.0460-0088.2	610088		
	2.4 TD Intercooler	85		09.91	07.94	- Multi-Link-Achse ¹⁾				
	2.8	108		09.90	05.92	- Multi-Link-Achse ¹⁾				
	2.8	115		09.90	05.92	- Multi-Link-Achse ¹⁾				
	2.9	150		08.90	07.94	- Multi-Link-Achse ¹⁾				

¹⁾ - multi link axle / - assale Multi-link / - essieu multi-link / - eje Multi-Link

²⁾ + multi link axle / + assale Multi-link / + essieu multi-link / + eje Multi-Link

³⁾ f.predec.13.2381-0067/-0068.2 / p.prece.13.2381-0067.2/-0068.2 / p.préd.13.2381-0067.2/-0068.2

⁴⁾ f.predec.13.2401-0023/-0024.2 / p.prece.13.2401-0023.2/-0024.2 / p.préd.13.2401-0023.2/-0024.2 / p.prede.13.2401-0023.2/-0024.2



































	 kW												
VOLVO 960 I Kombi (90-94)													
	2.0	103		09.90	08.93	+ Multi-Link-Achse ¹⁾	13.0460-2935.2	602935		21385	13,8 / S	TRW	
	2.0	140		08.90	09.93	+ Multi-Link-Achse ¹⁾							
	2.4 TD Intercooler	85		09.91	07.94	+ Multi-Link-Achse ¹⁾							
	2.8	108		09.90	05.92	+ Multi-Link-Achse ¹⁾							
	2.8	115		09.90	05.92	+ Multi-Link-Achse ¹⁾							
	2.9	150		08.90	07.94	+ Multi-Link-Achse ¹⁾							
	2.0	103		09.90	08.93	- Multi-Link-Achse ²⁾	24.0110-0189.1	410189			281	9,6 8,4 +B	
	2.0	140		08.90	09.93	- Multi-Link-Achse ²⁾							
	2.4 TD Intercooler	85		09.91	07.94	- Multi-Link-Achse ²⁾							
	2.8	108		09.90	05.92	- Multi-Link-Achse ²⁾							
	2.8	115		09.90	05.92	- Multi-Link-Achse ²⁾							
	2.9	150		08.90	07.94	- Multi-Link-Achse ²⁾							
	2.0	103		09.90	08.93	+ Multi-Link-Achse ¹⁾	24.0110-0206.1	410206			265	10,0 8,0	
	2.0	140		08.90	09.93	+ Multi-Link-Achse ¹⁾							
	2.4 TD Intercooler	85		09.91	07.94	+ Multi-Link-Achse ¹⁾							
	2.8	108		09.90	05.92	+ Multi-Link-Achse ¹⁾							
	2.8	115		09.90	05.92	+ Multi-Link-Achse ¹⁾							
	2.9	150		08.90	07.94	+ Multi-Link-Achse ¹⁾							
	2.0	103		09.90	12.91		83.6134-0300.3	330725	2		L=300		
	2.0	140		08.90	12.91								
	2.4 TD Intercooler	85		09.91	12.91								
	2.8	108		09.90	12.91								
	2.8	115		09.90	12.91								
	2.9	150		08.90	12.91								
	2.0	103		01.92	08.93		83.6124-0305.3	330723	2		L=305		
	2.0	140		01.92	09.93								
	2.4 TD Intercooler	85		01.92	07.94								
	2.8	108		01.92	05.92								
	2.8	115		01.92	05.92								
	2.9	150		01.92	07.94								
	2.0	103		09.90	08.93	- Multi-Link-Achse ²⁾	03.0137-0169.2	650169			160 x 25	Bremsbacken-Zubehör	
	2.0	140		08.90	09.93	- Multi-Link-Achse ²⁾	03.0137-9065.2	669065					
	2.4 TD Intercooler	85		09.91	07.94	- Multi-Link-Achse ²⁾							
	2.8	108		09.90	05.92	- Multi-Link-Achse ²⁾							
	2.8	115		09.90	05.92	- Multi-Link-Achse ²⁾							
	2.9	150		08.90	07.94	- Multi-Link-Achse ²⁾							
	2.0	103		09.90	08.93	+ Multi-Link-Achse ¹⁾	03.0137-0299.2	650299			160 x 25	Bremsbacken-Zubehör	
	2.0	140		08.90	09.93	+ Multi-Link-Achse ¹⁾	03.0137-9199.2	669199					
	2.4 TD Intercooler	85		09.91	07.94	+ Multi-Link-Achse ¹⁾							
	2.8	108		09.90	05.92	+ Multi-Link-Achse ¹⁾							
	2.8	115		09.90	05.92	+ Multi-Link-Achse ¹⁾							
	2.9	150		08.90	07.94	+ Multi-Link-Achse ¹⁾							
	2.0	103		09.90	08.93		03.6055-0430.3	320065			BR 5/25 (4)	ATE	
	2.0	140		08.90	09.93								
	2.8	108		09.90	05.92								
	2.8	115		09.90	05.92								
	2.9	150		08.90	07.94								
	2.4 TD Intercooler	85		09.91	07.94		03.6055-0431.3	320142			BR 5/35 (4)	ATE	
	2.0	103		09.90	08.93		24.2419-0928.3	030056			Gz 19,05		
	2.0	140		08.90	09.93								
	2.4 TD Intercooler	85		09.91	07.94								
	2.8	108		09.90	05.92								
	2.8	115		09.90	05.92								
	2.9	150		08.90	07.94								
	2.0	103		09.90	08.93		03.2522-0420.3	040086			Nz 22,20		
	2.0	140		08.90	09.93								
	2.4 TD Intercooler	85		09.91	07.94								
	2.8	108		09.90	05.92								
	2.8	115		09.90	05.92								
	2.9	150		08.90	07.94								
VOLVO 960 II Limousine (94-96)													
	2.5	125		08.94	12.96		03.2023-0875.3	010890			Thz 23,81/20,64 - B.	ATE	
	2.9	150		08.94	12.96								
	2.5	125		08.94	12.96		24.3571-1707.5	240079	<input type="checkbox"/>		D=57, - Halter	TRW	
	2.9	150		08.94	12.96		24.3571-1708.5	240080	<input type="checkbox"/>		D=57, - Halter	TRW	
	2.5	125		08.94	12.96		24.0101-3601.2	260044			Bremssattel-Zubehör	TRW	
	2.9	150		08.94	12.96								
	2.5	125		08.94	12.96		13.0460-2985.2	602985			20164	18,2	TRW
	2.9	150		08.94	12.96								
	2.5	125		08.94	12.96		24.0126-0102.1	426102			280	26,0 23,0 V +B	
	2.9	150		01.95	12.96								
	2.5	125		08.94	12.94		24.0126-0105.1	426105			280	26,0 23,0 V +B	
	2.9	150		08.94	12.94								
	2.5	125		08.94	12.94		83.6134-0335.3	330277	2		L=335		
	2.9	150		08.94	12.94								
	2.5	125		01.95	12.96		83.6124-0380.3	330268	2		L=380		
	2.9	150		01.95	12.96								
	2.5	125		08.94	12.96	- Multi-Link-Achse ²⁾	13.2401-0028.2	210046	<input type="checkbox"/>		D=40	ATE	
	2.9	150		08.94	12.96	- Multi-Link-Achse ²⁾	13.0441-4014.2	250079		für Vorg. 13.2401-0023/-0024.2 ³⁾	Dichtungssatz	ATE	
	2.5	125		08.94	12.96	- Multi-Link-Achse ²⁾	13.0460-3401.2	603401			20755	14,4	ATE
	2.9	150		08.94	12.96	- Multi-Link-Achse ²⁾	13.0460-0088.2	610088			Belagsatz-Zubehör	ATE	

¹⁾ + multi link axle / + assale Multi-link / + essieu multi-link / + eje Multi-Link

²⁾ - multi link axle / - assale Multi-link / - essieu multi-link / - eje Multi-Link

³⁾ f.predce.13.2401-0023/-0024.2 / p.prece.13.2401-0023.2/-0024.2 / p.pred.13.2401-0023.2/-0024.2 / p.pred.13.2401-0023.2/-0024.2



								
VOLVO 960 II Limousine (94-96)								
	2.5 2.9	125 150		08.94 08.94	12.96 + Multi-Link-Achse 1) 12.96 + Multi-Link-Achse 1)	13.0460-2935.2 602935		21385 13,8 /S TRW
	2.5 2.9	125 150		08.94 08.94	12.96 - Multi-Link-Achse 2) 12.96 - Multi-Link-Achse 2)	24.0110-0189.1 410189		281 9,6 8,4 +B
	2.5	125		08.94	12.96 + Multi-Link-Achse 1)	24.0110-0289.1 410289		265 10,0 8,0
	2.9	150		08.94	12.96 + Multi-Link-Achse 1)	24.0110-0206.1 410206		265 10,0 8,0
	2.5 2.9	125 150		08.94 08.94	12.96 12.96	83.6134-0300.3 330725	2	L=300
	2.5 2.9	125 150		08.94 08.94	12.96 12.96	03.0137-0299.2 650299 03.0137-9199.2 669199		160 x 25 Bremsbacken-Zubehör
	2.5 2.9	125 150		08.94 08.94	12.96 12.96	03.6055-0430.3 320065		BR 5/25 (4) ATE
	2.5 2.9	125 150		08.94 08.94	12.96 12.96	24.2419-0928.3 030056 24.2419-0941.3 030067		Gz 19,05 Gz 19,05
	2.5 2.9	125 150		08.94 08.94	12.96 12.96	03.2522-0420.3 040086 24.2520-0905.3 040057		Nz 22,20 Nz 20,64
VOLVO 960 II Kombi (94-96)								
	2.5 2.9	125 150		08.94 08.94	12.96 12.96	03.2023-0875.3 010890		THz 23,81/20,64 - B. ATE
	2.5 2.9	125 150		08.94 08.94	12.96 12.96	24.3571-1707.5 240079 24.3571-1708.5 240080 24.0101-3601.2 260044	 	D=57, - Halter TRW D=57, - Halter TRW Bremsattel-Zubehör TRW
	2.5 2.9	125 150		08.94 08.94	12.96 12.96	13.0460-2985.2 602985		20164 18,2 TRW
	2.5 2.9	125 150		08.94 01.95	12.96 12.96	24.0126-0102.1 426102		280 26,0 23,0 V +B
	2.9	150		08.94	12.94	24.0126-0105.1 426105		280 26,0 23,0 V +B
	2.5 2.9	125 150		08.94 08.94	12.94 12.94	83.6134-0335.3 330277	2	L=335
	2.5 2.9	125 150		01.95 01.95	12.96 12.96	83.6124-0380.3 330268	2	L=380
	2.5 2.9	125 150		08.94 08.94	12.96 - Multi-Link-Achse 2) 12.96 - Multi-Link-Achse 2)	13.2401-0028.2 210046 13.0441-4014.2 250079	 für Vorg. 13.2381-0065/-0066.2 3)	D=40 ATE Dichtungssatz ATE
	2.5 2.9	125 150		08.94 08.94	12.96 - Multi-Link-Achse 2) 12.96 - Multi-Link-Achse 2)	13.0460-3401.2 603401 13.0460-0088.2 610088		20755 14,4 ATE Belagsatz-Zubehör ATE
	2.5 2.9	125 150		08.94 08.94	12.96 + Multi-Link-Achse 1) 12.96 + Multi-Link-Achse 1)	13.0460-2935.2 602935		21385 13,8 /S TRW
	2.5 2.9	125 150		08.94 08.94	12.96 - Multi-Link-Achse 2) 12.96 - Multi-Link-Achse 2)	24.0110-0189.1 410189		281 9,6 8,4 +B
	2.5 2.9	125 150		08.94 08.94	12.96 + Multi-Link-Achse 1) 12.96 + Multi-Link-Achse 1)	24.0110-0289.1 410289 24.0110-0206.1 410206		265 10,0 8,0 265 10,0 8,0
	2.5 2.9	125 150		08.94 08.94	12.96 12.96	83.6134-0300.3 330725	2	L=300
	2.5 2.9	125 150		08.94 08.94	12.96 12.96	03.0137-0299.2 650299 03.0137-9199.2 669199		160 x 25 Bremsbacken-Zubehör
	2.9	150		08.94	12.96	03.0137-0169.2 650169 03.0137-9065.2 669065		160 x 25 Bremsbacken-Zubehör
	2.5 2.9	125 150		08.94 08.94	12.96 12.96	03.6055-0430.3 320065		BR 5/25 (4) ATE
	2.5 2.9	125 150		08.94 08.94	12.96 12.96	24.2419-0928.3 030056 24.2419-0941.3 030067		Gz 19,05 Gz 19,05
	2.5 2.9	125 150		08.94 08.94	12.96 12.96	03.2522-0420.3 040086 24.2520-0905.3 040057		Nz 22,20 Nz 20,64
VOLVO 1800 Sport (68-72)								
	1.8			01.68	12.72	03.2122-1906.3 010761		THz 22,20 - Behälter ATE
WARTBURG 1,3 (88-91)								
	1.3			10.88	04.91	24.3219-1201.3 020197		Rz 19,05

1) + multi link axle / + assale Multi-link / + essieu multi-link / + eje Multi-Link

2) - multi link axle / - assale Multi-link / - essieu multi-link / - eje Multi-Link

3) f.predéc.13.2381-0065/-0066.2 / p.precé.13.2381-0065.2/-0066.2 / p.préd.13.2381-0065.2/-0066.2 / p.prede.13.2381-0065.2/-0066.2

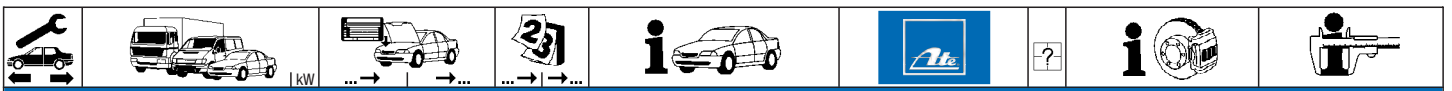

WARTBURG 353 (69-88)

	alle Typen		10.75	09.88		24.3219-1201.3	020197		Rz 19,05
--	------------	--	-------	-------	--	----------------	--------	--	----------

ZASTAVA 101 (73-93)

	alle Typen		06.73	12.93		24.3219-0801.3	020181		Rz 19,05	FI
--	------------	--	-------	-------	--	----------------	--------	--	----------	----

ZASTAVA 750

	alle Typen					24.3219-0801.3	020181		Rz 19,05	FI
--	------------	--	--	--	--	----------------	--------	--	----------	----





Ⓓ **Abmessungen Bremsscheiben**

ⒺⓃ **Dimensions brake discs**

ⒻⓇ **Dimensions Disques de frein**

ⒺⓈ **Medidas disco de freno**

Abmessungen Bremsscheiben

Dimensions brake discs - Misure dischi freno -

Dimensions Disques de frein - Medidas disco de freno

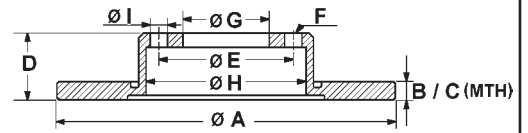

S Fixierschraube - fixing screw - vite di riparazione - vis de fixation - tornillo quefija
 B beschichtet - coated - rivestito - revêtu - recubierto
 HC hochgekohlt - high carbon - ad alto tenore di carbonio - à haute teneur en carbone - altamente carbonizado
 L legiert - alloyed - alligato/legato - allié - aleado
 V ventiliert - ventilated - ventilato - ventilé - ventilado
 ● gelocht - perforated - perforato - poinçonné - perforado

	S	B	HC	L	V	A	B	C	D	E	F	G	H	I	OE	#
24.0107-0100.1						244,0	7,0	6,3	47,0	108,0	6	86,7	128,0	9,5	CITROEN	95 599 322
24.0107-0104.1						178,0	7,0	6,3	14,5	63,0	4	45,6	85,5	9,4	CITROEN	2G 5 448 826 V 5 448 826
24.0107-0105.2						224,0	7,0	5,0	56,5	108,0	4	71,0	133,0	13,0	CITROEN	95 582 061 95 661 849
24.0107-0108.1						234,0	7,0	6,0	39,5	100,0	4	68,0	140,0	12,8	NISSAN	43206-58Y01
24.0107-0109.1		B				240,0	7,0	6,0	41,0	100,0	4	61,0	140,0	12,6	NISSAN	43206-5F001
24.0108-0100.1						239,0	8,0	7,0	44,0	100,0	4	65,0	124,5	12,9	AUDI/VW	861 615 301 B
24.0108-0104.1		S B				238,0	8,2	7,0	41,0	100,0	4	61,0	129,5	12,4	RENAULT	77 01 204 285
24.0108-0105.1						247,5	8,0	6,5	20,3	108,0	4	71,0	133,0	13,0	PEUGEOT	4246 H0
24.0108-0106.1		S B				247,0	8,0	6,0	25,3	108,0	4	71,1	133,5	13,0	CITROEN	4249 F5
														PEUGEOT	4249 F5	
24.0108-0107.1		S B				238,0	8,0	6,0	29,0	98,0	3	57,0	124,5	13,0	CITROEN	95 027 199 95 661 810
														PEUGEOT	4246 G0	
24.0108-0108.1		B				238,0	8,0	7,0	74,6	100,0	4	52,0	52,3	M12x1,5	RENAULT	77 00 780 077 77 00 780 078 77 00 829 553 77 01 204 293 77 01 204 294 77 01 204 523 77 01 204 901
24.0108-0109.1						238,0	8,0	7,0	74,6	100,0	4	52,0	52,3	M12x1,5	RENAULT	77 00 805 006 77 00 805 148 77 01 204 302 77 01 204 303
24.0108-0111.1		B				258,0	8,0	7,0	55,3	112,0	5	67,0	164,0	13,0	MERCEDES BENZ	168 423 02 12
24.0108-0113.1		S B				258,0	8,0	7,0	57,3	112,0	5	67,0	164,0	15,0	MERCEDES BENZ	169 423 09 12
24.0108-0114.2		B				240,0	8,0	7,0	80,6	100,0	4	52,3	55,0	M12x1,5	RENAULT	77 01 207 823 86 60 001 811 86 71 018 106
24.0108-0116.2		B				260,0	8,0	7,0	86,2	114,3	5	52,3	55,0	M12x1,5	RENAULT	43 20 015 39R 43 20 075 95R
24.0108-0117.2		B				238,0	8,0	7,0	74,6	100,0	4	52,3	52,0	M12x1,5	RENAULT	77 01 207 611
24.0108-0118.2		B				260,0	8,0	7,0	86,2	114,3	5	52,3	62,0	M12x1,5	RENAULT	43 20 065 06R 43 20 075 56R
24.0109-0100.2		B				249,0	9,0	7,0	69,2	108,0	4	56,0	62,0	M12x1,25	CITROEN	4249 32
														PEUGEOT	4249 19 4249 32	
24.0109-0101.1						267,0	9,4	7,5	65,3	108,0	4	70,0	160,0	12,8	ALFA ROMEO	60516948
24.0109-0103.1		B				278,0	9,0	7,3	58,5	112,0	5	67,0	164,0	15,0	MERCEDES BENZ	129 423 00 12
24.0109-0108.1						244,5	9,0	7,0	43,8	86,0	3	62,0	109,0	10,0	CITROEN	75 485 825
24.0109-0111.1		S B				239,0	9,0	8,0	47,6	100,0	4	61,0	155,0	13,0	HONDA	42510-SR3-A11 42510-SR3-J00
24.0109-0114.1		S B				278,0	9,0	7,3	55,5	112,0	5	67,0	164,0	13,2	CHRYSLER	0 5098 066AA
														MERCEDES BENZ	203 423 01 12 210 423 01 12 210 423 04 12 210 423 09 12 202 423 00 12	
24.0109-0120.1		S B				258,0	9,0	7,3	55,5	112,0	5	67,0	164,0	12,8	MERCEDES BENZ	202 423 00 12
24.0109-0121.2						224,0	9,0	8,0	63,2	108,0	5	71,0	135,0	13,0	CITROEN	4246 T3 95 661 814
24.0109-0122.1		B				224,0	9,0	7,0	57,5	108,0	4	71,1	132,7	13,0	CITROEN	95 667 811 E169114
24.0109-0123.1		S B				230,0	9,0	7,0	40,6	100,0	5	65,0	125,8	15,6	AUDI/SEAT/SKODA/VW	1J0 615 601 C 1J0 615 601 P
24.0109-0124.1		B				232,0	9,0	7,0	39,5	100,0	4	65,0	125,0	13,6	SEAT/VW	6N0 615 601 A 6N0 615 601 B
24.0109-0125.1						228,0	9,0	8,0	39,5	100,0	4	60,0	127,0	13,5	VOLVO	3432618 3450386
24.0109-0127.1						231,0	9,0	8,0	34,5	100,0	4	65,0	125,0	13,0	MAZDA	B4Y2-26-251C
24.0109-0128.1						242,0	9,0	8,0	36,4	100,0	4	54,0	130,9	14,5	TOYOTA	42431-12090 42431-12120
24.0109-0129.1						258,0	9,0	8,0	44,5	114,3	4	68,0	154,0	12,8	NISSAN	43206-42R05
24.0109-0130.1						258,0	9,0	7,5	43,5	108,0	4	68,0	160,7	15,5	SAAB	8970717
24.0109-0131.1		B				251,0	9,0	8,0	34,5	100,0	4	55,0	125,0	13,0	MAZDA	BB4C-26-251C BR74-26-251A
24.0109-0132.1						282,0	9,0	7,5	61,0	114,3	5	70,0	170,0	12,6	HONDA	42510-SP0-000 42510-SX0-000
24.0109-0133.1		S B				239,0	8,9	7,0	33,4	100,0	5	65,0	132,5	15,8	AUDI/VW/SKODA	1J0 615 601 D
24.0109-0136.1		S B	HC			280,0	9,0	8,0	38,0	112,0	3	58,0	153,5	12,5	SMART	000 4341 V002 000000

Abmessungen Bremsscheiben

Dimensions brake discs - Misure dischi freno -

Dimensions Disques de frein - Medidas disco de freno

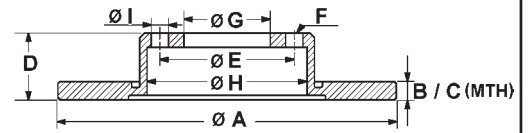

S Fixierschraube - fixing screw - vite di riparazione - vis de fixation - tornillo quefija

B beschichtet - coated - rivestito - revêtu - recubierto

HC hochgekohlt - high carbon - ad alto tenore di carbonio - à haute teneur en carbone - altamente carbonizado

L legiert - alloyed - alligato/legato - allié - aleado

V ventiliert - ventilated - ventilato - ventilé - ventilado

● gelocht - perforated - perforato - poinçonné - perforado

		S	B	HC	L	V	A	B	C	D	E	F	G	H	I	OE	#
24.0109-0137.1	409137	S	B				247,0	9,0	8,0	35,0	108,0	4	71,1	133,0	13,0	CITROEN	4246 X8 4259 53 4249 90
																PEUGEOT	4246 W9 4259 52 4249 90
24.0109-0138.1	409138		B				258,0	9,0	8,0	55,5	100,0	4	55,0	172,0	14,5	TOYOTA	42431-02070
24.0109-0139.1	409139		B				269,0	9,0	8,0	56,0	100,0	4	55,0	173,0	14,5	TOYOTA	42431-12250 42431-52050 42431-47020
24.0109-0140.1	409140		B				279,0	9,0	8,0	55,5	100,0	4	55,0	172,0	14,5	TOYOTA	42431-02080 42431-02081
24.0109-0141.1	409141	S					260,0	9,0	8,0	42,3	114,3	4	64,1	157,0	12,6	HONDA	42510-S30-900
24.0109-0142.1	409142		B				278,0	9,0	7,0	24,7	100,0	4	55,0	147,0	14,3	DAIHATSU	42431-0D060
																TOYOTA	42431-0D060
24.0109-0143.1	409143	S					260,0	9,0	8,0	48,2	100,0	4	61,0	156,0	13,0	HONDA	42510-S5A-A00
24.0109-0144.1	409144	S	B				282,0	9,0	8,0	58,3	114,3	5	64,1	170,0	12,5	HONDA	42510-S9A-N00
24.0109-0145.1	409145						260,0	9,0	8,0	48,1	114,3	4	64,1	157,0	12,6	HONDA	42510-S84-A50
24.0109-0146.1	409146		B				270,0	9,0	7,3	53,3	100,0	5	57,5	172,0	14,5	CHRYSLER	4509 553 4509 553AB 4509 553AC
24.0109-0147.1	409147						258,0	9,0	8,0	46,5	114,3	5	68,0	154,0	12,5	NISSAN	43206-74F00
24.0109-0148.1	409148						269,0	9,0	8,0	65,0	100,0	5	55,0	170,0	14,5	TOYOTA	42431-20360
24.0109-0150.2	409150		B				249,0	9,0	8,0	67,1	108,0	4	55,9	60,0	M12x1,25	CITROEN	4246 Z9 4249 34 4246 Z9
																PEUGEOT	
24.0109-0151.1	409151	S	B				304,5	9,0	7,5	61,0	114,3	5	64,1	200,0	12,8	HONDA	42510-SCA-E50
24.0109-0152.1	409152		B				303,0	9,0	8,0	62,1	114,3	5	62,0	190,0	14,5	TOYOTA	42431-42041
24.0109-0154.1	409154	S	B				278,0	9,0	7,3	57,5	112,0	5	67,0	164,0	15,0	MERCEDES BENZ	000 423 13 12
24.0109-0155.1	409155		B				259,0	9,0	7,5	30,5	114,3	5	62,0	156,0	14,8	TOYOTA	42431-02190 42431-12260
24.0109-0156.1	409156		B				259,0	9,0	7,5	30,0	100,0	4	55,0	156,0	14,5	ASTON MARTIN	42431-52080
																TOYOTA	42431-52080
24.0109-0157.1	409157		B				291,5	9,0	8,0	62,0	114,3	5	68,0	172,0	12,7	NISSAN	43206-JD00A
24.0109-0158.1	409158	S	B				260,0	9,0	8,0	42,2	114,3	5	64,2	140,5	12,6	HONDA	42510-SMG-E20 42510-SNA-A00
24.0109-0159.1	409159		B				266,0	9,0	8,0	36,2	100,0	4	55,0	131,0	14,5	TOYOTA	42431-12150 42431-12170
24.0109-0160.1	409160		B				278,0	9,0	8,0	43,1	114,3	5	62,0	169,0	12,7	SUZUKI	55611-80J10
24.0109-0161.1	409161		B				282,0	9,0	7,5	61,1	114,3	5	64,2	170,0	12,6	HONDA	42510-SZ3-J00
24.0109-0162.1	409162	S	B				260,0	9,0	8,0	31,1	100,0	4	61,0	142,4	12,6	HONDA	42510-TM8-G00
24.0109-0163.1	409163		B				259,0	9,0	7,5	30,2	100,0	5	55,0	156,2	14,5	SUBARU	4243112310
																TOYOTA	42431-12310
24.0109-0166.1	409166		B				292,0	9,0	8,0	62,0	114,3	4	68,0	172,0	12,5	NISSAN	43206-EM10A
24.0109-0167.1	409167		B				278,0	9,0	8,0	43,2	114,3	5	62,0	169,0	14,0	FIAT	71768089
																SUZUKI	55611-55L00 55611-80J01
24.0109-0168.1	409168	S	B				239,0	9,0	8,0	47,7	100,0	4	61,0	151,1	13,0	HONDA	42510-SEL-T50
24.0109-0169.1	409169	S	B				282,0	9,0	8,0	48,7	114,3	5	64,2	157,0	12,5	HONDA	42510-TA0-A01
24.0109-0170.1	409170		B				259,0	9,0	7,5	40,8	100,0	5	55,0	156,0	16,5	TOYOTA	42431-52150
24.0109-0171.2	409171		B				249,0	9,0	8,0	73,2	108,0	4	56,0	62,0	M12x1,25	CITROEN/PEUGEOT	4249 66
24.0109-0173.1	409173	S	B	HC			276,0	9,0	7,3	44,0	112,0	5	67,0	153,0	15,0	MERCEDES BENZ	246 423 04 12
24.0109-0174.1	409174	S	B				232,0	9,0	7,0	39,6	100,0	5	65,0	123,8	15,6	VOLKSWAGEN	1JE 615 601
24.0109-0175.1	409175		B				259,0	9,0	8,0	43,2	100,0	4	62,0	150,0	14,0	SUZUKI	55611-68L00
24.0109-0181.1	409181		B				265,0	9,0	7,0	39,0	114,3	5	68,0	143,0	13,0	MAZDA	B45G-26-251A BJS7-26-251B
24.0109-0182.1	409182		B				259,4	9,0	8,0	43,2	114,3	5	62,0	146,6	14,0	SUZUKI	55611-61M00
24.0109-0709.1	409709						260,0	9,0	8,0	48,1	114,3	5	64,1	157,0	12,6	HONDA	42510-S87-A00
24.0109-0711.1	409711		B				269,0	9,0	7,5	56,0	100,0	5	55,0	173,0	14,5	TOYOTA	42431-20420 42431-47030
24.0110-0109.1	410109						240,0	10,0	8,4	58,5	80,0	4	63,0	106,0	10,2	BMW	34 11 1 117 422
24.0110-0110.1	410110						272,0	9,5	7,9	61,5	120,0	5	75,0	160,0	14,5	BMW	34 21 1 163 132
24.0110-0111.1	410111		B				226,0	10,0	8,0	71,2	100,0	4	39,8	121,4	M12x1,5	SEAT/VW	357 615 601
																VOLKSWAGEN	6N0 615 601
24.0110-0115.1	410115		B				253,0	10,2	8,9	33,0	108,0	4	63,5	155,0	13,7	FORD	1514237 1756882 1780880 4083484 5022666 5030658 95GJ-2A315-EC C1BC-2A315-AA
24.0110-0116.1	410116		B				245,0	10,0	8,0	46,5	112,0	5	68,0	135,5	15,4	AUDI	443 615 601 B
24.0110-0117.1	410117	S	B	HC			300,0	10,0	8,4	61,0	120,0	5	75,0	180,0	14,5	BMW	34 21 1 162 305

Abmessungen Bremsscheiben

Dimensions brake discs - Misure dischi freno -

Dimensions Disques de frein - Medidas disco de freno

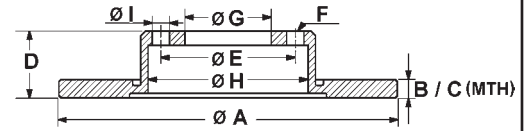

S Fixierschraube - fixing screw - vite di riparazione - vis de fixation - tornillo quejija

B beschichtet - coated - rivestito - revêtu - recubierto

HC hochgekohlt - high carbon - ad alto tenore di carbonio - à haute teneur en carbone - altamente carbonizado

L legiert - alloyed - alligato/legato - allié - aleado

V ventiliert - ventilated - ventilato - ventilé - ventilado

● gelocht - perforated - perforato - poinçonné - perforado

		S	B	HC	L	V	A	B	C	D	E	F	G	H	I	OE - #	
24.0110-0118.1	410118			HC			300,0	9,9	8,4	67,9	120,0	5	75,0	180,0	14,5	BMW	34 21 1 165 259
24.0110-0136.1	410136						215,0	10,0	8,0	33,0	102,0	4	86,0	106,0	M10x1,25	SUZUKI	55511-82001
24.0110-0139.1	410139						228,0	10,0	9,0	38,5	99,0	6	83,0	102,5	M8	RENAULT	77 01 466 540
24.0110-0142.1	410142						278,0	9,5	8,0	83,8	130,0	4	39,8	160,0	M14x1,5	VOLKSWAGEN	113 407 075 311 405 583 A
24.0110-0144.1	410144						261,0	9,9	8,0	82,1	100,0	4	39,8	160,0	M12x1,5	OPEL/VAUXHALL	5 69 204/90348319
24.0110-0147.1	410147						280,0	10,0	8,4	68,1	120,0	5	75,0	160,0	14,5	BMW	34 21 1 165 255
24.0110-0148.1	410148						221,0	10,0	8,7	42,0	108,0	4	72,0	131,0	13,4	FORD	1575877 5022650 5022651 6119634
24.0110-0150.1	410150		B				258,0	10,0	8,4	60,0	100,0	4	62,0	160,8	14,5	BMW	34 21 6 755 407
24.0110-0151.1	410151	S	B				239,0	10,0	8,0	38,9	100,0	4	65,0	124,5	13,6	AUDI/SEAT/VW	811 615 301
24.0110-0152.1	410152	S	B				236,0	10,0	7,0	41,0	100,0	4/6	60,0	123,0	14,0	OPEL/VAUXHALL	5 69 028/90008003
24.0110-0154.1	410154						245,0	10,0	8,0	59,5	112,0	5	68,0	135,8	15,4	AUDI	437 615 601
24.0110-0166.1	410166						250,0	9,9	8,0	21,0	80,0	6	62,0	134,0	8,5	ALFA ROMEO	60526121
24.0110-0174.1	410174						284,0	10,0	8,4	61,0	120,0	5	75,0	180,0	14,5	BMW	34 21 1 162 968
24.0110-0176.1	410176						284,0	10,0	8,4	68,0	120,0	5	75,0	180,0	14,5	BMW	34 21 1 163 150
24.0110-0178.1	410178		B				245,0	10,0	8,0	59,5	108,0	4	68,0	135,8	15,4	AUDI	443 615 601
24.0110-0179.1	410179						250,0	9,9	8,0	21,0	80,0	6	62,0	134,0	10,5	ALFA ROMEO	60533971
24.0110-0181.1	410181						259,0	10,0	8,0	72,0	114,3	5	48,0	58,0	12,5	FORD MAZDA	E92Z2C026A GJ25-26-251 GJ25-26-251A GJ25-26-251B GW55-26-251
24.0110-0182.1	410182		B				245,0	10,0	8,0	40,1	108,0	4	68,0	135,5	15,4	AUDI	8A0 615 601
24.0110-0183.1	410183						266,0	10,0	8,0	27,0	108,0	4	66,0	133,2	13,0	CITROEN PEUGEOT	95 661 746 4246 A9
24.0110-0185.1	410185	S	B				279,0	10,0	8,3	71,7	112,0	5	67,0	160,0	15,0	MERCEDES BENZ	126 423 00 12
24.0110-0186.1	410186		B				252,7	10,2	8,9	33,0	112,0	5	63,5	155,0	13,7	FORD	5027464 5027465
24.0110-0187.1	410187	S	B				247,0	10,0	9,0	34,2	108,0	4	66,0	133,0	13,0	CITROEN PEUGEOT	95 661 748 4246 A5 4249 95
24.0110-0189.1	410189		B				281,0	9,6	8,4	73,2	108,0	5	68,0	160,0	16,5	VOLVO	270736
24.0110-0190.1	410190		B				251,5	10,0	9,0	50,7	98,0	4	59,0	127,5	13,0	ALFA/FIAT/LANCIA	46758715 46831042 82434070 71738913
24.0110-0191.1	410191		B				270,0	10,0	8,0	67,0	110,0	5	65,5	160,0	14,0	OPEL/VAUXHALL	5 69 101/90272328
24.0110-0192.1	410192						289,8	10,0	9,0	46,0	140,0	5	107,0	177,0	13,0	SUZUKI	55211-80000
24.0110-0193.1	410193						239,5	10,2	8,7	58,1	108,0	4	63,5	136,0	13,7	FORD	5022947 5024744
24.0110-0196.1	410196		B				239,7	10,0	8,0	43,0	108,0	4	63,6	136,0	13,8	FORD	5022652 5022653
24.0110-0197.1	410197						238,0	10,0	9,0	29,0	98,0	3	57,0	124,3	12,8	CITROEN	95 638 635 95 661 848
24.0110-0198.1	410198						258,0	10,0	9,0	29,0	98,0	3	57,0	124,3	13,0	CITROEN	95 669 226
24.0110-0199.1	410199						247,0	10,0	8,0	34,3	108,0	4	71,0	133,0	13,0	PEUGEOT	4246 G9
24.0110-0200.1	410200						245,0	10,0	8,0	65,5	108,0	4	68,0	135,5	15,4	AUDI	443 615 601 E
24.0110-0201.1	410201		B				245,0	10,0	8,0	64,2	112,0	5	68,0	135,5	15,4	AUDI/SKODA/VW	4A0 615 601 A
24.0110-0202.1	410202	S	B	HC			280,0	10,0	8,4	60,0	120,0	5	75,0	160,8	14,5	BMW	34 21 1 165 457 34 21 6 864 051
24.0110-0203.1	410203		B				226,0	10,0	8,0	71,2	100,0	5	39,8	50,2	M14x1,5	SEAT/VW	357 615 601 B
24.0110-0204.1	410204		B				260,0	10,0	8,0	69,2	100,0	4	57,0	160,0	14,0	OPEL/VAUXHALL	5 69 206/90421872
24.0110-0205.1	410205		B				270,0	9,9	8,0	77,0	100,0	4	57,0	160,0	14,0	OPEL/VAUXHALL	5 69 102/90297932
24.0110-0206.1	410206						265,0	10,0	8,0	53,0	108,0	5	68,0	160,0	16,0	VOLVO	1359290
24.0110-0207.1	410207						245,0	10,0	8,0	46,5	108,0	4	68,0	135,5	15,4	AUDI	443 615 601 A
24.0110-0208.1	410208						247,0	10,0	9,0	32,5	98,0	3	57,0	124,5	13,0	CITROEN	95 661 811 96 047 276
24.0110-0209.1	410209		B				251,4	10,0	9,0	50,5	98,0	5	59,0	127,5	13,0	ALFA/FIAT/LANCIA	7789267 60569164 60653479 71738912 60801787 82439939 82440275
24.0110-0210.1	410210		B				245,0	10,0	8,0	83,6	112,0	5	45,2	135,5	M14x1,5	AUDI	8D0 615 601 B
24.0110-0211.1	410211	S	B	HC			272,0	10,0	8,4	78,0	120,0	5	75,0	160,8	14,5	BMW	34 21 6 758 552 34 21 6 758 553

Abmessungen Bremsscheiben

Dimensions brake discs - Misure dischi freno -

Dimensions Disques de frein - Medidas disco de freno

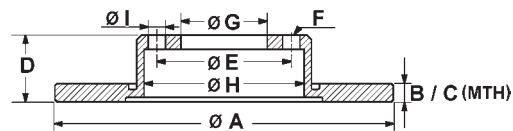

S Fixierschraube - fixing screw - vite di riparazione - vis de fixation - tornillo quefija

B beschichtet - coated - rivestito - revêtu - recubierto

HC hochgekohlt - high carbon - ad alto tenore di carbonio - à haute teneur en carbone - altamente carbonizado

L legiert - alloyed - alligato/legato - allié - aleado

V ventiliert - ventilated - ventilato - ventilé - ventilado

● gelocht - perforated - perforato - poinçonné - perforado

		S	B	H	C	L	V	A	B	C	D	E	F	G	H	I	OE - #
24.0110-0212.1	410212	S	B					238,5	10,0	8,0	48,1	100,0	4	61,0	154,5	13,0	HONDA 42510-SE0-010 42510-SH3-G00 42510-SK3-305 42510-SK3-E00 ROVER GBD90817 EGP1254
24.0110-0213.1	410213							270,0	10,0	8,6	62,6	108,0	4	63,5	180,0	13,7	FORD 5025951
24.0110-0214.1	410214		B					295,0	9,6	8,4	72,0	108,0	5	68,0	178,0	14,5	VOLVO 271794
24.0110-0215.1	410215		B					258,0	10,0	9,0	45,0	114,3	4	68,0	154,0	12,6	NISSAN 43206-99J01
24.0110-0216.1	410216							295,0	9,6	8,4	72,0	108,0	4	68,0	178,0	14,5	VOLVO 271497
24.0110-0217.1	410217	S	B					290,0	10,0	8,3	55,5	112,0	5	67,0	164,0	13,3	MERCEDES BENZ 210 423 10 12
24.0110-0218.1	410218		B					295,0	10,0	8,0	56,0	98,0	5	59,0	180,0	15,0	CITROEN FIAT/LANCIA PEUGEOT 4246 J5 9566928380
24.0110-0219.1	410219		B					265,0	10,5	9,5	44,3	100,0	4	66,0	149,6	13,5	RENAULT 77 01 205 844 86 71 005 980
24.0110-0220.1	410220		B					265,0	10,5	9,5	44,3	108,0	5	66,0	149,6	14,5	RENAULT 77 01 205 845 86 71 005 979
24.0110-0223.1	410223	S	B					268,0	10,0	8,0	45,8	112,0	5	68,2	154,5	16,8	FORD 1001094 1045995
24.0110-0224.1	410224		B					245,0	10,0	8,0	48,0	112,0	5	68,0	135,5	15,4	SEAT/VW AUDI/VW 7M0 615 601 C 8D0 615 601 A 8E0 615 601 A
24.0110-0225.1	410225	S	B					270,0	10,0	8,0	69,3	100,0	4	57,0	160,0	14,0	OPEL/VAUXHALL 5 69 209/90512909
24.0110-0226.1	410226	S	B					286,0	10,0	8,0	69,3	110,0	5	65,5	160,0	14,0	OPEL/VAUXHALL SAAB 5 69 210/90512910 4565693 5391578
24.0110-0227.1	410227	S	B	HC				298,0	10,0	8,4	61,0	120,0	5	75,0	185,0	14,5	BMW 34 21 1 163 835 34 21 6 767 049
24.0110-0228.1	410228	S	B	HC	L			280,0	10,0	8,0	65,2	112,0	5	67,0	178,0	15,0	MERCEDES BENZ 638 423 01 12
24.0110-0229.1	410229		B					260,0	10,0	8,4	41,0	114,3	4	90,0	154,0	12,6	MITSUBISHI MB699288 MR249356 MR913846 30872940
24.0110-0230.1	410230		B					290,5	10,0	8,0	60,0	108,0	4	71,0	185,0	13,0	VOLVO PEUGEOT 4246 L7 4246 T6 4246 T7
24.0110-0231.1	410231							290,0	10,0	8,0	40,0	108,0	5	71,0	185,0	13,0	PEUGEOT 4246 F1 4246 K9
24.0110-0232.1	410232	S	B					239,0	9,9	8,0	33,6	100,0	4	65,0	125,0	13,8	SEAT/VW 6N0 615 301
24.0110-0233.1	410233	S	B					260,0	10,0	8,0	48,7	114,3	4	64,1	155,0	12,8	HONDA 42510-SN7-000 42510-SV1-A00 42510-SV4-A00
24.0110-0234.1	410234		B					261,0	10,0	8,0	40,0	114,3	5	72,0	142,5	13,0	ROVER FORD MAZDA GBD90835 3415598 GA5Y-26-251C GA5Y-26-251D GA7Y-26-251 GA8Y-26-251 GTYP-26-251C
24.0110-0235.1	410235							211,0	10,0	9,0	35,0	88,0	4	70,0	98,0	M10x1,25	DAIHATSU 43512-87216-000
24.0110-0237.1	410237		B					266,0	10,0	8,5	65,8	100,0	5	58,0	170,0	12,8	SUBARU 26310AA051 26700FE010 26710AC020 26700FE080
24.0110-0238.1	410238							265,0	10,0	8,4	49,0	114,3	4	90,0	154,0	12,6	MITSUBISHI MB500555 MB500556
24.0110-0239.1	410239							213,5	9,6	8,6	61,2	73,0	4	55,6	85,0	3/8"	AUSTIN/ROVER GBD90806
24.0110-0240.1	410240		B					262,0	10,0	8,4	60,1	114,3	4	90,0	168,0	12,6	MITSUBISHI MB668083 MB857978
24.0110-0241.1	410241							269,0	10,0	9,0	64,5	100,0	5	54,0	188,5	14,5	TOYOTA 42431-20160
24.0110-0242.1	410242		B					290,0	10,0	8,0	46,2	139,5	5	107,0	182,5	13,0	SUZUKI 55211-60A00
24.0110-0243.1	410243							265,0	10,0	8,4	49,0	114,3	5	90,0	154,0	12,6	MITSUBISHI MB587433
24.0110-0244.1	410244							258,0	10,0	9,0	45,0	114,3	5	68,0	154,0	12,6	NISSAN 43206-88E03
24.0110-0249.1	410249							260,0	10,0	8,0	69,2	110,0	5	65,5	160,0	14,3	OPEL/VAUXHALL SAAB 5 69 105/90509590 4241477
24.0110-0250.1	410250	S	B					264,0	9,8	8,0	42,0	110,0	5	65,5	145,0	14,0	OPEL/VAUXHALL 5 69 109/9117772
24.0110-0251.1	410251	S	B					240,0	9,8	8,0	42,0	100,0	4	57,0	140,8	14,0	OPEL/VAUXHALL 5 69 111/9196587
24.0110-0253.1	410253							270,0	10,0	8,0	77,0	110,0	5	65,5	160,1	12,8	OPEL/VAUXHALL 5 69 207/90442651
24.0110-0255.1	410255							260,0	10,0	8,0	43,1	114,3	4	64,1	158,8	12,5	HONDA 42510-SG9-000 42510-SG9-010
24.0110-0256.1	410256							259,0	10,0	8,0	72,0	114,3	5	47,9	63,9	12,5	ROVER MAZDA GBD90802 G311-26-251A GM09-26-251B

Abmessungen Bremsscheiben

Dimensions brake discs - Misure dischi freno -

Dimensions Disques de frein - Medidas disco de freno

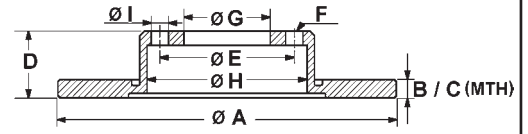

S Fixierschraube - fixing screw - vite di riparazione - vis de fixation - tornillo quefija

B beschichtet - coated - rivestito - revêtu - recubierto

HC hochgekohlt - high carbon - ad alto tenore di carbonio - à haute teneur en carbone - altamente carbonizado

L legiert - alloyed - alligato/legato - allié - aleado

V ventiliert - ventilated - ventilato - ventilé - ventilado

● gelocht - perforated - perforato - poinçonné - perforado

		S	B	HC	L	V	A	B	C	D	E	F	G	H	I	OE - #	
24.0110-0313.1	410313						280,0	10,2	8,9	33,0	108,0	4	63,5	155,0	13,7	FORD	4411312
24.0110-0314.1	410314	S	B	HC			280,0	10,0	8,4	65,5	120,0	5	75,0	160,8	14,5	BMW	34 21 6 855 001
24.0110-0315.1	410315	S	B	HC			296,0	10,4	8,9	65,5	120,0	5	75,0	160,8	14,5	BMW	34 21 4 031 725 34 21 6 764 649 34 21 6 855 002
24.0110-0316.1	410316		B				288,0	10,0	8,5	69,8	114,3	5	62,0	190,0	14,5	LEXUS	42431-48041
24.0110-0317.1	410317						262,0	10,0	8,4	61,0	114,3	4	76,0	168,0	12,8	HYUNDAI KIA	58411-38310 58411-3C000
24.0110-0318.1	410318		B				262,0	10,0	8,4	61,0	114,3	5	76,0	168,0	12,6	HYUNDAI KIA	58411-39600 58411-39600
24.0110-0319.1	410319						295,0	10,0	8,8	88,0	120,7	5	73,8	180,0	13,4	JAGUAR	JLM 10601 JLM 12424 JLM 1830
24.0110-0320.1	410320		B				290,0	10,0	8,5	56,8	114,3	5	62,0	180,0	14,5	TOYOTA	42431-0F010
24.0110-0321.1	410321		B				260,0	10,0	8,0	49,0	114,3	5	64,2	140,4	12,6	HONDA	42510-SEA-E00 42510-SEA-E50
24.0110-0323.1	410323		B				264,0	10,0	8,0	40,5	100,0	4/6	60,0	136,8	14,0	FIAT	55700592 55700593
24.0110-0324.1	410324		B				234,0	10,0	8,0	37,5	100,0	4	62,5	142,0	12,6	OPEL HYUNDAI KIA	5 69 097/93167282 58411-0X500 58411-07300 58411-07500
24.0110-0325.2	410325		B				270,0	10,0	9,0	80,7	100,0	4	55,0	52,3	M12x1,5	RENAULT	77 01 207 898 86 71 018 107 86 60 001 812
24.0110-0326.1	410326						260,0	10,0	8,0	48,5	100,0	4	61,0	148,5	12,6	MG	SDB000290
24.0110-0328.1	410328	S	B				300,0	10,0	8,3	57,5	112,0	5	67,0	164,0	15,3	MERCEDES BENZ	204 423 15 12
24.0110-0329.1	410329	S	B				302,0	10,0	8,0	61,0	114,3	5	64,1	200,0	12,5	HONDA	42510-SWW-G01 42510-T1G-G01
24.0110-0330.1	410330		B				302,0	10,0	8,4	58,7	114,3	5	80,0	190,0	12,6	CITROEN MITSUBISHI PEUGEOT	4249 62 4615A035 4249 F4
24.0110-0331.1	410331	S	B	HC			280,0	9,6	8,0	38,0	112,0	3	58,0	153,5	12,5	SMART	451 421 01 12
24.0110-0332.1	410332		B				262,0	10,0	8,0	61,1	114,3	5	76,0	168,0	12,5	HYUNDAI	58411-1H100 58411-1H300 58411-1H100 58411-1H300
24.0110-0333.1	410333		B				280,0	10,0	8,5	59,2	114,3	5	62,0	173,0	14,7	TOYOTA	42431-05050
24.0110-0334.1	410334		B				258,0	10,0	8,0	41,4	114,3	4	76,0	154,0	13,0	KIA	58411-2F100
24.0110-0335.1	410335		B				291,0	10,0	8,5	61,3	114,3	5	62,0	190,0	14,5	LEXUS	43431-30280
24.0110-0336.1	410336		B				284,0	10,0	8,4	54,5	114,3	5	76,0	190,0	12,6	HYUNDAI/KIA	58411-3L000 58411-3L010
24.0110-0337.1	410337		B				270,0	9,9	8,0	36,8	114,3	5	62,0	166,0	14,8	TOYOTA	42431-02170 42431-12280
24.0110-0338.1	410338		B				262,0	10,0	8,4	61,0	114,3	5	76,0	168,0	12,5	HYUNDAI	58411-2H300
24.0110-0339.1	410339	S	B				278,0	10,0	8,0	42,0	110,0	5/7	65,5	149,0	14,0	OPEL/VAUXHALL	5 69 122/93184247
24.0110-0340.1	410340	S	B				258,0	10,5	8,0	57,2	114,3	4	60,0	168,0	12,6	CHEVROLET DAEWOO	96549630 96549630
24.0110-0341.1	410341		B				275,0	10,0	8,4	61,0	114,3	5	76,0	168,0	12,5	KIA	58411-1D000
24.0110-0344.1	410344		B				302,0	10,0	8,4	58,7	114,3	5	69,0	190,0	12,5	MITSUBISHI	MR955407
24.0110-0345.1	410345		B				262,0	10,0	8,4	60,1	114,3	5	80,0	168,0	12,5	MITSUBISHI	MN116332 4615A119
24.0110-0346.1	410346		B				298,0	10,0	8,5	64,4	114,3	5	62,0	190,0	14,5	TOYOTA	42431-28130
24.0110-0347.1	410347		B				264,0	10,0	8,0	40,5	110,0	5	70,0	136,8	14,0	OPEL/VAUXHALL	5 69 418/93190227
24.0110-0349.1	410349		B				251,0	10,0	9,0	40,5	98,0	4	59,0	128,0	13,2	ALFA ROMEO	51805559 51813705 51865104 51865132
24.0110-0350.1	410350		B				269,0	10,0	9,0	64,7	100,0	5	55,0	170,0	14,5	TOYOTA	42431-20320
24.0110-0351.1	410351	S	B	HC L			300,0	10,0	8,3	58,3	112,0	5	67,0	180,0	15,3	MERCEDES BENZ	230 423 07 12
24.0110-0352.1	410352		B	HC L			299,0	10,4	8,5	67,6	139,5	6	105,6	190,0	16,0	SSANG YONG	4840105101 4840105110
24.0110-0355.1	410355		B				290,0	10,0	8,0	46,0	139,5	5	108,2	183,0	12,8	SUZUKI	55211-76J00 55211-76J01
24.0110-0356.1	410356	S	B				272,0	9,7	8,0	48,2	112,0	9	65,0	174,5	15,3	AUDI/SEAT/SKODA/VW	1K0 615 601 AA
24.0110-0357.1	410357		B				258,0	10,0	8,0	40,5	114,3	5	76,0	154,0	12,5	HYUNDAI/KIA	58411-1P300
24.0110-0358.1	410358	S	B				280,0	10,0	8,4	50,2	120,0	5	79,0	151,8	16,5	MINI	34 21 9 811 539
24.0110-0359.1	410359	S	B				264,0	10,0	8,0	40,5	110,0	5/5	70,0	136,8	14,0/11,0	ALFA ROMEO	51806283 51815313
24.0110-0360.1	410360		B				302,0	10,0	8,4	60,1	114,3	5	80,0	168,0	12,6	CITROEN MITSUBISHI PEUGEOT	16 062 920 80 4615A121 16 062 920 80



Abmessungen Bremsscheiben

Dimensions brake discs - Misure dischi freno -

Dimensions Disques de frein - Medidas disco de freno

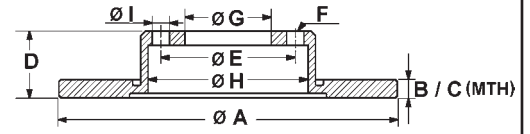

S Fixierschraube - fixing screw - vite di riparazione - vis de fixation - tornillo quefija

B beschichtet - coated - rivestito - revêtu - recubierto

HC hochgekohlt - high carbon - ad alto tenore di carbonio - à haute teneur en carbone - altamente carbonizado

L legiert - alloyed - alligato/legato - allié - aleado

V ventiliert - ventilated - ventilato - ventilé - ventilado

● gelocht - perforated - perforato - poinçonné - perforado

		S	B	HC	L	V	A	B	C	D	E	F	G	H	I	OE - #
24.0110-0361.1	410361		B				302,0	10,0	8,4	61,3	114,3	5	80,0	168,0	12,6	CHRYSLER FIAT JEEP LANCIA K04743999AA 4743 999AA K04743999AA
24.0110-0362.1	410362		B				262,0	10,0	8,4	63,8	114,3	5	76,0	168,0	12,6	KIA 58411-2K300
24.0110-0363.1	410363		B				262,0	10,0	8,4	60,2	114,3	5	80,0	168,0	12,6	CHRYSLER JEEP 5105 515AA 5105 515AA
24.0110-0364.1	410364		B				279,0	10,0	8,5	30,6	100,0	5	55,0	155,8	14,5	LEXUS 42431-52160
24.0110-0366.1	410366		B				286,0	10,0	8,5	63,5	100,0	5	58,0	190,0	13,0	SUBARU 26700FG000
24.0110-0367.1	410367		B				284,0	10,0	8,4	54,3	114,3	5	76,0	168,0	12,5	HYUNDAI 58411-3K110
24.0110-0368.1	410368		B				262,0	10,0	8,4	45,9	114,3	5	76,0	162,3	12,5	HYUNDAI 58411-3X300
24.0110-0369.1	410369		B				300,0	10,0	8,4	24,5	114,3	5	76,0	155,0	12,5	HYUNDAI 58411-3Z700
24.0110-0370.1	410370		B				284,0	10,0	8,4	24,7	114,3	5	76,0	154,5	12,5	HYUNDAI 58411-3Z100
24.0110-0378.1	410378		B				251,0	10,0	9,0	40,5	98,0	5	59,0	128,0	13,2	FIAT 51808471 51885409
24.0110-0379.1	410379		B	HC	L		262,0	10,0	8,4	45,1	114,3	5	76,0	162,0	12,5	HYUNDAI KIA 58411-A6300 58411-A6300
24.0110-0380.1	410380		B				276,0	10,0	8,0	31,6	114,3	5	64,0	143,0	12,7	HONDA 42510-TV0-E01
24.0110-0381.1	410381		B				303,0	10,0	8,0	39,8	114,3	5	68,0	143,0	13,0	MAZDA K011-26-251B
24.0110-0382.1	410382		S	B			295,0	10,0	8,3	44,0	112,0	5	67,0	161,0	15,2	MERCEDES BENZ 246 423 01 12 246 423 07 12
24.0110-0383.1	410383		B	HC	L		284,0	10,0	8,4	25,9	114,3	5	76,0	155,2	12,5	HYUNDAI/KIA 58411-A6200
24.0110-0384.1	410384		B				273,8	10,0	8,5	63,4	100,0	5	58,0	170,0	13,0	SUBARU 26700FJ000
24.0110-0388.1	410388		B	HC	L		284,0	10,0	8,4	55,3	114,3	5	76,0	168,0	12,5	HYUNDAI/KIA 58411-3S100
24.0110-0389.2	410389		B				270,0	10,0	9,0	80,7	108,0	5	52,0	55,0	M12x1,5	RENAULT 77 01 208 850
24.0110-0391.1	410391		S	B	HC	L	300,0	10,0	8,3	43,0	112,0	5	67,0	161,0	15,2	MERCEDES BENZ 000 423 16 12 172 423 02 12
24.0110-0392.1	410392		B				284,0	10,0	8,4	45,0	114,3	5	76,0	184,2	12,5	KIA 58411-A4000
24.0110-0393.1	410393		B				264,0	10,0	8,0	40,5	98,0	5	59,0	137,0	13,0	FIAT 51914664
24.0110-0394.1	410394		B				234,0	10,0	8,4	44,9	100,0	4	62,4	142,0	13,0	HYUNDAI 58411-B4300 58411-B9000
24.0110-0396.1	410396		S	B	HC		259,0	10,0	8,4	50,6	112,0	5	67,0	155,0	16,5	MINI 34 21 6 799 383
24.0110-0398.1	410398		B	HC			262,0	10,0	8,4	44,0	100,0	4	62,5	162,0	12,6	HYUNDAI KIA 58411-0U300 58411-0U300
24.0110-0700.1	410700						269,0	10,0	9,0	64,8	114,3	5	62,0	170,0	14,5	TOYOTA 42431-33010
24.0110-0704.1	410704		B				262,0	10,0	8,4	60,1	114,3	5	90,0	168,0	12,5	MITSUBISHI MB895200 MB928716
24.0110-0712.1	410712		B				288,0	10,0	8,5	60,0	114,3	5	62,0	170,0	14,5	LEXUS 42431-33080 42431-33140
24.0110-0714.1	410714						258,0	10,3	8,0	64,7	100,0	4	57,0	168,0	13,0	CHEVROLET DAEWOO 96312560 96312560
24.0110-0728.1	410728		B				273,8	10,0	8,5	67,5	100,0	5	58,0	170,0	13,0	SUBARU 26700AG001
24.0111-0100.2	411100		B				300,0	11,0	9,5	84,7	108,0	5	62,0	52,3	M14x1,5	RENAULT 82 00 649 353
24.0111-0101.2	411101		B				274,0	10,9	9,5	82,2	108,0	5	62,0	52,3	M12x1,5	RENAULT 86 71 018 108 86 60 001 813
24.0111-0115.1	411115		B				252,5	10,0	9,0	65,0	98,0	4	68,0	118,0	13,0	LADA 2101-3103002 2101-3501070
24.0111-0116.1	411116						238,0	11,0	8,0	55,5	92,0	4	73,0	112,5	10,5	OPEL/VAUXHALL 5 69 041/90272326
24.0111-0119.1	411119		B				240,5	11,0	9,2	40,0	98,0	4	59,0	123,0	13,0	ALFA/FIAT/LANCIA 7663465 7685656 46403960 51876438 60811879 71769481 71772238 51859078 71738421 1715410 BS51-1125-AA
24.0111-0120.1	411120						269,5	10,5	9,5	65,9	114,3	4	86,0	145,0	13,6	SAAB 8904575
24.0111-0122.1	411122						255,0	10,5	9,5	30,6	100,0	4	66,0	134,0	12,6	RENAULT 77 00 764 192 77 01 204 288
24.0111-0125.1	411125		B				230,0	11,0	8,4	43,8	114,3	4	67,4	142,0	12,6	HYUNDAI 51712-02110
24.0111-0127.1	411127		B				279,0	10,4	8,5	83,2	120,0	5/5	70,0	160,0	12,6	OPEL/VAUXHALL 5 69 201/90272329 5 69 203/90272330
24.0111-0129.1	411129						251,0	11,0	9,5	51,0	98,0	4	62,0	135,0	13,0	FIAT SEAT 4377102 SE022165002B
24.0111-0130.1	411130		B				227,0	10,8	9,0	45,8	98,0	4	62,0	117,0	13,0	AUTOB/FIAT/LANCIA SEAT 4385812 16500253 SE022165002A
24.0111-0133.1	411133		B				278,0	11,0	9,0	50,2	117,8	5	70,7	175,3	16,2	OPEL/VAUXHALL 5 69 110/9195294
24.0111-0137.1	411137		S	B			262,0	11,0	9,0	45,5	112,0	5	67,0	142,5	15,0	MERCEDES BENZ 201 421 12 12

Abmessungen Bremsscheiben

Dimensions brake discs - Misure dischi freno -

Dimensions Disques de frein - Medidas disco de freno

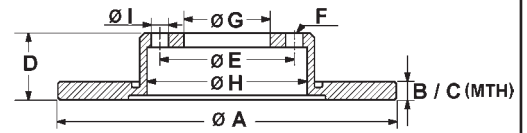

S Fixierschraube - fixing screw - vite di riparazione - vis de fixation - tornillo quefija

B beschichtet - coated - rivestito - revêtu - recubierto

HC hochgekohlt - high carbon - ad alto tenore di carbonio - à haute teneur en carbone - altamente carbonizado

L legiert - alloyed - alligato/legato - allié - aleado

V ventiliert - ventilated - ventilato - ventilé - ventilado

● gelocht - perforated - perforato - poinçonné - perforado

		S	B	HC	L	V	A	B	C	D	E	F	G	H	I	OE - #
24.0111-0139.1	411139						234,0	11,0	10,0	47,0	100,0	4	56,0	128,5	13,4	DAIHATSU 43512-87709-000 43512-87717-000 43512-87727-000
24.0111-0141.1	411141						256,0	10,8	8,0	41,1	100,0	6	60,0	123,0	14,3	OPEL/VAUXHALL 5 69 058/9117676
24.0111-0142.1	411142		B				240,5	11,0	9,2	40,0	98,0	5	59,0	123,0	13,0	ALFA ROMEO 60670804 71739571
24.0111-0144.1	411144		B				265,0	10,5	9,5	44,3	108,0	5	61,0	149,5	15,5	RENAULT 77 01 205 846 86 71 019 317
24.0111-0145.1	411145		S B				302,0	10,9	9,0	50,8	108,0	5	63,5	177,6	15,8	FORD 1379931 1385590 1405500 LAND ROVER LR027123
24.0111-0146.1	411146		B				302,0	11,0	9,4	71,5	114,3	5	69,0	190,0	12,5	HYUNDAI 58411-2B000
24.0111-0147.1	411147		S B				302,0	11,0	9,0	40,8	108,0	5	63,5	177,6	16,0	VOLVO 30769059
24.0111-0148.2	411148		B				274,0	10,9	9,5	82,2	100,0	4	62,0	52,3	M12x1,5	RENAULT 77 01 208 230
24.0111-0149.1	411149						240,5	11,0	9,2	40,0	98,0	4	59,0	124,5	13,0	ALFA ROMEO 60576335 60805117
24.0111-0150.1	411150						257,0	10,5	9,5	35,3	100,0	4	61,0	134,0	12,6	RENAULT 77 01 204 291
24.0111-0151.1	411151		B				265,0	10,5	9,5	54,3	108,0	5	66,0	149,6	15,5	RENAULT 60 25 304 079 60 25 370 406 86 71 012 048
24.0111-0152.1	411152		B				240,0	11,0	8,0	41,0	100,0	4/6	60,0	126,0	14,5	OPEL/VAUXHALL 5 69 020/9195981
24.0111-0153.1	411153		B				300,0	11,0	9,3	58,5	112,0	5	67,0	180,0	15,0	MERCEDES BENZ 220 423 01 12
24.0111-0154.1	411154		B				278,0	11,0	9,0	53,7	108,0	5	63,5	146,0	13,7	FORD 1362867 1362868 4367107 4457989 4475316 2T14-2A315-AC 2T14-2A315-BC
24.0111-0155.1	411155		B				265,0	11,0	9,0	40,8	108,0	5	63,5	152,0	13,7	FORD 1223540 1253728 1373360 1575733 1748745 9M51-2A315-BA 9M51-2A315-BB
24.0111-0158.1	411158		S B				280,0	11,0	9,0	41,0	108,0	5	63,5	192,0	13,7	FORD 1253962 1373361 1500156 VOLVO 7M51-2A315-BA 30769113 31341645
24.0111-0159.1	411159		B				211,0	11,0	10,0	40,9	100,0	4	55,1	125,0	13,2	DAIHATSU 43512-97204-000 43512-97207-000 43512-B2100-000
24.0111-0160.1	411160		B				280,0	11,0	9,0	40,8	114,3	5	72,0	154,0	14,0	MAZDA BP6Y-26-251D C25Y-26-251A C25Y-26-251B
24.0111-0164.1	411164		B				265,0	11,0	9,0	40,7	114,3	5	72,0	152,0	14,0	MAZDA BP4Y-26-251C C24Y-26-251C
24.0111-0165.1	411165		B				302,0	11,0	9,0	40,8	114,3	5	72,0	153,0	13,7	MAZDA C26Y-26-251A
24.0111-0166.2	411166		B				274,0	10,9	9,5	82,2	100,0	4	62,0	52,3	M12x1,5	RENAULT 86 60 001 815
24.0111-0167.2	411167		B				300,0	11,0	9,5	84,7	108,0	5	62,0	52,3	M12x1,5	RENAULT 82 00 663 193 86 71 018 264 86 71 019 319
24.0111-0168.1	411168		B				297,0	11,0	9,0	58,5	114,3	5	62,0	180,0	14,5	TOYOTA 42431-0F020
24.0111-0169.1	411169		B				290,0	11,0	9,0	33,7	114,3	5	62,0	155,0	14,5	TOYOTA 42431-05070
24.0111-0170.1	411170		B	HC L			302,0	11,0	9,4	71,5	114,3	5	69,0	190,0	12,5	HYUNDAI 58411-2P000 KIA 58411-2P000
24.0111-0171.1	411171		B				271,0	11,0	9,0	40,7	108,0	5	63,5	152,0	13,8	FORD 1704765
24.0111-0172.1	411172		B				280,0	11,0	9,0	50,7	108,0	5	63,5	153,5	13,7	FORD 1683383 AV61-2A315-BA 1683384 AV61-2A315-AA
24.0111-0173.2	411173		B				300,0	11,0	9,5	81,7	114,3	5	52,0	62,0	M14x1,5	RENAULT 40 20 200 03R 40 20 222 91R 43 20 000 15R
24.0111-0174.2	411174		B				274,0	11,0	9,5	88,2	108,0	5	52,0	62,0	M12x1,5	RENAULT 82 00 381 148
24.0111-0175.1	411175		S B	HC			290,0	11,0	9,4	66,0	120,0	5	75,0	160,8	16,5	BMW 34 21 6 792 225
24.0111-0180.2	411180		B				274,0	11,0	9,5	86,2	114,3	5	52,3	62,0	M12x1,5	RENAULT 40 20 296 46R
24.0111-0181.2	411181		B				300,0	11,0	9,5	101,7	114,3	5	52,0	62,0	M14x1,5	RENAULT 40 20 200 05R

Abmessungen Bremsscheiben

Dimensions brake discs - Misure dischi freno -

Dimensions Disques de frein - Medidas disco de freno

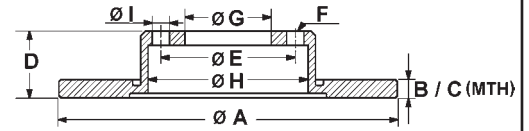

S Fixierschraube - fixing screw - vite di riparazione - vis de fixation - tornillo quejija

B beschichtet - coated - rivestito - revêtu - recubierto

HC hochgekohlt - high carbon - ad alto tenore di carbonio - à haute teneur en carbone - altamente carbonizado

L legiert - alloyed - alligato/legato - allié - aleado

V ventiliert - ventilated - ventilato - ventilé - ventilado

● gelocht - perforated - perforato - poinçonné - perforado

		S	B	HC	L	V	A	B	C	D	E	F	G	H	I	OE - #	
24.0111-0182.2	411182		B				274,0	11,0	9,5	88,2	108,0	5	52,0	62,0	M12x1,5	MERCEDES BENZ RENAULT	415 420 01 02 40 20 240 76R 43 20 043 27R
24.0111-0183.2	411183		B				300,0	11,0	9,5	102,2	108,0	5	52,3	62,0	M14x1,5	RENAULT	82 00 736 267
24.0111-0184.2	411184		B				290,0	11,0	9,5	90,2	114,3	5	52,3	62,0	M12x1,5	RENAULT	43 20 200 16R 40 20 205 36R
24.0111-0185.1	411185		B				204,0	11,0	9,5	50,8	108,0	5	63,5	177,3	13,8	FORD	5202204 DG9C-2A315-BC
24.0112-0102.1	412102						231,0	12,0	10,0	44,0	100,0	4	61,0	124,0	12,6	HONDA ROVER	45251-SB2-030 45251-SB2-732 DBP3169 GBD90810 GBD90818 GBD90827
24.0112-0106.1	412106	S	B				239,0	12,0	10,0	35,4	100,0	4	65,0	124,5	13,6	AUDI/SEAT/VW AUDI/VW	321 615 301 175 615 301
24.0112-0111.1	412111						284,0	12,0	10,4	76,0	120,0	5	79,0	146,0	14,5	BMW	34 11 1 163 134
24.0112-0112.1	412112						257,0	12,0	10,8	51,5	98,0	4	62,0	135,0	13,0	FIAT/LANCIA	4448411
24.0112-0115.1	412115						239,8	12,0	11,0	35,0	96,0	4	76,0	128,8	8,3	NISSAN	40206-05A01
24.0112-0116.1	412116	S	B				238,0	12,0	10,5	41,0	100,0	4	61,0	129,5	13,5	DACIA RENAULT	60 01 549 211 60 01 549 211 77 01 204 282 86 71 000 083
24.0112-0117.1	412117	S	B				284,0	12,0	10,0	46,5	112,0	5	67,0	154,3	15,0	MERCEDES BENZ	124 421 13 12
24.0112-0120.1	412120			HC			300,0	12,0	10,4	67,9	120,0	5	75,0	180,0	14,5	BMW	34 21 1 165 257
24.0112-0121.1	412121						214,0	12,0	10,0	43,2	100,0	4	59,0	125,5	12,5	NISSAN	40206-01B00 40206-01B01
24.0112-0122.1	412122						240,0	12,0	10,8	46,5	98,0	4	59,0	127,5	13,0	AUTOB/FIAT/LANCIA	71738423
24.0112-0123.1	412123						240,3	12,0	11,0	45,1	100,0	4	61,0	126,5	12,6	NISSAN	40206-61A01 40206-61A11
24.0112-0124.1	412124	S	B	HC			302,0	12,0	10,4	76,0	120,0	5	79,0	149,0	14,5	BMW	34 11 1 161 693
24.0112-0125.1	412125		B				239,0	12,0	10,8	42,5	98,0	4	58,5	127,0	13,1	LADA	2108-3501070
24.0112-0126.1	412126	S	B				286,0	12,0	10,4	51,5	120,0	5	79,0	148,0	14,5	BMW	34 11 6 757 750 34 11 6 757 751
24.0112-0127.1	412127		B				257,5	12,0	10,2	40,5	98,0	4	59,0	123,0	13,0	ALFA/FIAT/LANCIA	7663466 46820655 51859075 51866265 60808872 51866264
24.0112-0128.1	412128	S	B				284,0	12,0	10,0	43,5	112,0	5	67,0	154,3	12,8	MERCEDES BENZ	202 421 02 12
24.0112-0129.1	412129		B	HC			290,0	12,0	9,8	60,0	112,0	5	67,0	164,0	17,0	MERCEDES BENZ	140 423 06 12
24.0112-0130.1	412130						272,0	11,0	9,9	50,5	140,0	5	108,0	157,0	14,5	LADA	2121-3501070
24.0112-0131.1	412131		B				286,0	12,0	10,0	69,5	110,0	5	65,5	160,0	14,0	OPEL/VAUXHALL	5 69 208/90444513
24.0112-0132.1	412132	S	B	HC			324,0	12,0	10,4	61,0	120,0	5	75,0	180,0	14,5	BMW	34 21 6 757 748
24.0112-0133.1	412133						253,8	12,0	10,5	54,2	108,0	5	66,0	134,0	14,7	RENAULT	77 01 467 307
24.0112-0134.1	412134						253,8	12,0	10,5	54,2	100,0	4	66,0	134,0	12,6	RENAULT	77 01 467 306
24.0112-0135.1	412135						260,0	12,0	10,8	40,0	100,0	4/6	61,0	127,0	13,0	VOLVO	3459661
24.0112-0136.2	412136						251,0	12,0	10,8	62,3	108,0	5	71,0	134,7	13,0	CITROEN	95 661 796
24.0112-0137.1	412137		B				234,0	12,0	10,0	45,2	100,0	4	59,0	129,5	12,5	NISSAN	40206-5F003
24.0112-0138.1	412138	S	B				280,0	12,0	10,0	40,4	112,0	5	68,2	153,0	16,5	VOLKSWAGEN	701 615 601 A 7D0 615 601 7D0 615 601 B
24.0112-0139.1	412139						214,0	12,0	10,0	46,2	100,0	4	61,0	126,6	12,6	NISSAN	40206-21B01
24.0112-0141.1	412141		B				239,5	12,0	10,0	42,9	108,0	4	63,5	136,0	13,7	FORD MAZDA	1013581 1019598 1112542 1E03-33-251 1E03-33-251A 1E04-33-251
24.0112-0142.1	412142	S	B	HC	L		258,0	12,0	10,0	96,7	130,0	5	85,0	160,0	15,0	MERCEDES BENZ VOLKSWAGEN	901 423 06 12 901 423 08 12 901 423 10 12 2D0 615 601 2D0 615 601 C
24.0112-0143.1	412143						251,0	12,0	10,8	62,4	108,0	4	71,1	135,0	13,0	CITROEN	4246 L6
24.0112-0144.1	412144	S	B	HC	L		260,0	12,0	10,0	40,4	112,0	5	67,0	145,0	13,3	MERCEDES BENZ	168 421 01 12
24.0112-0145.1	412145						265,6	12,0	10,6	48,0	139,7	6	96,5	171,6	12,6	ISUZU	8-94173-244-0 8-94173-244-2
24.0112-0147.1	412147						234,5	12,0	10,0	45,0	100,0	4	55,0	124,5	13,0	MAZDA	DB0Y-33-251
24.0112-0148.1	412148		B				255,0	12,0	10,0	40,0	112,0	5/9	68,0	144,5	15,3	AUDI	8E0 615 601 D 8E0 615 601 Q
24.0112-0149.1	412149		B				290,0	12,0	10,3	56,0	112,0	5	67,0	164,0	13,0	MERCEDES BENZ	210 423 05 12
24.0112-0150.1	412150		B				277,0	11,9	10,0	71,0	108,0	5	68,0	160,0	16,5	VOLVO	272301

Abmessungen Bremsscheiben

Dimensions brake discs - Misure dischi freno -

Dimensions Disques de frein - Medidas disco de freno

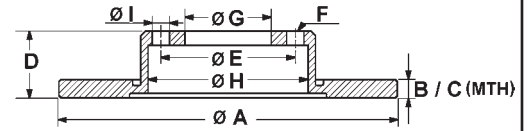

S Fixierschraube - fixing screw - vite di riparazione - vis de fixation - tornillo quefija

B beschichtet - coated - rivestito - revêtu - recubierto

HC hochgekohlt - high carbon - ad alto tenore di carbonio - à haute teneur en carbone - altamente carbonizado

L legiert - alloyed - alligato/legato - allié - aleado

V ventiliert - ventilated - ventilato - ventilé - ventilado

● gelocht - perforated - perforato - poinçonné - perforado

		S	B	HC	L	V	A	B	C	D	E	F	G	H	I	OE - #	
24.0116-0100.1	416100		B				280,0	16,0	13,0	78,6	112,0	5	88,0	133,5	12,5	MERCEDES BENZ	601 420 02 72 601 421 04 12
24.0116-0104.1	416104		B				258,0	16,0	13,0	95,5	112,0	5	45,2	67,9	M14x1,5	VOLKSWAGEN	251 407 617 M
24.0116-0105.1	416105		B				256,0	16,1	13,5	64,1	118,0	5	73,0	141,0	15,5	ALFA/FIAT	7531819 60809894 93500520
																CITROEN PEUGEOT	4246 N5 4246 B4 4249 L1
24.0116-0106.1	416106						290,0	16,0	14,8	61,0	118,0	5	73,0	141,0	15,5	CITROEN FIAT PEUGEOT	ZF 93 500 521 93500521 4246 H3
24.0116-0107.2	416107		B				238,5	16,0	14,5	79,0	140,0	5	102,0	138,0	M14x1,5	MERCEDES BENZ	631 420 03 72
24.0116-0108.1	416108						260,0	16,0	13,0	64,0	112,0	5	68,2	144,0	16,5	VOLKSWAGEN	701 615 301 C
24.0116-0109.1	416109						258,0	16,0	13,0	57,5	112,0	5	67,0	135,0	15,5	VOLKSWAGEN	251 407 615 Q
24.0116-0110.1	416110	S	B	HC	L		272,0	16,0	14,0	96,7	130,0	5	85,0	160,0	15,0	MERCEDES BENZ	902 423 03 12 902 423 05 12
																VOLKSWAGEN	2D0 615 601 A 2D0 615 601 D
24.0116-0116.2	416116		B				280,0	16,0	13,0	68,7	160,0	5	96,0	120,0	M10x1,5	FORD	1451161
24.0116-0117.1	416117		B				273,0	16,0	15,0	37,5	114,3	5	66,5	162,0	14,0	DAIHATSU	43512-87402-000
24.0116-0118.1	416118					V	234,0	16,0	14,0	37,0	88,0	4	70,0	111,0	M10	DAIHATSU	43512-87220-000
24.0116-0119.1	416119		B			V	292,0	16,0	14,0	62,0	114,3	5	68,0	172,0	12,7	NISSAN	43206-8H305 43206-8H700 43206-8H701 43206-8H702
																RENAULT	43 20 031 12R
24.0116-0120.1	416120		B			V	234,0	16,0	15,0	40,9	100,0	4	55,1	125,0	13,2	DAIHATSU	43512-97202-000
24.0116-0121.1	416121	S	B				298,0	16,0	14,0	71,0	130,0	6	85,0	180,0	15,0	MERCEDES BENZ VOLKSWAGEN	906 423 00 12 2E0 615 601 A
24.0116-0122.1	416122		B			V	308,0	16,0	14,0	62,0	114,3	5	68,0	190,0	12,8	NISSAN	43206-CA000
24.0116-0123.1	416123		B				300,0	16,0	14,2	80,0	130,0	5	79,0	172,0	17,5	CITROEN	4249 42 4249 K6
																FIAT	51740250 51749555
																PEUGEOT	4249 41 4249 K6 16 078 806 80
24.0116-0124.1	416124		B				280,0	16,0	14,2	82,0	118,0	5	72,0	172,0	15,6	CITROEN	4246 Y7 4249 K7 4249 L0
																FIAT	46833806 51740245 51749274
																PEUGEOT	51848617 4246 Y9 4249 K7 4249 L0
																	16 078 804 80
24.0116-0125.1	416125		B				280,0	16,0	14,2	82,0	130,0	5	79,0	172,0	17,5	CITROEN	4246 Z1 4249 K8 4249 K9
																FIAT	46833807 51740248 51749275
																PEUGEOT	51856412 4246 Z3 4249 K8 4249 K9
																	16 078 805 80
24.0116-0126.1	416126		B				280,0	16,0	13,0	16,3	124,0	5/10	107,5	144,5	10,7	FORD	1464031
24.0116-0127.1	416127					V	211,0	16,0	14,0	41,0	88,0	4	70,0	97,0	M10x1,25	DAIHATSU	43512-87215-000
24.0116-0128.1	416128						276,0	16,0	13,0	69,5	118,0	5	73,0	145,0	15,5	IVECO	42471034
24.0116-0129.1	416129						276,0	16,0	13,0	69,5	118,0	5	73,0	145,0	15,5	IVECO	2991646
24.0116-0130.1	416130		B			V	234,0	16,0	15,0	41,0	100,0	4	55,0	125,0	14,0	DAIHATSU SUBARU	43512-B1050-000 43512B1050
24.0116-0132.1	416132		B				280,0	16,0	13,0	62,1	127,0	6	108,0	164,5	10,8	NISSAN	43206-MB600
24.0116-0133.1	416133	S	B				303,0	16,0	13,0	83,0	130,0	5	85,0	158,5	15,0	MERCEDES BENZ	461 421 00 12 461 421 00 12
24.0116-0134.1	416134		B				284,0	16,0	13,0	43,9	124,0	10	107,1	148,0	10,7	FORD	1488311 8C1V-2A315-AA

Abmessungen Bremsscheiben

Dimensions brake discs - Misure dischi freno -

Dimensions Disques de frein - Medidas disco de freno

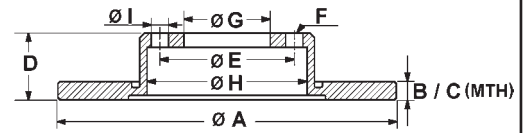

S Fixierschraube - fixing screw - vite di riparazione - vis de fixation - tornillo quefija

B beschichtet - coated - rivestito - revêtu - recubierto

HC hochgekohlt - high carbon - ad alto tenore di carbonio - à haute teneur en carbone - altamente carbonizado

L legiert - alloyed - alligato/legato - allié - aleado

V ventiliert - ventilated - ventilato - ventilé - ventilado

● gelocht - perforated - perforato - poinçonné - perforado

		S	B	HC	L	V	A	B	C	D	E	F	G	H	I	OE - #	
24.0117-0101.1	417101					V	231,0	17,0	15,0	44,0	100,0	4	61,0	124,0	12,6	HONDA ROVER	45251-SB2-932 45251-SB2-940 DBP7954 GBD90803 GBD90814 GBD90825
24.0117-0103.1	417103	B				V	231,2	17,0	15,0	50,0	114,3	4	64,0	137,5	12,8	SUBARU SUZUKI	5531180F03 55311-60B20 55311-72F00 55311M72F00
24.0117-0104.1	417104					V	287,0	17,0	15,0	46,1	140,0	5	107,0	183,0	13,0	SUZUKI	55211-56B00
24.0117-0105.1	417105	B				V	231,0	17,0	15,0	49,2	100,0	4	60,0	125,0	12,8	SUZUKI	55311-75F00 55311-M75F00
24.0117-0106.1	417106	B				V	253,0	17,0	15,0	49,0	100,0	4	60,0	153,0	12,5	OPEL/VAUXHALL SUBARU SUZUKI	47 06 749/93176389 47 07 288/93179462 5531186G02 55311-84E01 55311-86G02
24.0117-0107.1	417107	B				V	246,0	17,0	16,0	41,9	100,0	4	55,1	137,0	13,2	DAIHATSU	43512-97402-000
24.0117-0108.1	417108	B				V	257,0	17,0	15,0	49,2	100,0	4	60,0	151,0	12,7	SUZUKI	55311-80G02
24.0117-0109.1	417109					V	287,0	17,0	15,0	29,0	140,0	5	108,2	181,7	13,0	SUZUKI	55211-65D01
24.0117-0110.1	417110	B				V	257,0	17,0	15,0	38,3	100,0	4	64,0	123,5	12,6	CITROEN MITSUBISHI PEUGEOT	4249 L5 4615A093 4249 L5
24.0118-0101.1	418101					V	238,0	18,0	16,0	31,0	94,0	4	75,0	143,5	10,5	MAZDA	B107-33-251 BF68-33-251A
24.0118-0104.1	418104					V	242,0	18,0	16,0	43,9	90,0	4	70,0	100,0	M10	SUBARU	25431GA171 25431GA200
24.0118-0105.1	418105	B				V	282,0	18,0	15,0	64,5	112,0	5	68,2	144,0	16,5	VOLKSWAGEN	701 615 301 E
24.0118-0106.1	418106	S	B	HC		V	239,0	18,0	16,0	34,5	100,0	4	65,0	125,0	13,6	SEAT/VW VOLKSWAGEN	6N0 615 301 C 6N0 615 301 F
24.0118-0107.1	418107	B				V	240,0	18,0	16,0	45,2	100,0	4	61,0	130,0	12,6	NISSAN	40206-58A00 40206-58A01 40206-60Y01
24.0118-0108.1	418108	B				V	280,0	18,0	15,9	65,5	118,0	5	73,0	141,3	15,5	CITROEN FIAT PEUGEOT	4246 J9 1300500080 4246 J8
24.0118-0109.1	418109					V	242,0	18,0	16,4	34,0	104,0	4	86,0	126,0	10,6	MITSUBISHI	MB316677 MB366434
24.0118-0110.1	418110					V	238,0	18,0	17,0	48,2	100,0	4	54,1	127,0	14,5	TOYOTA	43512-12250 43512-12300 43512-12310 43512-12330 43512-12440 43512-12480
24.0118-0111.1	418111	S	B	HC		V	282,0	18,0	15,0	55,0	112,0	5	68,2	144,0	16,5	VOLKSWAGEN	701 615 301 G
24.0118-0112.1	418112					V	236,0	18,0	16,4	34,0	104,0	4	86,0	141,0	10,6	MITSUBISHI	MB618734 MB618735
24.0118-0113.1	418113	B				V	235,0	18,0	16,0	45,0	100,0	4	55,0	125,0	13,0	MAZDA	NA01-33-25X NA01-33-25XA NA01-33-25XC
24.0118-0115.1	418115					V	212,0	18,0	15,5	36,5	94,0	4	65,1	99,0	M10x1,25	SUBARU	725431150 725431312
24.0118-0116.1	418116					V	240,0	18,0	15,5	36,5	94,0	4	65,1	150,5	M10x1,25	SUBARU	725431321
24.0118-0117.1	418117					V	247,0	18,0	16,0	45,2	100,0	4	61,0	130,0	12,7	NISSAN	40206-0M802
24.0118-0118.1	418118					V	232,0	18,0	16,0	45,2	100,0	4	61,0	130,0	12,8	NISSAN	40206-0M602
24.0118-0119.1	418119					V	291,0	18,0	17,0	68,4	114,3	5	60,0	190,0	14,5	TOYOTA	42431-14110
24.0118-0120.1	418120	B				V	236,0	18,0	16,4	45,0	100,0	4	64,0	126,0	12,6	MITSUBISHI	MB699283 MB950922 MR449769 MB699283
24.0118-0121.1	418121					V	277,0	18,0	17,0	32,5	118,0	5	96,0	176,0	10,6	PROTON DAIHATSU	43512-87608-000
24.0118-0122.1	418122	B				V	313,5	18,0	16,6	80,2	139,6	6	101,0	210,0	12,6	ISUZU OPEL/VAUXHALL	97034036 5 69 104/97034036 5 69 106/91151563
24.0118-0124.1	418124	B				V	238,0	18,0	17,0	42,8	100,0	4	55,0	127,0	14,6	TOYOTA	43512-16070 43512-16120
24.0118-0125.1	418125					V	242,0	18,0	16,0	52,5	100,0	5	58,0	128,0	13,0	SUBARU	26310AA012
24.0118-0126.1	418126					V	234,5	18,0	17,0	47,0	100,0	4	56,0	128,5	13,0	DAIHATSU	43512-87710-000 43512-87718-000 43512-87725-000
24.0118-0129.1	418129	B				V	302,0	18,0	16,0	46,2	114,3	5	62,0	156,7	14,6	TOYOTA	43512-42010
24.0118-0131.1	418131	B				V	235,0	17,9	16,0	43,2	100,0	4	55,0	129,5	14,5	TOYOTA	43512-0D010 43512-52050

Abmessungen Bremsscheiben

Dimensions brake discs - Misure dischi freno -

Dimensions Disques de frein - Medidas disco de freno

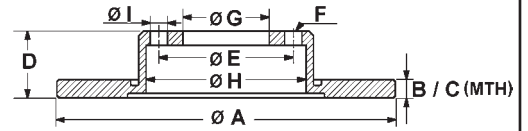

S Fixierschraube - fixing screw - vite di riparazione - vis de fixation - tornillo quejija

B beschichtet - coated - rivestito - revêtu - recubierto

HC hochgekohlt - high carbon - ad alto tenore di carbonio - à haute teneur en carbone - altamente carbonizado

L legiert - alloyed - alligato/legato - allié - aleado

V ventiliert - ventilated - ventilato - ventilé - ventilado

● gelocht - perforated - perforato - poinçonné - perforado

		S	B	HC	L	V	A	B	C	D	E	F	G	H	I	OE - #
24.0118-0136.1	418136					V	316,0	18,0	16,0	80,0	139,7	6	111,0	189,0	12,8	NISSAN 43206-05J04 43206-VB000
24.0118-0137.1	418137	S	B	HC		V	239,0	18,0	16,0	35,0	100,0	5	65,0	125,0	15,6	SKODA/VW VOLKSWAGEN 6Q0 615 301 6Q0 615 301 A
24.0118-0138.1	418138		B			V	234,0	18,0	16,0	50,7	100,0	4	62,2	126,0	12,6	HYUNDAI 51712-02551
24.0118-0139.1	418139		B			V	238,0	18,0	16,0	46,2	100,0	4	59,0	130,0	12,5	NISSAN 40206-1F500 40206-72B00
24.0118-0140.1	418140		B			V	315,0	18,0	16,4	84,2	139,7	6	108,0	197,0	12,5	mitsubishi MB618797
24.0118-0141.1	418141					V	266,0	18,0	16,4	60,2	114,3	4	90,0	168,0	12,6	HYUNDAI 58411-M2050 KIA 58411-M2050
24.0118-0143.1	418143		B			V	329,2	18,0	16,0	102,6	150,0	5	110,0	230,0	16,7	LEXUS/TOYOTA 42431-60220 42431-60221 42431-60280 42431-60281
24.0118-0144.1	418144		B			V	252,0	18,0	16,0	49,0	100,0	4	62,2	126,0	12,6	HYUNDAI 51712-0X700 51712-B9000
24.0118-0145.1	418145		B			V	241,0	18,0	16,0	49,0	100,0	4	62,2	126,0	12,6	KIA HYUNDAI 51712-0X500 KIA 51712-07500
24.0118-0146.1	418146		B			V	332,0	18,0	16,0	74,4	139,7	6	94,0	210,0	12,8	MITSUBISHI 4615A037
24.0118-0147.1	418147		B			V	310,0	18,0	16,5	67,2	114,3	5	62,0	190,0	14,5	LEXUS 42431-30290
24.0118-0148.1	418148		B			V	286,0	18,0	16,0	58,7	114,3	5	72,0	190,0	13,0	MAZDA LE44-26-251A
24.0118-0149.1	418149		B			V	302,0	18,0	16,0	43,3	114,3	5	72,0	142,8	13,0	MAZDA F151-26-251A
24.0118-0150.1	418150		B			V	301,6	18,0	16,0	56,6	114,3	5	72,0	190,0	13,0	MAZDA L206-26-251B
24.0118-0151.1	418151		B			V	256,0	18,0	16,0	46,9	100,0	4	62,2	126,0	12,5	HYUNDAI 51712-1J500
24.0118-0153.1	418153		B			V	302,0	18,0	15,0	51,0	140,0	8	120,0	164,0	10,9	OPEL/VAUXHALL 44 21 180/93168942 NISSAN 43206-00Q0C RENAULT 43 20 679 43R
24.0118-0154.1	418154		B			V	324,0	18,0	16,0	67,0	114,3	5	69,0	210,0	12,5	HYUNDAI 58411-3J500
24.0118-0158.1	418158		B			V	324,6	18,0	16,0	56,7	114,3	5	72,0	190,0	13,0	MAZDA L232-26-251C
24.0118-0709.1	418709		B			V	312,0	18,0	16,0	68,0	139,7	6	106,0	210,0	14,5	TOYOTA 42431-60200 LEXUS/TOYOTA 42431-60201
24.0118-0724.1	418724		B			V	308,0	18,0	16,0	62,7	114,3	5	68,0	190,0	12,7	NISSAN 43206-EB300
24.0118-0725.1	418725		B			V	290,0	18,0	16,0	67,4	100,0	5	58,0	170,0	13,0	SUBARU 26700AE080 26700AE081
24.0119-0104.1	419104					V	242,0	19,0	17,0	49,6	100,0	4	61,0	126,7	12,6	HONDA 45251-SE0-010
24.0119-0106.1	419106					V	242,0	19,0	17,0	44,1	100,0	4	61,0	122,0	12,6	HONDA 45251-SB2-990
24.0119-0107.1	419107	S	B	HC		V	276,0	19,0	17,4	60,3	120,0	5	75,0	160,8	14,5	BMW 34 21 6 855 155 34 21 6 864 903
24.0119-0108.1	419108	S	B	HC		V	294,0	18,9	17,4	59,7	120,0	5	75,0	160,8	14,8	BMW 34 21 1 165 563 34 21 6 864 056
24.0119-0109.1	419109		B			V	242,0	19,1	17,0	40,5	104,0	4	86,0	143,0	M10x1,25	HYUNDAI 51712-24100
24.0119-0111.1	419111					V	242,0	19,2	17,0	37,2	104,0	4	86,0	126,0	10,4	HYUNDAI 51712-28000 51712-28000D
24.0119-0112.1	419112	S	B	HC		V	294,0	19,0	17,4	74,7	120,0	5	75,0	160,8	14,7	BMW 34 21 6 794 303
24.0119-0113.1	419113	S	B	HC		V	294,0	19,0	17,4	60,5	120,0	5	75,0	184,0	14,7	BMW 34 21 1 166 165
24.0119-0114.1	419114		B			V	241,0	19,0	17,0	52,1	100,0	4	62,2	126,0	12,5	HYUNDAI 51712-25060 51712-25061
24.0119-0115.1	419115		B			V	241,0	19,0	17,0	47,8	100,0	4	62,2	126,0	12,5	NISSAN 51712-1C000
24.0119-0116.1	419116		B			V	256,0	19,0	17,0	47,9	100,0	4	62,2	125,0	12,5	HYUNDAI 51712-1C050
24.0120-0103.1	420103			HC	L	V	282,5	20,5	19,1	35,3	126,0	5	107,0	145,0	8,4	PORSCHE 477 405 083 A 911 351 041 20
24.0120-0104.1	420104			HC	L	V	289,0	20,0	18,6	100,0	130,0	5	103,0	180,0	15,4	PORSCHE 944 352 041 03
24.0120-0108.1	420108					V	260,0	20,0	18,0	54,0	98,0	5	58,0	127,0	13,0	CITROEN 5 429 669 S 75 529 364
24.0120-0112.1	420112		B	HC	L	V	289,0	19,9	18,7	71,2	130,0	5	102,8	180,0	15,6	PORSCHE 944 352 041 02
24.0120-0113.1	420113			HC		V	300,0	20,0	18,4	68,0	120,0	5	75,0	180,0	14,5	BMW 34 21 1 162 967
24.0120-0114.2	420114		B			V	281,0	19,9	18,0	80,5	115,0	5	91,0	128,5	M14x1,5	VOLKSWAGEN 281 615 283 A
24.0120-0115.1	420115	S	B	HC	L	V	236,0	20,0	17,0	41,0	100,0	4/6	60,0	123,0	14,0	CHEVROLET 90121445 DAEWOO 90121445 OPEL/VAUXHALL 5 69 054/90511111
24.0120-0119.1	420119					V	295,0	20,0	18,0	29,0	137,0	6	104,0	178,0	M12x1,25	NISSAN 40206-37J01 40206-C7000 40206-C7001 40206-G9500
24.0120-0120.1	420120			HC		V	256,0	20,0	18,0	41,9	108,0	4	68,0	134,0	15,4	AUDI 853 615 301 A 853 615 301 C
24.0120-0122.1	420122		B			V	308,0	20,0	18,0	64,5	108,0	5	68,0	178,0	16,5	VOLVO 8624926
24.0120-0123.1	420123	S	B	HC	L	V	239,0	20,0	18,0	39,0	100,0	4	65,0	123,8	13,6	AUDI/SEAT/VW 321 615 301 C
24.0120-0125.1	420125	S	B			V	238,0	20,1	17,7	41,0	100,0	4	61,0	128,0	12,5	NISSAN 40206-00QAJ RENAULT 77 01 204 286 86 71 000 085
24.0120-0126.1	420126		B			V	259,0	20,2	17,7	46,4	100,0	4	61,0	130,0	12,8	RENAULT 77 00 715 081 77 01 204 283

Abmessungen Bremsscheiben

Dimensions brake discs - Misure dischi freno -

Dimensions Disques de frein - Medidas disco de freno

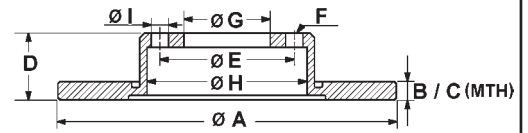

S Fixierschraube - fixing screw - vite di riparazione - vis de fixation - tornillo quefija

B beschichtet - coated - rivestito - revêtu - recubierto

HC hochgekohlt - high carbon - ad alto tenore di carbonio - à haute teneur en carbone - altamente carbonizado

L legiert - alloyed - alligato/legato - allié - aleado

V ventiliert - ventilated - ventilato - ventilé - ventilado

● gelocht - perforated - perforato - poinçonné - perforado

		S	B	HC	L	V	A	B	C	D	E	F	G	H	I	OE - #
24.0120-0128.1	420128						256,0	20,0	18,0	38,8	100,0	4	65,0	131,5	13,8	SEAT/VW 321 615 301 D 6N0 615 301 D
24.0120-0129.1	420129						257,4	20,0	18,2	51,7	98,0	4	59,0	127,0	13,0	ALFA/FIAT/LANCIA 60810227 82464702
24.0120-0130.1	420130						255,0	20,0	18,4	45,0	108,0	6	87,0	115,0	10,5	MITSUBISHI MB151387
24.0120-0131.1	420131						247,0	20,4	18,5	44,2	108,0	4	66,0	133,2	12,8	CITROEN PEUGEOT 4246 A6 91 517 694
24.0120-0132.1	420132	S	B				247,0	20,4	18,5	34,2	108,0	4	66,0	133,2	12,8	PEUGEOT CITROEN PEUGEOT 95 661 747 4246 A7 4249 96
24.0120-0133.1	420133	S	B				266,0	20,5	18,5	27,6	108,0	4	66,0	133,0	13,0	CITROEN 4249 F0 E169002 PEUGEOT 4246 97 4249 F0
24.0120-0134.1	420134						265,0	20,5	17,7	31,6	100,0	4	61,0	127,0	12,8	RENAULT 77 00 764 193 77 01 467 955
24.0120-0135.1	420135						244,0	20,5	17,7	31,6	100,0	4	61,0	127,0	12,5	RENAULT 77 00 758 901 77 01 204 954 77 01 467 954
24.0120-0137.1	420137		B				269,0	19,9	18,0	46,0	112,0	5	68,0	156,0	15,5	AUDI 447 615 601 A
24.0120-0139.1	420139						255,5	20,0	18,4	33,5	104,0	5	84,0	84,5	10,6	MITSUBISHI MB238495
24.0120-0140.1	420140	S	B	HC	L		256,0	20,0	17,0	41,0	100,0	4/6	60,0	123,0	14,0	OPEL/VAUXHALL 5 69 055/90511128
24.0120-0142.1	420142		B	HC	L		257,5	20,0	18,2	40,5	98,0	4	59,0	126,7	13,0	ALFA/FIAT/LANCIA 7779409 71738145 51749124 60806137 60810076 60811256 60811266
24.0120-0143.1	420143						240,0	20,0	18,2	46,5	98,0	4	59,0	124,5	13,0	FIAT 7650707
24.0120-0146.1	420146		B				253,0	20,0	18,0	43,7	108,0	4	63,5	153,0	13,7	FORD 4115996 5026786
24.0120-0147.1	420147		B				239,5	20,0	18,0	43,0	108,0	4	63,5	136,0	13,7	FORD/MAZDA 1019604 1066271 1320581 1320582 5028281
24.0120-0148.1	420148						238,0	20,1	17,7	46,0	100,0	4	61,0	132,0	12,5	RENAULT 77 01 466 782
24.0120-0152.1	420152						242,0	20,0	18,0	49,2	114,3	4	68,0	138,0	12,5	NISSAN 40206-90J01
24.0120-0153.1	420153						302,0	20,0	19,0	48,0	139,7	6	100,0	166,5	15,0	TOYOTA 43512-60011 43512-60040 43512-69015 43512-69016
24.0120-0154.1	420154	S	B	HC			298,0	20,0	18,4	61,3	120,0	5	75,0	185,0	14,5	BMW 34 21 1 164 175 34 21 6 767 060
24.0120-0155.1	420155		B	HC	L		257,5	20,0	18,2	40,5	98,0	5	59,0	126,7	16,5	CITROEN FIAT PEUGEOT 4249 L4 1316323080 4246 H8
24.0120-0157.1	420157						251,0	20,0	18,0	45,8	98,0	4	62,0	159,5	13,0	SEAT SE021165002A
24.0120-0159.1	420159						257,0	20,0	18,2	40,5	98,0	5	59,0	126,4	13,2	ALFA/FIAT 46425960
24.0120-0162.1	420162						243,0	20,0	18,0	42,5	100,0	4	57,0	136,0	13,0	KIA 0K20A-33-251A
24.0120-0163.1	420163						235,0	20,0	18,0	49,5	100,0	4	60,0	125,2	12,7	SUZUKI 55311-61G01
24.0120-0166.1	420166						253,0	20,0	18,4	28,6	104,0	5	84,0	148,0	10,6	HYUNDAI 58129-44010
24.0120-0168.1	420168						289,0	20,0	18,0	64,2	127,0	6	100,0	156,0	10,7	TOYOTA 43512-35190 VOLKSWAGEN J43 512 351 90
24.0120-0169.1	420169		B				255,0	20,0	18,0	45,0	100,0	4	55,0	125,0	13,0	MAZDA N026-33-25X
24.0120-0171.1	420171		B				286,0	20,0	18,0	67,0	110,0	5	65,5	160,0	14,0	OPEL/VAUXHALL 5 69 100/9195052
24.0120-0172.1	420172		B	HC	L		269,0	19,9	18,0	59,5	112,0	5/10	68,0	156,0	15,3	AUDI 857 615 601
24.0120-0173.1	420173	S	B				292,0	19,9	18,0	41,4	110,0	5	65,5	162,5	14,0	FIAT 46836490 71772548 OPEL/VAUXHALL SAAB 5 69 114/93171778 9191336 12762291
24.0120-0174.1	420174	S	B				240,0	20,0	17,0	41,0	100,0	4/6	60,0	126,0	14,0	OPEL/VAUXHALL 5 69 021/9195985
24.0120-0175.1	420175		B				255,0	20,0	18,0	43,1	100,0	4	55,0	129,0	14,5	TOYOTA 43512-0D050 43512-17120 43512-17130 43512-17131 43512-52040 43512-52090
24.0120-0176.1	420176		B	HC	L		292,0	20,0	18,0	67,0	130,0	5	98,0	164,0	15,4	PORSCHE 986 352 401 04
24.0120-0177.1	420177						242,0	20,0	18,0	43,5	100,0	4	57,0	136,0	13,0	KIA 0K2AA-33-251A 0K2AA-33-251B 0K2AA-33-251C

Abmessungen Bremsscheiben

Dimensions brake discs - Misure dischi freno -

Dimensions Disques de frein - Medidas disco de freno

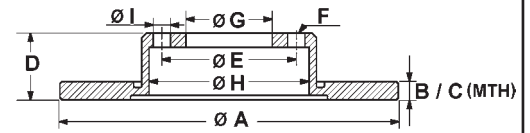

S Fixierschraube - fixing screw - vite di riparazione - vis de fixation - tornillo quefija

B beschichtet - coated - rivestito - revêtu - recubierto

HC hochgekohlt - high carbon - ad alto tenore di carbonio - à haute teneur en carbone - altamente carbonizado

L legiert - alloyed - alligato/legato - allié - aleado

V ventiliert - ventilated - ventilato - ventilé - ventilado

● gelocht - perforated - perforato - poinçonné - perforado

		S	B	HC	L	V	A	B	C	D	E	F	G	H	I	OE - #	
24.0120-0237.1	420237	S	B	HC		V	300,0	20,0	18,4	66,0	120,0	5	75,0	160,8	16,5	BMW	34 21 6 792 227
24.0120-0238.1	420238		B	HC		V	326,0	20,0	18,0	38,0	108,0	5	64,5	160,4	14,0	JAGUAR	C2C 25339 C2D 26352
24.0120-0240.1	420240	S	B	HC		V	300,0	20,0	18,4	66,0	120,0	5	75,0	185,0	16,5	BMW	34 21 6 792 229 34 21 6 864 900
24.0120-0243.1	420243	S	B	HC		V	330,0	20,0	18,4	66,2	120,0	5	75,0	185,0	16,5	BMW	34 21 6 864 899
24.0120-0708.1	420708		B			V	288,0	20,0	18,5	32,5	108,0	5	64,5	160,0	14,0	JAGUAR	JLM 20802 XR8 27087
24.0121-0100.1	421100					V	285,0	21,0	19,0	51,2	114,3	4	64,1	141,0	12,7	HONDA ROVER	45251-SG9-000 GBD90800 GBD90822
24.0121-0101.1	421101					V	285,0	21,0	19,0	31,8	108,0	5	61,0	134,0	14,5	RENAULT	77 00 801 101 77 01 204 298
24.0121-0102.1	421102					V	262,0	21,0	19,0	51,2	100,0	4	64,2	141,0	12,6	HONDA	45251-SF0-000
24.0121-0103.1	421103					V	285,0	21,0	19,0	31,8	100,0	4	61,0	134,0	12,5	RENAULT	77 00 801 213 77 01 204 299
24.0121-0104.1	421104	S	B			V	240,0	21,0	19,0	44,8	100,0	4	61,0	126,0	13,0	HONDA	45251-SH1-A00 45251-SH3-A00 45251-SR3-A10
24.0121-0105.1	421105	S	B			V	262,0	21,0	19,0	44,7	100,0	4	64,1	141,0	13,0	HONDA	45251-S5D-A10 45251-S6D-E10 45251-SCC-901 45251-SK7-A00 45251-SK7-A10 45251-SR0-A00 45251-SR0-A10 45251-ST3-E10 45251-TF3-E00 45251-TG5-H00
24.0121-0106.1	421106	S	B			V	259,0	20,7	17,7	41,0	100,0	4	61,0	130,0	12,7	ROVER NISSAN DACIA/RENAULT	GBD90840 SDB000990 40206-00QAA 60 01 548 578 77 00 842 131 77 01 204 828 77 01 206 339 77 11 130 038 86 71 005 976
24.0121-0107.1	421107					V	262,0	21,0	19,0	47,2	100,0	4	64,1	141,0	13,0	HONDA ROVER	45251-SK3-E00 GBD90830
24.0121-0110.1	421110					V	262,0	21,0	18,0	51,0	114,3	4	64,1	141,0	12,6	ROVER	GBD90801
24.0121-0112.1	421112		B	HC	L	V	282,0	20,5	19,0	74,2	130,0	5	103,0	155,0	15,4	PORSCHE	944 351 041 05
24.0121-0113.1	421113	S	B			V	240,0	21,0	19,0	39,2	100,0	4	61,0	126,5	13,0	HONDA	45251-S50-G00 45251-SAA-G11
24.0121-0114.1	421114		B			V	277,0	21,0	18,0	51,0	114,3	5	66,1	141,0	12,5	LAND ROVER	SDB101070
24.0121-0115.1	421115	S	B			V	258,0	21,0	19,0	39,2	100,0	4	64,1	141,3	12,6	HONDA	45251-SAA-G50
24.0121-0702.1	421702	S	B			V	262,0	21,0	19,0	47,2	114,3	5	64,2	141,0	12,6	HONDA	45251-S6M-000 45251-SNA-000
24.0122-0100.1	422100		B	HC		V	280,0	22,0	20,0	28,5	100,0	5	65,0	141,0	15,6	SEAT/VW	1H0 615 301 A
24.0122-0101.1	422101		B	HC		V	280,0	22,0	20,0	39,5	100,0	4	65,0	137,0	13,6	SEAT/VW	535 615 301
24.0122-0103.1	422103	S	B	HC		V	302,0	22,0	20,4	76,0	120,0	5	79,0	149,0	14,5	BMW	34 11 1 160 936
24.0122-0106.1	422106					V	278,0	22,0	20,0	66,3	112,0	5	80,0	127,5	15,0	MERCEDES BENZ	116 420 02 05
24.0122-0107.1	422107		B			V	284,0	22,0	20,2	39,4	98,0	4	59,0	127,0	13,0	ALFA/FIAT/LANCIA	46403958 46427947 46427949 60811890 60812067 60812137
24.0122-0108.1	422108		B	HC		V	256,0	22,0	20,0	56,5	108,0	4	68,0	132,7	15,4	AUDI	895 615 301 A
24.0122-0109.1	422109					V	271,0	22,0	19,0	59,4	108,0	5	88,0	130,0	10,5	OPEL/VAUXHALL	5 69 029/90008004
24.0122-0111.1	422111					V	280,0	22,0	20,4	78,0	120,0	5	74,0	143,0	14,5	BMW	34 11 1 119 563 34 11 1 163 130
24.0122-0112.1	422112					V	255,0	22,0	20,4	75,0	100,0	4	63,0	128,0	14,5	BMW	34 11 1 163 126
24.0122-0115.1	422115	S	B	HC		V	286,0	22,0	20,4	51,5	120,0	5	79,0	147,5	14,5	BMW	34 11 1 165 455 34 11 6 766 239 34 11 6 794 301 34 11 6 864 060
24.0122-0116.1	422116					V	278,0	22,0	19,4	68,3	112,0	5	80,0	127,5	15,0	MERCEDES BENZ	126 420 00 05 126 421 00 12
24.0122-0118.1	422118		B			V	256,0	22,0	20,0	46,5	108,0	4	68,0	132,7	15,4	AUDI	443 615 301 B
24.0122-0119.2	422119					V	269,0	22,0	20,0	51,5	98,0	5	72,0	120,0	M12x1,5	ALFA ROMEO	60522092
24.0122-0120.1	422120			HC	L	V	280,0	22,0	20,0	46,5	112,0	5	68,0	158,0	15,4	AUDI	437 615 301 A
24.0122-0122.1	422122		B	HC	L	V	260,0	22,0	20,4	35,0	100,0	4	66,0	138,0	14,5	BMW	34 11 1 160 915

Abmessungen Bremsscheiben

Dimensions brake discs - Misure dischi freno -

Dimensions Disques de frein - Medidas disco de freno

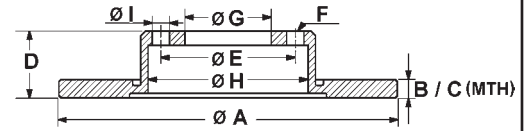

S Fixierschraube - fixing screw - vite di riparazione - vis de fixation - tornillo quefija

B beschichtet - coated - rivestito - revêtu - recubierto

HC hochgekohlt - high carbon - ad alto tenore di carbonio - à haute teneur en carbone - altamente carbonizado

L legiert - alloyed - alligato/legato - allié - aleado

V ventiliert - ventilated - ventilato - ventilé - ventilado

● gelocht - perforated - perforato - poinçonné - perforado

	S	B	HC	L	V	A	B	C	D	E	F	G	H	I	OE - #	
24.0122-0123.1	422123	S	B	HC	L	V	284,0	22,0	19,4	43,5	112,0	5	67,0	154,3	15,0	MERCEDES BENZ 124 421 16 12 124 421 27 12
24.0122-0124.1	422124		B	HC	L	V	262,0	22,0	19,4	44,5	112,0	5	67,0	142,5	15,0	MERCEDES BENZ 201 421 15 12
24.0122-0126.1	422126				V	271,0	22,0	19,0	59,4	108,0	5	94,0	130,0	10,5	OPEL/VAUXHALL 5 69 032/90008007	
24.0122-0127.1	422127				V	263,0	22,0	20,4	67,3	108,0	5	68,0	139,0	16,5	VOLVO 270739	
24.0122-0128.1	422128				V	239,2	22,0	20,2	46,1	98,0	4	58,5	127,4	13,0	ALFA ROMEO 60514881	
24.0122-0129.1	422129				V	250,0	22,0	20,0	49,2	114,3	4	68,0	144,0	12,5	NISSAN 40206-15E00 40206-15E01	
24.0122-0130.1	422130				V	257,2	22,0	20,2	50,7	98,0	4	59,0	127,0	13,2	ALFA/FIAT/LANCIA 46445005 60805172 60807625	
24.0122-0132.1	422132	S	B	HC	L	V	284,0	22,0	19,4	43,5	112,0	5	67,0	154,3	12,8	MERCEDES BENZ 202 421 09 12
24.0122-0133.1	422133			HC		V	300,0	22,0	19,4	60,0	112,0	5	67,0	164,0	17,0	MERCEDES BENZ 140 423 04 12
24.0122-0134.1	422134		B	HC	L	V	284,0	22,0	19,4	43,5	112,0	5	67,0	152,0	15,0	MERCEDES BENZ 124 421 23 12
24.0122-0135.1	422135				V	284,0	22,0	20,4	76,0	120,0	5	79,0	147,0	14,5	BMW 34 11 1 163 136	
24.0122-0136.1	422136		B	HC	L	V	295,0	22,0	19,4	49,5	112,0	5	67,0	154,3	15,0	MERCEDES BENZ 124 421 15 12
24.0122-0137.1	422137				V	287,0	22,0	20,0	56,0	108,0	5	68,0	157,0	14,0	VOLVO 1359908	
24.0122-0138.1	422138				V	262,5	22,0	20,0	56,0	108,0	5	68,0	139,0	14,0	VOLVO 1359906	
24.0122-0139.1	422139		B	HC		V	280,0	22,0	20,0	56,5	108,0	4	68,0	146,0	15,4	AUDI 8A0 615 301 E
24.0122-0140.1	422140			HC		V	280,0	22,0	19,0	78,6	112,0	5	88,0	133,5	12,5	MERCEDES BENZ 601 420 03 72 601 421 05 12
24.0122-0141.1	422141				V	276,0	22,0	20,0	48,0	108,0	5	71,0	130,5	13,0	CITROEN PEUGEOT 4246 E8	
24.0122-0142.1	422142		B	HC	L	V	283,0	22,0	20,0	28,2	108,0	4	66,1	133,5	13,0	CITROEN 4249 97 4246 V0 4246 V3
24.0122-0143.1	422143				V	280,0	22,0	20,0	58,0	108,0	5	61,0	131,5	14,7	PEUGEOT RENAULT 77 00 767 602 77 01 204 289	
24.0122-0145.1	422145		B		V	284,0	22,0	20,2	43,5	98,0	5	59,0	127,0	13,0	ALFA/FIAT/LANCIA 46445006 60569163 60571548 60653478 60699518 71739567 71739568	
24.0122-0146.1	422146		B		V	257,0	22,0	20,0	49,2	114,3	4	68,0	144,0	12,6	OPEL/VAUXHALL NISSAN 5 69 086/95511282 40206-71E02 40206-71E05 40206-71E06 40206-93J01	
24.0122-0147.1	422147		B		V	284,0	22,0	20,2	43,5	98,0	4	59,0	127,0	13,0	ALFA/FIAT/LANCIA 46403959 46448168 46455892 46455892 46758714 60810404 82450657	
24.0122-0148.1	422148	S	B	HC	L	V	262,0	22,0	19,8	44,0	100,0	4	61,0	132,0	13,5	CITROEN PEUGEOT 4249 76 4249 75
24.0122-0149.1	422149			HC	L	V	262,0	22,0	19,8	44,0	108,0	5	61,0	132,0	15,5	RENAULT 77 01 205 840
24.0122-0150.1	422150	S	B	HC		V	280,0	22,0	19,0	36,7	100,0	5	65,0	133,5	15,6	RENAULT 77 01 205 841
24.0122-0151.1	422151	S	B	HC		V	256,0	22,0	19,0	36,7	100,0	5	65,0	133,5	15,6	AUDI/SEAT/SKODA/VW 1J0 615 301 E 1J0 615 301 M 1J0 615 301 P
24.0122-0152.1	422152	S	B	HC		V	280,0	22,0	20,0	46,3	112,0	5/9	68,0	146,5	15,3	AUDI/SEAT/SKODA/VW 1J0 615 301 D 1J0 615 301 L 6R0 615 301 8Z0 615 301 D
24.0122-0153.1	422153				V	238,0	22,0	21,0	47,9	100,0	4	54,0	127,0	14,5	AUDI/SEAT/SKODA/VW 8E0 615 301 B 8E0 615 301 D 8E0 615 301 P	
24.0122-0154.1	422154				V	255,0	22,0	21,0	47,9	100,0	5	54,0	131,0	14,5	TOYOTA 43512-20260 43512-32090 43512-32180	
24.0122-0155.1	422155				V	258,0	22,0	20,4	33,5	104,0	5	84,0	153,5	10,8	MITSUBISHI MB407030	
24.0122-0156.1	422156				V	257,0	22,0	20,6	36,0	109,0	6	88,0	152,5	M12x1,25	ISUZU 8-94172-376-1	
24.0122-0158.1	422158		B		V	255,0	22,0	20,0	48,1	100,0	4	55,0	131,1	14,5	OPEL/VAUXHALL 5 69 801/94172376 TOYOTA 43512-12550	
24.0122-0159.1	422159	S	B	HC		V	296,0	22,0	20,4	76,3	120,0	5	79,0	148,8	14,5	BMW 34 11 6 767 061
24.0122-0160.1	422160	S	B	HC		V	300,0	22,0	20,4	51,8	120,0	5	79,0	164,0	14,5	BMW 34 11 1 164 539 34 11 6 757 526 34 11 6 766 224 34 11 6 864 058 34 11 6 794 302

Abmessungen Bremsscheiben

Dimensions brake discs - Misure dischi freno -

Dimensions Disques de frein - Medidas disco de freno

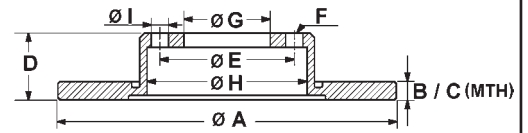

S Fixierschraube - fixing screw - vite di riparazione - vis de fixation - tornillo quefija

B beschichtet - coated - rivestito - revêtu - recubierto

HC hochgekohlt - high carbon - ad alto tenore di carbonio - à haute teneur en carbone - altamente carbonizado

L legiert - alloyed - alligato/legato - allié - aleado

V ventiliert - ventilated - ventilato - ventilé - ventilado

● gelocht - perforated - perforato - poinçonné - perforado

		S	B	HC	L	V	A	B	C	D	E	F	G	H	I	OE - #
24.0122-0161.1	422161	S	B	HC	L	V	276,0	22,0	19,0	77,2	130,0	5	85,0	156,3	15,0	MERCEDES BENZ VOLKSWAGEN 902 421 06 12 902 421 07 12 902 421 09 12 2D0 615 301 C 2D0 615 301 D
24.0122-0162.1	422162	S	B	HC	L	V	276,0	22,0	19,0	60,0	112,0	5	67,0	153,0	15,0	MERCEDES BENZ 638 421 01 12
24.0122-0163.1	422163		B	HC		V	256,0	22,0	20,0	36,6	100,0	5	65,0	135,0	15,6	AUDI/SEAT/SKODA/VW 8N0 615 601 B
24.0122-0164.1	422164					V	256,0	22,0	20,0	40,0	100,0	4/6	61,0	149,5	13,0	VOLVO 3455719
24.0122-0165.1	422165					V	257,0	22,0	20,0	45,0	100,0	4	55,0	125,0	13,0	MAZDA BB7E-33-25XD BR74-33-25X
24.0122-0166.1	422166		B			V	235,0	22,0	20,0	45,0	100,0	4	55,0	125,0	13,0	MAZDA BR70-33-25XF
24.0122-0167.1	422167					V	250,0	22,0	20,0	30,0	95,0	4	73,0	140,0	10,8	NISSAN 40206-04C01 40206-Y9503
24.0122-0168.1	422168	S	B	HC	L	V	260,0	22,0	19,4	40,4	112,0	5	67,0	145,0	13,3	MERCEDES BENZ 168 421 02 12 168 421 08 12
24.0122-0169.1	422169					V	257,0	22,0	20,0	44,0	114,3	4	69,0	160,0	12,6	HYUNDAI 51712-33001
24.0122-0170.1	422170					V	257,0	22,0	20,0	34,0	104,0	4	86,0	160,5	10,6	HYUNDAI 51712-28300
24.0122-0172.1	422172		B			V	258,0	22,0	20,0	43,4	108,0	4	63,5	136,0	13,7	FORD 1808479 98AX-1125-B1F
24.0122-0174.1	422174					V	280,0	22,0	20,0	49,0	114,3	5	68,0	160,5	12,6	MAZDA DD32-33-25X DD59-33-25X DD63-33-25XA
24.0122-0175.1	422175					V	277,0	22,0	20,4	45,0	108,0	6	87,0	87,5	11,0	NISSAN 40206-2L903 40206-88E01 40206-88E04
24.0122-0177.1	422177					V	240,5	22,0	20,0	43,0	95,2	4	66,0	122,0	13,0	HYUNDAI MN116706
24.0122-0178.1	422178		B			V	255,0	22,0	20,0	46,5	100,0	5	54,0	148,5	14,5	MITSUBISHI MB407038 MB407039 MN116706
24.0122-0179.1	422179		B			V	280,0	22,0	20,0	49,2	114,3	4	68,0	143,5	12,5	MG/ROVER NAM7806
24.0122-0180.1	422180					V	267,0	22,0	20,0	39,5	124,0	6	100,0	167,0	M10x1,25	TOYOTA 43512-20360 43512-20380
24.0122-0181.1	422181					V	280,0	22,2	20,7	77,0	114,0	5	72,0	147,5	15,5	NISSAN 40206-2F501 40206-55F01 40206-55F03
24.0122-0183.1	422183		B			V	279,0	22,0	20,0	52,5	114,3	5	62,0	147,0	14,6	JEEP 40206-10W00 40206-10W01 40206-35G00 40206-35G01
24.0122-0185.1	422185					V	319,0	22,0	20,0	70,2	139,7	6	108,0	173,0	14,6	TOYOTA 83 03 251 156 98 83 251 156 J325 1156
24.0122-0188.1	422188					V	258,0	22,0	21,0	48,0	100,0	4	54,0	131,0	14,6	TOYOTA 43512-12490
24.0122-0191.1	422191					V	281,0	22,0	20,2	47,5	108,0	5/10	59,0	134,0	14,7	LANCIA 46449389 82487489
24.0122-0192.1	422192		B	HC	L	V	300,0	22,0	19,4	58,5	112,0	5	67,0	180,0	15,0	MERCEDES BENZ 220 423 02 12
24.0122-0193.1	422193					V	250,0	22,0	20,0	50,2	114,3	5	68,0	140,0	12,7	NISSAN 40206-9C001
24.0122-0194.1	422194	S	B			V	266,0	22,0	20,0	34,2	108,0	4	66,0	133,1	13,0	CITROEN 4246 W1 4249 83 4249 G1 4246 W7 4249 83 4249 G1
24.0122-0196.1	422196		B	HC	L	V	285,0	21,9	19,0	93,0	145,0	6	120,0	169,0	15,0	MERCEDES BENZ 904 423 03 12
24.0122-0197.1	422197		B			V	257,5	22,0	20,2	40,5	98,0	4	59,0	127,0	13,0	VOLKSWAGEN 2D0 615 601 B CITROEN 4249 74 4249 L2
24.0122-0198.1	422198		B	HC		V	269,0	21,9	20,0	46,4	112,0	5	68,0	135,0	15,3	FIAT/LANCIA 46401356 46542383 46831041 51896287 51896288
24.0122-0199.1	422199		B	HC	L	V	270,0	22,0	19,4	35,5	112,0	5	67,0	145,0	13,3	PEUGEOT 4249 73 4249 L2
24.0122-0200.1	422200					V	310,0	22,0	20,0	29,0	140,0	5	108,3	181,2	13,0	AUDI 4D0 615 601 B
24.0122-0201.1	422201	S	B			V	300,0	22,0	19,4	68,0	112,0	5	67,0	180,0	15,3	MERCEDES BENZ 414 421 00 12
24.0122-0202.1	422202		B	HC		V	280,0	22,0	20,0	42,4	112,0	5	68,0	158,5	15,3	SUZUKI 55211-65D12
24.0122-0203.1	422203		B	HC		V	269,0	22,0	20,0	47,9	112,0	5/10	68,0	135,0	15,3	MERCEDES BENZ 000 423 09 12 AUDI/VW 4E0 615 601 4E0 615 601 E 4E0 615 601 J 4Z7 615 601

Abmessungen Bremsscheiben

Dimensions brake discs - Misure dischi freno -

Dimensions Disques de frein - Medidas disco de freno

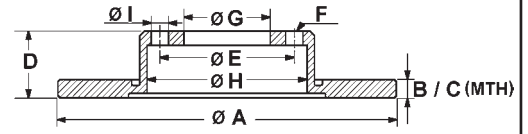

S Fixierschraube - fixing screw - vite di riparazione - vis de fixation - tornillo quejija
 B beschichtet - coated - rivestito - revêtu - recubierto
 HC hochgekohlt - high carbon - ad alto tenore di carbonio - à haute teneur en carbone - altamente carbonizado
 L legiert - alloyed - alligato/legato - allié - aleado
 V ventiliert - ventilated - ventilato - ventilé - ventilado
 ● gelocht - perforated - perforato - poinçonné - perforado

		S	B	HC	L	V	A	B	C	D	E	F	G	H	I	OE - #		
24.0122-0254.1	422254		B			V	275,0	22,0	19,0	46,5	100,0	4	55,0	131,0	14,5	TOYOTA	43512-52130	
24.0122-0255.1	422255					V	302,0	22,0	20,0	35,0	108,0	5	71,1	132,7	13,0	CITROEN	96 879 907 80	
24.0122-0256.1	422256		B			V	275,0	22,0	19,0	46,3	114,3	5	62,0	145,0	14,8	TOYOTA	43512-12670	
24.0122-0257.1	422257		S	B	HC	V	324,0	22,0	20,4	77,3	120,0	5	75,0	185,0	14,5	BMW	34 21 6 778 649	
24.0122-0258.1	422258		B			V	255,0	22,0	20,0	49,3	100,0	5	55,0	131,0	14,5	TOYOTA	43512-47030	
24.0122-0259.1	422259		S	B	HC	V	302,0	22,0	20,0	40,8	108,0	5	63,5	165,0	15,8	VOLVO	31341483	
24.0122-0260.1	422260		B			V	256,0	22,0	20,0	46,6	100,0	4	62,2	126,0	12,5	HYUNDAI KIA	51712-1G000 51712-1G000 51712-1W250	
24.0122-0261.1	422261		B		HC	V	302,0	22,0	20,0	50,7	108,0	5	63,5	165,0	15,7	VOLVO	31471033	
24.0122-0262.1	422262					V	276,0	22,0	19,0	72,5	118,0	5	73,0	145,0	15,5	IVECO	42470836	
24.0122-0263.1	422263		B			V	254,0	22,0	20,0	42,0	100,0	4	55,0	137,0	13,0	DAIHATSU SUBARU	43512-B1030-000 43512B1030	
24.0122-0264.1	422264		B			V	290,0	22,0	19,0	78,0	127,0	8	110,0	172,0	10,7	NISSAN	43206-MA50A 43207-9X100	
24.0122-0266.1	422266		B	HC	L	V	290,0	22,0	19,0	42,5	120,0	10	102,0	144,3	10,5	RENAULT	50 10 260 604	
24.0122-0267.1	422267		B	HC	L	V	290,0	22,0	19,0	78,0	132,0	8	115,0	172,0	10,8	RENAULT	50 10 260 609	
24.0122-0268.1	422268		B			V	322,0	22,0	20,2	62,0	114,3	5	68,0	172,0	12,7	NISSAN	43206-CD005	
24.0122-0270.1	422270		S	B	HC	V	258,0	22,0	19,8	44,0	100,0	4	61,0	125,3	13,5	MERCEDES BENZ DACIA RENAULT	415 420 01 01 40 20 612 00R 40 20 670 16R 77 01 210 081 40 20 612 00R 40 20 675 01R	
24.0122-0271.1	422271		S	B	HC	V	294,0	22,0	20,4	45,2	120,0	5	79,0	152,0	16,5	MINI	34 11 9 804 828 34 11 9 811 537	
24.0122-0272.1	422272		S	B	HC	V	330,0	21,9	20,0	36,0	112,0	5	68,0	147,7	15,3	AUDI	4H0 615 601 D 4H0 615 601 H 4H0 615 601 K 95B 615 601 A	
24.0122-0273.1	422273		S	B	HC	V	356,0	22,0	20,0	36,2	112,0	5	68,0	159,8	15,3	NISSAN	4H0 615 601 F	
24.0122-0276.1	422276		B			V	275,0	22,0	19,0	46,3	100,0	5	55,0	131,0	14,5	AUDI SUBARU TOYOTA	4351212710 43512-12710	
24.0122-0277.1	422277		B			V	260,0	22,0	20,0	44,0	100,0	4	61,0	130,0	12,8	NISSAN	40206-1HA0A	
24.0122-0278.1	422278		S	B	HC	V	300,0	22,0	20,4	73,0	120,0	5	79,0	152,0	16,5	BMW	34 11 6 792 217	
24.0122-0280.1	422280		B			V	256,0	22,0	20,0	40,2	100,0	4	60,0	132,8	12,5	SUZUKI	55311-68L00	
24.0122-0281.1	422281		S	B	HC	V	256,0	22,0	19,0	36,7	100,0	4	65,0	132,0	13,8	SEAT/SKODA/VW	1S0 615 301 H	
24.0122-0282.1	422282		B			V	272,0	22,0	20,0	40,2	100,0	4	60,0	150,0	12,5	SUZUKI	55311-68L50	
24.0122-0283.1	422283		B			V●	284,0	22,0	20,2	43,5	98,0	4	59,0	127,0	13,2	FIAT	5741446	
24.0122-0286.1	422286		B			V	284,0	22,0	20,0	43,5	98,0	5	59,0	127,0	13,5	FIAT	51937217 51937218	
24.0122-0287.1	422287		S	B	HC	L	●	330,0	22,0	19,4	54,0	112,0	5	67,0	184,0	15,0	MERCEDES BENZ	166 423 04 12
24.0122-0288.1	422288		S	B	HC	L	●	330,0	22,0	19,4	54,0	112,0	5	67,0	184,0	15,0	MERCEDES BENZ	166 423 01 12
24.0122-0289.1	422289		S	B	HC	L	V	258,0	22,0	19,8	43,9	100,0	4	61,0	126,5	13,5	DACIA RENAULT	40 20 631 49R 40 20 622 12R 40 20 676 15R 453 420 01 00
24.0122-0290.1	422290		B			V	280,0	22,0	20,0	47,0	114,3	5	62,0	146,3	12,7	SMART SUZUKI	55311-61M00	
24.0122-0292.1	422292		S	B	HC	V	280,0	22,0	20,4	45,1	112,0	5	67,0	150,5	16,5	BMW/MINI	34 11 6 866 295	
24.0122-0724.1	422724		B			V	300,0	22,0	20,4	72,3	139,7	6	94,0	199,0	12,6	MITSUBISHI	MR418067	
24.0123-0100.1	423100					V	246,0	23,0	21,0	55,5	92,0	4	73,0	115,0	10,6	OPEL/VAUXHALL	5 69 036/90009433	
24.0123-0101.1	423101					V	280,0	23,4	21,5	43,5	108,0	4	68,0	152,8	15,0	SAAB	4002150 8965550	
24.0123-0102.1	423102					V	282,0	23,0	21,0	34,0	114,3	4	92,0	160,0	M10x1,25	HONDA ROVER	45251-SM4-G02 GBD90837	
24.0123-0103.1	423103					V	260,0	23,0	21,0	34,0	114,3	4	92,0	160,0	M10x1,25	HONDA ROVER	45251-SM4-020 GBD90836	
24.0123-0104.1	423104		S	B		V	282,0	23,0	21,0	47,1	114,3	5	70,2	148,5	12,6	HONDA	45251-S2H-N00 45251-SP0-000 45251-SZ3-000 45251-SZ3-E00	
24.0123-0105.1	423105					V	260,0	23,0	21,0	47,2	114,3	4	64,1	141,0	12,8	HONDA	45251-S1A-G60 45251-SS0-000	
24.0123-0106.1	423106					V	282,0	23,0	21,0	47,2	114,3	4	64,1	141,0	13,0	HONDA	45251-SS0-A00 45251-ST3-E60	
24.0123-0108.1	423108					V	295,0	22,5	21,0	66,5	120,7	5	80,0	154,3	13,4	JAGUAR	JLM 1305	
24.0123-0109.1	423109		S	B		V	282,0	23,0	21,0	47,1	114,3	5	64,1	141,0	12,5	HONDA	45251-S7A-N10 45251-SCA-E00	
24.0123-0110.1	423110		S	B		V	282,0	23,0	21,0	47,2	114,3	5	64,2	141,0	12,6	HONDA	45251-S7A-E10 45251-SMG-G10 45251-SMG-E31	
24.0123-0111.1	423111		S	B		V	260,0	23,0	21,0	44,5	100,0	4	64,1	141,5	13,0	HONDA	45251-S6F-E10	
24.0123-0112.1	423112		B		HC	V	258,0	23,0	21,0	43,9	100,0	4	55,0	135,8	13,0	MAZDA	DF71-33-251	

Abmessungen Bremsscheiben

Dimensions brake discs - Misure dischi freno -

Dimensions Disques de frein - Medidas disco de freno

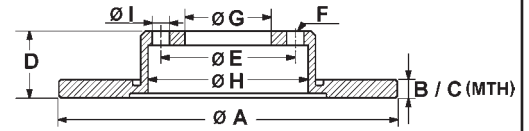

S Fixierschraube - fixing screw - vite di riparazione - vis de fixation - tornillo quefija

B beschichtet - coated - rivestito - revêtu - recubierto

HC hochgekohlt - high carbon - ad alto tenore di carbonio - à haute teneur en carbone - altamente carbonizado

L legiert - alloyed - alligato/legato - allié - aleado

V ventiliert - ventilated - ventilato - ventilé - ventilado

● gelocht - perforated - perforato - poinçonné - perforado

		S	B	HC	L	V	A	B	C	D	E	F	G	H	I	OE - #	
24.0123-0113.1	423113		B	HC		V	258,0	23,0	21,0	43,8	108,0	4	63,5	136,0	13,0	FORD	1523795 1535924 1546835 1679853 8V51-1125-AC 8V51-1125-AD
24.0123-0114.1	423114	S	B			V	315,0	22,9	21,5	48,0	120,0	5	67,4	172,0	16,3	CHEVROLET OPEL/VAUXHALL	13501314 5 69 062/13501303 5 69 128/13502199 13502199
24.0123-0116.1	423116	S	B			V	315,0	23,0	20,0	45,0	115,0	5	70,7	172,0	14,2	OPEL	5 69 093/13586855
24.0123-0119.1	423119	S	B	HC		V	269,0	22,5	19,8	44,1	114,3	5	68,0	141,0	15,7	DACIA/RENAULT	40 20 663 00R
24.0123-0122.1	423122		B			V	278,0	23,0	21,0	43,9	108,0	4	63,5	136,0	13,0	FORD	1751584 AY11-1125-AA 1833857 EY16-1125-AA
24.0123-0123.1	423123		B	HC		V	280,0	23,1	21,0	44,4	114,3	5	69,0	143,4	12,7	HYUNDAI/KIA	51712-A6000
24.0124-0103.1	424103		B			V	252,5	24,0	22,0	53,5	95,0	6	76,0	105,0	M10x1,5	OPEL/VAUXHALL RENAULT	44 03 283/9111283 77 01 204 281
24.0124-0105.1	424105					V	264,0	24,0	22,0	46,5	114,3	5	64,0	137,0	12,6	FORD MAZDA	E92Z 1125A GJ25-33-25XD GJ55-33-25XC
24.0124-0107.1	424107					V	270,0	24,0	22,6	71,2	100,0	5	78,6	138,5	M10	FORD	5022675
24.0124-0109.1	424109					V	260,0	24,2	22,2	51,6	112,0	5	72,0	137,0	13,7	FORD	6158214
24.0124-0110.1	424110					V	280,0	24,0	21,0	58,4	110,0	5	70,0	139,0	14,0	OPEL/VAUXHALL	5 69 038/90271133
24.0124-0111.1	424111		B			V	258,0	24,0	21,0	58,4	110,0	5	70,0	139,0	14,0	OPEL/VAUXHALL	5 69 039/90271134
24.0124-0112.1	424112		B			V	239,5	24,2	22,2	58,1	108,0	4	63,5	136,0	13,7	FORD	5022659 5022660 5022948 5023573
24.0124-0113.1	424113					V	260,0	24,2	22,2	58,1	108,0	4	63,5	136,0	13,7	FORD	1102560 5022663
24.0124-0114.1	424114					V	266,0	24,0	22,4	45,2	114,3	4	69,0	144,0	12,6	MITSUBISHI	MB366080 MB500968 MB500969
24.0124-0115.1	424115	S	B	HC	L	V	256,0	24,0	21,0	41,0	100,0	4/6	60,0	123,0	14,0	DAEWOO OPEL/VAUXHALL	96179110 5 69 001/90487402
24.0124-0116.1	424116			HC	L	V	299,0	24,0	22,0	71,0	130,0	5	103,0	180,0	15,4	PORSCHE	951 352 041 01
24.0124-0117.1	424117			HC	L	V	299,0	24,0	22,0	100,0	130,0	5	103,0	180,0	15,4	PORSCHE	951 352 041 02
24.0124-0118.1	424118		B	HC	L	V	280,0	24,0	20,0	64,5	112,0	5	68,2	144,0	16,5	VOLKSWAGEN	701 615 301 D
24.0124-0119.1	424119		B	HC	L	V	286,0	24,0	21,0	58,4	110,0	5	70,0	139,0	14,0	OPEL/VAUXHALL	5 69 053/90487103
24.0124-0120.1	424120		B			V	260,0	24,0	22,2	47,0	108,0	4	63,5	136,0	13,6	FORD	4070865 5026784
24.0124-0121.1	424121					V	260,0	24,2	22,2	53,1	112,0	5	63,5	138,0	13,7	FORD	5027462 5027463
24.0124-0125.1	424125					V	260,0	24,2	22,2	44,0	108,0	4	63,5	136,0	13,7	FORD	5025950
24.0124-0127.1	424127		B			V	280,0	24,0	21,9	67,6	118,0	5	73,0	142,0	15,5	CITROEN	4246 Y1 4249 99 4249 K3 4249 H8 16 078 720 80
24.0124-0128.1	424128	S	B	HC		V	280,0	24,0	20,0	55,2	112,0	5	68,2	144,0	16,5	VOLKSWAGEN	7D0 615 301 C
24.0124-0129.1	424129		B			V	258,0	24,0	22,0	48,6	114,3	5	72,0	142,5	13,0	FORD MAZDA	3958455 GA2Y-33-25X GA4Y-33-25X GA4Y-33-25XC GA4Y-33-25XD GA4Y-33-25XJ GA5Y-33-25X GA5Y-33-25XD
24.0124-0131.1	424131		B			V	254,0	24,2	22,2	43,0	100,0	5	78,5	104,0	M10	FORD	5025610 5029815
24.0124-0132.1	424132		B			V	270,0	24,2	22,2	43,0	100,0	5	78,5	104,0	M10	FORD	5029816
24.0124-0133.1	424133			HC	L	V	284,0	24,0	21,0	41,0	110,0	5/8	70,0	145,0	14,0	OPEL/VAUXHALL SAAB	5 69 047/90442513 4241428



Abmessungen Bremsscheiben

Dimensions brake discs - Misure dischi freno -

Dimensions Disques de frein - Medidas disco de freno

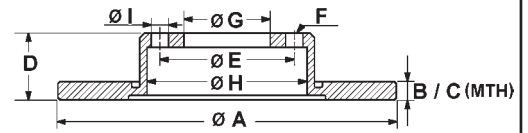

S Fixierschraube - fixing screw - vite di riparazione - vis de fixation - tornillo quefija

B beschichtet - coated - rivestito - revêtu - recubierto

HC hochgekohlt - high carbon - ad alto tenore di carbonio - à haute teneur en carbone - altamente carbonizado

L legiert - alloyed - alligato/legato - allié - aleado

V ventiliert - ventilated - ventilato - ventilé - ventilado

● gelocht - perforated - perforato - poinçonné - perforado

		S	B	HC	L	V	A	B	C	D	E	F	G	H	I	OE - #	
24.0124-0136.1	424136		B			V	256,0	24,0	21,5	45,5	114,3	4	69,0	145,0	12,6	HYUNDAI/KIA MITSUBISHI	51712-M2000 MB407639 MB928995 MR128153 MR205584 MR205585 30872926
24.0124-0137.1	424137					V	278,0	24,0	22,0	70,0	120,0	6	95,0	136,0	M12x1	VOLVO RENAULT	50 00 388 057
24.0124-0138.1	424138		B			V	300,0	24,0	21,9	65,5	130,0	5	80,0	161,0	17,5	CITROEN	4249 H2 4249 H9 16 078 722 80
																FIAT	46806234 51728378 51740247
																PEUGEOT	51858363 4246 Y5 4249 H2 4249 H9 16 078 722 80
24.0124-0139.1	424139	S	B			V	260,0	24,0	22,0	28,0	108,0	4	66,0	133,5	13,0	PEUGEOT	4246 L9
24.0124-0140.1	424140		B			V	276,0	24,0	22,4	45,1	108,0	6	87,0	136,0	10,6	MITSUBISHI	MB618716 MB928120 MB928697 MR129648 MR129649
24.0124-0141.1	424141		B			V	260,0	24,0	22,0	56,8	100,0	5	58,0	129,0	12,8	SUBARU	26300AE091 26310AA021 26310AA031 26310AA032 26310AC060
24.0124-0142.1	424142					V	256,0	24,0	22,4	45,3	114,3	5	69,0	145,0	12,6	MITSUBISHI	MB618799 MB668108
24.0124-0143.1	424143		B			V	298,5	24,0	22,0	70,0	127,0	5	101,6	158,0	10,0	LAND ROVER	FTC902
24.0124-0144.1	424144					V	276,0	24,0	22,4	45,2	114,3	5	69,0	165,0	12,6	MITSUBISHI	MB618344 MB858799
24.0124-0145.1	424145		B			V	277,0	24,0	22,0	56,5	100,0	5	58,0	129,0	13,0	SUBARU	26300AE050 26300AE070 26300AE071 26310AA091 26310AA092 26310AA120 26310AA121
24.0124-0146.1	424146		B			V	256,0	24,0	22,4	45,3	114,3	4	69,0	145,0	12,6	HYUNDAI/KIA MITSUBISHI	51712-M2010 MB668886 MB950570
24.0124-0147.1	424147					V	256,0	24,0	22,4	45,3	114,3	5	69,0	145,0	12,6	MITSUBISHI	MB699761
24.0124-0148.1	424148					V	278,0	24,0	22,2	35,5	108,0	4	63,5	137,0	13,7	FORD	5024174 5026674
24.0124-0149.1	424149		B			V	278,0	24,1	22,2	46,9	108,0	4	63,5	136,0	13,6	FORD	4070864 5026785
24.0124-0151.1	424151					V	260,0	24,3	22,8	53,0	108,0	4	63,5	137,0	13,8	FORD	5022664
24.0124-0152.1	424152	S	B	HC	L	V	256,0	23,8	21,0	41,1	100,0	4	60,0	123,0	14,3	OPEL/VAUXHALL	5 69 059/9117677
24.0124-0158.1	424158	S	B	HC	L	V	280,0	24,0	21,8	44,0	100,0	4	61,0	140,0	13,6	RENAULT	77 01 207 829 86 71 005 975
24.0124-0159.1	424159		B			V	281,0	23,9	21,5	45,7	114,3	4	69,0	146,5	12,5	MITSUBISHI VOLVO	M818027 30818027
24.0124-0161.1	424161		B			V	300,0	23,9	22,0	47,0	108,0	5	63,5	155,0	13,7	FORD	1376118 4179398 4181042
																JAGUAR	C2S 35270 C2S 42667 C2S 52091
24.0124-0162.1	424162		B			V	280,0	24,0	21,0	61,5	110,0	6	79,5	119,0	M10x1,5	OPEL/VAUXHALL RENAULT	45 00 098/9160398 77 00 302 128 86 71 017 103
24.0124-0163.1	424163	S				V	256,0	24,0	22,0	47,1	100,0	4/6	60,0	134,0	13,2	CHEVROLET	96286933 96312559
																DAEWOO	96286933 96312559
24.0124-0164.1	424164		B			V	258,0	24,0	22,0	47,0	100,0	4	55,0	125,0	13,0	MAZDA	BJ1Y-33-25X
24.0124-0165.1	424165		B	HC	L	V	298,0	24,0	22,0	67,0	130,0	5	98,0	164,0	15,4	PORSCHE	986 351 401 05
24.0124-0166.1	424166	S	B	HC	L	V	260,0	24,0	21,0	41,0	100,0	4/6	60,0	126,0	14,5	OPEL/VAUXHALL	5 69 000/9196050
24.0124-0167.1	424167		B			V	276,0	24,5	22,1	43,0	100,0	5	82,0	136,0	M10	FORD	1738807 1C1J-1125-A2D

Abmessungen Bremsscheiben

Dimensions brake discs - Misure dischi freno -

Dimensions Disques de frein - Medidas disco de freno

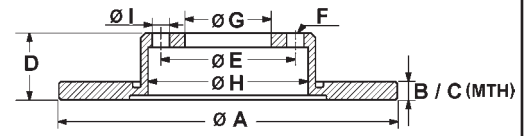

S Fixierschraube - fixing screw - vite di riparazione - vis de fixation - tornillo quejija

B beschichtet - coated - rivestito - revêtu - recubierto

HC hochgekohlt - high carbon - ad alto tenore di carbonio - à haute teneur en carbone - altamente carbonizado

L legiert - alloyed - alligato/legato - allié - aleado

V ventiliert - ventilated - ventilato - ventilé - ventilado

● gelocht - perforated - perforato - poinçonné - perforado

		S	B	HC	L	V	A	B	C	D	E	F	G	H	I	OE - #	
24.0124-0168.1	424168		B			V	294,0	24,5	22,1	43,0	100,0	5	82,0	136,0	M10	FORD 1738815 YC1J-1125-B2B	
24.0124-0169.1	424169		B	HC		V	280,0	24,0	21,8	46,9	108,0	5	61,0	139,8	13,5	RENAULT 82 00 007 121 86 71 017 410	
24.0124-0170.1	424170		B			V	276,0	24,0	22,4	45,0	114,3	4	69,0	145,0	12,5	MITSUBISHI MR389725 MR475331	
24.0124-0171.1	424171		S	B	HC	L	V	280,0	24,0	21,8	44,0	108,0	5	61,0	140,0	15,5	RENAULT 77 01 206 198
24.0124-0172.1	424172					V	284,5	24,0	22,4	51,0	139,6	5	96,3	171,0	12,5	KIA 0K011-33-251D 0K01A-33-251C 0K01A-33-25XB	
24.0124-0173.1	424173					V	258,0	24,0	22,0	48,6	114,3	4	72,0	143,7	13,0	KIA 0K9AA-33-251 0K9AA-33-251B 0K9AA-33-251C	
24.0124-0174.1	424174					V	284,0	24,2	22,9	60,5	111,1	5	82,6	138,5	11,5	JAGUAR JLM 727 JLM 776	
24.0124-0175.1	424175		B			V	273,5	24,0	22,0	47,5	114,3	5	72,0	143,0	13,0	MAZDA GF3Y-33-25XA	
24.0124-0176.1	424176		B	HC	L	V●	299,0	24,0	22,0	75,0	130,0	5	98,0	180,0	15,4	PORSCHE 996 352 401 05	
24.0124-0177.1	424177		B	HC		V	345,0	24,0	22,4	67,0	120,0	5	79,0	185,0	16,5	BMW 34 21 1 166 129	
24.0124-0178.1	424178		B			V	282,5	24,0	22,4	38,0	114,3	5	73,5	159,3	14,0	CHRYSLER 4721 820AE	
24.0124-0179.1	424179		B			V	278,0	24,0	22,0	44,5	108,0	5	63,5	136,0	13,7	FORD 1361298 1361300 4367104 4367106 4455980 4457985 2T14-1125-CC 2T14-1125-EC	
24.0124-0181.1	424181		S	B	HC		V	310,0	24,0	22,4	77,0	120,0	5	79,0	161,0	14,5	BMW 34 11 6 764 021
24.0124-0182.1	424182					V	276,0	24,0	22,4	45,0	114,3	5	69,0	145,0	12,5	MITSUBISHI MR449817 MR449818	
24.0124-0183.1	424183		B	HC	L	V●	299,0	24,0	22,0	65,0	130,0	5	103,0	180,0	15,4	PORSCHE 993 352 041 02	
24.0124-0184.1	424184		B			V	257,0	24,0	22,1	46,7	114,3	4	69,0	141,5	12,7	HYUNDAI 51712-2D310	
24.0124-0185.1	424185		B			V	258,0	24,0	22,0	48,5	100,0	4	57,0	143,6	13,0	KIA 0K2N1-33-251	
24.0124-0186.1	424186			HC		V	370,0	24,0	22,4	67,0	120,0	5	79,0	185,0	16,5	BMW 34 21 1 166 131	
24.0124-0187.1	424187		B			V	254,0	24,0	22,0	50,7	100,0	4	55,0	141,0	13,0	KIA 41712-FD-300	
24.0124-0188.1	424188		B	HC	L	V	278,0	24,0	21,4	55,5	112,0	5	67,0	164,0	15,0	MERCEDES BENZ 124 423 08 12	
24.0124-0189.1	424189			HC	L	V	282,5	24,0	22,6	35,0	126,0	5	107,0	145,0	8,4	PORSCHE 911 351 041 22	
24.0124-0190.1	424190			HC	L	V	290,0	24,0	22,6	83,0	130,0	5	90,0	180,0	15,4	PORSCHE 911 352 041 08	
24.0124-0191.1	424191		S	B	HC		V	300,0	24,0	21,8	43,9	100,0	4	61,0	139,8	13,5	RENAULT 77 01 207 897 86 71 017 844
24.0124-0192.1	424192		B			V	256,0	24,0	21,5	45,6	114,3	4	69,0	139,0	12,7	MITSUBISHI 4605A068 SMART 454 420 00 01	
24.0124-0193.1	424193					V	282,5	24,0	22,4	38,0	114,3	5	73,5	144,0	14,0	CHRYSLER 4509 340	
24.0124-0194.1	424194		B	HC	L	V●	299,0	24,0	22,0	67,0	130,0	5	98,0	180,0	15,4	PORSCHE 986 352 403 01 987 352 403 00	
24.0124-0195.1	424195					V	274,0	24,1	22,0	40,4	114,3	5	72,0	142,5	13,0	KIA 0K552-33-251 0K552-33-251A 0K56A-33-251 KJ002-33-251C	
24.0124-0196.1	424196		B			V	293,5	24,0	22,0	56,7	100,0	5	58,0	129,0	13,0	SUBARU 26300AE061 26300SA001	
24.0124-0197.1	424197		S	B	HC		V	300,0	24,0	22,4	73,5	120,0	5	79,0	152,0	14,5	BMW 34 11 6 764 643 34 11 6 854 998
24.0124-0198.1	424198					V	300,0	24,0	22,0	44,5	108,0	4	63,5	156,5	13,7	FORD 4328921 4410264	
24.0124-0199.1	424199		S	B		V	256,0	24,0	21,0	46,8	114,3	4	60,0	141,0	12,6	CHEVROLET/DAEWOO 96264591 96328338 96549782	
24.0124-0200.1	424200		S	B	HC		V	330,0	24,0	22,4	73,3	120,0	5	79,0	174,0	14,5	BMW 34 11 6 854 999
24.0124-0201.2	424201		S	B	HC		V	345,0	24,0	22,4	63,2	120,0	5	75,0	185,0	14,5	BMW 34 21 6 763 827
24.0124-0202.1	424202					V	276,0	24,0	22,4	45,2	114,3	6	93,0	137,0	10,6	MITSUBISHI MB895730	
24.0124-0203.1	424203		S	B	HC		V	312,0	23,9	22,4	73,1	120,0	5	79,0	152,0	16,5	BMW 34 11 6 792 219 34 11 6 855 006
24.0124-0207.1	424207					V	254,0	24,0	22,4	39,0	108,0	6	67,0	132,6	10,6	MITSUBISHI MB950958	
24.0124-0210.1	424210		B	HC	L	V●	298,0	24,0	22,0	67,0	130,0	5	98,0	164,0	15,4	PORSCHE 987 351 402 01	
24.0124-0211.1	424211		B	HC	L	V●	298,0	24,0	22,0	67,0	130,0	5	98,0	164,0	15,4	PORSCHE 987 351 401 01	
24.0124-0212.1	424212		S	B	HC	L	V	320,0	24,0	21,4	58,2	112,0	5	67,0	180,0	15,2	MERCEDES BENZ 221 423 10 12
24.0124-0213.1	424213		B	HC		V	345,0	24,0	22,4	74,0	120,0	5	79,0	185,0	16,5	BMW 34 21 6 864 054	
24.0124-0214.1	424214		B	HC		V	370,0	24,0	22,4	74,0	120,0	5	79,0	185,0	16,5	BMW 34 21 6 765 891	

Abmessungen Bremsscheiben

Dimensions brake discs - Misure dischi freno -

Dimensions Disques de frein - Medidas disco de freno

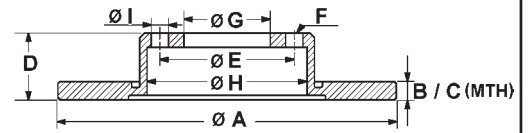

S Fixierschraube - fixing screw - vite di riparazione - vis de fixation - tornillo quejija

B beschichtet - coated - rivestito - revêtu - recubierto

HC hochgekohlt - high carbon - ad alto tenore di carbonio - à haute teneur en carbone - altamente carbonizado

L legiert - alloyed - alligato/legato - allié - aleado

V ventiliert - ventilated - ventilato - ventilé - ventilado

● gelocht - perforated - perforato - poinçonné - perforado

		S	B	HC	L	V	A	B	C	D	E	F	G	H	I	OE - #
24.0124-0215.1	424215		B			V	294,0	24,0	22,4	45,5	114,3	5	69,0	147,8	12,6	CITROEN 16 063 757 80 16 114 298 80 4249 59 MITSUBISHI 4615A006 MR128659 MR205215 PEUGEOT 16 063 757 80 16 114 298 80 4249 59
24.0124-0216.1	424216	S	B	HC		V	345,0	24,0	22,4	78,5	120,0	5	75,0	185,0	16,5	BMW 34 21 6 793 246
24.0124-0217.1	424217		B			V	302,5	24,0	22,0	45,0	114,3	5	72,0	144,0	13,0	MAZDA F152-33-251A
24.0124-0218.1	424218		B			V	322,6	24,0	22,0	45,0	114,3	5	72,0	144,0	13,0	MAZDA F160-33-251A
24.0124-0219.2	424219	S	B	HC		V	385,0	24,0	22,4	78,5	120,0	5	75,0	185,0	16,5	BMW 34 21 6 779 535
24.0124-0220.1	424220		B			V	254,0	24,0	22,4	40,0	108,0	5	87,0	153,5	10,6	HYUNDAI 58129-4A000
24.0124-0221.1	424221	S	B	HC		V	280,0	24,0	21,8	44,0	114,3	5	68,0	140,0	15,8	DACIA 40 20 641 51R RENAULT 40 20 600 10R
24.0124-0222.1	424222	S	B	HC		V	280,0	24,0	21,8	44,0	108,0	5	61,0	140,0	15,8	MERCEDES BENZ 415 420 00 01 415 420 07 01 82 01 464 604
24.0124-0223.1	424223	S	B	HC		V	280,0	24,0	21,8	44,0	108,0	5	61,0	140,0	15,8	RENAULT 77 01 208 848
24.0124-0224.1	424224	S	B	HC		V	300,0	24,0	21,8	44,0	108,0	5	61,0	140,0	15,8	RENAULT 77 01 208 849
24.0124-0226.1	424226	S	B	HC	L	V●	320,0	24,0	22,0	58,2	112,0	5	67,0	180,0	15,2	MERCEDES BENZ 230 423 15 12
24.0124-0228.1	424228		B			V	294,0	24,0	21,0	87,5	108,0	8	84,0	142,0	10,5	IVECO 2996043
24.0124-0229.1	424229		B			V	263,0	24,0	22,0	53,0	118,0	6	96,0	144,0	M12x1,5	NISSAN 40206-F3901
24.0124-0231.2	424231	S	B	HC		V●	350,0	24,0	22,4	66,5	120,0	5	75,0	185,0	14,5	BMW 34 21 2 283 803
24.0124-0232.2	424232	S	B	HC		V●	350,0	24,0	22,4	66,5	120,0	5	75,0	185,0	14,5	BMW 34 21 2 283 804
24.0124-0233.2	424233	S	B	HC		V	345,0	24,0	22,4	69,0	120,0	5	75,0	185,0	16,5	BMW 34 21 6 775 289
24.0124-0234.2	424234	S	B	HC		V●	370,0	24,0	22,4	61,6	120,0	5	75,0	185,0	14,5	BMW 34 21 2 282 808
24.0124-0235.2	424235	S	B	HC		V●	370,0	24,0	22,4	61,6	120,0	5	75,0	185,0	14,5	BMW 34 21 2 282 807
24.0124-0236.1	424236	S	B	HC	L	V	320,0	24,0	21,4	68,2	112,0	5	67,0	180,0	15,2	MERCEDES BENZ 000 423 11 12 219 423 00 12
24.0124-0237.1	424237		B			V	278,0	24,0	22,0	47,3	114,3	4	60,0	141,0	12,5	CHEVROLET 96329364
24.0124-0238.1	424238		B			V	280,0	24,0	22,0	44,0	114,3	4	68,0	143,2	13,0	NISSAN 40206-EM10A 40206-ET01C
24.0124-0239.2	424239	S	B	HC		V	330,0	24,0	22,4	66,0	120,0	5	75,0	172,0	16,5	BMW 34 11 6 794 429
24.0124-0240.1	424240	S	B	HC		V	307,0	24,0	22,4	45,2	120,0	5	79,0	152,0	16,5	MINI 34 11 9 804 829
24.0124-0241.1	424241	S	B	HC		V	370,0	23,9	22,4	69,0	120,0	5	75,0	185,0	16,6	BMW 34 21 6 775 291
24.0124-0242.2	424242	S	B	HC		V	330,0	24,0	22,4	73,1	120,0	5	79,0	171,8	14,5	BMW 34 11 6 782 601
24.0124-0243.1	424243		B	HC	L	V	254,5	24,0	22,4	40,0	108,0	5	87,0	152,5	10,6	HYUNDAI 58129-4A100
24.0124-0245.1	424245		B	HC		V	256,0	24,0	22,0	24,0	108,0	6	86,0	155,0	10,8	FORD 4883102 6M34-1027-CA
24.0124-0247.1	424247		B			V	280,0	24,0	22,0	44,0	114,3	5	68,0	144,0	12,7	NISSAN 40206-1KA3A
24.0124-0250.2	424250	S	B	HC		V	345,0	24,0	22,4	66,1	120,0	5	75,0	160,8	16,5	BMW 34 20 6 797 605
24.0124-0251.2	424251	S	B	HC		V	345,0	24,0	22,4	66,2	120,0	5	75,0	185,0	16,5	BMW 34 20 6 797 607
24.0124-0253.1	424253	S	B	HC		V	280,0	24,0	21,8	44,0	100,0	4	61,0	140,0	13,5	DACIA/RENAULT 40 20 605 40R 40 20 695 18R
24.0124-0258.1	424258	S	B	HC		V	276,0	24,0	21,0	49,7	112,0	9	65,0	144,0	15,3	SEAT/SKODA/VW 5Q0 615 301 A
24.0124-0259.1	424259	S	B	HC		V	330,0	24,0	22,4	45,1	112,0	5	67,0	151,4	16,5	BMW 34 11 6 865 713
24.0124-0260.1	424260	S	B	HC		V	307,0	24,0	22,4	45,1	112,0	5	67,0	151,0	16,5	BMW 34 11 6 799 351
24.0124-0702.1	424702		B			V	280,0	24,0	22,7	81,5	114,3	5	72,0	159,0	15,5	JEEP 5015 965AA
24.0124-0706.1	424706		B			V	257,0	24,0	22,4	45,5	114,3	4	69,0	141,5	12,5	HYUNDAI 51712-38100
24.0124-0723.1	424723		B			V	256,0	24,0	21,0	46,8	114,3	5	60,0	137,0	12,6	DAEWOO 96238673
24.0124-0724.1	424724		B			V	314,0	24,0	22,4	45,2	108,0	6	87,0	136,0	10,6	MITSUBISHI MB699716
24.0124-0735.1	424735		B			V	278,0	24,0	22,0	47,0	114,3	5	72,0	143,0	14,2	FORD 4096352 4668068
24.0125-0100.1	425100			HC		V	280,0	25,0	23,4	78,0	120,0	5	74,0	144,0	14,5	BMW 34 11 1 121 902 34 11 1 152 296 34 11 1 163 141
24.0125-0102.1	425102			HC	L	V	276,0	25,0	23,0	46,5	112,0	5	68,0	135,0	15,4	AUDI 447 615 301 A 447 615 301 B
24.0125-0104.1	425104			HC		V	282,0	25,0	23,4	76,0	120,0	5	79,0	146,0	14,5	BMW 34 11 1 163 147
24.0125-0105.1	425105	S	B	HC		V	288,0	25,0	23,0	46,5	112,0	5/9	68,0	135,0	15,4	AUDI/SEAT/SKODA 4A0 615 301 C 4A0 615 301 D 8E0 615 301 Q
24.0125-0106.1	425106		B	HC		V	276,0	25,0	23,0	56,5	108,0	4	68,0	135,0	15,4	AUDI 895 615 301 B
24.0125-0107.1	425107		B	HC	L	V	294,0	25,0	22,4	49,5	112,0	5	67,0	154,3	15,0	MERCEDES BENZ 124 421 24 12
24.0125-0108.1	425108		B	HC		V	288,0	25,0	23,0	28,5	100,0	5	65,0	136,0	15,6	VOLKSWAGEN 3A0 615 301 A
24.0125-0110.1	425110	S	B	HC	L	V	288,0	25,0	22,4	46,5	112,0	5	67,0	154,3	13,2	CHRYSLER 5098 063AA MERCEDES BENZ 203 421 03 12 210 421 07 12 210 421 24 12

Abmessungen Bremsscheiben

Dimensions brake discs - Misure dischi freno -

Dimensions Disques de frein - Medidas disco de freno

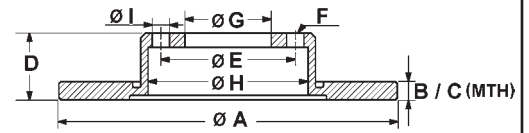

S Fixierschraube - fixing screw - vite di riparazione - vis de fixation - tornillo quefija
 L legiert - alloyed - alligato/legato - allié - aleado
 ● gelocht - perforated - perforato - poinçonné - perforado
 B beschichtet - coated - rivestito - revêtu - recubierto
 V ventiliert - ventilated - ventilato - ventilé - ventilado
 HC hochgekohlt - high carbon - ad alto tenore di carbonio - à haute teneur en carbone - altamente carbonizado

		S	B	HC	L	V	A	B	C	D	E	F	G	H	I	OE - #
24.0125-0113.1	425113	S	B	HC		V	288,0	25,0	22,0	34,5	100,0	5	65,0	136,0	15,6	AUDI/SEAT/SKODA/VW 1J0 615 301 R 1J0 615 301 S 6R0 615 301 A
24.0125-0114.1	425114	S	B	HC		V	288,0	25,1	21,0	55,4	112,0	5	68,2	144,2	16,5	FORD SEAT/VW VOLKSWAGEN 1045994 7M0 615 301 G 8E0 615 301 A 8E0 615 301 C
24.0125-0115.1	425115		B	HC		V	282,5	25,0	23,0	46,5	112,0	5	68,0	135,0	15,3	TOYOTA 43512-28060
24.0125-0116.1	425116					V	255,0	25,0	23,0	52,6	114,3	5	62,0	147,0	14,4	FORD 1373369 1734696 AV61-1125-BB 31262718
24.0125-0117.1	425117		B	HC		V	278,0	25,0	23,0	48,5	108,0	5	63,5	140,0	13,7	VOLVO TOYOTA 43512-26040 43512-26070 43512-35170 43512-35180 J43 512 351 80
24.0125-0118.1	425118					V	257,0	25,0	23,0	46,6	110,0	5	84,0	145,0	M10x1,25	VOLKSWAGEN OPEL/VAUXHALL SAAB 32025723 5390786
24.0125-0119.1	425119	S	B	HC	L	V	288,0	25,0	22,0	42,0	110,0	5/7	70,0	139,0	14,0	AUDI/SEAT/SKODA/VW 6R0 615 301 B 8N0 615 301 A 8L0 615 301
24.0125-0123.1	425123	S	B	HC		V	310,0	25,0	22,0	34,5	100,0	5/9	65,0	185,0	15,6	SAAB 4002143
24.0125-0124.1	425124		B			V	255,0	24,9	24,0	49,2	100,0	5	55,0	156,0	14,5	TOYOTA 43512-20470 43512-20580 43512-20700
24.0125-0125.1	425125					V	280,0	25,0	23,0	44,0	108,0	4	68,0	144,0	15,0	TOYOTA 43512-28100
24.0125-0126.1	425126					V	271,0	25,0	23,0	52,8	114,3	5	62,0	147,0	14,6	TOYOTA 43512-17070
24.0125-0129.1	425129					V	258,0	25,0	24,0	47,0	114,3	5	62,0	161,5	14,5	HONDA 45251-SM5-A00
24.0125-0130.1	425130					V	282,0	25,0	23,0	34,5	114,3	4	92,0	171,0	M10x1,25	OPEL/VAUXHALL 5 69 066/93197592
24.0125-0131.1	425131	S	B	HC	L	V	280,0	24,8	22,0	42,0	110,0	5/7	70,0	139,0	14,0	TOYOTA 43512-35200
24.0125-0135.1	425135					V	291,0	25,0	23,0	65,8	127,0	6	100,0	155,0	10,7	VOLKSWAGEN 6N0 615 301 E
24.0125-0136.1	425136			HC		V	256,0	25,0	23,0	39,5	100,0	4	65,0	132,2	13,6	AUDI/SEAT/SKODA 4B0 615 301 A 8E0 615 301 R
24.0125-0137.1	425137	S	B	HC		V	312,0	25,0	23,0	46,5	112,0	5	68,0	158,0	15,3	BMW 34 10 1 166 071 34 11 6 864 047
24.0125-0138.1	425138	S	B	HC		V	325,0	24,9	23,4	52,6	120,0	5	79,0	174,0	14,5	AUDI 895 615 301 D
24.0125-0139.1	425139		B	HC	L	V	276,0	24,9	23,0	56,5	112,0	5	68,0	135,0	15,5	TOYOTA 43512-05030
24.0125-0140.1	425140		B			V	260,0	25,0	23,0	49,2	100,0	5	55,0	131,0	14,5	FIAT 51819733 71772553
24.0125-0141.1	425141	S	B	HC		V	285,0	24,9	22,0	42,1	110,0	5/7	70,0	139,0	14,0	OPEL/VAUXHALL SAAB 5 69 003/93171497 9156807 93171497
24.0125-0142.1	425142	S	B	HC	L	V	308,0	25,0	22,0	42,0	110,0	5/8	70,0	139,0	14,0	OPEL/VAUXHALL SAAB 5 69 061/9194477 5391560 9184405
24.0125-0143.1	425143		B			V	275,0	25,0	23,0	49,3	114,3	5	62,0	144,0	14,5	TOYOTA 43512-42030
24.0125-0144.1	425144					V	277,0	25,0	23,0	46,2	100,0	5	54,0	131,0	14,5	TOYOTA 43512-20390
24.0125-0145.1	425145	S	B	HC		V	288,0	25,0	22,0	49,9	112,0	5/9	65,0	144,0	15,3	AUDI/SEAT/SKODA/VW 1K0 615 301 T JZW 615 301 J 5C0 615 301 A
24.0125-0146.1	425146		B			V	282,0	25,0	23,0	47,0	114,3	4	64,0	142,5	13,0	HONDA 45251-S1A-G00
24.0125-0147.1	425147		B			V	282,5	25,0	23,0	48,5	114,3	5	72,0	142,0	13,0	MAZDA GJ6Y-33-25XA
24.0125-0148.1	425148	S	B	HC	L	V	280,0	25,0	22,0	42,0	100,0	4/6	60,0	139,0	14,5	OPEL/VAUXHALL 5 69 006/93175376
24.0125-0149.1	425149		B	HC		V	314,0	25,0	23,0	59,7	112,0	5	68,0	144,0	15,3	AUDI 4F0 615 301 D
24.0125-0155.1	425155		B			V	255,0	25,0	23,0	49,3	100,0	4	55,0	131,0	14,5	TOYOTA 43512-02070 43512-13030 43512-47020
24.0125-0156.1	425156		B			V	276,0	25,0	23,0	49,2	100,0	5	55,0	131,0	14,5	TOYOTA 43512-20730
24.0125-0157.1	425157		B			V	275,0	25,0	23,0	49,2	100,0	4	55,0	129,0	14,5	TOYOTA 43512-02080
24.0125-0158.1	425158	S	B	HC		V	312,0	25,0	22,0	49,9	112,0	5/9	65,0	146,0	15,3	AUDI/VW/SKODA 1K0 615 301 AA JZW 615 301 H 5C0 615 301 B
24.0125-0160.1	425160	S	B	HC		V	325,0	25,0	23,4	62,2	120,0	5	75,0	174,0	16,5	BMW 34 11 3 400 151
24.0125-0161.1	425161					V	282,0	25,0	23,0	44,5	100,0	4	64,2	143,0	12,6	MG SDB000440



Abmessungen Bremsscheiben

Dimensions brake discs - Misure dischi freno -

Dimensions Disques de frein - Medidas disco de freno

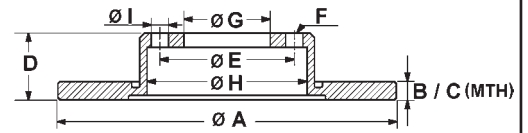

S Fixierschraube - fixing screw - vite di riparazione - vis de fixation - tornillo quefija

B beschichtet - coated - rivestito - revêtu - recubierto

HC hochgekohlt - high carbon - ad alto tenore di carbonio - à haute teneur en carbone - altamente carbonizado

L legiert - alloyed - alligato/legato - allié - aleado

V ventiliert - ventilated - ventilato - ventilé - ventilado

● gelocht - perforated - perforato - poinçonné - perforado

		S	B	HC	L	V	A	B	C	D	E	F	G	H	I	OE - #	
24.0125-0162.1	425162		B	HC		V	300,0	25,0	23,0	48,5	108,0	5	63,5	140,0	13,7	FORD VOLVO	1253965 1373370 1520297 1797226 DV61-1125-DA 274510 31341643 31362412 31381375 31400937 31400941
24.0125-0164.1	425164		B			V	297,0	25,0	22,0	64,7	120,0	5	70,0	161,5	14,3	LAND ROVER	NTC8780
24.0125-0165.1	425165		B	HC		V	278,0	25,0	23,0	48,5	114,3	5	72,0	140,0	14,0	MAZDA	BP4Y-33-25XC C24Y-33-25XB C24Y-33-25XC C24Y-33-25XD
24.0125-0167.1	425167	S	B	HC	L	V	288,0	25,0	22,4	44,5	112,0	5	67,0	154,3	15,3	MERCEDES BENZ	169 421 11 12
24.0125-0168.1	425168		B			V	275,0	25,0	23,0	49,2	100,0	4	55,0	131,0	14,6	TOYOTA	43512-13022
24.0125-0170.1	425170		B	HC		V	300,0	25,0	23,0	48,5	114,3	5	72,0	140,0	14,0	MAZDA	BP6Y-33-25XE C26Y-33-25XB
24.0125-0171.1	425171		B	HC		V	288,0	25,0	23,0	46,5	112,0	5/10	68,0	137,0	15,3	SKODA/VW	4B0 615 301 B
24.0125-0172.1	425172		B	HC		V	312,0	25,0	23,0	46,5	112,0	5/10	68,0	140,0	15,3	SKODA/VW	4B0 615 301 C
24.0125-0173.1	425173	S	B			V	300,0	25,0	23,0	47,2	114,3	5	64,1	141,0	12,7	HONDA	45251-SM6-A10
24.0125-0174.1	425174		B			V	300,0	25,0	23,0	47,2	114,3	5	64,2	142,0	12,6	HONDA	45251-SEA-E30
24.0125-0176.1	425176		B			V	297,5	25,0	22,0	91,5	120,0	5	70,1	161,1	14,3	LAND ROVER	SDB000380
24.0125-0177.1	425177		B			V	257,0	24,5	22,4	47,6	114,3	4	69,0	141,5	12,5	KIA	51712-3C000
24.0125-0178.1	425178		B			V	275,0	25,0	22,0	46,5	114,3	5	62,0	145,0	14,5	TOYOTA	43512-42040
24.0125-0179.1	425179	S	B	HC	L	V	288,0	25,0	22,4	64,5	112,0	5	67,0	154,3	15,2	MERCEDES BENZ	000 421 19 12
24.0125-0182.1	425182	S				V	300,0	25,0	23,0	47,1	114,3	5	64,1	141,0	12,7	HONDA	45251-S9A-E50
24.0125-0183.1	425183					V	282,0	25,0	23,0	47,0	114,3	5	64,1	142,5	13,0	HONDA	45251-S1A-E40 45251-S9A-E50
24.0125-0184.1	425184	S	B	HC		V	314,0	25,0	23,0	52,4	112,0	5	68,0	154,0	15,3	AUDI	8K0 615 301
24.0125-0187.1	425187		B			V	280,0	25,0	23,0	47,2	114,3	5	64,1	142,2	13,0	HONDA	45251-SEA-E00
24.0125-0188.1	425188		B			V	299,0	25,0	23,0	48,4	114,3	5	72,0	142,8	13,0	MAZDA	G33Y-33-25X
24.0125-0189.1	425189	S	B			V	281,5	25,0	23,0	47,2	114,3	5	64,1	142,5	12,5	HONDA	45251-SJH-E10
24.0125-0190.1	425190		B			V	294,5	25,0	23,0	49,0	114,3	5	62,0	154,0	12,6	SUZUKI	55211-65J00
24.0125-0195.1	425195		B	HC		V	320,0	25,0	23,0	48,5	114,3	5	72,0	148,0	13,7	MAZDA	B37F-33-25XA
24.0125-0196.1	425196		B			V	255,0	25,0	22,0	49,2	100,0	5	55,0	136,0	14,5	TOYOTA	43512-47040
24.0125-0197.1	425197		B	HC		V	320,0	25,0	23,0	48,5	108,0	5	63,5	148,0	13,7	FORD VOLVO	1724956 3M51-2C375-CE 31302573 31329122 31341644 31381376 31400818 31400938 31400942
24.0125-0198.1	425198	S	B	HC	L	V	280,0	25,0	22,0	43,2	100,0	4/6	60,0	139,0	14,5	OPEL/VAUXHALL	5 69 007/93181113 5 69 067/93197712
24.0125-0199.1	425199		B	HC		V	278,0	25,0	23,0	48,5	108,0	5	63,5	140,0	13,7	FORD	1790221 AV61-1125-DB
24.0125-0200.1	425200	S	B	HC	L	V	280,0	25,0	22,4	51,0	112,0	5	67,0	144,5	15,0	MERCEDES BENZ	246 421 11 12
24.0125-0208.1	425208		B			V	295,0	25,0	23,0	51,5	114,3	5	68,0	143,0	13,0	MAZDA	B45G-33-251A BJT2-33-251A
24.0125-0209.1	425209		B	HC		V	320,0	25,0	23,0	48,7	108,0	5	63,5	148,0	13,7	FORD	1770767 1829608 CV61-1125-GA DV61-1125-FA
24.0125-0210.1	425210		B			V	278,0	25,0	23,0	39,8	108,0	4	63,5	136,2	14,0	FORD	1854394 CN15-1125-CA
24.0125-0700.1	425700					V	275,0	25,0	23,0	49,2	100,0	5	55,0	129,0	14,5	TOYOTA	42512-20711
24.0125-0706.1	425706					V	300,0	25,0	23,0	39,7	114,3	5	70,2	142,5	12,6	HONDA	45251-S2A-000
24.0126-0100.1	426100			HC	L	V	283,0	26,0	24,0	48,0	108,0	5	71,0	130,5	13,0	CITROEN	95 661 813 96 099 616
24.0126-0101.1	426101		B			V	280,3	26,0	23,0	50,3	108,0	4	68,0	139,0	14,5	PEUGEOT	4246 N8
24.0126-0102.1	426102		B			V	280,3	26,0	23,0	50,3	108,0	5	68,0	139,0	14,5	VOLVO	271590 271788 272312
24.0126-0103.1	426103					V	281,0	26,0	24,2	43,7	98,0	5	59,0	127,0	13,0	ALFA ROMEO	60621051
24.0126-0104.1	426104		B			V	281,0	26,0	24,2	43,7	98,0	5	59,0	127,0	16,5	CITROEN FIAT/LANCIA PEUGEOT	4246 J3 4249 H5 1317651080 4246 J2 4249 H5

Abmessungen Bremsscheiben

Dimensions brake discs - Misure dischi freno -

Dimensions Disques de frein - Medidas disco de freno

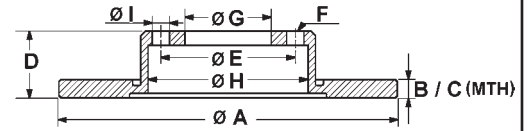

S Fixierschraube - fixing screw - vite di riparazione - vis de fixation - tornillo quefija

B beschichtet - coated - rivestito - revêtu - recubierto

HC hochgekohlt - high carbon - ad alto tenore di carbonio - à haute teneur en carbone - altamente carbonizado

L legiert - alloyed - alligato/legato - allié - aleado

V ventiliert - ventilated - ventilato - ventilé - ventilado

● gelocht - perforated - perforato - poinçonné - perforado

	S	B	HC	L	V	A	B	C	D	E	F	G	H	I	OE - #
24.0126-0105.1	426105	B			V	280,0	26,0	23,0	56,3	108,0	5	68,0	139,0	14,0	VOLVO 31262209 3516567 6848902
24.0126-0106.1	426106	S B			V	283,0	26,0	24,2	28,2	108,0	4	66,0	133,5	13,0	CITROEN PEUGEOT 4246 L8 4246 R7
24.0126-0107.1	426107	B	HC		V	302,0	26,0	23,0	50,0	108,0	5	68,0	151,0	14,4	VOLVO 272276
24.0126-0108.1	426108	B			V	257,0	26,0	24,0	52,5	114,3	5	68,0	139,5	12,8	NISSAN 40206-9C100 40206-9C101
24.0126-0109.1	426109	B			V	277,0	26,0	24,0	39,0	124,0	6	100,0	164,0	M10x1,25	FORD NISSAN 1954433 40206-0F000 40206-0F001 40206-31G01
24.0126-0111.1	426111	B			V	280,0	26,0	24,6	36,0	109,0	6	88,0	175,0	M12x1,25	ISUZU 97034034 97034035
24.0126-0112.1	426112				V	257,0	26,0	24,0	45,5	100,0	4	61,0	148,0	12,8	NISSAN 40206-54C01
24.0126-0114.1	426114				V	281,0	26,0	24,2	54,2	98,0	5	59,0	127,0	13,2	LANCIA 82476515
24.0126-0115.1	426115	B	HC		V	300,0	26,0	22,0	56,0	112,0	5	68,2	144,0	16,5	FORD SEAT/VW 1141782 7M3 615 301 A
24.0126-0116.1	426116	B	HC		V	303,0	26,0	23,0	51,5	112,0	5	67,0	168,0	15,0	MERCEDES BENZ 163 421 02 12 163 421 04 12
24.0126-0119.1	426119	B	HC		V	313,0	25,9	22,0	56,2	112,0	5	68,2	148,0	16,5	FORD SEAT/VW 1108038 7M3 615 301
24.0126-0120.1	426120	S B			V	283,0	26,0	24,0	34,2	108,0	4	66,0	133,5	13,0	CITROEN 4246 W2 4249 18 4249 84 4249 J6 16 064 014 80
24.0126-0121.1	426121	S B	HC	L	V	283,0	26,0	24,0	48,3	108,0	5	71,1	133,0	13,2	PEUGEOT 4246 W8 4249 17 4249 84 4249 J6 4246 P7 4246 V4 4249 L3
24.0126-0122.1	426122	B			V	285,5	26,0	23,0	50,3	108,0	5	68,0	139,0	16,5	VOLVO 272403 946133
24.0126-0123.1	426123	B	HC		V	300,0	26,0	22,8	47,0	108,0	5	61,0	139,6	13,5	RENAULT 82 00 007 122 86 71 016 878
24.0126-0125.1	426125	B			V	281,0	26,0	24,2	43,5	98,0	4	59,0	127,0	13,0	FIAT 46535086 46765546
24.0126-0126.1	426126	B			V	276,0	26,0	24,0	46,2	114,3	5	69,0	141,5	12,6	HYUNDAI 51712-3B000
24.0126-0127.1	426127	B			V	294,0	26,0	24,4	46,1	114,3	5	69,0	145,0	12,6	HYUNDAI 51712-26100
24.0126-0128.1	426128	B	HC	L	V	280,0	26,0	24,4	47,4	114,3	5	69,0	141,5	12,5	HYUNDAI 51712-3K050 51712-1F000 51712-2C000 51712-3K050
24.0126-0129.1	426129	B			V	280,0	26,0	24,4	47,3	114,3	4	69,0	141,4	12,7	HYUNDAI 51712-3C100 51712-3D300
24.0126-0130.1	426130	B			V	305,0	26,0	24,5	63,5	127,0	5	72,0	170,0	15,5	JEEP 5209 8672
24.0126-0131.1	426131	B			V	276,0	26,0	24,4	45,5	114,3	4	69,0	145,0	12,5	NISSAN MR510742
24.0126-0133.1	426133				V	281,0	26,0	24,2	47,2	108,0	5/10	59,0	134,0	14,5	ALFA/FIAT 46449390 60814639 71739635
24.0126-0134.1	426134	B			V	276,0	26,0	24,4	45,5	114,3	5	69,0	145,0	12,5	NISSAN MR510966
24.0126-0135.1	426135	B			V	274,0	26,2	24,0	48,5	114,3	5	72,0	140,5	13,0	KIA 0K55A-33-251 0K55B-33-251
24.0126-0136.1	426136	B	HC	L	V●	330,0	26,0	24,0	68,2	112,0	5	67,0	180,0	15,0	MERCEDES BENZ 211 423 11 12
24.0126-0137.1	426137	B	HC	L	V●	330,0	26,0	24,0	61,0	112,0	5	67,0	180,0	17,0	MERCEDES BENZ 220 423 09 12
24.0126-0138.1	426138	B			V	295,0	26,0	24,0	49,2	114,3	5	62,0	141,0	14,5	TOYOTA 43512-0F010 43512-05080
24.0126-0139.1	426139	B			V	277,0	26,0	24,0	49,5	100,0	5	55,0	129,0	14,5	TOYOTA 43512-05040
24.0126-0140.1	426140	S B			V	302,0	26,0	24,0	34,2	108,0	4	66,0	133,0	13,0	CITROEN 4249 33 96 876 021 80 96 876 021 80 98 092 662 80
24.0126-0141.1	426141	B			V	295,0	26,0	24,0	49,5	100,0	5	55,0	141,0	14,5	TOYOTA 43512-05050 43512-05070
24.0126-0142.1	426142		HC		V	300,0	26,0	22,8	44,0	108,0	5	61,0	139,6	15,6	RENAULT 82 00 196 263
24.0126-0143.1	426143	S B	HC	L	V	280,0	26,0	24,0	48,5	114,3	4	72,0	143,5	13,0	KIA 0K2FA-33-251
24.0126-0144.1	426144		HC	L	V	290,0	26,0	23,0	70,0	96,0	8	70,0	135,0	14,5	MERCEDES BENZ 905 421 00 12



Abmessungen Bremsscheiben

Dimensions brake discs - Misure dischi freno -

Dimensions Disques de frein - Medidas disco de freno

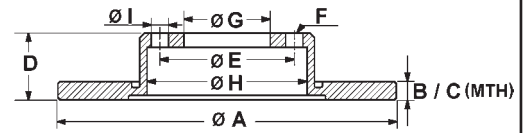

S Fixierschraube - fixing screw - vite di riparazione - vis de fixation - tornillo quefija

B beschichtet - coated - rivestito - revêtu - recubierto

HC hochgekohlt - high carbon - ad alto tenore di carbonio - à haute teneur en carbone - altamente carbonizado

L legiert - alloyed - alligato/legato - allié - aleado

V ventiliert - ventilated - ventilato - ventilé - ventilado

● gelocht - perforated - perforato - poinçonné - perforado

		S	B	HC	L	V	A	B	C	D	E	F	G	H	I	OE - #	
24.0126-0145.1	426145		B			V	290,0	26,0	24,4	46,3	139,7	6	94,0	171,0	12,8	MITSUBISHI 4615A061 MR407116 MR407289	
24.0126-0146.1	426146		B	HC	L	V	278,0	26,0	23,0	43,3	110,0	5/7	70,0	136,0	14,0	OPEL/VAUXHALL 55 69 026/93188919	
24.0126-0148.1	426148		B			V	273,0	26,0	23,0	49,2	114,3	5	62,0	142,0	14,8	TOYOTA 43512-02180	
24.0126-0149.1	426149		S	B	HC	L	V	330,0	26,0	23,4	58,2	112,0	5	67,0	180,0	15,0	MERCEDES BENZ 230 423 08 12
24.0126-0150.1	426150		B	HC	L	V	280,0	26,0	24,4	47,2	114,3	5	69,0	143,5	12,5	HYUNDAI/KIA 51712-1H000 51712-1H100 51712-2K100	
24.0126-0151.1	426151		B			V	303,0	26,0	24,0	47,0	114,3	5	72,0	159,0	14,0	KIA FORD 4668070	
24.0126-0152.2	426152		S	B	HC		V	338,0	25,9	24,4	73,0	120,0	5	79,0	171,5	14,5	BMW 34 11 6 778 647
24.0126-0154.1	426154		B			V	295,5	26,0	24,0	44,0	114,3	5	68,0	146,5	12,7	NISSAN 40206-JD00A 40206-JG00A	
24.0126-0155.1	426155		S	B		V	275,0	26,0	24,0	47,3	114,3	4	69,0	141,6	13,0	KIA 51712-2F100	
24.0126-0156.1	426156		B			V	295,0	26,0	23,0	49,1	114,3	5	62,0	143,2	14,8	TOYOTA 43512-02190 43512-0F030 43512-12680	
24.0126-0157.1	426157		B			V	275,0	26,0	24,0	47,4	114,3	5	69,0	143,3	12,5	HYUNDAI 51712-2H000	
24.0126-0158.1	426158		S	B	HC	L	V	296,0	26,0	23,4	44,0	114,3	5	68,0	147,7	15,8	RENAULT 40 20 600 02R 40 20 668 13R 40 20 670 23R
24.0126-0159.1	426159		S	B		V	302,0	26,0	24,0	34,2	108,0	4	66,0	133,2	13,0	CITROEN 4249 81 4249 86 4249 J8 4249 64 4249 80 4249 81 4249 86 4249 J8	
24.0126-0160.1	426160		B			V	320,0	26,0	23,0	49,3	114,3	5	62,0	143,0	14,5	TOYOTA 43512-05090	
24.0126-0161.1	426161		B	HC	L	V	290,0	26,0	23,0	42,5	120,0	10	102,0	144,5	10,5	RENAULT 50 10 260 603	
24.0126-0162.1	426162		B			V	290,0	26,0	24,4	45,8	114,3	5	69,0	145,5	12,6	MITSUBISHI MN116979	
24.0126-0163.1	426163		B			V	290,0	26,0	23,0	53,0	118,0	6	96,0	134,0	M12x1,5	NISSAN 40206-9X403 40206-9X40B RENAULT 50 01 871 214	
24.0126-0164.1	426164		B			V	276,0	26,0	24,4	45,5	114,3	5	69,0	146,0	12,5	MITSUBISHI MN116329 MN116330 4615A115 4615A190	
24.0126-0165.1	426165		S	B		V	276,0	26,0	23,0	45,5	105,0	5	60,0	139,0	14,2	CHEVROLET 13502045 13502824	
24.0126-0166.1	426166		S	B	HC	V	300,0	26,0	23,0	45,5	115,0	5	70,7	149,0	14,2	OPEL/VAUXHALL CHEVROLET OPEL/VAUXHALL 5 69 073/13502044 13502052 5 69 070/13502052 5 69 076/13502051 5 69 082/13503988	
24.0126-0168.1	426168		S	B		V	281,0	26,2	24,2	39,8	110,0	5/5	70,0	138,0	16,6/11,0	FIAT 51806278 51815312 51937306 51962485	
24.0126-0169.1	426169		B			V	274,0	26,0	24,4	44,2	108,0	5	87,0	132,0	10,5	JEEP HYUNDAI 58129-4A200	
24.0126-0170.1	426170		B			V	294,0	26,0	24,4	45,8	114,3	5	69,0	145,0	13,1	CITROEN 16 075 005 80 CHRYSLER 5105 514AA JEEP 5105 514AA MITSUBISHI 4615A117 PEUGEOT 16 075 005 80	
24.0126-0171.1	426171		B	HC	L	V	280,0	26,0	24,0	47,3	114,3	5	69,0	141,5	12,6	KIA 51712-1D100	
24.0126-0172.1	426172		B			V	300,0	26,0	24,0	49,5	114,3	5	62,0	150,2	12,8	SUZUKI 55311-57L00	
24.0126-0174.1	426174		B	HC	L	V	376,0	26,0	24,0	42,0	108,0	5	64,5	167,6	14,0	JAGUAR C2P 13648	
24.0126-0175.1	426175		B			V	257,0	26,0	24,0	53,7	114,3	4	68,0	144,0	12,8	NISSAN 40206-JX00A 40206-3LG0A	
24.0126-0176.1	426176		S	B	HC	L	V	302,0	26,0	24,0	34,2	108,0	5	66,0	133,5	13,2	PEUGEOT 4249 F8
24.0126-0177.1	426177		B			V	296,0	26,0	24,0	44,0	114,3	5	68,0	146,0	12,7	NISSAN 40206-1KC1A 40206-1KC3A	
24.0126-0180.1	426180		S	B	HC	L	V	280,0	26,0	23,8	45,0	108,0	5	61,0	139,8	15,8	MERCEDES BENZ 415 421 04 12
24.0126-0182.1	426182		S	B	HC	V	300,0	26,0	23,0	45,2	105,0	5	60,0	149,0	14,2	CHEVROLET 13502059 OPEL/VAUXHALL 5 69 091/13502059	
24.0126-0183.1	426183		S	B	HC	L	V	283,0	26,0	24,0	48,0	108,0	5	71,0	134,0	13,3	CITROEN 98 059 614 80 PEUGEOT 98 039 181 80
24.0126-0184.1	426184		B			V	277,0	26,0	23,0	49,3	114,3	5	62,0	142,0	14,6	TOYOTA 43512-02330	
24.0126-0185.1	426185		B	HC	L	V	296,0	26,0	24,0	44,0	114,3	5	68,0	148,0	12,8	NISSAN 40206-4EA0A 40206-4BA0A	
24.0126-0186.1	426186		S	B	HC	V	280,0	26,0	23,8	45,0	108,0	5	61,0	139,7	15,8	RENAULT 40 20 666 24R RENAULT 40 20 682 34R	

Abmessungen Bremsscheiben

Dimensions brake discs - Misure dischi freno -

Dimensions Disques de frein - Medidas disco de freno

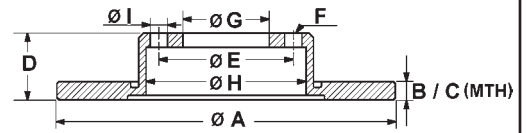

S Fixierschraube - fixing screw - vite di riparazione - vis de fixation - tornillo quefija
 B beschichtet - coated - rivestito - revêtu - recubierto
 HC hochgekohlt - high carbon - ad alto tenore di carbonio - à haute teneur en carbone - altamente carbonizado
 L legiert - alloyed - alligato/legato - allié - aleado
 V ventiliert - ventilated - ventilato - ventilé - ventilado
 ● gelocht - perforated - perforato - poinçonné - perforado

		S	B	HC	L	V	A	B	C	D	E	F	G	H	I	OE	#
24.0127-0100.1	427100		B			V	281,0	27,0	25,4	42,7	108,0	6	87,0	136,0	10,6	HYUNDAI	51712-H1000
24.0127-0101.1	427101					V	276,0	27,0	25,4	45,2	108,0	6	87,0	136,0	10,6	MITSUBISHI	MB928120
24.0128-0100.1	428100	S	B	HC	L	V●	295,0	28,0	26,0	64,5	112,0	5	67,0	154,3	15,2	MERCEDES BENZ	204 421 36 12
24.0128-0101.1	428101		B	HC		V	302,0	28,0	26,4	75,9	120,0	5	79,0	149,0	14,5	BMW	34 11 6 756 090
24.0128-0102.1	428102		B	HC	L	V	300,0	28,0	25,4	68,3	112,0	5	80,0	145,0	15,0	MERCEDES BENZ	126 421 05 12
24.0128-0103.1	428103		B	HC	L	V	300,0	28,0	25,4	45,5	112,0	5	67,0	154,3	15,0	MERCEDES BENZ	129 421 20 12
24.0128-0104.1	428104	S	B	HC	L	V	296,0	28,0	25,0	58,4	110,0	5	70,0	139,0	14,0	OPEL/VAUXHALL	5 69 044/90392559 5 69 016/93182283
24.0128-0105.1	428105	S	B	HC		V	316,0	28,0	26,4	77,0	120,0	5	79,0	159,0	14,5	BMW	34 11 6 757 752
24.0128-0106.1	428106	S	B	HC	L	V	300,0	28,0	25,4	46,5	112,0	5	67,0	154,0	13,3	CHRYSLER	5098 064AC
																MERCEDES BENZ	203 421 05 12 210 421 22 12 210 421 25 12
24.0128-0113.1	428113					V	255,0	28,0	26,0	49,2	100,0	5	55,0	131,0	14,5	TOYOTA	43512-05010
24.0128-0114.1	428114					V	255,0	28,0	26,0	49,1	114,3	5	62,0	146,5	14,6	TOYOTA	43512-33020
24.0128-0115.1	428115		B			V	275,0	28,0	26,0	49,2	114,3	5	62,0	158,5	14,8	TOYOTA	43512-07020 43512-33040 43512-33041 43512-33042 43512-33060 43512-44021 43512-05020
24.0128-0116.1	428116					V	255,0	28,0	26,0	49,3	100,0	5	55,0	155,5	14,5	TOYOTA	43512-05020
24.0128-0118.1	428118					V	310,0	28,0	26,0	47,3	108,0	5/10	59,0	141,5	14,7	ALFA ROMEO	60629865
24.0128-0119.1	428119					V	305,0	28,0	26,0	44,7	98,0	5	59,0	151,0	13,2	ALFA ROMEO	60652186 60670801
24.0128-0120.1	428120					V	305,0	28,0	26,0	44,7	98,0	4	59,0	151,0	13,2	FIAT	46465088 71738914
24.0128-0122.1	428122		B	HC		V	296,0	28,0	26,4	55,0	120,0	5	79,0	145,5	14,5	BMW	34 11 1 165 263
24.0128-0123.1	428123		B			V	305,0	27,9	25,0	50,3	108,0	5	68,0	139,0	16,5	VOLVO	274170 274559 9492715
24.0128-0125.1	428125		B	HC	L	V●	312,0	28,0	26,0	76,0	112,0	5	67,0	154,0	15,0	MERCEDES BENZ	220 421 09 12
24.0128-0126.1	428126		B	HC	L	V	316,0	28,0	25,4	46,5	112,0	5	67,0	154,3	13,0	MERCEDES BENZ	210 421 20 12
24.0128-0127.1	428127		B	HC	L	V	310,0	28,0	25,4	82,0	112,0	5	67,0	154,0	17,0	MERCEDES BENZ	140 421 03 12
24.0128-0128.1	428128	S	B			V	288,0	28,0	26,0	34,0	108,0	4	66,0	133,0	13,0	CITROEN	4246 T8 4246 W3
24.0128-0129.1	428129	S	B			V	305,5	28,0	25,0	77,8	130,0	5	90,0	157,0	15,8	NISSAN	40206-00QAD
																OPEL/VAUXHALL	44 03 038/9111038
																RENAULT	77 00 314 064
24.0128-0130.1	428130		B	HC	L	V●	318,0	28,0	26,0	67,0	130,0	5	98,0	158,8	15,4	PORSCHE	996 351 406 02
24.0128-0131.1	428131		B	HC	L	V●	318,0	28,0	26,0	67,0	130,0	5	98,0	158,8	15,4	PORSCHE	996 351 405 02
24.0128-0132.1	428132	S	B	HC		V	305,0	28,0	24,0	49,7	118,0	5	72,0	154,0	15,5	NISSAN	40206-00QAE 40206-00QAF 40206-00QAG 40206-00QAH
																OPEL/VAUXHALL	44 14 632/91165426
24.0128-0133.1	428133		B	HC		V	324,0	28,0	25,4	47,0	108,0	5	61,0	150,0	15,5	RENAULT	77 11 130 077 82 00 242 318 82 00 570 191 86 71 019 275
24.0128-0134.1	428134		B			V	305,0	28,0	26,0	44,0	108,0	5	61,0	132,0	15,5	RENAULT	77 01 206 673 86 71 012 049
24.0128-0135.1	428135		B	HC		V	308,0	28,0	25,8	47,0	108,0	5	61,0	140,0	15,5	RENAULT	82 00 242 317 82 00 570 677
24.0128-0136.1	428136		B			V	285,0	28,0	26,0	43,7	98,0	5	59,0	127,0	16,5	CITROEN	4246 P2 16 063 092 80
																FIAT/LANCIA	1325772080
																PEUGEOT	4249 H7 16 063 092 80
24.0128-0137.1	428137	S	B	HC		V	302,0	28,0	25,0	45,0	110,0	5/7	70,0	139,0	14,0	OPEL/VAUXHALL	5 69 004/93171500
																SAAB	9191247 93171500
24.0128-0138.1	428138		B			V	291,0	28,1	26,0	64,8	120,7	5	80,0	175,0	13,5	JAGUAR	JLM 20341
24.0128-0139.1	428139					V	275,0	28,0	26,0	50,8	114,3	5	60,1	143,5	14,5	LEXUS	43512-50060
24.0128-0140.1	428140		B			V	280,0	28,0	26,0	49,1	114,3	5	68,0	144,0	12,8	NISSAN	40206-3Y502 40206-3Y503 40206-4U101 40206-4U103 40206-4U107
24.0128-0142.1	428142		B	HC	L	V	312,0	28,0	25,4	64,5	112,0	5	67,0	154,0	15,3	MERCEDES BENZ	211 421 09 12
24.0128-0143.1	428143					V	305,0	28,0	26,0	28,0	108,0	4	66,0	132,9	13,0	PEUGEOT	4246 V1
24.0128-0144.1	428144		B	HC		V	316,0	28,0	25,0	50,0	108,0	5	68,0	144,0	16,5	VOLVO	30636074 30736406



Abmessungen Bremsscheiben

Dimensions brake discs - Misure dischi freno -

Dimensions Disques de frein - Medidas disco de freno

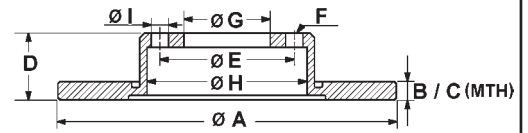

S Fixierschraube - fixing screw - vite di riparazione - vis de fixation - tornillo quefija
 B beschichtet - coated - rivestito - revêtu - recubierto
 HC hochgekohlt - high carbon - ad alto tenore di carbonio - à haute teneur en carbone - altamente carbonizado
 L legiert - alloyed - alligato/legato - allié - aleado
 V ventiliert - ventilated - ventilato - ventilé - ventilado
 ● gelocht - perforated - perforato - poinçonné - perforado

		S	B	HC	L	V	A	B	C	D	E	F	G	H	I	OE - #
24.0128-0145.1	428145	S	B	HC	L	V	300,0	28,0	25,0	58,5	112,0	5	67,0	153,0	15,0	MERCEDES BENZ 447 421 05 12 639 421 00 12 639 421 03 12
24.0128-0147.1	428147		B	HC		V	302,0	28,0	26,5	39,0	114,3	5	73,5	146,3	14,0	CHRYSLER 4683 918AB
24.0128-0148.1	428148					V	281,0	28,0	25,3	38,0	114,3	5	73,5	146,0	14,0	CHRYSLER 5073 069AA 4721 820AG
24.0128-0149.1	428149	S	B	HC		V	330,0	28,0	26,0	73,5	130,0	5	85,0	210,0	15,4	PORSCHE 955 352 401 30 955 352 401 31 VOLKSWAGEN 7L6 615 601 J 7L8 615 601 C
24.0128-0153.1	428153		B	HC		V	320,0	28,0	26,0	49,0	114,3	5	68,0	144,5	13,0	INFINITI NISSAN NISSAN 40206-EG000 40206-CA010 40206-EG000
24.0128-0154.1	428154	S	B	HC		V	300,0	28,0	26,0	52,0	108,0	5	63,5	140,0	15,8	FORD 1420601 1469085 1500158 1517696 6G91-2C375-F1B 7G91-1125-BA LAND ROVER LR000571 VOLVO LR007055 30769056 31202331 31341382
24.0128-0155.1	428155	S	B	HC	L	V	295,0	28,0	25,4	64,5	112,0	5	67,0	154,3	15,2	MERCEDES BENZ 212 421 13 12
24.0128-0156.1	428156	S	B			V	280,0	28,0	25,0	54,5	111,0	5	93,0	136,0	M10x1,5	FORD 1371394 1503290 1547061 6C11-1125-B1B 6C11-1125-BB
24.0128-0157.1	428157	S	B			V	300,0	28,0	25,0	54,5	111,0	5	93,0	136,0	M10x1,5	FORD 1371393 1503287 1546747
24.0128-0158.1	428158		B			V	321,0	28,0	26,4	49,1	114,3	5	69,0	143,0	12,5	HYUNDAI 51712-2B700
24.0128-0159.1	428159		B			V	296,0	28,0	25,0	49,2	114,3	5	62,0	145,0	14,5	LEXUS 43512-33140 TOYOTA 43512-42050 TOYOTA 43512-42090
24.0128-0162.1	428162	S	B	HC		V	316,0	28,0	26,0	52,0	108,0	5	63,5	144,0	16,0	FORD 1434812 1434815 LAND ROVER LR000470 VOLVO 30769061
24.0128-0163.1	428163		B	HC	L	V●	312,0	28,0	26,0	64,5	112,0	5	67,0	155,2	15,0	MERCEDES BENZ 230 421 04 12
24.0128-0164.1	428164	S	B	HC		V	314,0	28,0	25,0	44,9	110,0	5/7	70,0	139,0	14,0	OPEL/VAUXHALL 5 69 005/93175606 SAAB 24435132 93175606
24.0128-0165.1	428165		B	HC	L	V	298,0	28,0	26,0	50,0	126,0	5	107,0	156,0	8,4	PORSCHE 951 351 041 00
24.0128-0166.1	428166					V	300,0	28,0	26,0	38,0	124,0	6	100,0	184,0	M10x1	NISSAN 40206-1W600 40206-6W500
24.0128-0167.1	428167		B	HC	L	V	298,0	28,0	26,0	74,0	130,0	5	103,0	157,0	15,4	PORSCHE 951 351 041 01 951 351 041 02
24.0128-0169.1	428169		B	HC	L	V	358,0	28,0	26,0	73,5	130,0	5	85,0	210,0	15,4	AUDI/VOLKSWAGEN 7L8 615 601 A 7L8 615 601 D 7L8 615 601 E PORSCHE 955 352 403 00 958 352 401 50
24.0128-0171.1	428171		B	HC	L	V●	309,0	28,0	26,0	83,0	130,0	5	103,0	180,0	15,4	PORSCHE 930 352 045 01
24.0128-0172.1	428172		B	HC	L	V●	309,0	28,0	26,0	83,0	130,0	5	103,0	180,0	15,4	PORSCHE 930 352 046 01
24.0128-0174.1	428174			HC	L	V	298,0	28,0	26,0	80,0	130,0	5	103,0	161,0	15,4	PORSCHE 964 351 041 02
24.0128-0175.1	428175					V	273,5	28,0	26,0	51,0	114,3	5	72,0	142,8	13,0	MAZDA T002-33-25XA TY01-33-25X
24.0128-0176.1	428176	S	B	HC	L	V	295,0	28,0	25,4	54,5	112,0	5	67,0	154,0	15,3	MERCEDES BENZ 211 421 08 12
24.0128-0177.1	428177		B	HC	L	V●	330,0	28,0	26,0	46,5	112,0	5	67,0	154,0	13,0	MERCEDES BENZ 203 421 13 12
24.0128-0178.1	428178					V	288,0	28,0	26,0	50,0	108,0	5	71,0	130,5	13,0	CITROEN 4246 T2
24.0128-0179.1	428179		B			V	305,5	28,0	26,0	44,8	108,0	5/10	59,0	138,9	14,6	LANCIA 46776750
24.0128-0180.1	428180					V	296,0	28,0	26,0	51,0	114,3	5	72,0	142,8	13,0	MAZDA L12Y-33-25X
24.0128-0182.1	428182		B	HC		V	308,0	28,0	25,4	47,0	108,0	5	61,0	140,0	13,5	RENAULT 82 00 019 581
24.0128-0183.1	428183		B			V	275,0	28,0	26,0	49,2	100,0	5	55,0	132,0	14,5	TOYOTA 43512-20601
24.0128-0184.1	428184		B	HC		V	320,0	28,0	25,0	50,0	108,0	5	68,0	151,0	16,5	VOLVO 9475266
24.0128-0185.1	428185		B	HC		V	305,0	28,0	26,0	44,7	110,0	5/7	70,0	138,0	14,2	FIAT 51757229 71772547
24.0128-0186.1	428186		B			V	296,0	28,0	26,0	49,3	114,3	5	62,0	141,0	14,7	LEXUS 43512-48020 43512-48050
24.0128-0188.1	428188	S	B	HC	L	V	330,0	28,0	26,0	46,5	112,0	5	67,0	154,0	13,0	MERCEDES BENZ 203 421 04 12

Abmessungen Bremsscheiben

Dimensions brake discs - Misure dischi freno -

Dimensions Disques de frein - Medidas disco de freno

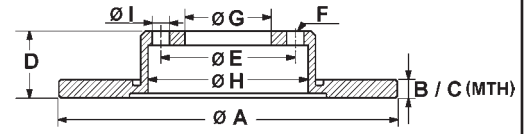

S Fixierschraube - fixing screw - vite di riparazione - vis de fixation - tornillo quefija
 B beschichtet - coated - rivestito - revêtu - recubierto
 HC hochgekohlt - high carbon - ad alto tenore di carbonio - à haute teneur en carbone - altamente carbonizado
 L legiert - alloyed - alligato/legato - allié - aleado
 V ventiliert - ventilated - ventilato - ventilé - ventilado
 ● gelocht - perforated - perforato - poinçonné - perforado

		S	B	HC	L	V	A	B	C	D	E	F	G	H	I	OE - #
24.0128-0189.1	428189					V	285,0	28,0	26,0	45,5	127,0	6	84,0	149,0	M10x1,25	TOYOTA 43512-26140 43512-26160
24.0128-0190.1	428190					V	296,0	28,0	26,0	49,2	114,3	5	62,0	156,0	14,7	TOYOTA 43512-33100 43512-28180 43512-28181
24.0128-0191.1	428191	S	B			V	330,0	28,0	26,0	39,7	110,0	5	70,0	151,0	16,6	ALFA ROMEO 51760622 51767384 JEEP 0 4779 884AC 4779 884AC
24.0128-0192.1	428192	S	B			V	305,0	28,0	26,0	39,7	110,0	5	70,0	138,0	16,6	ALFA ROMEO 51760621 51767381 51767382
24.0128-0194.1	428194		B			V	338,0	28,0	26,0	67,5	139,7	6	108,0	172,0	14,5	LEXUS/TOYOTA 43512-60150 43512-60151
24.0128-0195.1	428195					V	295,0	28,0	26,0	50,0	108,0	5	71,0	130,6	13,0	PEUGEOT 4246 L0
24.0128-0196.1	428196		B	HC	L	V●	330,0	28,0	26,0	75,0	130,0	5	98,0	180,0	15,4	PORSCHE 996 352 406 00 996 352 406 01 996 352 406 02 996 352 406 03
24.0128-0197.1	428197		B	HC	L	V●	330,0	28,0	26,0	75,0	130,0	5	98,0	180,0	15,4	PORSCHE 996 352 405 00 996 352 405 01 996 352 405 02 996 352 405 03
24.0128-0198.1	428198	S	B	HC		V	315,0	28,0	26,4	52,5	120,0	5	79,0	152,0	14,5	BMW 34 11 2 227 171
24.0128-0199.1	428199	S	B	HC		V	315,0	28,0	26,4	52,5	120,0	5	79,0	152,0	14,5	BMW 34 11 2 227 172
24.0128-0200.1	428200		B			V	302,0	28,0	26,0	54,0	139,6	5	96,3	163,0	12,5	KIA 51712-3E000
24.0128-0201.1	428201		B	HC	L	V	321,0	28,0	25,0	44,0	110,0	5/7	70,0	139,0	14,0	OPEL/AUXHALL 5 69 017/93185814
24.0128-0202.1	428202		B	HC	L	V	303,0	28,0	25,0	93,0	145,0	6	120,0	172,0	15,0	MERCEDES BENZ 906 421 01 12 VOLKSWAGEN 2E0 615 601
24.0128-0203.1	428203	S	B	HC	L	V	300,0	28,0	25,0	68,5	130,0	6	85,0	155,0	15,0	MERCEDES BENZ 906 421 00 12 VOLKSWAGEN 2E0 615 301
24.0128-0204.2	428204	S	B	HC		V	315,0	28,0	26,4	52,5	120,0	5	79,0	155,0	14,5	BMW 34 11 2 227 737
24.0128-0205.2	428205	S	B	HC		V	315,0	28,0	26,4	52,5	120,0	5	79,0	155,0	14,5	BMW 34 11 2 227 738
24.0128-0206.2	428206	S	B	HC		V●	325,0	28,0	26,4	52,5	120,0	5	79,0	154,8	14,5	BMW 34 11 2 282 801
24.0128-0207.2	428207	S	B	HC		V●	325,0	28,0	26,4	52,5	120,0	5	79,0	154,8	14,5	BMW 34 11 2 282 802
24.0128-0208.2	428208	S	B	HC		V●	345,0	28,0	26,4	52,5	120,0	5	79,0		14,5	BMW 34 11 2 282 445
24.0128-0209.2	428209	S	B	HC		V●	345,0	28,0	26,4	52,5	120,0	5	79,0		14,5	BMW 34 11 2 282 446
24.0128-0210.1	428210	S	B	HC		V	336,0	28,0	26,0	52,0	108,0	5	63,5	152,0	16,0	VOLVO 30769057
24.0128-0211.1	428211		B			V	274,0	28,3	26,0	50,6	114,3	5	72,0	140,0	13,0	KIA 0K58B-33-251
24.0128-0212.1	428212					V	296,0	28,0	26,0	49,5	114,3	5	62,0	141,3	14,5	TOYOTA 43512-48011
24.0128-0213.1	428213		B			V	280,0	28,0	25,9	71,5	118,0	5	73,0	142,0	15,5	CITROEN 4249 K2 16 078 721 80 FIAT 51705749 51740246 51848621
24.0128-0214.1	428214	S	B			V	280,0	28,0	26,0	48,0	108,0	5	71,1	152,0	13,2	PEUGEOT 16 078 721 80 CITROEN 4249 J9 FIAT 9467548387 PEUGEOT 4249 J9 TOYOTA SU001-A1063
24.0128-0215.1	428215		B			V	332,0	28,0	26,0	56,3	139,7	6	94,0	171,0	12,8	MITSUBISHI 4615A038
24.0128-0216.1	428216	S	B			V	304,0	28,0	26,0	48,0	108,0	5	71,0	145,5	13,2	CITROEN 4249 25 4249 K0 16 118 419 80 FIAT 9467548587 9467548588
24.0128-0217.1	428217	S	B			V	293,0	28,0	26,0	47,1	114,3	5	64,1	155,0	12,7	PEUGEOT 4249 24 4249 K0 TOYOTA SU001-A1064
24.0128-0219.1	428219		B			V	305,0	28,0	26,0	44,7	100,0	4	60,0	139,0	14,2	HONDA 45251-T1E-G01 51822457
24.0128-0220.1	428220		B			V	300,0	28,0	26,0	54,0	139,6	6	96,3	163,0	12,5	FIAT 51712-4D200
24.0128-0223.1	428223	S	B	HC		V	312,5	28,0	26,0	63,0	100,0	5	61,0	151,0	15,5	KIA 51712-H1030
24.0128-0224.1	428224		B			V	303,5	28,0	26,4	42,7	108,0	6	87,0	147,0	10,6	RENAULT 77 01 208 130
24.0128-0226.1	428226		B	HC	L	V	289,0	28,0	26,0	70,2	140,0	6	98,0	164,0	13,0	HYUNDAI 1490412 FORD 6M34-1027-DA UR61-33-251
24.0128-0227.1	428227		B			V	302,0	28,0	26,4	54,0	139,6	5	96,3	163,0	12,5	MAZDA 51712-3E500
24.0128-0228.1	428228		B			V	295,6	28,0	26,0	48,2	114,3	5	72,0	142,8	13,0	KIA L206-33-25XA
24.0128-0229.1	428229		B			V	325,0	28,3	26,0	49,5	120,7	5	73,8	155,0	13,5	MAZDA JLM 20617
24.0128-0231.1	428231		B	HC		V	305,0	28,0	26,0	44,8	98,0	4	59,0	139,0	13,2	JAGUAR 51738833 FIAT 51813785
24.0128-0232.1	428232		B			V	296,0	28,0	25,0	49,2	114,3	5	62,0	154,0	14,5	FIAT TOYOTA 43512-28190



Abmessungen Bremsscheiben

Dimensions brake discs - Misure dischi freno -

Dimensions Disques de frein - Medidas disco de freno

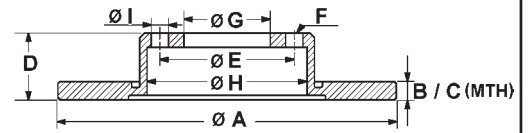

S Fixierschraube - fixing screw - vite di riparazione - vis de fixation - tornillo quefija

B beschichtet - coated - rivestito - revêtu - recubierto

HC hochgekohlt - high carbon - ad alto tenore di carbonio - à haute teneur en carbone - altamente carbonizado

L legiert - alloyed - alligato/legato - allié - aleado

V ventiliert - ventilated - ventilato - ventilé - ventilado

● gelocht - perforated - perforato - poinçonné - perforado

		S	B	HC	L	V	A	B	C	D	E	F	G	H	I	OE - #		
24.0128-0233.1	428233		B			V	320,0	28,0	26,0	48,2	114,3	5	72,0	143,0	13,0	MAZDA	EH14-33-25XA	
24.0128-0234.1	428234		B			V	300,0	28,0	26,4	47,3	114,3	5	69,0	141,5	12,5	HYUNDAI	51712-2L500	
24.0128-0238.1	428238		B			V	300,0	28,0	25,0	74,5	125,0	6	78,0	156,0	15,5	IVECO	2996131	
24.0128-0239.1	428239		B			V	290,0	28,0	25,0	46,0	95,0	9	64,0	123,0	12,5	IVECO	2996121	
24.0128-0240.1	428240		B	HC	L	V	320,0	28,0	26,0	38,0	114,3	5	68,0	175,0	12,8	NISSAN	40206-EB320 40206-3X00B 40206-5X00A	
24.0128-0241.1	428241		B	HC	L	V	296,0	28,0	26,0	38,0	114,3	6	68,0	161,0	12,8	NISSAN	40206-EB300	
24.0128-0242.1	428242		B			V	320,0	28,0	26,0	44,0	114,3	5	68,0	146,5	12,7	NISSAN RENAULT	40206-ET01A 40 20 698 28R	
24.0128-0243.1	428243		B	HC	L	V	305,0	28,0	26,0	44,7	98,0	4	59,0	191,0	13,0	FIAT	51817217	
24.0128-0244.1	428244		B	HC	L	V	276,0	28,0	26,0	45,2	118,0	5	94,0	151,5	M12x1,5	NISSAN RENAULT	40206-MB600 50 01 871 213	
24.0128-0245.1	428245	S	B	HC	L	V	320,0	28,0	25,4	44,0	114,3	5	68,0	147,7	15,8	RENAULT	40 20 600 03R 40 20 641 55R	
24.0128-0246.1	428246		B	HC	L	V●	330,0	28,0	26,0	69,0	130,0	5	98,0	159,7	15,4	PORSCHE	997 351 402 00 997 351 402 01	
24.0128-0247.1	428247		B	HC	L	V●	330,0	28,0	26,0	69,0	130,0	5	98,0	159,7	15,4	PORSCHE	997 351 401 00 997 351 401 01	
24.0128-0248.1	428248		B	HC	L	V	321,0	28,0	26,4	49,1	114,3	5	69,0	143,0	12,5	HYUNDAI	51712-2P700 51712-2W700	
24.0128-0249.1	428249		B			V	258,0	28,0	26,0	58,6	114,3	5	62,0	141,0	14,5	KIA TOYOTA	51712-2P700 43512-0K010 43512-0K030	
24.0128-0250.1	428250		B	HC		V	300,0	28,0	26,0	52,0	108,0	5	63,5	140,0	13,8	FORD	1500159 7G91-1125-EA	
24.0128-0251.1	428251		B	HC		V	303,0	28,0	26,0	56,9	120,0	5	76,0	165,2	16,6	VOLKSWAGEN	2H0 615 301 A	
24.0128-0252.1	428252	S	B			V	302,0	28,0	24,5	69,9	130,0	5	90,0	160,5	17,4	NISSAN OPEL/VAUXHALL RENAULT	40206-00Q0G 44 19 359/93197403 82 00 688 880	
24.0128-0253.1	428253		B	HC	L	V	305,0	28,0	26,0	45,7	98,0	5	59,2	127,0	13,0	FIAT	51897455 51914663	
24.0128-0254.1	428254	S	B	HC		V	328,0	28,0	26,4	73,1	120,0	5	75,0	153,8	16,5	OPEL/VAUXHALL	5 69 087/95511283	
24.0128-0255.1	428255		B			V	350,0	28,0	26,0	68,1	127,0	5	72,0	205,0	16,2	BMW	34 10 6 787 490	
24.0128-0256.1	428256		B	HC	L	V	300,0	28,0	26,4	47,3	114,3	5	69,0	142,5	12,5	JEEP HYUNDAI	5290 731AB 51712-3K150	
24.0128-0258.1	428258		B	HC	L	V	320,0	28,1	26,4	47,3	114,3	5	69,0	145,0	12,5	HYUNDAI/KIA	51712-3K160 51712-3K160 51712-2Y000	
24.0128-0260.1	428260		B	HC	L	V●	315,0	28,0	26,0	69,0	130,0	5	98,0	159,0	15,4	PORSCHE	981 351 402 01	
24.0128-0262.1	428262		S	B	HC	L	V●	295,0	28,0	26,0	51,1	112,0	5	67,0	154,6	15,0	MERCEDES BENZ	246 421 25 12
24.0128-0263.1	428263		B	HC		V	302,0	28,0	26,4	38,2	127,0	5	72,5	166,0	14,0	CHRYSLER	0 6803 2944AB 6803 2944AB K68032944AB	
24.0128-0264.1	428264		B	HC	L	V●	350,0	28,0	26,0	75,0	130,0	5	98,0	180,0	15,4	PORSCHE	997 352 406 02	
24.0128-0265.1	428265		B	HC	L	V●	350,0	28,0	26,0	75,0	130,0	5	98,0	180,0	15,4	PORSCHE	997 352 405 02	
24.0128-0269.1	428269	S	B	HC		V	304,0	28,0	26,0	48,0	108,0	5	71,0	133,2	13,2	CITROEN/PEUGEOT	4249 K1	
24.0128-0273.1	428273		B	HC	L	V●	315,0	28,0	26,0	69,0	130,0	5	98,0	159,0	15,4	PORSCHE	981 351 401 01	
24.0128-0275.1	428275	S	B	HC	L	V	295,0	28,0	25,4	51,1	112,0	5	67,0	154,6	15,0	MERCEDES BENZ	246 421 24 12	
24.0128-0276.1	428276	S	B	HC	L	V	295,0	28,0	25,4	51,0	112,0	5	67,0	155,0	15,0	MERCEDES BENZ	246 421 01 12	
24.0128-0280.1	428280		B	HC	L	V	300,0	28,0	26,4	47,2	114,3	5	69,0	142,5	12,5	KIA	51712-0Z000	
24.0128-0282.1	428282	S	B	HC	L	V	330,0	28,0	26,0	75,0	130,0	5	98,0	180,0	15,4	PORSCHE	970 352 403 00 298 615 601 A	
24.0128-0283.1	428283	S	B	HC	L	V	330,0	28,0	26,0	75,0	130,0	5	98,0	180,0	15,4	PORSCHE	970 352 404 00 298 615 602 A	
24.0128-0286.1	428286		B	HC	L	V	300,0	28,0	26,5	50,9	108,0	5	63,5	139,7	13,8	FORD	5202199 DG9C-1125-AC	
24.0128-0288.1	428288	S	B	HC	L	V	340,0	28,0	26,0	63,0	114,3	5	68,0	162,0	13,5	RENAULT	40 20 600 19R	
24.0128-0291.1	428291		B			V	320,0	28,0	26,0	44,0	114,3	5	68,0	153,7	12,7	NISSAN	40206-4CE0A	
24.0128-0708.1	428708			HC		V	288,0	28,0	26,0	64,8	114,3	5	72,0	158,0	15,5	JEEP	5212 8247AA 5212 8247AB 5212 8247AC	
24.0128-0722.1	428722					V	282,0	28,0	26,0	47,0	114,3	5	70,2	148,2	12,6	HONDA	45251-SP0-E00	
24.0128-0740.1	428740		B			V	296,0	28,0	26,0	49,2	114,3	5	62,0	149,0	14,5	LEXUS	43512-30310	
24.0128-0753.1	428753		B			V	319,0	28,0	26,0	49,3	114,3	5	62,0	178,5	14,7	LEXUS	43512-48080 43512-48081 43512-48100	
24.0129-0100.1	429100		B			V	305,0	28,5	26,0	49,5	120,7	5	73,8	154,5	13,4	JAGUAR	JLM 20150	
24.0129-0101.1	429101		B	HC	L	V	296,0	29,0	27,5	51,6	115,0	5	70,7	154,5	12,8	CHEVROLET	96625948 20955857 4801850	
																OPEL/VAUXHALL	48 08 848/96625948	

Abmessungen Bremsscheiben

Dimensions brake discs - Misure dischi freno -

Dimensions Disques de frein - Medidas disco de freno

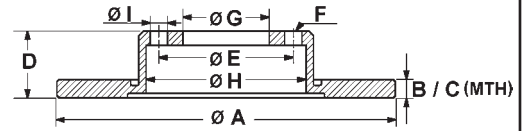

S Fixierschraube - fixing screw - vite di riparazione - vis de fixation - tornillo quefija L legiert - alloyed - alligato/legato - allié - aleado ● gelocht - perforated - perforato - poinçonné - perforado
 B beschichtet - coated - rivestito - revêtu - recubierto V ventiliert - ventilated - ventilato - ventilé - ventilado
 HC hochgekohlt - high carbon - ad alto tenore di carbonio - à haute teneur en carbone - altamente carbonizado

	S	B	H	L	V	A	B	C	D	E	F	G	H	I	OE - #
24.0132-0131.1 432131		B			V	300,0	32,0	29,9	73,5	130,0	5	80,0	161,0	18,0	CITROEN FIAT PEUGEOT 4249 38 4249 A6 16 078 723 80 51705758 51740249 4249 37 4249 A6 16 078 723 80
24.0132-0136.1 432136		B	HC	L	V●	330,0	32,0	30,0	47,5	112,0	5	67,0	154,0	15,0	MERCEDES BENZ 220 421 18 12
24.0132-0137.1 432137	S	B	HC	L	V●	335,0	32,0	30,0	64,5	112,0	5	67,0	154,0	15,2	MERCEDES BENZ 221 421 17 12
24.0132-0138.1 432138	S	B	HC	L	V●	350,0	32,0	30,0	64,5	112,0	5	67,0	154,0	15,2	MERCEDES BENZ 221 421 00 12 221 421 16 12
24.0132-0139.1 432139	S	B	HC	L	V	350,0	32,0	29,4	64,5	112,0	5	67,0	154,0	15,2	MERCEDES BENZ 219 421 01 12
24.0132-0140.1 432140		B	HC	L	V●	304,0	32,0	30,6	56,7	126,0	5	107,0	172,0	8,4	PORSCHE 930 351 047 02
24.0132-0142.1 432142		B	HC	L	V●	304,0	32,0	30,0	72,0	130,0	5	103,0	161,0	15,4	PORSCHE 993 351 043 01
24.0132-0143.1 432143		B	HC	L	V●	304,0	32,0	30,0	72,0	130,0	5	103,0	161,0	15,4	PORSCHE 993 351 044 01
24.0132-0144.1 432144	S	B	HC	L	V	330,0	32,0	29,4	64,5	112,0	5	67,0	154,0	15,0	MERCEDES BENZ 204 421 29 12 211 421 10 12 211 421 13 12 211 421 14 12
24.0132-0146.1 432146		B	HC	L	V●	304,0	32,0	30,6	56,7	126,0	5	107,0	172,0	8,4	PORSCHE 930 351 048 02
24.0132-0147.1 432147		B	HC	L	V●	334,0	32,0	30,0	51,5	112,0	5	67,0	154,0	13,0	MERCEDES BENZ 129 421 23 12
24.0132-0148.1 432148		B			V	313,0	32,0	30,0	70,0	144,0	5	115,0	172,5	12,5	LEXUS/TOYOTA 43512-60130 43512-60170
24.0132-0150.1 432150		B	HC	L	V	304,0	32,0	30,0	77,0	130,0	5	103,0	161,0	15,4	PORSCHE 928 351 044 03 928 351 044 60
24.0132-0151.1 432151		B	HC	L	V	304,0	32,0	30,0	77,0	130,0	5	103,0	161,0	15,4	PORSCHE 928 351 043 03 928 351 043 60
24.0132-0152.1 432152					V	309,0	32,0	30,0	43,1	108,0	5	71,1	136,0	13,0	PEUGEOT 4246 V5
24.0132-0153.1 432153	S	B	HC	L	V●	330,0	32,0	30,0	64,5	112,0	5	67,0	154,0	15,0	MERCEDES BENZ 230 421 08 12
24.0132-0154.1 432154		B	HC	L	V	330,0	32,0	29,4	47,5	112,0	5	67,0	154,0	15,0	MERCEDES BENZ 211 421 11 12
24.0132-0157.1 432157	S	B	HC	L	V	350,0	32,0	29,4	54,5	112,0	5	67,0	156,3	15,2	MERCEDES BENZ 164 421 05 12 164 421 14 12
24.0132-0158.1 432158	S	B	HC	L	V	330,0	32,0	29,4	54,5	112,0	5	67,0	156,3	15,2	MERCEDES BENZ 164 421 04 12 164 421 13 12
24.0132-0159.1 432159		B	HC	L	V	330,0	32,0	29,4	46,5	112,0	5	67,0	154,0	13,0	CHRYSLER 5135 475AA MERCEDES BENZ 210 421 23 12
24.0132-0160.1 432160	S	B	HC		V	334,0	31,9	30,4	62,9	120,0	5	79,0	159,0	14,8	BMW 34 11 1 165 072
24.0132-0161.2 432161	S	B	HC		V	345,0	32,0	30,4	77,0	120,0	5	79,0	159,5	14,5	BMW 34 11 2 282 803
24.0132-0162.2 432162	S	B	HC		V	345,0	32,0	30,4	77,0	120,0	5	79,0	159,5	14,5	BMW 34 11 2 282 804
24.0132-0163.2 432163		B	HC	L	V●	322,0	32,0	30,0	72,0	130,0	5	103,0	157,0	15,4	PORSCHE 993 351 045 10
24.0132-0164.2 432164		B	HC	L	V●	322,0	32,0	30,0	72,0	130,0	5	103,0	157,0	15,4	PORSCHE 993 351 046 10
24.0132-0165.2 432165		B	HC		V	334,0	32,0	30,0	35,0	100,0	5/9	65,0	146,0	15,6	AUDI 8N0 615 302 B VOLKSWAGEN 1J0 615 302 A
24.0132-0166.2 432166		B	HC		V	334,0	32,0	30,0	35,0	100,0	5/9	65,0	146,0	15,6	AUDI 8N0 615 301 B VOLKSWAGEN 1J0 615 301 AA
24.0132-0167.1 432167	S	B	HC	L	V	375,0	32,0	29,4	54,5	112,0	5	67,0	156,3	15,2	MERCEDES BENZ 164 421 15 12
24.0132-0168.1 432168	S	B	HC	L	V●	344,0	32,0	30,0	64,5	112,0	5	67,0	154,3	15,0	MERCEDES BENZ 204 421 11 12 000 421 14 12 000 421 15 12
24.0132-0169.1 432169		B	HC		V	321,0	32,0	30,0	51,0	114,3	5	69,0	143,0	12,5	HYUNDAI 51712-3J500
24.0132-0170.1 432170	S	B	HC	L	V●	322,0	32,0	30,0	51,5	112,0	5	67,0	154,2	15,2	MERCEDES BENZ 000 421 18 12 218 421 03 12
24.0132-0172.1 432172	S	B	HC		V	320,0	32,0	30,0	47,2	114,3	5	64,2	151,0	12,6	HONDA 45251-TL0-G51
24.0132-0175.1 432175	S	B	HC	L	V●	344,0	32,0	30,0	64,5	112,0	5	67,0	154,3	15,2	MERCEDES BENZ 000 421 16 12
24.0132-0178.1 432178	S	B	HC	L	V	330,0	32,0	29,4	54,5	112,0	5	67,0	158,0	15,0	MERCEDES BENZ 166 421 06 12
24.0132-0179.1 432179	S	B	HC	L	V●	350,0	32,0	29,4	54,0	112,0	5	67,0	158,0	15,0	MERCEDES BENZ 166 421 10 12
24.0132-0701.1 432701		B			V	296,0	32,0	30,0	50,8	114,3	5	62,0	143,5	14,5	LEXUS 43512-30180 43512-30181 43512-50100 43512-50110 43512-53010 43512-53020
24.0133-0100.1 433100	S	B	HC		V	340,0	32,6	29,5	55,6	120,0	5	76,0	154,8	16,6	VOLKSWAGEN 7E0 615 301 C
24.0133-0101.1 433101	S	B	HC	L	V	288,0	33,0	30,0	55,3	111,0	5	93,1	136,0	M10x1,5	FORD 1842994 BK21-1125-BC 3D0 615 301 F 4E0 615 301 P
24.0134-0100.1 434100		B	HC		V	360,0	34,0	31,0	59,7	112,0	5	68,0	135,0	15,0	AUDI/VW 996 351 409 02 996 351 409 03 996 351 409 05
24.0134-0101.1 434101		B	HC	L	V●	330,0	34,0	32,0	69,5	130,0	5	98,0	173,5	15,4	PORSCHE 996 351 410 02 996 351 410 03 996 351 410 05
24.0134-0102.1 434102		B	HC	L	V●	330,0	34,0	32,0	69,5	130,0	5	98,0	173,5	15,4	PORSCHE 996 351 410 02 996 351 410 03 996 351 410 05

Abmessungen Bremsscheiben

Dimensions brake discs - Misure dischi freno -

Dimensions Disques de frein - Medidas disco de freno

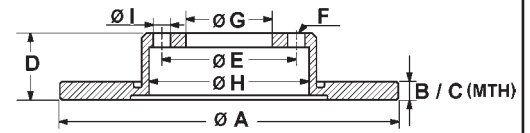

S Fixierschraube - fixing screw - vite di riparazione - vis de fixation - tornillo quefija

B beschichtet - coated - rivestito - revêtu - recubierto

HC hochgekohlt - high carbon - ad alto tenore di carbonio - à haute teneur en carbone - altamente carbonizado

L legiert - alloyed - alligato/legato - allié - aleado

V ventiliert - ventilated - ventilato - ventilé - ventilado

● gelocht - perforated - perforato - poinçonné - perforado

		S	B	HC	L	V	A	B	C	D	E	F	G	H	I	OE - #	
24.0134-0103.1	434103	S	B	HC		V	356,0	34,0	31,5	52,4	112,0	5	68,0	149,0	15,3	AUDI PORSCHÉ	4G0 615 301 K 997 351 409 90
24.0134-0105.1	434105		B	HC	L	V●	350,0	34,0	32,0	67,5	130,0	5	98,0	185,0	15,4	PORSCHÉ	997 351 410 90
24.0134-0106.1	434106		B	HC	L	V●	350,0	34,0	32,0	67,5	130,0	5	98,0	185,0	15,4	PORSCHÉ	997 351 410 90
24.0134-0123.1	434123		B	HC	L	V	350,0	34,0	32,0	68,5	130,0	5	85,0	185,0	15,4	AUDI/VW PORSCHÉ	7L6 615 301 K 7L8 615 301 995 351 40 150 955 351 401 51
24.0134-0124.1	434124		B	HC	L	V	350,0	34,0	32,0	68,5	130,0	5	85,0	185,0	15,4	AUDI/VW PORSCHÉ	7L6 615 302 K 7L8 615 302 995 351 40 250 955 351 402 51
24.0136-0101.1	436101		B	HC		V	374,0	36,0	34,4	81,0	120,0	5	79,0	187,0	16,5	BMW	34 11 6 766 107
24.0136-0102.1	436102		B	HC	L	V●	360,0	36,0	34,0	64,5	112,0	5	67,0	154,0	15,2	MERCEDES BENZ	221 421 18 12
24.0136-0103.1	436103		B	HC		V	385,0	36,0	33,5	59,7	112,0	5	68,0	135,0	15,3	AUDI	4E0 615 301 K
24.0136-0104.1	436104		B	HC		V	356,0	36,0	34,4	61,9	120,0	5	75,0	158,0	16,5	BMW	34 11 6 756 847
24.0136-0105.1	436105		B	HC	L	V●	360,0	36,0	34,0	76,0	112,0	5	67,0	154,0	15,0	MERCEDES BENZ	220 421 19 12
24.0136-0106.2	436106	S	B	HC		V	348,0	36,0	34,4	77,0	120,0	5	79,0	154,3	14,5	BMW	34 11 6 766 871 34 11 6 779 467
24.0136-0107.1	436107		B	HC		V	385,0	36,0	33,5	61,4	112,0	5	68,0	135,0	15,2	AUDI	4F0 615 301 J
24.0136-0108.1	436108	S	B	HC	L	V●	360,0	36,0	34,0	64,5	112,0	5	67,0	154,0	15,2	MERCEDES BENZ	000 421 20 12 221 421 08 12
24.0136-0109.1	436109	S	B	HC		V	365,0	36,0	34,4	62,0	120,0	5	75,0	168,0	16,5	BMW	34 11 6 793 243
24.0136-0110.1	436110		B	HC		V	348,0	35,9	34,4	80,9	120,0	5	79,0	154,0	16,5	BMW	34 11 6 767 353
24.0136-0111.1	436111		B	HC		V	368,0	36,0	34,0	68,7	130,0	5	85,0	157,0	15,4	PORSCHÉ VOLKSWAGEN	955 351 403 00 7L8 615 301 A
24.0136-0112.2	436112	S	B	HC		V	385,0	36,0	34,4	62,0	120,0	5	75,0	153,7	16,5	BMW	34 11 6 782 068
24.0136-0113.2	436113	S	B	HC		V	385,0	36,0	34,4	62,0	120,0	5	75,0	153,7	16,5	BMW	34 11 6 782 067
24.0136-0114.2	436114	S	B	HC		V	348,0	36,0	34,4	66,0	120,0	5	75,0	153,7	16,5	BMW	34 11 6 785 670
24.0136-0115.2	436115	S	B	HC		V	348,0	36,0	34,4	66,0	120,0	5	75,0	153,7	16,5	BMW	34 11 6 785 669
24.0136-0116.2	436116	S	B	HC		V●	374,0	36,0	34,4	77,0	120,0	5	79,0	174,0	14,5	BMW	34 11 2 282 806
24.0136-0117.2	436117	S	B	HC		V●	374,0	36,0	34,4	77,0	120,0	5	79,0	174,0	14,5	BMW	34 11 2 282 805
24.0136-0118.2	436118	S	B	HC		V	374,0	36,0	34,4	66,0	120,0	5	75,0	186,8	16,5	BMW	34 11 6 785 676
24.0136-0119.2	436119	S	B	HC		V	374,0	36,0	34,4	66,0	120,0	5	75,0	186,8	16,5	BMW	34 11 6 785 675
24.0136-0120.2	436120	S	B	HC		V	374,0	36,0	34,4	66,0	120,0	5	75,0	153,8	16,5	BMW	34 11 6 789 544
24.0136-0121.2	436121	S	B	HC		V	374,0	36,0	34,4	66,0	120,0	5	75,0	153,8	16,5	BMW	34 11 6 789 543
24.0136-0122.1	436122		B	HC		V	380,0	36,0	34,0	48,0	108,0	5	71,0	200,0	14,0	JAGUAR	C2P 12622
24.0136-0123.1	436123	S	B	HC		V	360,0	36,0	34,0	68,5	130,0	5	85,0	160,0	15,4	PORSCHÉ	958 351 403 01 958 351 403 00
24.0136-0124.1	436124	S	B	HC		V	360,0	36,0	34,0	68,5	130,0	5	85,0	160,0	15,4	VOLKSWAGEN PORSCHÉ	7P6 615 301 A 958 351 404 01 958 351 404 00
24.0136-0125.2	436125	S	B	HC		V●	400,0	36,0	34,4	63,2	120,0	5	75,0	198,0	16,5	BMW	34 11 2 284 102
24.0136-0126.2	436126	S	B	HC		V●	400,0	36,0	34,4	63,2	120,0	5	75,0	198,0	16,5	BMW	34 11 2 284 101
24.0136-0127.1	436127	S	B	HC	L	V	360,0	36,0	34,0	68,6	130,0	5	98,0	160,0	15,4	PORSCHÉ	970 351 404 00 298 615 302 B
24.0136-0128.1	436128	S	B	HC	L	V	360,0	36,0	34,0	68,6	130,0	5	98,0	160,0	15,4	PORSCHÉ	970 351 403 00 298 615 301 B



Abmessungen PowerDisc

Dimensions PowerDisc - Misure PowerDisc -

Dimensions PowerDisc - Medidas PowerDisc

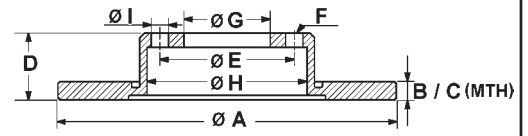

S Fixierschraube - fixing screw - vite di riparazione - vis de fixation - tornillo quefija

B beschichtet - coated - rivestito - revêtu - recubierto

HC hochgekohlt - high carbon - ad alto tenore di carbonio - à haute teneur en carbone - altamente carbonizado

L legiert - alloyed - alligato/legato - allié - aleado

V ventiliert - ventilated - ventilato - ventilé - ventilado

		S	B	HC	L	V	A	B	C	D	E	F	G	H	I	OE - #
24.0311-0158.1	511158		B				280,0	11,0	9,0	41,0	108,0	5	63,5	192,0	13,7	FORD VOLVO 1253962 1373361 1500156 7M51-2A315-BA 30769113 31341645
24.0311-0171.1	511171		B				271,0	11,0	9,0	40,7	108,0	5	63,5	152,0	13,8	FORD 1704765
24.0312-0106.1	512106		S	B			239,0	12,0	10,0	35,4	100,0	4	65,0	124,5	13,6	AUDI/SEAT/VW AUDI/VW 321 615 301 175 615 301
24.0312-0125.1	512125		B				239,0	12,0	10,8	42,5	98,0	4	58,5	127,0	13,1	LADA 2108-3501070
24.0312-0126.1	512126		S	B			286,0	12,0	9,6	51,5	120,0	5	79,0	148,0	14,5	BMW 34 11 6 757 750 34 11 6 757 751
24.0312-0141.1	512141		B				239,5	12,0	10,0	42,9	108,0	4	63,5	136,0	13,7	FORD MAZDA 1013581 1019598 1112542 1E03-33-251 1E03-33-251A 1E04-33-251
24.0312-0144.1	512144		S	B	HC	L	260,0	12,0	10,0	40,4	112,0	5	67,0	145,0	13,3	MERCEDES BENZ 168 421 01 12
24.0312-0148.1	512148		B				255,0	12,0	10,0	40,0	112,0	5/9	68,0	144,5	15,3	AUDI 8E0 615 601 D 8E0 615 601 Q
24.0312-0151.1	512151		B				288,0	11,9	10,0	64,8	108,0	5	68,0	178,0	16,5	VOLVO 9434167
24.0312-0152.1	512152		B	HC			324,0	12,0	9,6	80,2	120,0	5	75,0	185,0	16,8	BMW 34 21 6 859 678
24.0312-0154.1	512154		B				280,0	12,0	10,0	34,0	108,0	5	63,5	151,0	13,7	FORD 1676983 4176921 4179406 7S7J-2A315-BB
24.0312-0157.1	512157		S	B			278,0	11,9	10,0	41,4	110,0	5	65,5	145,2	14,0	FIAT 46836489 71772552
24.0312-0158.1	512158		B				256,0	12,0	10,0	48,6	112,0	5/9	65,0	140,0	15,3	AUDI/SKODA/VW 1K0 615 601 L 1K0 615 601 AC
24.0312-0159.1	512159		B				302,0	12,0	10,0	49,4	112,0	5/9	68,0	177,0	15,3	AUDI 4F0 615 601 E
24.0312-0166.1	512166		B				288,0	12,0	10,0	36,0	112,0	5	68,0	162,0	15,3	AUDI 8E0 615 601 M
24.0312-0167.1	512167		S	B	HC	L	276,0	12,0	10,0	44,5	112,0	5	67,0	145,0	15,3	MERCEDES BENZ 169 421 00 12
24.0312-0169.1	512169		S	B			282,0	12,0	10,0	48,6	112,0	5/9	65,0	159,0	15,3	AUDI/SKODA/VW 1K0 615 601 AD 1K0 615 601 M
24.0312-0178.1	512178		S	B			300,0	12,0	10,0	36,4	112,0	5	68,0	169,0	15,3	AUDI 8K0 615 601 B
24.0312-0187.1	512187		S	B			292,0	12,0	10,5	48,0	120,0	5	67,4	171,5	16,3	OPEL/VAUXHALL 5 69 025/13501302 5 69 127/13502198 13502198
24.0312-0188.1	512188		S	B			268,0	12,0	10,0	44,9	105,0	5	60,0	147,0	14,2	SAAB CHEVROLET 13502135/13502136
24.0312-0189.1	512189		S	B			292,0	12,0	10,0	45,0	115,0	5	70,7	157,0	14,2	OPEL/VAUXHALL CHEVROLET 13502139 5 69 071/13502138 5 69 075/13502137 5 69 085/13504280
24.0313-0161.1	513161		S	B			236,0	12,7	9,7	41,0	100,0	4/6	60,0	123,0	14,0	OPEL/VAUXHALL 5 69 020/90008005 5 69 030/90008031 5 69 013/93182290
24.0313-0178.1	513178		S	B			255,6	12,9	11,0	39,2	100,0	4	65,0	135,5	13,6	SEAT/VW 357 615 301
24.0313-0181.1	513181		B	HC			280,0	13,0	11,0	46,5	112,0	5	68,0	159,0	15,4	AUDI 8D0 615 301 A
24.0313-0184.1	513184		S	B			266,0	13,0	11,0	27,2	108,0	4	66,0	133,0	13,0	CITROEN 16 086 916 80 4246 R4 4249 82
24.0313-0185.1	513185		S	B			247,5	13,0	11,0	34,2	108,0	4	66,0	133,0	13,0	PEUGEOT 16 086 916 80 4246 R2
24.0315-0105.1	515105		B	HC			288,0	15,0	13,0	46,5	112,0	5	68,0	135,5	15,4	AUDI 4A0 615 301 B
24.0318-0106.1	518106		S	B	HC	V	239,0	18,0	16,0	34,5	100,0	4	65,0	125,0	13,6	SEAT/VW VOLKSWAGEN 6N0 615 301 C 6N0 615 301 F
24.0318-0137.1	518137		S	B	HC	V	239,0	18,0	16,0	35,0	100,0	5	65,0	125,0	15,6	SKODA/VW VOLKSWAGEN 6Q0 615 301 6Q0 615 301 A
24.0319-0107.1	519107		S	B	HC	V	276,0	19,0	16,6	60,3	120,0	5	75,0	160,8	14,5	BMW 34 21 6 855 155 34 21 6 864 903
24.0319-0108.1	519108		S	B	HC	V	294,0	18,9	17,4	59,7	120,0	5	75,0	160,8	14,8	BMW 34 21 1 165 563 34 21 6 864 056

Abmessungen PowerDisc

Dimensions PowerDisc - Misure PowerDisc - Dimensiones PowerDisc - Medidas PowerDisc

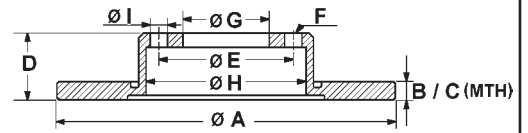

S Fixierschraube - fixing screw - vite di riparazione - vis de fixation - tornillo quefija

B beschichtet - coated - rivestito - revêtu - recubierto

HC hochgekohlt - high carbon - ad alto tenore di carbonio - à haute teneur en carbone - altamente carbonizado

L legiert - alloyed - alligato/legato - allié - aleado

V ventiliert - ventilated - ventilato - ventilé - ventilado

		S	B	HC	L	V	A	B	C	D	E	F	G	H	I	OE - #	
24.0320-0115.1	520115	S	B	HC	L	V	236,0	20,0	17,0	41,0	100,0	4/6	60,0	123,0	14,0	CHEVROLET DAEWOO OPEL/VAUXHALL	90121445 90121445 5 69 054/90511111
24.0320-0123.1	520123	S	B	HC	L	V	239,0	20,0	18,0	39,0	100,0	4	65,0	123,8	13,6	AUDI/SEAT/VW AUDI/VW	321 615 301 C 321 615 301 A
24.0320-0128.1	520128	S	B	HC	L	V	256,0	20,0	18,0	38,8	100,0	4	65,0	131,5	13,8	SEAT/VW	321 615 301 D 6N0 615 301 D
24.0320-0132.1	520132	S	B			V	247,0	20,4	18,5	34,2	108,0	4	66,0	133,2	12,8	CITROEN PEUGEOT	95 661 747 4246 A7 4249 96
24.0320-0133.1	520133	S	B			V	266,0	20,5	18,5	27,6	108,0	4	66,0	133,0	13,0	CITROEN PEUGEOT	4249 F0 4246 97 4249 F0
24.0320-0142.1	520142		B	HC	L	V	257,5	20,0	18,2	40,5	98,0	4	59,0	126,7	13,0	ALFA/FIAT/LANCIA	7779409 71738145 51749124 60806137 60810076 60811256 60811266
24.0320-0146.1	520146		B			V	253,0	20,0	18,0	43,7	108,0	4	63,5	153,0	13,7	FORD	4115996 5026786
24.0320-0147.1	520147		B			V	239,5	20,0	18,0	43,0	108,0	4	63,5	136,0	13,7	FORD/MAZDA	1019604 1066271 1320581 1320582 5028281
24.0320-0154.1	520154	S	B	HC		V	298,0	20,0	17,6	61,3	120,0	5	75,0	185,0	14,5	BMW	34 21 1 164 175 34 21 6 767 060
24.0320-0173.1	520173	S	B			V	292,0	19,9	18,0	41,4	110,0	5	65,5	162,5	14,0	FIAT OPEL/VAUXHALL SAAB	46836490 71772548 5 69 114/93171778 9191336 12762291
24.0320-0175.1	520175		B			V	255,0	20,0	18,0	43,1	100,0	4	55,0	129,0	14,5	TOYOTA	43512-0D050 43512-17120 43512-17130 43512-17131 43512-52040 43512-52090
24.0320-0183.1	520183	S	B	HC		V	320,0	20,0	18,4	63,2	120,0	5	75,0	185,0	14,5	BMW	34 21 6 772 085
24.0320-0195.1	520195	S	B	HC		V	300,0	20,0	18,4	66,0	120,0	5	75,0	160,8	14,5	BMW	34 21 6 855 007
24.0320-0204.1	520204	S	B	HC		V	300,0	20,0	18,4	66,1	120,0	5	75,0	185,0	14,5	BMW	34 21 6 864 901
24.0320-0213.1	520213	S	B	HC		V	320,0	20,0	18,4	86,1	120,0	5	75,0	185,0	14,5	BMW	34 21 6 763 345
24.0320-0234.1	520234	S	B	HC		V	330,0	20,0	18,4	71,0	120,0	5	75,0	154,0	16,5	BMW	34 20 6 868 936
24.0322-0100.1	522100		B	HC		V	280,0	22,0	20,0	28,5	100,0	5	65,0	141,0	15,6	SEAT/VW	1H0 615 301 A
24.0322-0103.1	522103	S	B	HC		V	302,0	22,0	19,6	76,0	120,0	5	79,0	149,0	14,5	BMW	34 11 1 160 936
24.0322-0115.1	522115	S	B	HC		V	286,0	22,0	19,6	51,5	120,0	5	79,0	147,5	14,5	BMW	34 11 1 165 455 34 11 6 766 239 34 11 6 794 301 34 11 6 864 060
24.0322-0122.1	522122		B	HC	L	V	260,0	22,0	19,6	35,0	100,0	4	66,0	138,0	14,5	BMW	34 11 1 160 915
24.0322-0132.1	522132	S	B	HC	L	V	284,0	22,0	19,4	43,5	112,0	5	67,0	154,3	12,8	MERCEDES BENZ	202 421 09 12
24.0322-0150.1	522150	S	B	HC		V	280,0	22,0	19,0	36,7	100,0	5	65,0	133,5	15,6	AUDI/SEAT/SKODA/VW	1J0 615 301 E 1J0 615 301 M 1J0 615 301 P 1J0 615 301 D 1J0 615 301 L 6R0 615 301 8Z0 615 301 D
24.0322-0151.1	522151	S	B	HC		V	256,0	22,0	19,0	36,7	100,0	5	65,0	133,5	15,6	AUDI/SEAT/SKODA/VW	1J0 615 301 D 1J0 615 301 L 6R0 615 301 8Z0 615 301 D
24.0322-0152.1	522152		B	HC		V	280,0	22,0	20,0	46,3	112,0	5/9	68,0	146,5	15,3	AUDI/VW AUDI/VW	8E0 615 301 B 8E0 615 301 D 8E0 615 301 P
24.0322-0159.1	522159	S	B	HC		V	296,0	22,0	19,6	76,3	120,0	5	79,0	148,8	14,5	BMW	34 11 6 767 061
24.0322-0160.1	522160	S	B	HC		V	300,0	22,0	19,6	51,8	120,0	5	79,0	164,0	14,5	BMW	34 11 1 164 539 34 11 6 757 526 34 11 6 766 224 34 11 6 864 058 34 11 6 794 302
24.0322-0161.1	522161	S	B	HC	L	V	276,0	22,0	19,0	77,2	130,0	5	85,0	156,3	15,0	MERCEDES BENZ VOLKSWAGEN	902 421 06 12 902 421 07 12 902 421 09 12 2D0 615 301 C 2D0 615 301 D

Abmessungen PowerDisc

Dimensions PowerDisc - Misure PowerDisc - Dimensiones PowerDisc - Medidas PowerDisc

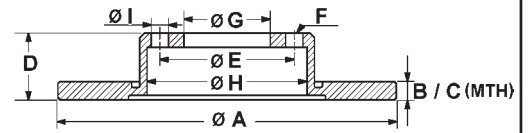

S Fixierschraube - fixing screw - vite di riparazione - vis de fixation - tornillo quejija

B beschichtet - coated - rivestito - revêtu - recubierto

HC hochgekohlt - high carbon - ad alto tenore di carbonio - à haute teneur en carbone - altamente carbonizado

L legiert - alloyed - alligato/legato - allié - aleado

V ventiliert - ventilated - ventilato - ventilé - ventilado

		S	B	HC	L	V	A	B	C	D	E	F	G	H	I	OE - #	
24.0322-0162.1	522162	S	B	HC	L	V	276,0	22,0	19,0	60,0	112,0	5	67,0	153,0	15,0	MERCEDES BENZ	638 421 01 12
24.0322-0163.1	522163	B	HC			V	256,0	22,0	20,0	36,6	100,0	5	65,0	135,0	15,6	AUDI/VW	8N0 615 601 B
24.0322-0168.1	522168	S	B	HC	L	V	260,0	22,0	19,4	40,4	112,0	5	67,0	145,0	13,3	MERCEDES BENZ	168 421 02 12 168 421 08 12
24.0322-0170.1	522170					V	257,0	22,0	20,0	34,0	104,0	4	86,0	160,5	10,6	HYUNDAI	51712-28300
24.0322-0172.1	522172		B			V	258,0	22,0	20,0	43,4	108,0	4	63,5	136,0	13,7	FORD/MAZDA	1808479 98AX-1125-B1F
24.0322-0197.1	522197		B			V	257,5	22,0	20,2	40,5	98,0	4	59,0	127,0	13,0	CITROEN	4249 74 4249 L2
																FIAT/LANCIA	46401356 46542383 46831041 51896287 51896288
																PEUGEOT	4249 73 4249 L2
24.0322-0199.1	522199		B	HC	L	V	270,0	22,0	19,4	35,5	112,0	5	67,0	145,0	13,3	MERCEDES BENZ	414 421 00 12
24.0322-0204.1	522204		B	HC		V	276,0	22,0	19,6	44,2	100,0	4	64,2	150,0	14,7	MINI	34 11 6 774 984
24.0322-0209.1	522209	S	B	HC		V	320,0	22,0	20,4	60,5	120,0	5	75,0	185,0	14,5	BMW	34 20 1 166 073
24.0322-0210.1	522210	S	B	HC		V	280,0	22,0	19,0	49,9	112,0	5/9	65,0	144,0	15,3	AUDI/SEAT/VW	1K0 615 301 AK
24.0322-0223.1	522223		B	HC		V	330,0	22,0	20,0	49,4	112,0	5	68,0	138,0	15,3	AUDI	4F0 615 601 F
24.0322-0224.1	522224	S	B	HC		V	320,0	22,0	20,4	79,7	120,0	5	75,0	185,0	16,5	BMW	34 21 3 332 217
24.0322-0231.1	522231	S	B			V	257,0	22,0	20,0	40,5	100,0	4/6	60,0	126,0	14,5	FIAT	55700920 55700921
																OPEL/VAUXHALL	5 69 024/93188917 5 69 065/9319724
24.0322-0232.1	522232	S	B	HC	L	V	276,0	22,0	19,4	44,5	112,0	5	67,0	145,0	15,3	MERCEDES BENZ	169 421 08 12
24.0322-0236.1	522236	S	B	HC		V	336,0	22,0	20,4	67,3	120,0	5	75,0	185,0	14,5	BMW	34 21 6 855 004
24.0322-0238.1	522238	S	B	HC		V	292,0	22,0	19,6	73,3	120,0	5	79,0	151,5	14,5	BMW	34 11 6 854 997
24.0322-0239.1	522239	S	B	HC		V	284,0	22,0	19,6	73,3	120,0	5	79,0	151,5	16,6	BMW	34 11 6 792 215 34 11 6 854 996
24.0322-0247.1	522247		B	HC		V	294,0	22,0	20,4	44,2	100,0	4	64,2	150,0	16,2	MINI	34 11 6 774 986 34 11 6 858 652
24.0322-0248.1	522248		B	HC		V	280,0	22,0	20,4	44,2	100,0	4	64,2	150,0	16,2	MINI	34 11 6 774 985 34 11 6 858 651
24.0323-0113.1	523113		B	HC		V	258,0	23,0	21,0	43,8	108,0	4	63,5	136,0	13,0	FORD	1523795 1535924 1546835 1679853 8V51-1125-AC 8V51-1125-AD
24.0323-0114.1	523114	S	B			V	315,0	22,9	21,5	48,0	120,0	5	67,4	172,0	16,3	CHEVROLET OPEL/VAUXHALL	13501314 5 69 062/13501303 5 69 128/13502199 13502199
24.0324-0115.1	524115	S	B	HC	L	V	256,0	24,0	21,0	41,0	100,0	4/6	60,0	123,0	14,0	DAEWOO OPEL/VAUXHALL FORD	96179110 5 69 001/90487402 4070865 5026784
24.0324-0120.1	524120		B			V	260,0	24,0	22,2	47,0	108,0	4	63,5	136,0	13,6		
24.0324-0152.1	524152	S	B	HC	L	V	256,0	23,8	21,0	41,1	100,0	4	60,0	123,0	14,3	OPEL/VAUXHALL	5 69 059/9117677
24.0324-0158.1	524158	S	B	HC	L	V	280,0	24,0	21,8	44,0	100,0	4	61,0	140,0	13,6	RENAULT	77 01 207 829 86 71 005 975
24.0324-0159.1	524159		B			V	281,0	23,9	21,5	45,7	114,3	4	69,0	146,5	12,5	MITSUBISHI VOLVO	M818027 30818027
24.0324-0161.1	524161		B			V	300,0	23,9	22,0	47,0	108,0	5	63,5	155,0	13,7	FORD	1376118 4179398 4181042
																JAGUAR	C2S 35270 C2S 42667 C2S 52091
24.0324-0166.1	524166		B	HC	L	V	260,0	24,0	21,0	41,0	100,0	4/6	60,0	126,0	14,5	OPEL/VAUXHALL	5 69 000/9196050
24.0324-0171.1	524171	S	B	HC	L	V	280,0	24,0	21,8	44,0	108,0	5	61,0	140,0	15,5	RENAULT	77 01 206 198
24.0324-0181.1	524181	S	B	HC		V	310,0	24,0	21,6	77,0	120,0	5	79,0	161,0	14,5	BMW	34 11 6 764 021
24.0324-0197.1	524197	S	B	HC		V	300,0	24,0	21,6	73,5	120,0	5	79,0	152,0	14,5	BMW	34 11 6 764 643 34 11 6 854 998
24.0324-0200.1	524200	S	B	HC		V	330,0	24,0	21,6	73,3	120,0	5	79,0	174,0	14,5	BMW	34 11 6 854 999
24.0324-0203.1	524203	S	B	HC		V	312,0	23,9	22,4	73,1	120,0	5	79,0	152,0	16,5	BMW	34 11 6 792 219 34 11 6 855 006
24.0325-0105.1	525105		B	HC		V	288,0	25,0	23,0	46,5	112,0	5/9	68,0	135,0	15,4	AUDI/SEAT/SKODA	4A0 615 301 C 4A0 615 301 D 8E0 615 301 Q
24.0325-0110.1	525110	S	B	HC	L	V	288,0	25,0	22,4	46,5	112,0	5	67,0	154,3	13,2	MERCEDES BENZ	203 421 03 12 210 421 07 12 210 421 24 12



Abmessungen PowerDisc

Dimensions PowerDisc - Misure PowerDisc - Dimensiones PowerDisc - Medidas PowerDisc

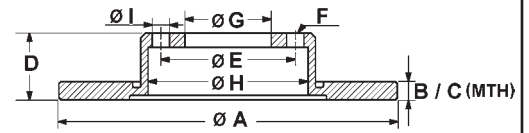

S Fixierschraube - fixing screw - vite di riparazione - vis de fixation - tornillo quefija

B beschichtet - coated - rivestito - revêtu - recubierto

HC hochgekohlt - high carbon - ad alto tenore di carbonio - à haute teneur en carbone - altamente carbonizado

L legiert - alloyed - alligato/legato - allié - aleado

V ventiliert - ventilated - ventilato - ventilé - ventilado

		S	B	HC	L	V	A	B	C	D	E	F	G	H	I	OE - #	
24.0325-0113.1	525113	S	B	HC		V	288,0	25,0	22,0	34,5	100,0	5	65,0	136,0	15,6	AUDI/SEAT/SKODA/VW	1J0 615 301 R 1J0 615 301 S 6R0 615 301 A
24.0325-0114.1	525114	S	B	HC		V	288,0	25,1	21,0	55,4	112,0	5	68,2	144,2	16,5	FORD SEAT/VW VOLKSWAGEN	1045994 7M0 615 301 G 8E0 615 301 A 8E0 615 301 C
24.0325-0115.1	525115		B	HC		V	282,5	25,0	23,0	46,5	112,0	5	68,0	135,0	15,3	FORD	1373369 1734696 AV61-1125-BB 31262718
24.0325-0117.1	525117		B	HC		V	278,0	25,0	23,0	48,5	108,0	5	63,5	140,0	13,7	VOLVO OPEL/VAUXHALL SAAB	5 69 056/90512029 5390786
24.0325-0119.1	525119	S	B	HC	L	V	288,0	25,0	22,0	42,0	110,0	5/7	70,0	139,0	14,0	AUDI/SEAT/SKODA/VW	6R0 615 301 B 8N0 615 301 A 8L0 615 301
24.0325-0123.1	525123		B	HC		V	310,0	25,0	22,0	34,5	100,0	5/9	65,0	185,0	15,6	OPEL/VAUXHALL SAAB	5 69 066/93197592 4B0 615 301 A 8E0 615 301 R
24.0325-0131.1	525131	S	B	HC	L	V	280,0	24,8	22,0	42,0	110,0	5/7	70,0	139,0	14,0	BMW	34 10 1 166 071 34 11 6 864 047
24.0325-0137.1	525137		B	HC		V	312,0	25,0	23,0	46,5	112,0	5	68,0	158,0	15,3	FIAT	51819733 71772553
24.0325-0138.1	525138	S	B	HC		V	325,0	24,9	22,5	52,6	120,0	5	79,0	174,0	14,5	OPEL/VAUXHALL SAAB	5 69 003/93171497 9156807 93171497
24.0325-0141.1	525141	S	B	HC		V	285,0	24,9	22,0	42,1	110,0	5/7	70,0	139,0	14,0	OPEL/VAUXHALL SAAB	5 69 061/9194477 5391560 9184405
24.0325-0142.1	525142	S	B	HC	L	V	308,0	25,0	22,0	42,0	110,0	5/8	70,0	139,0	14,0	AUDI/SEAT/SKODA/VW	1K0 615 301 T JZW 615 301 J
24.0325-0145.1	525145	S	B	HC		V	288,0	25,0	22,0	49,9	112,0	5/9	65,0	144,0	15,3	OPEL/VAUXHALL	5 69 006/93175376
24.0325-0148.1	525148	S	B	HC	L	V	280,0	25,0	22,0	42,0	100,0	4/6	60,0	139,0	14,5	AUDI	4F0 615 301 D
24.0325-0149.1	525149		B	HC		V	314,0	25,0	23,0	59,7	112,0	5	68,0	144,0	15,3	AUDI/VW/SKODA	1K0 615 301 AA JZW 615 301 H
24.0325-0158.1	525158	S	B	HC		V	312,0	25,0	22,0	49,9	112,0	5/9	65,0	146,0	15,3	BMW	34 11 3 400 151
24.0325-0160.1	525160	S	B	HC		V	325,0	25,0	22,6	62,2	120,0	5	75,0	174,0	16,5	FORD	1253965 1373370 1520297 1797226 DV61-1125-DA
24.0325-0162.1	525162		B	HC		V	300,0	25,0	23,0	48,5	108,0	5	63,5	140,0	13,7	VOLVO	274510 31341643 31362412 31381375 31400937 31400941
24.0325-0167.1	525167	S	B	HC	L	V	288,0	25,0	22,4	44,5	112,0	5	67,0	154,3	15,3	MERCEDES BENZ	169 421 11 12
24.0325-0171.1	525171		B	HC		V	288,0	25,0	23,0	46,5	112,0	5/10	68,0	137,0	15,3	SKODA/VW	4B0 615 301 B
24.0325-0172.1	525172		B	HC		V	312,0	25,0	23,0	46,5	112,0	5/10	68,0	140,0	15,3	SKODA/VW	4B0 615 301 C
24.0325-0179.1	525179	S	B	HC	L	V	288,0	25,0	22,4	64,5	112,0	5	67,0	154,3	15,2	MERCEDES BENZ	000 421 19 12
24.0325-0184.1	525184	S	B	HC		V	314,0	25,0	23,0	52,4	112,0	5	68,0	154,0	15,3	AUDI	8K0 615 301
24.0325-0197.1	525197		B	HC		V	320,0	25,0	23,0	48,5	108,0	5	63,5	148,0	13,7	FORD	1724956
																VOLVO	3M51-2C375-CE 31302573 31329122 31341644 31381376 31400818 31400942
24.0325-0198.1	525198	S	B	HC	L	V	280,0	25,0	22,0	43,2	100,0	4/6	60,0	139,0	14,5	OPEL/VAUXHALL	5 69 007/93181113 5 69 067/93197712
24.0325-0199.1	525199		B	HC		V	278,0	25,0	23,0	48,5	108,0	5	63,5	140,0	13,7	FORD	1790221 AV61-1125-DB
24.0326-0106.1	526106	S	B			V	283,0	26,0	24,2	28,2	108,0	4	66,0	133,5	13,0	CITROEN PEUGEOT	4246 L8 4246 R7
24.0326-0107.1	526107		B	HC		V	302,0	26,0	23,0	50,0	108,0	5	68,0	151,0	14,4	VOLVO	272276
24.0326-0115.1	526115		B	HC		V	300,0	26,0	22,0	56,0	112,0	5	68,2	144,0	16,5	FORD	1141782
24.0326-0119.1	526119		B	HC		V	313,0	25,9	22,0	56,2	112,0	5	68,2	148,0	16,5	SEAT/VW FORD SEAT/VW	7M3 615 301 A 1108038 7M3 615 301



Abmessungen PowerDisc

Dimensions PowerDisc - Misure PowerDisc -

Dimensiones PowerDisc - Medidas PowerDisc

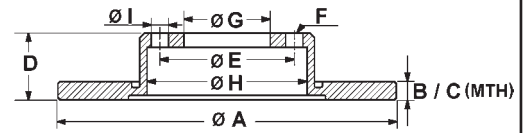

S Fixierschraube - fixing screw - vite di riparazione - vis de fixation - tornillo quefija

B beschichtet - coated - rivestito - revêtu - recubierto

HC hochgekohlt - high carbon - ad alto tenore di carbonio - à haute teneur en carbone - altamente carbonizado

L legiert - alloyed - alligato/legato - allié - aleado

V ventiliert - ventilated - ventilato - ventilé - ventilado

S B H C L V A B C D E F G H I OE - #

24.0326-0120.1	526120	S	B		V	283,0	26,0	24,0	34,2	108,0	4	66,0	133,5	13,0	CITROEN	4246 W2 4249 18 4249 84 / 4249 J6 16 064 014 80	
															PEUGEOT	4246 W8 4249 17 4249 84 / 4249 J6	
24.0326-0123.1	526123	B	HC		V	300,0	26,0	22,8	47,0	108,0	5	61,0	139,6	13,5	RENAULT	82 00 007 122 86 71 016 878	
24.0326-0165.1	526165	S	B	HC	V	276,0	26,0	23,0	45,5	105,0	5	60,0	139,0	14,2	CHEVROLET	13502045 13502824	
															OPEL/VAUXHALL	5 69 073/13502044	
24.0326-0166.1	526166	S	B	HC	V	300,0	26,0	23,0	45,5	115,0	5	70,7	149,0	14,2	CHEVROLET	13502052	
															OPEL/VAUXHALL	5 69 070/13502052 5 69 076/13502051 5 69 082/13503988	
24.0328-0106.1	528106	S	B	HC	L	V	300,0	28,0	25,4	46,5	5	67,0	154,0	13,3	MERCEDES BENZ	203 421 05 12 210 421 22 12 210 421 25 12	
24.0328-0123.1	528123	B			V	305,0	27,9	25,0	50,3	108,0	5	68,0	139,0	16,5	VOLVO	274170 / 274559 9492715	
24.0328-0129.1	528129	S	B		V	305,5	28,0	25,0	77,8	130,0	5	90,0	157,0	15,8	NISSAN	40206-00QAD	
															OPEL/VAUXHALL	44 03 038/9111038	
															RENAULT	77 00 314 064	
24.0328-0136.1	528136	B			V	285,0	28,0	26,0	43,7	98,0	5	59,0	127,0	16,5	CITROEN	4246 P2 16 063 092 80	
															FIAT/LANCIA	1325772080	
															PEUGEOT	4249 H7 16 063 092 80	
24.0328-0137.1	528137	S	B	HC	V	302,0	28,0	25,0	45,0	110,0	5/7	70,0	139,0	14,0	OPEL/VAUXHALL	5 69 004/93171500	
															SAAB	9191247 93171500	
24.0328-0142.1	528142	B	HC	L	V	312,0	28,0	25,4	64,5	112,0	5	67,0	154,0	15,3	MERCEDES BENZ	211 421 09 12	
24.0328-0154.1	528154	S	B	HC	V	300,0	28,0	26,0	52,0	108,0	5	63,5	140,0	15,8	FORD	1420601 / 1469085 1500158 / 1517696 6G91-2C375-F1B 7G91-1125-BA	
															LAND ROVER	LR000571 LR007055	
															VOLVO	30769056 / 31202331 31341382	
24.0328-0162.1	528162	S	B	HC	V	316,0	28,0	26,0	52,0	108,0	5	63,5	144,0	16,0	FORD	1434812 1434815	
															LAND ROVER	LR000470	
															VOLVO	30769061	
24.0328-0176.1	528176	B	HC	L	V	295,0	28,0	25,4	54,5	112,0	5	67,0	154,0	15,3	MERCEDES BENZ	211 421 08 12	
24.0328-0198.1	528198	S	B	HC	V	315,0	28,0	26,4	52,5	120,0	5	79,0	152,0	14,5	BMW	34 11 2 227 171	
24.0328-0199.1	528199	S	B	HC	V	315,0	28,0	26,4	52,5	120,0	5	79,0	152,0	14,5	BMW	34 11 2 227 172	
24.0328-0250.1	528250	B	HC		V	300,0	28,0	26,0	52,0	108,0	5	63,5	140,0	13,8	FORD	1500159 7G91-1125-EA	
24.0328-0254.1	528254	S	B	HC	V	328,0	28,0	26,4	73,1	120,0	5	75,0	153,8	16,5	BMW	34 10 6 787 490	
24.0330-0107.1	530107	S	B	HC	V	324,0	29,9	27,6	73,7	120,0	5	79,0	149,0	14,8	BMW	34 11 6 767 059	
24.0330-0109.1	530109	S	B	HC	V	332,0	29,9	27,6	62,1	120,0	5	75,0	158,0	16,5	BMW	34 11 6 766 036 34 11 6 859 679	
24.0330-0113.1	530113	B	HC		V	320,0	30,0	28,0	46,5	112,0	5/9	68,0	137,0	15,3	AUDI	8D0 615 301 M 8E0 615 301 AD	
24.0330-0115.1	530115	B	HC		V	345,0	30,0	27,0	49,9	112,0	5/9	65,0	140,0	15,3	AUDI/SKODAVW	1K0 615 301 M	
24.0330-0173.1	530173	S	B	HC	V	324,0	30,0	27,6	77,0	120,0	5	79,0	165,0	14,5	BMW	34 11 6 753 221	
24.0330-0175.1	530175	S	B	HC	V	321,0	30,0	28,0	59,7	112,0	5	68,0	144,8	15,3	AUDI	4F0 615 301 E	
24.0330-0176.1	530176	S	B	HC	V	347,0	30,0	28,0	59,7	112,0	5	68,0	158,0	15,3	AUDI	4F0 615 301 G	
24.0330-0193.1	530193	S	B	HC	V	320,0	30,0	28,0	52,4	112,0	5	68,0	153,4	15,3	AUDI	8K0 615 301 A	
24.0330-0207.1	530207	S	B	HC	L	V	296,0	30,0	27,0	51,0	120,0	5	67,4	163,7	16,3	CHEVROLET	13501307
															OPEL/VAUXHALL	5 69 078/13579147	
															SAAB	13502213	
24.0330-0209.1	530209	S	B	HC	V	321,0	30,0	27,0	51,0	120,0	5	67,4	160,0	16,3	CHEVROLET	13501320, 135799150	
															OPEL/VAUXHALL	5 69 083/135799150	
															SAAB	135799150	
24.0332-0101.1	532101	S	B	HC	L	V	322,0	32,0	29,4	64,5	5	67,0	154,3	15,2	MERCEDES BENZ	000 421 12 12	
24.0332-0144.1	532144	S	B	HC	L	V	330,0	32,0	29,4	64,5	5	67,0	154,0	15,0	MERCEDES BENZ	204 421 29 12 211 421 10 12 211 421 13 12 211 421 14 12	
24.0332-0158.1	532158	S	B	HC	L	V	330,0	32,0	29,4	54,5	5	67,0	156,3	15,2	MERCEDES BENZ	164 421 04 12 164 421 13 12	



Ⓛ Armaturen

Ⓛ Fittings

Ⓛ Composants et accessoires

Ⓛ Assesorios

Armaturen

Fittings - Attrezzature - Composants et accessoires - Accesorios

Gewindedarstellung und Dichtflächen-Anordnung bei Innengewinden der Anschlußarmaturen

Representation of threads and sealing surface arrangement in case of internal-threads

Rappresentazione della filattatura e disposizione delle superfici di tenuta nella filettatura interna dei pezzi di attacco

Présentation de filet et arrangement de face d'étanchéité en case de filetage intérieure des armatures

Ilustración de roscas y disposición de superficies de contacto en roscas interiores de los accesorios de conexión

Abdichtung durch Bördel nach DIN 74234
Sealing by flaring according to DIN 74234 tenuta
Stagna tramite flangiatura DIN 74234
Etanchement par colet selon DIN 74234
Junta mediante reborde según DIN 74234

Abdichtung mit Dichtring nach DIN 7603
Sealing by seal ring according to DIN 7603
Tenuta stagna tramite guarnizione DIN 7603
Etanchement par joint selon DIN 7603
Junta con retén según DIN 7603

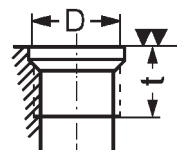
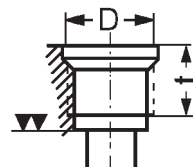
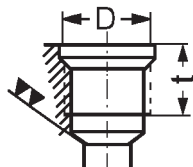
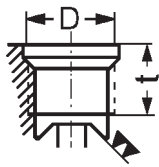

Gewinde Ausführung

Thread design
Esecuzione filettata
Exécution filet
Ejecución de rosca

A 1

A 2

A 3

A 4

Bördel

Flare
Bordatura tipo
Colet
Reborde

E

F

-

-

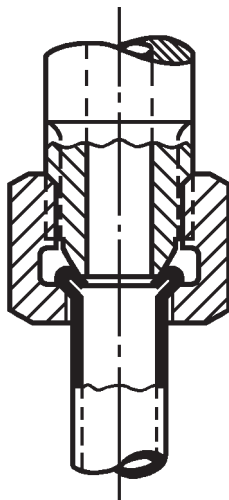

DIN 74233

Überwurfschraube
Union screw
Viti con risvolto
Vis chapeau
Tornillos de racor

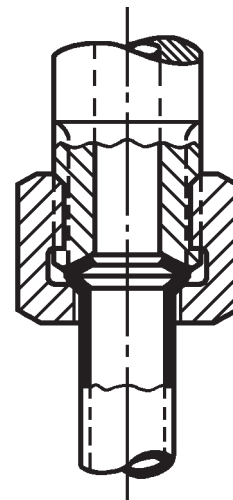

DIN 74234





E

F

Bördel
Flare
Bordatura tipo
Colet
Reborde

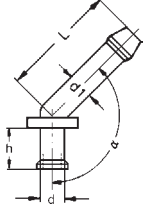

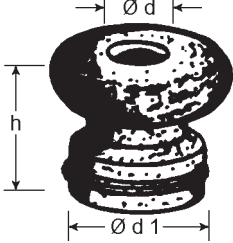
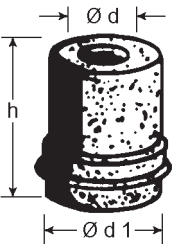
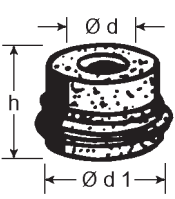
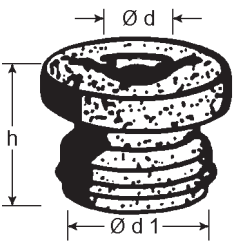
Armaturen

Fittings - Attrezzature - Composants et accessoires - Accesorios

Kniestücke Elbows Raccordi a gomito Raccord en équerre Piezas acodadas	Abmessungen - Dimensions - Dimensioni - Dimensions - Medidas [mm]					
	$\varnothing d$	$\varnothing d_1$	h	L	α	
	8,0	8,0	11,0	32,0	95°	03.3390-0055.1 390149
	8,0	8,0	11,0	32,0	105°	03.3390-0065.1 390150
	12,8	8,0	13,0	32,0	135°	03.3390-0130.1 390153
	12,8	8,0	13,0	32,0	105°	03.3390-0139.1 390154
Behälterstopfen Reservoir seal Tappi per serbatoio Bouchon de réservoir Tapones de depósitos	Abmessungen - Dimensions - Dimensioni - Dimensions - Medidas [mm]					
	$\varnothing d$	$\varnothing d_1$	h			
	4,2	17,0	18,0	Kautschuk	①	03.3304-0600.1 390081
	6,5	17,0	18,0	Kautschuk	①	03.3304-0700.1 390082
	6,5	17,0	10,5	Kautschuk	①	03.3304-1100.1 390084
	6,5	17,0	10,4	EPDM		03.3304-1102.1 390085
	7,3	17,0	13,5	Kautschuk	①	03.3304-1000.1 390083
	7,3	22,0	13,0			03.3304-1400.1 390088
	12,3	22,0	13,0	EPDM		03.3304-2208.1 390090
	① Kautschuk India rubber Caucciù Caoutchouc Caucho					
Behälterschlauch Reservoir tube Flessibile per serbatoio Flexible réservoir Manguera del depósito	Abmessungen - Dimensions - Dimensioni - Dimensions - Medidas					
	$\varnothing D$ [mm]	$\varnothing d$ [mm]	L [m]			
	13,5	7,5	5,0	03.3538-0005.1 390414		
	13,5	7,5	20,0	03.3538-0020.1 390415		



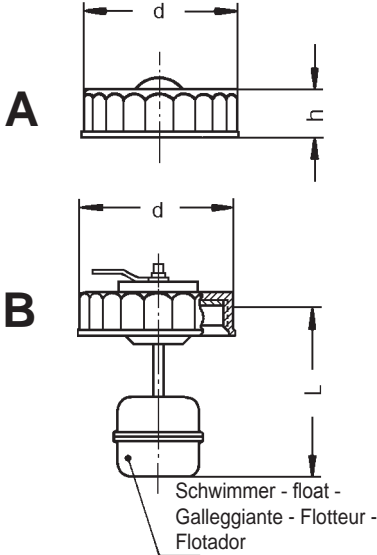

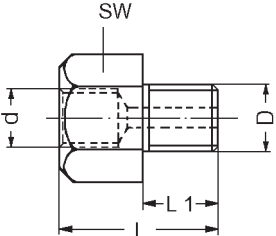
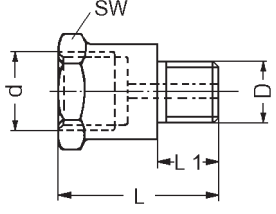
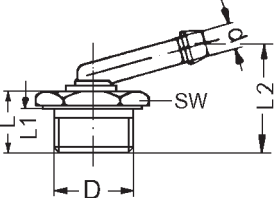
Armaturen

Fittings - Attrezzature - Composants et accessoires - Accesorios

Behälter Verschraubung Reservoir screw fitting Tappi filettato per serbatoio Couvercle de réservoir Fijación de depósito	Abmessungen - Dimensions - Dimensioni - Dimensions - Medidas [mm]										
	Ausführung - Design - Esecuzione - Exécution - Ejecución	d	h	L							
	A	max. 51	14,0		03.3556-1065.2 390425						
		max. 51	14,0		03.3556-1141.2 390434						
		max. 51	14,5		03.3556-1147.2 390435 M						
		max. 51	14,0		03.3556-1164.2 390437						
	B	max. 51		45,5	03.3556-1094.2 390427						
		max. 51		51,2	03.3556-1113.2 390428						
		max. 51		83,0	03.3556-1115.2 390431						
		max. 51		54,0	03.3556-1124.2 390433						
		max. 51		40,5	03.3556-1199.2 390440						
	M nur für Mineralöl only for mineral oil solo per olio minerale seulement pour huile minérale sólo para aceite mineral										
Schraubstutzen Screw adapters Raccordi filettati Raccord fileté Racores	Abmessungen - Dimensions - Dimensioni - Dimensions - Medidas [mm]										
	D	d	Gewinde Ausführung - Thread design - Esecuzione filettata - Exécution filet - Ejecución de rosca	L	L₁	L₂	SW				
	M 10 x 1	M 10 x 1	A 2	21,0	8,0		17	03.3510-0100.1 390271			
		M 12 x 1	A 1	24,0	8,0		17	03.3510-0300.1 390273			
	M 12 x 1	M 10 x 1	A 2	20,5	8,0		17	03.3510-0054.1 390269 ①			
		M 12 x 1	A 1	22,0	8,0		17	03.3510-0059.1 390270			
	M 14 x 1,5	M 10 x 1	A 2	26,0	14,0		19	03.3510-4100.1 390279			
		M 12 x 1	A 2	27,0	12,0		19	03.3510-0800.1 390275			
① mit Drosselbohrung with throttle hole con foro calibrato di strozzamento avec d'étranglement con taladro estrangulador											
	M 10 x 1	M 10 x 1	A 2	32,0	8,0		17	03.3510-0200.1 390272			
	M 22 x 1,5	Ø 10		16,5	12,0	30,0	27	03.3510-0026.2 390266			

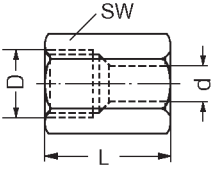
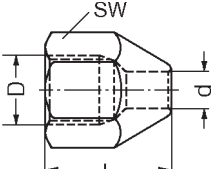

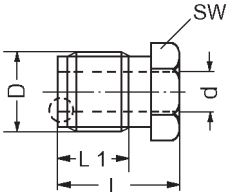
Armaturen

Fittings - Attrezzature - Composants et accessoires - Accesorios

Überwurfmutter Union nuts Dadi con risvolto Écrou-chapeau Tuerca de racor	Abmessungen - Dimensions - Dimensioni - Dimensions - Medidas [mm]							
	D	d	L	L ₁	für Bördel - for flare - bordatura tipo - pour colet - para reborde	SW		
	M 10 x 1	5,2	14,0		E	14	24.3516-0110.1	390549 ①
	<p>① In Sortimentbox 24.3516-0210.2 390553 enthalten. Included in collection 24.3516-0210.2 390553. Contenuto nella scatola di assortimento 24.3516-0210.2 390553. Incluse dans collection 24.3516-0210.2 390553. Se incluye en caja de surtido 24.3516-0210.2 390553.</p>							
	3/8" -24 UNF-2B	5,2	17,5		E	14	24.3516-0111.1	390550 ①
	<p>① In Sortimentbox 24.3516-0210.2 390553 enthalten. Included in collection 24.3516-0210.2 390553. Contenuto nella scatola di assortimento 24.3516-0210.2 390553. Incluse dans collection 24.3516-0210.2 390553. Se incluye en caja de surtido 24.3516-0210.2 390553.</p>							
Überwurfschrauben Union screws Viti con risvolto Vis chapeau Tornillos de racor	Abmessungen - Dimensions - Dimensioni - Dimensions - Medidas [mm]							
	D	d	L	L ₁	für Bördel - for flare - bordatura tipo - pour colet - para reborde	SW		
  E  F	M 10 x 1	4,75	17,0	11,0	E	10	03.3516-2300.1	390317
		5,2	16,7	9,0	E	10	24.3516-0020.1	390541 ②
		5,0	16,5	10,5	F	11	03.3516-3500.1	390318
		5,0	16,5	9,4	F	11	03.3516-0602.1	390412
		5,0	16,0	10,0	E	11	03.3516-0800.1	390313
		5,2	24,8	15,0	F	11	24.3516-0070.1	390546 ②
	M 10 x 1,25	5,2	19,5	12,0	F	10	24.3516-0050.1	390544 ②
		5,2	14,2	9,5	E	10	24.3516-0060.1	390545 ②
	M 12 x 1	6,2	18,0	10,5	E	12	24.3516-0080.1	390547
		5,2	20,0	12,5	F	12	24.3516-0090.1	390548
	3/8" -24 UNF-2A	5,2	18,0	11,0	E	10	24.3516-0040.1	390543 ②
		5,2	21,0	16,0	F	11	24.3516-0030.1	390542 ②
	<p>② In Sortimentbox 24.3516-0210.2 390553 enthalten. Included in collection 24.3516-0210.2 390553. Contenuto nella scatola di assortimento 24.3516-0210.2 390553. Incluse dans collection 24.3516-0210.2 390553. Se incluye en caja de surtido 24.3516-0210.2 390553.</p>							

Armaturen

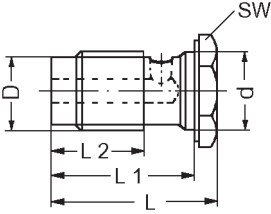
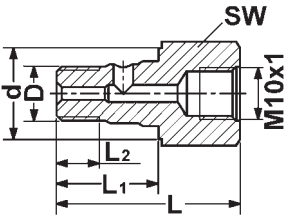
Fittings - Attrezzature - Composants et accessoires - Accesorios

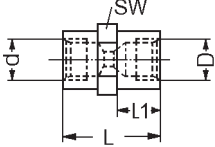
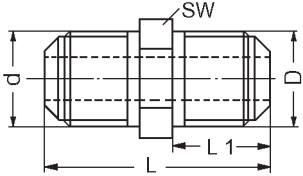
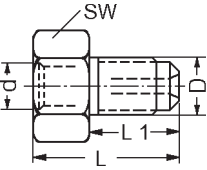
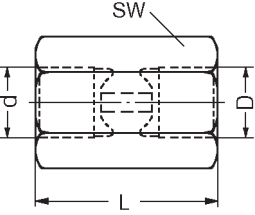
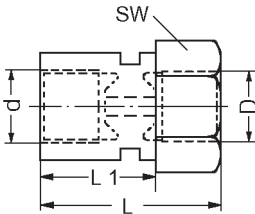
Hohlschrauben Hollow screws Viti cave Vis creuse Tornillos huecos	Abmessungen - Dimensions - Dimensioni - Dimensions - Medidas [mm]								
	D	d	L	L ₁	L ₂	SW			
	M 10 x 1	12,1	24,5	19,5	8,5	17	03.3520-0302.1	390381	
		12,1	30,0	24,5	12,0	17	03.3520-0501.1	390382	
	M 12 x 1	14,1	28,0	22,5	10,0	17	03.3520-1003.1	390418	
	M 14 x 1,5	14,1	33,5	27,5	15,0	17	03.3520-2900.1	390390	
	M 10 x 1	12,1	34,0	19,0	8,0	17	03.3520-0600.1	390383	
Zwischenstücke Pipe adapters Raccordi intermedi Raccord intermédiaire Piezas intercaladas	Abmessungen - Dimensions - Dimensioni - Dimensions - Medidas [mm]								
	D	Gewinde Ausführung - Thread design - Esecuzione Filettata - Exécution filet - Ejecución de rosca	d	Gewinde Ausführung - Thread design - Esecuzione Filettata - Exécution filet - Ejecución de rosca	L	L ₁			SW
	M 10 x 1	A 2	M 10 x 1	A 2	24,0	8,5	14	03.3511-0800.1	390285 ^①
^① In Sortimentbox 24.3516-0210.2 390553 enthalten. Included in collection 24.3516-0210.2 390553 . Contenuto nella scatola di assortimento 24.3516-0210.2 390553 . Include dans collection 24.3516-0210.2 390553 . Se incluye en caja de surtido 24.3516-0210.2 390553 .									
	M 12 x 1		M 12 x 1		35,0	15,0	12	03.3511-3800.1	390291
	M 12 x 1		M 10 x 1	A 2	28,0	15,3	17	03.3511-5200.1	390292
	M 12 x 1	A 1	M 12 x 1	A 1	29,0	-	17	03.3511-1000.1	390286
	M 12 x 1	A 1	M 12 x 1	A 1	29,0	19,0	19	03.3511-1100.1	390287

Armaturen

Fittings - Attrezzature - Composants et accessoires - Accesorios

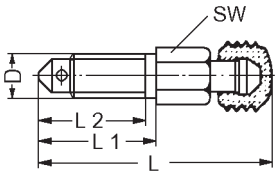
Entlüfterventil Bleeder valve Valvola di spurgo Vis de purge Válvula de ventilador	Abmessungen - Dimensions - Dimensioni - Dimensions - Medidas [mm]					
	D	L	L ₁	L ₂	SW	
 <p>Bestell-Nr. Staubkappe Part No. dust cap Codici ordinazione del parapolvere Référence capuchon de protection Referencia guardapolvo</p> <p>03.3590-0700.1 390456 03.3590-0701.1 390457 M</p>	M 6	31,5	16,0	12,0	7	03.3518-0100.2 390329
		31,5	16,0	12,0	7	03.3518-0102.2 390330 M
		41,0	22,0	12,0	7	03.3518-0200.2 390332
		29,0	13,5	12,0	7	03.3518-0300.2 390333
		29,0	13,5	12,0	7	03.3518-0302.2 390334 M
	M 7	33,0	16,5	15,0	7	03.3518-4200.2 390357
		41,0	22,0	15,5	7	03.3518-5900.2 390363
		22,5	12,5	11,0	7	03.3518-6800.2 390369 ①
		29,5	12,5	11,0	7	03.3518-6901.2 390370
	M 8	35,0	18,5	17,0	9	03.3518-0500.2 390337
		35,0	18,5	17,0	9	03.3518-0502.2 390339 M
		44,0	22,0	20,0	9	03.3518-0600.2 390340
		49,0	32,0	20,0	9	03.3518-0700.2 390342
		59,0	42,0	20,0	9	03.3518-0800.2 390343
		52,0	32,0	20,0	9	03.3518-6100.2 390364
		90,0	35,0	18,0	9	03.3518-8000.2 390373
	M 10 x 1	32,0	16,0	13,0	11	03.3518-0900.2 390345
		32,0	16,0	13,0	11	03.3518-0902.2 390346 M
		38,0	21,0	18,0	11	03.3518-1900.2 390354
		32,0	16,0	13,0	10	03.3518-5200.2 390358
M 12 x 1	31,5	15,5	13,0	12	03.3518-1501.2 390349 ②	
M 12 x 1,5	43,0	26,0	24,0	14	03.3518-1300.2 390347	
7/16"-20 UNF-2A	40,0	23,0	21,0	11	03.3518-1700.2 390352	

M nur für Mineralöl
only for mineral oil
solo per olio minerale
seulement pour huile minérale
sólo para aceite mineral

① mit Staubkappe **03.3590-0044.1 390455**
with dust cap **03.3590-0044.1 390455**
con parapolvere **03.3590-0044.1 390455**
avec capuchon de protection **03.3590-0044.1 390455**
con guardapolvo **03.3590-0044.1 390455**

② mit 60° Innenkegel
with 60° internal cone
con cono interno 60°
avec cône intérieur 60°
con cono interior 60°

Staubkappen
dust caps
parapolvere
capuchon de protection
guardapolvo

03.3590-0700.1 390456

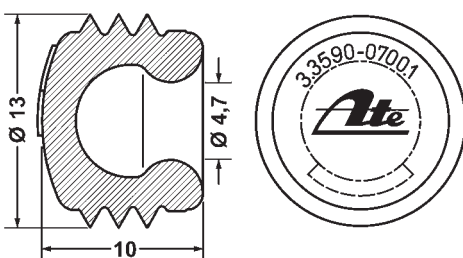

03.3590-0701.1 390457

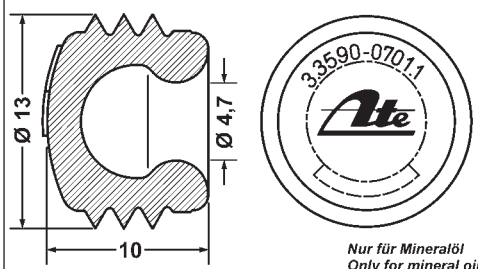

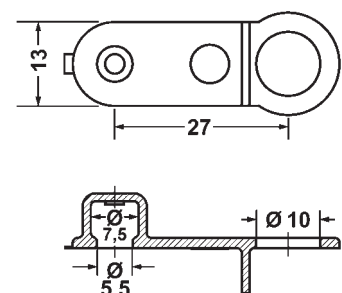

13.8190-0296.1 390409

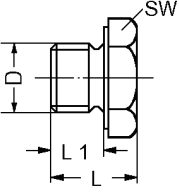
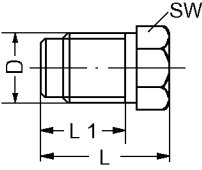

Armaturen

Fittings - Attrezzature - Composants et accessoires - Accesorios

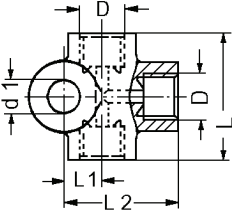
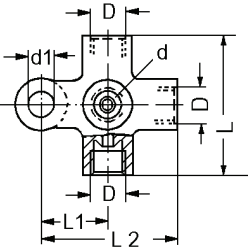
Verschlußstopfen Plugs Tappi Obturbateur Tapón de cierre	Abmessungen - Dimensions - Dimensioni - Dimensions - Medidas [mm]									
	D	d	L	L ₁	für Bördel - for flare - bordatura tipo - pour colet - para reborde	SW				
	M 10 x 1		12,5	7,5		14	03.3517-0100.1	390321		
	M 10 x 1		12,5	7,5		14	03.3517-0101.2	390322 ①		
① mit Dichtring (CU) with sealing ring (CU) avec joint d'étanchéité (CU) con anello di tenuta (CU) con junta (CU)										
	M 10 x 1		18,0	11,5	E + F	10	03.3517-5100.1	390326		
	M 12 x 1		20,0	13,0	E	12	03.3517-0300.1	390323		
Verteiler distributors ripartitore distributeur distribuidor	Abmessungen - Dimensions - Dimensioni - Dimensions - Medidas [mm]									
	D	Gewinde Ausführung - Thread design - Esecuzione Filettata - Exécution filet - Ejecución de rosca	d	Gewinde Ausführung - Thread design - Esecuzione Filettata - Exécution filet - Ejecución de rosca	L	L ₁	L ₂			d ₁
3 Anschlüsse - 3 Connections - 3 Attacchi - 3 Raccords - 3 Conexiones	M 10 x 1	A 2			30,0	8,0	23,0	7,1	03.3513-0200.1	390297
	M 10 x 1	A 2			30,0	8,0	23,0	8,4	03.3513-1000.1	390299
	M 10 x 1	A 1			36,0	9,0	27,0	8,4	03.3513-2700.1	390300
	M 12 x 1	A 1			36,0	10,0	31,5	8,3	03.3513-0300.1	390298
										
	4 Anschlüsse - 4 Connections - 4 Attacchi - 4 Raccords - 4 Conexiones	M 10 x 1	A 2	M 10 x 1	A 2	32,0	17,0	33,0	8,4	03.3514-2600.1
M 10 x 1		A 2	M 10 x 1 ①	A 2	32,0	17,0	33,0	8,4	03.3514-2600.2	390307
										
	① mit Entlüfterventil with bleeder valve con valvola di spurgo avec vis de purge con válvula de ventilador									

Armaturen

Fittings - Attrezzature - Composants et accessoires - Accesorios

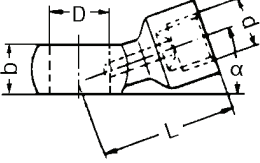
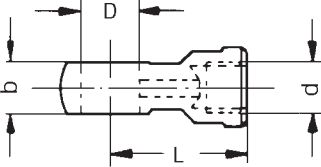
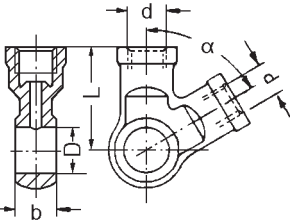
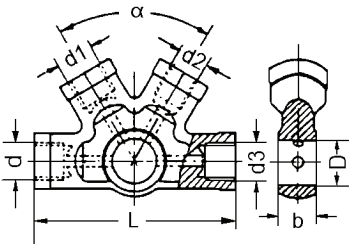
Ringstutzen Banjo fittings Raccordi anulari Manchon à oeillet Racores anulares	Abmessungen - Dimensions - Dimensioni - Dimensions - Medidas [mm]							
	D	d	Gewinde Ausführung - Thread design - Esecuzione filettata - Exécution filet - Ejecución de rosca	L	b	α		
1 Anschluss - 1 Connection - 1 Attaccho - 1 Raccord - 1 Conexión 	12,0	M 10 x 1	A 2	27,0	10,0	20°	03.3521-0100.1	390392
		M 10 x 1	A 2	30,0	10,0	30°	03.3521-0400.1	390394
	14,0	M 10 x 1	A 2	32,0	12,0	20°	03.3521-0800.1	390398
		M 12 x 1	A 1	32,0	12,0	20°	03.3521-0600.1	390395
1 Anschluss - 1 Connection - 1 Attaccho - 1 Raccord - 1 Conexión 	12,0	M 10 x 1	A 2	26,0	10,0		03.3521-0200.1	390393 ①
	① für Bremslichtschalter mit konischem Gewinde for stop-light switch with conical thread per interruttore luce di arresto con filettatura conica pour contacteur de stop avec filetage conique para interruptor de luz de freno con rosca cónica							
2 Anschlüsse - 2 Connections - 2 Attacchi - 2 Raccords - 2 Conexiones 	12,0	M 10 x 1	A 2	20,5	15,5	34°	03.3522-0200.1	390402
		M 12 x 1	A 1	32,0	12,0	60°	03.3522-0500.1	390403
	14,0	M 12 x 1	A 1	32,0	12,0	60°	03.3522-1100.1	390404
		M 10 x 1 ②	A 4					
② für Bremslichtschalter for stop-light switch per interruttore luce di arresto pour contacteur de stop para interruptor de luz de freno								
4 Anschlüsse - 4 Connections - 4 Attacchi - 4 Raccords - 4 Conexiones 	14,0	M 10 x 1	A 2	64,0	12,0	60°	03.3524-0300.1	390407



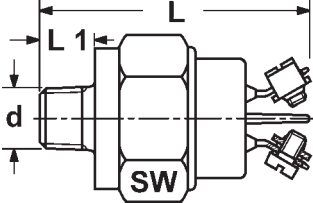
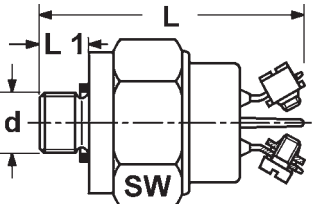
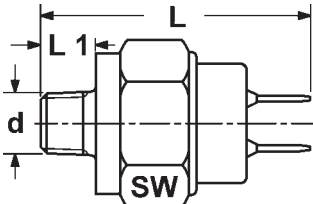
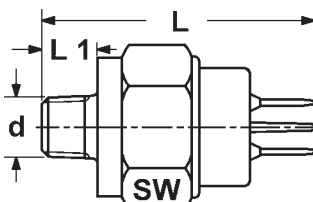
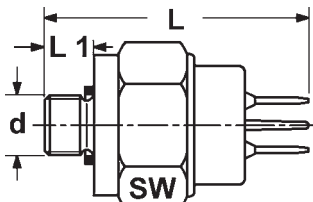
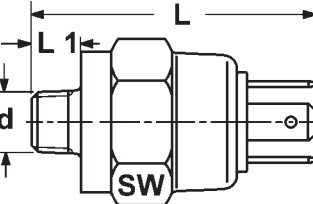

Armaturen

Fittings - Attrezzature - Composants et accessoires - Accesorios

Bremslichtschalter Stop-light switch Interruttore luce di arresto Contacteur de stop Interruptor de luz de freno	Abmessungen - Dimensions - Dimensioni - Dimensions - Medidas [mm]						
	Ausführung - Design - Esecuzione - Exécution - Ejecución	d	L	L ₁	L ₂		SW
	Klemm-Anschluß Clamp connection Collegamento a morsetto	M 10 x 1	46,0	9,0		24	24.3526-0100.3 340017
	Borne de serrage Conexión por fijación	M 10 x 1	46,0	9,0		24	24.3526-0600.3 340027 M
	Klemm-Anschluß Clamp connection Collegamento a morsetto	M 10 x 1	46,0	8,0		24	24.3526-0110.3 340018
	Borne de serrage Conexión por fijación	M 10 x 1	46,0	8,0		24	24.3526-0610.3 340030 M
	Steck-Anschluß Plug connection Attacco a spina Contact à fiches Enchufe de conexión	M 10 x 1	42,0	9,0		22	03.3526-2002.3 340010
	Steck-Anschluß Plug connection Attacco a spina Contact à fiches Enchufe de conexión	M 10 x 1	46,0	9,0		24	24.3526-0800.3 340033
	Steck-Anschluß Plug connection Attacco a spina Contact à fiches Enchufe de conexión	M 10 x 1	46,0	8,0		24	24.3526-0810.3 340037
	Steck-Anschluß Plug connection Attacco a spina Contact à fiches Enchufe de conexión	M 10 x 1	48,0	9,0		24	24.3526-1900.0 340038
		M 10 x 1	48,0	9,0		24	24.3526-2200.0 340039 M
M nur für Mineralöl - only for mineral oil - solo per olio minerale seulement pour huile minérale - sólo para aceite mineral							

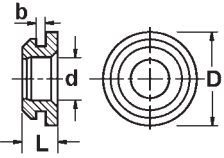
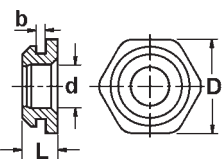

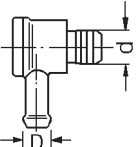
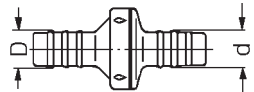

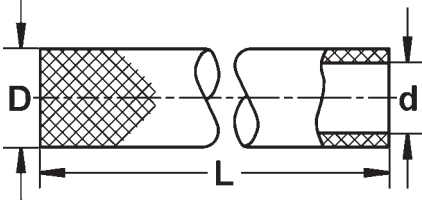



Armaturen

Fittings - Attrezzature - Composants et accessoires - Accesorios

Dichtung für Vakuum-Anschlußstück Hexagon for vacuum connection Guarnizione per pezzo di raccordo per depressione Hexagone pour raccord à dépression Retén para terminal de empalme al vacío	Abmessungen - Dimensions - Dimensioni - Dimensions - Medidas [mm]				
	L	b	D	d	
	9,5	1,5	28,0	13,0	03.7718-7203.1 390360
	9,5	2,5	28,0	13,0	03.7718-7202.1 390378
Vakuum-Rückschlagventil Vacuum check valve Valvola di non ritorno per depressione Soupape à dépression Válvula de retención al vacío	Abmessungen - Dimensions - Dimensioni - Dimensions - Medidas [mm]				
	L	b	D	d	
			12,4	16,5	03.6118-7305.2 990032
			10,5	16,5	03.6718-9931.2 990002
			11,8	11,8	24.7718-7301.2 990024
			13,0	13,0	03.6118-7307.2 990033
Vakuumschlauch Vacuum tube Tubazione di pressione Tuyauterie de pression Tubería de presión	Abmessungen - Dimensions - Dimensioni - Dimensions - Medidas				
	Ø D [mm]	Ø d [mm]	L [m]		
	19,0	12,0	1,0	03.9305-1059.1 730083	

Armaturen

Fittings - Attrezzature - Composants et accessoires - Accesorios

<p>Prüfanschlüsse Testing connectors attacchi di prova connexion d'essai conexiones de ensayo</p>	<p>Für den festen Einbau in die Bremsanlage (z.B. anstelle eines Verteilerstückes). Druckprüfgeräte können hier direkt über die Anschlußschlauchleitung verbunden werden, ohne die Bremsanlage nachträglich zu entlüften. For permanent installation in the braking system (e.g. in the place of a distributor piece). The pressure testing units can be connected here directly to the connection hose line without having to bleed the braking system afterwards. Per montaggio fisso nell'impianto di frenatura (p.e. al posto di un ripartitore a più vie). Apparecchi prova pressione possono essere collegati direttamente tramite il tubo di collegamento, senza dover spurgare l'impianto freni a posteriori. Pour installation permanente dans le système de freinage (par ex: à la place d'une pièce de distribution). Les appareils de vérification de la pression peuvent être directement reliés à la connexion. Le système de freinage n'a pas besoin d'être purgé par la suite. Para el montaje fijo en la instalación de frenos (p. ej. en lugar de un distribuidor). Los controladores de presión no pueden unirse aquí directamente a través de la línea de conexión sin tener que airear posteriormente la instalación de frenos.</p>			
	 03.9305-0501.3 390481	 03.9305-0510.3 390483	 03.9305-0520.3 390485	 03.9305-0530.3 390486
<p>Anzahl der Befestigungslaschen Number of mounting links Numero delle fascette Nombre de trous de fixation Número de las bridas de fijación</p>	1	1	2	2
<p>Anzahl der Anschlüsse Number of connections Numero di attacchi Nombre de raccordement Número de conexiones</p>	2	3	2	2
<p>Gewinde Ausführung Thread design Esecuzione filettata Exécution filet Ejecución de rosca</p>	M 12 x 1 A1	M 12 x 1 A1	M 10 x 1 A2	M 12 x 1 A1
<p>Richtung des Prüfanschlusses zur Befestigungslasche Direction of the testing connector to the mounting link Direzione del raccordo di prova alla fascetta di fissaggio Nens du raccord d'essai par rapport aux trous de fixation Dirección de la conexión de ensayo a la brida de fijación</p>	horizontal orizzontale	vertical verticale	vertical verticale	vertical verticale
	 03.9305-0570.3 390488	 03.9305-0590.3 390489	 03.9305-0700.3 390491	
<p>Anzahl der Befestigungslaschen Number of mounting links Numero delle fascette Nombre de trous de fixation Número de las bridas de fijación</p>	1	1	-	
<p>Anzahl der Anschlüsse Number of connections Numero di attacchi Nombre de raccordement Número de conexiones</p>	3	3	1	
<p>Gewinde Ausführung Thread design Esecuzione filettata Exécution filet Ejecución de rosca</p>	M 12 x 1 A1	M 10 x 1 A2	M 10 x 1	
<p>Richtung des Prüfanschlusses zur Befestigungslasche Direction of the testing connector to the mounting link Direzione del raccordo di prova alla fascetta di fissaggio Nens du raccord d'essai par rapport aux trous de fixation Dirección de la conexión de ensayo a la brida de fijación</p>	vertical verticale	horizontal orizzontale	-	
<p>Prüfanschlüsse - Einzelteile Testing connectors - individual parts Attacchi di prova - pezzi singoli Connexion d'essai - pièces détachées Piezas sueltas - conexión de ensayo</p>	<p>03.9305-0502.0 390482</p> <p>Verbindungskette Connecting chain catena di collegamento chaîne de raccordement cadena de unión</p>		<p>03.3501-0021.1 390242</p> <p>Gummichtung in der Verschlusskappe Rubber seal in the sealing cap guarnizione in gomma nella calotta joint dans le capuchon junta de goma en la tapa de cierre</p>	

Armaturen

Fittings - Attrezzature - Composants et accessoires - Accesorios

Sortimente
Assortments
Assortimenti
Assortiments
Surtidos

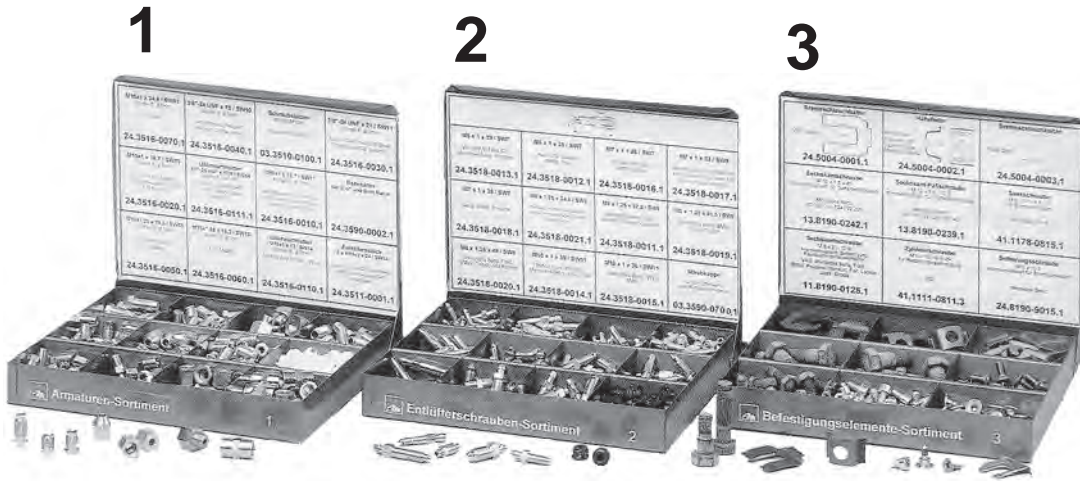

<p>① M10x1 x 24,8 / SW11 Bördel F, Ø5mm ● 24.3516-0070.1 390546</p>	<p>① 3/8"-24 UNF x 18/SW10 Bördel E, Ø5mm ● 24.3516-0040.1 390543</p>	<p>② Schraubstutzen M10x1/M10x1 ■ 03.3510-0100.1 390271</p>	<p>① 3/8"-24 UNF x 21/SW11 Bördel F, Ø5mm ● 24.3516-0030.1 390542</p>	<p>1 24.3516-0210.2 390553 Armaturen Sortiment Fittings collection Serie di accessori Armatures collection Surtido de accesorios</p>
<p>① M10x1 x 16,7 / SW10 Bördel E, Ø5mm ● 24.3516-0020.1 390541</p>	<p>③ Überwurfmutter 3/8"-24UNFx17,5/SW11/E, Ø5mm ● 24.3516-0111.1 390550</p>	<p>① M10x1 x 16,7 / SW11 Bördel F, Ø5mm ● 24.3516-0010.1 390540</p>	<p>Rohrhalter ④ für 3/16" und 5mm ● 24.3590-0002.1 390567</p>	
<p>① M10x1,25 x 10,5 / SW10 Bördel F, Ø5mm ● 24.3516-0050.1 390544</p>	<p>① M10x1,25 x 14,2 / SW10 Bördel E, Ø5mm ● 24.3516-0060.1 390545</p>	<p>③ Überwurfmutter M10x1 x 13 / SW14 / E, Ø5mm ● 24.3516-0110.1 390549</p>	<p>⑤ Zwischenstück 2 x M10x1 x 24 SW14 ● 03.3511-0800.1 390285</p>	
<p>M6 x 1 x 29 SW7 ● 24.3518-0013.1 390558</p>	<p>M6 x 1 x 38 SW7 ● 24.3518-0012.1 390557</p>	<p>M7 x 1 x 26 SW7 ● 24.3518-0016.1 390561</p>	<p>M7 x 1 x 33 SW9 ● 24.3518-0017.1 390562</p>	<p>2 24.3516-0220.2 390554 Entlüfterschrauben Sortiment Bleeder valve collection Viti di spurgo assortimento Vis de purge collection Surtido de tornillos de ventilador</p>
<p>M7 x 1 x 38 SW7 ● 24.3518-0018.1 390563</p>	<p>M8 x 1,25 x 24,5 SW8 ● 24.3518-0021.1 390566</p>	<p>M8 x 1,25 x 32,5 SW9 ● 24.3518-0011.1 390556</p>	<p>M8 x 1,25 x 41,5 SW9 ● 24.3518-0019.1 390564</p>	
<p>M8 x 1,25 x 49 SW9 ● 24.3518-0020.1 390565</p>	<p>M10 x 1 x 30 SW11 ● 24.3518-0014.1 390559</p>	<p>M10 x 1 x 36 SW11 ● 24.3518-0015.1 390560</p>	<p>⑥ Staubkappe ■ 03.3590-0700.1 390456</p>	
<p>⑦ Bremschlauchhalter ● 24.5004-0001.1 390568</p>	<p>⑧ Haltefeder ● 24.5004-0002.1 390569</p>	<p>⑦ Bremschlauchhalter ● 24.5004-0003.1 390570</p>	<p>3 24.3516-0230.2 390555 Befestigungselemente Sortiment Fittings Collection Pezzi di fissaggio assortimento Fixation collection Surtido de elementos de fijación</p>	
<p>⑨ Sechskantschraube M12 x 1,5 x 45 ■ 13.8190-0242.1 990124</p>	<p>⑩ Sechskant-Paßschraube M12 x 1,5 - 10.9 ■ 13.8190-0239.1 990122</p>	<p>⑪ Senkschraube M6 x 14 -4.8 - H ● 41.1178-0815.1 990137</p>		
<p>⑨ Sechskantschraube M8 x 21 - 10.9 ● 11.8190-0125.1 990054</p>	<p>⑫ Zylinderschraube M6 x 10 -8.8 ● 41.1111-0811.3 990136</p>	<p>⑬ Sicherungsschraube M6 x 15,5 ● 24.8190-9015.1 990133</p>		
<p>① Bördel Flare</p>	<p>② Schraubstutzen Screw adapters</p>	<p>③ Überwurfmutter Union nut</p>	<p>④ Rohrhalter für 3/16" und 5mm Pipe holder</p>	<p>Reborde Racores</p>
<p>⑤ Zwischenstück pipe adapter</p>	<p>⑥ Staubkappe Dust cap</p>	<p>⑦ Bremschlauchhalter Hose spring-clamp</p>	<p>⑧ Haltefeder Fixation spring</p>	<p>Tuerca de racor Soporte de tubo para 3/16" y 5mm</p>
<p>⑨ Sechskantschraube Hexagon screw</p>	<p>⑩ Sechskant-Paßschraube Hexagone-fitting screw</p>	<p>⑪ Senkschraube Boulon hexagonal</p>	<p>⑫ Zylinderschraube Cylinder screw</p>	<p>Piezas intercaladas Guardapolvo Soporte manguera de freno</p>
<p>⑬ Sicherungsschraube Locking screw</p>	<p>⑭ Nachfüllbeutel 10 Stück Refillbag with 10 pieces</p>	<p>⑮ Einzelteil Single part</p>	<p>⑯ Sicherungsschraube Locking screw</p>	<p>Resorte de retención Resorte de retención Resorte de retención Tornillo hexagonal Tornillo calibrado hexagonal Tornillo cilíndrico Tornillo de seguridad</p>
<p>● Nachfüllbeutel 10 Stück Refillbag with 10 pieces</p>	<p>● Einzelteil Single part</p>	<p>● Nachfüllbeutel 10 Stück Sacchetto di riassortimento 10 pezzi</p>	<p>● Einzelteil Pièces dé tachées</p>	<p>● Nachfüllbeutel 10 Stück Sac de remplissage à 10 pièces</p>
<p>● Einzelteil Single part</p>	<p>● Einzelteil Single part</p>	<p>● Einzelteil Pezzo singolo</p>	<p>● Einzelteil Pièces dé tachées</p>	<p>● Einzelteil Pieza suelta</p>





- ⓓ **Bremsgeräte komplett**
- Ⓔ**N** **Booster units complete**
- Ⓕ**R** **Servo-freins complets**
- Ⓔ**S** **Servofreno completo**

Bremsgeräte komplett

Booster units complete - Servofreni completi -
Servo-freins complets - Servofreno completo

● Die Nr. befindet sich auf dem im Fahrzeug eingebautem Aggregat.
the number is on the unit build in the car
il numero si trova sull'aggregato montato nella macchina
le numéro se trouve sur la pièce montée dans le véhicule
el n° se encuentra en el equipo montado en el vehículo



03.6121-0501.4	03.3508-0264.3	310009	Behälter
03.6122-0010.4	03.3508-8302.3	310046	Behälter
03.6122-0017.4	03.3508-8302.3	310046	Behälter
03.6122-0018.4	03.3508-8302.3	310046	Behälter
03.6122-0601.4	03.3508-8302.3	310046	Behälter
03.6122-1002.4	03.3508-8302.3	310046	Behälter
03.6122-1006.4	03.3508-8302.3	310046	Behälter
03.6122-1401.4	03.3508-8302.3	310046	Behälter
03.6122-2001.4	03.2119-6207.3	010060	THz 19,05
03.6122-2002.4	03.2119-6207.3	010060	THz 19,05
03.6122-2003.4	03.2119-6207.3	010060	THz 19,05
03.6122-2102.4	03.3508-8302.3	310046	Behälter
03.6122-2401.4	03.2119-0525.3	010046	THz 19,05 + Behälter
03.6122-2402.4	03.2120-0148.3	010070	THz 20,64 + Behälter
03.6122-2407.4	03.2120-0148.3	010070	THz 20,64 + Behälter
03.6127-0001.4	03.2123-6802.3	010186	THz 23,81
03.6127-0301.4	03.2123-6802.3	010186	THz 23,81
03.6127-0801.4	03.2122-0142.3	010128	THz 22,20
	03.3558-0676.3	310077	Behälter + WE
03.6127-0804.4	03.3558-0676.3	310077	Behälter + WE
03.6132-0702.4	03.3508-8302.3	310046	Behälter
03.6132-1103.4	03.2120-0148.3	010070	THz 20,64 + Behälter
03.6132-1401.4	03.3508-8302.3	310046	Behälter
03.6132-1501.4	03.2122-0142.3	010128	THz 22,20
	03.3558-0676.3	310077	Behälter + WE
03.6132-1502.4	03.2122-0142.3	010128	THz 22,20
	03.3558-0676.3	310077	Behälter + WE
03.6132-1701.4	03.2123-1003.3	010175	THz 23,81
03.6132-1901.4	03.2120-5503.3	010124	THz 20,64 + Behälter
03.6132-2001.4	03.3508-8302.3	310046	Behälter
03.6132-2701.4	03.3508-7504.3	310045	Behälter
03.6132-2901.4	03.2120-0148.3	010070	THz 20,64 + Behälter

03.6132-3401.4	03.3508-8302.3	310046	Behälter
03.6132-3905.4	03.3508-7504.3	310045	Behälter
03.6132-3907.4	03.2120-1531.3	010092	THz 20,64
	03.3508-7504.3	310045	Behälter
03.6132-3908.4	03.3508-7504.3	310045	Behälter
03.6132-3912.4	03.2120-1531.3	010092	THz 20,64
03.6132-4201.4	03.2120-0148.3	010070	THz 20,64 + Behälter
03.6132-4202.4	03.2120-0148.3	010070	THz 20,64 + Behälter
03.6132-4203.4	03.2120-0148.3	010070	THz 20,64 + Behälter
03.6132-4207.4	03.2120-0148.3	010070	THz 20,64 + Behälter
03.6132-4401.4	03.2120-5503.3	010124	THz 20,64 + Behälter
03.6132-4601.4	03.3508-7504.3	310045	Behälter
03.6132-4703.4	03.3508-8302.3	310046	Behälter
03.6132-4704.4	03.3508-8302.3	310046	Behälter
03.6132-4901.4	03.3508-7504.3	310045	Behälter
03.6132-5201.4	03.3508-7504.3	310045	Behälter
03.6132-5405.4	03.2120-0538.3	010077	THz 20,64
03.6132-5501.4	03.2120-1531.3	010092	THz 20,64
	03.3508-7504.3	310045	Behälter
03.6132-5502.4	03.3508-7504.3	310045	Behälter
03.6132-5701.4	03.2120-1531.3	010092	THz 20,64
03.6132-5802.4	03.3508-7504.3	310045	Behälter
03.6132-6301.4	03.2120-2598.3	010116	THz 20,64
03.6132-6302.4	03.2120-2598.3	010116	THz 20,64
03.6132-6304.4	03.2120-2598.3	010116	THz 20,64
03.6132-6305.4	03.2120-2598.3	010116	THz 20,64
03.6132-6306.4	03.2120-2598.3	010116	THz 20,64
03.6132-6501.4	03.2120-1531.3	010092	THz 20,64
03.6132-6512.4	03.2120-1531.3	010092	THz 20,64
03.6132-6515.4	03.2120-1491.3	010089	THz 20,64 + WE
03.6132-6706.4	03.2120-1491.3	010089	THz 20,64 + WE
03.6142-0301.4	03.3508-8302.3	310046	Behälter

Bremsgeräte komplett

Booster units complete - Servofreni completi -
Servo-freins complets - Servofreno completo

● Die Nr. befindet sich auf dem im Fahrzeug eingebautem Aggregat.
the number is on the unit build in the car
il numero si trova sull'aggregato montato nella macchina
le numéro se trouve sur la pièce montée dans le véhicule
el n° se encuentra en el equipo montado en el vehículo



03.6142-0701.4	03.3508-8302.3	310046	Behälter
03.6142-1201.4	03.2123-2604.3	010178	THz 23,81 + WE
03.6142-1202.4	03.2123-2604.3	010178	THz 23,81 + WE
03.6142-1205.4	03.2123-2604.3	010178	THz 23,81 + WE
03.6142-1701.4	03.2119-6207.3 03.3558-0676.3	010060 310077	THz 19,05 Behälter + WE
03.6142-1703.4	03.2120-4504.3 03.3558-0676.3	010123 310077	THz 20,64 Behälter + WE
03.6142-1704.4	03.2120-4504.3 03.3558-0676.3	010123 310077	THz 20,64 Behälter + WE
03.6142-2402.4	03.2123-6207.3 03.3508-7504.3	010185 310045	THz 23,81 Behälter
03.6142-2403.4	03.3508-7504.3	310045	Behälter
03.6142-3001.4	03.2120-5503.3	010124	THz 20,64 + Behälter
03.6142-3201.4	03.6058-0301.3	320072	BR 25/5 (3)
03.6142-3203.4	03.6058-0301.3	320072	BR 25/5 (3)
03.6142-3204.4	03.6058-0301.3	320072	BR 25/5 (3)
03.6142-3205.4	03.6058-0301.3	320072	BR 25/5 (3)
03.6142-3301.4	03.2123-6207.3 03.3508-7504.3	010185 310045	THz 23,81 Behälter
03.6142-3302.4	03.3508-7504.3	310045	Behälter
03.6142-4401.4	03.2123-2604.3	010178	THz 23,81 + WE
03.6142-4601.4	03.2122-0142.3 03.3558-0676.3	010128 310077	THz 22,20 Behälter + WE
03.6142-4602.4	03.2122-0142.3 03.3558-0676.3	010128 310077	THz 22,20 Behälter + WE
03.6142-4603.4	03.2122-0142.3 03.3558-0676.3	010128 310077	THz 22,20 Behälter + WE
03.6142-4604.4	03.2122-0142.3 03.3558-0676.3	010128 310077	THz 22,20 Behälter + WE
03.6142-4605.4	03.2122-0142.3 03.3558-0676.3	010128 310077	THz 22,20 Behälter + WE
03.6142-4701.4	03.2122-4902.3	010144	THz 22,20
03.6142-4702.4	03.2122-4902.3	010144	THz 22,20
03.6142-4704.4	03.2122-4902.3	010144	THz 22,20

03.6142-4801.4	03.2123-6207.3 03.3508-7504.3	010185 310045	THz 23,81 Behälter
03.6142-4802.4	03.3508-7504.3	310045	Behälter
03.6142-4803.4	03.3508-7504.3	310045	Behälter
03.6142-5201.4	03.2123-6207.3 03.3508-7504.3	010185 310045	THz 23,81 Behälter
03.6142-5202.4	03.3508-7504.3	310045	Behälter
03.6142-5203.4	03.3508-7504.3	310045	Behälter
03.6142-5205.4	03.2123-4911.3	010182	THz 23,81
03.6142-5301.4	03.3508-8302.3	310046	Behälter
03.6142-5502.4	03.3508-7504.3	310045	Behälter
03.6142-6803.4	03.2122-4902.3	010144	THz 22,20
03.6142-7203.4	03.2120-1491.3	010089	THz 20,64 + WE
03.6142-7204.4	03.2120-1491.3	010089	THz 20,64 + WE
03.6142-7205.4	03.2120-1491.3	010089	THz 20,64 + WE
03.6142-7301.4	03.2120-1491.3	010089	THz 20,64 + WE
03.6142-7302.4	03.2120-1491.3	010089	THz 20,64 + WE
03.6142-7303.4	03.2120-1491.3	010089	THz 20,64 + WE
03.6147-0401.4	03.2125-1102.3 03.3508-3600.3	010202 310030	THz 25,40 Behälter
03.6147-0501.4	03.2125-1102.3	010202	THz 25,40
03.6147-1101.4	03.2125-1302.3	010203	THz 25,40
03.6147-1102.4	03.2125-1302.3	010203	THz 25,40
03.6147-1103.4	03.2125-1302.3	010203	THz 25,40
03.6147-1301.4	03.2123-6802.3	010186	THz 23,81
03.6147-1703.4	03.2125-1302.3	010203	THz 25,40
03.6147-2402.4	03.2123-8611.3	010195	THz 23,81
03.6152-0206.4	03.2123-3402.3 03.3508-8753.3 03.6850-0202.4	010181 310049 300043	THz 23,81 Behälter + WE 9"
03.6152-0209.4	03.2023-0166.3 03.6850-0202.4	010015 300043	THz 23,81/19,05 9"
03.6152-0210.4	03.2023-0166.3 03.6850-0202.4	010015 300043	THz 23,81/19,05 9"

Bremsgeräte komplett

Booster units complete - Servofreni completi -
Servo-freins complets - Servofreno completo

● Die Nr. befindet sich auf dem im Fahrzeug eingebautem Aggregat.
the number is on the unit build in the car
il numero si trova sull'aggregato montato nella macchina
le numéro se trouve sur la pièce montée dans le véhicule
el n° se encuentra en el equipo montado en el vehículo



03.6152-0401.4	03.2122-6202.3	010148	THz 22,20
03.6152-0601.4	03.3508-8302.3	310046	Behälter
03.6152-0701.4	03.2123-6802.3	010186	THz 23,81
03.6152-0702.4	03.2122-6202.3	010148	THz 22,20
03.6152-0703.4	03.2122-6202.3	010148	THz 22,20
03.6152-0803.4	03.2123-6207.3 03.3508-7504.3	010185 310045	THz 23,81 Behälter
03.6152-1002.4	03.2123-3302.3	010180	THz 23,81
03.6152-1101.4	03.3508-8302.3	310046	Behälter
03.6152-1401.4	03.2123-6802.3	010186	THz 23,81
03.6152-1502.4	03.2123-3302.3	010180	THz 23,81
03.6152-1701.4	03.2123-6207.3 03.3508-7504.3	010185 310045	THz 23,81 Behälter
03.6152-1801.4	03.2122-0142.3 03.3558-0676.3	010128 310077	THz 22,20 Behälter + WE
03.6152-2001.4	03.2123-6207.3 03.3508-7504.3	010185 310045	THz 23,81 Behälter
03.6152-2002.4	03.3508-7504.3	310045	Behälter
03.6152-2003.4	03.2123-4911.3	010182	THz 23,81
03.6152-2101.4	03.3508-8302.3	310046	Behälter
03.6157-0201.4	03.3508-8302.3	310046	Behälter
03.6157-0301.4	03.2123-1003.3 03.3508-8753.3 03.6855-1202.4	010175 310049 300056	THz 23,81 Behälter + WE 9" Tandem
03.6157-0302.4	03.2123-1003.3 03.3508-8753.3 03.6855-1202.4	010175 310049 300056	THz 23,81 Behälter + WE 9" Tandem
03.6157-0303.4	03.2123-1003.3 03.3508-8753.3 03.6855-1202.4	010175 310049 300056	THz 23,81 Behälter + WE 9" Tandem
03.6157-0304.4	03.2123-3402.3 03.3508-8753.3 03.6855-1202.4	010181 310049 300056	THz 23,81 Behälter + WE 9" Tandem
03.6157-0305.4	03.2123-1003.3 03.3508-8753.3 03.6855-1202.4	010175 310049 300056	THz 23,81 Behälter + WE 9" Tandem
03.6157-0306.4	03.2123-3402.3 03.3508-8753.3 03.6855-1202.4	010181 310049 300056	THz 23,81 Behälter + WE 9" Tandem

03.6157-0307.4	03.6855-1202.4	300056	9" Tandem
03.6157-0308.4	03.2023-0166.3 03.6855-1202.4	010015 300056	THz 23,81/19,05 9" Tandem
03.6157-0309.4	03.6855-1202.4	300056	9" Tandem
03.6157-0310.4	03.2023-0166.3 03.6855-1202.4	010015 300056	THz 23,81/19,05 9" Tandem
03.6157-0501.4	03.2123-7002.3	010187	THz 23,81
03.6157-0503.4	03.2123-7002.3	010187	THz 23,81
03.6197-1501.4	03.3508-8302.3	310046	Behälter
03.6197-2101.4	03.3508-8302.3	310046	Behälter
03.6197-2201.4	03.3508-8302.3	310046	Behälter
03.6197-2202.4	03.3508-8302.3	310046	Behälter
03.6197-2203.4	03.3508-8302.3	310046	Behälter
03.6197-2204.4	03.3508-8302.3	310046	Behälter
03.6197-2801.4	03.3508-8302.3	310046	Behälter
03.6197-3301.4	03.3508-8302.3	310046	Behälter
03.6197-3302.4	03.3508-8302.3	310046	Behälter
03.6732-0101.4	03.2120-2031.3	010106	THz 20,64
03.6732-0201.4	03.2120-2031.3	010106	THz 20,64
03.6732-0203.4	03.2120-2031.3	010106	THz 20,64
03.6732-0401.4	03.2120-2031.3	010106	THz 20,64
03.6732-0503.4	03.2120-2598.3	010116	THz 20,64
03.6732-0504.4	03.2120-2598.3	010116	THz 20,64
03.6732-0601.4	03.2120-2031.3	010106	THz 20,64
03.6732-0901.4	03.2119-3389.3	010057	THz 19,05
03.6732-1001.4	03.2119-3389.3	010057	THz 19,05
03.6732-1101.4	03.2119-3389.3	010057	THz 19,05
03.6732-1103.4	03.2119-3389.3	010057	THz 19,05
03.6732-1201.4	03.2119-3389.3	010057	THz 19,05
03.6732-3301.4	03.2119-3389.3	010057	THz 19,05
03.6732-3501.4	03.2119-3389.3	010057	THz 19,05
03.6742-0101.4	03.2120-2598.3	010116	THz 20,64

Bremsgeräte komplett

**Booster units complete - Servofreni completi -
Servo-freins complets - Servofreno completo**

● Die Nr. befindet sich auf dem im Fahrzeug eingebautem Aggregat.
the number is on the unit build in the car
il numero si trova sull'aggregato montato nella macchina
le numéro se trouve sur la pièce montée dans le véhicule
el n° se encuentra en el equipo montado en el vehículo



03.6742-0102.4	03.2120-2598.3	010116	THz 20,64
03.6742-0103.4	03.2120-2598.3	010116	THz 20,64
03.6742-0104.4	03.2120-2598.3	010116	THz 20,64
03.6742-0105.4	03.2120-2598.3	010116	THz 20,64
03.6742-0106.4	03.2120-2598.3	010116	THz 20,64
03.6742-0107.4	03.2120-2598.3	010116	THz 20,64
03.6742-0108.4	03.2120-2598.3	010116	THz 20,64
03.6742-0109.4	03.2120-2598.3	010116	THz 20,64
03.6742-0110.4	03.2120-2598.3	010116	THz 20,64
03.6742-0111.4	03.2120-2598.3	010116	THz 20,64
03.6742-0112.4	03.2120-2598.3	010116	THz 20,64
03.6742-0113.4	03.2120-2598.3	010116	THz 20,64
03.6742-0114.4	03.2120-2598.3	010116	THz 20,64
03.6742-0115.4	03.2120-2598.3	010116	THz 20,64
03.6742-0116.4	03.2120-2598.3	010116	THz 20,64
03.6742-0117.4	03.2120-2598.3	010116	THz 20,64
03.6742-0118.4	03.2120-2598.3	010116	THz 20,64
03.6742-0119.4	03.2120-2597.3	010115	THz 20,64
03.6742-0120.4	03.2120-2597.3	010115	THz 20,64
03.6742-0121.4	03.2120-2597.3	010115	THz 20,64
03.6742-0122.4	03.2120-2597.3	010115	THz 20,64
03.6742-0123.4	03.2120-2597.3	010115	THz 20,64
03.6742-0124.4	03.2120-2597.3	010115	THz 20,64
03.6742-0201.4	03.2123-4911.3	010182	THz 23,81
03.6742-0202.4	03.2120-0538.3	010077	THz 20,64
03.6742-0203.4	03.2120-2598.3	010116	THz 20,64
03.6742-0204.4	03.2120-2598.3	010116	THz 20,64
03.6742-0301.4	03.2120-2598.3	010116	THz 20,64
03.6742-0302.4	03.2120-2598.3	010116	THz 20,64
03.6742-0401.4	03.2120-2598.3	010116	THz 20,64
03.6742-0402.4	03.2120-2598.3	010116	THz 20,64

03.6742-0404.4	03.2120-2598.3	010116	THz 20,64
03.6742-0406.4	03.2120-2598.3	010116	THz 20,64
03.6742-0407.4	03.2120-2598.3	010116	THz 20,64
03.6742-0409.4	03.2120-2597.3	010115	THz 20,64
03.6742-0410.4	03.2120-2597.3	010115	THz 20,64
03.6742-0411.4	03.2120-2597.3	010115	THz 20,64
03.6742-0412.4	03.2120-2597.3	010115	THz 20,64
03.6742-0413.4	03.2120-2597.3	010115	THz 20,64
03.6742-0414.4	03.2120-2597.3	010115	THz 20,64
03.6742-0415.4	03.2120-2597.3	010115	THz 20,64
03.6742-0416.4	03.2120-2597.3	010115	THz 20,64
03.6742-0419.4	03.2120-2597.3	010115	THz 20,64
03.6742-0420.4	03.2120-2597.3	010115	THz 20,64
03.6742-0421.4	03.2120-2597.3	010115	THz 20,64
03.6742-0422.4	03.2120-2597.3	010115	THz 20,64
03.6742-0423.4	03.2120-2597.3	010115	THz 20,64
03.6742-0601.4	03.2122-0142.3 03.3558-0676.3	010128 310077	THz 22,20 Behälter + WE
03.6742-0701.4	03.2119-3389.3	010057	THz 19,05
03.6742-1201.4	03.2119-3389.3	010057	THz 19,05
03.6742-1501.4	03.2120-2031.3	010106	THz 20,64
03.6742-1701.4	03.2120-2031.3	010106	THz 20,64
03.6752-0201.4	03.2120-2031.3 03.6750-0202.4	010106 300033	THz 20,64 9"
03.6752-0302.4	03.2120-2031.3	010106	THz 20,64
03.6752-0305.4	03.2120-2331.3	010110	THz 20,64
03.6752-0306.4	03.2120-2031.3	010106	THz 20,64
03.6752-0501.4	03.2120-2598.3	010116	THz 20,64
03.6752-0502.4	03.2120-2598.3	010116	THz 20,64
03.6752-0505.4	03.2120-2597.3	010115	THz 20,64
03.6752-0506.4	03.2120-2597.3	010115	THz 20,64
03.6752-0507.4	03.2120-2597.3	010115	THz 20,64

Bremsgeräte komplett

Booster units complete - Servofreni completi - Servo-freins complets - Servofreno completo

● Die Nr. befindet sich auf dem im Fahrzeug eingebautem Aggregat.
the number is on the unit build in the car
il numero si trova sull'aggregato montato nella macchina
le numéro se trouve sur la pièce montée dans le véhicule
el n° se encuentra en el equipo montado en el vehículo



03.6752-0508.4	03.2120-2597.3	010115	THz 20,64
03.6752-0801.4	03.2122-9812.3	010161	THz 22,20
03.6752-0902.4	03.2120-2331.3	010110	THz 20,64
	03.7750-0302.4	300071	9"
03.6752-0903.4	03.7750-0302.4	300071	9"
03.6752-1002.4	03.2120-2682.3	010118	THz 20,64
03.6752-1101.4	03.2120-2331.3	010110	THz 20,64
03.6752-1102.4	03.2122-9612.3	010159	THz 22,20
03.6752-1201.4	03.2120-2331.3	010110	THz 20,64
03.6752-1301.4	03.2126-0512.3	010217	THz 26,99
03.6752-1401.4	03.2120-2331.3	010110	THz 20,64
03.6752-1607.4	03.2120-2597.3	010115	THz 20,64
03.6752-1608.4	03.2120-2597.3	010115	THz 20,64
03.6752-1609.4	03.2120-2597.3	010115	THz 20,64
03.6752-1610.4	03.2120-2597.3	010115	THz 20,64
03.6752-1611.4	03.2120-2597.3	010115	THz 20,64
03.6752-1703.4	03.2120-2597.3	010115	THz 20,64
03.6752-1704.4	03.2120-2597.3	010115	THz 20,64
03.6752-1901.4	03.2120-2031.3	010106	THz 20,64
03.6752-2101.4	03.2120-2682.3	010118	THz 20,64
03.6752-2502.4	03.2122-9631.3	010160	THz 22,20
03.6752-2601.4	03.2122-9631.3	010160	THz 22,20
03.6752-2901.4	03.6750-2902.4	300037	9"
03.6752-2902.4	03.2122-9631.3	010160	THz 22,20
	03.6750-2902.4	300037	9"
03.6752-2903.4	03.2120-2682.3	010118	THz 20,64
	03.6750-2902.4	300037	9"
03.6752-3103.4	03.2120-2682.3	010118	THz 20,64
03.6752-3201.4	03.2120-2031.3	010106	THz 20,64
03.6752-3501.4	03.2120-2682.3	010118	THz 20,64
03.6752-3601.4	03.2120-2682.3	010118	THz 20,64
03.6752-3701.4	03.2122-0626.3	010539	THz 22,20

03.6752-3702.4	03.2122-9631.3	010160	THz 22,20
03.6757-1004.4	03.2023-0166.3	010015	THz 23,81/19,05
	03.6855-1202.4	300056	9" Tandem
03.6762-0101.4	03.2123-8311.3	010192	THz 23,81
	03.7760-0902.4	300088	10"
03.6762-0102.4	03.2122-6911.3	010153	THz 22,20
	03.7760-0902.4	300088	10"
03.6762-0103.4	03.2122-6911.3	010153	THz 22,20
	03.7760-0902.4	300088	10"
03.6762-0104.4	03.7760-0902.4	300088	10"
03.6762-0105.4	03.2020-0402.3	010001	THz 20,64/19,05
	03.7760-0902.4	300088	10"
03.6762-0106.4	03.2123-8311.3	010192	THz 23,81
	03.7760-0902.4	300088	10"
03.6762-0107.4	03.7760-0902.4	300088	10"
03.6762-0108.4	03.2120-2082.3	010107	THz 20,64
	03.7760-0902.4	300088	10"
03.6762-0110.4	03.2120-1802.3	010099	THz 20,64
	03.7760-0902.4	300088	10"
03.6762-0111.4	03.2020-0402.3	010001	THz 20,64/19,05
	03.7760-0902.4	300088	10"
03.6762-0112.4	03.2120-1802.3	010099	THz 20,64
	03.7760-0902.4	300088	10"
03.6762-0114.4	03.2020-0402.3	010001	THz 20,64/19,05
	03.7760-0902.4	300088	10"
03.6762-0115.4	03.2120-2082.3	010107	THz 20,64
	03.7760-0902.4	300088	10"
03.6762-0116.4	03.2123-8311.3	010192	THz 23,81
	03.7760-0902.4	300088	10"
03.6762-0117.4	03.7760-0902.4	300088	10"
03.6762-0118.4	03.2123-8311.3	010192	THz 23,81
	03.7760-0902.4	300088	10"
03.6762-0312.4	03.7760-2702.4	300090	10"
03.6762-0401.4	03.2023-0825.3	010028	THz 23,81/19,05
	03.7760-2702.4	300090	10"
03.6762-0402.4	03.2023-0825.3	010028	THz 23,81/19,05
	03.7760-2702.4	300090	10"
03.6762-0501.4	03.2022-0702.3	010007	THz 22,20/19,05
03.6762-0502.4	03.2022-0702.3	010007	THz 22,20/19,05

Bremsgeräte komplett

Booster units complete - Servofreni completi - Servo-freins complets - Servofreno completo

● Die Nr. befindet sich auf dem im Fahrzeug eingebautem Aggregat.
the number is on the unit build in the car
il numero si trova sull'aggregato montato nella macchina
le numéro se trouve sur la pièce montée dans le véhicule
el n° se encuentra en el equipo montado en el vehículo



03.6762-0503.4	03.2022-0702.3	010007	THz 22,20/19,05	03.6842-0704.4	03.2120-0538.3	010077	THz 20,64
03.6762-0504.4	03.2022-1402.3	010010	THz 22,20/19,05	03.6842-1001.4	03.2123-0162.3	010162	THz 23,81 + WE
03.6762-0505.4	03.2022-1402.3	010010	THz 22,20/19,05	03.6842-1002.4	03.2120-2462.3	010113	THz 20,64 + WE
03.6762-0508.4	03.2022-1602.3	010011	THz 22,20/19,05	03.6842-1003.4	03.2123-0162.3	010162	THz 23,81 + WE
03.6762-0509.4	03.2022-1602.3	010011	THz 22,20/19,05	03.6842-1401.4	03.2120-0151.3	010071	THz 20,64
03.6762-0519.4	03.2022-1402.3	010010	THz 22,20/19,05	03.6842-1605.4	03.2120-2598.3	010116	THz 20,64
03.6762-0520.4	03.2022-1602.3	010011	THz 22,20/19,05	03.6842-1606.4	03.2120-2598.3	010116	THz 20,64
03.6762-0522.4	03.2022-0702.3	010007	THz 22,20/19,05	03.6842-1607.4	03.2120-2598.3	010116	THz 20,64
03.6762-0523.4	03.2022-1402.3	010010	THz 22,20/19,05	03.6842-1608.4	03.2120-2598.3	010116	THz 20,64
03.6762-0525.4	03.2022-1602.3	010011	THz 22,20/19,05	03.6842-1609.4	03.2120-2598.3	010116	THz 20,64
03.6762-0601.4	03.2020-0402.3 03.7760-0902.4	010001 300088	THz 20,64/19,05 10"	03.6842-1610.4	03.2120-2598.3	010116	THz 20,64
03.6762-0602.4	03.2120-1802.3 03.7760-0902.4	010099 300088	THz 20,64 10"	03.6842-1611.4	03.2120-2598.3	010116	THz 20,64
03.6832-0101.4	03.2120-3412.3	010121	THz 20,64	03.6842-1612.4	03.2120-2598.3	010116	THz 20,64
03.6832-0104.4	03.6058-0501.3	320074	BR 25/5 (4)	03.6842-1613.4	03.2120-2598.3	010116	THz 20,64
03.6832-0201.4	03.2120-1531.3	010092	THz 20,64	03.6842-1614.4	03.2120-2598.3	010116	THz 20,64
03.6832-0202.4	03.2120-1531.3	010092	THz 20,64	03.6842-3401.4	03.2123-0162.3	010162	THz 23,81 + WE
03.6832-0601.4	03.2120-0322.3	010074	THz 20,64 + WE	03.6852-0201.4	03.2123-1003.3 03.3508-8753.3 03.6850-0202.4	010175 310049 300043	THz 23,81 Behälter + WE 9"
03.6832-0701.4	03.2120-2462.3	010113	THz 20,64 + WE	03.6852-0202.4	03.2123-3402.3 03.3508-8753.3 03.6850-0202.4	010181 310049 300043	THz 23,81 Behälter + WE 9"
03.6832-1001.4	03.2120-2462.3	010113	THz 20,64 + WE	03.6852-0203.4	03.2123-1003.3 03.3508-8753.3 03.6850-0202.4	010175 310049 300043	THz 23,81 Behälter + WE 9"
03.6832-1102.4	03.2120-0148.3	010070	THz 20,64 + Behälter	03.6852-0204.4	03.6850-0202.4	300043	9"
03.6832-1301.4	03.2120-0151.3	010071	THz 20,64	03.6852-0205.4	03.2023-0166.3 03.6850-0202.4	010015 300043	THz 23,81/19,05 9"
03.6832-1505.4	03.2120-1531.3	010092	THz 20,64	03.6852-0207.4	03.2023-0166.3 03.6850-0202.4	010015 300043	THz 23,81/19,05 9"
03.6832-1704.4	03.2120-1531.3	010092	THz 20,64	03.6852-0210.4	03.2023-0166.3 03.6850-0202.4	010015 300043	THz 23,81/19,05 9"
03.6832-1705.4	03.2120-1531.3	010092	THz 20,64	03.6852-0211.4	03.2023-0166.3 03.6850-0202.4	010015 300043	THz 23,81/19,05 9"
03.6832-1706.4	03.2120-1531.3	010092	THz 20,64	03.6852-0501.4	03.2123-2604.3 03.6850-0502.4	010178 300044	THz 23,81 + WE 9"
03.6842-0301.4	03.2120-0622.3	010079	THz 20,64	03.6842-0702.4	03.2120-0538.3	010077	THz 20,64
03.6842-0601.4	03.2120-0538.3	010077	THz 20,64	03.6842-0703.4	03.2123-4911.3	010182	THz 23,81
03.6842-0701.4	03.2120-0538.3	010077	THz 20,64				

Bremsgeräte komplett

Booster units complete - Servofreni completi -
Servo-freins complets - Servofreno completo

● Die Nr. befindet sich auf dem im Fahrzeug eingebautem Aggregat.
the number is on the unit build in the car
il numero si trova sull'aggregato montato nella macchina
le numéro se trouve sur la pièce montée dans le véhicule
el n° se encuentra en el equipo montado en el vehículo



03.6852-0503.4	03.2123-2604.3 03.6850-0502.4	010178 300044	THz 23,81 + WE 9"
03.6852-1001.4	03.2123-5212.3 03.6850-5402.4	010183 300055	THz 23,81 9"
03.6852-1002.4	03.2123-5212.3 03.6850-5402.4	010183 300055	THz 23,81 9"
03.6852-1006.4	03.2123-0271.3 03.6850-5402.4	010164 300055	THz 23,81 + WE 9"
03.6852-1007.4	03.2123-0271.3 03.6850-5402.4	010164 300055	THz 23,81 + WE 9"
03.6852-1008.4	03.2123-0291.3 03.6850-5402.4	010165 300055	THz 23,81 9"
03.6852-1009.4	03.2123-0291.3 03.6850-5402.4	010165 300055	THz 23,81 9"
03.6852-1012.4	03.2123-0271.3 03.6850-5402.4	010164 300055	THz 23,81 + WE 9"
03.6852-1013.4	03.2123-0271.3 03.6850-5402.4	010164 300055	THz 23,81 + WE 9"
03.6852-1014.4	03.6850-5402.4	300055	9"
03.6852-1015.4	03.6850-5402.4	300055	9"
03.6852-1301.4	03.2123-6802.3	010186	THz 23,81
03.6852-1302.4	03.2123-6802.3	010186	THz 23,81
03.6852-1303.4	03.2123-6802.3	010186	THz 23,81
03.6852-1304.4	03.2122-6202.3	010148	THz 22,20
03.6852-1601.4	03.2123-6002.3 03.6850-2602.4	010184 300049	THz 23,81 9"
03.6852-1701.4	03.2123-9002.3	010198	THz 23,81 + WE
03.6852-1702.4	03.2123-9002.3	010198	THz 23,81 + WE
03.6852-1902.4	03.2123-4911.3	010182	THz 23,81
03.6852-1903.4	03.2123-6207.3	010185	THz 23,81
03.6852-2001.4	03.2123-6002.3 03.6850-2602.4	010184 300049	THz 23,81 9"
03.6852-2101.4	03.2120-0562.3	010078	THz 20,64
03.6852-2201.4	03.2123-4911.3	010182	THz 23,81
03.6852-2202.4	03.2123-6207.3	010185	THz 23,81
03.6852-2205.4	03.2120-0538.3	010077	THz 20,64

03.6852-2307.4	03.2120-1491.3	010089	THz 20,64 + WE
03.6852-2401.4	03.2120-0622.3	010079	THz 20,64
03.6852-2402.4	03.2120-0622.3	010079	THz 20,64
03.6852-2405.4	03.2120-0622.3	010079	THz 20,64
03.6852-3801.4	03.2120-1142.3	010085	THz 20,64
03.6852-4403.4	03.2122-8806.3	010157	THz 22,20
03.6852-4404.4	03.2122-8806.3	010157	THz 22,20
03.6852-4405.4	03.2122-8806.3	010157	THz 22,20
03.6852-4406.4	03.2122-8806.3	010157	THz 22,20
03.6852-4407.4	03.2122-8806.3	010157	THz 22,20
03.6852-4408.4	03.2122-8806.3	010157	THz 22,20
03.6852-4409.4	03.2122-8806.3	010157	THz 22,20
03.6852-4603.4	03.2123-7902.3 03.7750-5702.4	010191 300083	THz 23,81 + WE 9"
03.6852-4604.4	03.2123-8902.3 03.7750-5702.4	010197 300083	THz 23,81 9"
03.6852-4605.4	03.2023-0172.3 03.7750-5702.4	010016 300083	THz 23,81/19,05 9"
03.6852-4606.4	03.2023-0172.3 03.7750-5702.4	010016 300083	THz 23,81/19,05 9"
03.6852-4702.4	03.2123-7902.3	010191	THz 23,81 + WE
03.6852-4703.4	03.2123-8902.3	010197	THz 23,81
03.6852-5002.4	03.2120-1491.3	010089	THz 20,64 + WE
03.6852-5003.4	03.2120-1531.3	010092	THz 20,64
03.6852-5401.4	03.2123-5212.3 03.6850-5402.4	010183 300055	THz 23,81 9"
03.6852-5402.4	03.2123-5212.3 03.6850-5402.4	010183 300055	THz 23,81 9"
03.6852-5403.4	03.2123-5212.3 03.6850-5402.4	010183 300055	THz 23,81 9"
03.6852-5404.4	03.2123-5212.3 03.6850-5402.4	010183 300055	THz 23,81 9"
03.6852-5902.4	03.2122-8012.3	010156	THz 22,20
03.6852-6202.4	03.2122-8012.3 03.6058-0301.3	010156 320072	THz 22,20 BR 25/5 (3)

Bremsgeräte komplett

Booster units complete - Servofreni completi - Servo-freins complets - Servofreno completo

● Die Nr. befindet sich auf dem im Fahrzeug eingebautem Aggregat.
the number is on the unit build in the car
il numero si trova sull'aggregato montato nella macchina
le numéro se trouve sur la pièce montée dans le véhicule
el n° se encuentra en el equipo montado en el vehículo



03.6857-0101.4	03.2023-0166.3 03.6855-1202.4	010015 300056	THz 23,81/19,05 9" Tandem
03.6857-0104.4	03.6855-1202.4	300056	9" Tandem
03.6857-0105.4	03.2023-0166.3 03.6855-1202.4	010015 300056	THz 23,81/19,05 9" Tandem
03.6857-0108.4	03.2023-0166.3 03.6855-1202.4	010015 300056	THz 23,81/19,05 9" Tandem
03.6857-0303.4	03.2023-0166.3 03.6855-1202.4	010015 300056	THz 23,81/19,05 9" Tandem
03.6857-0304.4	03.2023-0166.3 03.6855-1202.4	010015 300056	THz 23,81/19,05 9" Tandem
03.6857-0501.4	03.2125-1712.3	010204	THz 25,40
03.6857-0502.4	03.2125-1712.3	010204	THz 25,40
03.6857-0503.4	03.2125-1712.3	010204	THz 25,40
03.6857-0504.4	03.2125-1712.3	010204	THz 25,40
03.6857-1001.4	03.2023-0166.3 03.6855-1202.4	010015 300056	THz 23,81/19,05 9" Tandem
03.6857-1002.4	03.2023-0166.3 03.6855-1202.4	010015 300056	THz 23,81/19,05 9" Tandem
03.6857-1003.4	03.2023-0166.3 03.6855-1202.4	010015 300056	THz 23,81/19,05 9" Tandem
03.6857-1106.4	03.2123-8512.3	010194	THz 23,81
03.6857-1201.4	03.2023-0166.3 03.6855-1202.4	010015 300056	THz 23,81/19,05 9" Tandem
03.6857-1202.4	03.2023-0166.3 03.6855-1202.4	010015 300056	THz 23,81/19,05 9" Tandem
03.6857-1203.4	03.2025-0111.3 03.6855-1202.4	010033 300056	THz 25,40/19,05 9" Tandem
03.6857-1204.4	03.2025-0111.3 03.6855-1202.4	010033 300056	THz 25,40/19,05 9" Tandem
03.6857-1205.4	03.2025-0111.3 03.6855-1202.4	010033 300056	THz 25,40/19,05 9" Tandem
03.6857-1401.4	03.2126-0512.3 03.6855-1402.4	010217 300057	THz 26,99 9" Tandem
03.6857-1402.4	03.2125-1902.3 03.6855-1402.4	010206 300057	THz 25,40 9" Tandem
03.6857-1403.4	03.2125-1902.3 03.6855-1402.4	010206 300057	THz 25,40 9" Tandem

03.6857-1404.4	03.2125-2102.3 03.6855-1402.4	010207 300057	THz 25,40 9" Tandem
03.6857-1405.4	03.6855-1402.4	300057	9" Tandem
03.6857-1406.4	03.6855-1402.4	300057	9" Tandem
03.6857-1407.4	03.6855-1402.4	300057	9" Tandem
03.6857-1408.4	03.6855-1402.4	300057	9" Tandem
03.6857-1409.4	03.6855-1402.4	300057	9" Tandem
03.6857-1410.4	03.6855-1402.4	300057	9" Tandem
03.6857-1411.4	03.6855-1402.4	300057	9" Tandem
03.6857-1413.4	03.6855-1402.4	300057	9" Tandem
03.6857-1416.4	03.6855-1402.4	300057	9" Tandem
03.6857-1417.4	03.6855-1402.4	300057	9" Tandem
03.6857-1420.4	03.6855-1402.4	300057	9" Tandem
03.6857-1421.4	03.6855-1402.4	300057	9" Tandem
03.6857-1422.4	03.6855-1402.4	300057	9" Tandem
03.6857-1423.4	03.6855-1402.4	300057	9" Tandem
03.6857-1424.4	03.6855-1402.4	300057	9" Tandem
03.6857-1425.4	03.6855-1402.4	300057	9" Tandem
03.6857-1426.4	03.6855-1402.4	300057	9" Tandem
03.6857-1501.4	03.2125-1712.3	010204	THz 25,40
03.6857-1502.4	03.2125-1712.3	010204	THz 25,40
03.6857-1503.4	03.2125-1712.3	010204	THz 25,40
03.6857-1504.4	03.2125-1712.3	010204	THz 25,40
03.6857-1701.4	03.2123-6002.3 03.3558-0676.3	010184 310077	THz 23,81 Behälter + WE
03.6857-1801.4	03.2125-3801.3	010215	THz 25,40
03.6857-1901.4	03.6855-1902.4	300059	9" Tandem
03.6857-1902.4	03.6855-1902.4	300059	9" Tandem
03.6857-1905.4	03.6855-1902.4	300059	9" Tandem
03.6857-1906.4	03.2125-1902.3 03.6855-1902.4	010206 300059	THz 25,40 9" Tandem
03.6857-1907.4	03.6855-1902.4	300059	9" Tandem

Bremsgeräte komplett

Booster units complete - Servofreni completi -
Servo-freins complets - Servofreno completo

● Die Nr. befindet sich auf dem im Fahrzeug eingebautem Aggregat.
the number is on the unit build in the car
il numero si trova sull'aggregato montato nella macchina
le numéro se trouve sur la pièce montée dans le véhicule
el n° se encuentra en el equipo montado en el vehículo



03.6857-1910.4	03.6855-1902.4	300059	9" Tandem
03.6857-1911.4	03.6855-1902.4	300059	9" Tandem
03.6857-1912.4	03.6855-1902.4	300059	9" Tandem
03.6857-1913.4	03.2125-2102.3 03.6855-1902.4	010207 300059	THz 25,40 9" Tandem
03.6857-2101.4	03.2130-0102.3 03.6855-2202.4	010221 300061	THz 30,00 9" Tandem
03.6857-2103.4	03.6855-2202.4	300061	9" Tandem
03.6857-2201.4	03.2130-0102.3 03.6855-2202.4	010221 300061	THz 30,00 9" Tandem
03.6857-2202.4	03.6855-2202.4	300061	9" Tandem
03.6857-2203.4	03.6855-2202.4	300061	9" Tandem
03.6857-2204.4	03.6855-2202.4	300061	9" Tandem
03.6857-2205.4	03.6855-2202.4	300061	9" Tandem
03.6857-2301.4	03.2123-8512.3	010194	THz 23,81
03.6857-2401.4	03.2125-3801.3	010215	THz 25,40
03.6862.0904.4	03.7760-0902.4	300088	10"
03.6862-0201.4	03.2023-0166.3	010015	THz 23,81/19,05
03.6862-0202.4	03.2023-0166.3	010015	THz 23,81/19,05
03.6862-0203.4	03.2023-0166.3	010015	THz 23,81/19,05
03.6862-0204.4	03.2023-0166.3	010015	THz 23,81/19,05
03.6862-0301.4	03.2123-9002.3	010198	THz 23,81 + WE
03.6862-0501.4	03.2123-4911.3	010182	THz 23,81
03.6862-0502.4	03.2123-4911.3	010182	THz 23,81
03.6862-0505.4	03.2123-4911.3	010182	THz 23,81
03.6862-0506.4	03.2123-6207.3	010185	THz 23,81
03.6862-0507.4	03.2123-4911.3	010182	THz 23,81
03.6862-0508.4	03.2123-4911.3	010182	THz 23,81
03.6862-0801.4	03.2123-9002.3 03.7760-0402.4	010198 300087	THz 23,81 + WE 10"
03.6862-0802.4	03.2023-0183.3 03.7760-0402.4	010017 300087	THz 23,81/19,05 10"
03.6862-0803.4	03.7760-0402.4	300087	10"

03.6862-0901.4	03.2122-6911.3 03.7760-0902.4	010153 300088	THz 22,20 10"
03.6862-0902.4	03.2122-6911.3 03.7760-0902.4	010153 300088	THz 22,20 10"
03.6862-0903.4	03.2123-8311.3 03.7760-0902.4	010192 300088	THz 23,81 10"
03.6862-1101.4	03.2125-3801.3	010215	THz 25,40
03.6862-1105.4	03.2125-3801.3	010215	THz 25,40
03.6862-1201.4	03.2023-0262.3	010020	THz 23,81/20,64
03.6952-0201.4	03.2122-8012.3	010156	THz 22,20
03.6952-0202.4	03.2122-8012.3 03.6058-0301.3	010156 320072	THz 22,20 BR 25/5 (3)
03.6952-0301.4	03.2023-0172.3 03.7750-5702.4	010016 300083	THz 23,81/19,05 9"
03.6952-0302.4	03.2023-0172.3 03.7750-5702.4	010016 300083	THz 23,81/19,05 9"
03.6952-0401.4	03.2122-9612.3 03.7750-0302.4	010159 300071	THz 22,20 9"
03.6952-0501.4	03.2122-9612.3 03.7750-0302.4	010159 300071	THz 22,20 9"
03.6952-0601.4	03.2122-9612.3 03.7750-0302.4	010159 300071	THz 22,20 9"
03.6952-0701.4	03.2122-9612.3 03.7750-0302.4	010159 300071	THz 22,20 9"
03.7732-0201.4	03.2120-2031.3	010106	THz 20,64
03.7732-0401.4	03.2120-2031.3	010106	THz 20,64
03.7742-0801.4	03.2120-2031.3	010106	THz 20,64
03.7742-0901.4	03.2120-2031.3	010106	THz 20,64
03.7742-1404.4	03.2120-3943.3	010532	THz 20,64
03.7742-2001.4	03.2120-2031.3	010106	THz 20,64
03.7742-2101.4	03.2120-2031.3	010106	THz 20,64
03.7742-3802.4	03.2122-1184.3	010592	THz 22,20
03.7742-3806.4	03.2122-1184.3	010592	THz 22,20
03.7742-3808.4	03.2122-1184.3	010592	THz 22,20
03.7742-4001.4	03.2120-4221.3	010605	THz 20,64
03.7742-4401.4	03.2123-1484.3	010595	THz 23,81

Bremsgeräte komplett

Booster units complete - Servofreni completi - Servo-freins complets - Servofreno completo

● Die Nr. befindet sich auf dem im Fahrzeug eingebautem Aggregat.
the number is on the unit build in the car
il numero si trova sull'aggregato montato nella macchina
le numéro se trouve sur la pièce montée dans le véhicule
el n° se encuentra en el equipo montado en el vehículo



03.7742-4402.4	03.2123-1484.3	010595	THz 23,81
03.7752-0101.4	03.2022-0602.3	010006	THz 22,20/19,05
03.7752-0102.4	03.2022-0602.3	010006	THz 22,20/19,05
03.7752-0104.4	03.2022-0602.3	010006	THz 22,20/19,05
03.7752-0201.4	03.2122-9612.3	010159	THz 22,20
	03.7750-0302.4	300071	9"
03.7752-0204.4	03.2122-9612.3	010159	THz 22,20
	03.7750-0302.4	300071	9"
03.7752-0302.4	03.2122-9612.3	010159	THz 22,20
	03.7750-0302.4	300071	9"
03.7752-0401.4	03.2023-0562.3	010025	THz 23,81/20,64
	03.7750-0302.4	300071	9"
03.7752-0402.4	03.2023-0542.3	010024	THz 23,81/20,64
	03.7750-0302.4	300071	9"
03.7752-0404.4	03.7750-5702.4	300083	9"
03.7752-0405.4	03.2023-0542.3	010024	THz 23,81/20,64
	03.7750-5702.4	300083	9"
03.7752-0501.4	03.2122-9612.3	010159	THz 22,20
	03.7750-0302.4	300071	9"
03.7752-0707.4	03.2122-0264.3	010129	THz 22,20
03.7752-0708.4	03.2122-0264.3	010129	THz 22,20
03.7752-0709.4	03.2122-0264.3	010129	THz 22,20
03.7752-0710.4	03.2122-0282.3	010130	THz 22,20
03.7752-0713.4	03.2122-0264.3	010129	THz 22,20
03.7752-0714.4	03.2122-0264.3	010129	THz 22,20
03.7752-0715.4	03.2122-0264.3	010129	THz 22,20
03.7752-0716.4	03.2122-0264.3	010129	THz 22,20
03.7752-0717.4	03.2122-0264.3	010129	THz 22,20
03.7752-0718.4	03.2122-0264.3	010129	THz 22,20
03.7752-0722.4	03.2122-0264.3	010129	THz 22,20
03.7752-0723.4	03.2123-1121.3	010176	THz 23,81
03.7752-0808.4	03.2122-0264.3	010129	THz 22,20
03.7752-0809.4	03.2122-0264.3	010129	THz 22,20
03.7752-0810.4	03.2122-0282.3	010130	THz 22,20

03.7752-0813.4	03.2122-0264.3	010129	THz 22,20
03.7752-0814.4	03.2122-0264.3	010129	THz 22,20
03.7752-0815.4	03.2122-0264.3	010129	THz 22,20
03.7752-0816.4	03.2122-0264.3	010129	THz 22,20
03.7752-0819.4	03.2122-0264.3	010129	THz 22,20
03.7752-0820.4	03.2123-1121.3	010176	THz 23,81
03.7752-0901.4	03.2122-1042.3	010137	THz 22,20
	03.7750-4302.4	300076	9"
03.7752-0902.4	03.2120-3943.3	010532	THz 20,64
	03.7750-4302.4	300076	9"
03.7752-1031.4	03.2123-1484.3	010595	THz 23,81
03.7752-1201.4	03.2122-1042.3	010137	THz 22,20
	03.7750-4902.4	300079	9"
03.7752-1202.4	03.2120-3943.3	010532	THz 20,64
	03.7750-4902.4	300079	9"
03.7752-1204.4	03.2120-3943.3	010532	THz 20,64
	03.7750-4902.4	300079	9"
03.7752-2601.4	03.0101-0025.2	320014	BRES 3/35
	03.2120-3943.3	010532	THz 20,64
	03.7750-5502.4	300081	9"
03.7752-2603.4	03.2120-3943.3	010532	THz 20,64
	03.7750-5502.4	300081	9"
03.7752-2604.4	03.0101-0025.2	320014	BRES 3/35
	03.2120-3943.3	010532	THz 20,64
	03.7750-5502.4	300081	9"
03.7752-2607.4	03.2120-3943.3	010532	THz 20,64
	03.7750-5502.4	300081	9"
03.7752-2608.4	03.2120-3943.3	010532	THz 20,64
	03.7750-5502.4	300081	9"
03.7752-2701.4	03.2120-3943.3	010532	THz 20,64
03.7752-2801.4	03.2122-0264.3	010129	THz 22,20
03.7752-3101.4	03.2120-3943.3	010532	THz 20,64
03.7752-3103.4	03.2120-3943.3	010532	THz 20,64
03.7752-3131.4	03.2122-1184.3	010592	THz 22,20
03.7752-3401.4	03.2122-0264.3	010129	THz 22,20
03.7752-3402.4	03.2122-0282.3	010130	THz 22,20
03.7752-3403.4	03.2123-1121.3	010176	THz 23,81

Bremsgeräte komplett

Booster units complete - Servofreni completi -
Servo-freins complets - Servofreno completo

● Die Nr. befindet sich auf dem im Fahrzeug eingebautem Aggregat.
the number is on the unit build in the car
il numero si trova sull'aggregato montato nella macchina
le numéro se trouve sur la pièce montée dans le véhicule
el n° se encuentra en el equipo montado en el vehículo



03.7752-3405.4	03.2122-0282.3	010130	THz 22,20
03.7752-3501.4	03.2122-0264.3	010129	THz 22,20
03.7752-3502.4	03.2122-0282.3	010130	THz 22,20
03.7752-3504.4	03.2123-1121.3	010176	THz 23,81
03.7752-3510.4	03.2122-0282.3	010130	THz 22,20
03.7752-3731.4	03.2122-1184.3	010592	THz 22,20
03.7752-3831.4	03.2123-1484.3	010595	THz 23,81
03.7752-4302.4	03.2122-1042.3	010137	THz 22,20
	03.7750-4302.4	300076	9"
03.7752-4401.4	03.2123-1121.3	010176	THz 23,81
03.7752-4402.4	03.2123-1121.3	010176	THz 23,81
03.7752-4501.4	03.2123-1121.3	010176	THz 23,81
03.7752-4503.4	03.2123-1121.3	010176	THz 23,81
03.7752-4701.4	03.2120-2031.3	010106	THz 20,64
03.7752-4901.4	03.2122-1042.3	010137	THz 22,20
	03.7750-4902.4	300079	9"
03.7752-5509.4	03.7750-5502.4	300081	9"
03.7752-5510.4	03.7750-5502.4	300081	9"
03.7752-5511.4	03.7750-5502.4	300081	9"
03.7752-5512.4	03.7750-5502.4	300081	9"
03.7752-5513.4	03.7750-5502.4	300081	9"
03.7752-5514.4	03.7750-5502.4	300081	9"
03.7752-6003.4	03.2122-1184.3	010592	THz 22,20
03.7752-6102.4	03.2122-1042.3	010137	THz 22,20
03.7752-6104.4	03.2122-1042.3	010137	THz 22,20
03.7752-6403.4	03.2122-1184.3	010592	THz 22,20
03.7752-6404.4	03.2123-1484.3	010595	THz 23,81
03.7752-6802.4	03.2123-1484.3	010595	THz 23,81
03.7752-6902.4	03.2123-1484.3	010595	THz 23,81
03.7752-6903.4	03.2123-1484.3	010595	THz 23,81
03.7752-7401.4	03.2122-1042.3	010137	THz 22,20
03.7752-8105.4	03.2122-1331.3	010607	THz 22,20

03.7752-8108.4	03.2122-1331.3	010607	THz 22,20
03.7757-0101.4	03.2023-0230.3	010019	THz 23,81/19,05
03.7757-0102.4	03.2023-0825.3	010028	THz 23,81/19,05
03.7757-0201.4	03.2025-0211.3	010034	THz 25,40/19,05
03.7757-0203.4	03.7750-0302.4	300071	9"
03.7757-0204.4	03.7750-0302.4	300071	9"
03.7757-0314.4	03.2023-0642.3	010026	THz 23,81/20,64
03.7757-0319.4	03.2023-0642.3	010026	THz 23,81/20,64
03.7757-0321.4	03.2023-0642.3	010026	THz 23,81/20,64
03.7757-0324.4	03.2023-0642.3	010026	THz 23,81/20,64
03.7762-0101.4	03.2123-8311.3	010192	THz 23,81
	03.7760-0902.4	300088	10"
03.7762-0102.4	03.2122-6911.3	010153	THz 22,20
	03.7760-0902.4	300088	10"
03.7762-0103.4	03.2122-6911.3	010153	THz 22,20
	03.7760-0902.4	300088	10"
03.7762-0104.4	03.7760-0902.4	300088	10"
03.7762-0108.4	03.2120-2082.3	010107	THz 20,64
	03.7760-0902.4	300088	10"
03.7762-0110.4	03.2120-1802.3	010099	THz 20,64
	03.7760-0902.4	300088	10"
03.7762-0112.4	03.2120-1802.3	010099	THz 20,64
	03.7760-0902.4	300088	10"
03.7762-0114.4	03.2020-0402.3	010001	THz 20,64/19,05
	03.7760-0902.4	300088	10"
03.7762-0115.4	03.2120-2082.3	010107	THz 20,64
	03.7760-0902.4	300088	10"
03.7762-0116.4	03.2123-8311.3	010192	THz 23,81
	03.7760-0902.4	300088	10"
03.7762-0117.4	03.7760-0902.4	300088	10"
03.7762-0118.4	03.2123-8311.3	010192	THz 23,81
	03.7760-0902.4	300088	10"
03.7762-0119.4	03.2120-2082.3	010107	THz 20,64
	03.7760-0902.4	300088	10"
03.7762-0120.4	03.2120-2082.3	010107	THz 20,64
	03.7760-0902.4	300088	10"

Bremsgeräte komplett

**Booster units complete - Servofreni completi -
Servo-freins complets - Servofreno completo**

● Die Nr. befindet sich auf dem im Fahrzeug eingebautem Aggregat.
the number is on the unit build in the car
il numero si trova sull'aggregato montato nella macchina
le numéro se trouve sur la pièce montée dans le véhicule
el n° se encuentra en el equipo montado en el vehículo



03.7762-0121.4	03.2120-1802.3 03.7760-0902.4	010099 300088	THz 20,64 10"	03.7762-0704.4	03.2022-1201.3 03.7760-0902.4	010009 300088	THz 22,20/17,46 10"
03.7762-0122.4	03.2120-1802.3 03.7760-0902.4	010099 300088	THz 20,64 10"	03.7762-0705.4	03.2022-1201.3 03.7760-0902.4	010009 300088	THz 22,20/17,46 10"
03.7762-0123.4	03.2020-0402.3 03.7760-0902.4	010001 300088	THz 20,64/19,05 10"	03.7762-0801.4	03.2022-1201.3 03.7760-0902.4	010009 300088	THz 22,20/17,46 10"
03.7762-0124.4	03.7760-0902.4	300088	10"	03.7762-0802.4	03.2022-1201.3 03.7760-0902.4	010009 300088	THz 22,20/17,46 10"
03.7762-0201.4	03.2020-0402.3 03.7760-0902.4	010001 300088	THz 20,64/19,05 10"	03.7762-0901.4	03.2022-1201.3 03.7760-0902.4	010009 300088	THz 22,20/17,46 10"
03.7762-0202.4	03.2120-1802.3 03.7760-0902.4	010099 300088	THz 20,64 10"	03.7762-0902.4	03.2022-1201.3 03.7760-0902.4	010009 300088	THz 22,20/17,46 10"
03.7762-0204.4	03.2120-2082.3 03.7760-0902.4	010107 300088	THz 20,64 10"	03.7762-1001.4	03.2125-3011.3	010211	THz 25,40
03.7762-0301.4	03.2023-0825.3 03.7760-2702.4	010028 300090	THz 23,81/19,05 10"	03.7762-1002.4	03.2125-3011.3	010211	THz 25,40
03.7762-0302.4	03.2023-0825.3 03.7760-2702.4	010028 300090	THz 23,81/19,05 10"	03.7762-1203.4	03.2125-3011.3	010211	THz 25,40
03.7762-0312.4	03.2023-0825.3 03.7760-2702.4	010028 300090	THz 23,81/19,05 10"	03.7762-1204.4	03.2125-3011.3	010211	THz 25,40
03.7762-0313.4	03.2023-0825.3 03.7760-2702.4	010028 300090	THz 23,81/19,05 10"	03.7762-1801.4	03.2125-3011.3	010211	THz 25,40
03.7762-0401.4	03.2023-0262.3 03.7760-0402.4	010020 300087	THz 23,81/20,64 10"	03.7762-1802.4	03.2125-3011.3	010211	THz 25,40
03.7762-0402.4	03.7760-0402.4	300087	10"	03.7762-1901.4	03.2125-3011.3	010211	THz 25,40
03.7762-0501.4	03.2120-1802.3 03.7760-0902.4	010099 300088	THz 20,64 10"	03.7762-1902.4	03.2125-3011.3	010211	THz 25,40
03.7762-0502.4	03.2120-2082.3 03.7760-0902.4	010107 300088	THz 20,64 10"	03.7762-2001.4	03.2125-3011.3	010211	THz 25,40
03.7762-0503.4	03.7760-0902.4	300088	10"	03.7762-2002.4	03.2125-3011.3	010211	THz 25,40
03.7762-0504.4	03.2120-1802.3 03.7760-0902.4	010099 300088	THz 20,64 10"	03.7762-2701.4	03.2023-0825.3 03.7760-2702.4	010028 300090	THz 23,81/19,05 10"
03.7762-0505.4	03.2120-2082.3 03.7760-0902.4	010107 300088	THz 20,64 10"	03.7762-3606.4	03.2023-1084.3 03.7760-3602.4	010591 300176	THz 23,81/20,64 10"
03.7762-0506.4	03.7760-0902.4	300088	10"	03.7762-3607.4	03.2023-1044.3 03.7760-3602.4	010590 300176	THz 23,81/20,64 10"
03.7762-0701.4	03.2022-1201.3 03.7760-0902.4	010009 300088	THz 22,20/17,46 10"	03.7762-3706.4	03.2023-1084.3	010591	THz 23,81/20,64
03.7762-0702.4	03.2022-1201.3 03.7760-0902.4	010009 300088	THz 22,20/17,46 10"	03.7762-3707.4	03.2023-1044.3	010590	THz 23,81/20,64
03.7762-0703.4	03.2022-1201.3 03.7760-0902.4	010009 300088	THz 22,20/17,46 10"	03.7767-0101.4	03.2026-0462.3	010728	THz 26,99/25,40
				03.7767-0102.4	03.2026-0462.3	010728	THz 26,99/25,40
				03.7767-0103.4	03.2026-0512.3	010038	THz 26,99/25,40
				03.7767-0104.4	03.2026-0512.3	010038	THz 26,99/25,40
				03.7767-0105.4	03.2026-0462.3	010728	THz 26,99/25,40

Bremsgeräte komplett

Booster units complete - Servofreni completi - Servo-freins complets - Servofreno completo

● Die Nr. befindet sich auf dem im Fahrzeug eingebautem Aggregat.
the number is on the unit build in the car
il numero si trova sull'aggregato montato nella macchina
le numéro se trouve sur la pièce montée dans le véhicule
el n° se encuentra en el equipo montado en el vehículo



03.7767-0107.4	03.2026-0462.3	010728	THz 26,99/25,40
10.6350-2002.4	10.6123-0522.3	010633	THz 23,81
10.6362-0501.4	10.6360-1003.4	300156	10"
10.6362-0502.4	10.6360-1003.4	300156	10"
10.6362-0503.4	10.6360-1003.4	300156	10"
10.6362-0504.4	10.6360-1003.4	300156	10"
10.6362-1001.4	10.6360-1003.4	300156	10"
10.6362-1002.4	10.6360-1003.4	300156	10"
10.6362-1003.4	10.6360-1003.4	300156	10"
10.6362-1004.4	10.6360-1003.4	300156	10"
10.6362-2001.4	10.6360-2002.4	300143	10"
10.6362-2002.4	10.6360-2002.4	300143	10"



Ⓓ **Reparatursätze**







Ⓔ**N** **Repair kits**

Ⓕ**R** **Nécessaires de réparation**

Ⓔ**S** **Juegos de reparación**







Reparatursätze

Repair kits - Corredi riparazione - Nécessaires de réparation - Juegos de reparación

					
03.2415-0512.3 030001	03.0350-1508.2 071508	Gz Reparatursatz	11.3331-8501.2 220004	11.0101-5402.2 260009 11.0441-3302.2 250004 11.8116-0015.1 390492 11.8171-0008.1 990049	Hülsensatz Dichtungssatz Haltefeder Führungsbolzen
03.2415-0514.3 030002	03.0350-1508.2 071508	Gz Reparatursatz	11.3331-8502.2 220005	11.0101-5402.2 260009 11.0441-3302.2 250004 11.8116-0015.1 390492 11.8171-0008.1 990049	Hülsensatz Dichtungssatz Haltefeder Führungsbolzen
03.2415-0515.3 030003	03.0350-1508.2 071508	Gz Reparatursatz	11.3334-8001.2 220006	11.0101-5407.2 260011 11.0441-3302.2 250004 11.8116-0015.1 390492 11.8171-0008.1 990049	Hülsensatz Dichtungssatz Haltefeder Führungsbolzen
03.2419-3307.3 030014	03.0350-1906.2 071906	Gz Reparatursatz	11.3334-8002.2 220007	11.0101-5407.2 260011 11.0441-3302.2 250004 11.8116-0008.1 990049	Hülsensatz Dichtungssatz Führungsbolzen
03.2419-7800.3 030016	03.0350-1919.2 071919	Gz Reparatursatz	11.3334-9995.2 220008	11.0101-5402.2 260009 11.8171-0008.1 990049	Hülsensatz Führungsbolzen
03.2419-9000.3 030025	03.0350-1919.2 071919	Gz Reparatursatz	11.3334-9996.2 220009	11.0101-5402.2 260009 11.8171-0008.1 990049	Hülsensatz Führungsbolzen
03.2515-1101.3 040001	03.0450-1502.2 081502	Nz Reparatursatz	11.3341-8501.2 220010	11.0101-5402.2 260009 11.8116-0066.1 390577 11.8171-0008.1 990049	Hülsensatz Haltefeder Führungsbolzen
03.2520-1201.3 040011	03.0450-2006.2 082006	Nz Reparatursatz	11.3341-8502.2 220011	11.0101-5402.2 260009 11.8116-0066.1 390577 11.8171-0008.1 990049	Hülsensatz Haltefeder Führungsbolzen
03.2523-0811.3 040019	03.0450-2311.2 082311	Nz Reparatursatz	11.3351-8501.2 220012	11.0101-5402.2 260009 11.8116-0015.1 390492 11.8171-0008.1 990049	Hülsensatz Haltefeder Führungsbolzen
03.2525-1802.3 040025	03.0450-2509.2 082509	Nz Reparatursatz	11.3351-8502.2 220013	11.0101-5402.2 260009 11.8116-0015.1 390492 11.8171-0008.1 990049	Hülsensatz Haltefeder Führungsbolzen
03.2525-2602.3 040029	03.0450-2510.2 082510	Nz Reparatursatz	11.3351-8503.2 220014	11.0101-5402.2 260009 11.8116-0015.1 390492 11.8171-0008.1 990049	Hülsensatz Haltefeder Führungsbolzen
03.2525-2711.3 040030	03.0450-2510.2 082510	Nz Reparatursatz	11.3351-8504.2 220015	11.0101-5402.2 260009 11.8116-0015.1 390492 11.8171-0008.1 990049	Hülsensatz Haltefeder Führungsbolzen
03.2528-1301.3 040032	03.0450-2805.2 082805	Nz Reparatursatz	11.3361-8503.2 220016	11.0101-5402.2 260009 11.0441-3602.2 250008 11.8116-0066.1 390577 11.8171-0008.1 990049	Hülsensatz Dichtungssatz Haltefeder Führungsbolzen
03.2538-0102.3 040033	03.0450-3801.2 083801	Nz Reparatursatz	11.3361-8504.2 220017	11.0101-5402.2 260009 11.0441-3602.2 250008 11.8116-0066.1 390577 11.8171-0008.1 990049	Hülsensatz Dichtungssatz Haltefeder Führungsbolzen
03.2538-0104.3 040035	03.0450-3801.2 083801	Nz Reparatursatz	11.3361-8505.2 220024	11.0101-5402.2 260009 11.0441-3602.2 250008 11.8171-0008.1 990049	Hülsensatz Dichtungssatz Führungsbolzen
03.2728-2101.3 020008	03.0402-1128.2 060027	Rz Reparatursatz	11.3361-8506.2 220025	11.0101-5402.2 260009 11.0441-3602.2 250008 11.8171-0008.1 990049	Hülsensatz Dichtungssatz Führungsbolzen
03.2728-2201.3 020009	03.0402-1128.2 060027	Rz Reparatursatz			
03.3128-1401.3 010295	03.0370-1828.2 051828	Hz Reparatursatz			
03.3131-2201.3 010300	03.0370-1131.2 051131	Hz Reparatursatz			
03.3131-2401.3 010303	03.0370-1131.2 051131	Hz Reparatursatz			
03.3138-2001.3 010310	03.0370-1038.2 051038 03.0370-9998.2 059998	Hz Reparatursatz Hz Rep. Satz,-Kolben			
03.3219-0102.3 020036	03.0470-2619.2 060051	Rz Dichtungssatz			
03.3219-0411.3 020038	03.0470-2619.2 060051	Rz Dichtungssatz			
03.3231-3401.3 020120	03.0401-2031.2 052031	Rz Reparatursatz			
03.3241-1801.3 020130	03.0403-0341.2 060031	Rz Reparatursatz			
03.3241-1802.3 020131	03.0403-0341.2 060031	Rz Reparatursatz			
03.3508-2801.2 310092	03.0101-3501.2 390001	Behälter Rep. Satz			
10.6360-1602.4 300194	03.0655-0003.2 370003	Wegsensor			
11.1361-0004.2 200001	11.0441-3601.2 250007	Dichtungssatz			
11.1441-8035.2 200002	11.0441-4402.2 250014	Dichtungssatz			
11.1441-8036.2 200003	11.0441-4402.2 250014	Dichtungssatz			
11.1541-0013.2 200005	11.0441-5401.2 250027	Dichtungssatz			
11.3331-8016.2 220003	11.0101-5402.2 260009 11.0441-3302.2 250004 11.8171-0008.1 990049	Hülsensatz Dichtungssatz Führungsbolzen			







Reparatursätze

Repair kits - Corredi riparazione - Nécessaires de réparation - Juegos de reparación

  		  	
11.3361-9975.2 220281	11.0101-5407.2 260011 Hülsensatz 11.0441-3602.2 250008 Dichtungssatz 11.8116-0073.1 390498 Haltefeder 11.8171-0008.1 990049 Führungsbolzen	11.3401-8505.2 220032	11.0101-5402.2 260009 Hülsensatz 11.0441-4002.2 250011 Dichtungssatz 11.8171-0008.1 990049 Führungsbolzen
11.3361-9976.2 220282	11.0101-5407.2 260011 Hülsensatz 11.0441-3602.2 250008 Dichtungssatz 11.8116-0073.1 390498 Haltefeder 11.8171-0008.1 990049 Führungsbolzen	11.3401-8506.2 220033	11.0101-5402.2 260009 Hülsensatz 11.0441-4002.2 250011 Dichtungssatz 11.8171-0008.1 990049 Führungsbolzen
11.3381-8501.2 220018	11.0101-5402.2 260009 Hülsensatz 11.0441-3802.2 250009 Dichtungssatz 11.8116-0066.1 390577 Haltefeder 11.8171-0008.1 990049 Führungsbolzen	11.3401-8507.2 220034	11.0101-5402.2 260009 Hülsensatz 11.0441-4002.2 250011 Dichtungssatz 11.8116-0296.1 390445 Haltefeder 11.8171-0008.1 990049 Führungsbolzen
11.3381-8502.2 220019	11.0101-5402.2 260009 Hülsensatz 11.0441-3802.2 250009 Dichtungssatz 11.8116-0066.1 390577 Haltefeder 11.8171-0008.1 990049 Führungsbolzen	11.3401-8508.2 220035	11.0101-5402.2 260009 Hülsensatz 11.0441-4002.2 250011 Dichtungssatz 11.8116-0296.1 390445 Haltefeder 11.8171-0008.1 990049 Führungsbolzen
11.3381-8503.2 220020	11.0101-5402.2 260009 Hülsensatz 11.0441-3803.2 250010 Dichtungssatz 11.8116-0066.1 390577 Haltefeder 11.8171-0008.1 990049 Führungsbolzen	11.3401-8511.2 220026	11.0101-5402.2 260009 Hülsensatz 11.0441-4002.2 250011 Dichtungssatz 11.8116-0296.1 390445 Haltefeder 11.8171-0008.1 990049 Führungsbolzen
11.3381-8504.2 220021	11.0101-5402.2 260009 Hülsensatz 11.0441-3803.2 250010 Dichtungssatz 11.8116-0066.1 390577 Haltefeder 11.8171-0008.1 990049 Führungsbolzen	11.3401-8512.2 220027	11.0101-5402.2 260009 Hülsensatz 11.0441-4002.2 250011 Dichtungssatz 11.8116-0296.1 390445 Haltefeder 11.8171-0008.1 990049 Führungsbolzen
11.3381-8505.2 220022	11.0101-5402.2 260009 Hülsensatz 11.0441-3802.2 250009 Dichtungssatz 11.8116-0066.1 390577 Haltefeder 11.8171-0008.1 990049 Führungsbolzen	11.3401-8513.2 220036	11.0101-5402.2 260009 Hülsensatz 11.0441-4002.2 250011 Dichtungssatz 11.8116-0315.2 390447 Haltefeder 11.8171-0008.1 990049 Führungsbolzen
11.3381-8506.2 220023	11.0101-5402.2 260009 Hülsensatz 11.0441-3802.2 250009 Dichtungssatz 11.8116-0066.1 390577 Haltefeder 11.8171-0008.1 990049 Führungsbolzen	11.3401-8514.2 220037	11.0101-5402.2 260009 Hülsensatz 11.0441-4002.2 250011 Dichtungssatz 11.8116-0315.2 390447 Haltefeder 11.8171-0008.1 990049 Führungsbolzen
11.3401-0055.2 220519	11.0101-5407.2 260011 Hülsensatz 11.8116-0143.1 390513 Haltefeder 11.8171-0008.1 990049 Führungsbolzen	11.3421-8501.2 220405	11.0101-6004.2 260014 Hülsensatz 11.8171-0008.1 990049 Führungsbolzen
11.3401-0056.2 220520	11.0101-5407.2 260011 Hülsensatz 11.8116-0143.1 390513 Haltefeder 11.8171-0008.1 990049 Führungsbolzen	11.3421-8502.2 220406	11.0101-6004.2 260014 Hülsensatz 11.8171-0008.1 990049 Führungsbolzen
11.3401-8501.2 220028	11.0101-5402.2 260009 Hülsensatz 11.0441-4002.2 250011 Dichtungssatz 11.8116-0066.1 390577 Haltefeder 11.8171-0008.1 990049 Führungsbolzen	11.3451-8501.2 220389	11.0101-5407.2 260011 Hülsensatz 11.0101-5409.2 260035 Hülsensatz 11.8171-0008.1 990049 Führungsbolzen
11.3401-8502.2 220029	11.0101-5402.2 260009 Hülsensatz 11.0441-4002.2 250011 Dichtungssatz 11.8116-0066.1 390577 Haltefeder 11.8171-0008.1 990049 Führungsbolzen	11.3451-8502.2 220390	11.0101-5407.2 260011 Hülsensatz 11.0101-5409.2 260035 Hülsensatz 11.8171-0008.1 990049 Führungsbolzen
11.3401-8503.2 220030	11.0101-5402.2 260009 Hülsensatz 11.0441-4002.2 250011 Dichtungssatz 11.8116-0066.1 390577 Haltefeder 11.8171-0008.1 990049 Führungsbolzen	11.3456-8003.2 220038	11.0441-4501.2 250015 Dichtungssatz
11.3401-8504.2 220031	11.0101-5402.2 260009 Hülsensatz 11.0441-4002.2 250011 Dichtungssatz 11.8116-0066.1 390577 Haltefeder 11.8171-0008.1 990049 Führungsbolzen	11.3456-8004.2 220039	11.0441-4501.2 250015 Dichtungssatz
		11.3481-0106.2 220040	11.0101-4802.2 260007 Hülsensatz 11.0441-4810.2 250023 Dichtungssatz
		11.3481-0107.2 220041	11.0101-4802.2 260007 Hülsensatz
		11.3481-0108.2 220042	11.0101-4802.2 260007 Hülsensatz
		11.3481-0167.2 220285	11.0101-5407.2 260011 Hülsensatz 11.0441-4811.2 250024 Dichtungssatz
		11.3481-0168.2 220286	11.0101-5407.2 260011 Hülsensatz 11.0441-4811.2 250024 Dichtungssatz







Reparatursätze

Repair kits - Corredi riparazione - Nécessaires de réparation - Juegos de reparación

					
11.3481-8014.2 220045	11.0101-4802.2 260007 11.0441-4803.2 250018	Hülsensatz Dichtungssatz	11.3481-8507.2 220065	11.0101-5402.2 260009 11.0441-4810.2 250022 11.8171-0008.1 990049	Hülsensatz Dichtungssatz Führungsbolzen
11.3481-8015.2 220046	11.0101-4802.2 260007 11.0441-4803.2 250018	Hülsensatz Dichtungssatz	11.3481-8508.2 220066	11.0101-5402.2 260009 11.0441-4810.2 250023 11.8171-0008.1 990049	Hülsensatz Dichtungssatz Führungsbolzen
11.3481-8016.2 220047	11.0101-4802.2 260007 11.0441-4803.2 250018	Hülsensatz Dichtungssatz	11.3481-8509.2 220329	11.0101-4801.2 260006 11.0441-4808.2 250022 24.0102-4801.2 260085	Hülsensatz Dichtungssatz Hülsensatz+Schrauben
11.3481-8029.2 220048	11.0101-4802.2 260007 11.0441-4803.2 250018	Hülsensatz Dichtungssatz	11.3481-8510.2 220330	11.0101-4801.2 260006 11.0441-4808.2 250022 24.0102-4801.2 260085	Hülsensatz Dichtungssatz Hülsensatz+Schrauben
11.3481-8030.2 220049	11.0101-4802.2 260007 11.0441-4803.2 250018	Hülsensatz Dichtungssatz	11.3481-8511.2 220337	11.0101-5407.2 260011 11.0441-4805.2 250020 11.8171-0008.1 990049	Hülsensatz Dichtungssatz Führungsbolzen
11.3481-8037.2 220050	11.0101-5407.2 260011 11.0441-4805.2 250020 11.8171-0008.1 990049	Hülsensatz Dichtungssatz Führungsbolzen	11.3481-8512.2 220338	11.0101-5407.2 260011 11.0441-4805.2 250020 11.8171-0008.1 990049	Hülsensatz Dichtungssatz Führungsbolzen
11.3481-8038.2 220051	11.0101-5407.2 260011 11.0441-4805.2 250020 11.8171-0008.1 990049	Hülsensatz Dichtungssatz Führungsbolzen	11.3481-8513.2 220335	11.0101-5407.2 260011 11.0230-0687.1 260106 11.0441-4805.2 250020 11.8171-0008.1 990049	Hülsensatz Halter Dichtungssatz Führungsbolzen
11.3481-8075.2 220053	11.0101-5407.2 260011 11.0441-4811.2 250024 11.8171-0008.1 990049	Hülsensatz Dichtungssatz Führungsbolzen	11.3481-8514.2 220336	11.0101-5407.2 260011 11.0230-0687.1 260106 11.0441-4805.2 250020 11.8171-0008.1 990049	Hülsensatz Halter Dichtungssatz Führungsbolzen
11.3481-8076.2 220054	11.0101-5407.2 260011 11.0441-4811.2 250024 11.8171-0008.1 990049	Hülsensatz Dichtungssatz Führungsbolzen	11.3481-8515.2 220365	11.0101-5407.2 260011 11.8171-0008.1 990049	Hülsensatz Führungsbolzen
11.3481-8083.2 220057	11.0101-5407.2 260011 11.0441-4811.2 250024 11.8116-0129.1 390591 11.8171-0008.1 990049	Hülsensatz Dichtungssatz Haltefeder Führungsbolzen	11.3481-8516.2 220366	11.0101-5407.2 260011 11.8171-0008.1 990049	Hülsensatz Führungsbolzen
11.3481-8084.2 220058	11.0101-5407.2 260011 11.0441-4811.2 250024 11.8116-0129.1 390591 11.8171-0008.1 990049	Hülsensatz Dichtungssatz Haltefeder Führungsbolzen	11.3481-9833.2 220561	11.0101-5407.2 260011 11.0441-4811.2 250024 11.8116-0129.1 390591 11.8171-0008.1 990049	Hülsensatz Dichtungssatz Haltefeder Führungsbolzen
11.3481-8085.2 220059	11.0101-5407.2 260011 11.0441-4811.2 250024 11.8116-0129.1 390591 11.8171-0008.1 990049	Hülsensatz Dichtungssatz Haltefeder Führungsbolzen	11.3481-9834.2 220562	11.0101-5407.2 260011 11.0441-4811.2 250024 11.8116-0129.1 390591 11.8171-0008.1 990049	Hülsensatz Dichtungssatz Haltefeder Führungsbolzen
11.3481-8086.2 220060	11.0101-5407.2 260011 11.0441-4811.2 250024 11.8116-0129.1 390591 11.8171-0008.1 990049	Hülsensatz Dichtungssatz Haltefeder Führungsbolzen	11.3521-8003.2 220070	11.0101-4802.2 260007	Hülsensatz
11.3481-8503.2 220061	11.0101-4801.2 260006 11.0441-4804.2 250019 11.0441-4808.2 250022 24.0102-4801.2 260085	Hülsensatz Dichts. (+Sich. Ring) Dichtungssatz Hülsensatz+Schrauben	11.3521-8004.2 220071	11.0101-4802.2 260007	Hülsensatz
11.3481-8504.2 220062	11.0101-4801.2 260006 11.0441-4804.2 250019 11.0441-4808.2 250022 24.0102-4801.2 260085	Hülsensatz Dichts. (+Sich. Ring) Dichtungssatz Hülsensatz+Schrauben	11.3521-8011.2 220072	11.0441-5202.2 250026	Dichtungssatz
11.3481-8505.2 220063	11.0101-5407.2 260011 11.0441-4805.2 250020 11.8171-0008.1 990049	Hülsensatz Dichtungssatz Führungsbolzen	11.3521-8012.2 220073	11.0441-5202.2 250026	Dichtungssatz
11.3481-8506.2 220064	11.0101-5407.2 260011 11.0441-4805.2 250020 11.8171-0008.1 990049	Hülsensatz Dichtungssatz Führungsbolzen	11.3521-8501.2 220391	11.0101-5407.2 260011 11.0101-5409.2 260035 11.8171-0008.1 990049	Hülsensatz Hülsensatz Führungsbolzen
			11.3521-8502.2 220392	11.0101-5407.2 260011 11.0101-5409.2 260035 11.8171-0008.1 990049	Hülsensatz Hülsensatz Führungsbolzen
			11.3541-8017.2 220076	11.0101-5407.2 260011 11.0441-5402.2 250028 11.8171-0008.1 990049	Hülsensatz Dichtungssatz Führungsbolzen







Reparatursätze

Repair kits - Corredi riparazione - Nécessaires de réparation - Juegos de reparación

					
11.3541-8018.2 220077	11.0101-5407.2 260011 Hülsensatz 11.0441-5402.2 250028 Dichtungssatz 11.8171-0008.1 990049 Führungsbolzen		11.3541-8102.2 220092	11.0101-5407.2 260011 Hülsensatz 11.0441-5402.2 250028 Dichtungssatz 11.8116-0097.1 390590 Haltefeder 11.8171-0008.1 990049 Führungsbolzen	
11.3541-8039.2 220078	11.0441-5404.2 250029 Dichtungssatz		11.3541-8105.2 220339	11.0101-5407.2 260011 Hülsensatz 11.8171-0008.1 990049 Führungsbolzen	
11.3541-8040.2 220079	11.0441-5404.2 250029 Dichtungssatz		11.3541-8106.2 220340	11.0101-5407.2 260011 Hülsensatz 11.8171-0008.1 990049 Führungsbolzen	
11.3541-8045.2 220080	11.0101-5407.2 260011 Hülsensatz 11.0441-5405.2 250030 Dichtungssatz 11.8171-0008.1 990049 Führungsbolzen		11.3541-8501.2 220093	11.0101-5409.2 260035 Hülsensatz 11.0441-5405.2 250030 Dichtungssatz 11.8171-0008.1 990049 Führungsbolzen	
11.3541-8061.2 220081	11.0101-5407.2 260011 Hülsensatz 11.0441-5402.2 250028 Dichtungssatz 11.8171-0008.1 990049 Führungsbolzen		11.3541-8502.2 220094	11.0101-5409.2 260035 Hülsensatz 11.0441-5405.2 250030 Dichtungssatz 11.8171-0008.1 990049 Führungsbolzen	
11.3541-8062.2 220082	11.0101-5407.2 260011 Hülsensatz 11.0441-5402.2 250028 Dichtungssatz 11.8171-0008.1 990049 Führungsbolzen		11.3541-8503.2 220095	11.0101-5409.2 260035 Hülsensatz 11.0441-5405.2 250030 Dichtungssatz 11.8171-0008.1 990049 Führungsbolzen	
11.3541-8065.2 220083	11.0441-5404.2 250029 Dichtungssatz		11.3541-8504.2 220096	11.0101-5409.2 260035 Hülsensatz 11.0441-5405.2 250030 Dichtungssatz 11.8171-0008.1 990049 Führungsbolzen	
11.3541-8066.2 220084	11.0441-5404.2 250029 Dichtungssatz		11.3541-8505.2 220097	11.0101-5407.2 260011 Hülsensatz 11.0441-5402.2 250028 Dichtungssatz 11.8171-0008.1 990049 Führungsbolzen	
11.3541-8067.2 220085	11.0101-5407.2 260011 Hülsensatz 11.0441-5405.2 250030 Dichtungssatz		11.3541-8506.2 220098	11.0101-5407.2 260011 Hülsensatz 11.0441-5402.2 250028 Dichtungssatz 11.8171-0008.1 990049 Führungsbolzen	
11.3541-8068.2 220086	11.0101-5407.2 260011 Hülsensatz 11.0441-5405.2 250030 Dichtungssatz		11.3541-8507.2 220099	11.0101-5407.2 260011 Hülsensatz 11.0441-5402.2 250028 Dichtungssatz 11.8171-0008.1 990049 Führungsbolzen	
11.3541-8083.2 220241	11.0101-5407.2 260011 Hülsensatz 11.8116-0292.1 390521 Haltefeder 11.8171-0008.1 990049 Führungsbolzen		11.3541-8508.2 220100	11.0101-5407.2 260011 Hülsensatz 11.0441-5402.2 250028 Dichtungssatz 11.8171-0008.1 990049 Führungsbolzen	
11.3541-8084.2 220242	11.0101-5407.2 260011 Hülsensatz 11.8116-0292.1 390521 Haltefeder 11.8171-0008.1 990049 Führungsbolzen		11.3541-8509.2 220101	11.0101-5407.2 260011 Hülsensatz 11.0441-5402.2 250028 Dichtungssatz 11.8171-0008.1 990049 Führungsbolzen	
11.3541-8085.2 220287	11.0101-5407.2 260011 Hülsensatz 11.8116-0129.1 390591 Haltefeder 11.8116-0292.1 390521 Haltefeder 11.8171-0008.1 990049 Führungsbolzen		11.3541-8510.2 220102	11.0101-5407.2 260011 Hülsensatz 11.0441-5402.2 250028 Dichtungssatz 11.8171-0008.1 990049 Führungsbolzen	
11.3541-8086.2 220288	11.0101-5407.2 260011 Hülsensatz 11.8116-0129.1 390591 Haltefeder 11.8116-0292.1 390521 Haltefeder 11.8171-0008.1 990049 Führungsbolzen		11.3541-8511.2 220103	11.0101-5402.2 260009 Hülsensatz 11.0441-5402.2 250028 Dichtungssatz 11.8116-0091.1 390502 Haltefeder 11.8171-0008.1 990049 Führungsbolzen	
11.3541-8089.2 220087	11.0101-5407.2 260011 Hülsensatz 11.0441-5402.2 250028 Dichtungssatz 11.8171-0008.1 990049 Führungsbolzen		11.3541-8512.2 220104	11.0101-5402.2 260009 Hülsensatz 11.0441-5402.2 250028 Dichtungssatz 11.8116-0091.1 390502 Haltefeder 11.8171-0008.1 990049 Führungsbolzen	
11.3541-8090.2 220088	11.0101-5407.2 260011 Hülsensatz 11.0441-5402.2 250028 Dichtungssatz 11.8171-0008.1 990049 Führungsbolzen		11.3541-8513.2 220105	11.0101-5402.2 260009 Hülsensatz 11.0441-5402.2 250028 Dichtungssatz 11.8171-0008.1 990049 Führungsbolzen	
11.3541-8091.2 220089	11.0101-5407.2 260011 Hülsensatz 11.0441-5402.2 250028 Dichtungssatz 11.8171-0008.1 990049 Führungsbolzen		11.3541-8514.2 220106	11.0101-5402.2 260009 Hülsensatz 11.0441-5402.2 250028 Dichtungssatz 11.8171-0008.1 990049 Führungsbolzen	
11.3541-8092.2 220090	11.0101-5407.2 260011 Hülsensatz 11.0441-5402.2 250028 Dichtungssatz 11.8171-0008.1 990049 Führungsbolzen				
11.3541-8101.2 220091	11.0101-5407.2 260011 Hülsensatz 11.0441-5402.2 250028 Dichtungssatz 11.8116-0097.1 390590 Haltefeder 11.8171-0008.1 990049 Führungsbolzen				







Reparatursätze

Repair kits - Corredi riparazione - Nécessaires de réparation - Juegos de reparación

	 		 
11.3541-8515.2 220107	11.0101-5402.2 260009 Hülsensatz 11.0441-5402.2 250028 Dichtungssatz 11.8171-0008.1 990049 Führungsbolzen	11.3571-8010.2 220120	11.0101-5407.2 260011 Hülsensatz 11.0441-5702.2 250033 Dichtungssatz
11.3541-8516.2 220108	11.0101-5402.2 260009 Hülsensatz 11.0441-5402.2 250028 Dichtungssatz 11.8171-0008.1 990049 Führungsbolzen	11.3571-8501.2 220121	11.0101-5402.2 260009 Hülsensatz 11.0101-5407.2 260011 Hülsensatz 11.0441-5702.2 250033 Dichtungssatz 11.8116-0091.1 390502 Haltefeder 11.8171-0008.1 990049 Führungsbolzen
11.3541-8517.2 220109	11.0101-5402.2 260009 Hülsensatz 11.0441-5402.2 250028 Dichtungssatz 11.8116-0091.1 390502 Haltefeder 11.8171-0008.1 990049 Führungsbolzen	11.3571-8502.2 220122	11.0101-5402.2 260009 Hülsensatz 11.0101-5407.2 260011 Hülsensatz 11.0441-5702.2 250033 Dichtungssatz 11.8116-0091.1 390502 Haltefeder 11.8171-0008.1 990049 Führungsbolzen
11.3541-8518.2 220110	11.0101-5402.2 260009 Hülsensatz 11.0441-5402.2 250028 Dichtungssatz 11.8116-0091.1 390502 Haltefeder 11.8171-0008.1 990049 Führungsbolzen	11.3571-8503.2 220123	11.0101-5402.2 260009 Hülsensatz 11.0441-5702.2 250033 Dichtungssatz 11.8116-0091.1 390502 Haltefeder 11.8171-0008.1 990049 Führungsbolzen
11.3541-8519.2 220111	11.0101-5409.2 260035 Hülsensatz 11.0441-5405.2 250030 Dichtungssatz	11.3571-8504.2 220124	11.0101-5402.2 260009 Hülsensatz 11.0441-5702.2 250033 Dichtungssatz 11.8116-0091.1 390502 Haltefeder 11.8171-0008.1 990049 Führungsbolzen
11.3541-8520.2 220112	11.0101-5409.2 260035 Hülsensatz 11.0441-5405.2 250030 Dichtungssatz	11.3571-8505.2 220125	11.0101-5409.2 260035 Hülsensatz 11.0441-5704.2 250034 Dichtungssatz 11.8116-0143.1 390513 Haltefeder 11.8171-0008.1 990049 Führungsbolzen
11.3541-8521.2 220113	11.0101-5409.2 260035 Hülsensatz 11.0441-5405.2 250030 Dichtungssatz	11.3571-8506.2 220126	11.0101-5409.2 260035 Hülsensatz 11.0441-5704.2 250034 Dichtungssatz 11.8116-0143.1 390513 Haltefeder 11.8171-0008.1 990049 Führungsbolzen
11.3541-8522.2 220114	11.0101-5409.2 260035 Hülsensatz 11.0441-5405.2 250030 Dichtungssatz	11.3571-8507.2 220127	11.0101-5409.2 260035 Hülsensatz 11.0441-5704.2 250034 Dichtungssatz 11.8116-0143.1 390513 Haltefeder 11.8170-0306.1 260102 Halter 11.8171-0008.1 990049 Führungsbolzen
11.3541-8523.2 220115	11.0101-5409.2 260035 Hülsensatz 11.0441-5409.2 250031 Dichtungssatz 11.8116-0143.1 390513 Haltefeder 11.8170-0306.1 260102 Halter 11.8171-0008.1 990049 Führungsbolzen	11.3571-8508.2 220128	11.0101-5409.2 260035 Hülsensatz 11.0441-5704.2 250034 Dichtungssatz 11.8116-0143.1 390513 Haltefeder 11.8170-0306.1 260102 Halter 11.8171-0008.1 990049 Führungsbolzen
11.3541-8524.2 220116	11.0101-5409.2 260035 Hülsensatz 11.0441-5409.2 250031 Dichtungssatz 11.8116-0143.1 390513 Haltefeder 11.8170-0306.1 260102 Halter 11.8171-0008.1 990049 Führungsbolzen	11.3571-8509.2 220313	11.0101-5407.2 260011 Hülsensatz 11.8171-0008.1 990049 Führungsbolzen
11.3541-8529.2 220341	11.0101-5407.2 260011 Hülsensatz 11.0441-5402.2 250028 Dichtungssatz 11.8171-0008.1 990049 Führungsbolzen	11.3571-8510.2 220314	11.0101-5407.2 260011 Hülsensatz 11.8171-0008.1 990049 Führungsbolzen
11.3541-8530.2 220342	11.0101-5407.2 260011 Hülsensatz 11.0441-5402.2 250028 Dichtungssatz 11.8171-0008.1 990049 Führungsbolzen	11.3571-8511.2 220315	11.0101-5407.2 260011 Hülsensatz 11.8171-0008.1 990049 Führungsbolzen
11.3541-8531.2 220367	11.0101-5407.2 260011 Hülsensatz 11.8171-0008.1 990049 Führungsbolzen	11.3571-8512.2 220316	11.0101-5407.2 260011 Hülsensatz 11.8171-0008.1 990049 Führungsbolzen
11.3541-8532.2 220368	11.0101-5407.2 260011 Hülsensatz 11.8171-0008.1 990049 Führungsbolzen	11.3571-8515.2 220333	11.0101-5409.2 260035 Hülsensatz 11.0441-5704.2 250034 Dichtungssatz 11.8171-0008.1 990049 Führungsbolzen
11.3571-8007.2 220117	11.0101-5407.2 260011 Hülsensatz 11.0441-5702.2 250033 Dichtungssatz 11.8116-0073.1 390498 Haltefeder 11.8171-0008.1 990049 Führungsbolzen	11.3571-8516.2 220334	11.0101-5409.2 260035 Hülsensatz 11.0441-5704.2 250034 Dichtungssatz 11.8171-0008.1 990049 Führungsbolzen
11.3571-8008.2 220118	11.0101-5407.2 260011 Hülsensatz 11.0441-5702.2 250033 Dichtungssatz 11.8116-0073.1 390498 Haltefeder 11.8171-0008.1 990049 Führungsbolzen		
11.3571-8009.2 220119	11.0101-5407.2 260011 Hülsensatz 11.0441-5702.2 250033 Dichtungssatz		







Reparatursätze

Repair kits - Corredi riparazione - Nécessaires de réparation - Juegos de reparación

					
11.3571-8517.2 220321	11.0101-5409.2 260035 Hülsensatz 11.0441-5704.2 250034 Dichtungssatz 11.8116-0143.1 390513 Haltefeder 11.8171-0008.1 990049 Führungsbolzen		11.3601-8049.3 220327	11.0441-6007.2 250146 Dichtungssatz	
11.3571-8518.2 220322	11.0101-5409.2 260035 Hülsensatz 11.0441-5704.2 250034 Dichtungssatz 11.8116-0143.1 390513 Haltefeder 11.8171-0008.1 990049 Führungsbolzen		11.3601-8050.3 220328	11.0441-6007.2 250146 Dichtungssatz	
11.3571-8521.2 220319	11.0101-5409.2 260035 Hülsensatz 11.0441-5704.2 250034 Dichtungssatz 11.8116-0143.1 390513 Haltefeder 11.8170-0306.1 260102 Halter 11.8171-0008.1 990049 Führungsbolzen		11.3601-8063.2 220135	11.0101-5407.2 260011 Hülsensatz 11.0441-6007.2 250146 Dichtungssatz 11.8116-0073.1 390498 Haltefeder 11.8171-0008.1 990049 Führungsbolzen	
11.3571-8522.2 220320	11.0101-5409.2 260035 Hülsensatz 11.0441-5704.2 250034 Dichtungssatz 11.8116-0143.1 390513 Haltefeder 11.8170-0306.1 260102 Halter 11.8171-0008.1 990049 Führungsbolzen		11.3601-8064.2 220136	11.0101-5407.2 260011 Hülsensatz 11.0441-6007.2 250146 Dichtungssatz 11.8116-0073.1 390498 Haltefeder 11.8171-0008.1 990049 Führungsbolzen	
11.3571-8523.2 220343	11.0101-5407.2 260011 Hülsensatz 11.0101-5409.2 260035 Hülsensatz 11.0441-5704.2 250034 Dichtungssatz 11.8116-0143.1 390513 Haltefeder 11.8171-0008.1 990049 Führungsbolzen		11.3601-8065.2 220137	11.0101-5407.2 260011 Hülsensatz 11.0441-6003.2 250037 Dichtungssatz 11.8171-0008.1 990049 Führungsbolzen	
11.3571-8524.2 220344	11.0101-5407.2 260011 Hülsensatz 11.0101-5409.2 260035 Hülsensatz 11.0441-5704.2 250034 Dichtungssatz 11.8116-0143.1 390513 Haltefeder 11.8171-0008.1 990049 Führungsbolzen		11.3601-8066.2 220138	11.0101-5407.2 260011 Hülsensatz 11.0441-6003.2 250037 Dichtungssatz 11.8171-0008.1 990049 Führungsbolzen	
11.3571-8525.2 220363	11.0101-5407.2 260011 Hülsensatz 11.0441-5704.2 250034 Dichtungssatz 11.8116-0292.1 390521 Haltefeder 11.8171-0008.1 990049 Führungsbolzen		11.3601-8067.2 220139	11.0101-5407.2 260011 Hülsensatz 11.0441-6007.2 250146 Dichtungssatz 11.8171-0008.1 990049 Führungsbolzen	
11.3571-8526.2 220364	11.0101-5407.2 260011 Hülsensatz 11.0441-5704.2 250034 Dichtungssatz 11.8116-0292.1 390521 Haltefeder 11.8171-0008.1 990049 Führungsbolzen		11.3601-8068.2 220140	11.0101-5407.2 260011 Hülsensatz 11.0441-6007.2 250146 Dichtungssatz 11.8171-0008.1 990049 Führungsbolzen	
11.3601-0011.2 220129	11.0101-5407.2 260011 Hülsensatz 11.0441-6003.2 250037 Dichtungssatz 11.8171-0008.1 990049 Führungsbolzen		11.3601-8071.2 220141	11.0101-5407.2 260011 Hülsensatz 11.0441-6007.2 250146 Dichtungssatz 11.8171-0008.1 990049 Führungsbolzen	
11.3601-0012.2 220130	11.0101-5407.2 260011 Hülsensatz 11.0441-6003.2 250037 Dichtungssatz 11.8171-0008.1 990049 Führungsbolzen		11.3601-8072.2 220142	11.0101-5407.2 260011 Hülsensatz 11.0441-6007.2 250146 Dichtungssatz 11.8171-0008.1 990049 Führungsbolzen	
11.3601-0073.2 220131	11.0101-5407.2 260011 Hülsensatz 11.0441-6003.2 250037 Dichtungssatz 11.8171-0008.1 990049 Führungsbolzen		11.3601-8073.2 220143	11.0101-5407.2 260011 Hülsensatz 11.0441-6007.2 250146 Dichtungssatz 11.8171-0008.1 990049 Führungsbolzen	
11.3601-0074.2 220132	11.0101-5407.2 260011 Hülsensatz 11.0441-6003.2 250037 Dichtungssatz 11.8171-0008.1 990049 Führungsbolzen		11.3601-8074.2 220144	11.0101-5407.2 260011 Hülsensatz 11.0441-6007.2 250146 Dichtungssatz 11.8171-0008.1 990049 Führungsbolzen	
11.3601-8001.2 220133	11.0101-5407.2 260011 Hülsensatz 11.0441-6003.2 250037 Dichtungssatz 11.8116-0052.1 390496 Haltefeder 11.8171-0008.1 990049 Führungsbolzen		11.3601-8501.2 220145	11.0101-5402.2 260009 Hülsensatz 11.0230-0020.2 260023 Haltersatz 11.0441-6003.2 250037 Dichtungssatz 11.8116-0083.1 390501 Haltefeder 11.8171-0008.1 990049 Führungsbolzen	
11.3601-8002.2 220134	11.0101-5407.2 260011 Hülsensatz 11.0441-6003.2 250037 Dichtungssatz 11.8116-0052.1 390496 Haltefeder 11.8171-0008.1 990049 Führungsbolzen		11.3601-8502.2 220146	11.0101-5402.2 260009 Hülsensatz 11.0230-0020.2 260023 Haltersatz 11.0441-6003.2 250037 Dichtungssatz 11.8116-0083.1 390501 Haltefeder 11.8171-0008.1 990049 Führungsbolzen	
			11.3601-8503.2 220147	11.0101-5402.2 260009 Hülsensatz 11.0441-6003.2 250037 Dichtungssatz 11.8116-0083.1 390501 Haltefeder 11.8171-0008.1 990049 Führungsbolzen	
			11.3601-8504.2 220148	11.0101-5402.2 260009 Hülsensatz 11.0441-6003.2 250037 Dichtungssatz 11.8116-0083.1 390501 Haltefeder 11.8171-0008.1 990049 Führungsbolzen	







Reparatursätze

Repair kits - Corredi riparazione - Nécessaires de réparation - Juegos de reparación

  		  	
11.3601-8505.2 220149	11.0101-5402.2 260009 Hülsensatz 11.0441-6003.2 250037 Dichtungssatz 11.8116-0083.1 390501 Haltefeder 11.8171-0008.1 990049 Führungsbolzen	11.3601-8523.2 220349	11.0101-5407.2 260011 Hülsensatz 11.0441-6007.2 250146 Dichtungssatz 11.8116-0073.1 390498 Haltefeder 11.8171-0008.1 990049 Führungsbolzen
11.3601-8506.2 220150	11.0101-5402.2 260009 Hülsensatz 11.0441-6003.2 250037 Dichtungssatz 11.8116-0083.1 390501 Haltefeder 11.8171-0008.1 990049 Führungsbolzen	11.3601-8524.2 220350	11.0101-5407.2 260011 Hülsensatz 11.0441-6007.2 250146 Dichtungssatz 11.8116-0073.1 390498 Haltefeder 11.8171-0008.1 990049 Führungsbolzen
11.3601-8507.2 220151	11.0101-5407.2 260011 Hülsensatz 11.0441-6003.2 250037 Dichtungssatz 11.8116-0052.1 390496 Haltefeder 11.8171-0008.1 990049 Führungsbolzen	11.3601-8525.2 220351	11.0101-5407.2 260011 Hülsensatz 11.0441-6007.2 250146 Dichtungssatz 11.8116-0143.1 390513 Haltefeder 11.8171-0008.1 990049 Führungsbolzen
11.3601-8508.2 220152	11.0101-5407.2 260011 Hülsensatz 11.0441-6003.2 250037 Dichtungssatz 11.8116-0052.1 390496 Haltefeder 11.8171-0008.1 990049 Führungsbolzen	11.3601-8526.2 220352	11.0101-5407.2 260011 Hülsensatz 11.0441-6007.2 250146 Dichtungssatz 11.8116-0143.1 390513 Haltefeder 11.8171-0008.1 990049 Führungsbolzen
11.3601-8509.2 220153	11.0101-6004.2 260014 Hülsensatz 11.0441-6003.2 250037 Dichtungssatz	11.3601-8527.2 220353	11.0101-5407.2 260011 Hülsensatz 11.0441-6007.2 250146 Dichtungssatz 11.8116-0301.1 390610 Haltefeder 11.8171-0008.1 990049 Führungsbolzen
11.3601-8510.2 220154	11.0101-6004.2 260014 Hülsensatz 11.0441-6003.2 250037 Dichtungssatz	11.3601-8528.2 220354	11.0101-5407.2 260011 Hülsensatz 11.0441-6007.2 250146 Dichtungssatz 11.8116-0301.1 390610 Haltefeder 11.8171-0008.1 990049 Führungsbolzen
11.3601-8511.2 220155	11.0101-5402.2 260009 Hülsensatz 11.0441-6003.2 250037 Dichtungssatz 11.8171-0008.1 990049 Führungsbolzen	11.3601-8529.2 220355	11.0101-5407.2 260011 Hülsensatz 11.0441-6007.2 250146 Dichtungssatz 11.8171-0008.1 990049 Führungsbolzen
11.3601-8512.2 220156	11.0101-5402.2 260009 Hülsensatz 11.0441-6003.2 250037 Dichtungssatz 11.8171-0008.1 990049 Führungsbolzen	11.3601-8530.2 220356	11.0101-5407.2 260011 Hülsensatz 11.0441-6007.2 250146 Dichtungssatz 11.8171-0008.1 990049 Führungsbolzen
11.3601-8513.2 220393	11.0441-6007.2 250146 Dichtungssatz 11.8171-0008.1 990049 Führungsbolzen	11.4601-8001.3 220157	11.0441-6002.2 250036 Dichtungssatz
11.3601-8514.2 220394	11.0441-6007.2 250146 Dichtungssatz 11.8171-0008.1 990049 Führungsbolzen	11.4601-8002.3 220158	11.0441-6002.2 250036 Dichtungssatz
11.3601-8515.2 220323	11.0101-5402.2 260009 Hülsensatz 11.0441-6003.2 250037 Dichtungssatz 11.8116-0083.1 390501 Haltefeder 11.8171-0008.1 990049 Führungsbolzen	11.4601-8003.3 220159	11.0441-6002.2 250036 Dichtungssatz
11.3601-8516.2 220324	11.0101-5402.2 260009 Hülsensatz 11.0441-6003.2 250037 Dichtungssatz 11.8116-0083.1 390501 Haltefeder 11.8171-0008.1 990049 Führungsbolzen	11.4601-8004.3 220160	11.0441-6002.2 250036 Dichtungssatz
11.3601-8519.2 220345	11.0101-5407.2 260011 Hülsensatz 11.0441-6007.2 250146 Dichtungssatz 11.8116-0073.1 390498 Haltefeder 11.8171-0008.1 990049 Führungsbolzen	11.9341-9991.2 220407	11.0101-5402.2 260009 Hülsensatz 11.8171-0008.1 990049 Führungsbolzen
11.3601-8520.2 220346	11.0101-5407.2 260011 Hülsensatz 11.0441-6007.2 250146 Dichtungssatz 11.8116-0073.1 390498 Haltefeder 11.8171-0008.1 990049 Führungsbolzen	11.9341-9992.2 220408	11.0101-5402.2 260009 Hülsensatz 11.8171-0008.1 990049 Führungsbolzen
11.3601-8521.2 220347	11.0101-5407.2 260011 Hülsensatz 11.0441-6003.2 250037 Dichtungssatz 11.8116-0052.1 390496 Haltefeder 11.8171-0008.1 990049 Führungsbolzen	11.9347-7001.2 220473	11.0101-5407.2 260011 Hülsensatz 11.8171-0008.1 990049 Führungsbolzen
11.3601-8522.2 220348	11.0101-5407.2 260011 Hülsensatz 11.0441-6003.2 250037 Dichtungssatz 11.8116-0052.1 390496 Haltefeder 11.8171-0008.1 990049 Führungsbolzen	11.9347-7002.2 220474	11.0101-5407.2 260011 Hülsensatz 11.8171-0008.1 990049 Führungsbolzen
		11.9347-7003.2 220565	11.0101-5407.2 260011 Hülsensatz 11.8171-0008.1 990049 Führungsbolzen
		11.9347-7004.2 220566	11.0101-5407.2 260011 Hülsensatz 11.8171-0008.1 990049 Führungsbolzen
		11.9347-7005.2 220643	11.0101-5407.2 260011 Hülsensatz 11.8171-0008.1 990049 Führungsbolzen
		11.9347-7006.2 220644	11.0101-5407.2 260011 Hülsensatz 11.8171-0008.1 990049 Führungsbolzen







Reparatursätze

Repair kits - Corredi riparazione - Nécessaires de réparation - Juegos de reparación

  			  		
11.9367-7001.2 220733	11.0101-5407.2 260011 Hülsensatz 11.8171-0008.1 990049 Führungsbolzen		11.9401-9951.2 220463	11.0101-5402.2 260009 Hülsensatz 11.8116-0296.1 390445 Haltefeder 11.8171-0008.1 990049 Führungsbolzen	
11.9367-7002.2 220734	11.0101-5407.2 260011 Hülsensatz 11.8171-0008.1 990049 Führungsbolzen		11.9401-9952.2 220464	11.0101-5402.2 260009 Hülsensatz 11.8116-0296.1 390445 Haltefeder 11.8171-0008.1 990049 Führungsbolzen	
11.9381-9957.2 220661	11.0101-5407.2 260011 Hülsensatz 11.8116-0143.1 390513 Haltefeder 11.8171-0008.1 990049 Führungsbolzen		11.9401-9959.2 220833	11.0101-5402.2 260009 Hülsensatz 11.0441-4002.2 250011 Dichtungssatz 11.8171-0008.1 990049 Führungsbolzen	
11.9381-9958.2 220662	11.0101-5407.2 260011 Hülsensatz 11.8116-0143.1 390513 Haltefeder 11.8171-0008.1 990049 Führungsbolzen		11.9401-9960.2 220834	11.0101-5402.2 260009 Hülsensatz 11.0441-4002.2 250011 Dichtungssatz 11.8171-0008.1 990049 Führungsbolzen	
11.9381-9959.2 220433	11.0101-5402.2 260009 Hülsensatz 11.0441-3803.2 250010 Dichtungssatz 11.8116-0066.1 390577 Haltefeder 11.8171-0008.1 990049 Führungsbolzen		11.9401-9975.2 220495	11.0101-5402.2 260009 Hülsensatz 11.8171-0008.1 990049 Führungsbolzen	
11.9381-9960.2 220434	11.0101-5402.2 260009 Hülsensatz 11.0441-3803.2 250010 Dichtungssatz 11.8116-0066.1 390577 Haltefeder 11.8171-0008.1 990049 Führungsbolzen		11.9401-9976.2 220496	11.0101-5402.2 260009 Hülsensatz 11.8171-0008.1 990049 Führungsbolzen	
11.9381-9961.2 220435	11.0101-5402.2 260009 Hülsensatz 11.0441-3803.2 250010 Dichtungssatz 11.8116-0066.1 390577 Haltefeder 11.8171-0008.1 990049 Führungsbolzen		11.9401-9977.2 220439	11.0101-5402.2 260009 Hülsensatz 11.8171-0008.1 990049 Führungsbolzen	
11.9381-9962.2 220436	11.0101-5402.2 260009 Hülsensatz 11.0441-3803.2 250010 Dichtungssatz 11.8116-0066.1 390577 Haltefeder 11.8171-0008.1 990049 Führungsbolzen		11.9401-9978.2 220440	11.0101-5402.2 260009 Hülsensatz 11.8171-0008.1 990049 Führungsbolzen	
11.9387-7001.2 220397	11.0101-5407.2 260011 Hülsensatz 11.8171-0008.1 990049 Führungsbolzen		11.9406-9993.2 220413	11.0101-5402.2 260009 Hülsensatz 11.8171-0008.1 990049 Führungsbolzen	
11.9387-7002.2 220398	11.0101-5407.2 260011 Hülsensatz 11.8171-0008.1 990049 Führungsbolzen		11.9406-9994.2 220414	11.0101-5402.2 260009 Hülsensatz 11.8171-0008.1 990049 Führungsbolzen	
11.9387-7003.2 220567	11.0101-5407.2 260011 Hülsensatz 11.8171-0008.1 990049 Führungsbolzen		11.9406-9995.2 220415	11.0101-5402.2 260009 Hülsensatz 11.8171-0008.1 990049 Führungsbolzen	
11.9387-7004.2 220568	11.0101-5407.2 260011 Hülsensatz 11.8171-0008.1 990049 Führungsbolzen		11.9406-9996.2 220416	11.0101-5402.2 260009 Hülsensatz 11.8171-0008.1 990049 Führungsbolzen	
11.9387-7005.2 220569	11.0101-5407.2 260011 Hülsensatz 11.8171-0008.1 990049 Führungsbolzen		11.9407-7001.2 220573	11.0101-5407.2 260011 Hülsensatz 11.8171-0008.1 990049 Führungsbolzen	
11.9387-7006.2 220570	11.0101-5407.2 260011 Hülsensatz 11.8171-0008.1 990049 Führungsbolzen		11.9407-7002.2 220574	11.0101-5407.2 260011 Hülsensatz 11.8171-0008.1 990049 Führungsbolzen	
11.9387-7015.2 220627	11.0101-5407.2 260011 Hülsensatz 11.8171-0008.1 990049 Führungsbolzen		11.9407-7005.2 220637	11.0101-5407.2 260011 Hülsensatz 11.8171-0008.1 990049 Führungsbolzen	
11.9387-7016.2 220628	11.0101-5407.2 260011 Hülsensatz 11.8171-0008.1 990049 Führungsbolzen		11.9407-7006.2 220638	11.0101-5407.2 260011 Hülsensatz 11.8171-0008.1 990049 Führungsbolzen	
11.9387-7021.2 220629	11.0101-5407.2 260011 Hülsensatz 11.8171-0008.1 990049 Führungsbolzen		11.9421-9911.2 220825	11.0101-5402.2 260009 Hülsensatz 11.8116-0066.1 390577 Haltefeder 11.8171-0008.1 990049 Führungsbolzen	
11.9387-7022.2 220630	11.0101-5407.2 260011 Hülsensatz 11.8171-0008.1 990049 Führungsbolzen		11.9421-9912.2 220826	11.0101-5402.2 260009 Hülsensatz 11.8116-0066.1 390577 Haltefeder 11.8171-0008.1 990049 Führungsbolzen	
11.9387-7045.2 220797	11.0101-5407.2 260011 Hülsensatz 11.8171-0008.1 990049 Führungsbolzen		11.9421-9963.2 220465	11.0101-5402.2 260009 Hülsensatz 11.8116-0296.1 390445 Haltefeder 11.8171-0008.1 990049 Führungsbolzen	
11.9387-7046.2 220798	11.0101-5407.2 260011 Hülsensatz 11.8171-0008.1 990049 Führungsbolzen		11.9421-9964.2 220466	11.0101-5402.2 260009 Hülsensatz 11.8116-0296.1 390445 Haltefeder 11.8171-0008.1 990049 Führungsbolzen	







Reparatursätze

Repair kits - Corredi riparazione - Nécessaires de réparation - Juegos de reparación

  			  		
11.9421-9965.2 220799	11.0101-5407.2 260011 11.8171-0008.1 990049	Hülsensatz Führungsbolzen	11.9481-9811.2 220445	11.0101-5407.2 260011 11.8171-0008.1 990049	Hülsensatz Führungsbolzen
11.9421-9966.2 220800	11.0101-5407.2 260011 11.8171-0008.1 990049	Hülsensatz Führungsbolzen	11.9481-9812.2 220446	11.0101-5407.2 260011 11.8171-0008.1 990049	Hülsensatz Führungsbolzen
11.9421-9979.2 220497	11.0101-5407.2 260011 11.8171-0008.1 990049	Hülsensatz Führungsbolzen	11.9481-9871.2 220681	11.0101-5407.2 260011 11.0441-4811.2 250024 11.8116-0129.1 390591 11.8171-0008.1 990049	Hülsensatz Dichtungssatz Haltefeder Führungsbolzen
11.9421-9980.2 220498	11.0101-5407.2 260011 11.8171-0008.1 990049	Hülsensatz Führungsbolzen	11.9481-9872.2 220682	11.0101-5407.2 260011 11.0441-4811.2 250024 11.8116-0129.1 390591 11.8171-0008.1 990049	Hülsensatz Dichtungssatz Haltefeder Führungsbolzen
11.9426-9957.2 220895	11.0101-5402.2 260009 11.8171-0008.1 990049	Hülsensatz Führungsbolzen	11.9521-7001.2 220499	11.0101-5407.2 260011 11.8171-0008.1 990049	Hülsensatz Führungsbolzen
11.9426-9958.2 220896	11.0101-5402.2 260009 11.8171-0008.1 990049	Hülsensatz Führungsbolzen	11.9521-7002.2 220500	11.0101-5407.2 260011 11.8171-0008.1 990049	Hülsensatz Führungsbolzen
11.9426-9959.2 220801	11.0101-5407.2 260011 11.8171-0008.1 990049	Hülsensatz Führungsbolzen	11.9541-9543.2 220645	11.0101-5407.2 260011 11.8116-0301.1 390610 11.8171-0008.1 990049	Hülsensatz Haltefeder Führungsbolzen
11.9426-9960.2 220802	11.0101-5407.2 260011 11.8171-0008.1 990049	Hülsensatz Führungsbolzen	11.9541-9544.2 220646	11.0101-5407.2 260011 11.8116-0301.1 390610 11.8171-0008.1 990049	Hülsensatz Haltefeder Führungsbolzen
11.9426-9977.2 220897	11.0101-5402.2 260009 11.8171-0008.1 990049	Hülsensatz Führungsbolzen	11.9541-9545.2 220625	11.0101-5407.2 260011 11.8116-0301.1 390610 11.8171-0008.1 990049	Hülsensatz Haltefeder Führungsbolzen
11.9426-9993.2 220443	11.0101-5402.2 260009 11.8171-0008.1 990049	Hülsensatz Führungsbolzen	11.9541-9546.2 220626	11.0101-5407.2 260011 11.8116-0301.1 390610 11.8171-0008.1 990049	Hülsensatz Haltefeder Führungsbolzen
11.9426-9994.2 220444	11.0101-5402.2 260009 11.8171-0008.1 990049	Hülsensatz Führungsbolzen	11.9541-9549.2 220575	11.0101-5409.2 260035 11.0441-5409.2 250031	Hülsensatz Dichtungssatz
11.9441-9949.2 220803	11.0101-5409.2 260035 11.8171-0008.1 990049	Hülsensatz Führungsbolzen	11.9541-9550.2 220576	11.0101-5409.2 260035 11.0441-5409.2 250031	Hülsensatz Dichtungssatz
11.9441-9950.2 220804	11.0101-5409.2 260035 11.8171-0008.1 990049	Hülsensatz Führungsbolzen	11.9541-9553.2 220563	11.0101-5409.2 260035 11.8171-0008.1 990049	Hülsensatz Führungsbolzen
11.9441-9957.2 220827	11.0101-5402.2 260009 11.8116-0296.1 390445 11.8171-0008.1 990049	Hülsensatz Haltefeder Führungsbolzen	11.9541-9554.2 220564	11.0101-5409.2 260035 11.8171-0008.1 990049	Hülsensatz Führungsbolzen
11.9441-9958.2 220828	11.0101-5402.2 260009 11.8116-0296.1 390445 11.8171-0008.1 990049	Hülsensatz Haltefeder Führungsbolzen	11.9541-9569.2 220725	11.0101-5407.2 260011 11.8171-0008.1 990049	Hülsensatz Führungsbolzen
11.9441-9967.2 220807	11.0101-5409.2 260035 11.8171-0008.1 990049	Hülsensatz Führungsbolzen	11.9541-9570.2 220726	11.0101-5407.2 260011 11.8171-0008.1 990049	Hülsensatz Führungsbolzen
11.9441-9968.2 220808	11.0101-5409.2 260035 11.8171-0008.1 990049	Hülsensatz Führungsbolzen	11.9541-9575.2 220829	11.0101-5402.2 260009 11.8171-0008.1 990049	Hülsensatz Führungsbolzen
11.9461-9981.2 220899	11.0101-5402.2 260009 11.8116-0296.1 390445 11.8171-0008.1 990049	Hülsensatz Haltefeder Führungsbolzen	11.9541-9576.2 220830	11.0101-5402.2 260009 11.8171-0008.1 990049	Hülsensatz Führungsbolzen
11.9461-9982.2 220900	11.0101-5402.2 260009 11.8116-0296.1 390445 11.8171-0008.1 990049	Hülsensatz Haltefeder Führungsbolzen	11.9541-9587.2 220419	11.0101-5402.2 260009 11.0441-5402.2 250028 11.8171-0008.1 990049	Hülsensatz Dichtungssatz Führungsbolzen
11.9461-9983.2 220467	11.0101-5402.2 260009 11.8116-0296.1 390445 11.8171-0008.1 990049	Hülsensatz Haltefeder Führungsbolzen	11.9541-9588.2 220420	11.0101-5402.2 260009 11.0441-5402.2 250028 11.8171-0008.1 990049	Hülsensatz Dichtungssatz Führungsbolzen
11.9461-9984.2 220468	11.0101-5402.2 260009 11.8116-0296.1 390445 11.8171-0008.1 990049	Hülsensatz Haltefeder Führungsbolzen			







Reparatursätze

Repair kits - Corredi riparazione - Nécessaires de réparation - Juegos de reparación

					
11.9541-9595.2 220501	11.0101-5409.2 260035 Hülsensatz 11.0441-5409.2 250031 Dichtungssatz 11.8116-0143.1 390513 Haltefeder 11.8171-0008.1 990049 Führungsbolzen		11.9571-9813.2 220647	11.0101-5407.2 260011 Hülsensatz 11.8171-0008.1 990049 Führungsbolzen	
11.9541-9596.2 220502	11.0101-5409.2 260035 Hülsensatz 11.0441-5409.2 250031 Dichtungssatz 11.8116-0143.1 390513 Haltefeder 11.8171-0008.1 990049 Führungsbolzen		11.9571-9814.2 220648	11.0101-5407.2 260011 Hülsensatz 11.8171-0008.1 990049 Führungsbolzen	
11.9541-9667.2 220421	11.0101-5402.2 260009 Hülsensatz 11.0441-5402.2 250028 Dichtungssatz 11.8171-0008.1 990049 Führungsbolzen		11.9571-9819.2 220469	11.0441-5704.2 250034 Dichtungssatz	
11.9541-9668.2 220422	11.0101-5402.2 260009 Hülsensatz 11.0441-5402.2 250028 Dichtungssatz 11.8171-0008.1 990049 Führungsbolzen		11.9571-9820.2 220470	11.0441-5704.2 250034 Dichtungssatz	
11.9541-9805.2 220503	11.0101-5407.2 260011 Hülsensatz 11.8116-0073.1 390498 Haltefeder 11.8171-0008.1 990049 Führungsbolzen		11.9571-9821.2 220579	11.0101-5407.2 260011 Hülsensatz 11.8171-0008.1 990049 Führungsbolzen	
11.9541-9806.2 220504	11.0101-5407.2 260011 Hülsensatz 11.8116-0073.1 390498 Haltefeder 11.8171-0008.1 990049 Führungsbolzen		11.9571-9822.2 220580	11.0101-5407.2 260011 Hülsensatz 11.8171-0008.1 990049 Führungsbolzen	
11.9546-9997.2 220399	11.0101-5407.2 260011 Hülsensatz		11.9571-9823.2 220471	11.0101-5407.2 260011 Hülsensatz 11.0441-5704.2 250034 Dichtungssatz 11.8116-0292.1 390521 Haltefeder 11.8171-0008.1 990049 Führungsbolzen	
11.9546-9998.2 220400	11.0101-5407.2 260011 Hülsensatz		11.9571-9824.2 220472	11.0101-5407.2 260011 Hülsensatz 11.0441-5704.2 250034 Dichtungssatz 11.8116-0292.1 390521 Haltefeder 11.8171-0008.1 990049 Führungsbolzen	
11.9571-9757.2 220857	11.8116-0301.1 390610 Haltefeder		11.9571-9835.2 220427	11.0101-5409.2 260035 Hülsensatz 11.0441-5704.2 250034 Dichtungssatz 11.8116-0143.1 390513 Haltefeder 11.8171-0008.1 990049 Führungsbolzen	
11.9571-9758.2 220858	11.8116-0301.1 390610 Haltefeder		11.9571-9836.2 220428	11.0101-5409.2 260035 Hülsensatz 11.0441-5704.2 250034 Dichtungssatz 11.8116-0143.1 390513 Haltefeder 11.8171-0008.1 990049 Führungsbolzen	
11.9571-9765.2 220663	11.8171-0008.1 990049 Führungsbolzen		11.9571-9841.2 220401	11.0101-5407.2 260011 Hülsensatz 11.8116-0301.1 390610 Haltefeder 11.8171-0008.1 990049 Führungsbolzen	
11.9571-9766.2 220664	11.8171-0008.1 990049 Führungsbolzen		11.9571-9842.2 220402	11.0101-5407.2 260011 Hülsensatz 11.8116-0301.1 390610 Haltefeder 11.8171-0008.1 990049 Führungsbolzen	
11.9571-9779.2 220657	11.0101-5407.2 260011 Hülsensatz 11.8171-0008.1 990049 Führungsbolzen		11.9571-9847.2 220487	11.0101-5407.2 260011 Hülsensatz 11.0101-5409.2 260035 Hülsensatz 11.0441-5704.2 250034 Dichtungssatz 11.8116-0143.1 390513 Haltefeder 11.8171-0008.1 990049 Führungsbolzen	
11.9571-9780.2 220658	11.0101-5407.2 260011 Hülsensatz 11.8171-0008.1 990049 Führungsbolzen		11.9571-9848.2 220488	11.0101-5407.2 260011 Hülsensatz 11.0101-5409.2 260035 Hülsensatz 11.0441-5704.2 250034 Dichtungssatz 11.8116-0143.1 390513 Haltefeder 11.8171-0008.1 990049 Führungsbolzen	
11.9571-9781.2 220659	11.0101-5407.2 260011 Hülsensatz 11.8171-0008.1 990049 Führungsbolzen		11.9571-9861.2 220403	11.0101-5407.2 260011 Hülsensatz 11.8116-0301.1 390610 Haltefeder 11.8171-0008.1 990049 Führungsbolzen	
11.9571-9782.2 220660	11.0101-5407.2 260011 Hülsensatz 11.8171-0008.1 990049 Führungsbolzen		11.9571-9862.2 220404	11.0101-5407.2 260011 Hülsensatz 11.8116-0301.1 390610 Haltefeder 11.8171-0008.1 990049 Führungsbolzen	
11.9571-9785.2 220595	11.0101-5407.2 260011 Hülsensatz 11.8171-0008.1 990049 Führungsbolzen		11.9571-9863.2 220513	11.0101-5407.2 260011 Hülsensatz 11.8171-0008.1 990049 Führungsbolzen	
11.9571-9786.2 220596	11.0101-5407.2 260011 Hülsensatz 11.8171-0008.1 990049 Führungsbolzen		11.9571-9864.2 220514	11.0101-5407.2 260011 Hülsensatz 11.8171-0008.1 990049 Führungsbolzen	
11.9571-9801.2 220577	11.0101-5407.2 260011 Hülsensatz 11.8171-0008.1 990049 Führungsbolzen				
11.9571-9802.2 220578	11.0101-5407.2 260011 Hülsensatz 11.8171-0008.1 990049 Führungsbolzen				
11.9571-9811.2 220485	11.0101-5407.2 260011 Hülsensatz 11.0441-5704.2 250034 Dichtungssatz 11.8171-0008.1 990049 Führungsbolzen				
11.9571-9812.2 220486	11.0101-5407.2 260011 Hülsensatz 11.0441-5704.2 250034 Dichtungssatz 11.8171-0008.1 990049 Führungsbolzen				







Reparatursätze

Repair kits - Corredi riparazione - Nécessaires de réparation - Juegos de reparación

					
11.9571-9867.2 220423	11.0441-5704.2 250034 11.8171-0008.1 990049	Dichtungssatz Führungsbolzen	11.9601-9829.2 220505	11.0101-5407.2 260011 11.8171-0008.1 990049	Hülsensatz Führungsbolzen
11.9571-9868.2 220424	11.0441-5704.2 250034 11.8171-0008.1 990049	Dichtungssatz Führungsbolzen	11.9601-9830.2 220506	11.0101-5407.2 260011 11.8171-0008.1 990049	Hülsensatz Führungsbolzen
11.9571-9871.2 220425	11.0101-5407.2 260011 11.8171-0008.1 990049	Hülsensatz Führungsbolzen	11.9606-9945.2 220727	11.8171-0008.1 990049	Führungsbolzen
11.9571-9872.2 220426	11.0101-5407.2 260011 11.8171-0008.1 990049	Hülsensatz Führungsbolzen	11.9606-9946.2 220728	11.8171-0008.1 990049	Führungsbolzen
11.9571-9971.2 220605	11.0101-5407.2 260011 11.0441-5702.2 250033 11.8116-0073.1 390498 11.8171-0008.1 990049	Hülsensatz Dichtungssatz Haltefeder Führungsbolzen	11.9606-9954.2 220588	11.0101-5409.2 260035 11.8171-0008.1 990049	Hülsensatz Führungsbolzen
11.9571-9972.2 220606	11.0101-5407.2 260011 11.0441-5702.2 250033 11.8116-0073.1 390498 11.8171-0008.1 990049	Hülsensatz Dichtungssatz Haltefeder Führungsbolzen	11.9606-9957.2 220815	11.0101-5409.2 260035 11.8171-0008.1 990049	Hülsensatz Führungsbolzen
11.9576-9947.2 220809	11.0101-5409.2 260035 11.8171-0008.1 990049	Hülsensatz Führungsbolzen	11.9606-9958.2 220816	11.0101-5409.2 260035 11.8171-0008.1 990049	Hülsensatz Führungsbolzen
11.9576-9948.2 220810	11.0101-5409.2 260035 11.8171-0008.1 990049	Hülsensatz Führungsbolzen	11.9606-9959.2 220729	11.8171-0008.1 990049	Führungsbolzen
11.9576-9975.2 220649	11.0101-5407.2 260011 11.8171-0008.1 990049	Hülsensatz Führungsbolzen	11.9606-9960.2 220730	11.8171-0008.1 990049	Führungsbolzen
11.9576-9976.2 220650	11.0101-5407.2 260011 11.8171-0008.1 990049	Hülsensatz Führungsbolzen	11.9606-9961.2 220655	11.0101-5409.2 260035 11.8171-0008.1 990049	Hülsensatz Führungsbolzen
11.9576-9995.2 220651	11.0101-5409.2 260035 11.8171-0008.1 990049	Hülsensatz Führungsbolzen	11.9606-9962.2 220656	11.0101-5409.2 260035 11.8171-0008.1 990049	Hülsensatz Führungsbolzen
11.9576-9996.2 220652	11.0101-5409.2 260035 11.8171-0008.1 990049	Hülsensatz Führungsbolzen	11.9606-9965.2 220817	11.0101-5409.2 260035 11.8171-0008.1 990049	Hülsensatz Führungsbolzen
11.9601-9745.2 220653	11.0101-5407.2 260011 11.8171-0008.1 990049	Hülsensatz Führungsbolzen	11.9606-9966.2 220818	11.0101-5409.2 260035 11.8171-0008.1 990049	Hülsensatz Führungsbolzen
11.9601-9746.2 220654	11.0101-5407.2 260011 11.8171-0008.1 990049	Hülsensatz Führungsbolzen	11.9606-9967.2 220905	11.0101-5402.2 260009 11.8171-0008.1 990049	Hülsensatz Führungsbolzen
11.9601-9759.2 220811	11.8171-0008.1 990049	Führungsbolzen	11.9606-9968.2 220906	11.0101-5402.2 260009 11.8171-0008.1 990049	Hülsensatz Führungsbolzen
11.9601-9760.2 220812	11.8171-0008.1 990049	Führungsbolzen	11.9606-9969.2 220731	11.8171-0008.1 990049	Führungsbolzen
11.9601-9765.2 220813	11.0101-5407.2 260011 11.8171-0008.1 990049	Hülsensatz Führungsbolzen	11.9606-9970.2 220732	11.8171-0008.1 990049	Führungsbolzen
11.9601-9766.2 220814	11.0101-5407.2 260011 11.8171-0008.1 990049	Hülsensatz Führungsbolzen	11.9606-9971.2 220589	11.0101-5407.2 260011 11.8171-0008.1 990049	Hülsensatz Führungsbolzen
11.9601-9787.2 220585	11.0101-5407.2 260011 11.8116-0301.1 390610 11.8171-0008.1 990049	Hülsensatz Haltefeder Führungsbolzen	11.9606-9972.2 220590	11.0101-5407.2 260011 11.8171-0008.1 990049	Hülsensatz Führungsbolzen
11.9601-9788.2 220586	11.0101-5407.2 260011 11.8116-0301.1 390610 11.8171-0008.1 990049	Hülsensatz Haltefeder Führungsbolzen	11.9606-9979.2 220907	11.8116-0315.2 390447 11.8171-0008.1 990049	Haltefeder Führungsbolzen
11.9601-9823.2 220849	11.0101-5402.2 260009 11.0441-6003.2 250037	Hülsensatz Dichtungssatz	11.9606-9980.2 220908	11.8116-0315.2 390447 11.8171-0008.1 990049	Haltefeder Führungsbolzen
11.9601-9824.2 220850	11.0101-5402.2 260009 11.0441-6003.2 250037	Hülsensatz Dichtungssatz	11.9606-9981.2 220591	11.0101-5407.2 260011 11.8171-0008.1 990049	Hülsensatz Führungsbolzen
			11.9606-9982.2 220592	11.0101-5407.2 260011 11.8171-0008.1 990049	Hülsensatz Führungsbolzen
			11.9606-9991.2 220429	11.0101-5402.2 260009 11.8171-0008.1 990049	Hülsensatz Führungsbolzen







Reparatursätze

Repair kits - Corredi riparazione - Nécessaires de réparation - Juegos de reparación

					
11.9606-9992.2 220430	11.0101-5402.2 260009 11.8171-0008.1 990049	Hülsensatz Führungsbolzen	13.2381-9997.2 210040	13.0441-3801.2 250058	Dichtungssatz
13.2351-0011.2 210008	13.0441-3506.2 250052	Dichtungssatz	13.2383-0001.2 210041	13.0441-3803.2 250060	Dichtungssatz
13.2351-0012.2 210009	13.0441-3506.2 250052	Dichtungssatz	13.2383-0002.2 210042	13.0441-3803.2 250060	Dichtungssatz
13.2351-0013.2 210010	13.0441-3506.2 250052	Dichtungssatz	13.2384-0013.2 210043	13.0441-3810.2 250066	Dichtungssatz
13.2351-0014.2 210011	13.0441-3506.2 250052	Dichtungssatz	13.2384-0014.2 210044	13.0441-3810.2 250066	Dichtungssatz
13.2351-0017.2 210012	13.0441-3506.2 250052	Dichtungssatz	13.2401-0027.2 210045	13.0441-4014.2 250079	Dichtungssatz
13.2351-0018.2 210013	13.0441-3506.2 250052	Dichtungssatz	13.2401-0028.2 210046	13.0441-4014.2 250079	Dichtungssatz
13.2351-0025.2 210210	13.0441-3506.2 250052	Dichtungssatz	13.2401-8007.2 210047	13.0441-4002.2 250074 13.0441-4008.2 250076	Dichtungssatz Dichtungssatz
13.2351-0026.2 210211	13.0441-3506.2 250052	Dichtungssatz	13.2401-8008.2 210048	13.0441-4002.2 250074 13.0441-4008.2 250076	Dichtungssatz Dichtungssatz
13.2351-8005.2 210014	13.0441-3505.2 250051	Dichtungssatz	13.2401-8013.2 210051	13.0441-4020.2 250084	Dichtungssatz
13.2351-8006.2 210015	13.0441-3505.2 250051	Dichtungssatz	13.2401-8014.2 210052	13.0441-4020.2 250084	Dichtungssatz
13.2353-8003.2 210016	13.0441-3504.2 250050	Dichtungssatz	13.2421-0025.2 210145	13.0441-4206.2 250087	Dichtungssatz
13.2353-8004.2 210017	13.0441-3504.2 250050	Dichtungssatz	13.2421-0026.2 210146	13.0441-4206.2 250087	Dichtungssatz
13.2361-8001.2 210214	13.0441-3606.2 250147	Dichtungssatz	13.2421-0043.2 210193	13.0441-4216.2 250093	Dichtungssatz
13.2361-8002.2 210215	13.0441-3606.2 250147	Dichtungssatz	13.2421-0044.2 210194	13.0441-4216.2 250093	Dichtungssatz
13.2381-0039.2 210020	13.0441-3812.2 250068	Dichtungssatz	13.2421-8005.2 210053	13.0441-4205.2 250086	Dichtungssatz
13.2381-0040.2 210021	13.0441-3812.2 250068	Dichtungssatz	13.2421-8006.2 210054	13.0441-4205.2 250086	Dichtungssatz
13.2381-0067.2 210024	13.0441-3815.2 250069	Dichtungssatz	13.2421-8007.2 210055	13.0441-4205.2 250086	Dichtungssatz
13.2381-0068.2 210025	13.0441-3815.2 250069	Dichtungssatz	13.2421-8008.2 210056	13.0441-4205.2 250086	Dichtungssatz
13.2381-0083.2 210026	13.0441-3819.2 250072	Dichtungssatz	13.2421-8021.2 210057	13.0441-4206.2 250087	Dichtungssatz
13.2381-0084.2 210027	13.0441-3819.2 250072	Dichtungssatz	13.2421-8022.2 210058	13.0441-4206.2 250087	Dichtungssatz
13.2381-0085.2 210028	13.0441-3819.2 250072	Dichtungssatz	13.2421-8025.2 210061	13.0441-4216.2 250093	Dichtungssatz
13.2381-0086.2 210029	13.0441-3819.2 250072	Dichtungssatz	13.2421-8026.2 210062	13.0441-4216.2 250093	Dichtungssatz
13.2381-0087.2 210149	13.0441-3819.2 250072	Dichtungssatz	13.2423-8009.2 210063	13.0441-4206.2 250087	Dichtungssatz
13.2381-0088.2 210150	13.0441-3819.2 250072	Dichtungssatz	13.2423-8010.2 210064	13.0441-4206.2 250087	Dichtungssatz
13.2381-8027.2 210033	13.0441-3811.2 250067	Dichtungssatz	13.2424-0009.2 210065	13.0441-4212.2 250089	Dichtungssatz
13.2381-8028.2 210034	13.0441-3811.2 250067	Dichtungssatz	13.2424-0010.2 210066	13.0441-4212.2 250089	Dichtungssatz
13.2381-8029.2 210035	13.0441-3811.2 250067	Dichtungssatz	13.2424-8001.2 210072	13.0441-4212.2 250089	Dichtungssatz
13.2381-8030.2 210036	13.0441-3811.2 250067	Dichtungssatz	13.2424-8002.2 210073	13.0441-4212.2 250089	Dichtungssatz
13.2381-8033.2 210222	13.0441-3817.2 250071	Dichtungssatz	13.2461-8001.2 210226	13.0441-4601.2 250099	Dichtungssatz
13.2381-8034.2 210223	13.0441-3817.2 250071	Dichtungssatz	13.2461-8002.2 210227	13.0441-4601.2 250099	Dichtungssatz
13.2381-8035.2 210037	13.0441-3817.2 250071	Dichtungssatz	13.2481-0024.2 210074	13.0441-4819.2 250104	Dichtungssatz
13.2381-8036.2 210038	13.0441-3817.2 250071	Dichtungssatz	13.2481-0026.2 210075	13.0441-4825.2 250107	Dichtungssatz
13.2381-9996.2 210039	13.0441-3801.2 250058	Dichtungssatz	13.2481-0033.2 210076	13.0441-4819.2 250104	Dichtungssatz







Reparatursätze

Repair kits - Corredi riparazione - Nécessaires de réparation - Juegos de reparación

					
13.2481-0034.2 210077	13.0441-4819.2 250104	Dichtungssatz	13.2544-8002.2 210116	13.0441-5417.2 250118 13.0471-5405.2 250136 13.0471-5407.2 250137 13.0471-5408.2 250138 13.0471-5409.2 250139 13.8158-0020.1 990113 13.8158-0021.1 990114	Dichtungssatz Rep.Satz Nachstellung Verbindungsschrauben Rep.Satz Rückstellwelle Rep.Satz Bremshebel Handbremshebel Handbremshebel
13.2481-0057.2 210078	13.0441-4819.2 250104	Dichtungssatz	13.2571-8011.2 210121	13.0441-5718.2 250120	Dichtungssatz
13.2481-0073.2 210079	13.0441-4819.2 250104	Dichtungssatz	13.2571-8012.2 210122	13.0441-5718.2 250120	Dichtungssatz
13.2481-0074.2 210080	13.0441-4819.2 250104	Dichtungssatz	13.2571-8013.2 210123	13.0441-5718.2 250120	Dichtungssatz
13.2481-0075.2 210081	13.0441-4819.2 250104	Dichtungssatz	13.2571-8014.2 210124	13.0441-5718.2 250120	Dichtungssatz
13.2481-0076.2 210082	13.0441-4819.2 250104	Dichtungssatz	13.2571-8015.2 210125	13.0441-5720.2 250122	Dichtungssatz
13.2481-2311.3 210085	13.0441-4819.2 250104	Dichtungssatz	13.2571-8016.2 210126	13.0441-5720.2 250122	Dichtungssatz
13.2481-2411.3 210086	13.0441-4819.2 250104	Dichtungssatz	13.2571-8023.2 210127	13.0441-5724.2 250125	Dichtungssatz
13.2481-7404.3 210089	13.0441-4819.2 250104	Dichtungssatz	13.2571-8024.2 210128	13.0441-5724.2 250125	Dichtungssatz
13.2481-8007.2 210090	13.0441-4825.2 250107	Dichtungssatz	13.2571-8027.2 210129	13.0441-5720.2 250122	Dichtungssatz
13.2481-8008.2 210091	13.0441-4825.2 250107	Dichtungssatz	13.2571-8028.2 210130	13.0441-5720.2 250122	Dichtungssatz
13.2481-8011.2 210092	13.0441-4825.2 250107	Dichtungssatz	13.2571-9994.2 210131	13.0441-5720.2 250122	Dichtungssatz
13.2481-8012.2 210093	13.0441-4825.2 250107	Dichtungssatz	13.2571-9995.2 210132	13.0441-5720.2 250122	Dichtungssatz
13.2481-8013.2 210094	13.0441-4825.2 250107	Dichtungssatz	13.2571-9998.2 210133	13.0441-5718.2 250120	Dichtungssatz
13.2481-8014.2 210095	13.0441-4825.2 250107	Dichtungssatz	13.2571-9999.2 210134	13.0441-5718.2 250120	Dichtungssatz
13.2481-8057.2 210096	13.0441-4825.2 250107	Dichtungssatz	13.2601-0179.3 210141	13.0441-6012.2 250133	Dichtungssatz
13.2481-8058.2 210097	13.0441-4825.2 250107	Dichtungssatz	13.2601-0180.3 210142	13.0441-6012.2 250133	Dichtungssatz
13.2481-8067.2 210098	13.0441-4819.2 250104	Dichtungssatz	13.2601-7015.2 210230	03.3518-6100.2 390364 03.3518-8000.2 390373 13.0441-6012.2 250133	Entlüfterventil Entlüfterventil Dichtungssatz
13.2481-8068.2 210099	13.0441-4819.2 250104	Dichtungssatz	13.2601-7016.2 210231	03.3518-6100.2 390364 03.3518-8000.2 390373 13.0441-6012.2 250133	Entlüfterventil Entlüfterventil Dichtungssatz
13.2481-9992.2 210100	13.0441-4819.2 250104	Dichtungssatz	13.2601-8025.2 210157	13.0441-6001.2 250126	Dichtungssatz
13.2481-9993.2 210101	13.0441-4819.2 250104	Dichtungssatz	13.2601-8026.2 210158	13.0441-6001.2 250126	Dichtungssatz
13.2481-9998.2 210102	13.0441-4815.2 250102	Dichtungssatz	13.2601-8027.2 210159	13.0441-6001.2 250126	Dichtungssatz
13.2481-9999.2 210103	13.0441-4815.2 250102	Dichtungssatz	13.2601-8028.2 210160	13.0441-6001.2 250126	Dichtungssatz
13.2483-8001.2 210104	13.0441-4825.2 250107	Dichtungssatz	13.2601-8029.2 210161	13.0441-6003.2 250128	Dichtungssatz
13.2483-8002.2 210105	13.0441-4825.2 250107	Dichtungssatz	13.2601-8030.2 210162	13.0441-6003.2 250128	Dichtungssatz
13.2541-8001.2 210110	13.0441-5416.2 250117	Dichtungssatz	13.2601-8031.2 210163	13.0441-6003.2 250128	Dichtungssatz
13.2541-8002.2 210111	13.0441-5416.2 250117	Dichtungssatz	13.2601-8032.2 210164	13.0441-6003.2 250128	Dichtungssatz
13.2541-8008.2 210112	13.0441-5411.2 250114	Dichtungssatz	13.2601-8033.2 210165	13.0441-6003.2 250128	Dichtungssatz
13.2541-9998.2 210113	13.0441-5409.2 250112	Dichtungssatz	13.2601-8034.2 210166	13.0441-6003.2 250128	Dichtungssatz
13.2541-9999.2 210114	13.0441-5409.2 250112	Dichtungssatz			
13.2544-8001.2 210115	13.0441-5417.2 250118 13.0471-5405.2 250136 13.0471-5407.2 250137 13.0471-5408.2 250138 13.0471-5409.2 250139 13.8158-0020.1 990113 13.8158-0021.1 990114	Dichtungssatz Rep.Satz Nachstellung Verbindungsschrauben Rep.Satz Rückstellwelle Rep.Satz Bremshebel Handbremshebel Handbremshebel			







Reparatursätze

Repair kits - Corredi riparazione - Nécessaires de réparation - Juegos de reparación

					
13.2601-8035.2 210167	03.3518-6100.2 390364 03.3518-8000.2 390373 13.0441-6012.2 250133	Entlüfterventil Entlüfterventil Dichtungssatz	13.4441-8017.3 210203	13.0441-4408.2 250096	Dichtungssatz
13.2601-8036.2 210168	03.3518-6100.2 390364 03.3518-8000.2 390373 13.0441-6012.2 250133	Entlüfterventil Entlüfterventil Dichtungssatz	13.4441-8018.3 210204	13.0441-4408.2 250096	Dichtungssatz
13.2601-8037.2 210169	03.3518-6100.2 390364 03.3518-8000.2 390373 13.0441-6012.2 250133	Entlüfterventil Entlüfterventil Dichtungssatz	13.4571-0019.3 210249	13.0441-5721.2 250123	Dichtungssatz
13.2601-8038.2 210170	03.3518-6100.2 390364 03.3518-8000.2 390373 13.0441-6012.2 250133	Entlüfterventil Entlüfterventil Dichtungssatz	13.4571-0020.3 210250	13.0441-5721.2 250123	Dichtungssatz
13.2601-9996.2 210176	13.0441-6001.2 250126	Dichtungssatz	13.4571-8005.3 210205	13.0441-5721.2 250123	Dichtungssatz
13.2601-9997.2 210177	13.0441-6001.2 250126	Dichtungssatz	13.4571-8006.3 210206	13.0441-5721.2 250123	Dichtungssatz
13.4341-8001.2 210151	13.0441-3401.2 250044	Dichtungssatz	13.4574-8005.3 210207	13.0441-5721.2 250123 24.8190-0029.2 990156	Dichtungssatz Handbremsbetätigung
13.4341-8002.2 210152	13.0441-3401.2 250044	Dichtungssatz	13.4574-8006.3 210208	13.0441-5721.2 250123 24.8190-0030.2 990157	Dichtungssatz Handbremsbetätigung
13.4401-8005.2 210182	13.0441-4018.2 250083	Dichtungssatz	13.9544-0021.2 210257	13.0441-5417.2 250118 13.0471-5405.2 250136 13.0471-5407.2 250137 13.0471-5408.2 250138 13.0471-5409.2 250139 13.8158-0020.1 990113 13.8158-0021.1 990114	Dichtungssatz Dichtungssatz Rep.Satz Nachstellung Verbindungsschrauben Rep.Satz Rückstellwelle Rep.Satz Bremshebel Handbremshebel Handbremshebel
13.4401-8006.2 210183	13.0441-4018.2 250083	Dichtungssatz	13.9544-0022.2 210258	13.0441-5417.2 250118 13.0471-5405.2 250136 13.0471-5407.2 250137 13.0471-5408.2 250138 13.0471-5409.2 250139 13.8158-0020.1 990113 13.8158-0021.1 990114	Dichtungssatz Rep.Satz Nachstellung Verbindungsschrauben Rep.Satz Rückstellwelle Rep.Satz Bremshebel Handbremshebel Handbremshebel
13.4401-8009.2 210184	13.0441-4018.2 250083	Dichtungssatz	24.0530-3801.3 220161	24.0101-3601.2 260044	Bremssattel-Zubehör
13.4401-8010.2 210185	13.0441-4018.2 250083	Dichtungssatz	24.1441-1701.5 239001	11.0441-4402.2 250014	Dichtungssatz
13.4401-8018.2 210186	13.0441-4018.2 250083	Dichtungssatz	24.1441-1702.5 239002	11.0441-4402.2 250014	Dichtungssatz
13.4401-8019.2 210187	13.0441-4018.2 250083	Dichtungssatz	24.3304-1701.5 240113	24.0101-3004.2 260042	Bremssattel-Zubehör
13.4401-8020.2 210188	13.0441-4018.2 250083	Dichtungssatz	24.3304-1702.5 240114	24.0101-3004.2 260042	Bremssattel-Zubehör
13.4401-8021.2 210189	13.0441-4018.2 250083	Dichtungssatz	24.3304-1703.5 240091	24.0101-3004.2 260042	Bremssattel-Zubehör
13.4401-8022.2 210190	13.0441-4018.2 250083	Dichtungssatz	24.3304-1704.5 240092	24.0101-3004.2 260042	Bremssattel-Zubehör
13.4401-8027.2 210191	13.0441-4016.2 250081	Dichtungssatz	24.3304-1707.5 240097	24.0101-3001.2 260039	Bremssattel-Zubehör
13.4401-8028.2 210192	13.0441-4016.2 250081	Dichtungssatz	24.3304-1708.5 240098	24.0101-3001.2 260039	Bremssattel-Zubehör
13.4421-8003.2 210197	13.0441-4214.2 250091	Dichtungssatz	24.3331-8501.5 240509	11.0101-5402.2 260009 11.0441-3302.2 250004 11.8116-0015.1 390492 11.8171-0008.1 990049	Hülsensatz Dichtungssatz Haltefeder Führungsbolzen
13.4421-8004.2 210198	13.0441-4214.2 250091	Dichtungssatz	24.3331-8502.5 240510	11.0101-5402.2 260009 11.0441-3302.2 250004 11.8116-0015.1 390492 11.8171-0008.1 990049	Hülsensatz Dichtungssatz Haltefeder Führungsbolzen
13.4421-8007.2 210235	13.0441-4214.2 250091	Dichtungssatz	24.3341-9991.5 240511	11.0101-5402.2 260009 11.8171-0008.1 990049	Hülsensatz Führungsbolzen
13.4421-8008.2 210236	13.0441-4214.2 250091	Dichtungssatz	24.3341-9992.5 240512	11.0101-5402.2 260009 11.8171-0008.1 990049	Hülsensatz Führungsbolzen
13.4421-8009.2 210228	13.0441-4214.2 250091	Dichtungssatz	24.3344-1701.5 240087	24.0101-3401.2 260043	Bremssattel-Zubehör
13.4421-8010.2 210229	13.0441-4214.2 250091	Dichtungssatz			
13.4441-8011.3 210216	13.0441-4408.2 250096	Dichtungssatz			
13.4441-8012.3 210217	13.0441-4408.2 250096	Dichtungssatz			
13.4441-8013.3 210199	13.0441-4408.2 250096	Dichtungssatz			
13.4441-8014.3 210200	13.0441-4408.2 250096	Dichtungssatz			
13.4441-8015.3 210201	13.0441-4408.2 250096	Dichtungssatz			
13.4441-8016.3 210202	13.0441-4408.2 250096	Dichtungssatz			







Reparatursätze

Repair kits - Corredi riparazione - Nécessaires de réparation - Juegos de reparación

					
24.3344-1702.5 240088	24.0101-3401.2 260043	Bremssattel-Zubehör	24.3381-9962.5 240520	11.0101-5402.2 260009 11.0441-3803.2 250010 11.8116-0066.1 390577 11.8171-0008.1 990049	Hülsensatz Dichtungssatz Haltefeder Führungsbolzen
24.3344-1703.5 240117	24.0101-3601.2 260044	Bremssattel-Zubehör	24.3384-1601.5 240013	24.0101-3601.2 260044	Bremssattel-Zubehör
24.3344-1704.5 240118	24.0101-3601.2 260044	Bremssattel-Zubehör	24.3384-1602.5 240014	24.0101-3601.2 260044	Bremssattel-Zubehör
24.3361-8503.5 240513	11.0101-5402.2 260009 11.0441-3602.2 250008 11.8116-0066.1 390577 11.8171-0008.1 990049	Hülsensatz Dichtungssatz Haltefeder Führungsbolzen	24.3384-1603.5 240015	24.0101-3601.2 260044	Bremssattel-Zubehör
24.3361-8504.5 240514	11.0101-5402.2 260009 11.0441-3602.2 250008 11.8116-0066.1 390577 11.8171-0008.1 990049	Hülsensatz Dichtungssatz Haltefeder Führungsbolzen	24.3384-1604.5 240016	24.0101-3601.2 260044	Bremssattel-Zubehör
24.3361-9975.5 240541	11.0101-5407.2 260011 11.0441-3602.2 250008 11.8116-0073.1 390498 11.8171-0008.1 990049	Hülsensatz Dichtungssatz Haltefeder Führungsbolzen	24.3384-1703.5 240055	24.0101-3601.2 260044	Bremssattel-Zubehör
24.3361-9976.5 240542	11.0101-5407.2 260011 11.0441-3602.2 250008 11.8116-0073.1 390498 11.8171-0008.1 990049	Hülsensatz Dichtungssatz Haltefeder Führungsbolzen	24.3384-1704.5 240056	24.0101-3601.2 260044	Bremssattel-Zubehör
24.3364-1603.5 240009	24.0101-3601.2 260044	Bremssattel-Zubehör	24.3384-1705.5 240063	24.0101-3601.2 260044	Bremssattel-Zubehör
24.3364-1604.5 240010	24.0101-3601.2 260044	Bremssattel-Zubehör	24.3384-1706.5 240064	24.0101-3601.2 260044	Bremssattel-Zubehör
24.3364-1605.5 240011	11.0101-5403.2 260010 24.0101-3601.2 260044	Faltenbalgsatz Bremssattel-Zubehör	24.3384-1707.5 240171	11.0101-5403.2 260010 24.0101-3601.2 260044	Faltenbalgsatz Bremssattel-Zubehör
24.3364-1606.5 240012	11.0101-5403.2 260010 24.0101-3601.2 260044	Faltenbalgsatz Bremssattel-Zubehör	24.3384-1708.5 240172	11.0101-5403.2 260010 24.0101-3601.2 260044	Faltenbalgsatz Bremssattel-Zubehör
24.3364-1701.5 240053	24.0101-3601.2 260044	Bremssattel-Zubehör	24.3401-1601.5 240173	24.0101-3401.2 260043	Bremssattel-Zubehör
24.3364-1702.5 240054	24.0101-3601.2 260044	Bremssattel-Zubehör	24.3401-1602.5 240174	24.0101-3401.2 260043	Bremssattel-Zubehör
24.3381-1701.5 240071	24.0101-3801.2 260045	Bremssattel-Zubehör	24.3401-1603.5 240017	24.0101-3401.2 260043 24.0101-3601.2 260044	Bremssattel-Zubehör Bremssattel-Zubehör
24.3381-1702.5 240072	24.0101-3801.2 260045	Bremssattel-Zubehör	24.3401-1604.5 240018	24.0101-3401.2 260043 24.0101-3601.2 260044	Bremssattel-Zubehör Bremssattel-Zubehör
24.3381-8503.5 240515	11.0101-5402.2 260009 11.0441-3803.2 250010 11.8116-0066.1 390577 11.8171-0008.1 990049	Hülsensatz Dichtungssatz Haltefeder Führungsbolzen	24.3401-1703.5 240351	11.0101-5402.2 260009 11.0441-4002.2 250011 11.8116-0066.1 390577 11.8171-0008.1 990049	Hülsensatz Dichtungssatz Haltefeder Führungsbolzen
24.3381-8504.5 240516	11.0101-5402.2 260009 11.0441-3803.2 250010 11.8116-0066.1 390577 11.8171-0008.1 990049	Hülsensatz Dichtungssatz Haltefeder Führungsbolzen	24.3401-1704.5 240352	11.0101-5402.2 260009 11.0441-4002.2 250011 11.8116-0066.1 390577 11.8171-0008.1 990049	Hülsensatz Dichtungssatz Haltefeder Führungsbolzen
24.3381-9959.5 240517	11.0101-5402.2 260009 11.0441-3803.2 250010 11.8116-0066.1 390577 11.8171-0008.1 990049	Hülsensatz Dichtungssatz Haltefeder Führungsbolzen	24.3401-1705.5 240423	11.0101-5402.2 260009 11.0441-4002.2 250011 11.8116-0066.1 390577 11.8171-0008.1 990049	Hülsensatz Dichtungssatz Haltefeder Führungsbolzen
24.3381-9960.5 240518	11.0101-5402.2 260009 11.0441-3803.2 250010 11.8116-0066.1 390577 11.8171-0008.1 990049	Hülsensatz Dichtungssatz Haltefeder Führungsbolzen	24.3401-1706.5 240424	11.0101-5402.2 260009 11.0441-4002.2 250011 11.8116-0066.1 390577 11.8171-0008.1 990049	Hülsensatz Dichtungssatz Haltefeder Führungsbolzen
24.3381-9961.5 240519	11.0101-5402.2 260009 11.0441-3803.2 250010 11.8116-0066.1 390577 11.8171-0008.1 990049	Hülsensatz Dichtungssatz Haltefeder Führungsbolzen	24.3401-8503.5 240521	11.0101-5402.2 260009 11.0441-4002.2 250011 11.8116-0066.1 390577 11.8171-0008.1 990049	Hülsensatz Dichtungssatz Haltefeder Führungsbolzen
			24.3401-8504.5 240522	11.0101-5402.2 260009 11.0441-4002.2 250011 11.8116-0066.1 390577 11.8171-0008.1 990049	Hülsensatz Dichtungssatz Haltefeder Führungsbolzen
			24.3401-9977.5 240523	11.0101-5402.2 260009 11.8171-0008.1 990049	Hülsensatz Führungsbolzen







Reparatursätze

Repair kits - Corredi riparazione - Nécessaires de réparation - Juegos de reparación

					
24.3401-9978.5 240524	11.0101-5402.2 260009 Hülsensatz 11.8171-0008.1 990049 Führungsbolzen		24.3481-1708.5 240074	24.0101-3601.2 260044 Bremssattel-Zubehör	
24.3421-1705.5 240353	11.0101-5402.2 260009 Hülsensatz 11.8116-0296.1 390445 Haltefeder 11.8171-0008.1 990049 Führungsbolzen		24.3481-1731.5 240209	11.0101-5407.2 260011 Hülsensatz 11.0441-4805.2 250020 Dichtungssatz 11.8171-0008.1 990049 Führungsbolzen	
24.3421-1706.5 240354	11.0101-5402.2 260009 Hülsensatz 11.8116-0296.1 390445 Haltefeder 11.8171-0008.1 990049 Führungsbolzen		24.3481-1732.5 240210	11.0101-5407.2 260011 Hülsensatz 11.0441-4805.2 250020 Dichtungssatz 11.8171-0008.1 990049 Führungsbolzen	
24.3421-9979.5 240475	11.0101-5407.2 260011 Hülsensatz 11.8171-0008.1 990049 Führungsbolzen		24.3481-1733.5 240213	11.0101-5407.2 260011 Hülsensatz 11.0441-4811.2 250024 Dichtungssatz 11.8116-0129.1 390591 Haltefeder 11.8171-0008.1 990049 Führungsbolzen	
24.3421-9980.5 240476	11.0101-5407.2 260011 Hülsensatz 11.8171-0008.1 990049 Führungsbolzen		24.3481-1734.5 240214	11.0101-5407.2 260011 Hülsensatz 11.0441-4811.2 250024 Dichtungssatz 11.8116-0129.1 390591 Haltefeder 11.8171-0008.1 990049 Führungsbolzen	
24.3434-1601.5 240019	24.0101-4301.2 260047 Bremssattel-Zubehör		24.3481-1735.5 240283	11.0101-4801.2 260006 Hülsensatz 11.0441-4808.2 250022 Dichtungssatz 24.0102-4801.2 260085 Hülsensatz+Schrauben	
24.3434-1602.5 240020	24.0101-4301.2 260047 Bremssattel-Zubehör		24.3481-1736.5 240284	11.0101-4801.2 260006 Hülsensatz 11.0441-4808.2 250022 Dichtungssatz 24.0102-4801.2 260085 Hülsensatz+Schrauben	
24.3434-1701.5 240357	11.0101-5403.2 260010 Faltenbalgsatz		24.3481-1745.5 240277	11.0101-4803.2 260008 Hülsensatz 11.0441-4808.2 250022 Dichtungssatz 24.0102-4803.2 260086 Hülsensatz+Schrauben	
24.3434-1702.5 240358	11.0101-5403.2 260010 Faltenbalgsatz		24.3481-1746.5 240278	11.0101-4803.2 260008 Hülsensatz 11.0441-4808.2 250022 Dichtungssatz 24.0102-4803.2 260086 Hülsensatz+Schrauben	
24.3451-1703.5 240059	11.0101-5403.2 260010 Faltenbalgsatz 24.0101-3401.2 260043 Bremssattel-Zubehör		24.3481-1747.5 240279	11.0101-4803.2 260008 Hülsensatz 11.0441-4808.2 250022 Dichtungssatz 24.0102-4803.2 260086 Hülsensatz+Schrauben	
24.3451-1704.5 240060	11.0101-5403.2 260010 Faltenbalgsatz 24.0101-3401.2 260043 Bremssattel-Zubehör		24.3481-1748.5 240280	11.0101-4803.2 260008 Hülsensatz 11.0441-4808.2 250022 Dichtungssatz 24.0102-4803.2 260086 Hülsensatz+Schrauben	
24.3481-0705.5 240021	24.0101-4801.2 990131 Bremssattel-Zubehör		24.3481-1749.5 240281	11.0101-4801.2 260006 Hülsensatz 11.0441-4808.2 250022 Dichtungssatz 24.0102-4801.2 260085 Hülsensatz+Schrauben	
24.3481-0706.5 240022	24.0101-4801.2 990131 Bremssattel-Zubehör		24.3481-1750.5 240282	11.0101-4801.2 260006 Hülsensatz 11.0441-4808.2 250022 Dichtungssatz 24.0102-4801.2 260085 Hülsensatz+Schrauben	
24.3481-0707.5 240023	24.0101-4801.2 990131 Bremssattel-Zubehör		24.3481-1753.5 240287	11.0101-4803.2 260008 Hülsensatz 11.0441-4808.2 250022 Dichtungssatz 24.0102-4803.2 260086 Hülsensatz+Schrauben	
24.3481-0708.5 240024	24.0101-4801.2 990131 Bremssattel-Zubehör		24.3481-1754.5 240288	11.0101-4803.2 260008 Hülsensatz 11.0441-4808.2 250022 Dichtungssatz 24.0102-4803.2 260086 Hülsensatz+Schrauben	
24.3481-0711.5 240025	24.0101-4801.2 990131 Bremssattel-Zubehör		24.3481-8515.5 240477	11.0101-5407.2 260011 Hülsensatz 11.8171-0008.1 990049 Führungsbolzen	
24.3481-0712.5 240026	24.0101-4801.2 990131 Bremssattel-Zubehör		24.3481-8516.5 240478	11.0101-5407.2 260011 Hülsensatz 11.8171-0008.1 990049 Führungsbolzen	
24.3481-0713.5 240027	24.0101-4801.2 990131 Bremssattel-Zubehör				
24.3481-0714.5 240028	24.0101-4801.2 990131 Bremssattel-Zubehör				
24.3481-1505.5 240047	24.0101-4803.2 260049 Bremssattel-Zubehör				
24.3481-1506.5 240048	24.0101-4803.2 260049 Bremssattel-Zubehör				
24.3481-1611.5 240029	24.0101-4807.2 260053 Bremssattel-Zubehör				
24.3481-1612.5 240030	24.0101-4807.2 260053 Bremssattel-Zubehör				
24.3481-1615.5 240031	24.0101-4806.2 260052 Bremssattel-Zubehör				
24.3481-1616.5 240032	24.0101-4806.2 260052 Bremssattel-Zubehör				
24.3481-1617.5 240115	24.0101-3601.2 260044 Bremssattel-Zubehör				
24.3481-1618.5 240116	24.0101-3601.2 260044 Bremssattel-Zubehör				
24.3481-1703.5 240051	24.0101-4301.2 260047 Bremssattel-Zubehör				
24.3481-1704.5 240052	24.0101-4301.2 260047 Bremssattel-Zubehör				
24.3481-1707.5 240073	24.0101-3601.2 260044 Bremssattel-Zubehör				







Reparatursätze

Repair kits - Corredi riparazione - Nécessaires de réparation - Juegos de reparación

					
24.3481-9833.5 240479	11.0101-5407.2 260011 Hülsensatz 11.0441-4811.2 250024 Dichtungssatz 11.8116-0129.1 390591 Haltefeder 11.8171-0008.1 990049 Führungsbolzen		24.3541-1701.5 240005	11.0101-5407.2 260011 Hülsensatz 11.0441-5402.2 250028 Dichtungssatz 11.8171-0008.1 990049 Führungsbolzen	
24.3481-9834.5 240480	11.0101-5407.2 260011 Hülsensatz 11.0441-4811.2 250024 Dichtungssatz 11.8116-0129.1 390591 Haltefeder 11.8171-0008.1 990049 Führungsbolzen		24.3541-1702.5 240006	11.0101-5407.2 260011 Hülsensatz 11.0441-5402.2 250028 Dichtungssatz 11.8171-0008.1 990049 Führungsbolzen	
24.3511-1701.5 240101	24.0101-5102.2 260056 Bremssattel-Zubehör		24.3541-1705.5 240111	24.0101-5405.2 260063 Bremssattel-Zubehör	
24.3511-1702.5 240102	24.0101-5102.2 260056 Bremssattel-Zubehör		24.3541-1706.5 240112	24.0101-5405.2 260063 Bremssattel-Zubehör	
24.3521-0701.7 220209	24.0101-4801.2 990131 Bremssattel-Zubehör		24.3541-1707.5 240067	24.0101-5401.2 260059 Bremssattel-Zubehör	
24.3521-0702.7 220210	24.0101-4801.2 990131 Bremssattel-Zubehör		24.3541-1708.5 240068	24.0101-5401.2 260059 Bremssattel-Zubehör	
24.3521-0705.5 240033	24.0101-4801.2 990131 Bremssattel-Zubehör		24.3541-1711.5 240107	24.0101-5102.2 260056 Bremssattel-Zubehör	
24.3521-0706.5 240034	24.0101-4801.2 990131 Bremssattel-Zubehör		24.3541-1712.5 240108	24.0101-5102.2 260056 Bremssattel-Zubehör	
24.3521-1701.5 240001	11.0101-5407.2 260011 Hülsensatz 11.0441-5202.2 250026 Dichtungssatz 11.8116-0097.1 390590 Haltefeder 11.8171-0008.1 990049 Führungsbolzen		24.3541-1717.5 240121	24.0101-3601.2 260044 Bremssattel-Zubehör	
24.3521-1702.5 240002	11.0101-5407.2 260011 Hülsensatz 11.0441-5202.2 250026 Dichtungssatz 11.8116-0097.1 390590 Haltefeder 11.8171-0008.1 990049 Führungsbolzen		24.3541-1718.5 240122	24.0101-3601.2 260044 Bremssattel-Zubehör	
24.3521-1700.5 240481	11.0101-5407.2 260011 Hülsensatz 11.8171-0008.1 990049 Führungsbolzen		24.3541-1719.5 240057	11.0101-5403.2 260010 Faltenbalgsatz 11.0101-5409.2 260035 Hülsensatz 24.0101-4301.2 260047 Bremssattel-Zubehör	
24.3521-1702.5 240002	11.0101-5407.2 260011 Hülsensatz 11.0441-5202.2 250026 Dichtungssatz 11.8116-0097.1 390590 Haltefeder 11.8171-0008.1 990049 Führungsbolzen		24.3541-1720.5 240058	11.0101-5403.2 260010 Faltenbalgsatz 11.0101-5409.2 260035 Hülsensatz 24.0101-4301.2 260047 Bremssattel-Zubehör	
24.3521-7001.5 240481	11.0101-5407.2 260011 Hülsensatz 11.8171-0008.1 990049 Führungsbolzen		24.3541-1721.5 240075	24.0101-3601.2 260044 Bremssattel-Zubehör	
24.3521-7002.5 240482	11.0101-5407.2 260011 Hülsensatz 11.8171-0008.1 990049 Führungsbolzen		24.3541-1722.5 240076	24.0101-3601.2 260044 Bremssattel-Zubehör	
24.3541-0701.5 240035	24.0101-4801.2 990131 Bremssattel-Zubehör		24.3541-1723.5 240077	24.0101-3601.2 260044 Bremssattel-Zubehör	
24.3541-0702.5 240036	24.0101-4801.2 990131 Bremssattel-Zubehör		24.3541-1724.5 240078	24.0101-3601.2 260044 Bremssattel-Zubehör	
24.3541-1603.5 240037	24.0101-3601.2 260044 Bremssattel-Zubehör		24.3541-1725.5 240003	11.0101-5403.2 260010 Faltenbalgsatz 11.0441-5404.2 250029 Dichtungssatz	
24.3541-1604.5 240038	24.0101-3601.2 260044 Bremssattel-Zubehör		24.3541-1726.5 240004	11.0101-5403.2 260010 Faltenbalgsatz 11.0441-5404.2 250029 Dichtungssatz	
24.3541-1609.5 240039	11.0101-5403.2 260010 Faltenbalgsatz 11.0101-5409.2 260035 Hülsensatz 24.0101-4301.2 260047 Bremssattel-Zubehör		24.3541-1731.5 240061	24.0101-4301.2 260047 Bremssattel-Zubehör	
24.3541-1610.5 240040	11.0101-5403.2 260010 Faltenbalgsatz 11.0101-5409.2 260035 Hülsensatz 24.0101-4301.2 260047 Bremssattel-Zubehör		24.3541-1732.5 240062	24.0101-4301.2 260047 Bremssattel-Zubehör	
24.3541-1611.5 240041	24.0101-3401.2 260043 Bremssattel-Zubehör		24.3541-1739.5 240223	11.0101-5403.2 260010 Faltenbalgsatz	
24.3541-1612.5 240042	24.0101-3401.2 260043 Bremssattel-Zubehör		24.3541-1740.5 240224	11.0101-5403.2 260010 Faltenbalgsatz	
24.3541-1619.5 240043	24.0101-3601.2 260044 Bremssattel-Zubehör		24.3541-1773.7 220527	11.0101-5403.2 260010 Faltenbalgsatz 24.0101-3401.2 260043 Bremssattel-Zubehör	
24.3541-1620.5 240044	24.0101-3601.2 260044 Bremssattel-Zubehör		24.3541-1774.7 220528	11.0101-5403.2 260010 Faltenbalgsatz 24.0101-3401.2 260043 Bremssattel-Zubehör	
24.3541-1631.7 220325	11.0101-5403.2 260010 Faltenbalgsatz 11.0441-5404.2 250029 Dichtungssatz		24.3541-1779.5 240249	11.0101-5403.2 260010 Faltenbalgsatz	
24.3541-1632.7 220326	11.0101-5403.2 260010 Faltenbalgsatz 11.0441-5404.2 250029 Dichtungssatz		24.3541-1780.5 240250	11.0101-5403.2 260010 Faltenbalgsatz	
			24.3541-8083.5 240483	11.0101-5407.2 260011 Hülsensatz 11.8116-0292.1 390521 Haltefeder 11.8171-0008.1 990049 Führungsbolzen	







Reparatursätze

Repair kits - Corredi riparazione - Nécessaires de réparation - Juegos de reparación

  			  		
24.3541-8084.5 240484	11.0101-5407.2 260011 Hülsensatz 11.8116-0292.1 390521 Haltefeder 11.8171-0008.1 990049 Führungsbolzen		24.3571-1705.5 240069	24.0101-3401.2 260043	Bremssattel-Zubehör
24.3541-8085.5 240525	11.0101-5407.2 260011 Hülsensatz 11.8116-0129.1 390591 Haltefeder 11.8116-0292.1 390521 Haltefeder 11.8171-0008.1 990049 Führungsbolzen		24.3571-1706.5 240070	24.0101-3401.2 260043	Bremssattel-Zubehör
24.3541-8086.5 240526	11.0101-5407.2 260011 Hülsensatz 11.8116-0129.1 390591 Haltefeder 11.8116-0292.1 390521 Haltefeder 11.8171-0008.1 990049 Führungsbolzen		24.3571-1707.5 240079	24.0101-3601.2 260044	Bremssattel-Zubehör
24.3541-8105.5 240485	11.0101-5407.2 260011 Hülsensatz 11.8171-0008.1 990049 Führungsbolzen		24.3571-1708.5 240080	24.0101-3601.2 260044	Bremssattel-Zubehör
24.3541-8106.5 240486	11.0101-5407.2 260011 Hülsensatz 11.8171-0008.1 990049 Führungsbolzen		24.3571-1725.5 240313	11.0101-5407.2 260011 Hülsensatz 11.0441-5704.2 250034 Dichtungssatz 11.8116-0292.1 390521 Haltefeder 11.8171-0008.1 990049 Führungsbolzen	
24.3541-8521.5 240487	11.0101-5409.2 260035 Hülsensatz 11.0441-5405.2 250030 Dichtungssatz		24.3571-1726.5 240314	11.0101-5407.2 260011 Hülsensatz 11.0441-5704.2 250034 Dichtungssatz 11.8116-0292.1 390521 Haltefeder 11.8171-0008.1 990049 Führungsbolzen	
24.3541-8522.5 240488	11.0101-5409.2 260035 Hülsensatz 11.0441-5405.2 250030 Dichtungssatz		24.3571-1733.5 240349	11.0101-5402.2 260009 Hülsensatz 11.8171-0008.1 990049 Führungsbolzen	
24.3541-8523.5 240551	11.0101-5409.2 260035 Hülsensatz 11.0441-5409.2 250031 Dichtungssatz 11.8116-0143.1 390513 Haltefeder 11.8170-0306.1 260102 Halter 11.8171-0008.1 990049 Führungsbolzen		24.3571-1734.5 240350	11.0101-5402.2 260009 Hülsensatz 11.8171-0008.1 990049 Führungsbolzen	
24.3541-8524.5 240552	11.0101-5409.2 260035 Hülsensatz 11.0441-5409.2 250031 Dichtungssatz 11.8116-0143.1 390513 Haltefeder 11.8170-0306.1 260102 Halter 11.8171-0008.1 990049 Führungsbolzen		24.3571-1761.5 240461	11.0101-5407.2 260011 Hülsensatz 11.0441-5704.2 250034 Dichtungssatz 11.8116-0292.1 390521 Haltefeder 11.8171-0008.1 990049 Führungsbolzen	
24.3541-8529.5 240553	11.0101-5407.2 260011 Hülsensatz 11.0441-5402.2 250028 Dichtungssatz 11.8171-0008.1 990049 Führungsbolzen		24.3571-1762.5 240462	11.0101-5407.2 260011 Hülsensatz 11.0441-5704.2 250034 Dichtungssatz 11.8116-0292.1 390521 Haltefeder 11.8171-0008.1 990049 Führungsbolzen	
24.3541-8530.5 240554	11.0101-5407.2 260011 Hülsensatz 11.0441-5402.2 250028 Dichtungssatz 11.8171-0008.1 990049 Führungsbolzen		24.3571-8505.5 240489	11.0101-5409.2 260035 Hülsensatz 11.0441-5704.2 250034 Dichtungssatz 11.8116-0143.1 390513 Haltefeder 11.8171-0008.1 990049 Führungsbolzen	
24.3541-9587.5 240527	11.0101-5402.2 260009 Hülsensatz 11.0441-5402.2 250028 Dichtungssatz 11.8171-0008.1 990049 Führungsbolzen		24.3571-8506.5 240490	11.0101-5409.2 260035 Hülsensatz 11.0441-5704.2 250034 Dichtungssatz 11.8116-0143.1 390513 Haltefeder 11.8171-0008.1 990049 Führungsbolzen	
24.3541-9588.5 240528	11.0101-5402.2 260009 Hülsensatz 11.0441-5402.2 250028 Dichtungssatz 11.8171-0008.1 990049 Führungsbolzen		24.3571-8507.5 240555	11.8170-0306.1 260102 Halter	
24.3541-9667.5 240529	11.0101-5402.2 260009 Hülsensatz 11.0441-5402.2 250028 Dichtungssatz 11.8171-0008.1 990049 Führungsbolzen		24.3571-8508.5 240556	11.8170-0306.1 260102 Halter	
24.3541-9668.5 240530	11.0101-5402.2 260009 Hülsensatz 11.0441-5402.2 250028 Dichtungssatz 11.8171-0008.1 990049 Führungsbolzen		24.3571-8511.5 240491	11.0101-5407.2 260011 Hülsensatz 11.8171-0008.1 990049 Führungsbolzen	
24.3546-1707.7 220597	11.0101-5407.2 260011 Hülsensatz		24.3571-8512.5 240492	11.0101-5407.2 260011 Hülsensatz 11.8171-0008.1 990049 Führungsbolzen	
24.3546-1708.7 220598	11.0101-5407.2 260011 Hülsensatz		24.3571-8517.5 240493	11.0101-5409.2 260035 Hülsensatz 11.0441-5704.2 250034 Dichtungssatz 11.8116-0143.1 390513 Haltefeder 11.8171-0008.1 990049 Führungsbolzen	
24.3571-1703.5 240099	24.0101-5701.2 260065 Bremssattel-Zubehör		24.3571-8518.5 240494	11.0101-5409.2 260035 Hülsensatz 11.0441-5704.2 250034 Dichtungssatz 11.8116-0143.1 390513 Haltefeder 11.8171-0008.1 990049 Führungsbolzen	
24.3571-1704.5 240100	24.0101-5701.2 260065 Bremssattel-Zubehör		24.3571-8521.5 240495	11.0101-5409.2 260035 Hülsensatz 11.0441-5704.2 250034 Dichtungssatz 11.8116-0143.1 390513 Haltefeder 11.8170-0306.1 260102 Halter 11.8171-0008.1 990049 Führungsbolzen	







Reparatursätze

Repair kits - Corredi riparazione - Nécessaires de réparation - Juegos de reparación

	 	  
24.3571-8522.5 240496	11.0101-5409.2 260035 Hülsensatz 11.0441-5704.2 250034 Dichtungssatz 11.8116-0143.1 390513 Haltefeder 11.8170-0306.1 260102 Halter 11.8171-0008.1 990049 Führungsbolzen	24.3601-8501.5 240533 11.0101-5402.2 260009 Hülsensatz 11.0230-0020.2 260023 Haltersatz 11.0441-6003.2 250037 Dichtungssatz 11.8116-0083.1 390501 Haltefeder 11.8171-0008.1 990049 Führungsbolzen
24.3571-9801.5 240497	11.0101-5407.2 260011 Hülsensatz 11.8171-0008.1 990049 Führungsbolzen	24.3601-8502.5 240534 11.0101-5402.2 260009 Hülsensatz 11.0230-0020.2 260023 Haltersatz 11.0441-6003.2 250037 Dichtungssatz 11.8116-0083.1 390501 Haltefeder 11.8171-0008.1 990049 Führungsbolzen
24.3571-9802.5 240498	11.0101-5407.2 260011 Hülsensatz 11.8171-0008.1 990049 Führungsbolzen	24.3601-8503.5 240535 11.0101-5402.2 260009 Hülsensatz 11.0441-6003.2 250037 Dichtungssatz 11.8116-0083.1 390501 Haltefeder 11.8171-0008.1 990049 Führungsbolzen
24.3571-9811.5 240531	11.0101-5407.2 260011 Hülsensatz 11.0441-5704.2 250034 Dichtungssatz 11.8171-0008.1 990049 Führungsbolzen	24.3601-8504.5 240536 11.0101-5402.2 260009 Hülsensatz 11.0441-6003.2 250037 Dichtungssatz 11.8116-0083.1 390501 Haltefeder 11.8171-0008.1 990049 Führungsbolzen
24.3571-9812.5 240532	11.0101-5407.2 260011 Hülsensatz 11.0441-5704.2 250034 Dichtungssatz 11.8171-0008.1 990049 Führungsbolzen	24.3601-8505.5 240537 11.0101-5402.2 260009 Hülsensatz 11.0441-6003.2 250037 Dichtungssatz 11.8116-0083.1 390501 Haltefeder 11.8171-0008.1 990049 Führungsbolzen
24.3571-9813.5 240557	11.0101-5407.2 260011 Hülsensatz 11.8171-0008.1 990049 Führungsbolzen	24.3601-8506.5 240538 11.0101-5402.2 260009 Hülsensatz 11.0441-6003.2 250037 Dichtungssatz 11.8116-0083.1 390501 Haltefeder 11.8171-0008.1 990049 Führungsbolzen
24.3571-9814.5 240558	11.0101-5407.2 260011 Hülsensatz 11.8171-0008.1 990049 Führungsbolzen	24.3601-8511.5 240539 11.0101-5402.2 260009 Hülsensatz 11.0441-6003.2 250037 Dichtungssatz 11.8171-0008.1 990049 Führungsbolzen
24.3571-9823.5 240499	11.0101-5407.2 260011 Hülsensatz 11.0441-5704.2 250034 Dichtungssatz 11.8116-0292.1 390521 Haltefeder 11.8171-0008.1 990049 Führungsbolzen	24.3601-8512.5 240540 11.0101-5402.2 260009 Hülsensatz 11.0441-6003.2 250037 Dichtungssatz 11.8171-0008.1 990049 Führungsbolzen
24.3571-9824.5 240500	11.0101-5407.2 260011 Hülsensatz 11.0441-5704.2 250034 Dichtungssatz 11.8116-0292.1 390521 Haltefeder 11.8171-0008.1 990049 Führungsbolzen	24.3601-8527.5 240503 11.0101-5407.2 260011 Hülsensatz 11.0441-6007.2 250146 Dichtungssatz 11.8116-0301.1 390610 Haltefeder 11.8171-0008.1 990049 Führungsbolzen
24.3571-9841.5 240501	11.0101-5407.2 260011 Hülsensatz 11.8171-0008.1 990049 Führungsbolzen	24.3601-8528.5 240504 11.0101-5407.2 260011 Hülsensatz 11.0441-6007.2 250146 Dichtungssatz 11.8116-0301.1 390610 Haltefeder 11.8171-0008.1 990049 Führungsbolzen
24.3571-9842.5 240502	11.0101-5407.2 260011 Hülsensatz 11.8171-0008.1 990049 Führungsbolzen	24.3601-9787.5 240505 11.0101-5407.2 260011 Hülsensatz 11.8171-0008.1 990049 Führungsbolzen
24.3601-1601.5 240203	11.0101-5403.2 260010 Faltenbalgsatz	24.3601-9788.5 240506 11.0101-5407.2 260011 Hülsensatz 11.8171-0008.1 990049 Führungsbolzen
24.3601-1602.5 240204	11.0101-5403.2 260010 Faltenbalgsatz	24.3601-9829.5 240507 11.0101-5407.2 260011 Hülsensatz 11.8171-0008.1 990049 Führungsbolzen
24.3601-1701.5 240007	11.0101-5407.2 260011 Hülsensatz 11.0441-6003.2 250037 Dichtungssatz 11.8171-0008.1 990049 Führungsbolzen	24.3601-9830.5 240508 11.0101-5407.2 260011 Hülsensatz 11.8171-0008.1 990049 Führungsbolzen
24.3601-1702.5 240008	11.0101-5407.2 260011 Hülsensatz 11.0441-6003.2 250037 Dichtungssatz 11.8171-0008.1 990049 Führungsbolzen	24.9235-0013.5 230001 13.0441-3506.2 250052 Dichtungssatz
24.3601-1709.5 240275	11.0101-6004.2 260014 Hülsensatz 11.0441-6003.2 250037 Dichtungssatz	24.9235-0014.5 230002 13.0441-3506.2 250052 Dichtungssatz
24.3601-1710.5 240276	11.0101-6004.2 260014 Hülsensatz 11.0441-6003.2 250037 Dichtungssatz	24.9235-8005.5 230023 13.0441-3505.2 250051 Dichtungssatz
24.3601-1713.5 240355	11.0101-5402.2 260009 Hülsensatz 11.0441-6003.2 250037 Dichtungssatz 11.8171-0008.1 990049 Führungsbolzen	24.9235-8006.5 230024 13.0441-3505.2 250051 Dichtungssatz
24.3601-1714.5 240356	11.0101-5402.2 260009 Hülsensatz 11.0441-6003.2 250037 Dichtungssatz 11.8171-0008.1 990049 Führungsbolzen	

Reparatursätze

Repair kits - Corredi riparazione - Nécessaires de réparation - Juegos de reparación

					
24.9236-8001.5 230007	13.0441-3606.2 250147	Dichtungssatz	24.9440-8028.5 230052	13.0441-4016.2 250081	Dichtungssatz
24.9236-8002.5 230008	13.0441-3606.2 250147	Dichtungssatz	24.9442-8003.5 230053	13.0441-4214.2 250091	Dichtungssatz
24.9238-0087.5 230035	13.0441-3819.2 250072	Dichtungssatz	24.9442-8004.5 230054	13.0441-4214.2 250091	Dichtungssatz
24.9238-0088.5 230036	13.0441-3819.2 250072	Dichtungssatz			
24.9238-8027.5 230011	13.0441-3811.2 250067	Dichtungssatz			
24.9238-8028.5 230012	13.0441-3811.2 250067	Dichtungssatz			
24.9238-8029.5 230013	13.0441-3811.2 250067	Dichtungssatz			
24.9238-8030.5 230014	13.0441-3811.2 250067	Dichtungssatz			
24.9238-8033.5 230015	13.0441-3817.2 250071	Dichtungssatz			
24.9238-8034.5 230016	13.0441-3817.2 250071	Dichtungssatz			
24.9238-8035.5 230025	13.0441-3817.2 250071	Dichtungssatz			
24.9238-8036.5 230026	13.0441-3817.2 250071	Dichtungssatz			
24.9240-0027.5 230017	13.0441-4014.2 250079	Dichtungssatz			
24.9240-0028.5 230018	13.0441-4014.2 250079	Dichtungssatz			
24.9240-8013.5 230019	13.0441-4020.2 250084	Dichtungssatz			
24.9240-8014.5 230020	13.0441-4020.2 250084	Dichtungssatz			
24.9242-8005.5 230027	13.0441-4205.2 250086	Dichtungssatz			
24.9242-8006.5 230028	13.0441-4205.2 250086	Dichtungssatz			
24.9242-8007.5 230029	13.0441-4205.2 250086	Dichtungssatz			
24.9242-8008.5 230030	13.0441-4205.2 250086	Dichtungssatz			
24.9242-8021.5 230031	13.0441-4206.2 250087	Dichtungssatz			
24.9242-8022.5 230032	13.0441-4206.2 250087	Dichtungssatz			
24.9246-8001.5 230021	13.0441-4601.2 250099	Dichtungssatz			
24.9246-8002.5 230022	13.0441-4601.2 250099	Dichtungssatz			
24.9257-8023.5 230033	13.0441-5724.2 250125	Dichtungssatz			
24.9257-8024.5 230034	13.0441-5724.2 250125	Dichtungssatz			
24.9257-8027.5 230039	13.0441-5720.2 250122	Dichtungssatz			
24.9257-8028.5 230040	13.0441-5720.2 250122	Dichtungssatz			
24.9260-8025.5 230041	13.0441-6001.2 250126	Dichtungssatz			
24.9260-8026.5 230042	13.0441-6001.2 250126	Dichtungssatz			
24.9260-8029.5 230043	13.0441-6003.2 250128	Dichtungssatz			
24.9260-8030.5 230044	13.0441-6003.2 250128	Dichtungssatz			
24.9260-8031.5 230045	13.0441-6003.2 250128	Dichtungssatz			
24.9260-8032.5 230046	13.0441-6003.2 250128	Dichtungssatz			
24.9440-8027.5 230051	13.0441-4016.2 250081	Dichtungssatz			



Ⓛ **Vergleichsliste**

Ⓔ **Cross reference list**



Ⓕ **Liste des correspondances**

Ⓖ **Lista referencias**

Vergleichsliste

Cross reference list - Tabella di conversione codici

Liste des correspondances - Lista referencias







ALFA ROMEO 	ALFA ROMEO 	BMW 			
101336	83.7704-0281.3 330804	11633.22052.00/30	13.0460-4035.2 604035	32 10 1 157 375	24.5905-0320.3 330058
102487	83.7704-0281.3 330804	11633.26003.00/30	13.0460-3011.2 603011	34 11 1 100 736	13.0460-5029.2 605029
107101	83.7704-0281.3 330804	11646.22014.02.00	24.0122-0119.2 422119	34 11 1 101 093	13.4401-8021.2 210189
130474	24.0113-0171.1 413171	11646.26215.01.00	24.0110-0179.1 410179	34 11 1 101 094	13.4401-8022.2 210190
510364	03.2419-8000.3 030017	11646.45050.00	03.3558-0676.3 310077	34 11 1 101 095	13.4401-8021.2 210189
510829	03.2525-2201.3 040026	11650.26215.00	24.0110-0166.1 410166	34 11 1 101 096	13.4401-8022.2 210190
533991	03.2525-2201.3 040026	11650.45049.00	03.2122-0142.3 010128	34 11 1 101 843	13.4341-8002.2 210152
542407	03.2419-8000.3 030017	11650.45050.00	03.3558-0676.3 310077	34 11 1 101 844	13.4341-8001.2 210151
548195	24.0122-0128.1 422128	11650.45050.08	03.3558-0676.3 310077	34 11 1 103 207	13.0460-9030.2 609030
700487	03.2119-6207.3 010060	11655.18051.00	03.2419-8601.3 030022	34 11 1 103 236	03.3518-6100.2 390364
700495	03.2119-6207.3 010060	11655.22045.00/01	13.0460-4019.2 604019	34 11 1 103 245	13.0441-5406.2 250110
705109	03.2119-6207.3 010060	11655.26055.00/01	13.0460-3013.2 603013	34 11 1 103 289	13.0441-3401.2 250044
795024	13.0441-4212.2 250089	11900.26004.04/16	13.0441-4212.2 250089	34 11 1 103 321	13.0460-9030.2 609030
795026	13.0441-3302.2 250042	14020.22008.00/13	03.3518-6100.2 390364	34 11 1 103 723	13.0441-4018.2 250083
795341	13.0460-3905.2 603905	14020.22038.00/13	03.3518-6100.2 390364	34 11 1 103 726	13.0460-9030.2 609030
795356	13.0460-3905.2 603905	14020.22038.02/16	13.0441-4018.2 250083	34 11 1 103 744	13.0460-9030.2 609030
795357	13.0460-7055.2 607055	16100.26003.00/30	13.0460-3013.2 603013	34 11 1 104 273	13.4341-8002.2 210152
795402	13.0460-2969.2 602969	16200.32050.01/00	03.3558-0676.3 310077	34 11 1 104 274	13.4341-8001.2 210151
9945750	13.0460-2962.2 602962	16414.22052.01/30	13.0460-2980.2 602980	34 11 1 104 944	24.0110-0109.1 410109
9945815	13.0460-2980.2 602980	16416.26003.01/30	13.0460-2962.2 602962	34 11 1 105 388	24.3601-8504.5 240536
9945816	13.0460-2980.2 602980	16420.22023.03/00	24.0120-0129.1 420129	34 11 1 111 513	13.4401-8021.2 210189
9946023	13.0460-2809.2 602809	16420.22413.01/00	13.0460-2962.2 602962	34 11 1 111 514	13.4401-8022.2 210190
60565637	24.3344-1703.5 240117	16420.26003.00/30	13.0460-2962.2 602962	34 11 1 111 649	13.0460-9030.2 609030
60565638	24.3344-1704.5 240118	54911.40000.00/00	83.7704-0281.3 330804	34 11 1 113 664	13.0460-0018.2 610018
60749883	03.0137-0139.2 650139	54968.60000.00/00	03.2419-8000.3 030017	34 11 1 115 937	13.2481-8011.2 210092
60801383	24.3727-0514.2 580514	70049.50000.00	03.2119-6207.3 010060	34 11 1 115 938	13.2481-8012.2 210093
60801577	03.2525-2201.3 040026	70596.60000.00.00	03.0137-9125.2 669125	34 11 1 116 618	13.0441-4825.2 250107
60801790	24.3727-0514.2 580514			34 11 1 116 619	13.0460-4033.2 604033
10133.60000.00	83.7704-0281.3 330804	BMW		34 11 1 116 940	24.0122-0111.1 422111
10512.12050.00	03.2525-1802.3 040025	21 52 1 101 692	03.2419-7800.3 030016	34 11 1 116 947	24.0113-0139.1 413139
10512.12050.01	03.2525-1802.3 040025	21 52 1 101 737	03.2519-1402.3 040005	34 11 1 117 002	13.0460-5032.2 605032
10512.22014.00	24.0113-0102.2 413102	21 52 1 102 060	03.2522-3001.3 040013	34 11 1 117 352	13.0460-5032.2 605032
10512.45028.01	03.6048-0601.3 320052	21 52 1 102 061	03.2520-1001.3 040009	34 11 1 117 422	24.0110-0109.1 410109
10512.45050.00	03.3558-0676.3 310077	21 52 1 102 625	03.0350-1919.2 071919	34 11 1 117 537	13.2481-8011.2 210092
10514.22052.03/16	13.0441-4819.2 250104	21 52 1 104 269	03.2520-1001.3 040009	34 11 1 117 538	13.2481-8012.2 210093
10514.22052.03/25	13.0460-4035.2 604035	21 52 1 104 510	03.2419-7800.3 030016	34 11 1 117 979	13.0460-9030.2 609030
10514.22053.00/30	13.0460-6027.2 606027	21 52 1 106 516	03.2522-3601.3 040014	34 11 1 118 517	13.0460-5032.2 605032
10514.22053.03/30	13.0441-3001.2 250041	21 52 1 113 379	03.2519-1402.3 040005	34 11 1 119 112	24.0122-0112.1 422112
10514.26004.02/16	03.0137-0149.2 650149	21 52 1 113 875	03.0450-2006.2 082006	34 11 1 119 175	13.0441-4018.2 250083
10514.26020.00	13.0460-3011.2 603011	21 52 1 114 536	03.2522-3601.3 040014	34 11 1 119 176	13.0460-9031.2 609031
10526.26003.00/30	13.0460-6027.2 606027	21 52 1 114 537	03.2520-1201.3 040011	34 11 1 119 177	13.0460-9031.2 609031
10541.22052.00/25	13.0460-6027.2 606027	21 52 1 114 538	03.2419-9000.3 030025	34 11 1 119 201	13.0460-0122.2 610122
10541.22053.00/25	13.0460-6027.2 606027	21 52 1 116 300	03.2520-1201.3 040011	34 11 1 119 248	24.0113-0138.1 413138
10541.22053.00/30	03.2525-1802.3 040025	21 52 1 116 302	03.2419-9000.3 030025	34 11 1 119 563	24.0122-0111.1 422111
10548.12050.00	03.2525-1802.3 040025	21 52 1 116 303	03.2419-9000.3 030025	34 11 1 119 564	24.0122-0111.1 422111
10548.12050.01	03.2525-1802.3 040025	21 52 1 116 302	03.2419-9000.3 030025	34 11 1 121 902	24.0125-0100.1 425100
10548.12050.01/27	03.0450-2509.2 082509	21 52 1 150 449	03.2419-9000.3 030025	34 11 1 121 938	13.0460-0038.2 610038
10548.12050.02	03.2525-1802.3 040025	21 52 1 150 451	03.2522-3601.3 040014	34 11 1 150 251	13.2481-8011.2 210092
10548.26003.01/16	13.0441-3803.2 250060	21 52 1 150 782	03.2419-9000.3 030025	34 11 1 150 252	13.2481-8012.2 210093
10548.26003.01/25	13.0460-3011.2 603011	21 52 1 152 580	24.5905-0320.3 330058	34 11 1 150 253	13.2481-8011.2 210092
10548.26003.01/30	13.0460-3011.2 603011	21 52 1 152 581	24.5802-0320.3 330050	34 11 1 150 254	13.2481-8012.2 210093
10548.26003.03/16	13.0441-3803.2 250060	21 52 1 152 584	24.5802-0320.3 330050	34 11 1 150 259	13.2481-8011.2 210092
10548.26215.00	24.0109-0101.1 409101	21 52 1 152 658	24.2419-0912.3 030044	34 11 1 150 260	13.2481-8012.2 210093
10548.45020.03	03.2120-4504.3 010123	21 52 1 153 512	24.5905-0320.3 330058	34 11 1 150 387	24.3601-8503.5 240535
10548.45020.04	03.2120-4504.3 010123	21 52 1 153 513	24.5802-0320.3 330050	34 11 1 150 524	13.0460-5032.2 605032
10562.45027.00/01	24.3526-0810.3 340037	21 52 1 153 520	03.2520-1201.3 040011	34 11 1 150 527	13.0460-5032.2 605032
10564.12050.00/27	03.0450-2510.2 082510	21 52 1 154 580	24.2419-0912.3 030044	34 11 1 150 540	13.0460-0916.2 610916
10564.12051.01	03.2417-0301.3 030004	21 52 1 155 425	24.2419-0922.3 030051	34 11 1 150 550	13.0460-0122.2 610122
10564.45020.00	03.2122-0142.3 010128	21 52 1 156 000	24.2419-0912.3 030044	34 11 1 150 554	13.0460-0123.2 610123
11305.18051.00/00	03.2419-8900.3 030024	21 52 1 156 004	03.2419-9000.3 030025	34 11 1 151 632	24.0112-0111.1 412111
11305.18051.01	03.2419-8900.3 030024	21 52 1 156 673	24.5802-0320.3 330050	34 11 1 151 655	24.0122-0135.1 422135
11305.18051.01/00	03.2419-8900.3 030024	21 52 1 157 346	03.2522-3601.3 040014	34 11 1 151 656	24.0122-0135.1 422135
11305.45050.00	03.3558-0676.3 310077	21 52 1 158 677	03.2522-3601.3 040014	34 11 1 152 295	24.0113-0139.1 413139
11315.18051.00	03.2419-8900.3 030024	21 52 1 158 903	24.2522-0905.3 040042	34 11 1 152 296	24.0125-0100.1 425100
11348.22052.00/30	13.0460-4019.2 604019	21 52 1 159 537	24.2526-0902.3 040052	34 11 1 152 297	24.0125-0100.1 425100
11348.26003.00/30	13.0460-3013.2 603013	21 52 1 159 714	24.5905-0320.3 330058	34 11 1 152 607	24.8190-0213.2 620213
11352.22045.01/01	13.0460-4035.2 604035	21 52 1 161 874	24.2526-0902.3 040052	34 11 1 153 195	11.0101-5402.2 260009
11502.45544.00	24.5307-0320.3 330703	21 52 4 648 052	03.2519-1402.3 040005	34 11 1 153 200	11.8171-0008.1 990049
11538.45056.00	24.5307-0320.3 330703	21 52 4 648 146	03.0350-1508.2 071508	34 11 1 153 202	11.0441-5402.2 250028
11568.22052.01/30	13.0460-6027.2 606027	21 52 6 766 277	24.2522-0905.3 040042	34 11 1 153 203	13.0460-7046.2 607046
11600.12051.11	03.2419-8601.3 030022	21 52 6 775 924	24.2522-0905.3 040042	34 11 1 153 208	11.0441-5702.2 250033



Vergleichsliste

Cross reference list - Tabella di conversione codici



Liste des correspondances - Lista referencias

 			 			 		
34 11 1 153 228	24.0125-0104.1	425104	34 11 1 160 368	24.3601-8506.5	240538	34 21 1 117 932	24.9242-8008.5	230030
34 11 1 153 303	10.0504-0113.3	340021	34 11 1 160 450	13.0460-6033.2	606033	34 21 1 117 981	13.0460-3024.2	603024
34 11 1 154 379	24.3481-1607.5	240211	34 11 1 160 522	13.0460-2921.2	602921	34 21 1 117 983	13.0460-0125.2	610125
34 11 1 154 380	24.3481-1608.5	240212	34 11 1 160 708	13.0460-9037.2	609037	34 21 1 119 182	13.0441-3303.2	250043
34 11 1 154 443	13.0460-2921.2	602921	34 11 1 160 915	24.0122-0122.1	422122	34 21 1 119 211	24.9242-8007.5	230029
34 11 1 154 611	13.0460-7046.2	607046	34 11 1 160 915	24.0322-0122.1	522122	34 21 1 119 212	24.9242-8008.5	230030
34 11 1 154 747	24.0113-0167.1	413167	34 11 1 160 936	24.0122-0103.1	422103	34 21 1 119 213	24.9242-8007.5	230029
34 11 1 154 749	24.0122-0122.1	422122	34 11 1 160 936	24.0322-0103.1	522103	34 21 1 119 566	24.0110-0110.1	410110
34 11 1 154 749	24.0322-0122.1	522122	34 11 1 161 347	13.0460-2921.2	602921	34 21 1 119 581	24.0110-0150.1	410150
34 11 1 154 750	24.0122-0122.1	422122	34 11 1 161 349	13.0460-2921.2	602921	34 21 1 119 581	24.0310-0150.1	510150
34 11 1 154 750	24.0322-0122.1	522122	34 11 1 161 693	24.0112-0124.1	412124	34 21 1 119 945	24.3220-1712.3	020406
34 11 1 154 974	24.0125-0100.1	425100	34 11 1 161 717	13.0460-7046.2	607046	34 21 1 121 387	24.0110-0174.1	410174
34 11 1 155 076	13.0460-7046.2	607046	34 11 1 162 481	13.0460-2921.2	602921	34 21 1 150 159	13.0460-0121.2	610121
34 11 1 155 998	13.0460-2921.2	602921	34 11 1 162 535	13.0460-6033.2	606033	34 21 1 150 273	13.2421-8005.2	210053
34 11 1 155 999	13.0460-2921.2	602921	34 11 1 163 126	24.0122-0112.1	422112	34 21 1 150 273	24.9242-8005.5	230027
34 11 1 156 124	24.0113-0139.1	413139	34 11 1 163 128	24.0113-0138.1	413138	34 21 1 150 274	13.2421-8006.2	210054
34 11 1 156 128	24.0113-0139.1	413139	34 11 1 163 130	24.0122-0111.1	422111	34 21 1 150 274	24.9242-8006.5	230028
34 11 1 156 143	24.0125-0104.1	425104	34 11 1 163 134	24.0112-0111.1	412111	34 21 1 150 275	13.2421-8005.2	210053
34 11 1 156 898	13.0460-2921.2	602921	34 11 1 163 136	24.0122-0135.1	422135	34 21 1 150 275	24.9242-8005.5	230027
34 11 1 156 899	13.0460-2921.2	602921	34 11 1 163 141	24.0125-0100.1	425100	34 21 1 150 276	13.2421-8006.2	210054
34 11 1 157 037	11.0441-6003.2	250037	34 11 1 163 142	24.0125-0100.1	425100	34 21 1 150 276	24.9242-8006.5	230028
34 11 1 157 038	11.0101-5402.2	260009	34 11 1 163 144	24.0113-0139.1	413139	34 21 1 150 545	13.0460-0121.2	610121
34 11 1 157 041	11.8171-0008.1	990049	34 11 1 163 147	24.0125-0104.1	425104	34 21 1 150 556	13.0460-3024.2	603024
34 11 1 157 043	11.0441-4810.2	250023	34 11 1 163 148	24.0125-0104.1	425104	34 21 1 150 557	13.0460-0125.2	610125
34 11 1 157 389	24.3601-8503.5	240535	34 11 1 163 415	11.0101-6004.2	260014	34 21 1 151 633	11.3331-8501.2	220004
34 11 1 157 390	24.3601-8504.5	240536	34 11 1 163 433	11.0441-6003.2	250037	34 21 1 151 633	24.3331-8501.5	240509
34 11 1 157 495	11.3601-8501.2	220145	34 11 1 165 263	24.0128-0122.1	428122	34 21 1 151 634	11.3331-8502.2	220005
34 11 1 157 495	24.3601-8501.5	240533	34 11 2 061 000	03.3217-0301.3	020022	34 21 1 151 634	24.3331-8502.5	240510
34 11 1 157 496	24.3601-8502.5	240534	34 11 2 225 107	24.8190-0214.2	620214	34 21 1 151 635	11.3331-8501.2	220004
34 11 1 157 501	11.3601-8505.2	220149	34 11 2 226 009	13.0460-9031.2	609031	34 21 1 151 635	24.3331-8501.5	240509
34 11 1 157 501	24.3601-8505.5	240537	34 11 2 226 084	13.0460-7046.2	607046	34 21 1 151 636	11.3331-8502.2	220005
34 11 1 157 502	24.3601-8506.5	240538	34 11 2 226 203	11.8116-0091.1	390502	34 21 1 151 636	24.3331-8502.5	240510
34 11 1 157 510	13.0460-7046.2	607046	34 11 2 226 407	24.3601-8503.5	240535	34 21 1 152 221	24.0110-0176.1	410176
34 11 1 157 561	13.0460-7046.2	607046	34 11 2 226 408	24.3601-8504.5	240536	34 21 1 152 298	24.0110-0147.1	410147
34 11 1 157 569	13.0460-6033.2	606033	34 11 2 227 331	13.0460-9037.2	609037	34 21 1 153 194	11.0441-3302.2	250004
34 11 1 157 625	11.3601-8501.2	220145	34 11 2 227 670	11.8116-0083.1	390501	34 21 1 153 196	13.0460-7047.2	607047
34 11 1 157 625	24.3601-8501.5	240533	34 11 2 227 863	13.0460-9037.2	609037	34 21 1 153 199	11.8116-0015.1	390492
34 11 1 157 626	24.3601-8502.5	240534	34 11 2 228 248	13.0460-6033.2	606033	34 21 1 153 241	11.3331-8501.2	220004
34 11 1 157 687	11.8116-0083.1	390501	34 11 2 266 206	11.8116-0091.1	390502	34 21 1 153 241	24.3331-8501.5	240509
34 11 1 157 747	13.0460-2921.2	602921	34 11 2 282 554	13.0460-6033.2	606033	34 21 1 153 242	11.3331-8502.2	220005
34 11 1 157 748	13.0460-2921.2	602921	34 11 2 283 363	11.8116-0315.2	390447	34 21 1 153 242	24.3331-8502.5	240510
34 11 1 157 813	13.0460-6033.2	606033	34 11 2 660 198	13.0441-5406.2	250110	34 21 1 153 243	11.3331-8501.2	220004
34 11 1 157 923	13.0460-7046.2	607046	34 11 6 752 434	24.0113-0167.1	413167	34 21 1 153 243	24.3331-8501.5	240509
34 11 1 158 038	24.0128-0101.1	428101	34 11 6 756 090	24.0128-0101.1	428101	34 21 1 153 244	11.3331-8502.2	220005
34 11 1 158 040	24.0122-0103.1	422103	34 11 6 757 253	11.8116-0315.2	390447	34 21 1 153 244	24.3331-8502.5	240510
34 11 1 158 040	24.0322-0103.1	522103	34 11 6 757 746	24.0130-0101.1	430101	34 21 1 153 881	03.0137-9076.2	669076
34 11 1 158 042	24.0112-0124.1	412124	34 11 6 773 126	11.0441-6007.2	250146	34 21 1 153 883	03.0137-9076.2	669076
34 11 1 158 200	11.8171-0008.1	990049	34 21 1 101 741	24.0223-0005.1	480035	34 21 1 153 884	03.0137-9076.2	669076
34 11 1 158 265	13.0460-6033.2	606033	34 21 1 101 760	24.3215-1105.3	020159	34 21 1 154 236	03.3220-3201.3	020065
34 11 1 158 316	13.0460-2921.2	602921	34 21 1 103 392	03.3222-4211.3	020075	34 21 1 154 385	03.0137-0151.2	650151
34 11 1 158 550	24.0128-0122.1	428122	34 21 1 103 482	13.0441-4205.2	250086	34 21 1 154 398	13.0460-7036.2	607036
34 11 1 158 692	13.0441-4018.2	250083	34 21 1 103 683	24.0110-0110.1	410110	34 21 1 154 448	03.0137-9076.2	669076
34 11 1 159 249	13.0460-5032.2	605032	34 21 1 107 107	24.9242-8007.5	230029	34 21 1 154 599	11.3331-8501.2	220004
34 11 1 159 257	13.0460-9030.2	609030	34 21 1 107 108	24.9242-8008.5	230030	34 21 1 154 599	24.3331-8501.5	240509
34 11 1 159 261	13.0460-9031.2	609031	34 21 1 107 134	24.3215-1105.3	020159	34 21 1 154 600	11.3331-8502.2	220005
34 11 1 159 279	13.0460-6033.2	606033	34 21 1 111 515	13.2421-8005.2	210053	34 21 1 154 600	24.3331-8502.5	240510
34 11 1 159 415	13.0460-7046.2	607046	34 21 1 111 515	24.9242-8005.5	230027	34 21 1 154 601	11.3331-8501.2	220004
34 11 1 159 895	24.0130-0101.1	430101	34 21 1 111 516	13.2421-8006.2	210054	34 21 1 154 601	24.3331-8501.5	240509
34 11 1 159 896	24.0128-0101.1	428101	34 21 1 111 516	24.9242-8006.5	230028	34 21 1 154 602	11.3331-8502.2	220005
34 11 1 159 897	24.0122-0103.1	422103	34 21 1 111 852	03.0137-0009.2	650009	34 21 1 154 602	24.3331-8502.5	240510
34 11 1 159 897	24.0322-0103.1	522103	34 21 1 112 899	24.9242-8007.5	230029	34 21 1 154 613	13.0460-7047.2	607047
34 11 1 159 898	24.0112-0124.1	412124	34 21 1 112 900	24.9242-8008.5	230030	34 21 1 154 871	11.3331-8501.2	220004
34 11 1 159 916	24.0130-0101.1	430101	34 21 1 112 961	03.0137-0009.2	650009	34 21 1 154 871	24.3331-8501.5	240509
34 11 1 160 360	11.0230-0020.2	260023	34 21 1 113 665	13.0460-0014.2	610014	34 21 1 154 872	11.3331-8502.2	220005
34 11 1 160 361	11.3601-8501.2	220145	34 21 1 113 666	13.0460-0125.2	610125	34 21 1 154 872	24.3331-8502.5	240510
34 11 1 160 361	24.3601-8501.5	240533	34 21 1 113 685	13.0460-0014.2	610014	34 21 1 154 921	03.0137-0152.2	650152
34 11 1 160 362	24.3601-8502.5	240534	34 21 1 116 949	24.0110-0110.1	410110	34 21 1 154 943	11.3331-8501.2	220004
34 11 1 160 363	24.3601-8503.5	240535	34 21 1 117 047	24.0225-0001.1	480043	34 21 1 154 943	24.3331-8501.5	240509
34 11 1 160 364	24.3601-8504.5	240536	34 21 1 117 104	03.3219-2106.3	020043	34 21 1 154 944	11.3331-8502.2	220005
34 11 1 160 367	11.3601-8505.2	220149	34 21 1 117 284	03.0137-0009.2	650009	34 21 1 154 944	24.3331-8502.5	240510
34 11 1 160 367	24.3601-8505.5	240537	34 21 1 117 730	24.0110-0147.1	410147	34 21 1 155 015	24.0110-0263.1	410263

Vergleichsliste

Cross reference list - Tabella di conversione codici

Liste des correspondances - Lista referencias



BMW		BMW		BMW				
34 21 1 155 077	13.0460-7047.2	607047	34 21 1 160 533	13.0460-3605.2	603605	34 21 9 064 271	03.0137-0152.2	650152
34 21 1 155 491	11.3381-8501.2	220018	34 21 1 160 533	13.0470-3605.2	LD3605	34 31 0 049 762	24.3526-0810.3	340037
34 21 1 155 492	24.3381-8502.5	240664	34 21 1 160 927	11.3401-8503.2	220030	34 31 1 103 271	03.2123-7002.3	010187
34 21 1 155 501	24.0120-0113.1	420113	34 21 1 160 927	24.3401-8503.5	240521	34 31 1 103 742	03.2123-6802.3	010186
34 21 1 155 993	11.3331-8501.2	220004	34 21 1 160 928	11.3401-8504.2	220031	34 31 1 113 656	03.2120-3412.3	010121
34 21 1 155 993	24.3331-8501.5	240509	34 21 1 160 928	24.3401-8504.5	240522	34 31 1 114 234	03.2122-6202.3	010148
34 21 1 155 994	11.3331-8502.2	220005	34 21 1 161 455	13.0460-3605.2	603605	34 31 1 116 605	03.2122-6912.3	010154
34 21 1 155 994	24.3331-8502.5	240510	34 21 1 161 455	13.0470-3605.2	LD3605	34 31 1 117 208	03.2120-0622.3	010079
34 21 1 156 087	11.3381-8501.2	220018	34 21 1 162 305	24.0110-0117.1	410117	34 31 1 117 593	03.2123-6802.3	010186
34 21 1 156 088	24.3381-8502.5	240664	34 21 1 162 305	24.0310-0117.1	510117	34 31 1 117 594	03.2122-6202.3	010148
34 21 1 156 167	24.3222-1604.3	020276	34 21 1 162 446	13.0460-3605.2	603605	34 31 1 120 032	03.2120-0622.3	010079
34 21 1 156 297	24.0222-8009.1	480026	34 21 1 162 446	13.0470-3605.2	LD3605	34 31 1 120 217	03.2120-0562.3	010078
34 21 1 156 463	13.0460-7047.2	607047	34 21 1 162 536	13.0460-3605.2	603605	34 31 1 120 218	03.2120-0562.3	010078
34 21 1 156 668	24.0110-0117.1	410117	34 21 1 162 536	13.0470-3605.2	LD3605	34 31 1 120 478	03.2123-6802.3	010186
34 21 1 156 668	24.0310-0117.1	510117	34 21 1 162 967	24.0120-0113.1	420113	34 31 1 120 479	03.2122-6202.3	010148
34 21 1 156 744	13.0460-7036.2	607036	34 21 1 162 968	24.0110-0174.1	410174	34 31 1 120 832	03.2123-7002.3	010187
34 21 1 156 746	13.0460-7047.2	607047	34 21 1 163 132	24.0110-0110.1	410110	34 31 1 121 911	03.3304-1400.1	390088
34 21 1 156 748	13.0460-7047.2	607047	34 21 1 163 138	24.0120-0113.1	420113	34 31 1 150 229	03.2122-6912.3	010154
34 21 1 157 042	11.0441-3802.2	250009	34 21 1 163 140	24.0110-0174.1	410174	34 31 1 152 767	03.2122-7513.3	010155
34 21 1 157 046	11.8116-0066.1	390577	34 21 1 163 145	24.0110-0263.1	410263	34 31 1 153 019	03.2123-8711.3	010196
34 21 1 157 302	03.0137-0151.2	650151	34 21 1 163 146	24.0110-0263.1	410263	34 31 1 153 053	03.2123-8312.3	010193
34 21 1 157 334	13.0460-3803.2	603803	34 21 1 163 150	24.0110-0176.1	410176	34 31 1 153 916	03.2122-6911.3	010153
34 21 1 157 360	24.0112-0120.1	412120	34 21 1 163 241	11.3331-8501.2	220004	34 31 1 153 919	03.2123-8311.3	010192
34 21 1 157 514	13.0460-7047.2	607047	34 21 1 163 241	24.3331-8501.5	240509	34 31 1 154 070	03.2122-6911.3	010153
34 21 1 157 555	24.3381-8503.5	240515	34 21 1 164 499	13.0460-3605.2	603605	34 31 1 154 263	03.2020-0402.3	010001
34 21 1 157 556	11.3381-8504.2	220021	34 21 1 164 499	13.0470-3605.2	LD3605	34 31 1 154 398	13.0460-7036.2	607036
34 21 1 157 556	24.3381-8504.5	240516	34 21 1 164 501	13.0460-3605.2	603605	34 31 1 154 405	03.2120-2082.3	010107
34 21 1 157 557	24.3381-8503.5	240515	34 21 1 164 501	13.0470-3605.2	LD3605	34 31 1 154 918	03.2120-1802.3	010099
34 21 1 157 558	11.3381-8504.2	220021	34 21 1 165 233	13.0460-3605.2	603605	34 31 1 155 269	03.2122-7513.3	010155
34 21 1 157 558	24.3381-8504.5	240516	34 21 1 165 233	13.0470-3605.2	LD3605	34 31 1 155 270	03.2123-8711.3	010196
34 21 1 157 646	11.8116-0066.1	390577	34 21 1 165 235	13.0460-3605.2	603605	34 31 1 156 273	03.2020-0402.3	010001
34 21 1 157 781	24.0110-0118.1	410118	34 21 1 165 235	13.0470-3605.2	LD3605	34 31 1 156 643	03.2125-2802.3	010210
34 21 1 157 814	13.0460-3803.2	603803	34 21 1 165 255	24.0110-0147.1	410147	34 31 1 157 111	03.2125-3011.3	010211
34 21 1 157 915	11.3331-8501.2	220004	34 21 1 165 257	24.0112-0120.1	412120	34 31 1 157 206	03.2022-1201.3	010009
34 21 1 157 915	24.3331-8501.5	240509	34 21 1 165 259	24.0110-0118.1	410118	34 31 1 160 660	24.2125-1716.3	010663
34 21 1 157 916	11.3331-8502.2	220005	34 21 1 165 265	24.0120-0181.1	420181	34 31 1 160 868	03.2025-1211.3	010475
34 21 1 157 916	24.3331-8502.5	240510	34 21 2 157 574	13.0460-3605.2	603605	34 31 1 161 617	03.2125-3011.3	010211
34 21 1 157 925	13.0460-7047.2	607047	34 21 2 157 574	13.0470-3605.2	LD3605	34 31 1 161 861	03.2125-3011.3	010211
34 21 1 157 926	13.0460-7047.2	607047	34 21 2 157 575	13.0460-3605.2	603605	34 31 1 161 870	24.2125-1716.3	010663
34 21 1 158 221	13.0460-3803.2	603803	34 21 2 157 575	13.0470-3605.2	LD3605	34 31 2 225 257	03.2123-0242.3	010163
34 21 1 158 266	13.0460-3803.2	603803	34 21 2 186 348	03.3215-0221.3	020013	34 31 4 550 106	24.3526-0100.3	340017
34 21 1 158 268	13.0460-3803.2	603803	34 21 2 225 229	24.8190-0215.2	620215	34 31 8 048 562	24.3526-0100.3	340017
34 21 1 158 323	13.0460-7036.2	607036	34 21 2 225 409	11.3381-8501.2	220018	34 31 8 748 109	24.3526-0810.3	340037
34 21 1 158 556	24.0222-8009.1	480026	34 21 2 225 410	24.3381-8502.5	240664	34 32 1 102 567	24.5201-0290.3	331401
34 21 1 158 576	24.0110-0262.1	410262	34 21 2 225 446	11.3381-8501.2	220018	34 32 1 103 873	03.3304-0700.1	390082
34 21 1 158 578	11.0441-4002.2	250011	34 21 2 225 447	24.3381-8502.5	240664	34 32 1 108 133	83.7704-0290.3	330826
34 21 1 158 642	13.0460-3803.2	603803	34 21 2 226 013	13.0460-7047.2	607047	34 32 1 108 134	24.5170-0201.3	331450
34 21 1 158 712	24.0225-0001.1	480043	34 21 2 226 730	24.0120-0181.1	420181	34 32 1 108 135	24.5201-0204.3	331400
34 21 1 158 883	11.0441-3602.2	250008	34 21 2 227 671	11.8116-0066.1	390577	34 32 1 109 322	03.3508-8802.3	310051
34 21 1 158 912	13.0460-7036.2	607036	34 21 2 227 672	11.8116-0296.1	390445	34 32 1 109 324	03.3508-8801.3	310050
34 21 1 159 171	11.0441-3803.2	250010	34 21 2 282 198	11.8116-0296.1	390445	34 32 1 112 399	03.3508-5851.3	310039
34 21 1 159 265	13.0460-3024.2	603024	34 21 3 060 060	03.3217-0301.3	020022	34 32 1 112 400	03.3508-5951.3	310041
34 21 1 159 273	13.0460-7047.2	607047	34 21 3 460 010	24.0220-0007.1	480015	34 32 1 112 402	03.3508-5959.3	310044
34 21 1 159 588	03.0137-0009.2	650009	34 21 3 460 120	24.3217-1707.3	020108	34 32 1 113 183	24.5201-0204.3	331400
34 21 1 159 659	24.0120-0181.1	420181	34 21 3 660 020	03.0137-0009.2	650009	34 32 1 113 184	24.5201-0290.3	331401
34 21 1 160 198	13.0460-3803.2	603803	34 21 3 660 123	03.3217-0602.3	020024	34 32 1 114 908	03.3508-8802.3	310051
34 21 1 160 333	11.3361-8503.2	220016	34 21 6 750 190	13.0460-3605.2	603605	34 32 1 115 694	24.5201-0290.3	331401
34 21 1 160 333	24.3361-8503.5	240513	34 21 6 750 190	13.0470-3605.2	LD3605	34 32 1 115 695	24.5201-0204.3	331400
34 21 1 160 334	11.3361-8504.2	220017	34 21 6 753 675	11.8116-0296.1	390445	34 32 1 115 697	24.5170-0201.3	331450
34 21 1 160 334	24.3361-8504.5	240514	34 21 6 755 407	24.0110-0150.1	410150	34 32 1 116 515	83.7704-0290.3	330826
34 21 1 160 340	13.0460-3605.2	603605	34 21 6 755 407	24.0310-0150.1	510150	34 32 1 152 274	83.6124-0422.3	330269
34 21 1 160 340	13.0470-3605.2	LD3605	34 21 6 761 238	13.0460-3605.2	603605	34 32 1 153 107	24.5170-0201.3	331450
34 21 1 160 353	11.3381-8501.2	220018	34 21 6 761 238	13.0470-3605.2	LD3605	34 32 1 153 109	83.6124-0422.3	330269
34 21 1 160 354	24.3381-8502.5	240664	34 21 6 761 239	13.0460-3605.2	603605	34 32 1 154 327	24.5102-0304.3	331407
34 21 1 160 381	24.3381-8503.5	240515	34 21 6 761 239	13.0470-3605.2	LD3605	34 32 1 154 398	13.0460-7036.2	607036
34 21 1 160 382	11.3381-8504.2	220021	34 21 6 761 241	13.0460-3605.2	603605	34 32 1 154 904	24.5102-0304.3	331407
34 21 1 160 382	24.3381-8504.5	240516	34 21 6 761 241	13.0470-3605.2	LD3605	34 32 1 156 157	24.5113-0423.3	331396
34 21 1 160 397	11.3331-8501.2	220004	34 21 6 761 253	13.0460-3803.2	603803	34 32 1 156 334	83.6124-0331.3	330267
34 21 1 160 397	24.3331-8501.5	240509	34 21 6 778 168	13.0460-3605.2	603605	34 32 1 156 978	03.2125-3011.3	010211
34 21 1 160 398	11.3331-8502.2	220005	34 21 6 778 168	13.0470-3605.2	LD3605	34 32 1 159 165	83.6104-0245.3	330525
34 21 1 160 398	24.3331-8502.5	240510	34 21 9 064 270	03.0137-0151.2	650151	34 32 1 159 878	24.5201-0204.3	331400



Vergleichsliste

Cross reference list - Tabella di conversione codici

Liste des correspondances - Lista referencias



 BMW			 BMW			 CHEVROLET		
34 32 1 159 879	24.5201-0290.3	331401	34 41 1 160 116	24.3727-0212.2	580212	NP1464	03.0137-0267.2	650267
34 32 1 159 881	24.5170-0201.3	331450	34 41 1 160 729	03.0137-0248.2	650248			
34 32 1 159 882	83.7704-0290.3	330826	34 41 1 160 924	03.0137-0248.2	650248	CHRYSLER		
34 32 1 159 887	83.6104-0245.3	330525	34 41 1 162 005	24.3727-0215.2	580215			
34 32 1 159 888	83.6124-0331.3	330267	34 41 1 163 400	03.0137-9700.2	669700	0 4423 368	24.0124-0193.1	424193
34 32 1 159 889	83.6124-0422.3	330269	34 41 6 761 289	03.0137-0248.2	650248	0 4423 812	13.0460-8009.2	608009
34 32 1 159 890	24.5102-0304.3	331407	34 41 6 761 294	03.0137-0150.2	650150	0 4509 340	24.0124-0193.1	424193
34 32 1 159 891	24.5113-0423.3	331396	34 41 6 851 437	03.0137-9700.2	669700	0 4762 682	13.0460-8003.2	608003
34 32 1 160 240	83.6204-0300.3	330548	34 41 6 851 438	03.0137-9701.2	669701	0 4773 264	13.0460-8003.2	608003
34 32 1 160 428	83.6204-0300.3	330548	34 41 9 064 019	03.0137-9062.2	669062	0 4797 568	13.0460-8003.2	608003
34 32 1 189 882	83.7704-0290.3	330826	34 41 9 064 266	03.0137-9058.2	669058	0 4882 107	13.0460-8003.2	608003
34 32 1 235 736	24.5224-0330.3	331263	34 41 9 064 274	03.0137-9148.2	669148	0 5011 743AA	13.0460-8003.2	608003
34 32 1 237 261	83.6104-0470.3	330253	34 41 9 064 497	03.0137-9062.2	669062	0 5018 595AA	13.0460-8003.2	608003
34 32 4 051 524	24.5170-0201.3	331450	61 31 1 361 896	24.8190-0215.2	620215	0 5098 065AA	24.0109-0114.1	409114
34 32 4 650 315	83.7704-0290.3	330826	61 31 1 362 977	10.0522-4005.1	340029	0 5098 065AA	24.0309-0114.1	509114
34 33 1 116 365	03.6058-0501.3	320074				0 5098 066AA	24.0109-0114.1	409114
34 33 1 117 162	10.0144-4216.3	340013	BÜSSING			0 5098 066AA	24.0309-0114.1	509114
34 33 1 117 397	10.0504-0113.3	340021	11 165 108 105	24.3526-0110.3	340018	0 5143 633AA	13.0460-4047.2	604047
34 33 1 117 398	10.0515-0515.3	340024	13 3102 2201	83.6123-0381.3	330262	0 5143 633AA	13.0470-4047.2	LD4047
34 33 1 119 875	10.0144-4216.3	340013	82 997 416 054	03.3125-0401.3	010290	4423 368	24.0124-0193.1	424193
34 33 1 150 231	03.7760-0902.4	300088	90 810 518 186	03.3150-0101.3	010321	4423 812	13.0460-8009.2	608009
34 33 1 150 918	10.0144-4234.3	340014	90 810 520 195	03.3508-0501.3	310017	4509 340	24.0124-0193.1	424193
34 33 1 150 922	10.0522-4002.1	340028	90 810 520 377	03.3318-0800.2	390112	4762 682	13.0460-8003.2	608003
34 33 1 152 494	03.6045-0620.3	320040	90 810 522 203	03.3508-0401.3	310014	4773 264	13.0460-8003.2	608003
34 33 1 152 825	10.0144-4216.3	340013	90 810 522 204	03.3508-0401.3	310014	4797 568	13.0460-8003.2	608003
34 33 1 153 303	10.0504-0113.3	340021	90 810 522 212	03.3508-0501.3	310017	4882 107	13.0460-8003.2	608003
34 33 1 154 024	03.7760-0902.4	300088	90 810 522 339	03.3509-0100.3	310057	5011 743AA	13.0460-8003.2	608003
34 33 1 155 270	03.2123-8711.3	010196	90 810 522 426	03.3517-0300.1	390323	5018 595AA	13.0460-8003.2	608003
34 33 1 156 925	10.0144-4234.3	340014	90 810 522 495	83.6103-0320.3	330224	5098 065AA	24.0109-0114.1	409114
34 33 1 156 978	03.2125-3011.3	010211	90 810 525 166	24.3526-0810.3	340037	5098 065AA	24.0309-0114.1	509114
34 33 1 157 199	03.7760-0902.4	300088	90 810 525 170	83.6103-0260.3	330221	5098 066AA	24.0109-0114.1	409114
34 33 1 157 210	10.0515-0515.3	340024	90 810 525 179	83.6103-0320.3	330224	5098 066AA	24.0309-0114.1	509114
34 33 1 157 416	03.7760-0902.4	300088	90 810 526 180	83.6103-0500.3	330230	5143 633AA	13.0460-4047.2	604047
34 33 1 159 749	10.0515-9002.3	340026	90 810 526 183	83.6103-0500.3	330230	5143 633AA	13.0470-4047.2	LD4047
34 33 1 162 054	10.0515-0515.3	340024	90 810 526 186	83.6103-0600.3	330233	K05011743AA	13.0460-8003.2	608003
34 33 1 162 056	10.0515-9002.3	340026	90 810 618 186	03.3150-0101.3	010321	K05011743AB	13.0460-8003.2	608003
34 34 1 156 716	03.6055-0303.3	320064	90 810 826 105	83.6103-0260.3	330221	K05018595AA	13.0460-8003.2	608003
34 35 1 153 964	24.8190-0201.2	620201	90 810 826 113	83.6103-0320.3	330224			
34 35 1 179 819	24.8190-0213.2	620213				CITROEN		
34 35 1 179 820	24.8190-0214.2	620214	CHEVROLET			00 176 894 00	24.3222-1118.3	020315
34 35 1 179 821	24.8190-0215.2	620215	9197912	24.0125-0119.1	425119	16 092 527 80	13.0460-5958.2	605958
34 35 1 180 432	24.8190-0214.2	620214	9197912	24.0325-0119.1	525119	17 689 400	24.3222-1118.3	020315
34 35 1 180 780	24.8190-0215.2	620215	15254670	11.8171-0008.1	990049	2150 55	24.3728-0515.2	590515
34 35 1 180 781	24.8190-0214.2	620214	90121445	24.0120-0115.1	420115	2150 Q3	24.3728-0315.2	590315
34 35 1 180 782	24.8190-0213.2	620213	90121445	24.0320-0115.1	520115	2150 R7	24.3728-0305.2	590305
34 35 1 181 802	24.8190-0224.2	620224	90235420	03.3217-3512.3	020032	4224 03	03.0137-9700.2	669700
34 35 1 182 270	10.0522-4005.1	340029	90297765	24.3521-1701.5	240001	4241 4L	03.0520-5720.3	695720
34 35 9 058 889	24.8190-0201.2	620201	90297766	24.3521-1702.5	240002	4241 5T	03.0520-2022.3	692022
34 41 0 005 254	03.0137-9062.2	669062	90487042	24.3521-1701.5	240001	4241 5V	03.0420-1620.3	681620
34 41 0 304 724	03.0137-9062.2	669062	90487043	24.3521-1702.5	240002	4241 5Y	03.0520-2620.3	692620
34 41 0 410 825	03.0137-9062.2	669062	90487402	24.0124-0115.1	424115	4241 6A	03.0520-0519.3	690519
34 41 1 100 550	03.0137-9700.2	669700	90487402	24.0324-0115.1	524115	4241 6C	03.0520-1619.3	691619
34 41 1 103 128	24.3727-0202.2	580202	90496327	24.0125-0119.1	425119	4241 E7	03.0137-0195.2	650195
34 41 1 114 215	24.3727-0201.2	580201	90496327	24.0325-0119.1	525119	4241 E8	03.0137-0196.2	650196
34 41 1 118 053	03.0137-0149.2	650149	90511111	24.0120-0115.1	420115	4241 G3	03.0137-0261.2	650261
34 41 1 120 189	24.3727-0206.2	580206	90511162	13.0460-7052.2	607052	4241 H8	03.0137-0330.2	650330
34 41 1 121 512	03.0137-0150.2	650150	90512029	24.0125-0119.1	425119	4241 H9	03.0137-0269.2	650269
34 41 1 150 784	24.3727-0220.2	580220	90512029	24.0325-0119.1	525119	4241 J1	03.0137-0312.2	650312
34 41 1 150 896	24.3727-0209.2	580209	95975171	24.3219-1767.3	020552	4241 J5	03.0137-0312.2	650312
34 41 1 151 198	03.0137-9700.2	669700	96175281	24.0220-0001.2	480013	4241 J6	03.0137-0196.2	650196
34 41 1 152 689	24.3727-0220.2	580220	96179110	24.0124-0115.1	424115	4241 J9	03.0137-0196.2	650196
34 41 1 153 582	24.3727-0213.2	580213	96193089	24.3521-1701.5	240001	4241 L3	03.0137-0196.2	650196
34 41 1 154 244	24.3727-0219.2	580219	96193090	24.3521-1702.5	240002	4241 L4	03.0137-0261.2	650261
34 41 1 154 401	24.3727-0212.2	580212	96193771	24.0220-0036.1	480149	4242 25	03.0520-0519.3	690519
34 41 1 154 681	24.3727-0212.2	580212	96226977	11.9481-9871.2	220681	4242 29	03.0520-1619.3	691619
34 41 1 155 523	03.0137-0150.2	650150	96226978	11.9481-9872.2	220682	4246 L6	24.0112-0143.1	412143
34 41 1 156 356	24.3727-0220.2	580220	96574718	24.3219-1767.3	020552	4246 L8	24.0126-0106.1	426106
34 41 1 157 823	03.0137-0149.2	650149	11046948372	13.0460-7051.2	607051	4246 L8	24.0326-0106.1	526106
34 41 1 158 423	24.3727-0213.2	580213	11046952012	13.0460-7052.2	607052	4246 N5	24.0116-0105.1	416105
34 41 1 159 467	03.0137-0149.2	650149	NP1441	03.0137-0267.2	650267	4246 R5	24.0120-0133.1	420133
34 41 1 159 468	03.0137-0150.2	650150						



Vergleichsliste

Cross reference list - Tabella di conversione codici

Liste des correspondances - Lista referencias



CITROEN		CITROEN		CITROEN				
4246 R5	24.0320-0133.1	520133	4400 J4	11.3481-9833.2	220561	4806 61	24.5229-0199.3	330534
4246 T3	24.0109-0121.2	409121	4400 J4	24.3481-9833.5	240479	4806 64	24.5228-0245.3	330531
4246 T8	24.0128-0128.1	428128	4400 J5	11.3481-9834.2	220562	4806 65	24.5228-0195.3	330469
4246 T9	24.0122-0142.1	422142	4400 J5	24.3481-9834.5	240480	4806 68	24.5111-0301.3	330499
4246 V0	24.0122-0142.1	422142	4400 T9	24.3431-1701.5	240437	4806 81	24.5111-0301.3	330499
4246 W3	24.0128-0128.1	428128	4400 V0	24.3431-1702.5	240438	4806 83	24.5111-0375.3	331128
4246 W6	24.0120-0133.1	420133	4401 63	24.3481-1615.5	240031	4806 84	24.5111-0460.3	330603
4246 W6	24.0320-0133.1	520133	4401 64	24.3481-1616.5	240032	4806 85	24.5111-0438.3	330568
4247 22	24.0225-4002.1	480048	4402 70	24.3225-1101.3	020294	4806 86	24.5229-0255.3	330581
4247 24	24.0222-8017.1	480071	4402 81	24.3226-1101.3	020296	4806 91	24.5111-0460.3	330603
4247 32	24.0218-0016.1	480011	4402 86	24.3220-1607.3	020234	4806 A8	24.5111-0460.3	330603
4247 32	24.0218-0716.2	480203	4402 87	24.3220-1608.3	020235	4806 A9	24.5111-0460.3	330603
4247 33	24.0216-5001.1	480001	4402 90	24.3219-1603.3	020200	4806 C4	83.6401-0159.3	330746
4247 33	24.0216-5701.2	480212	4402 91	24.3219-1604.3	020201	4806 E0	24.5111-0460.3	330603
4247 35	24.0218-0020.1	480074	4402 93	24.3219-1609.3	020319	4816 26	24.5228-0185.3	330107
4247 35	24.0218-0720.2	480205	4402 94	24.3219-1610.3	020320	4816 27	24.5112-0260.3	330577
4247 40	24.0220-3014.1	480090	4402 97	24.3220-1617.3	020244	4816 31	24.5112-0285.3	330604
4247 42	24.0216-5001.1	480001	4402 98	24.3220-1618.3	020245	4816 35	24.5112-0285.3	330604
4247 42	24.0216-5701.2	480212	4402 A0	24.3220-1615.3	020242	4816 36	24.5112-0315.3	330509
4247 43	24.0216-5001.1	480001	4402 A1	24.3220-1616.3	020243	4834 76	24.3727-0527.2	580527
4247 43	24.0216-5701.2	480212	4402 A8	24.3220-1711.3	020409	4861 32	24.6513-1701.3	320160
4247 44	24.0218-0020.1	480074	4402 C3	24.3220-1711.3	020409	4861 98	24.6512-1507.3	320023
4247 44	24.0218-0720.2	480205	4427 55	13.0460-0435.2	610435	5 429 669 S	24.0120-0108.1	420108
4249 76	24.0122-0147.1	422147	4427 59	13.0460-0206.2	610206	5 462 429	13.0460-4911.2	604911
4249 97	24.0122-0142.1	422142	4427 64	13.0460-0406.2	610406	5 488 527	24.3217-1101.3	020309
4249 F0	24.0120-0133.1	420133	4427 65	13.0460-0403.2	610403	5 950 690	24.5112-0285.3	330604
4249 F0	24.0320-0133.1	520133	4427 66	13.0460-0424.2	610424	75 386 82	24.0116-0106.1	416106
4249 F5	24.0108-0106.1	408106	4427 70	11.8116-0073.1	390498	75 485 825	24.0109-0108.1	409108
4251 28	13.0460-4066.2	604066	4427 84	11.8116-0129.1	390591	75 492 063	83.6196-0325.3	330727
4251 29	13.0460-4911.2	604911	4427 94	13.0460-0424.2	610424	75 492 434	24.3228-1101.3	020297
4251 33	13.0460-3973.2	603973	4439 14	11.0101-5407.2	260011	75 516 219	13.0460-4906.2	604906
4251 37	13.0460-3962.2	603962	4439 33	11.8171-0008.1	990049	75 516 220	13.0460-4906.2	604906
4251 38	13.0460-7088.2	607088	4448 70	11.0441-4501.2	250015	75 529 364	24.0120-0108.1	420108
4251 39	13.0460-7088.2	607088	4448 74	11.0441-4811.2	250024	75 530 008	24.3228-1102.3	020347
4251 44	13.0460-2817.2	602817	4448 76	11.0441-3602.2	250008	75 685 01	24.0113-0168.1	413168
4251 45	13.0460-3986.2	603986	4535 G5	03.7740-4002.4	300108	79 01 440 250	24.3222-1102.3	020257
4251 46	13.0460-3823.2	603823	4545 43	24.0751-1136.3	360059	79 10 030 170	24.3220-1105.3	020216
4251 47	13.0460-3962.2	603962	4545 54	24.0721-1185.3	360058	9 940 558	24.3226-1101.3	020296
4251 56	13.0460-3956.2	603956	4545 74	24.0741-1114.3	360067	91 500 635	24.5228-0185.3	330107
4251 57	13.0460-3972.2	603972	4575 08	24.7718-7301.2	990024	91 508 338	24.0110-0187.1	410187
4251 58	13.0460-3973.2	603973	4601 83	24.2122-0801.3	010373	91 509 908	24.0222-8017.1	480071
4251 59	13.0460-4910.2	604910	4601 85	03.2120-2031.3	010106	91 510 533	03.2120-2031.3	010106
4251 70	13.0460-7088.2	607088	4601 88	24.2122-0801.3	010373	91 517 694	24.0120-0131.1	420131
4251 83	13.0460-4956.2	604956	4601 97	03.2119-3389.3	010057	91 517 695	24.0120-0132.1	420132
4251 97	13.0460-3823.2	603823	4601 98	24.2122-1704.3	010423	91 517 695	24.0320-0132.1	520132
4252 11	13.0460-3986.2	603986	4601 A2	03.2119-3389.3	010057	91 518 534	03.2119-3389.3	010057
4252 57	13.0460-3823.2	603823	4601 F1	24.2120-1722.3	010544	91 518 535	03.2119-3389.3	010057
4252 74	13.0460-3823.2	603823	4601 F4	24.2120-1722.3	010544	91 518 816	24.5112-0325.3	330415
4252 91	13.0460-3956.2	603956	4601 G5	03.2120-4221.3	010605	94 04 308 348	03.0137-9055.2	669055
4252 92	13.0460-3972.2	603972	4601 G7	03.2122-1331.3	010607	94 04 308 508	03.0137-9169.2	669169
4253 88	13.0460-5958.2	605958	4601 G8	03.2122-1331.3	010607	94 04 402 708	24.3225-1101.3	020294
4254 30	13.0460-5958.2	605958	4601 H4	03.2120-2031.3	010106	94 04 402 868	24.3220-1607.3	020234
4254 90	13.0460-3823.2	603823	4601 H8	03.2120-2031.3	010106	94 04 402 878	24.3220-1608.3	020235
4308 11	03.0137-9188.2	669188	4745 F6	24.3727-0304.2	580304	94 04 601 858	03.2120-2031.3	010106
4308 30	03.0137-9032.2	669032	4745 F8	24.3727-0307.2	580307	94 04 601 978	03.2119-3389.3	010057
4308 34	03.0137-9055.2	669055	4745 G1	24.3727-0306.2	580306	94 78 267 980	24.0218-0016.1	480011
4308 38	03.0137-9228.2	669228	4745 G5	24.3727-0312.2	580312	94 78 267 980	24.0218-0716.2	480203
4308 40	03.0137-9079.2	669079	4745 G6	24.3727-0311.2	580311	95 027 199	24.0108-0107.1	408107
4308 50	03.0137-9169.2	669169	4745 H5	24.3727-0330.2	580330	95 030 547	24.0109-0121.2	409121
4308 52	03.0137-9086.2	669086	4745 H7	24.3727-0816.2	580816	95 493 191	24.2120-1502.3	010405
4308 53	03.0137-9175.2	669175	4745 K4	24.3727-0316.2	580316	95 493 193	24.2117-1501.3	010398
4308 55	03.0137-9220.2	669220	4745 K5	24.3727-0317.2	580317	95 494 208	24.2119-1705.3	010460
4308 57	03.0137-9228.2	669228	4745 L2	24.3727-0310.2	580310	95 494 973	24.5119-0435.3	330472
4308 58	03.0137-9158.2	669158	4745 N6	24.3727-0324.2	580324	95 496 106	24.3727-0310.2	580310
4308 61	03.0137-9228.2	669228	4745 T4	24.3727-0816.2	580816	95 496 746	24.3728-0304.2	590304
4400 83	24.3481-1609.7	220197	4806 24	24.5112-0362.3	330512	95 534 349	13.0460-4910.2	604910
4400 84	24.3481-1610.7	220198	4806 35	24.5112-0435.3	330524	95 555 655	24.2120-1502.3	010405
4400 G7	11.3481-9833.2	220561	4806 36	24.5112-0436.3	330574	95 565 564	13.0460-4911.2	604911
4400 G7	24.3481-9833.5	240479	4806 52	24.5112-0155.3	330507	95 569 738	24.3220-1105.3	020216
4400 G8	11.3481-9834.2	220562	4806 55	24.5111-0330.3	330160	95 569 739	24.3222-1102.3	020257
4400 G8	24.3481-9834.5	240480	4806 56	24.5111-0290.3	330108	95 570 824	13.0460-4900.2	604900



Vergleichsliste

Cross reference list - Tabella di conversione codici



Liste des correspondances - Lista referencias

CITROEN			CITROEN			CITROEN		
95 570 825	13.0460-4900.2	604900	95 659 641	13.0460-3916.2	603916	ZF 04 450 938	24.3727-0527.2	580527
95 571 755	24.2117-1501.3	010398	95 659 642	13.0460-4956.2	604956	ZF 04 460 471	24.3728-0515.2	590515
95 571 759	24.2117-1501.3	010398	95 659 661	03.0137-0211.2	650211	ZF 04 477 793	24.5112-0260.3	330577
95 575 080	24.0110-0183.1	410183	95 659 662	03.0137-9125.2	669125	ZF 05 952 297	24.5112-0362.3	330512
95 582 061	24.0107-0105.2	407105	95 659 671	03.0137-0196.2	650196	ZF 07 567 861	24.5112-0436.3	330574
95 582 062	24.0107-0105.2	407105	95 659 673	24.3219-1609.3	020319	ZF 07 567 862	24.5112-0435.3	330524
95 589 273	13.0460-3915.2	603915	95 659 674	24.3219-1610.3	020320	ZF 07 568 440	24.0116-0105.1	416105
95 590 838	13.0460-0403.2	610403	95 659 676	03.0137-0197.2	650197	ZF 07 568 501	24.0113-0168.1	413168
95 594 172	24.6512-1507.3	320023	95 661 746	24.0110-0183.1	410183	ZF 07 570 315	24.5112-0260.3	330577
95 599 101	24.5228-0200.3	330470	95 661 747	24.0120-0132.1	420132	ZF 07 570 316	24.5112-0285.3	330604
95 599 322	24.0107-0100.1	407100	95 661 747	24.0320-0132.1	520132	ZF 09 937 665	24.2122-0801.3	010373
95 606 669	24.3222-1118.3	020315	95 661 748	24.0110-0187.1	410187	ZF 09 938 829	24.2122-0801.3	010373
95 607 096	24.3481-1609.7	220197	95 661 749	24.0108-0106.1	408106	ZF 09 938 868	24.3225-1101.3	020294
95 607 097	24.3481-1610.7	220198	95 661 796	24.0112-0136.2	412136	ZF 93 500 520	24.0116-0105.1	416105
95 608 853	24.3219-1603.3	020200	95 661 798	13.0460-4911.2	604911	ZF 93 500 521	24.0116-0106.1	416106
95 608 854	24.3219-1604.3	020201	95 661 810	24.0108-0107.1	408107			
95 610 161	24.3727-0324.2	580324	95 661 812	24.0122-0141.1	422141			
95 610 218	24.3728-0304.2	590304	95 661 813	24.0126-0100.1	426100			
95 611 505	24.3727-0310.2	580310	95 661 814	24.0109-0121.2	409121			
95 614 553	03.0137-9188.2	669188	95 661 849	24.0107-0105.2	407105			
95 614 560	13.0460-0406.2	610406	95 661 851	03.0137-0330.2	650330	41 06 021 92R	13.0460-2834.2	602834
95 616 818	13.0460-2956.2	602956	95 661 871	13.0460-2825.2	602825	60 01 547 616	24.3481-1611.5	240029
95 619 206	24.0216-5001.1	480001	95 663 080	03.0137-0092.2	650092	60 01 547 617	24.3481-1612.5	240030
95 619 206	24.0216-5701.2	480212	95 666 970	13.0460-3952.2	603952	60 01 547 619	13.0460-2834.2	602834
95 619 515	03.0137-0195.2	650195	95 666 971	13.0460-3954.2	603954	60 01 547 630	03.0137-0312.2	650312
95 619 516	03.0137-9079.2	669079	95 666 972	13.0460-3954.2	603954	60 01 547 684	24.0112-0116.1	412116
95 619 550	13.0460-4042.2	604042	95 666 973	13.0460-3916.2	603916	60 01 547 703	24.0220-3021.1	480127
95 619 603	13.0460-0424.2	610424	95 667 764	13.0460-4956.2	604956	60 01 547 816	24.5111-0300.3	330407
95 619 604	11.0441-4501.2	250015	95 667 765	13.0460-2901.2	602901	60 01 547 819	24.5229-0285.3	330032
95 624 482	13.0460-4911.2	604911	95 667 786	13.0460-2902.2	602902	60 01 547 911	13.0460-2834.2	602834
95 624 483	13.0460-4900.2	604900	95 667 787	13.0460-3956.2	603956	60 01 548 126	24.0218-0032.1	480118
95 624 484	13.0460-3915.2	603915	95 667 788	13.0460-3972.2	603972	60 01 548 578	24.0121-0106.1	421106
95 624 920	24.3481-1609.7	220197	95 667 809	13.0460-4956.2	604956	60 01 549 211	24.0112-0116.1	412116
95 624 921	24.3481-1610.7	220198	95 667 809	24.0120-0133.1	420133	60 01 551 097	24.5229-0285.3	330032
95 624 970	13.0460-2901.2	602901	95 667 810	24.0320-0133.1	520133	60 01 551 098	24.5111-0300.3	330407
95 625 020	03.0137-0285.2	650285	95 667 811	24.0122-0142.1	422142	77 00 419 824	24.0218-0032.1	480118
95 632 048	24.0120-0133.1	420133	95 668 067	24.0109-0122.1	409122	77 00 419 824	24.0218-0732.2	480207
95 632 048	24.0320-0133.1	520133	95 668 068	24.3220-1617.3	020244	77 00 839 322	24.0220-3021.1	480127
95 632 790	24.5120-0435.3	330488	95 668 069	24.3220-1618.3	020245	77 01 201 758	03.0137-0312.2	650312
95 637 322	24.0122-0141.1	422141	95 668 070	24.3220-1615.3	020242	77 01 201 769	24.3481-1611.5	240029
95 640 895	13.0460-2902.2	602902	96 012 770	24.3220-1616.3	020243	77 01 201 770	24.3481-1612.5	240030
95 643 713	03.0137-0330.2	605330	96 026 873	24.0108-0106.1	408106	77 01 203 979	03.0137-0312.2	650312
95 643 714	03.0137-0269.2	650269	96 026 875	24.3727-0308.2	580308	77 01 205 518	03.0137-9228.2	669228
95 644 348	03.2119-3389.3	010057	96 032 560	24.3727-0309.2	580309	77 01 205 720	03.0137-0312.2	650312
95 644 437	03.0420-1620.3	681620	96 032 561	24.3727-0304.2	580304	77 01 206 339	24.0121-0106.1	421106
95 646 300	13.0460-4042.2	604042	96 032 564	24.3727-0305.2	580305	77 01 206 962	03.0137-0312.2	650312
95 647 733	13.0460-2825.2	602825	96 032 565	24.3727-0306.2	580306	77 01 208 111	03.0137-0312.2	650312
95 651 053	13.0460-0206.2	610206	96 037 346	24.5411-0550.3	330567	77 01 208 265	13.0460-2834.2	602834
95 653 061	13.0460-4906.2	604906	96 054 779	24.0122-0141.1	422141	77 01 209 639	13.0460-2834.2	602834
95 653 213	03.0137-0195.2	650195	96 070 525	24.0110-0187.1	410187	77 01 210 142	13.0460-2834.2	602834
95 654 085	13.0460-4956.2	604956	96 075 716	24.5112-0155.3	330507	77 11 130 071	13.0460-2834.2	602834
95 654 086	13.0460-3916.2	603916	96 075 932	24.2122-1704.3	010423			
95 655 344	03.0137-0195.2	650195	96 080 322	24.5111-0290.3	330108			
95 658 555	24.3481-1615.5	240031	96 097 749	24.3728-0310.2	590310	90009594	24.3219-1767.3	020552
95 658 556	24.3481-1616.5	240032	96 099 616	24.0126-0100.1	426100	90121445	24.0120-0115.1	420115
95 658 557	13.0460-2981.2	602981	96 104 679	24.3728-0305.2	590305	90121445	24.0320-0115.1	520115
95 658 571	03.0137-9175.2	669175	96 109 017	24.5111-0355.3	330757	90235420	03.3217-3512.3	020032
95 658 617	13.0460-4042.2	604042	96 113 241	24.0731-1133.3	360156	90235422	24.3219-1767.3	020552
95 658 639	13.0460-3916.2	603916	96 121 652	24.3727-0311.2	580311	90235948	24.3727-0730.2	580730
95 659 340	13.0460-3943.2	603943	96 121 653	24.3727-0312.2	580312	90374076	24.3219-1767.3	020552
95 659 341	13.0460-3954.2	603954	96 124 223	24.5228-0195.3	330469	90421738	11.8116-0129.1	390591
95 659 353	13.0460-2825.2	602825	96 124 230	24.5111-0425.3	330278	90443261	24.3219-1767.3	020552
95 659 470	03.0137-0261.2	650261	96 169 410	24.5228-0185.3	330107	90498300	24.3219-1715.3	020122
95 659 472	03.0137-9086.2	669086	AM 451 018 A	03.0137-0092.2	650092	96175281	24.0220-0001.2	480013
95 659 474	24.3220-1603.3	020230	AM 451 23	24.0107-0100.1	407100	96179110	24.0124-0115.1	424115
95 659 475	24.3220-1604.3	020231	AMN 453 05	24.3215-1602.3	020355	96179110	24.0324-0115.1	524115
95 659 534	03.2120-2031.3	010106	AYA 453 011 A	24.3228-1101.3	020297	96192182	11.9481-9871.2	220681
95 659 616	13.0460-3952.2	603952	E169002	24.0120-0133.1	420133	96192183	11.9481-9872.2	220682
95 659 622	24.0218-0020.1	480074	E169114	24.0109-0122.1	409122	96193089	24.3521-1701.5	240001
95 659 622	24.0218-0720.2	480205	ZF 00 791 462	24.6513-1701.3	320160	96193090	24.3521-1702.5	240002
95 659 640	13.0460-3947.2	603947	ZF 04 449 694	24.0225-4002.1	480048	96193771	24.0220-0036.1	480149

Vergleichsliste

Cross reference list - Tabella di conversione codici

Liste des correspondances - Lista referencias



DAEWOO		DAIMLER		FIAT				
96226977	11.9481-9871.2	220681	JLM 1305	24.0123-0108.1	423108	793330	13.0460-2941.2	602941
96226978	11.9481-9872.2	220682	JLM 1829	13.0460-7138.2	607138	793355	13.0460-2941.2	602941
96430417	03.0137-0267.2	650267				793438	24.3215-1102.3	020156
96574718	24.3219-1767.3	020552	FERRARI			793439	24.3219-1102.3	020190
11010154072	11.0101-5407.2	260011				793460	13.0460-2949.2	602949
11044148112	11.0441-4811.2	250024	101393	83.6215-0400.3	330323	793470	13.0460-2941.2	602941
11044152022	11.0441-5202.2	250026	116373	24.5224-0330.3	331263	793485	13.0460-3942.2	603942
11046948322	13.0460-7051.2	607051	118100	83.6101-0325.3	330206	793774	13.0460-2952.2	602952
11046948372	13.0460-7051.2	607051	118101	83.7758-0381.3	331485	794079	13.0460-2948.2	602948
11046952012	13.0460-7052.2	607052	127838	83.6101-0240.3	330202	794091	13.0460-2949.2	602949
11817100081	11.8171-0008.1	990049	95691531	13.0441-4009.2	250077	794858	13.0460-2949.2	602949
90235948-B	24.3727-0730.2	580730				794870	13.0460-2948.2	602948
NP1441	03.0137-0267.2	650267	FIAT			794937	24.2122-1716.3	010485
NP1464	03.0137-0267.2	650267				794962	13.0460-2949.2	602949
S4520005	03.0137-0267.2	650267	790204	24.2119-0806.3	010345	795428	13.0460-2809.2	602809
S4520006	03.0137-0267.2	650267	790215	24.3219-0801.3	020181	795621	24.2120-1710.3	010468
DAF			790605	13.0460-3936.2	603936	4108899	24.5105-0139.3	331216
5516017643	24.3526-1900.0	340038	790608	24.2119-0827.3	010350	4121616	24.3219-0801.3	020181
105 902	03.3508-8302.3	310046	790610	24.3217-1115.3	020310	4121621	24.3222-0801.3	020248
110 634	24.5170-0315.3	331309	790833	24.3219-0803.3	020183	4139481	24.3219-0802.3	020182
186 082	03.3318-0800.2	390112	790837	24.2119-0827.3	010350	4139486	24.3219-0802.3	020182
502 808	13.0460-3010.2	603010	790838	24.2119-0827.3	010350	4139496	24.5207-0205.3	330042
532 221	03.0370-1038.2	051038	790853	24.3223-0802.3	020286	4167824	24.5207-0205.3	330042
532 221	03.0370-9998.2	059998	790860	24.2119-0806.3	010345	4167825	24.2119-0831.3	010416
562 327	03.0370-1131.2	051131	790981	24.6046-0801.3	320116	4184518	24.2119-0832.3	010417
571 754	03.3138-2001.3	010310	791328	24.2119-0829.3	010351	4188225	24.2119-0831.3	010416
573 788	03.3508-0501.3	310017	791440	24.2119-0826.3	010349	4188357	24.2119-0832.3	010417
892 112	83.6104-0220.3	330474	791442	24.3481-1703.5	240051	4189021	24.2119-0832.3	010417
892 365	24.3526-0810.3	340037	791443	24.3481-1704.5	240052	4203721	24.2119-0832.3	010417
892 402	03.3217-0401.3	020023	791444	24.3481-1703.5	240051	4208311	24.0111-0130.1	411130
893 596	03.3508-8302.3	310046	791445	24.3481-1704.5	240052	4213025	24.5209-0280.3	330044
DAIHATSU			791452	24.2119-0806.3	010345	4231433	24.2119-0832.3	010417
04491-60020-000	13.0460-5816.2	605816	791456	24.6513-0801.3	320117	4231435	24.2119-0831.3	010416
04491-60060-000	13.0460-5816.2	605816	791462	24.6513-1701.3	320160	4234923	24.5105-0139.3	331216
04491-87602-000	13.0460-5816.2	605816	791906	13.0460-3939.2	603939	4253987	24.5209-0280.3	330044
04491-87603-000	13.0460-5816.2	605816	791939	13.0460-2941.2	602941	4256246	24.5209-0250.3	330043
04491-87606-000	13.0460-5816.2	605816	792040	24.2120-0801.3	010362	4257052	24.5209-0250.3	330043
04491-87609-000	13.0460-5816.2	605816	792088	24.2119-0826.3	010349	4270732	24.5209-0280.3	330044
04492-87101-000	13.0460-5972.2	605972	792113	13.0460-3939.2	603939	4277188	24.3215-0802.3	020308
04492-87102-000	13.0460-5972.2	605972	792383	13.0460-3904.2	603904	4293206	24.5209-0353.3	330046
04492-87707-000	13.0460-5824.2	605824	792489	13.0460-2941.2	602941	4296669	13.0460-3936.2	603936
04492-87708-000	13.0460-5824.2	605824	792539	13.0460-3939.2	603939	4298756	24.3223-0801.3	020316
04495-87601-000	03.0137-0316.2	650316	792561	13.0460-3940.2	603940	4306333	24.2119-0832.3	010417
04495-87603-000	03.0137-0316.2	650316	792589	13.0460-3939.2	603939	4341780	24.2119-0831.3	010416
04495-87605-000	03.0137-0316.2	650316	792698	13.0460-3939.2	603939	4347802	24.2119-0831.3	010416
04495-87606-000	03.0137-0316.2	650316	792703	13.0460-2941.2	602941	4348052	24.5209-0280.3	330044
04495-87706-000	03.0137-0186.2	650186	792707	13.0460-3904.2	603904	4363679	24.2119-0832.3	010417
04495-87707-000	03.0137-0315.2	650315	792722	24.2119-0826.3	010349	4373350	24.2119-0831.3	010416
04495-87708-000	03.0137-0315.2	650315	792725	13.0460-3940.2	603940	4373614	24.3219-0801.3	020181
04495-87712-000	03.0137-0186.2	650186	792895	24.2120-0801.3	010362	4373639	24.2119-0832.3	010417
43512-87215-000	24.0116-0127.1	416127	792915	24.2119-0826.3	010349	4373680	24.2119-0831.3	010416
43512-87216-000	24.0110-0235.1	410235	792987	24.2119-0806.3	010345	4374057	24.3219-0802.3	020182
43512-87221-000	24.0110-0235.1	410235	792999	24.2119-0826.3	010349	4374063	24.3222-0801.3	020248
43512-87509-000	24.0110-0235.1	410235	793007	24.2119-0826.3	010349	4377102	24.0111-0129.1	411129
43512-87604-000	24.0118-0121.1	418121	793010	24.2119-0826.3	010349	4379680	24.0218-5001.1	480012
43512-87605-000	24.0118-0121.1	418121	793034	24.2119-0827.3	010350	4385812	24.0111-0130.1	411130
43512-87608-000	24.0118-0121.1	418121	793039	24.2119-0827.3	010350	4394460	24.3219-0801.3	020181
43512-87709-000	24.0111-0139.1	411139	793053	24.2119-0827.3	010350	4394469	24.3223-0802.3	020286
43512-87710-000	24.0118-0126.1	418126	793120	13.0460-2948.2	602948	4394596	24.2119-0815.3	010347
43512-87717-000	24.0111-0139.1	411139	793184	13.0460-2949.2	602949	4394597	24.2119-0815.3	010347
43512-87718-000	24.0118-0126.1	418126	793193	24.2119-0806.3	010345	4395137	24.2119-0831.3	010416
43512-87725-000	24.0118-0126.1	418126	793234	24.2119-0829.3	010351	4397019	24.2119-0806.3	010345
43512-87727-000	24.0111-0139.1	411139	793266	24.2120-1710.3	010468	4406021	24.3727-0503.2	580503
			793272	13.0460-3942.2	603942	4410503	24.2119-0806.3	010345
			793289	24.2119-0832.3	010417	4423942	24.2119-0806.3	010345
			793290	24.2119-0831.3	010416	4434816	13.0460-3936.2	603936
			793298	24.2119-0831.3	010416	4448411	24.0112-0112.1	412112
			793307	24.2119-0806.3	010345	4449694	24.0225-4002.1	480048
			793309	24.2119-0815.3	010347	4450931	24.0113-0168.1	413168
DAIMLER			793322	13.0460-3940.2	603940	4450938	24.3727-0527.2	580527
			793323	13.0460-3940.2	603940	4464149	24.5209-0280.3	330044
DBC 6595	24.8190-1302.2	621302	793325	13.0460-3939.2	603939	4471492	24.5209-0280.3	330044



Vergleichsliste

Cross reference list - Tabella di conversione codici

Liste des correspondances - Lista referencias



FIAT		FIAT		FIAT				
5880891	03.0137-0015.2	650015	7569161	24.5112-0390.3	330517	9941243	03.0137-0330.2	650330
5881040	03.0137-0015.2	650015	7569593	24.5112-0315.3	330509	9941666	24.3344-1703.5	240117
5881214	03.0137-0015.2	650015	7569600	24.0222-8018.1	480078	9941667	24.3344-1704.5	240118
5882984	13.0460-5409.2	605409	7570315	24.5112-0260.3	330577	9941669	13.0460-2951.2	602951
5882985	13.0460-5410.2	605410	7570316	24.5112-0285.3	330604	9941872	13.0460-2979.2	602979
5888144	03.0137-0015.2	650015	7573814	24.3727-0519.2	580519	9941873	13.0460-2962.2	602962
5888146	03.0137-0330.2	650330	7586907	24.5112-0160.3	330612	9942902	24.3344-1703.5	240117
5888147	13.0460-2941.2	602941	7592915	24.3728-0501.2	590501	9942903	24.3344-1704.5	240118
5888149	13.0460-3936.2	603936	7599325	24.0218-0011.1	480006	9942904	13.0460-2951.2	602951
5888154	13.0460-3936.2	603936	7607381	24.6513-0801.3	320117	9943323	24.2120-1733.3	010686
5888433	03.0137-0207.2	650207	7609087	24.5112-0384.3	330651	9943934	03.0137-0330.2	650330
5888453	03.0137-0208.2	650208	7609088	24.5112-0360.3	330513	9943935	03.0137-0269.2	650269
5888528	13.0460-5409.2	605409	7609367	24.3727-0509.2	580509	9944329	13.0460-2979.2	602979
5888529	13.0460-5410.2	605410	7610378	24.3728-0503.2	590503	9944386	24.2122-1716.3	010485
5888781	13.0460-2948.2	602948	7613105	24.2119-0806.3	010345	9944678	13.0460-2979.2	602979
5888939	13.0460-3904.2	603904	7615326	24.3727-0510.2	580510	9944784	24.3344-1704.5	240118
5889089	13.0460-2949.2	602949	7615327	24.3727-0511.2	580511	9944785	24.3344-1703.5	240117
5889225	13.0460-3936.2	603936	7615339	24.3727-0513.2	580513	9944814	13.0460-2809.2	602809
5889226	13.0460-3939.2	603939	7615342	24.3727-0006.2	580006	9944861	13.0460-2902.2	602902
5889227	13.0460-3939.2	603939	7615343	24.3727-0521.2	580521	9945070	13.0460-2901.2	602901
5890500	03.0137-0207.2	650207	7619751	24.5228-0223.3	330530	9945076	13.0460-2902.2	602902
5890763	03.0137-0015.2	650015	7645056	24.0120-0142.1	420142	9945371	03.0137-0273.2	650273
5892309	13.0460-3939.2	603939	7645056	24.0320-0142.1	520142	9945379	24.3219-0803.3	020183
5892310	13.0460-3940.2	603940	7649509	24.3728-0502.2	590502	9945496	13.0460-2951.2	602951
5892312	13.0460-3940.2	603940	7649589	24.5112-0315.3	330509	9945582	24.3344-1703.5	240117
5892313	13.0460-2952.2	602952	7650707	24.0120-0143.1	420143	9945584	24.3344-1704.5	240118
5892330	13.0460-2948.2	602948	7655155	24.5112-0360.3	330513	9945629	13.0460-2962.2	602962
5892481	13.0460-2949.2	602949	7655156	24.5112-0384.3	330651	9945760	24.2122-1716.3	010485
5892593	13.0460-3904.2	603904	7661241	24.3727-0507.2	580507	9945762	24.2122-1716.3	010485
5892601	13.0460-2941.2	602941	7663465	24.0111-0119.1	411119	9945821	13.0460-2951.2	602951
5892650	13.0460-2962.2	602962	7663466	24.0112-0127.1	412127	9945822	13.0460-2951.2	602951
5892727	13.0460-2949.2	602949	7667806	24.5228-0223.3	330530	9945823	13.0460-2951.2	602951
5892728	13.0460-2949.2	602949	7670999	24.3728-0502.2	590502	9945911	24.3225-1101.3	020294
5892730	13.0460-2949.2	602949	7671309	24.3727-0518.2	580518	9945939	24.3226-1101.3	020296
5892731	13.0460-2952.2	602952	7671310	24.3727-0509.2	580509	9946023	13.0460-2809.2	602809
5892732	13.0460-2949.2	602949	7674443	24.3728-0503.2	590503	9946227	13.0460-2979.2	602979
5892733	13.0460-2949.2	602949	7685656	24.0111-0119.1	411119	9946385	24.2122-0801.3	010373
5892734	13.0460-2949.2	602949	7696710	24.3219-0803.3	020183	9946560	03.0137-0330.2	650330
5892735	13.0460-2949.2	602949	7710210	24.3728-0503.2	590503	9946561	03.0137-0269.2	650269
5892740	13.0460-4958.2	604958	7710212	24.3728-0502.2	590502	9946750	13.0460-2987.2	602987
5892945	13.0460-2949.2	602949	7714822	24.3727-0521.2	580521	9946898	24.3481-1703.5	240051
5895983	13.0460-2809.2	602809	7722749	24.3728-0503.2	590503	9946899	24.3481-1704.5	240052
5944002	24.5228-0200.3	330470	7722751	24.3728-0502.2	590502	9947007	13.0460-2951.2	602951
5950690	24.5112-0285.3	330604	7724708	24.3728-0515.2	590515	9947017	24.3481-1703.5	240051
5951339	24.3727-0507.2	580507	7740758	24.3222-1701.3	020376	9947018	24.3481-1704.5	240052
5951342	24.3727-0508.2	580508	7750119	24.0218-0011.1	480006	9947098	24.2120-1710.3	010468
5951660	13.0460-3939.2	603939	7757604	24.3220-1116.3	020313	9947099	24.2122-1716.3	010485
5951671	13.0460-3940.2	603940	7759547	24.2419-1721.3	030100	9947106	03.0137-0262.2	650262
5951681	13.0460-2941.2	602941	7767150	24.2120-1710.3	010468	9947938	13.0460-2826.2	602826
5951897	13.0460-3936.2	603936	7769850	24.0222-8018.1	480078	9947943	24.3220-1116.3	020313
5952297	24.5112-0362.3	330512	7777842	24.0218-5001.1	480012	9948200	03.0137-0207.2	650207
5961814	24.0112-0122.1	412122	7779409	24.0120-0142.1	420142	9948232	24.3219-0803.3	020183
5969735	24.3727-0517.2	580517	7779409	24.0320-0142.1	520142	9948235	03.0137-0015.2	650015
5971061	24.5112-0410.3	330494	7784315	24.3728-0503.2	590503	9948315	24.2122-1716.3	010485
5974792	24.0218-5001.1	480012	7785747	24.3728-0502.2	590502	9949173	13.0460-2826.2	602826
5983950	13.0460-2941.2	602941	7789267	24.0110-0209.1	410209	9950437	24.3344-1703.5	240117
5987896	24.3219-1103.3	020408	9937665	24.2122-0801.3	010373	9950438	24.3344-1704.5	240118
7032156	03.2122-0142.3	010128	9938829	24.2122-0801.3	010373	9950477	24.3344-1703.5	240117
7074619	24.2120-0802.3	010363	9938868	24.3225-1101.3	020294	9950478	24.3344-1704.5	240118
7081967	24.2120-0802.3	010363	9939028	13.0460-2901.2	602901	9950479	13.0460-2951.2	602951
7174008	24.2119-0826.3	010349	9939503	13.0460-2962.2	602962	9950521	24.2122-1716.3	010485
7531819	24.0116-0105.1	416105	9939718	03.0137-0330.2	650330	9950550	13.0460-2987.2	602987
7538682	24.0116-0106.1	416106	9940092	13.0460-2901.2	602901	9950647	13.0460-2987.2	602987
7550923	24.0120-0143.1	420143	9940554	24.3225-1101.3	020294	9950677	24.2122-1716.3	010485
7563849	24.5112-0410.3	330494	9940558	24.3226-1101.3	020296	9950713	13.0460-2951.2	602951
7563852	24.5228-0200.3	330470	9940969	13.0460-2962.2	602962	9950714	13.0460-2951.2	602951
7567861	24.5112-0436.3	330574	9941175	13.0460-2980.2	602980	9950814	03.0137-0262.2	650262
7567862	24.5112-0435.3	330524	9941207	13.0460-2901.2	602901	9950853	13.0460-2951.2	602951
7568440	24.0116-0105.1	416105	9941208	13.0460-2902.2	602902	9950865	13.0460-2826.2	602826
7568501	24.0113-0168.1	413168	9941210	03.0137-0269.2	650269	9951116	24.2122-1716.3	010485
7569160	24.5112-0386.3	330516	9941211	13.0460-2962.2	602962	46401730	24.3727-0521.2	580521



Vergleichsliste

Cross reference list - Tabella di conversione codici

Liste des correspondances - Lista referencias



FIAT		FIAT		FIAT				
46403088	24.0122-0147.1	422147	60569163	24.0122-0145.1	422145	60750780	13.0460-3905.2	603905
46403958	24.0122-0107.1	422107	60569164	24.0110-0209.1	410209	60750781	13.0460-7055.2	607055
46403959	24.0122-0147.1	422147	60571548	24.0122-0145.1	422145	60750795	13.0460-3905.2	603905
46403960	24.0111-0119.1	411119	60576335	24.0111-0149.1	411149	60750796	13.0460-7055.2	607055
46408830	24.3727-0545.2	580545	60577826	24.3727-0006.2	580006	60750838	13.0460-2969.2	602969
46416712	24.0120-0142.1	420142	60578093	24.0122-0145.1	422145	60750855	13.0460-3905.2	603905
46416712	24.0320-0142.1	520142	60589820	24.2122-1716.3	010485	60750856	13.0460-7055.2	607055
46421938	03.2525-2201.3	040026	60608676	24.2122-1716.3	010485	60750871	03.0137-0262.2	650262
46421939	24.2523-1702.3	040087	60622077	24.0122-0145.1	422145	60750873	13.0460-7055.2	607055
46421942	24.2525-1705.3	040083	60653478	24.0122-0145.1	422145	60751116	03.3558-0676.3	310077
46423415	24.0120-0142.1	420142	60653479	24.0110-0209.1	410209	60760092	13.0460-3014.2	603014
46423415	24.0320-0142.1	520142	60658565	24.0122-0145.1	422145	60760094	13.0460-3014.2	603014
46427947	24.0122-0107.1	422107	60658566	24.0110-0209.1	410209	60760104	13.0460-3013.2	603013
46427949	24.0122-0107.1	422107	60699518	24.0122-0145.1	422145	60760106	13.0460-2980.2	602980
46445004	24.0122-0147.1	422147	60701786	24.0110-0166.1	410166	60760110	13.0460-2809.2	602809
46445005	24.0122-0130.1	422130	60702072	24.0110-0179.1	410179	60760117	03.2122-0142.3	010128
46445006	24.0122-0145.1	422145	60703319	03.0137-0262.2	650262	60760120	13.0460-2962.2	602962
46448168	24.0122-0147.1	422147	60709427	83.7704-0281.3	330804	60760121	13.0460-2809.2	602809
46455892	24.0122-0147.1	422147	60709762	83.7704-0281.3	330804	60760124	13.0460-2980.2	602980
46456849	24.3727-0521.2	580521	60711956	13.0441-4819.2	250104	60765006	13.0460-2968.2	602968
46478560	24.2419-1721.3	030100	60711959	13.0460-4035.2	604035	60765017	13.0460-2968.2	602968
46531635	24.2525-1706.3	040088	60712016	13.0441-3001.2	250041	60765018	13.0460-2968.2	602968
46531636	03.2525-2201.3	040026	60712607	13.0460-3011.2	603011	60776098	13.0460-2968.2	602968
46535126	24.2122-1716.3	010485	60712608	13.0460-3011.2	603011	60777262	13.0460-3905.2	603905
46758714	24.0122-0147.1	422147	60713600	13.0460-6027.2	606027	60777263	13.0460-7055.2	607055
46758715	24.0110-0190.1	410190	60713601	13.0460-6027.2	606027	60777264	13.0460-2969.2	602969
46786435	83.6401-0159.3	330746	60714325	03.0450-2509.2	082509	60777600	13.0460-2949.2	602949
46819776	24.0218-0011.1	480006	60714401	13.0441-3803.2	250060	60777601	13.0460-2951.2	602951
46820655	24.0112-0127.1	412127	60714402	13.0460-3011.2	603011	60777621	13.0460-2979.2	602979
46831042	24.0110-0190.1	410190	60714404	13.0460-3011.2	603011	60777805	13.0460-9034.2	609034
51749124	24.0120-0142.1	420142	60714480	03.2120-4504.3	010123	60777807	13.0460-2968.2	602968
51749124	24.0320-0142.1	520142	60716270	03.2525-1802.3	040025	60778257	13.0460-4019.2	604019
51816526	24.0222-8018.1	480078	60718544	83.7704-0281.3	330804	60778260	13.0460-3011.2	603011
51859075	24.0112-0127.1	412127	60720645	13.0460-4019.2	604019	60778263	13.0460-4035.2	604035
51859078	24.0111-0119.1	411119	60720648	13.0460-3013.2	603013	60778265	13.0460-3013.2	603013
51863510	24.0218-0011.1	480006	60723584	13.0460-6027.2	606027	60778279	13.0460-3905.2	603905
51866264	24.0112-0127.1	412127	60723585	13.0460-3011.2	603011	60778285	13.0460-7055.2	607055
51866265	24.0112-0127.1	412127	60727285	13.0460-4035.2	604035	60778676	13.0460-2968.2	602968
51876438	24.0111-0119.1	411119	60727286	13.0460-4035.2	604035	60800249	03.2122-0142.3	010128
51900803	24.0218-0011.1	480006	60727289	13.0460-3011.2	603011	60800345	24.0111-0149.1	411149
51990127	24.0122-0145.1	422145	60727290	13.0460-3011.2	603011	60800372	24.5112-0160.3	330612
51996238	24.0122-0145.1	422145	60729251	13.0460-4035.2	604035	60801390	24.0110-0190.1	410190
52015291	24.0122-0145.1	422145	60729279	13.0460-3011.2	603011	60801722	24.0122-0145.1	422145
55701046	24.5228-0216.3	330908	60729341	03.2122-0142.3	010128	60801751	24.0122-0130.1	422130
60501235	03.2419-8000.3	030017	60730497	03.2419-8601.3	030022	60801752	24.0120-0129.1	420129
60501237	03.2419-8000.3	030017	60730514	13.0460-4019.2	604019	60801753	24.0110-0190.1	410190
60501338	83.7704-0281.3	330804	60730542	13.0460-3013.2	603013	60801754	24.0120-0129.1	420129
60501453	24.0113-0171.1	413171	60735549	13.0441-4212.2	250089	60801755	24.0110-0190.1	410190
60501727	83.7704-0281.3	330804	60736106	13.0460-9034.2	609034	60801786	24.0110-0209.1	410209
60502664	03.2419-8000.3	030017	60737389	13.0460-9034.2	609034	60801787	24.0110-0209.1	410209
60502665	03.2525-2201.3	040026	60740842	13.0460-4019.2	604019	60802029	24.0112-0127.1	412127
60502666	03.2525-2201.3	040026	60740845	13.0460-3013.2	603013	60805117	24.0111-0149.1	411149
60511528	24.2523-1702.3	040087	60741656	03.3558-0676.3	310077	60805172	24.0122-0130.1	422130
60514881	24.0122-0128.1	422128	60743390	24.0110-0209.1	410209	60806135	24.0122-0147.1	422147
60516270	03.2525-1802.3	040025	60743417	13.0460-2980.2	602980	60806137	24.0120-0142.1	420142
60516271	03.2525-1802.3	040025	60743563	13.0460-2980.2	602980	60806137	24.0320-0142.1	520142
60516371	24.0113-0102.2	413102	60743565	13.0460-2962.2	602962	60806307	24.3727-0521.2	580521
60516390	03.6048-0601.3	320052	60743569	24.0120-0129.1	420129	60806310	24.3727-0006.2	580006
60516551	03.0137-0149.2	650149	60743578	13.0460-2962.2	602962	60806311	24.3727-0521.2	580521
60516944	03.0137-0149.2	650149	60748478	03.2119-6207.3	010060	60806876	24.2120-1710.3	010468
60516948	24.0109-0101.1	409101	60749601	03.2119-6207.3	010060	60807625	24.0122-0130.1	422130
60517115	03.2417-0301.3	030004	60750205	24.3217-1112.3	020175	60808872	24.0112-0127.1	412127
60517201	03.2122-0142.3	010128	60750208	03.0137-9125.2	669125	60809894	24.0116-0105.1	416105
60518094	03.2419-8900.3	030024	60750413	13.0460-2969.2	602969	60809897	24.2419-1721.3	030100
60518194	03.2419-8900.3	030024	60750464	13.0460-3905.2	603905	60809966	24.3220-1116.3	020313
60518410	24.5307-0320.3	330703	60750465	13.0460-7055.2	607055	60810025	24.0222-8018.1	480078
60520463	03.0137-0149.2	650149	60750466	03.0137-0262.2	650262	60810038	03.0137-0208.2	650208
60522092	24.0122-0119.2	422119	60750467	03.0137-0139.2	650139	60810076	24.0120-0142.1	420142
60522155	03.3558-0676.3	310077	60750472	03.0137-0262.2	650262	60810076	24.0320-0142.1	520142
60526121	24.0110-0166.1	410166	60750509	13.0441-4212.2	250089	60810227	24.0120-0129.1	420129
60533971	24.0110-0179.1	410179	60750511	13.0441-3302.2	250042	60810239	13.0460-2949.2	602949



Vergleichsliste

Cross reference list - Tabella di conversione codici



Liste des correspondances - Lista referencias

FIAT 		FIAT 		FORD 				
60810404	24.0122-0147.1	422147	82390671	24.3727-0514.2	580514	1006012	24.3222-1117.3	020272
60811256	24.0120-0142.1	420142	82394418	24.0110-0190.1	410190	1006013	24.3217-1715.3	020463
60811256	24.0320-0142.1	520142	82401754	24.5209-0280.3	330044	1006016	24.3219-1107.3	020338
60811266	24.0120-0142.1	420142	82409600	03.2525-2201.3	040026	1007172	24.3727-0644.2	580644
60811266	24.0320-0142.1	520142	82422135	24.5209-0280.3	330044	1007814	11.3481-8514.2	220336
60811771	24.2525-1705.3	040083	82427592	24.0122-0145.1	422145	1007818	11.3541-8529.2	220341
60811878	24.0122-0147.1	422147	82433789	24.0122-0130.1	422130	1007818	24.3541-8529.5	240553
60811879	24.0111-0119.1	411119	82433858	24.0120-0129.1	420129	1007819	11.3541-8530.2	220342
60811890	24.0122-0107.1	422107	82433859	24.0110-0190.1	410190	1007819	24.3541-8530.5	240554
60812067	24.0122-0107.1	422107	82433860	24.0120-0129.1	420129	1007821	11.3481-8513.2	220335
60812137	24.0122-0107.1	422107	82433918	24.0122-0147.1	422147	1010502	13.0460-7073.2	607073
60812164	24.0122-0147.1	422147	82434070	24.0110-0190.1	410190	1010503	13.0460-7071.2	607071
60812422	24.0122-0147.1	422147	82434169	24.0114-0102.1	414102	1013581	24.0112-0141.1	412141
60812546	24.3727-0521.2	580521	82439939	24.0110-0209.1	410209	1013815	24.5303-0400.3	330404
60812685	24.0122-0130.1	422130	82440275	24.0110-0209.1	410209	1013843	13.0460-7073.2	607073
60812799	24.3727-0006.2	580006	82440356	24.0122-0147.1	422147	1014655	03.0137-0272.2	650272
60813038	24.0122-0147.1	422147	82441688	24.3727-0514.2	580514	1017668	24.0218-0024.2	480079
60813056	24.3727-0521.2	580521	82442878	24.5112-0220.3	330613	1017668	24.0218-0724.2	480206
60813443	24.0122-0145.1	422145	82450539	24.0122-0145.1	422145	1018615	24.5304-0280.3	330589
60814217	24.2525-1706.3	040088	82450657	24.0122-0147.1	422147	1019239	24.3727-0639.2	580639
60814804	24.0110-0209.1	410209	82451441	24.0122-0130.1	422130	1019240	24.3727-0641.2	580641
60814827	24.2419-1721.3	030100	82451746	24.0122-0147.1	422147	1019598	24.0112-0141.1	412141
60814839	24.0222-8018.1	480078	82451747	24.0122-0130.1	422130	1019604	24.0120-0147.1	420147
60815246	03.2525-2201.3	040026	82462136	24.0122-0107.1	422107	1019604	24.0320-0147.1	520147
60815938	24.0122-0145.1	422145	82464702	24.0120-0129.1	420129	1019627	24.2125-1706.3	010496
71711434	24.0122-0145.1	422145	82468102	24.5112-0384.3	330651	1019628	24.2125-1708.3	010498
71711447	24.0122-0145.1	422145	82476515	24.0126-0114.1	426114	1022077	13.0460-7165.2	607165
71736960	83.6401-0159.3	330746	82481842	24.3727-0545.2	580545	1022078	13.0460-7163.2	607163
71737950	24.3220-1116.3	020313	92323733	24.3727-0510.2	580510	1022079	13.0460-7056.2	607056
71737951	24.3220-1116.3	020313	92323734	24.3727-0511.2	580511	1022395	03.6043-1956.3	320202
71738145	24.0120-0142.1	420142	92498609	24.0112-0127.1	412127	1022421	03.6043-1953.3	320201
71738145	24.0320-0142.1	520142	93500520	24.0116-0105.1	416105	1022424	03.6043-1954.3	320226
71738324	24.3219-0803.3	020183	93500521	24.0116-0106.1	416106	1023692	83.6118-0281.3	330483
71738375	03.0137-0015.2	650015	99388259	24.2122-0801.3	010373	1025018	24.5309-0540.3	331368
71738376	03.0137-0207.2	650207	1313675080	24.0225-4002.1	480048	1025911	24.0120-0146.1	420146
71738421	24.0111-0119.1	411119	1472155080	24.5111-0301.3	330499	1025911	24.0320-0146.1	520146
71738423	24.0112-0122.1	412122	9404427708	11.8116-0073.1	390498	1027371	24.0222-8014.1	480031
71738443	24.2120-0801.3	010362	9404439148	11.0101-5407.2	260011	1027745	24.5302-0296.3	330476
71738444	24.2120-1710.3	010468	9404448768	11.0441-3602.2	250008	1030601	13.0460-7073.2	607073
71738446	24.2120-1710.3	010468	16420.26100.01/00	24.0110-0190.1	410190	1031781	13.0460-3965.2	603965
71738467	24.2525-1706.3	040088				1037718	24.2419-1723.3	030112
71738912	24.0110-0209.1	410209	FORD			1038834	24.3727-0644.2	580644
71738913	24.0110-0190.1	410190				1040745	24.3727-0641.2	580641
71739128	24.2120-0802.3	010363	0438874	24.5170-0426.3	331452	1041466	11.8116-0143.1	390513
71739132	24.3225-1101.3	020294	0461234	83.6204-0300.3	330548	1042688	13.0460-7071.2	607071
71739567	24.0122-0145.1	422145	0461564	24.3526-0810.3	340037	1044225	24.3364-1704.5	240310
71739568	24.0122-0145.1	422145	0504992	83.6103-0320.3	330224	1044227	24.3364-1704.5	240310
71739592	24.2122-1716.3	010485	0546820	24.3526-0810.3	340037	1044229	24.3364-1706.5	240312
71740006	24.2119-0815.3	010347	0553750	03.3217-0602.3	020024	1044230	24.3364-1706.5	240312
71740008	24.2119-0826.3	010349	0558087	03.3219-2106.3	020043	1044233	24.3364-1703.5	240309
71748384	13.0460-3939.2	603939	0609741	83.6103-0600.3	330233	1044234	24.3364-1703.5	240309
71750931	13.0460-5929.2	605929	0621258	83.6104-0450.3	330251	1044237	24.3364-1705.5	240311
71752994	13.0460-2949.2	602949	0690344	83.6123-0381.3	330262	1044239	24.3364-1705.5	240311
71769481	24.0111-0119.1	411119	0690345	83.6103-0240.3	330220	1045392	24.0218-0024.2	480079
71770933	24.0111-0119.1	411119	0690346	83.6103-0470.3	330229	1045392	24.0218-0724.2	480206
71772238	24.0111-0119.1	411119	0710084	13.0460-4035.2	604035	1046070	24.3727-0639.2	580639
77362187	13.0460-2962.2	602962	0710417	13.0460-4035.2	604035	1048069	24.3727-0641.2	580641
77362242	13.0460-2826.2	602826	0800962	13.0460-6027.2	606027	1048296	24.3541-1708.5	240068
77362266	13.0460-3939.2	603939	1000837	24.3727-0639.2	580639	1048298	24.3541-1707.5	240067
77362292	03.0137-0015.2	650015	1000839	24.3727-0641.2	580641	1048308	13.0460-3965.2	603965
77362298	03.0137-0208.2	650208	1000859	24.0218-0024.2	480079	1048309	13.0460-3965.2	603965
77362317	03.0137-0207.2	650207	1000859	24.0218-0724.2	480206	1050100	24.3727-0644.2	580644
77362318	03.0137-0015.2	650015	1001959	24.3384-1708.5	240172	1051343	24.3727-0644.2	580644
77362319	03.0137-0330.2	650330	1001960	24.3384-1707.5	240171	1054047	24.2419-1723.3	030112
77362344	13.0460-2987.2	602987	1002202	11.0441-5704.2	250034	1060213	24.3727-0639.2	580639
77362423	03.0137-0015.2	650015	1005567	24.3727-0639.2	580639	1063194	24.3727-0644.2	580644
77362424	03.0137-0015.2	650015	1005568	24.3727-0639.2	580639	1064762	13.0460-7073.2	607073
77362425	03.0137-0207.2	650207	1005574	24.3727-0641.2	580641	1064763	13.0460-7071.2	607071
77362611	03.0137-9088.2	669088	1006004	03.0137-9217.2	669217	1066271	24.0120-0147.1	420147
77363591	11.8171-0008.1	990049	1006005	03.0137-9177.2	669177	1066271	24.0320-0147.1	520147
82388579	24.0120-0129.1	420129	1006011	24.3220-1112.3	020223	1071938	83.7114-0376.3	330373

Vergleichsliste

Cross reference list - Tabella di conversione codici

Liste des correspondances - Lista referencias



FORD		FORD		FORD				
1071939	24.5309-0540.3	331368	1138611	24.3541-1708.5	240068	1574839	13.0460-7042.2	607042
1072951	24.3601-8528.5	240504	1138612	24.3541-1707.5	240067	1575877	24.0110-0148.1	410148
1072953	24.3601-8527.5	240503	1138619	24.3421-1710.5	240698	1576612	13.0460-7042.2	607042
1072959	24.3601-8528.5	240504	1138620	24.3421-1709.5	240697	1576821	13.0460-7042.2	607042
1072961	24.3601-8527.5	240503	1203934	03.0137-0376.2	650376	1576827	13.0460-7042.2	607042
1073731	13.0460-7057.2	607057	1204850	13.0460-3963.2	603963	1576829	13.0460-7042.2	607042
1073732	13.0460-7056.2	607056	1204852	13.0460-3964.2	603964	1576830	13.0460-7042.2	607042
1078043	24.3727-0639.2	580639	1320581	24.0120-0147.1	420147	1576835	13.0460-7042.2	607042
1079347	13.0460-7057.2	607057	1320581	24.0320-0147.1	520147	1576836	13.0460-7042.2	607042
1079348	13.0460-7056.2	607056	1320582	24.0120-0147.1	420147	1576887	13.0460-7042.2	607042
1079919	13.0460-7073.2	607073	1320582	24.0320-0147.1	520147	1579847	13.0441-5409.2	250112
1079920	13.0460-7071.2	607071	1323621	24.0110-0115.1	410115	1583104	13.0441-5409.2	250112
1086921	03.0137-9217.2	669217	1328617	24.3364-1704.5	240310	1583215	03.2120-0151.3	010071
1086922	03.0137-9177.2	669177	1328618	24.3364-1703.5	240309	1591094	13.0460-7042.2	607042
1088934	13.0460-3963.2	603963	1328619	24.3364-1706.5	240312	1591990	24.0110-0148.1	410148
1088938	13.0460-3964.2	603964	1328620	24.3364-1705.5	240311	1591991	24.0110-0148.1	410148
1092259	24.2419-1723.3	030112	1373781	24.0110-0115.1	410115	1591993	24.0113-0118.1	413118
1093543	24.3727-0639.2	580639	1465126	13.0460-7073.2	607073	1591995	24.0113-0122.1	413122
1095201	13.0460-7057.2	607057	1473006	24.0110-0115.1	410115	1591996	24.0113-0122.1	413122
1095202	13.0460-7056.2	607056	1473043	03.0137-0237.2	650237	1595523	13.0460-7071.2	607071
1096940	13.0460-7056.2	607056	1473056	03.0137-0272.2	650272	1595524	13.0460-7027.2	607027
1096942	13.0460-7057.2	607057	1477771	11.3541-8529.2	220341	1595875	24.0124-0112.1	424112
1097769	13.0460-7163.2	607163	1477771	24.3541-8529.5	240553	1598117	24.0218-0010.2	480005
1102560	24.0124-0113.1	424113	1478335	24.3364-1704.5	240310	1604578	24.3541-1701.5	240005
1103617	24.3727-0639.2	580639	1478336	24.3364-1706.5	240312	1613087	24.2119-0905.3	010353
1103618	24.3727-0644.2	580644	1478415	24.3364-1703.5	240309	1613128	13.0460-7027.2	607027
1104131	24.3217-1715.3	020463	1478418	24.3364-1705.5	240311	1613313	13.0460-7042.2	607042
1104132	24.3219-1107.3	020338	1478446	24.3421-1710.5	240698	1613351	83.6339-0228.3	330361
1106343	03.3517-5100.1	390326	1478455	24.3421-1709.5	240697	1613354	24.5302-0296.3	330476
1108004	24.3727-0641.2	580641	1478466	11.3481-8514.2	220336	1613463	24.2120-0905.3	010364
1111283	13.0460-2933.2	602933	1478467	11.3541-8530.2	220342	1619053	24.0124-0112.1	424112
1112542	24.0112-0141.1	412141	1478467	24.3541-8530.5	240554	1619054	24.0124-0112.1	424112
1113008	03.6043-1954.3	320226	1478469	24.3601-8528.5	240504	1619118	24.3727-0628.2	580628
1113010	03.6043-1956.3	320202	1478495	11.3481-8513.2	220335	1619136	03.0137-0164.2	650164
1113275	03.6043-1953.3	320201	1478497	24.3601-8527.5	240503	1619138	24.3217-1114.3	020177
1113641	24.3220-1111.3	020222	1478525	24.3541-1701.5	240005	1619209	13.0460-7071.2	607071
1113980	24.3222-1117.3	020272	1478806	24.2532-5003.3	090013	1619225	11.0441-4805.2	250020
1115986	24.3222-1114.3	020269	1480493	03.2120-5503.3	010124	1619229	24.0124-0112.1	424112
1118406	24.3364-1704.5	240310	1484750	24.3219-1107.3	020338	1629450	24.0110-0148.1	410148
1118407	24.3364-1706.5	240312	1484751	24.3220-1112.3	020223	1629451	24.0110-0148.1	410148
1118408	24.3364-1703.5	240309	1484752	24.3217-1715.3	020463	1629474	24.0124-0112.1	424112
1118409	24.3364-1705.5	240311	1484766	13.0441-4825.2	250107	1629475	24.0110-0193.1	410193
1121371	11.0230-0687.1	260106	1486316	24.3219-1107.3	020338	1629476	24.0124-0112.1	424112
1121374	11.3481-8512.2	220338	1486750	24.3219-1107.3	020338	1629477	24.0110-0193.1	410193
1121377	11.3481-8514.2	220336	1487877	13.0441-5409.2	250112	1629482	24.0124-0112.1	424112
1121379	11.3481-8513.2	220335	1490767	24.0220-3001.2	480020	1629483	24.0124-0112.1	424112
1121380	11.3541-8530.2	220342	1500668	13.0460-3964.2	603964	1629947	24.3728-0625.2	590625
1121380	24.3541-8530.5	240554	1514237	24.0110-0115.1	410115	1630011	24.0124-0109.1	424109
1121381	11.3541-8529.2	220341	1517558	24.3217-1715.3	020463	1630012	24.0110-0186.1	410186
1121381	24.3541-8529.5	240553	1517559	24.3219-1107.3	020338	1630149	24.0110-0115.1	410115
1121753	24.3601-8528.5	240504	1539549	24.0114-0100.1	414100	1630360	24.3217-1114.3	020177
1121758	24.3601-8527.5	240503	1540738	13.0460-7042.2	607042	1637322	24.3727-0624.2	580624
1126532	24.3220-1112.3	020223	1540739	13.0460-7042.2	607042	1637874	13.0441-4015.2	250080
1129032	24.5305-0310.3	331326	1540740	13.0460-7042.2	607042	1637904	24.0711-1129.1	360002
1129985	13.0460-3963.2	603963	1541801	24.0218-0011.1	480006	1637969	24.0110-0115.1	410115
1129986	13.0460-3964.2	603964	1541804	24.0111-0119.1	411119	1638880	13.0460-2928.2	602928
1130751	13.0460-3965.2	603965	1544173	24.0218-0011.1	480006	1642643	13.0460-6910.2	606910
1130758	13.0460-7056.2	607056	1548454	83.7704-0320.3	330851	1643706	24.0124-0113.1	424113
1133442	24.3222-1117.3	020272	1548635	13.0460-7042.2	607042	1643718	24.0124-0113.1	424113
1133750	13.0460-3965.2	603965	1549695	24.0113-0118.1	413118	1644433	24.3727-0616.2	580616
1134158	13.0460-3960.2	603960	1549699	24.0113-0122.1	413122	1644434	24.3727-0624.2	580624
1134159	13.0460-3959.2	603959	1552517	13.0441-5409.2	250112	1644831	24.0124-0151.1	424151
1138582	11.3481-8512.2	220338	1563516	03.2119-0525.3	010046	1644844	24.0124-0112.1	424112
1138589	11.3481-8514.2	220336	1563526	03.2120-5503.3	010124	1644845	24.0124-0112.1	424112
1138590	11.3541-8530.2	220342	1568369	13.0460-7042.2	607042	1644857	24.0110-0193.1	410193
1138590	24.3541-8530.5	240554	1568857	83.6104-0450.3	330251	1644859	24.0124-0113.1	424113
1138591	24.3601-8528.5	240504	1568862	83.7704-0320.3	330851	1647679	24.3728-0625.2	590625
1138600	11.3481-8513.2	220335	1571346	24.0110-0148.1	410148	1647730	13.0460-7040.2	607040
1138601	11.3541-8529.2	220341	1571347	24.0110-0148.1	410148	1647731	13.0460-7041.2	607041
1138601	24.3541-8529.5	240553	1571348	24.0110-0148.1	410148	1648236	13.0460-2928.2	602928
1138602	24.3601-8527.5	240503	1572058	13.0460-7042.2	607042	1648631	03.0137-0164.2	650164



Vergleichsliste

Cross reference list - Tabella di conversione codici



Liste des correspondances - Lista referencias

FORD 	FORD 	FORD 
1648810	83.6339-0228.3 330361	5018898
1648811	83.6339-0253.3 330362	5018899
1652206	13.0460-2928.2 602928	5018900
1652547	24.0110-0186.1 410186	5018902
1654620	13.0460-7041.2 607041	5018907
1656491	24.3727-0628.2 580628	5018908
1656793	24.3727-0624.2 580624	5018930
1659647	24.3727-0623.2 580623	5018981
1659671	24.3727-0623.2 580623	5019038
1659938	13.0460-7073.2 607073	5019046
1661467	24.0124-0148.1 424148	5020409
1661473	11.8116-0073.1 390498	5020413
1661490	11.0441-6007.2 250146	5020547
1661491	11.0441-6007.2 250146	5020552
1661851	24.0222-8010.2 480027	5020562
1662293	03.0137-0292.2 650292	5020817
1662294	03.0137-0292.2 650292	5020818
1664703	24.3727-0627.2 580627	5021305
1664811	24.3727-0627.2 580627	5021734
1664872	24.3727-0627.2 580627	5022253
1664975	24.3727-0627.2 580627	5022397
1680868	24.0218-0011.1 480006	5022398
1680869	24.0218-0011.1 480006	5022650
1715410	24.0111-0119.1 411119	5022651
1756882	24.0110-0115.1 410115	5022652
1780880	24.0110-0115.1 410115	5022653
1954433	24.0126-0109.1 426109	5022654
1954460	13.0460-5959.2 605959	5022654
1954475	24.0225-4014.1 480155	5022658
1954496	03.0137-0376.2 650376	5022659
1954497	24.3223-1709.3 020444	5022660
1954498	24.3222-1717.3 020443	5022661
1956495	13.0460-5959.2 605959	5022663
1956522	24.2123-1726.3 010557	5022664
1957042	13.0460-5959.2 605959	5022666
1959359	24.3223-1709.3 020444	5022669
1960416	03.0137-0376.2 650376	5022671
3256541	13.0460-5806.2 605806	5022674
3395510	24.0124-0129.1 424129	5022676
3395842	13.0460-5973.2 605973	5022677
3401278	13.0460-5954.2 605954	5022829
3415598	24.0110-0234.1 410234	5022947
3894048	13.0460-5954.2 605954	5022948
3898005	13.0460-5973.2 605973	5022949
3958455	24.0124-0129.1 424129	5023224
4034886	24.0218-0024.2 480079	5023225
4034886	24.0218-0724.2 480206	5023226
4055730	24.3225-1103.3 020346	5023441
4056029	24.0124-0120.1 424120	5023483
4056029	24.0324-0120.1 524120	5023486
4056031	24.0124-0149.1 424149	5023573
4070864	24.0124-0149.1 424149	5023732
4070865	24.0124-0120.1 424120	5023994
4070865	24.0324-0120.1 524120	5023996
4071714	24.0120-0147.1 420147	5023998
4071714	24.0320-0147.1 520147	5023999
4083484	24.0110-0115.1 410115	5024174
4084226	24.0120-0147.1 420147	5024744
4084226	24.0320-0147.1 520147	5025048
4115996	24.0120-0146.1 420146	5025610
4115996	24.0320-0146.1 520146	5025611
5010540	13.0460-6910.2 606910	5025929
5015665	03.0137-0157.2 650157	5025950
5015917	13.0460-7005.2 607005	5025951
5015919	13.0460-7071.2 607071	5026344
5015920	13.0460-7027.2 607027	5026661
5015924	13.0460-7042.2 607042	5026674
5015932	13.0460-6910.2 606910	5026784
5015935	13.0460-6911.2 606911	5026784
5016220	03.0137-0164.2 650164	5026785
5018535	03.0137-9046.2 669046	5026786
		13.0460-7005.2 607005
		13.0460-7071.2 607071
		13.0460-7027.2 607027
		13.0460-7042.2 607042
		13.0460-6910.2 606910
		13.0460-6911.2 606911
		13.0460-7042.2 607042
		13.0460-2912.2 602912
		03.0137-0138.2 650138
		03.0137-0036.2 650036
		03.0137-0157.2 650157
		03.0137-0138.2 650138
		03.0137-0138.2 650138
		03.0137-0157.2 650157
		03.0137-0164.2 650164
		13.0460-7040.2 607040
		13.0460-7041.2 607041
		03.0137-0164.2 650164
		24.3541-1701.5 240005
		24.0113-0118.1 413118
		13.0460-6910.2 606910
		13.0460-6911.2 606911
		24.0110-0148.1 410148
		24.0110-0148.1 410148
		24.0110-0196.1 410196
		24.0110-0196.1 410196
		24.0120-0147.1 420147
		24.0320-0147.1 520147
		24.0110-0193.1 410193
		24.0124-0112.1 424112
		24.0124-0112.1 424112
		24.0124-0113.1 424113
		24.0124-0113.1 424113
		24.0124-0151.1 424151
		24.0110-0115.1 410115
		24.0110-0186.1 410186
		24.0113-0118.1 413118
		24.0114-0100.1 414100
		24.0114-0103.1 414103
		24.0114-0100.1 414100
		24.0113-0122.1 413122
		24.0110-0193.1 410193
		24.0124-0112.1 424112
		24.0110-0186.1 410186
		24.3541-1701.5 240005
		24.3434-1602.5 240020
		24.3434-1601.5 240019
		24.0124-0121.1 424121
		24.0110-0115.1 410115
		13.0460-3944.2 603944
		24.0124-0112.1 424112
		24.0113-0118.1 413118
		13.0460-7071.2 607071
		13.0460-2912.2 602912
		13.0460-7040.2 607040
		13.0460-7041.2 607041
		24.0124-0148.1 424148
		24.0110-0193.1 410193
		13.0460-7073.2 607073
		24.0124-0131.1 424131
		24.0124-0132.1 424132
		13.0460-7073.2 607073
		24.0124-0125.1 424125
		24.0110-0213.1 410213
		03.0137-0254.2 650254
		13.0460-3965.2 603965
		24.0124-0148.1 424148
		24.0124-0120.1 424120
		24.0324-0120.1 524120
		24.0124-0149.1 424149
		24.0120-0146.1 420146
		24.0320-0146.1 520146
		24.0124-0121.1 424121
		24.0110-0186.1 410186
		13.0460-3965.2 603965
		24.0124-0132.1 424132
		03.0137-0282.2 650282
		24.0120-0147.1 420147
		24.0320-0147.1 520147
		13.0460-3960.2 603960
		13.0460-3959.2 603959
		13.0460-7057.2 607057
		13.0460-7056.2 607056
		11.8116-0301.1 390610
		24.0124-0131.1 424131
		24.0124-0132.1 424132
		24.0110-0115.1 410115
		24.3220-1112.3 020223
		24.0113-0118.1 413118
		24.0113-0122.1 413122
		03.2119-0525.3 010046
		24.3217-1706.3 020044
		24.3215-1104.3 020158
		24.0114-0100.1 414100
		24.2119-0905.3 010353
		24.3727-0619.2 580619
		24.3215-1104.3 020158
		24.0222-8010.2 480027
		24.3728-0623.2 590623
		24.2119-0905.3 010353
		03.2119-0525.3 010046
		03.2120-0148.3 010070
		03.2120-0148.3 010070
		24.0220-3001.2 480020
		24.0124-0112.1 424112
		24.0110-0193.1 410193
		24.3215-1104.3 020158
		24.2122-1702.3 010421
		24.0218-0010.2 480005
		11.0441-5402.2 250028
		11.0441-5402.2 250028
		11.8171-0008.1 990049
		03.0137-9043.2 669043
		24.3222-1117.3 020272
		24.0110-0148.1 410148
		24.0110-0148.1 410148
		24.3215-1104.3 020158
		24.3728-0615.2 590615
		24.3728-0615.2 590615
		13.0460-7071.2 607071
		13.0460-7042.2 607042
		13.0460-7042.2 607042
		24.0110-0193.1 410193
		13.0460-7042.2 607042
		03.2123-8611.3 010195
		83.6339-0228.3 330361
		83.6339-0253.3 330362
		13.0460-7027.2 607027
		03.0137-0138.2 650138
		24.3728-0625.2 590625
		24.2122-1713.3 010463
		24.2122-1713.3 010463
		24.0110-0148.1 410148
		24.3728-0625.2 590625
		13.0460-7027.2 607027
		13.0460-7027.2 607027
		13.0460-7071.2 607071
		24.0113-0118.1 413118

Vergleichsliste

Cross reference list - Tabella di conversione codici

Liste des correspondances - Lista referencias

FORD			FORD			FORD		
6124275	24.3728-0625.2	590625	6158945	13.0460-7071.2	607071	6196052	24.3219-1107.3	020338
6125634	24.5305-0310.3	331326	6159054	24.3727-0617.2	580617	6196053	24.3222-1117.3	020272
6125636	83.6327-0180.3	330740	6162190	13.0460-7073.2	607073	6197738	13.0460-3960.2	603960
6126854	24.5302-0296.3	330476	6162337	13.0460-2933.2	602933	6197739	13.0460-3959.2	603959
6127520	13.0460-7071.2	607071	6162338	13.0460-2928.2	602928	6197741	24.3421-1710.5	240698
6127527	13.0460-7040.2	607040	6162658	03.0137-0157.2	650157	6197743	24.3421-1709.5	240697
6127528	13.0460-7041.2	607041	6163735	24.3727-0617.2	580617	6198026	24.0228-0001.1	480068
6128159	11.0441-6003.2	250037	6165965	13.0460-6911.2	606911	6203650	13.0460-7073.2	607073
6128542	24.3728-0625.2	590625	6166055	24.0114-0103.1	414103	6442332	24.0110-0186.1	410186
6129003	83.6339-0253.3	330362	6166056	24.0114-0100.1	414100	6449782	11.0441-6007.2	250146
6129626	03.0137-9043.2	669043	6166952	13.0460-7071.2	607071	6450826	24.0124-0121.1	424121
6129627	03.0137-9043.2	669043	6166953	13.0460-7027.2	607027	6464214	24.0225-4004.1	480069
6130483	13.0460-7071.2	607071	6166967	24.3727-0631.2	580631	6464704	24.3222-1124.3	020344
6132471	13.0460-7005.2	607005	6166968	24.3727-0632.2	580632	6464705	24.3220-1121.3	020343
6132472	13.0460-7005.2	607005	6166969	24.3727-0630.2	580630	6464706	24.3225-1103.3	020346
6132473	11.0441-4805.2	250020	6167629	24.0222-8011.1	480028	6483825	24.0711-1333.3	360020
6132484	11.0441-4805.2	250020	6168109	24.0124-0121.1	424121	6492327	24.0218-0024.2	480079
6132807	13.0460-7071.2	607071	6168200	24.3727-0625.2	580625	6492327	24.0218-0724.2	480206
6132808	13.0460-7027.2	607027	6168201	24.3727-0622.2	580622	6500943	03.0137-0237.2	650237
6132910	24.5302-0296.3	330476	6168203	24.3727-0618.2	580618	6500944	03.0137-0238.2	650238
6133549	24.0124-0112.1	424112	6169520	24.3727-0617.2	580617	6500945	03.0137-0282.2	650282
6133550	24.0124-0112.1	424112	6169974	24.0124-0113.1	424113	6500952	13.0460-3965.2	603965
6133554	11.8116-0052.1	390496	6169975	24.0124-0113.1	424113	6500954	13.0460-3965.2	603965
6134507	24.0124-0112.1	424112	6170667	24.2120-1739.3	010762	6500959	13.0460-4058.2	604058
6135220	24.5305-0370.3	331392	6171464	24.3727-0631.2	580631	6501431	11.0441-6007.2	250146
6136543	24.2122-0906.3	010378	6173278	24.2122-1603.3	010381	6502746	24.3727-0628.2	580628
6136834	24.2122-1712.3	010462	6174117	13.0460-7071.2	607071	6511773	13.0460-7071.2	607071
6136892	13.0460-7040.2	607040	6174503	24.3728-0601.2	590601	6559229	24.0222-8010.2	480027
6136893	13.0460-7071.2	607071	6175343	13.0460-2933.2	602933	6559230	03.0137-0157.2	650157
6137291	24.0110-0193.1	410193	6176621	11.3481-8512.2	220338	6560026	24.0218-0024.2	480079
6137292	24.0220-3001.2	480020	6176743	24.0218-0024.2	480079	6560026	24.0218-0724.2	480206
6139192	24.3728-0615.2	590615	6176743	24.0218-0724.2	480206	6560027	24.0220-3002.2	480021
6139438	24.3727-0616.2	580616	6176744	24.0220-3002.2	480021	6560028	24.0220-3004.2	480023
6139621	24.3727-0617.2	580617	6177228	03.0137-0164.2	650164	6567001	13.0460-6910.2	606910
6140343	24.3728-0622.2	590622	6177410	24.3728-0627.2	590627	6567002	13.0460-6911.2	606911
6141149	13.0460-2933.2	602933	6177473	03.0137-0292.2	650292	6569119	24.5303-0400.3	330404
6141433	24.3727-0625.2	580625	6178479	13.0460-7071.2	607071	6577423	24.5236-0429.3	330586
6142943	24.0220-3001.2	480020	6178480	13.0460-7071.2	607071	6577424	24.5236-0430.3	330587
6143701	24.3728-0623.2	590623	6179304	24.5302-0295.3	330403	6577425	24.5245-0405.3	330686
6144685	13.0460-7071.2	607071	6180371	13.0460-3965.2	603965	6577426	24.5245-0398.3	331188
6147496	13.0460-7071.2	607071	6180378	24.3541-1708.5	240068	6579150	03.0137-0290.2	650290
6149181	24.5245-0405.3	330686	6180380	24.3541-1707.5	240067	6581520	24.2123-1606.3	010386
6149182	24.5245-0398.3	331188	6181209	03.0137-9124.2	669124	6612561	24.3728-0601.2	590601
6150092	03.0137-0254.2	650254	6183822	24.0220-3001.2	480020	6616408	24.0711-1323.1	360019
6150095	03.0137-0292.2	650292	6183876	03.0137-0235.2	650235	6627122	03.6043-1774.3	320031
6150270	03.0137-0138.2	650138	6183877	03.0137-0236.2	650236	6643690	24.5304-0280.3	330589
6150894	24.0711-1301.1	360015	6184245	13.0460-3944.2	603944	6645754	24.2120-1604.3	010370
6151044	24.2123-1756.3	010756	6184958	24.0711-1129.1	360002	6658706	24.3727-0636.2	580636
6151046	24.2123-1705.3	010440	6186923	11.0101-5407.2	260011	6658707	24.3727-0637.2	580637
6152221	24.3434-1602.5	240020	6187321	24.3541-1701.5	240005	6658751	24.3727-0626.2	580626
6152222	24.3434-1602.5	240020	6187600	24.3217-1601.3	020180	6668584	11.8116-0301.1	390610
6152223	24.3434-1601.5	240019	6187601	24.3219-1106.3	020192	6668585	11.8116-0143.1	390513
6152224	24.3434-1601.5	240019	6187602	24.3222-1111.3	020266	6668587	13.0460-7165.2	607165
6153883	24.3728-0625.2	590625	6188427	13.0460-7073.2	607073	6668590	24.3601-8528.5	240504
6154078	11.0441-6003.2	250037	6188429	24.3541-1701.5	240005	6668592	24.3601-8527.5	240503
6154286	24.3727-0618.2	580618	6189145	13.0460-7071.2	607071	6668594	11.0441-6007.2	250146
6155610	13.0460-2933.2	602933	6189146	13.0460-7071.2	607071	6669768	24.3364-1704.5	240310
6155611	13.0460-7027.2	607027	6189147	13.0460-7040.2	607040	6669769	24.3364-1703.5	240309
6155623	13.0460-7041.2	607041	6189148	13.0460-7040.2	607040	6669777	11.0101-5407.2	260011
6156352	24.0110-0148.1	410148	6189769	13.0460-2933.2	602933	6669779	13.0460-3963.2	603963
6157177	13.0460-7041.2	607041	6191062	24.0110-0196.1	410196	6669780	13.0460-3964.2	603964
6158202	24.0124-0112.1	424112	6191063	24.0110-0196.1	410196	6676122	24.3727-0627.2	580627
6158203	24.0110-0193.1	410193	6191064	24.0120-0147.1	420147	6700130	24.3364-1706.5	240312
6158204	24.0124-0112.1	424112	6191064	24.0320-0147.1	520147	6700131	24.3364-1705.5	240311
6158205	24.0110-0193.1	410193	6191842	24.5303-0400.3	330404	6704268	13.0460-7071.2	607071
6158210	24.0124-0112.1	424112	6192365	03.0137-0254.2	650254	6704269	13.0460-7040.2	607040
6158211	24.0124-0112.1	424112	6192490	24.0220-3008.2	480075	6704270	13.0460-7041.2	607041
6158212	24.0110-0148.1	410148	6193694	24.0124-0121.1	424121	6704271	13.0460-3965.2	603965
6158213	24.0110-0148.1	410148	6194541	24.3727-0616.2	580616	6710010	24.0222-8014.1	480031
6158214	24.0124-0109.1	424109	6194542	24.3727-0618.2	580618	6710016	03.0137-0253.2	650253
6158215	24.0110-0186.1	410186	6196051	24.3220-1112.3	020223	6710017	03.0137-0253.2	650253



Vergleichsliste

Cross reference list - Tabella di conversione codici



Liste des correspondances - Lista referencias

FORD			FORD			FORD		
6714710	24.5306-0295.3	330662	75AB-2140-HB	03.2119-0525.3	010046	93BB-2553-BE	24.3364-1705.5	240311
6733350	03.0137-0291.2	650291	78AB-2140-JA	03.2119-0525.3	010046	93BB-2B486-AA	11.8116-0301.1	390610
6750550	24.3727-0638.2	580638	78BB-2140-AA	03.2120-0151.3	010071	93BB-2B486-CA	11.8116-0143.1	390513
6754692	24.2123-1724.3	010566	78EB-2140-BA	03.2120-0148.3	010070	93BB-2B507-BB	24.2125-1707.3	010497
6758577	83.7114-0376.3	330373	81AB-2282-FA	83.6339-0228.3	330361	93BB-2K021-DC	13.0460-7163.2	607163
6758585	83.6227-0281.3	330424	81AB-2282-FB	83.6339-0228.3	330361	93BB-2K021-DD	13.0460-7163.2	607163
6758587	83.6114-0300.3	330258	81AB-2282-GA	83.6339-0253.3	330362	93BB-2K021-EB	13.0460-7057.2	607057
6781601	24.2125-1707.3	010497	81AB-2282-GC	83.6339-0253.3	330362	93BB-2K021-FB	13.0460-7056.2	607056
6789916	24.2419-1723.3	030112	81AB-2B107-AA	11.0441-5402.2	250028	93BB-2L231-AA	24.3601-8528.5	240504
6790835	03.6043-1784.3	320034	81AB-2L484-AA	11.0441-5402.2	250028	93BB-2L232-AA	24.3601-8527.5	240503
6790836	03.6043-1773.3	320030	81AB-2L527-AA	11.8171-0008.1	990049	93BB-2L410-AA	03.6043-1774.3	320031
6790837	03.6043-1783.3	320033	82GB-2140-AA	03.2123-8611.3	010195	93BB-2L410-BB	03.6043-1784.3	320034
6808555	24.3220-1111.3	020222	83BB-2B107-BA	11.0441-6003.2	250037	93BB-2L410-EA	03.6043-1773.3	320030
6808556	24.3222-1116.3	020271	83BB-2L484-BB	11.0441-6003.2	250037	93BB-2L410-FA	03.6043-1783.3	320033
6808557	24.3222-1114.3	020269	84FB-2B107-AA	11.0441-4805.2	250020	93BB-2L410-GA	03.6043-1776.3	320032
6827588	13.0460-7057.2	607057	84FB-2L484-AA	11.0441-4805.2	250020	93BB-2L410-HA	03.6043-1786.3	320035
6828211	24.5303-0455.3	330588	84FG-2B107-AA	11.0441-4805.2	250020	93BB-2L484-AA	11.0441-6007.2	250146
6837899	03.6043-1776.3	320032	85FX2-N119-AA	24.3541-1701.5	240005	93BX-2L051-AA	11.8116-0301.1	390610
6837900	03.6043-1786.3	320035	85FX-2N119-AA	24.3541-1701.5	240005	93BX-2L051-BA	11.8116-0143.1	390513
6837963	24.0220-3006.1	480062	85GB-2078-AA	24.5305-0310.3	331326	93GB-2K021-AC	13.0460-7060.2	607060
6842331	24.2123-1606.3	010386	85GB-2282-AA	83.6327-0180.3	330740	93GB-2K021-CA	13.0460-7057.2	607057
6854704	24.3727-0639.2	580639	85GB-2B486-AA	11.8116-0052.1	390496	93GB-2K021-CB	13.0460-7057.2	607057
6877835	13.0460-7163.2	607163	85GG-2B372-AD	24.0711-1129.1	360002	94BB-2B507-AA	24.2125-1707.3	010497
6877836	13.0460-7057.2	607057	85GG-2B372-CB	24.0711-1301.1	360015	94BB-7A543-AD	24.2419-1723.3	030112
6877837	13.0460-7056.2	607056	86VB-2282-BB	24.5245-0405.3	330686	94VB-2140AB	24.2123-1724.3	010566
6882582	13.0460-7060.2	607060	86VB-2282-CC	24.5245-0398.3	331188	94VB-2B507-BA	10.6123-0154.3	010578
6882584	13.0460-7057.2	607057	86VB-2A032-BA	24.2123-1756.3	010756	94ZT-7A564-AA	24.2532-5003.3	090013
6912221	24.3727-0627.2	580627	87AB-2282-AA	83.6339-0228.3	330361	94ZT-7A564-AB	24.2532-5003.3	090013
6920296	03.0137-9217.2	669217	87AB-2282-BA	83.6339-0253.3	330362	95GJ-2A315-EC	24.0110-0115.1	410115
6920297	03.0137-9251.2	669251	88AB-2L526-AA	11.0101-5407.2	260011	95GX-2A315-EB	24.0110-0115.1	410115
6920710	24.0218-0024.2	480079	89BB-2K021-AB	13.0460-7071.2	607071	95VW-2L527-AA	11.8171-0008.1	990049
6920710	24.0218-0724.2	480206	89FB-2140-AA	24.2120-1739.3	010762	95VW-2M032-AA	11.0441-5704.2	250034
6920711	24.0220-3004.2	480023	89FB-2L231-AB	11.3481-8512.2	220338	96FB-2261-AA	24.3217-1715.3	020463
6922548	24.2123-1606.3	010386	89FB-2L232-BC	24.3541-1701.5	240005	96FB-2282-BA	24.5304-0280.3	330589
6922621	24.5164-0315.3	331209	89FX-2B294-AB	11.3481-8512.2	220338	96FB-2L231-AA	11.3481-8514.2	220336
6924890	24.3727-0639.2	580639	89GB-2K021-AB	13.0460-7040.2	607040	96FB-2L231-BA	11.3541-8530.2	220342
6941703	24.5129-0395.3	330582	89GB-2K021-BB	13.0460-7041.2	607041	96FB-2L231-BA	24.3541-8530.5	240554
6941705	24.5129-0396.3	330583	91AB-2140-ED	24.2123-1606.3	010386	96FB-2L232-AA	11.3481-8513.2	220335
6944442	24.3727-0644.2	580644	91AB-2B372-AA	24.0711-1323.1	360019	96FB-2L232-BA	11.3541-8529.2	220341
6960026	83.7114-0376.3	330373	91AB-2L484-BA	11.0441-6007.2	250146	96FB-2L232-BA	24.3541-8529.5	240553
6974959	24.2125-1707.3	010497	91AB-2M008-BD	13.0460-4058.2	604058	96FX-2B135-AA	11.0230-0687.1	260106
6978969	03.0137-0235.2	650235	91AG-2B372-BA	24.0711-1333.3	360020	96FX-2B294-AA	11.3481-8514.2	220336
7018202	13.0460-3960.2	603960	91FB-2282-AA	24.5306-0295.3	330662	96FX-2B294-BA	11.3541-8530.2	220342
7018203	13.0460-3959.2	603959	92AB-2078-BB	24.5129-0395.3	330582	96FX-2B294-BA	24.3541-8530.5	240554
7034902	24.2123-1724.3	010566	92AB-2078-DB	24.5129-0396.3	330583	96FX-2B302-AA	11.3481-8513.2	220335
7043631	24.3727-0641.2	580641	92VB-2004AA	24.2123-1724.3	010566	96FX-2B302-BA	11.3541-8529.2	220341
7055297	03.0137-0253.2	650253	92VB-2282-AA	24.5245-0405.3	330686	96FX-2B302-BA	24.3541-8529.5	240553
7067563	83.7114-0376.3	330373	92VB-2282-BA	24.5245-0398.3	331188	97BG-2282-AA	83.6118-0281.3	330483
7098234	24.0220-3008.2	480075	92VX-2B120-BB	24.3421-1710.5	240698	97BG-2282-BB	24.5309-0540.3	331368
7100750	24.2123-1606.3	010386	92VX-2B121-BB	24.3421-1709.5	240697	97BG-2282-BC	24.5309-0540.3	331368
7113400	24.2532-5003.3	090013	93BB-2078-AB	83.7114-0376.3	330373	97BG-2K021-AA	13.0460-7056.2	607056
7114005	13.0460-4058.2	604058	93BB-2078-AD	83.7114-0376.3	330373	97BG-2K021-AB	13.0460-7056.2	607056
7117257	24.3219-1717.3	020415	93BB-2078-AE	83.7114-0376.3	330373	97BG-2K021-BA	13.0460-7057.2	607057
7117258	24.2120-1606.3	010582	93BB-2282-AA	83.6227-0281.3	330424	97BG-2K021-BB	13.0460-7057.2	607057
7127225	24.3727-0662.2	580662	93BB-2282-CA	83.6114-0300.3	330258	97BG-2L231-AA	24.3601-8528.5	240504
7143733	10.6123-0154.3	010578	93BB-2282-DD	24.5164-0315.3	331209	97BG-2L231-CA	24.3601-8528.5	240504
7153476	13.0460-3963.2	603963	93BB-2552-AA	24.3364-1704.5	240310	97BG-2L232-AA	24.3601-8527.5	240503
7153477	13.0460-3964.2	603964	93BB-2552-AB	24.3364-1704.5	240310	97BG-2L232-CA	24.3601-8527.5	240503
7166588	03.0137-0235.2	650235	93BB-2552-AC	24.3364-1704.5	240310	97BG-2L410-AA	03.6043-1953.3	320201
7176735	03.0137-0272.2	650272	93BB-2552-AD	24.3364-1704.5	240310	97BG-2L410-AB	03.6043-1953.3	320201
7201659	11.0101-5407.2	260011	93BB-2552-BA	24.3364-1706.5	240312	97BG-2L410-BA	03.6043-1954.3	320226
7201660	11.8171-0008.1	990049	93BB-2552-BB	24.3364-1706.5	240312	97BG-2L410-BB	03.6043-1954.3	320226
7204066	24.0110-0115.1	410115	93BB-2552-BC	24.3364-1706.5	240312	97BG-2L410-CA	03.6043-1956.3	320202
7264793	24.3727-0638.2	580638	93BB-2552-BE	24.3364-1706.5	240312	97BG-2L410-CB	03.6043-1956.3	320202
7264799	24.3727-0644.2	580644	93BB-2553-AA	24.3364-1703.5	240309	97BX-2B294-CA	24.3601-8528.5	240504
7267808	03.0137-0253.2	650253	93BB-2553-AB	24.3364-1703.5	240309	97BX-2B302-CA	24.3601-8527.5	240503
7272225	24.5303-0455.3	330588	93BB-2553-AC	24.3364-1703.5	240309	9S51-1113-AA	24.0218-0011.1	480006
7296356	24.0218-0024.2	480079	93BB-2553-AD	24.3364-1703.5	240309	9S51-1113-BA	24.0218-0011.1	480006
7296356	24.0218-0724.2	480206	93BB-2553-BA	24.3364-1705.5	240311	9S51-1113-CA	24.0218-0011.1	480006
7376434	24.3727-0642.2	580642	93BB-2553-BB	24.3364-1705.5	240311	9S51-1113-DA	24.0218-0011.1	480006
71BB-2140-TB	03.2120-5503.3	010124	93BB-2553-BC	24.3364-1705.5	240311	9S51-1125-CA	24.0111-0119.1	411119

Vergleichsliste

Cross reference list - Tabella di conversione codici

Liste des correspondances - Lista referencias



FORD 			HANOMAG 			HENSCHEL 		
BS51-1125-AA	24.0111-0119.1	411119	1823 053 310	03.3222-4401.3	020076	924 746	03.3508-0401.3	310014
C1BC-2A315-AA	24.0110-0115.1	410115	2121 050 131	83.6192-0250.3	330726	HONDA		
D72VB-2078-BA	83.6104-0450.3	330251	247 925 142	24.3526-0810.3	340037	04431-ST3-E00	03.0137-0339.2	650339
E92Z-1125-A	24.0124-0105.1	424105	247 925 143	03.3517-0300.1	390323	06022-SP8-000	13.0460-5998.2	605998
E92Z-2001-A	13.0460-5932.2	605932	247 925 719	03.3508-0401.3	310014	42510-SD4-000	24.0110-0267.1	410267
E92Z-2C026-A	24.0110-0181.1	410181	2840 498 M92	03.3138-2001.3	010310	42510-SE0-000	24.0110-0212.1	410212
F5RZ-7A508-B	24.2532-5003.3	090013	2930 599 M91	13.0441-5718.2	250120	42510-SE0-010	24.0110-0212.1	410212
P02Z-2200-A	13.0460-5995.2	605995	2945 478 M91	03.3138-2001.3	010310	42510-SG9-000	24.0110-0255.1	410255
R85FX-2N119-AA	24.3541-1701.5	240005	2954 343 M91	24.3526-0110.3	340018	42510-SG9-010	24.0110-0255.1	410255
R85FX-2N119-AB	24.3541-1701.5	240005	2962 254 M91	83.6103-0320.3	330224	42510-SH3-G00	24.0110-0212.1	410212
R89FX-2B294-AB	11.3481-8512.2	220338	2965 525 M1	03.3517-0300.1	390323	42510-SK3-305	24.0110-0212.1	410212
R93BX-2552-AD	24.3364-1704.5	240310	2966 133 M1	83.6103-0600.3	330233	42510-SK3-E00	24.0110-0212.1	410212
R93BX-2552-AE	24.3364-1704.5	240310	2977 278 M91	03.0370-1038.2	051038	42510-SM4-950	24.0110-0233.1	410233
R93BX-2552-BE	24.3364-1706.5	240312	2977 278 M91	03.0370-9998.2	059998	42510-SN7-000	24.0110-0233.1	410233
R93BX-2552-BF	24.3364-1706.5	240312	2998 825 M1	03.3509-0100.3	310057	42510-SP0-000	24.0109-0132.1	409132
R93BX-2553-AD	24.3364-1703.5	240309	3002737X1	24.3526-0100.3	340017	42510-SR3-000	24.0109-0111.1	409111
R93BX-2553-AE	24.3364-1703.5	240309	3083 208 M91	03.3508-0501.3	310017	42510-SR3-A10	24.0109-0111.1	409111
R93BX-2553-BE	24.3364-1705.5	240311	3083 212 M91	03.3117-1408.3	010255	42510-SR3-A11	24.0109-0111.1	409111
R93BX-2553-BF	24.3364-1705.5	240311	3141 902 M1	24.3526-0810.3	340037	42510-SR3-G00	24.0109-0111.1	409111
R96FX-2B294-AA	11.3481-8514.2	220336	317 223 019	24.3526-0110.3	340018	42510-SR3-J00	24.0110-0267.1	410267
R96FX-2B294-AB	11.3481-8514.2	220336	3227 885 M91	03.3115-2651.3	010250	42510-SS0-000	24.0110-0267.1	410267
R96FX-2B294-BA	11.3541-8530.2	220342	418 646 M1	03.3508-0264.3	310009	42510-SV1-A00	24.0110-0233.1	410233
R96FX-2B294-BA	24.3541-8530.5	240554	418 652 946	83.6103-0650.3	330235	42510-SV4-A00	24.0109-0132.1	409132
R96FX-2B294-BB	11.3541-8530.2	220342	418 654 017	83.6103-0500.3	330230	42510-SX0-000	24.0218-0018.1	480063
R96FX-2B294-BB	24.3541-8530.5	240554	4227 083 M91	03.3508-0264.3	310009	42610-SB2-000	24.0218-0018.1	480063
R96FX-2B302-AA	11.3481-8513.2	220335	4227 410 M91	03.3115-2651.3	010250	42610-SB2-010	24.0220-3016.1	480107
R96FX-2B302-AB	11.3481-8513.2	220335	534 922 902	03.3508-0401.3	310014	42610-SK3-E10	24.0222-0001.1	480123
R96FX-2B302-BA	11.3541-8529.2	220341	540 144 061	83.6103-0200.3	330219	43012-ST3-E00	24.3304-1702.5	240114
R96FX-2B302-BA	24.3541-8529.5	240553	540 184 013	03.5201-0220.3	331272	43012-ST3-E01	24.3304-1701.5	240113
R96FX-2B302-BB	24.3541-8529.5	240553	540 184 427	03.2122-0704.3	010134	43013-ST3-E00	24.3304-1701.5	240113
R97BX-2B294-CA	24.3601-8528.5	240504	541 922 709	03.3509-0100.3	310057	43013-ST3-E01	03.0137-0339.2	650339
R97BX-2B294-CB	24.3601-8528.5	240504	582 908 104	83.6103-0450.3	330228	43015-SP8-000	13.0460-5998.2	605998
R97BX-2B302-CA	24.3601-8527.5	240503	582 923 265	83.6103-0650.3	330235	43021-SK3-E00	13.0460-5998.2	605998
R97BX-2B302-CB	24.3601-8527.5	240503	582 923 734	03.2123-3302.3	010180	43022-S2A-000	13.0460-5929.2	605929
V86BB-2B107-AA	13.0441-4015.2	250080	583 303 929	03.2123-3302.3	010180	43022-S2A-E50	13.0460-5929.2	605929
V89BB-2B107-AA	11.0441-6007.2	250146	583 303 944	03.2522-2612.3	040012	43022-S3N-000	13.0460-5711.2	605711
V89BB-2B486-AA	11.8116-0073.1	390498	583 303 945	24.3222-1733.3	020538	43022-S3N-E50	13.0460-5711.2	605711
V89BB-2L484-AA	11.0441-6007.2	250146	583 303 949	03.3138-2001.3	010310	43022-S5A-E50	13.0460-5929.2	605929
VX443-611190-VX	03.3517-5100.1	390326	583 925 711	03.3138-2001.3	010310	43022-S5A-J00	13.0460-5929.2	605929
XK-186580	03.3508-4903.3	310032	5954 390 410	03.3508-0401.3	310014	43022-S6D-000	13.0460-5929.2	605929
XS51-2261-AA	24.3217-1715.3	020463	603 420 00 18	24.3526-0100.3	340017	43022-S6D-E50	13.0460-5929.2	605929
YS61-2282-AD	24.5305-0310.3	331326	773 922 701	24.3526-0110.3	340018	43022-S7S-010	13.0460-5711.2	605711
			774 922 701	83.6103-0470.3	330229	43022-S9A-E51	13.0460-5711.2	605711
			780 924 746	83.6103-0620.3	330234	43022-S9A-E52	13.0460-5711.2	605711
			900 071 174	83.6103-0470.3	330229	43022-SE0-000	13.0460-5998.2	605998
			900 074 174	83.6103-0620.3	330234	43022-SE0-930	13.0460-5998.2	605998
			974 010 004	83.6203-0260.3	330300	43022-SE0-931	13.0460-5998.2	605998
			974 010 005	83.6123-0471.3	330263	43022-SE0-S00	13.0460-5998.2	605998
			974 010 006	83.6123-0381.3	330262	43022-SED-000	13.0460-5711.2	605711
			974 010 008	83.6103-0600.3	330233	43022-SED-E50	13.0460-5711.2	605711
			974 010 009	03.3517-0300.1	390323	43022-SED-E60	13.0460-5711.2	605711
			974 010 016	24.3526-0110.3	340018	43022-SF1-S00	13.0460-5998.2	605998
			974 010 017	24.3526-0100.3	340017	43022-SF1-S01	13.0460-5998.2	605998
			974 160 001	24.3526-0110.3	340018	43022-SG9-V00	13.0460-2800.2	602800
			974 540 001	83.6103-0620.3	330234	43022-SJF-E00	13.0460-5711.2	605711
			975 803 001	03.3517-0300.1	390323	43022-SL5-000	13.0460-5929.2	605929
			975 323 002	24.3526-0110.3	340017	43022-SM4-G00	13.0460-5929.2	605929
			990 071 174	83.6103-0620.3	330234	43022-SN7-000	13.0460-5929.2	605929
			9987 4225 002	03.3517-0300.1	390323	43022-SN7-E50	13.0460-5929.2	605929
			999 977 693	24.3526-0110.3	340018	43022-SN7-E50HE	13.0460-5929.2	605929
000 295 89 07	03.2525-2602.3	040029	X86.0024.2088.18/00	03.3222-5804.3	020083	43022-SP0-E01	13.0460-5711.2	605711
000 428 01 35	83.6103-0450.3	330228	X86.0074.1740.00	24.3526-0110.3	340018	43022-SR3-G00	13.0460-5998.2	605998
000 428 76 35	83.6133-0500.3	330272	X86.0247.9251.42	24.3526-0810.3	340037	43022-SR3-G01	13.0460-5998.2	605998
000 431 70 12	03.6521-0012.3	320094	X86.0990.0711.74	24.3526-0110.3	340018	43022-ST3-E00	13.0460-5998.2	605998
000 586 33 29	03.0450-2509.2	082509	X86.1820.0546.01	24.3526-0810.3	340037	43022-ST3-E50	13.0460-5998.2	605998
000 586 46 29	03.0450-2510.2	082510				43022-SV4-A00	13.0460-5929.2	605929
001 428 21 35	83.6123-0465.3	330379				43022-SV4-A20	13.0460-5929.2	605929
001 428 53 35	83.6123-0465.3	330379						
002 420 88 18	03.3222-5804.3	020083						
004 317 012	03.6521-0012.3	320094						
005 420 78 18	03.3222-7802.3	020088						
009 420 83 18	03.3222-7802.3	020088						
084 779 000	03.3131-0102.3	010296						
1020 52 05	03.3122-0101.3	010277						
1120 050 431	83.6103-0500.3	330230						
1443 986 X1	03.3517-0300.1	390323						
1820 050 121	83.6203-0200.3	330298						
1820 050 211	83.6203-0300.3	330386						
1820 050 501	03.3304-0700.1	390082						
1820 050 521	83.6123-0465.3	330379						
1820 053 310	03.3222-4401.3	020076						
1820 054 561	03.3304-0700.1	390082						
1820 054 601	24.3526-0810.3	340037						
1820 055 141	83.6103-0200.3	330219						
1823 050 310	03.3222-4401.3	020076						
1823 053 041	03.3318-0800.2	390112						
HANOMAG								
			HENSCHEL					
			1 085 227	03.3517-0300.1	390323			
			1 085 234	83.6103-0600.3	330233			
			920 616	83.6103-0320.3	330224			



Vergleichsliste

Cross reference list - Tabella di conversione codici

Liste des correspondances - Lista referencias



HONDA 			HONDA 			HONDA 		
43022-SV4-E50	13.0460-5929.2	605929	43301-SM4-A01	24.3219-1723.3	020427	45022-SL0-E61	13.0460-5982.2	605982
43022-SV4-G00	13.0460-5929.2	605929	43301-SR3-003	24.3219-1723.3	020427	45022-SL0-G00	13.0460-5982.2	605982
43022-SV4-G21	13.0460-5929.2	605929	43301-ST3-E01	24.3219-1743.3	020485	45022-SL0-G01	13.0460-5982.2	605982
43022-SV4-G22	13.0460-5929.2	605929	44400-SK3-E10	24.0121-0107.1	421107	45022-SL0-G02	13.0460-5982.2	605982
43022-SY8-A01	13.0460-5929.2	605929	45004-SEA-E01	11.8171-0008.1	990049	45022-SM4-A00	13.0460-5818.2	605818
43022-SZ3-A01	13.0460-5711.2	605711	45007-SEA-E01	11.0101-5407.2	260011	45022-SM5-A00	13.0460-5982.2	605982
43022-SZ3-E50	13.0460-5711.2	605711	45012-ST3-E00	24.3541-1814.5	240382	45022-SN7-E50	13.0460-5982.2	605982
43022-TF2-G00	13.0460-5929.2	605929	45013-ST3-E00	24.3541-1813.5	240381	45022-SR3-G40	13.0460-5955.2	605955
43022-TM8-G01	13.0460-5929.2	605929	45021-SK3-E00	24.3541-1814.5	240382	45022-SN7-G41	13.0460-5955.2	605955
43023-SK3-E00	24.3304-1701.5	240113	45022-S04-602	13.0460-5943.2	605943	45022-SN7-G42	13.0460-5955.2	605955
43024-SK3-E10	03.0137-9221.2	669221	45022-S04-G00	13.0460-5943.2	605943	45022-SN7-G50	13.0460-5982.2	605982
43053-S2G-E50	03.0137-0294.2	650294	45022-S04-G02	13.0460-5943.2	605943	45022-SN7-Y40	13.0460-5955.2	605955
43053-S5A-E50	03.0137-0294.2	650294	45022-S04-J02	13.0460-5943.2	605943	45022-SR3-910	13.0460-5919.2	605919
43053-SM4-E50	03.0137-0287.2	650287	45022-S04-V10	13.0460-5820.2	605820	45022-SR3-G00	13.0460-5943.2	605943
43053-SR3-A00	03.0137-0284.2	650284	45022-S10-A00	13.0460-5982.2	605982	45022-SR3-G01	13.0460-5943.2	605943
43153-S04-A01	03.0137-0284.2	650284	45022-S10-A01	13.0460-5982.2	605982	45022-SR3-V01	13.0460-5820.2	605820
43153-S2G-951	03.0137-0294.2	650294	45022-S10-A02	13.0460-5982.2	605982	45022-SR3-V10	13.0460-5820.2	605820
43153-S2H-003	03.0137-0294.2	650294	45022-S30-A00	13.0460-5982.2	605982	45022-SR3-V11	13.0460-5820.2	605820
43153-S5A-J01	03.0137-0294.2	650294	45022-S30-A01	13.0460-5982.2	605982	45022-SR3-V12	13.0460-5820.2	605820
43153-S6A-J01	03.0137-0287.2	650287	45022-S30-A02	13.0460-5982.2	605982	45022-SS0-G00	13.0460-5982.2	605982
43153-SA2-601	03.0137-0179.2	650179	45022-S30-E50	13.0460-5982.2	605982	45022-SS0-G01	13.0460-5955.2	605955
43153-SB2-003	03.0137-0179.2	650179	45022-S30-G10	13.0460-5955.2	605955	45022-SS0-G10	13.0460-5955.2	605955
43153-SB2-601	03.0137-0179.2	650179	45022-S30-G10	13.0460-5955.2	605955	45022-ST3-E01	13.0460-2803.2	602803
43153-SB2-603	03.0137-0179.2	650179	45022-S5A-E50	13.0460-5820.2	605820	45023-SK3-E00	24.3541-1813.5	240381
43153-SE0-003	03.0137-0294.2	650294	45022-S5A-G00	13.0460-5820.2	605820	45172-S04-003	03.0137-9096.2	669096
43153-SE0-013	03.0137-0294.2	650294	45022-S5A-G01	13.0460-5820.2	605820	45226-SF1-003	13.0460-0308.2	610308
43153-SE0-N51	03.0137-0294.2	650294	45022-S5B-E00	13.0460-5820.2	605820	45227-SM4-003	13.0460-0075.2	610075
43153-SE0-S01	03.0137-0294.2	650294	45022-S6D-E01	13.0460-2803.2	602803	45237-SM5-A01	13.0460-0075.2	610075
43153-SH3-003	03.0137-0179.2	650179	45022-S6D-E50	13.0460-0142.2	610142	45237-SP0-003	13.0460-0075.2	610075
43153-SH3-013	03.0137-0179.2	650179	45022-S6D-E51	13.0460-0142.2	610142	45237-SR3-003	13.0460-0073.2	610073
43153-SH3-023	03.0137-0179.2	650179	45022-S74-E10	13.0460-2803.2	602803	45237-SS0-A01	13.0460-0075.2	610075
43153-SH3-A01	03.0137-0179.2	650179	45022-S74-E50	13.0460-2803.2	602803	45238-SR3-003	13.0460-0073.2	610073
43153-SH3-A02	03.0137-0179.2	650179	45022-S74-E50	13.0460-2803.2	602803	45251-S1A-G60	24.0123-0105.1	423105
43153-SH3-G02	03.0137-0179.2	650179	45022-SA0-660	13.0460-5916.2	605916	45251-S5D-A10	24.0121-0105.1	421105
43153-SJ6-023	03.0137-0294.2	650294	45022-SA0-670	13.0460-5916.2	605916	45251-S6D-E10	24.0121-0105.1	421105
43153-SM4-003	03.0137-0294.2	650294	45022-SA0-N50	13.0460-5916.2	605916	45251-SA6-670	24.0119-0104.1	419104
43153-SM4-A01	03.0137-0287.2	650287	45022-SA6-600	13.0460-5936.2	605936	45251-SB2-010	24.0112-0102.1	412102
43153-SR3-003	03.0137-0179.2	650179	45022-SA6-N50	13.0460-5936.2	605936	45251-SB2-020	24.0112-0102.1	412102
43153-SR3-A01	03.0137-0284.2	650284	45022-SAA-E50	13.0460-5943.2	605943	45251-SB2-030	24.0112-0102.1	412102
43153-SR4-A02	03.0137-0294.2	650294	45022-SAA-E51	13.0460-5943.2	605943	45251-SB2-720	24.0112-0102.1	412102
43153-SR7-003	03.0137-0294.2	650294	45022-SAA-G00	13.0460-5943.2	605943	45251-SB2-730	24.0112-0102.1	412102
43153-ST0-J01	03.0137-0294.2	650294	45022-SB0-505	13.0460-5919.2	605919	45251-SB2-731	24.0112-0102.1	412102
43153-SV4-J01	03.0137-0294.2	650294	45022-SB0-670	13.0460-5919.2	605919	45251-SB2-732	24.0112-0102.1	412102
43154-SM4-A01	03.0137-0287.2	650287	45022-SB0-671	13.0460-5918.2	605918	45251-SB2-750	24.0117-0101.1	417101
43155-SM4-A01	03.0137-0287.2	650287	45022-SB0-672	13.0460-5918.2	605918	45251-SB2-751	24.0117-0101.1	417101
43171-S04-N01	03.0137-9096.2	669096	45022-SD2-506	13.0460-5918.2	605918	45251-SB2-752	24.0117-0101.1	417101
43171-SK3-E10	03.0137-9221.2	669221	45022-SD2-A11	13.0460-5918.2	605918	45251-SB2-780	24.0119-0106.1	419106
43172-S04-003	03.0137-9096.2	669096	45022-SD2-A12	13.0460-5918.2	605918	45251-SB2-781	24.0119-0106.1	419106
43172-S04-N01	03.0137-9096.2	669096	45022-SD2-A13	13.0460-5918.2	605918	45251-SB2-782	24.0119-0106.1	419106
43172-SK3-E10	03.0137-9221.2	669221	45022-SE0-505	13.0460-5918.2	605918	45251-SB2-930	24.0117-0101.1	417101
43172-ST3-E01	03.0137-9221.2	669221	45022-SE0-910	13.0460-5918.2	605918	45251-SB2-931	24.0117-0101.1	417101
43175-SK3-E10	03.0137-9221.2	669221	45022-SE0-911	13.0460-5918.2	605918	45251-SB2-932	24.0117-0101.1	417101
43175-ST3-E01	03.0137-9221.2	669221	45022-SE0-912	13.0460-5918.2	605918	45251-SB2-940	24.0117-0101.1	417101
43183-SK3-E10	03.0137-9221.2	669221	45022-SE0-A00	13.0460-5918.2	605918	45251-SB2-990	24.0119-0106.1	419106
43183-ST3-E01	03.0137-9221.2	669221	45022-SE0-A01	13.0460-5918.2	605918	45251-SCC-000	24.0121-0105.1	421105
43185-SK3-E10	03.0137-9221.2	669221	45022-SE0-A10	13.0460-5918.2	605918	45251-SCC-900	24.0121-0105.1	421105
43185-ST3-E01	03.0137-9221.2	669221	45022-SE0-A11	13.0460-5918.2	605918	45251-SCC-901	24.0121-0105.1	421105
43227-SG0-013	13.0460-0287.2	610287	45022-SE0-A12	13.0460-5918.2	605918	45251-SE0-010	24.0119-0104.1	419104
43244-SG0-003	13.0460-0287.2	610287	45022-SF1-000	13.0460-5920.2	605920	45251-SF0-000	24.0121-0102.1	421102
43244-SZ3-A01	13.0460-0287.2	610287	45022-SF1-010	13.0460-5920.2	605920	45251-SG9-000	24.0121-0100.1	421100
43300-S04-003	24.3219-1724.3	020428	45022-SF1-020	13.0460-5920.2	605920	45251-SH1-A00	24.0121-0104.1	421104
43300-SA3-681	24.3219-1122.3	020364	45022-SH3-930	13.0460-5920.2	605920	45251-SH3-A00	24.0121-0104.1	421104
43300-SB2-003	24.3219-1122.3	020364	45022-SH3-931	13.0460-5920.2	605920	45251-SK3-E00	24.0121-0107.1	421107
43300-SH3-J01	24.3219-1724.3	020428	45022-SH3-932	13.0460-5920.2	605920	45251-SK7-A00	24.0121-0105.1	421105
43300-SM4-A01	24.3219-1724.3	020428	45022-SH3-G00	13.0460-5919.2	605919	45251-SK7-A10	24.0121-0105.1	421105
43300-SR3-003	24.3219-1724.3	020428	45022-SH3-G03	13.0460-5919.2	605919	45251-SK7-J00	24.0121-0105.1	421105
43300-ST3-E01	24.3219-1743.3	020485	45022-SH3-G30	13.0460-5920.2	605920	45251-SM4-010	24.0123-0103.1	423103
43301-S04-003	24.3219-1723.3	020427	45022-SH3-G31	13.0460-5920.2	605920	45251-SM4-020	24.0123-0103.1	423103
43301-SA3-681	24.3219-1121.3	020363	45022-SH3-G32	13.0460-5920.2	605920	45251-SM5-A00	24.0125-0130.1	425130
43301-SB2-003	24.3219-1121.3	020363	45022-SH3-G33	13.0460-5920.2	605920	45251-SN7-E40	24.0123-0103.1	423103
43301-SH3-J01	24.3219-1723.3	020427	45022-SH3-G50	13.0460-5919.2	605919	45251-SP0-E00	24.0128-0722.1	428722



Vergleichsliste

Cross reference list - Tabella di conversione codici

Liste des correspondances - Lista referencias

 HONDA			 HYUNDAI			 JAGUAR		
45251-SR0-A00	24.0121-0105.1	421105	59760-22000	24.3727-3103.2	583103	JLM 20671	11.0441-4811.2	250024
45251-SR0-A10	24.0121-0105.1	421105	59760-22100	24.3727-3103.2	583103	JLM 20702	13.0460-7138.2	607138
45251-SR3-A10	24.0121-0104.1	421104	59760-22110	24.3727-3103.2	583103	JLM 21222	13.0460-7138.2	607138
45251-SS0-000	24.0123-0105.1	423105	59770-22000	24.3727-3102.2	583102	JLM 21469	11.9601-9782.2	220992
45251-SS0-A00	24.0123-0106.1	423106	59770-22100	24.3727-3102.2	583102	JLM 21495	11.0441-6007.2	250146
45251-ST3-E10	24.0121-0105.1	421105	59770-22110	24.3727-3102.2	583102	JLM 2191	11.0441-6003.2	250037
45251-ST3-E60	24.0123-0106.1	423106	MB858404	24.3431-1705.5	240365	JLM 2194	11.0101-5407.2	260011
45251-TF3-E00	24.0121-0105.1	421105	MB858405	24.3431-1706.5	240366	JLM 2196	11.8116-0073.1	390498
45251-TG5-H00	24.0121-0105.1	421105	ISUZU			JLM 2200	11.0441-3602.2	250008
46100-S04-A01	24.2120-1751.3	010909	8-94172-376-1	24.0122-0156.1	422156	JLM 2201	03.0137-9700.2	669700
46100-S04-A02	24.2120-1751.3	010909	8-94173-244-0	24.0112-0145.1	412145	JLM 2213	11.8171-0008.1	990049
			8-94173-244-2	24.0112-0145.1	412145	JLM 2219	11.8171-0008.1	990049
HYUNDAI			8-94230-541-4	24.3225-1702.3	020425	JLM 2277	24.0124-0174.1	424174
51712-21350	24.0119-0109.1	419109	8-94230-541-5	24.3225-1702.3	020425	MJA 5824 AA	24.0124-0174.1	424174
51712-21350DS	24.0119-0109.1	419109	8-94388-016-0	24.3526-0110.3	340017	MJD 7868 AA	83.7835-0412.3	331275
51712-21B00	24.0119-0109.1	419109	8-94388-017-0	24.3526-0110.3	340018	MJE 2001 AB	11.0441-6007.2	250146
51712-24100	24.0119-0109.1	419109	8-94461-155-0	24.3601-1715.5	240389	MNA 5680 AA	13.0460-7138.2	607138
51712-28000	24.0119-0111.1	419111	8-97127-616-0	13.0460-5942.2	605942		83.6314-0375.3	330558
51712-28000D	24.0119-0111.1	419111		24.3225-1702.3	020425	JEEP		
51712-28300	24.0122-0170.1	422170	IVECO			0 4423 601	24.3220-1748.3	020584
51712-28300	24.0322-0170.1	522170	1287342	24.3526-0100.3	340017	0 5015 965AA	24.0124-0702.1	424702
51712-33001	24.0122-0169.1	422169	1906039	13.0460-4955.2	604955	0 5200 5000	24.0124-0702.1	424702
51712-M2000	24.0124-0136.1	424136	1906350	03.0137-0300.2	650300	0 5200 7710	24.0124-0702.1	424702
58101-17A00	13.0460-5933.2	605933	1906350	03.0137-0309.2	650309	0 5200 8264	24.0124-0702.1	424702
58101-22A00	13.0460-5936.2	605936	1906352	13.0460-2843.2	602843	0 5200 8440	24.0124-0702.1	424702
58101-22A10	13.0460-5936.2	605936	1906402	13.0460-4914.2	604914	0 5252 617	24.3220-1748.3	020584
58101-24A00	13.0460-5936.2	605936	1906416	24.8190-2901.2	622901	4423 601	24.3220-1748.3	020584
58101-24B00	13.0460-5936.2	605936	1906416	24.8190-2901.2	622901	5015 965AA	24.0124-0702.1	424702
58101-24C00	13.0460-5936.2	605936	1907942	24.3526-0810.3	340037	5200 5000	24.0124-0702.1	424702
58101-28A00	13.0460-5933.2	605933	03416614	24.3526-0810.3	340037	5200 7710	24.0124-0702.1	424702
58101-29A00	13.0460-5933.2	605933	03420508	24.3526-1900.0	340038	5200 8264	24.0124-0702.1	424702
58101-29A10	13.0460-5933.2	605933	42031890	24.3526-0810.3	340037	5200 8440	24.0124-0702.1	424702
58101-29A30	13.0460-5933.2	605933	1171493801	24.3526-0810.3	340037	5252 617	24.3220-1748.3	020584
58101-29A50	13.0460-5933.2	605933	5145801907	24.3526-0100.3	340017	83 03 251 156	24.0122-0181.1	422181
58101-2DA20	13.0460-5933.2	605933	8751280117	24.3526-0100.3	340017	98 83 251 156	24.0122-0181.1	422181
58101-33A00	13.0460-5933.2	605933	33528121-2	24.3526-0110.3	340018	J325 1156	24.0122-0181.1	422181
58101-33C00	13.0460-5933.2	605933	5155-28-03.12	24.3526-0110.3	340018	KÄSSBOHRER		
58101-34A10	13.0460-5933.2	605933	5157-28-10.272	24.3526-0110.3	340018	4.527.005.000	83.6103-0500.3	330230
58101-34A20	13.0460-5933.2	605933	F5155280312	24.3526-0810.3	340037	8.282.095.000	03.3131-0601.3	010299
58101-34A21	13.0460-5933.2	605933	JAGUAR			8.282.095.100	03.3131-0601.3	010299
58101-35A10	13.0460-5933.2	605933	C2C 24016	13.0460-4964.2	604964	8.282.166.000	03.3125-0401.3	010290
58101-38A00	13.0460-5933.2	605933	C2C 27297	11.8171-0008.1	990049	8.282.191.000	03.3138-2010.3	010311
58101-38A20	13.0460-5933.2	605933	C2C 29161	11.0101-5407.2	260011	8.282.191.200	03.3138-2010.3	010311
58101-38A40	13.0460-5933.2	605933	C2C 8361	13.0460-4964.2	604964	8.282.192.000	03.3134-0300.3	010308
58161-31000	24.0113-0122.1	413122	C2S 19829	24.2532-5003.3	090013	8.282.192.200	03.3134-0300.3	010308
58180-23A00	24.3541-1807.5	240335	C2S 46903	24.2532-5003.3	090013	8.282.030.000 E	03.3125-0401.3	010290
58180-24A00	24.3541-1807.5	240335	CAC 4188	24.7718-7301.2	990024	KIA		
58180-25A00	24.3541-1807.5	240335	DBC 6595	24.8190-1302.2	621302	OK20A-33-25Z	11.0101-5407.2	260011
58180-28A00	24.3541-1807.5	240335	JLM 10601	24.0110-0319.1	410319	OK20A-33-69A	11.8171-0008.1	990049
58181-23A00	24.3541-1808.5	240336	JLM 11114	13.0460-7246.2	607246	OK20A-43-900A	03.0101-0014.2	320004
58181-24A00	24.3541-1808.5	240336	JLM 11176	11.9601-9782.2	220992	OK30A-26-610	24.3217-1120.3	020360
58181-25A00	24.3541-1808.5	240336	JLM 11716	11.9481-9872.2	220682	OK30A-33-28Z	13.0460-5944.2	605944
58181-28A00	24.3541-1808.5	240336	JLM 11870	11.9481-9871.2	220681	OK70Y-33-28Z	13.0460-5806.2	605806
58305-22A01	03.0137-0366.2	650366	JLM 11871	24.0120-0188.1	420188	OK72A-26-38Z	03.0137-0486.2	650486
58305-22A00	03.0137-0367.2	650367	JLM 11904	24.0110-0319.1	410319	51712-21350	24.0119-0109.1	419109
58305-28A00	03.0137-0369.2	650369	JLM 12123	11.9481-9872.2	220682	51712-24100	24.0119-0109.1	419109
58305-28B00	03.0137-0369.2	650369	JLM 12124	11.9481-9871.2	220681	51712-M2000	24.0124-0136.1	424136
58305-28C00	03.0137-0369.2	650369	JLM 12304	24.0120-0188.1	420188	58101-17A00	13.0460-5933.2	605933
58305-28D00	03.0137-0369.2	650369	JLM 12424	24.0123-0108.1	423108	58101-29A10	13.0460-5933.2	605933
58305-28E00	03.0137-0369.2	650369	JLM 12426	24.0128-0138.1	428138	58101-2DA20	13.0460-5933.2	605933
58305-29A00	03.0137-0369.2	650369	JLM 12427	13.0460-7138.2	607138	58101-38A00	13.0460-5933.2	605933
58305-44A00	03.0137-0036.2	650036	JLM 12428	24.0110-0319.1	410319	58101-38A20	13.0460-5933.2	605933
58305-44A10	03.0137-0036.2	650036	JLM 1305	11.9481-9872.2	220992	58101-38A40	13.0460-5933.2	605933
58305-44A40	03.0137-0036.2	650036	JLM 1826	24.0120-0188.1	420188			
58330-25000	24.3219-1743.3	020485	JLM 1829	24.0123-0138.1	428138			
58380-25000	24.3219-1743.3	020485	JLM 1830	13.0460-7138.2	607138			
58411-22000	24.0218-0027.1	480099	JLM 1833	24.0110-0319.1	410319			
58411-22010	24.0218-0027.1	480099	JLM 20341	13.0460-7246.2	607246			
58411-22020	24.0218-0027.1	480099	JLM 20342	24.0128-0138.1	428138			
				24.0120-0188.1	420188			



Vergleichsliste

Cross reference list - Tabella di conversione codici



Liste des correspondances - Lista referencias

KIA			LAND ROVER			MAGIRUS (KHD)		
58101-M2A04	13.0460-5933.2	605933	SFP000140	13.0460-6925.2	606925	113 2431 E 8834-02	83.6103-0320.3	330224
K0BA2-33-28Z	13.0460-5944.2	605944	SFP000160	13.0460-6923.2	606923	1171-4938.01	24.3526-0810.3	340037
KD001-33-29Z	13.0460-0451.2	610451	SFP000250	13.0460-6924.2	606924	127 1610 TY 8751-28	03.0370-1131.2	051131
KK150-26-38Z	03.0137-0204.2	650204	SFP000260	13.0460-6925.2	606925	1472-8701.31	83.6103-0400.3	330226
KK150-33-23Z	13.0460-5970.2	605970	SFP000280	13.0460-6923.2	606923	2030-3706.05	03.3318-0800.2	390112
KK150-33-251	24.0113-0165.1	413165	SML100070	24.3220-1112.3	020223	237 4448 KZ 1210-30	03.2515-1101.3	040001
KK150-33-28Z	13.0460-5970.2	605970	STC1275	13.0460-6925.2	606925	237 4908 UA 1210-30	83.6203-0250.3	330299
MDA01-33-251	24.0113-0165.1	413165	STC1601	13.0460-6923.2	606923	244 2720 ED 5075-52	03.2515-1101.3	040001
MDX01-26-380	03.0137-9113.2	669113	STC2952	13.0460-6925.2	606925	246 8167 KZ 5082-28	03.3134-0300.3	010308
MDX01-26-391	03.0137-9113.2	669113	STC3765	13.0460-6922.2	606922	246 8233 KZ 5082-28	03.3138-2001.3	010310
			STC8568	13.0460-6926.2	606926	296 1029-5140-28	03.3318-0800.2	390112
LADA			STC8570	13.0460-6917.2	606917	3060-345 M8	24.3526-0810.3	340037
1118-3502070	24.0220-0020.1	480059	STC8571	13.0460-6916.2	606916	330 671 29	83.6103-0500.3	330230
2101-1602510	24.2519-0505.3	040070	STC8572	13.0460-6922.2	606922	335 281 212	24.3526-0100.3	340017
2101-1602610	24.2419-1101.3	030085	STC8574	13.0460-0414.2	610414	341 6614 EE 5034-80	24.3526-0810.3	340037
2101-3103002	24.0111-0115.1	411115	STC9187	13.0460-6926.2	606926	342 0509 E 5087-28	03.3517-0300.1	390323
2101-3501070	24.0111-0115.1	411115	STC9189	13.0460-6917.2	606917	342 3580 KZ 5081-28	03.3508-0264.3	310009
2101-3501089	13.0460-2966.2	602966	STC9190	13.0460-6916.2	606916	385 835 85	83.6103-0620.3	330234
2101-3501090	13.0460-2966.2	602966	STC9191	13.0460-6922.2	606922	432 6387	03.3508-0401.3	310014
2101-3502040	24.3220-1102.3	020213	SYG000030	11.8171-0008.1	990049	446 9763 KZ 5081-28	03.3508-5951.3	310041
2101-3502040-10	24.3220-1102.3	020213	SZR000010	11.8116-0296.1	390445	5112-5206.18	83.6103-0320.3	330224
2101-3502090	03.0137-0232.2	650232				5145-8019.07	24.3526-0810.3	340037
2101-3502090-01	03.0137-0232.2	650232	LEXUS			5148-5203.05	03.3508-0401.3	310014
2101-3502090-80	03.0137-0232.2	650232	04466-60080	13.0460-5744.2	605744	5155-2803.13	03.3517-0300.1	390323
2101-3505008	24.2119-0831.3	010416	04466-60090	13.0460-5744.2	605744	5155-5211.10	03.2515-1101.3	040001
2101-3505009	24.2119-0832.3	010417	04466-60140	13.0460-5744.2	605744	5156-2801.10	83.6103-0620.3	330234
2101-3508180	24.3727-2402.2	582402	46540-20060	03.0137-0402.2	650402	5157-2810.272	24.3526-0110.3	340018
2103-2305009	24.2119-0832.3	010417	46540-20070	03.0137-0402.2	650402	5157-2810.90	03.3509-0100.3	310057
21050-3502040	24.3220-1103.3	020214	46540-20070	03.0137-0402.2	650402	5157-2812.160	83.6103-0190.3	330218
2105-3502040	24.3220-1103.3	020214	46540-28010	03.0137-0400.2	650400	5167-2812.01	83.6103-0600.3	330233
21080-3502070	24.0220-0020.1	480059	46540-44010	03.0137-0400.2	650400	5167-2812.07	83.6103-0450.3	330228
21080-3502090	03.0137-0231.2	650231	46540-50010	03.0137-0400.2	650400	5167-2812.08	83.6103-0300.3	330223
2108-3501070	24.0112-0125.1	412125	46550-20060	03.0137-0402.2	650402	5167-2812.11	03.3138-2001.3	010310
2108-3501070	24.0312-0125.1	512125	46550-28010	03.0137-0400.2	650400	5177-2835.01	83.6103-0400.3	330226
2108-3501080	13.0460-2965.2	602965	46550-33020	03.0137-0402.2	650402	7101-4099.42	03.3517-0300.1	390323
2108-3501089	13.0460-2965.2	602965	46550-50010	03.0137-0400.2	650400	8000-0604	24.2423-0905.3	030070
2108-3502070	24.0220-0020.1	480059	46590-20060	03.0137-0402.2	650402	8602-8006	24.2423-0905.3	030070
2108-3502090	03.0137-0231.2	650231	46590-28010	03.0137-0400.2	650400	8602-8036	24.2423-0905.3	030070
2108-3502090-80	03.0137-0231.2	650231	46590-33020	03.0137-0402.2	650402	8603-0915	24.2538-0901.3	040056
2108-3505010	24.2120-0803.3	010415	46590-50010	03.0137-0400.2	650400	8751-2801.17	24.3526-0100.3	340017
2108-3506060	24.5127-0305.3	330578				8751-2801.71	03.3318-0800.2	390112
2108-3508180	24.3727-2403.2	582403	MAGIRUS (KHD)			8751-2890.220	03.2419-1451.3	030012
21100-3501089	13.0460-2965.2	602965	1-3112	83.6103-0450.3	330228	DIN 74225 EE 10	83.6203-0400.3	330302
2110-3501080	13.0460-2965.2	602965	1287342	24.3526-0100.3	340017	E 5155-2803.12	24.3526-0100.3	340017
2110-3501089	13.0460-2965.2	602965	0113-2430	83.6203-0250.3	330299	K 18 117	83.6103-0550.3	330231
2121-3501070	24.0112-0130.1	412130	0113-2431	83.6103-0320.3	330224	S 18 921	83.6103-0650.3	330235
2121-3501090	13.0460-8006.2	608006	0113-7292	83.6103-0300.3	330223			
2121-3502070	24.0225-0004.1	480058	0231-7786	24.3526-0810.3	340037	MAN		
2121-3505009	24.2119-0832.3	010417	0237-4448	03.2515-1101.3	040001	38.91411.0170	03.3131-0102.3	010296
2121-3508180	24.3727-2401.2	582401	0341-0834	83.6103-0320.3	330224	81.25505.0193	24.3526-0100.3	340017
			0342-0509	03.3517-0300.1	390323	81.25505.0247	24.3526-0100.3	340017
LAND ROVER			0431-1134	03.3508-5951.3	310041	81.25520.0023	24.3526-0810.3	340037
FRC7329	24.0114-0108.1	414108	0431-4921	13.2601-8038.2	210170	81.30716.6002	03.0450-2509.2	082509
FRC7392	24.0114-0108.1	414108	0431-4923	13.2601-8036.2	210168	81.31110.7000	03.3508-0264.3	310009
FRC9831	24.0113-0189.1	413189	0431-4924	13.2601-8037.2	210169	81.51130.6003	03.0370-1131.2	051131
FTC1381	24.0113-0189.1	413189	0431-6931	13.0441-5416.2	250117	81.51130.6006	03.3138-2001.3	010310
FTC3846	24.0114-0108.1	414108	0431-7986	03.3508-8801.3	310050	81.51130.6017	03.3131-0601.3	010299
FTC902	24.0124-0143.1	424143	0432-2292	13.0441-6001.2	250126	81.51130.7000	03.3131-0601.3	010299
GWC1821	24.3220-1112.3	020223	0432-6387	03.3508-0401.3	310014	81.51133.0003	03.3318-0800.2	390112
LR000750	11.8171-0008.1	990049	0433-8428	13.0441-6010.2	250132	81.51210.0029	83.6103-0260.3	330221
LR000751	11.0101-5407.2	260011	0434-4643	13.0441-5416.2	250117	81.51210.0030	83.6103-0650.3	330235
LR003977	11.8171-0008.1	990049	0437-3912	03.3508-8802.3	310051	81.51210.0031	83.6203-0260.3	330300
NTC4991	24.2125-1710.3	010559	0437-5656	13.0441-4018.2	250083	81.51210.0036	83.6103-0800.3	330237
RTC4518	13.0460-6926.2	606926	0625-9259	13.2481-8012.2	210093	81.51210.2001	83.6103-0550.3	330231
RTC5574	13.0460-6925.2	606925	0625-9260	13.2481-8011.2	210092	81.51210.5005	83.6103-0620.3	330234
RTC5756	13.0460-6922.2	606922	1 1114 019 908.00	13.0441-5416.2	250117	81.51501.6001	03.3509-0600.3	310065
SDB000330	24.0114-0115.1	414115	1 2114 010 520.00	13.2481-8012.2	210093	81.51501.7004	03.3508-0501.3	310017
SDB100980	24.0114-0115.1	414115	1 2114 010 530.00	13.2481-8011.2	210092	81.90310.0148	03.3517-0300.1	390323
SFP000130	13.0460-6924.2	606924	1 2114 019 901.00	13.0441-4825.2	250107	81.96340.0045	83.6103-0500.3	330230
			112 5468 E-8834-02	83.6123-0381.3	330262	81.96340.0081	83.6103-0700.3	330236

Vergleichsliste

Cross reference list - Tabella di conversione codici



Liste des correspondances - Lista referencias

MAN 	MAZDA 	MAZDA 
81.96340.0103	83.6103-0450.3	330228
81.96340.0213	83.6103-0320.3	330224
90.81051.8186	03.3150-0101.3	010321
90.81052.2203	03.3508-0401.3	310014
90.81052.2486	24.3526-0110.3	340018
90.81052.2495	24.3526-0810.3	340037
90.81084.5147	24.3526-0100.3	340017
MASERATI		
327256318	11.8116-0091.1	390502
MAZDA		
1E00-26-251	24.0218-0024.2	480079
1E00-26-251	24.0218-0724.2	480206
1E00-26-251A	24.0218-0024.2	480079
1E00-26-251A	24.0218-0724.2	480206
1E01-26-251	24.0218-0024.2	480079
1E01-26-251	24.0218-0724.2	480206
1E01-26-251A	24.0218-0024.2	480079
1E01-26-251A	24.0218-0724.2	480206
1E02-26-251	24.0218-0024.2	480079
1E02-26-251	24.0218-0724.2	480206
1E03-26-610	24.3217-1715.3	020463
1E03-33-23Z	13.0460-7073.2	607073
1E03-33-23ZA	13.0460-7073.2	607073
1E03-33-23ZB	13.0460-7073.2	607073
1E03-33-251	24.0112-0141.1	412141
1E03-33-251A	24.0112-0141.1	412141
1E03-33-980	11.3481-8514.2	220336
1E03-33-990	11.3481-8513.2	220335
1E04-26-610	24.3217-1715.3	020463
1E04-33-251	24.0112-0141.1	412141
1E06-26-610	24.3219-1107.3	020338
1E06-33-23Z	13.0460-7071.2	607071
1E06-33-23ZA	13.0460-7071.2	607071
1E06-33-23ZB	13.0460-7071.2	607071
1E06-33-980	11.3541-8530.2	220342
1E06-33-980	24.3541-8530.5	240554
1E06-33-990	11.3541-8529.2	220341
1E06-33-990	24.3541-8529.5	240553
1E07-26-610	24.3219-1107.3	020338
B092-26-251	24.0220-0029.1	480120
B092-26-610	24.3217-1703.3	020380
B0YW-33-23Z	13.0460-5974.2	605974
B0YW-33-23ZC	13.0460-5974.2	605974
B107-33-251	24.0118-0101.1	418101
B216-26-610	24.3217-1703.3	020380
B216-26-610A	24.3217-1703.3	020380
B216-26-610B	24.3217-1703.3	020380
B455-33-292	13.0460-5944.2	605944
B455-44-410E	24.3727-1810.2	581810
B455-44-420E	24.3727-1811.2	581811
B461-26-251C	24.0109-0127.1	409127
B461-26-251D	24.0109-0127.1	409127
B4Y2-26-251	24.0109-0127.1	409127
B4Y2-26-251A	24.0109-0127.1	409127
B4Y2-26-251B	24.0109-0127.1	409127
B4Y2-26-251C	24.0109-0127.1	409127
B4Y6-33-23Z	13.0460-5944.2	605944
B4Y6-33-23ZA	13.0460-5944.2	605944
B530-26-251A	24.0109-0131.1	409131
B596-26-251	24.0220-0026.1	480104
B596-26-251A	24.0220-0026.1	480104
B596-26-251C	24.0220-0026.1	480104
B596-26-251D	24.0220-0026.1	480104
B596-26-380B	03.0137-9182.2	669182
B596-26-390A	03.0137-9182.2	669182
B5Y6-26-38Z	03.0137-0278.2	650278
B5Y6-26-38ZA	03.0137-0278.2	650278
B5Y6-33-23Z	13.0460-5944.2	605944
B5Y6-33-28Z	13.0460-5944.2	605944
B5Y8-33-23Z	13.0460-5944.2	605944
B5Y8-33-23ZA	13.0460-5944.2	605944
B6Y3-26-43Z	13.0460-5824.2	605824
B6Y3-26-43ZA	13.0460-5824.2	605824
B6Y3-26-48Z	13.0460-5824.2	605824
BB4C-26-251	24.0109-0131.1	409131
BB4C-26-251A	24.0109-0131.1	409131
BB4C-26-251B	24.0109-0131.1	409131
BB4C-26-251C	24.0109-0131.1	409131
BB7E-33-25XA	24.0122-0165.1	422165
BB7E-33-25XB	24.0122-0165.1	422165
BB7E-33-25XC	24.0122-0165.1	422165
BB7E-33-25XD	24.0122-0165.1	422165
BCYC-33-23Z	13.0460-5944.2	605944
BCYD-26-38Z	03.0137-0278.2	650278
BCYD-26-38ZA	03.0137-0278.2	650278
BCYW-33-23Z	13.0460-5944.2	605944
BCYW-33-23ZC	13.0460-5944.2	605944
BF68-33-251A	24.0118-0101.1	418101
BL78-26-43Z	13.0460-5824.2	605824
BL78-26-48Z	13.0460-5824.2	605824
BLYM-33-23Z	13.0460-5954.2	605954
BP18-26-38Z	03.0137-0184.2	650184
BP18-26-38ZA	03.0137-0184.2	650184
BR70-33-25XA	24.0122-0166.1	422166
BR70-33-25XF	24.0122-0166.1	422166
BR74-26-251A	24.0109-0131.1	409131
BR74-26-251B	24.0109-0131.1	409131
BR74-26-251E	24.0109-0131.1	409131
BR74-33-25X	24.0122-0165.1	422165
BRY0-33-28Z	13.0460-5944.2	605944
BRY4-33-23Z	13.0460-5974.2	605974
BRY4-33-28Z	13.0460-5974.2	605974
BSY6-26-38Z	03.0137-0239.2	650239
BWYH-26-43Z	13.0460-5972.2	605972
CB01-33-980D	24.3571-1704.5	240100
CB01-33-980E	24.3571-1704.5	240100
CB01-33-980F	24.3571-1704.5	240100
CB01-33-990D	24.3571-1703.5	240099
CB01-33-990E	24.3571-1703.5	240099
CB01-33-990F	24.3571-1703.5	240099
CB80-33-980	24.3571-1704.5	240100
CB80-33-980A	24.3571-1704.5	240100
CB80-33-990	24.3571-1703.5	240099
CB80-33-990A	24.3571-1703.5	240099
CBY0-33-23Z	13.0460-5954.2	605954
CBY1-33-23ZA	13.0460-5954.2	605954
CBY1-33-23ZB	13.0460-5954.2	605954
CBY1-33-23ZC	13.0460-5954.2	605954
CBY1-33-23ZD	13.0460-5954.2	605954
CBY1-33-23ZE	13.0460-5954.2	605954
CBY1-33-23ZF	13.0460-5954.2	605954
CBY1-33-23ZG	13.0460-5954.2	605954
CBY9-33-23Z	13.0460-5954.2	605954
CBY9-33-28Z	13.0460-5954.2	605954
CC29-44-150	24.3727-1812.2	581812
D061-26-380	03.0137-9186.2	669186
D102-26-251	24.0220-0026.1	480104
DA01-33-251	24.0113-0165.1	413165
DA15-26-38Z	03.0137-0204.2	650204
DA15-26-38ZA	03.0137-0204.2	650204
DA19-33-28Z	13.0460-5970.2	605970
DA19-33-28ZA	13.0460-5970.2	605970
DAY5-26-710	24.3219-1752.3	020505
DB0Y-33-251	24.0112-0147.1	412147
DBY2-26-38Z	03.0137-0263.2	650263
DCY0-33-23ZA	13.0460-5944.2	605944
DCY0-33-23ZB	13.0460-5944.2	605944
DCY1-33-23Z	13.0460-5944.2	605944
DCY5-33-23Z	13.0460-5944.2	605944
DCY9-33-23Z	13.0460-5944.2	605944
DF71-26-610	24.3219-1752.3	020505
E0Y8-26-43ZA	13.0460-5972.2	605972
G211-33-28Z	13.0460-5932.2	605932
G311-26-251A	24.0110-0256.1	410256
G5Y6-26-43ZA	13.0460-5973.2	605973
G5Y6-33-23Z	13.0460-5954.2	605954
GA2Y-33-25X	24.0124-0129.1	424129
GA3Y-26-251	24.0110-0234.1	410234
GA4Y-26-251	24.0110-0234.1	410234
GA4Y-33-25X	24.0124-0129.1	424129
GA4Y-33-25XC	24.0124-0129.1	424129
GA4Y-33-25XD	24.0124-0129.1	424129
GA4Y-33-25XH	24.0124-0129.1	424129
GA4Y-33-25XJ	24.0124-0129.1	424129
GA5R-33-61X	24.3571-1704.5	240100
GA5R-33-61XA	24.3571-1704.5	240100
GA5R-33-71X	24.3571-1703.5	240099
GA5R-33-71XA	24.3571-1703.5	240099
GA5R-33-980	24.3571-1704.5	240100
GA5R-33-980A	24.3571-1704.5	240100
GA5R-33-980B	24.3571-1704.5	240100
GA5R-33-980C	24.3571-1704.5	240100
GA5R-33-990	24.3571-1703.5	240099
GA5R-33-990A	24.3571-1703.5	240099
GA5R-33-990B	24.3571-1703.5	240099
GA5R-33-990C	24.3571-1703.5	240099
GA5R-44-150B	24.3727-1812.2	581812
GA5R-44-150C	24.3727-1812.2	581812
GA5R-44-410A	24.3727-1808.2	581808
GA5R-44-420B	24.3727-1809.2	581809
GA5Y-26-251	24.0110-0234.1	410234
GA5Y-26-251A	24.0110-0234.1	410234
GA5Y-26-251C	24.0110-0234.1	410234
GA5Y-26-251D	24.0110-0234.1	410234
GA5Y-33-25X	24.0124-0129.1	424129
GA5Y-33-25XA	24.0124-0129.1	424129
GA5Y-33-25XB	24.0124-0129.1	424129
GA5Y-33-25XC	24.0124-0129.1	424129
GA5Y-33-25XD	24.0124-0129.1	424129
GAY7-26-251	24.0110-0234.1	410234
GAY8-26-251	24.0110-0234.1	410234
GAYE-26-43Z	13.0460-5973.2	605973
GAYE-26-43ZA	13.0460-5973.2	605973
GAYE-26-43ZB	13.0460-5973.2	605973
GAYR-33-23ZA	13.0460-5954.2	605954
GAZR-33-98Z	24.3571-1704.5	240100
GAZR-33-98ZA	24.3571-1704.5	240100
GAZR-33-99Z	24.3571-1703.5	240099
GAZR-33-99ZA	24.3571-1703.5	240099
GBYH-33-23Z	13.0460-5954.2	605954
GCYD-33-23Z	13.0460-5954.2	605954
GEYC-33-23Z	13.0460-5954.2	605954
GEYT-33-23Z	13.0460-5954.2	605954
GEYV-33-23Z	13.0460-5954.2	605954
GJ21-26-251	24.0222-8028.1	480143
GJ21-26-251A	24.0222-8028.1	480143
GJ21-26-251B	24.0222-8028.1	480143
GJ21-26-38Z	03.0137-0185.2	650185
GJ21-26-38ZA	03.0137-0185.2	650185
GJ21-26-610C	24.3217-1120.3	020360
GJ21-26-610D	24.3217-1120.3	020360
GJ21-33-28ZB	13.0460-5932.2	605932
GJ21-44-150	24.3727-1812.2	581812
GJ25-26-251	24.0110-0181.1	410181
GJ25-26-251A	24.0110-0181.1	410181
GJ25-26-251B	24.0110-0181.1	410181
GJ25-33-25XD	24.0124-0105.1	424105
GJ25-33-29Z	13.0460-0313.2	610313
GJ55-33-25XA	24.0124-0105.1	424105

Vergleichsliste

Cross reference list - Tabella di conversione codici

Liste des correspondances - Lista referencias



MAZDA		 MERCEDES BENZ		 MERCEDES BENZ		 MERCEDES BENZ		
GJ55-33-25XB	24.0124-0105.1	424105	000 420 15 01	13.9441-0042.2	210280	000 421 25 98	13.2571-9999.2	210134
GJ55-33-25XC	24.0124-0105.1	424105	000 420 15 44	13.0441-5724.2	250125	000 421 28 91	13.0460-0158.2	610158
GJ83-26-38Z	03.0137-0185.2	650185	000 420 17 55	03.3518-6100.2	390364	000 421 29 91	13.0460-0158.2	610158
GJ83-26-38ZA	03.0137-0185.2	650185	000 420 20 51	03.0401-2031.2	052031	000 421 30 88	13.0460-0158.2	610158
GJ87-26-48ZA	13.0460-5995.2	605995	000 420 24 44	13.0441-6012.2	250133	000 421 30 91	13.0460-0171.2	610171
GJY1-33-28Z	13.0460-5932.2	605932	000 420 25 44	13.0441-5721.2	250123	000 421 32 91	13.0460-0214.2	610214
GM09-26-251B	24.0110-0256.1	410256	000 420 29 55	03.3518-8000.2	390373	000 421 33 91	13.0460-0186.2	610186
GN51-33-23Z	13.0460-5932.2	605932	000 420 46 83	13.2423-8009.2	210063	000 421 34 88	13.0460-0160.2	610160
GN51-33-28Z	13.0460-5932.2	605932	000 420 47 83	13.2423-8010.2	210064	000 421 36 91	13.0460-0197.2	610197
GTYF-26-251C	24.0110-0234.1	410234	000 420 50 83	24.3541-1631.5	240413	000 421 39 91	13.0460-0219.2	610219
GW55-26-251	24.0110-0181.1	410181	000 420 51 83	24.3541-1632.5	240414	000 421 39 98	13.2571-9998.2	210133
H266-26-48Z	13.0460-5625.2	605625	000 420 52 83	24.3541-1631.5	240413	000 421 40 91	13.0460-0215.2	610215
H266-26-48ZA	13.0460-5625.2	605625	000 420 53 83	24.3541-1632.5	240414	000 421 40 98	13.2571-9999.2	210134
HF39-26-48Z	13.0460-5625.2	605625	000 420 55 83	24.3541-1603.5	240037	000 421 41 91	13.0460-0160.2	610160
HF39-26-48ZA	13.0460-5625.2	605625	000 420 56 83	24.3541-1604.5	240038	000 421 41 98	13.2571-9998.2	210133
NA01-26-251A	24.0109-0127.1	409127	000 420 57 20	13.0460-3804.2	603804	000 421 42 98	13.2571-9999.2	210134
NA01-33-25X	24.0118-0113.1	418113	000 420 57 20	13.0460-4036.2	604036	000 421 43 98	13.2571-9998.2	210133
NA01-33-25XA	24.0118-0113.1	418113	000 420 57 83	24.3541-1725.5	240003	000 421 44 98	13.2571-9999.2	210134
NA01-33-25XC	24.0118-0113.1	418113	000 420 58 20	13.0460-3804.2	603804	000 421 46 86	11.0101-5403.2	260010
NAY0-26-43Z	13.0460-5972.2	605972	000 420 58 20	13.0460-4036.2	604036	000 421 47 91	13.0460-0158.2	610158
S083-49-280	13.0460-5806.2	605806	000 420 58 83	24.3541-1726.5	240004	000 421 52 91	13.0460-0239.2	610239
S083-49-280A	13.0460-5806.2	605806	000 420 59 20	13.0460-9029.2	609029	000 421 59 98	13.2571-9998.2	210133
S231-49-280	13.0460-5806.2	605806	000 420 59 83	24.3541-1725.5	240003	000 421 60 98	13.2571-9999.2	210134
S231-49-280A	13.0460-5806.2	605806	000 420 60 20	13.0460-9029.2	609029	000 421 64 91	13.0460-0236.2	610236
SE28-26-38Z	03.0137-0486.2	650486	000 420 60 83	24.3541-1726.5	240004	000 421 64 91 64	13.0460-0236.2	610236
SE28-26-38ZA	03.0137-0486.2	650486	000 420 62 20	13.0460-3804.2	603804	000 421 71 86	13.0441-4214.2	250091
SE96-33-28Z	13.0460-5806.2	605806	000 420 63 20	13.0460-9028.2	609028	000 421 71 98	13.2571-9998.2	210133
SF04-33-28Z	13.0460-5806.2	605806	000 420 64 20	13.0460-9028.2	609028	000 421 72 86	13.0441-3817.2	250071
TAY2-26-43Z	13.0460-5625.2	605625	000 420 65 20	13.0460-9028.2	609028	000 421 72 98	13.2571-9999.2	210134
TBY7-26-43Z	13.0460-5625.2	605625	000 420 66 20	13.0460-6027.2	606027	000 421 73 98	13.2571-9998.2	210133
			000 420 67 18	03.3228-0502.3	020109	000 421 74 98	13.2571-9999.2	210134
			000 420 67 20	13.0460-6027.2	606027	000 421 77 86	13.0441-3606.2	250147
			000 420 68 20	13.0460-9028.2	609028	000 421 78 86	13.0441-4216.2	250093
			000 420 71 20	13.0460-4036.2	604036	000 421 79 86	13.0441-4601.2	250099
			000 420 71 83	13.0441-4018.2	250083	000 423 00 75	13.0471-5405.2	250136
			000 420 74 20	13.0460-6031.2	606031	000 423 04 19	13.0471-5408.2	250138
			000 420 75 20	13.0460-6031.2	606031	000 423 11 42	13.8158-0020.1	990113
			000 420 76 20	13.0460-3804.2	603804	000 423 12 42	13.8158-0021.1	990114
			000 420 76 20	13.0460-4036.2	604036	000 423 13 71	13.0471-5407.2	250137
			000 420 79 83	24.9442-8003.5	230053	000 423 23 98	13.2381-8027.2	210033
			000 420 80 83	24.9442-8004.5	230054	000 423 24 98	13.2381-8028.2	210034
			000 420 82 83	24.9238-8033.5	230015	000 423 25 98	13.2381-8027.2	210033
			000 420 83 83	13.2381-8034.2	210223	000 423 26 98	13.2381-8028.2	210034
			000 420 83 83	24.9238-8034.5	230016	000 423 31 98	13.2381-8027.2	210033
			000 420 84 18	03.3222-0902.3	020068	000 423 32 98	13.2381-8028.2	210034
			000 420 87 83	24.9246-8001.5	230021	000 423 33 98	13.2381-8027.2	210033
			000 420 88 20	13.0460-4030.2	604030	000 423 34 98	13.2381-8028.2	210034
			000 420 88 83	24.9246-8002.5	230022	000 423 47 98	13.2381-8027.2	210033
			000 420 89 20	13.0460-2923.2	602923	000 423 48 98	13.2381-8028.2	210034
			000 420 90 20	13.0460-4030.2	604030	000 423 58 98	13.2381-8027.2	210033
			000 420 90 83	24.9571-7005.5	230061	000 423 59 98	13.2381-8028.2	210034
			000 420 91 20	13.0460-2923.2	602923	000 423 60 98	13.2381-8029.2	210035
			000 420 91 83	24.9571-7006.5	230062	000 423 61 98	13.2381-8030.2	210036
			000 420 92 83	13.2401-8013.2	210051	000 423 63 98	13.2381-8027.2	210033
			000 420 92 83	24.9240-8013.5	230019	000 423 64 98	13.2381-8028.2	210034
			000 420 93 83	13.2401-8014.2	210052	000 423 70 98	13.2381-8027.2	210033
			000 420 93 83	24.9240-8014.5	230020	000 423 71 98	13.2381-8028.2	210034
			000 420 94 20	13.0460-9029.2	609029	000 423 72 98	13.2381-8027.2	210033
			000 420 95 20	13.0460-9029.2	609029	000 423 73 98	13.2381-8028.2	210034
			000 420 95 83	13.0441-4020.2	250084	000 423 82 98	13.2381-8029.2	210035
			000 420 97 20	13.0460-3990.2	603990	000 423 83 98	13.2381-8030.2	210036
			000 420 98 20	13.0460-4034.2	604034	000 423 89 98	13.2421-8021.2	210057
			000 420 99 20	13.0460-2927.2	602927	000 423 89 98	24.9242-8021.5	230031
			000 420 99 20	13.0470-2927.2	LD2927	000 423 90 98	24.9242-8022.5	230032
			000 420 99 83	13.0441-5721.2	250123	000 423 91 98	13.2381-8027.2	210033
			000 421 02 91	13.0460-0026.2	610026	000 423 92 98	13.2381-8028.2	210034
			000 421 08 18	11.8171-0008.1	990049	000 423 95 98	13.2353-8003.2	210016
			000 421 14 20	13.0460-0214.2	610214	000 423 96 98	13.2353-8004.2	210017
			000 421 23 91	13.0460-0131.2	610131	000 426 63 98	13.2381-8027.2	210033
			000 421 24 91	13.0460-0132.2	610132	000 428 00 32	03.3517-0300.1	390323
			000 421 24 98	13.2571-9998.2	210133	000 428 01 35	83.6103-0450.3	330228



Vergleichsliste

Cross reference list - Tabella di conversione codici



Liste des correspondances - Lista referencias

MERCEDES BENZ 			MERCEDES BENZ 			MERCEDES BENZ 		
000 428 02 35	83.6103-0500.3	330230	000 586 25 42	13.0460-3804.2	603804	001 420 02 20	13.0470-3805.2	LD3805
000 428 07 35	83.6123-0381.3	330262	000 586 25 42	13.0460-4036.2	604036	001 420 03 20	13.0460-4037.2	604037
000 428 08 35	83.6103-0240.3	330220	000 586 27 88	03.0402-1128.2	060027	001 420 04 18	03.3223-0102.3	020090
000 428 14 35	83.6103-0650.3	330235	000 586 28 88	03.0402-1128.2	060027	001 420 05 20	13.0460-9029.2	609029
000 428 16 35	83.6103-0450.3	330228	000 586 29 42	13.0460-6027.2	606027	001 420 06 20	13.0460-3804.2	603804
000 428 26 35	83.6204-0240.3	330718	000 586 31 29	03.0450-3801.2	083801	001 420 06 20	13.0460-4036.2	604036
000 428 28 35	24.5170-0426.3	331452	000 586 33 29	03.0450-2509.2	082509	001 420 06 83	13.2421-8025.2	210061
000 428 29 35	83.7704-0320.3	330851	000 586 37 42	13.0460-6027.2	606027	001 420 07 20	13.0460-2927.2	602927
000 428 30 35	83.6104-0210.3	330473	000 586 38 29	03.0450-2805.2	082805	001 420 07 20	13.0470-2927.2	LD2927
000 428 31 35	83.6204-0220.3	330308	000 586 39 29	03.0450-2311.2	082311	001 420 07 83	13.2421-8026.2	210062
000 428 35 35	83.7704-0281.3	330804	000 586 41 42	13.0460-4036.2	604036	001 420 08 20	13.0460-4037.2	604037
000 428 36 35	83.6192-0250.3	330726	000 586 46 29	03.0450-2510.2	082510	001 420 09 20	13.0460-6031.2	606031
000 428 38 35	83.6203-0250.3	330299	000 586 48 43	03.0370-1038.2	051038	001 420 10 20	13.0460-2923.2	602923
000 428 39 35	83.6203-0260.3	330300	000 586 48 43	03.0370-9998.2	059998	001 420 13 20	13.0460-3805.2	603805
000 428 40 35	83.6103-0320.3	330224	000 586 53 43	13.0441-3504.2	250050	001 420 13 20	13.0470-3805.2	LD3805
000 428 42 35	83.6103-0400.3	330226	000 586 64 42	13.0441-5718.2	250120	001 420 13 83	11.0101-5403.2	260010
000 428 43 35	83.6103-0600.3	330233	000 586 72 42	13.0460-6027.2	606027	001 420 14 20	13.0460-4401.2	604401
000 428 44 35	83.6103-0190.3	330218	000 586 74 42	13.0441-6001.2	250126	001 420 15 20	13.0460-6015.2	606015
000 428 45 35	83.6203-0200.3	330298	000 586 75 42	13.0460-9028.2	609028	001 420 18 83	24.3541-1603.5	240037
000 428 47 35	83.6103-0550.3	330231	000 586 76 42	13.0460-3804.2	603804	001 420 19 83	24.3541-1604.5	240038
000 428 48 35	83.6123-0381.3	330262	000 586 76 42	13.0460-4036.2	604036	001 420 23 83	11.0441-6007.2	250146
000 428 58 35	83.6204-0350.3	330382	000 586 91 42	03.0402-1128.2	060027	001 420 33 18	03.2728-2101.3	020008
000 428 67 35	83.6104-0440.3	330714	000 991 03 60	13.0460-0026.2	610026	001 420 34 18	03.2728-2201.3	020009
000 428 70 35	83.6203-0300.3	330386	000 991 20 60	13.0460-0214.2	610214	001 420 37 83	13.2421-8025.2	210061
000 428 71 35	24.5201-0220.3	331272	000 991 32 60	13.0460-0158.2	610158	001 420 38 83	13.2421-8026.2	210062
000 428 76 35	83.6133-0500.3	330272	000 991 39 60	13.0460-0131.2	610131	001 420 39 83	24.9246-8001.5	230021
000 428 79 35	83.6104-0241.3	330731	000 991 40 60	13.0460-0132.2	610132	001 420 40 83	24.9246-8002.5	230022
000 428 80 35	24.5170-0426.3	331452	000 991 73 60	13.0460-0197.2	610197	001 420 75 20	13.0460-9029.2	609029
000 428 82 35	83.6133-0551.3	330273	000 991 97 60	13.0460-0171.2	610171	001 420 76 20	13.0460-4037.2	604037
000 428 89 35	83.6133-0651.3	330274	000 991 97 60	13.0460-0186.2	610186	001 420 77 20	13.0460-6027.2	606027
000 428 91 35	83.6133-0551.3	330273	000 991 97 60	13.0460-0215.2	610215	001 420 78 20	13.0460-9028.2	609028
000 428 93 35	83.6104-0220.3	330474	000 991 98 60	13.0460-0219.2	610219	001 420 79 20	13.0460-4036.2	604036
000 430 00 81	03.3318-0800.2	390112	000 997 08 86	03.3304-0700.1	390082	001 420 81 20	13.0460-2923.2	602923
000 430 03 81	03.3318-0800.2	390112	000 997 50 30	03.3517-0101.2	390322	001 420 85 20	13.0460-4037.2	604037
000 430 47 02	03.3508-0264.3	310009	000 997 78 30	03.3517-0101.2	390322	001 420 92 20	13.0460-6031.2	606031
000 430 64 01	03.3125-0401.3	010290	001 295 02 06	24.2419-0942.3	030068	001 420 93 20	13.0460-3804.2	603804
000 430 72 01	03.3126-0505.3	010294	001 295 03 07	03.2538-0104.3	040035	001 420 93 20	13.0460-4036.2	604036
000 430 92 30	03.6850-0202.4	300043	001 295 11 06	24.2419-0917.3	030047	001 420 94 20	13.0460-4201.2	604201
000 430 95 30	03.6855-1202.4	300056	001 295 13 07	24.2523-1210.3	040105	001 420 95 20	13.0460-3805.2	603805
000 431 12 02	03.3508-3600.3	310030	001 295 14 06	24.2419-0901.3	030041	001 420 95 20	13.0470-3805.2	LD3805
000 431 13 02	03.3509-0100.3	310057	001 295 14 07	24.2523-1210.3	040105	001 420 96 20	13.0460-2923.2	602923
000 431 15 02	03.3508-0501.3	310017	001 295 15 06	24.2419-0937.3	030063	001 420 98 20	13.0460-4201.2	604201
000 431 16 02	03.3508-0401.3	310014	001 295 17 06	24.2419-0917.3	030047	001 420 99 20	13.0460-9029.2	609029
000 431 21 02	03.3508-0801.3	310023	001 295 24 06	24.2419-0932.3	030058	001 421 02 98	13.2571-9998.2	210133
000 431 24 02	03.3509-0600.3	310065	001 295 27 07	24.2523-1210.3	040105	001 421 03 98	13.2571-9999.2	210134
000 431 36 07	24.7718-7301.2	990024	001 295 29 06	03.2423-0603.3	030036	001 421 29 98	13.2571-8013.2	210123
000 431 47 02	03.3508-0264.3	310009	001 295 29 07	24.2523-1210.3	040105	001 421 30 98	13.2571-8014.2	210124
000 431 53 02	03.3508-4903.3	310032	001 295 30 06	24.2426-0902.3	030073	001 421 36 98	24.9260-8025.5	230041
000 431 64 02	03.3508-8753.3	310049	001 295 30 07	24.2523-1210.3	040105	001 421 37 98	24.9260-8026.5	230042
000 431 69 02	03.3508-0264.3	310009	001 295 38 06	24.2419-0942.3	030068	001 421 47 98	13.2571-9998.2	210133
000 431 70 12	03.6521-0012.3	320094	001 295 40 06	24.2419-0921.3	030050	001 421 48 98	13.2571-9999.2	210134
000 431 89 02	03.3508-8753.3	310049	001 295 43 06	24.2419-0942.3	030068	001 421 51 98	13.2571-8013.2	210123
000 540 02 17	24.8190-0401.2	620401	001 295 44 06	24.2419-0935.3	030061	001 421 52 98	13.2571-8014.2	210124
000 545 01 09	03.3526-2002.3	340010	001 295 44 06	24.2419-0936.3	030062	001 421 73 98	13.2571-9998.2	210133
000 545 05 09	24.3526-0100.3	340017	001 295 51 06	24.2419-0934.3	030060	001 421 74 98	13.2571-9999.2	210134
000 545 13 09	24.3526-0100.3	340017	001 295 52 06	24.2419-0932.3	030058	001 421 77 98	24.9260-8025.5	230041
000 545 17 09	24.3526-0100.3	340017	001 295 53 07	03.2538-0104.3	040035	001 421 78 98	24.9260-8026.5	230042
000 545 22 09	24.3526-0100.3	340017	001 295 54 07	24.2528-0907.3	040054	001 421 79 98	13.2601-9996.2	210176
000 545 34 09	24.3526-0100.3	340017	001 295 60 06	03.2423-0603.3	030036	001 421 80 98	13.2601-9997.2	210177
000 545 42 09	24.3526-0100.3	340017	001 295 61 07	24.2523-1210.3	040105	001 421 81 98	13.2571-9998.2	210133
000 545 43 09	24.3526-0810.3	340037	001 295 68 06	24.2419-0915.3	030045	001 421 82 98	13.2571-9999.2	210134
000 545 51 09	24.3526-0810.3	340037	001 295 68 07	03.2523-0811.3	040019	001 421 86 98	24.9260-8025.5	230041
000 545 55 09	24.3526-1900.0	340038	001 295 76 06	24.2419-0917.3	030047	001 421 87 98	24.9260-8026.5	230042
000 545 61 09	24.3526-0100.3	340017	001 295 79 06	24.2419-0917.3	030047	001 421 98 98	13.4571-8005.3	210205
000 586 01 43	03.0101-3501.2	390001	001 295 80 06	24.2419-0942.3	030068	001 421 99 98	13.4571-8006.3	210206
000 586 06 42	13.0460-6027.2	606027	001 295 86 06	24.2419-0917.3	030047	001 423 46 98	24.9235-8005.5	230023
000 586 11 43	03.0370-1131.2	051131	001 295 87 06	24.2419-0937.3	030063	001 423 47 98	24.9235-8006.5	230024
000 586 13 43	13.0441-5718.2	250120	001 295 88 07	03.2538-0104.3	040035	001 428 02 35	83.6103-0300.3	330223
000 586 15 43	13.0441-4206.2	250087	001 295 96 07	24.2528-0907.3	040054	001 428 03 35	83.6104-0470.3	330253
000 586 21 29	03.0450-2311.2	082311	001 420 01 20	13.0460-4030.2	604030	001 428 04 35	24.5201-0220.3	331272
000 586 22 42	13.0460-4036.2							

Vergleichsliste

Cross reference list - Tabella di conversione codici



Liste des correspondances - Lista referencias

MERCEDES BENZ 			MERCEDES BENZ 			MERCEDES BENZ 		
001 428 09 35	83.6203-0250.3	330299	002 420 37 20	13.0460-4202.2	604202	003 420 30 20	13.0460-4047.2	604047
001 428 14 35	83.6204-0280.3	330732	002 420 46 20	13.0460-4047.2	604047	003 420 30 20	13.0470-4047.2	LD4047
001 428 17 35	24.5201-0220.3	331272	002 420 46 20	13.0470-4047.2	LD4047	003 420 33 83	13.2601-8036.2	210168
001 428 18 35	83.6103-0200.3	330219	002 420 49 18	03.3219-3401.3	020049	003 420 34 20	03.0137-4001.2	654001
001 428 21 35	83.6123-0465.3	330379	002 420 57 20	13.0460-6015.2	606015	003 420 34 83	13.2601-8037.2	210169
001 428 36 35	83.6103-0450.3	330228	002 420 58 20	03.0137-4001.2	654001	003 420 35 83	13.2601-8038.2	210170
001 428 48 35	83.6133-0651.3	330274	002 420 81 18	03.3241-1801.3	020130	003 420 36 20	13.0460-6031.2	606031
001 428 53 35	83.6123-0465.3	330379	002 420 88 18	03.3222-5804.3	020083	003 420 44 20	13.0460-6015.2	606015
001 428 54 35	83.6123-0465.3	330379	002 421 00 98	13.9574-7005.2	210275	003 420 48 20	13.0460-4047.2	604047
001 428 55 35	83.6133-0500.3	330272	002 421 01 98	13.9574-7006.2	210276	003 420 48 20	13.0470-4047.2	LD4047
001 428 87 35	83.6203-0250.3	330299	002 421 05 98	24.9260-8029.5	230043	003 420 49 20	13.0460-4047.2	604047
001 428 88 35	83.6104-0360.3	330475	002 421 06 98	24.9260-8030.5	230044	003 420 49 20	13.0470-4047.2	LD4047
001 428 94 35	24.5170-0426.3	331452	002 421 18 98	24.9260-8025.5	230041	003 420 74 20	13.0460-6031.2	606031
001 428 95 35	24.5201-0474.3	331434	002 421 19 98	24.9260-8026.5	230042	003 420 77 20	13.0460-6015.2	606015
001 430 36 30	03.6850-0202.4	300043	002 421 23 98	24.9260-8025.5	230041	003 420 77 20 10	13.0460-6015.2	606015
001 430 43 60	13.0441-6010.2	250132	002 421 24 98	24.9260-8026.5	230042	003 421 00 98	24.9260-8029.5	230043
001 430 48 01	03.3131-0601.3	010299	002 421 28 98	13.2601-8027.2	210159	003 421 01 98	24.9260-8030.5	230044
001 430 52 01	03.2123-0609.3	010171	002 421 29 98	13.2601-8028.2	210160	003 421 06 98	24.9260-8029.5	230043
001 430 63 01	03.2123-0609.3	010171	002 421 30 98	24.9260-8029.5	230043	003 421 07 98	24.9260-8030.5	230044
001 430 64 01	03.2123-0614.3	010172	002 421 31 98	24.9260-8030.5	230044	003 421 10 98	24.9260-8031.5	230045
001 430 66 30	03.6850-0202.4	300043	002 421 38 98	13.4441-8015.2	210263	003 421 11 98	24.9260-8032.5	230046
001 430 79 01	03.3138-2001.3	010310	002 421 39 98	13.4441-8016.2	210264	003 421 24 98	13.2601-8034.2	210166
001 430 81 01	03.2320-0201.3	010234	002 421 40 98	13.4441-8013.2	210261	003 421 25 98	13.2601-8033.2	210165
001 430 84 30	03.6855-1202.4	300056	002 421 41 98	13.4441-8014.2	210262	003 421 39 98	13.4441-8013.2	210261
001 430 89 01	03.2123-0614.3	010172	002 421 54 98	13.2571-8011.2	210121	003 421 40 98	13.4441-8014.2	210262
001 431 05 02	03.3508-0503.3	310018	002 421 55 98	13.2571-8012.2	210122	003 421 41 98	13.4441-8015.2	210263
001 431 06 02	03.3508-8753.3	310049	002 421 56 98	13.2571-8013.2	210123	003 421 42 98	13.4441-8016.2	210264
001 431 07 02	03.3508-8753.3	310049	002 421 57 98	13.2571-8014.2	210124	003 421 43 98	13.4441-8015.2	210263
001 431 08 12	03.6511-0030.3	320076	002 423 11 98	13.9544-0022.2	210258	003 421 44 98	13.4441-8016.2	210264
001 431 09 12	03.6511-0030.3	320076	002 423 12 98	13.9544-0021.2	210257	003 421 45 98	13.4441-8013.2	210261
001 431 39 12	03.6513-0340.3	320084	002 423 94 98	13.2421-8025.2	210061	003 421 46 98	13.4441-8014.2	210262
001 431 42 02	03.3508-8753.3	310049	002 423 95 98	13.2421-8026.2	210062	003 421 47 98	13.4441-8013.2	210261
001 431 45 02	03.3508-8753.3	310049	002 428 05 35	83.6133-0500.3	330272	003 421 48 98	13.4441-8014.2	210262
001 431 69 12	03.6515-0305.3	320087	002 428 20 35	83.6203-0250.3	330299	003 421 49 98	13.4441-8015.2	210263
001 586 18 42	13.0460-9028.2	609028	002 428 57 35	24.5201-0220.3	331272	003 421 50 98	13.4441-8016.2	210264
001 586 19 42	13.0460-6027.2	606027	002 428 58 35	83.6203-0250.3	330299	003 430 04 01	03.2122-4902.3	010144
001 586 31 42	13.0460-6027.2	606027	002 430 02 30	03.6850-2602.4	300049	003 430 06 01	03.2125-1302.3	010203
001 586 32 42	13.0460-9028.2	609028	002 430 14 01	03.3134-0300.3	010308	003 430 06 30	03.6855-1902.4	300059
001 586 33 42	13.0460-9028.2	609028	002 430 21 01	03.3138-2001.3	010310	003 430 07 01	03.2125-1102.3	010202
001 586 36 42	13.0460-9028.2	609028	002 430 22 01	03.3134-0300.3	010308	003 430 15 30	03.7760-2702.4	300090
001 586 37 42	03.0403-0341.2	060031	002 430 28 01	03.2123-1003.3	010175	003 430 22 01	03.2123-1003.3	010175
001 586 48 42	13.0441-5417.2	250118	002 430 36 01	03.3138-2001.3	010310	003 430 24 30	03.7760-2702.4	300090
001 586 53 42	13.0441-5721.2	250123	002 430 41 01	03.3134-0300.3	010308	003 430 34 30	03.6855-2202.4	300061
001 586 54 42	13.0441-5721.2	250123	002 430 44 30	03.6855-1202.4	300056	003 430 60 01	03.2023-0166.3	010015
001 586 64 42	13.0460-3804.2	603804	002 430 68 30	03.6855-1202.4	300056	003 430 78 01	03.2023-0166.3	010015
001 586 70 42	13.0460-4401.2	604401	002 430 84 01	03.3138-2001.3	010310	003 430 79 01	03.2123-6002.3	010184
001 586 73 43	13.0441-3811.2	250067	002 430 85 01	03.3134-0300.3	010308	003 430 82 01	03.2123-6002.3	010184
001 586 89 42	13.0460-4401.2	604401	002 430 86 01	03.2125-1102.3	010202	003 430 98 01	24.2123-0901.3	010382
001 991 16 60	13.0460-0239.2	610239	002 430 91 01	03.3138-2001.3	010310	003 430 99 01	03.2023-0166.3	010015
001 991 27 60	13.0460-0236.2	610236	002 430 92 01	03.3134-0300.3	010308	003 542 47 17	24.3526-1900.0	340038
001 991 27 60 64	13.0460-0236.2	610236	002 430 93 01	03.2123-3402.3	010181	004 420 14 20	13.0460-4401.2	604401
001 997 55 30	03.3517-5100.1	390326	002 430 99 30	03.6855-1402.4	300057	004 420 16 20	13.0460-4047.2	604047
002 295 04 07	03.2538-0104.3	040035	002 431 13 12	03.6513-0340.3	320084	004 420 16 20	13.0470-4047.2	LD4047
002 295 13 07	03.2523-0812.3	040020	002 586 17 42	13.0441-6010.2	250132	004 420 37 18	24.3223-1705.3	020418
002 420 00 20	13.0460-3504.2	603504	002 586 20 42	13.0460-6031.2	606031	004 420 41 83	13.2601-0145.2	210247
002 420 01 20	13.0460-3504.2	603504	002 586 41 42	13.0460-6031.2	606031	004 420 42 83	13.2601-0146.2	210248
002 420 02 20	13.0460-2923.2	602923	002 586 44 42	13.0441-6003.2	250128	004 420 43 83	13.2544-0019.2	210251
002 420 03 20	13.0460-6036.2	606036	002 586 45 42	13.0460-9029.2	609029	004 420 44 83	13.9571-0003.2	210277
002 420 04 20	13.0460-9033.2	609033	002 586 46 42	13.0460-9029.2	609029	004 420 45 83	13.9574-7005.2	210275
002 420 05 20	13.0460-4047.2	604047	002 586 47 42	13.0460-3804.2	603804	004 420 48 83	13.2544-0020.2	210252
002 420 05 20	13.0470-4047.2	LD4047	002 586 47 42	13.0460-4036.2	604036	004 420 49 83	13.9571-0004.2	210278
002 420 08 18	03.3220-0905.3	020059	002 586 48 42	13.0460-3804.2	603804	004 420 50 83	13.9574-7006.2	210276
002 420 12 20	13.0460-9033.2	609033	002 586 48 42	13.0460-4036.2	604036	004 420 62 18	03.3222-5804.3	020083
002 420 15 20	13.0460-4201.2	604201	002 586 53 42	13.0441-4408.2	250096	004 420 81 83	13.9441-0041.2	210279
002 420 16 20	13.0460-4047.2	604047	003 420 03 18	03.3220-0905.3	020059	004 420 82 83	13.9441-0042.2	210280
002 420 16 20	13.0470-4047.2	LD4047	003 420 04 18	03.3222-4007.3	020074	004 421 78 98	13.4441-8013.2	210261
002 420 18 20	13.0460-9033.2	609033	003 420 07 20	13.0460-4401.2	604401	004 421 79 98	13.4441-8014.2	210262
002 420 19 20	13.0460-4202.2	604202	003 420 14 20	03.0137-4001.2	654001	004 421 82 98	13.4441-8015.2	210263
002 420 23 20	13.0460-2927.2	602927	003 420 15 20	13.0460-6015.2	606015	004 421 83 98	13.4441-8016.2	210264
002 420 23 20	13.0470-2927.2	LD2927	003 420 20 83	13.2601-8035.2	210167	004 430 08 30	03.7760-2702.4	300090
002 420 26 20	13.0460-9033.2	609033	003 420 24 20	13.0460-3990.2	603990	004 430 09 01	03.2023-0166.3	010015

Vergleichsliste

Cross reference list - Tabella di conversione codici

Liste des correspondances - Lista referencias



MERCEDES BENZ 			MERCEDES BENZ 			MERCEDES BENZ 		
004 430 12 01	24.2123-0901.3	010382	011 420 01 18	24.3222-1732.3	020537	124 421 05 71	13.8190-0330.1	990134
004 430 17 01	24.2022-1601.3	010340	011 420 16 18	24.3244-0904.3	020301	124 421 13 12	24.0112-0117.1	412117
004 430 22 01	03.2126-0512.3	010217	011 420 88 18	24.3217-1109.3	020173	124 421 14 12	24.0122-0134.1	422134
004 430 23 01	03.2023-0166.3	010015	107 420 00 83	13.2601-8034.2	210166	124 421 15 12	24.0122-0136.1	422136
004 430 24 01	24.2022-1601.3	010340	107 420 01 83	13.2601-8033.2	210165	124 421 16 12	24.0122-0123.1	422123
004 430 25 01	03.2023-0166.3	010015	107 420 02 83	13.2601-8027.2	210159	124 421 23 12	24.0122-0134.1	422134
004 430 26 01	03.2025-0111.3	010033	107 420 03 83	13.2601-8028.2	210160	124 421 24 12	24.0125-0107.1	425107
004 430 28 01	03.2125-1902.3	010206	107 420 04 83	24.9440-8027.5	230051	124 421 26 12	24.0128-0103.1	428103
004 430 29 01	03.2125-2102.3	010207	107 420 05 83	24.9440-8028.5	230052	124 421 27 12	24.0122-0123.1	422123
004 430 30 01	03.2123-6002.3	010184	108 423 02 12	24.0110-0185.1	410185	124 423 05 12	24.0109-0114.1	409114
004 430 31 30	03.7760-2702.4	300090	110 420 00 72	24.0113-0111.1	413111	124 423 05 12	24.0309-0114.1	509114
004 430 33 01	03.2023-0230.3	010019	110 421 01 12	24.0113-0111.1	413111	124 423 06 12	24.0120-0199.1	420199
004 430 34 01	03.2023-0825.3	010028	114 421 00 12	24.0113-0137.1	413137	124 423 08 12	24.0124-0188.1	424188
004 430 35 30	03.7760-2702.4	300090	115 290 01 15	03.3508-1706.3	310024	124 423 10 12	24.0120-0199.1	420199
004 430 38 01	03.2025-0211.3	010034	115 420 00 72	24.0110-0185.1	410185	126 420 00 05	24.0122-0116.1	422116
004 430 39 01	03.2023-0825.3	010028	115 420 01 72	24.0113-0112.1	413112	126 420 00 83	24.9260-8031.5	230045
004 430 48 01	24.2133-0901.3	010387	115 420 02 72	24.0113-0113.1	413113	126 420 01 20	03.0137-0171.2	650171
004 430 50 01	03.2130-0102.3	010221	115 420 16 85	24.3727-0406.2	580406	126 420 01 72	24.0122-0116.1	422116
004 430 53 01	03.2130-0102.3	010221	115 420 20 85	24.3727-0407.2	580407	126 420 01 83	24.9260-8032.5	230046
004 430 55 01	03.2025-0211.3	010034	115 420 26 85	24.3727-0407.2	580407	126 420 04 83	13.2381-8029.2	210035
004 430 75 01	03.2025-0211.3	010034	115 420 27 85	24.3727-0407.2	580407	126 420 05 83	13.2381-8030.2	210036
005 420 17 20	13.0460-3805.2	603805	115 421 11 12	24.0113-0112.1	413112	126 420 06 83	13.2571-8023.2	210127
005 420 17 20	13.0470-3805.2	LD3805	115 421 13 12	24.0113-0113.1	413113	126 420 07 83	13.2571-8024.2	210128
005 420 78 18	03.3222-7802.3	020088	115 421 14 12	24.0113-0137.1	413137	126 420 16 85	24.3727-0416.2	580416
005 420 79 18	24.3223-1705.3	020418	115 423 02 12	24.0110-0185.1	410185	126 420 17 85	24.3727-0417.2	580417
005 420 81 18	24.3215-0902.3	020153	115 423 04 12	24.0110-0185.1	410185	126 421 00 12	24.0122-0116.1	422116
005 420 98 20	13.0460-4401.2	604401	116 420 00 83	24.9260-8025.5	230041	126 421 04 12	24.0128-0102.1	428102
005 430 24 01	03.2023-0825.3	010028	116 420 01 72	24.0122-0106.1	422106	126 421 05 12	24.0128-0102.1	428102
005 430 26 01	03.2023-0230.3	010019	116 420 01 83	24.9260-8026.5	230042	126 423 00 12	24.0110-0185.1	410185
005 430 54 01	03.2026-0512.3	010038	116 420 02 05	24.0122-0106.1	422106	126 428 01 35	83.6204-0282.3	330309
005 430 55 01	03.2026-0462.3	010728	116 428 01 35	83.6204-0280.3	330732	126 428 03 35	83.7704-0281.3	330804
005 430 59 01	24.2022-1601.3	010340	123 420 00 72	24.0113-0137.1	413137	126 540 20 17	24.8190-0401.2	620401
005 430 69 01	03.2026-0462.3	010728	123 420 01 20	03.0137-0171.2	650171	126 997 02 32	03.3517-5100.1	390326
005 586 72 42	13.0460-6027.2	606027	123 420 01 83	24.9260-8029.5	230043	129 420 00 83	24.9442-8003.5	230053
006 420 15 18	03.2524-0400.3	040024	123 420 02 83	24.9260-8030.5	230044	129 420 01 83	24.9442-8004.5	230054
006 421 17 98	13.4441-8015.2	210263	123 420 02 85	24.3727-0403.2	580403	129 420 02 83	24.9238-8035.5	230025
006 421 18 98	13.4441-8016.2	210264	123 420 03 83	24.9260-8029.5	230043	129 420 03 83	24.9238-8036.5	230026
006 421 21 98	13.4441-8013.2	210261	123 420 04 83	24.9260-8030.5	230044	129 420 08 85	24.3727-0468.2	580468
006 421 22 98	13.4441-8014.2	210262	123 420 04 85	24.3727-0401.2	580401	129 420 09 85	24.3727-0469.2	580469
006 421 23 98	13.4441-8013.2	210261	123 420 05 83	13.2381-8027.2	210033	129 420 26 85	24.3727-0464.2	580464
006 421 24 98	13.4441-8014.2	210262	123 420 05 85	24.3727-0402.2	580402	129 420 27 85	24.3727-0464.2	580464
006 421 29 98	13.4441-8015.2	210263	123 420 06 83	13.2381-8028.2	210034	129 421 02 12	24.0122-0123.1	422123
006 421 30 98	13.4441-8016.2	210264	123 420 07 83	13.2381-8027.2	210033	129 421 03 12	24.0122-0123.1	422123
006 421 31 98	13.4441-8015.2	210263	123 420 08 83	13.2381-8028.2	210034	129 421 06 12	24.0128-0103.1	428103
006 421 32 98	13.4441-8016.2	210264	123 420 09 83	13.2381-8027.2	210033	129 421 10 12	24.0128-0103.1	428103
007 420 09 18	24.3217-1109.3	020173	123 420 10 83	13.2381-8028.2	210034	129 421 15 12	24.0130-0121.1	430121
007 420 21 18	03.2524-0400.3	040024	123 420 11 83	13.2421-8021.2	210057	129 421 16 12	24.0130-0122.1	430122
007 421 03 98	13.2601-7015.2	210230	123 420 11 83	24.9242-8021.5	230031	129 421 17 12	24.0130-0121.1	430121
007 421 04 98	13.2601-8037.2	210169	123 420 12 83	24.9242-8022.5	230032	129 421 18 12	24.0130-0122.1	430122
007 421 05 98	13.2601-7016.2	210231	123 420 14 83	13.2381-8027.2	210033	129 421 20 12	24.0128-0103.1	428103
007 421 06 98	13.2601-8038.2	210170	123 420 15 83	13.2381-8028.2	210034	129 423 00 12	24.0109-0103.1	409103
007 421 15 98	13.4441-8015.2	210263	123 421 00 12	24.0113-0137.1	413137	129 423 03 12	24.0122-0218.1	422118
007 421 16 98	13.4441-8016.2	210264	123 428 01 35	83.7704-0281.3	330804	129 428 00 35	24.5101-0346.3	331406
007 421 83 98	13.4441-8013.2	210261	123 428 02 35	83.6104-0360.3	330475	140 420 00 48	24.5113-0540.3	331301
007 421 84 98	13.4441-8014.2	210262	123 428 03 35	24.5170-0426.3	331452	140 420 04 20	03.0137-0244.2	650244
008 420 24 18	24.3222-1732.3	020537	123 428 05 35	24.5170-0426.3	331452	140 420 08 20	03.0137-0244.2	650244
008 420 42 18	24.3215-0902.3	020153	123 428 06 35	24.5101-0346.3	331406	140 420 09 20	03.0137-0244.2	650244
008 420 43 18	24.3217-1109.3	020173	123 540 00 17	24.8190-0401.2	620401	140 420 09 85	24.3727-0456.2	580456
008 420 44 18	24.3222-1732.3	020537	124 420 00 83	24.9238-8035.5	230025	140 420 10 85	24.3727-0455.2	580455
008 421 18 98	13.4441-8013.2	210261	124 420 01 48	83.6154-0526.3	330285	140 420 18 85	24.3727-0462.2	580462
008 421 19 98	13.4441-8014.2	210262	124 420 01 83	24.9238-8036.5	230026	140 420 19 85	24.3727-0456.2	580456
008 421 20 98	13.4441-8013.2	210261	124 420 02 83	24.9235-8005.5	230023	140 420 20 85	24.3727-0455.2	580455
008 421 21 98	13.4441-8014.2	210262	124 420 03 20	03.0137-0170.2	650170	140 420 38 85	24.3727-0462.2	580462
009 420 11 18	24.3222-1732.3	020537	124 420 03 83	24.9235-8006.5	230024	140 420 44 85	24.3727-0462.2	580462
009 420 15 18	24.3244-0904.3	020301	124 420 05 20	03.0137-0170.2	650170	140 421 02 12	24.0130-0100.1	430100
009 420 70 18	24.3244-0904.3	020301	124 420 07 20	03.0137-0170.2	650170	140 421 03 12	24.0128-0127.1	428127
009 420 82 18	03.3222-5804.3	020083	124 420 10 85	24.3727-0411.2	580411	140 421 09 12	24.0130-0100.1	430100
009 420 83 18	03.3222-7802.3	020088	124 420 11 85	24.3727-0409.2	580409	140 421 10 12	24.0130-0100.1	430100
009 420 84 18	24.3223-1705.3	020418	124 420 26 85	24.3727-0411.2	580411	140 423 04 12	24.0122-0133.1	422133
010 420 08 18	24.3244-0904.3	020301	124 421 00 71	13.8190-0242.1	990124	140 423 06 12	24.0112-0129.1	412129
011 420 00 18	24.3222-1732.3	020537	124 421 01 71	13.8190-0330.1	990134	140 540 12 17	24.8190-0401.2	620401



Vergleichsliste

Cross reference list - Tabella di conversione codici



Liste des correspondances - Lista referencias

MERCEDES BENZ 			MERCEDES BENZ 			MERCEDES BENZ 		
201 290 00 11	24.2523-1210.3	040105	419 421 09 98	13.2601-8038.2	210170	601 420 34 85	24.3727-0460.2	580460
201 290 01 11	24.2523-1210.3	040105	419 421 10 98	13.9544-0021.2	210257	601 420 36 85	24.3727-0459.2	580459
201 290 03 11	24.2523-1210.3	040105	419 421 11 98	13.9544-0022.2	210258	601 420 37 85	24.3727-0460.2	580460
201 290 04 11	24.2523-1310.3	040106	427 421 00 98	13.2601-8035.2	210167	601 420 46 85	24.3727-0459.2	580459
201 290 05 11	24.2523-1310.3	040106	427 421 01 98	13.2601-8037.2	210169	601 420 47 85	24.3727-0460.2	580460
201 420 00 83	24.9235-8005.5	230023	427 421 02 98	13.2601-8036.2	210168	601 420 76 20	13.0460-4401.2	604401
201 420 01 83	24.9235-8006.5	230024	427 421 03 98	13.2601-8038.2	210170	601 420 87 20	13.0460-4401.2	604401
201 420 02 83	24.9235-8005.5	230023	427 421 04 98	13.9544-0022.2	210258	601 421 03 12	24.0122-0140.1	422140
201 420 03 83	24.9235-8006.5	230024	427 421 05 98	13.9544-0021.2	210257	601 421 04 12	24.0116-0100.1	416100
201 420 04 83	24.9235-8005.5	230023	427 421 17 98	13.9574-7005.2	210275	601 421 05 12	24.0122-0140.1	422140
201 420 04 85	24.3727-0410.2	580410	427 421 18 98	13.9574-7006.2	210276	601 421 50 12	24.0116-0100.1	416100
201 420 05 83	24.9235-8006.5	230024	427 421 19 98	13.2601-8035.2	210167	601 421 51 12	24.0116-0100.1	416100
201 420 06 85	24.3727-0409.2	580409	427 421 20 98	13.2601-8036.2	210168	601 423 50 01	24.0226-0001.1	480050
201 420 07 85	24.3727-0409.2	580409	427 421 21 98	13.2601-8037.2	210169	601 423 51 01	24.0223-0009.1	480039
201 421 08 12	24.0111-0137.1	411137	427 421 22 98	13.2601-8038.2	210170	601 586 00 42	13.0460-4401.2	604401
201 421 12 12	24.0111-0137.1	411137	427 421 23 98	13.9544-0021.2	210257	603 420 00 18	24.3222-1733.3	020538
201 421 13 12	24.0122-0124.1	422124	427 421 24 98	13.9544-0022.2	210258	608 420 03 18	03.3222-4401.3	020076
201 421 15 12	24.0122-0124.1	422124	435 421 04 98	13.9544-0021.2	210257	608 428 00 35	83.6123-0465.3	330379
201 423 09 12	24.0109-0120.1	409120	435 421 05 98	13.9544-0022.2	210258	608 428 01 35	83.6203-0200.3	330298
201 423 09 12	24.0309-0120.1	509120	435 421 12 98	13.2601-7015.2	210230	608 430 07 01	03.2123-3302.3	010180
201 423 11 12	24.0109-0120.1	409120	435 421 13 98	13.2601-7016.2	210231	608 431 00 49	03.3304-0700.1	390082
201 423 11 12	24.0309-0120.1	509120	435 421 14 98	13.2601-8037.2	210169	608 545 00 09	24.3526-0810.3	340037
201 423 12 12	24.0109-0120.1	409120	435 421 15 98	13.2601-8038.2	210170	631 290 00 12	24.2419-1729.3	030118
201 423 12 12	24.0309-0120.1	509120	435 542 00 17	24.8190-0403.2	620403	631 420 00 18	24.3225-1102.3	020318
201 540 03 17	24.8190-0402.2	620402	437 421 01 98	13.4571-8005.3	210205	631 420 00 82	13.0460-0918.2	610918
202 290 00 11	24.2523-1310.3	040106	437 421 02 98	13.4571-8006.3	210206	631 420 01 20	13.0460-3945.2	603945
202 290 01 12	24.2419-1703.3	030097	437 421 04 98	13.9574-7005.2	210275	631 420 03 20	13.0460-3945.2	603945
202 423 00 12	24.0109-0120.1	409120	437 421 05 98	13.9574-7006.2	210276	631 420 03 72	24.0116-0107.2	416107
202 423 00 12	24.0309-0120.1	509120	437 421 07 98	13.4571-8005.3	210205	631 420 04 83	24.3481-1759.5	240339
203 423 01 12	24.0109-0114.1	409114	437 421 08 98	13.4571-8006.3	210206	631 420 05 83	24.3481-1759.5	240339
203 423 01 12	24.0309-0114.1	509114	437 421 10 98	13.9574-7005.2	210275	631 420 10 83	24.3481-1759.5	240339
210 423 01 12	24.0109-0114.1	409114	437 421 11 98	13.9574-7006.2	210276	631 420 11 83	24.3481-1759.5	240339
210 423 01 12	24.0309-0114.1	509114	437 421 12 98	13.9571-0003.2	210277	631 420 12 85	24.3727-0415.2	580415
210 423 04 12	24.0109-0114.1	409114	437 421 13 98	13.9571-0004.2	210278	631 420 19 85	24.3727-0414.2	580414
210 423 04 12	24.0309-0114.1	509114	437 421 14 98	13.9574-7005.2	210275	631 420 20 85	24.3727-0413.2	580413
210 423 09 12	24.0109-0114.1	409114	437 421 15 98	13.9574-7006.2	210276	631 420 21 85	24.3727-0415.2	580415
210 423 09 12	24.0309-0114.1	509114	437 421 16 98	13.9571-0003.2	210277	631 420 32 83	24.3481-1759.5	240339
310 420 00 18	24.3238-0901.3	020298	437 421 17 98	13.9571-0004.2	210278	631 420 33 83	24.3481-1759.5	240339
310 420 03 18	24.3238-0901.3	020298	437 421 18 98	13.9574-7005.2	210275	631 423 00 01	24.0225-4003.1	480049
310 420 05 18	24.3238-0901.3	020298	437 421 19 98	13.9574-7006.2	210276	631 423 00 07	03.0137-0245.2	650245
310 420 08 18	24.3238-0901.3	020298	437 421 20 98	13.2601-0146.2	210248	631 423 00 88	03.0137-9145.2	669145
316 420 01 18	03.3241-1801.3	020130	437 421 21 98	13.2601-0145.2	210247	631 423 01 07	03.0137-0245.2	650245
316 420 02 18	03.3241-1801.3	020130	437 421 22 98	13.2544-0019.2	210251	631 428 00 35	24.5232-0388.3	330580
405 421 00 98	13.2601-0145.2	210247	437 421 23 98	13.2544-0020.2	210252	631 430 11 01	24.2125-1719.3	010666
405 421 01 98	13.2601-0146.2	210248	437 421 25 98	13.2544-0019.2	210251	667 290 02 12	24.2419-0933.3	030059
405 421 02 98	13.2544-0019.2	210251	437 421 26 98	13.2544-0020.2	210252	667 420 29 01	13.4441-8013.2	210261
405 421 03 98	13.2544-0020.2	210252	440 421 00 98	13.2601-8035.2	210167	667 420 30 01	13.4441-8014.2	210262
405 421 06 98	13.2544-0019.2	210251	440 421 01 98	13.2601-8036.2	210168	667 420 31 01	13.4441-8013.2	210261
405 421 07 98	13.2544-0020.2	210252	440 421 02 98	13.2601-8037.2	210169	667 420 32 01	13.4441-8014.2	210262
415 423 00 23	03.0137-9228.2	669228	440 421 03 98	13.2601-8038.2	210170	667 420 35 01	13.4441-8013.2	210261
416 421 00 98	13.2601-8035.2	210167	460 295 00 06	24.2419-0942.3	030068	667 420 36 01	13.4441-8014.2	210262
416 421 01 98	13.2601-8037.2	210169	460 420 00 20	13.0460-4401.2	604401	667 420 37 01	13.4441-8013.2	210261
416 421 02 98	13.9544-0022.2	210258	460 420 50 48	24.5224-0460.3	331264	667 420 38 01	13.4441-8014.2	210262
416 421 03 98	13.9544-0021.2	210257	460 421 00 12	24.0116-0133.1	416133	667 420 47 01	13.4441-8017.2	210265
416 421 04 98	13.2601-8038.2	210170	460 428 51 35	24.5165-0450.3	331259	667 420 48 01	13.4441-8018.2	210266
416 421 05 98	13.2601-8036.2	210168	460 428 54 35	24.5224-0460.3	331264	667 428 01 35	83.6104-0470.3	330253
416 421 06 98	13.9544-0022.2	210258	460 540 06 17	24.8190-0406.2	620406	668 420 01 18	03.3230-0401.3	020115
416 421 07 98	13.9544-0021.2	210257	461 420 07 02	13.9441-0041.2	210279	668 420 02 18	03.3230-0401.3	020115
418 421 01 98	13.2544-0019.2	210251	461 420 08 02	13.9441-0042.2	210280	668 420 03 18	03.3230-0401.3	020115
418 421 02 98	13.2544-0020.2	210252	461 421 00 12	24.0116-0133.1	416133	668 421 01 12	24.0130-0198.1	430198
418 421 15 98	13.2601-0145.2	210247	463 420 50 85	24.3727-0477.2	580477	668 421 02 12	24.0130-0103.1	430103
418 421 16 98	13.2601-0146.2	210248	463 420 51 85	24.3727-0476.2	580476	668 421 06 12	24.0130-0198.1	430198
419 421 00 98	13.2601-8035.2	210167	463 421 00 12	24.0130-0217.1	430217	669 420 00 20	13.0460-6015.2	606015
419 421 01 98	13.2601-8037.2	210169	463 421 01 12	24.0130-0217.1	430217	669 420 01 20	13.0460-6015.2	606015
419 421 02 98	13.2601-8036.2	210168	463 421 03 12	24.0130-0217.1	430217	669 421 01 12	24.0130-0198.1	430198
419 421 03 98	13.2601-8038.2	210170	601 420 00 72	24.0116-0100.1	416100	669 421 06 12	24.0130-0198.1	430198
419 421 04 98	13.9544-0022.2	210258	601 420 01 72	24.0122-0140.1	422140	669 540 04 17	24.8190-0415.2	620415
419 421 05 98	13.9544-0021.2	210257	601 420 02 72	24.0116-0100.1	416100	669 540 05 17	24.8190-0415.2	620415
419 421 06 98	13.2601-8035.2	210167	601 420 03 72	24.0122-0140.1	422140	669 540 06 17	24.8190-0415.2	620415
419 421 07 98	13.2601-8036.2	210168	601 420 11 85	24.3727-0420.2	580420	670 420 01 18	03.3231-3401.3	020120
419 421 08 98	13.2601-8037.2	210169	601 420 33 85	24.3727-0459.2	580459	670 420 02 18	03.3231-3401.3	020120

Vergleichsliste

Cross reference list - Tabella di conversione codici

Liste des correspondances - Lista referencias



								
MERCEDES BENZ		MERCEDES BENZ		MERCEDES BENZ				
670 420 03 18	03.3231-3401.3	020120	A 000 420 58 20	13.0460-4036.2	604036	A 000 421 47 91	13.0460-0158.2	610158
670 420 28 20	13.0460-6015.2	606015	A 000 420 58 83	24.3541-1726.5	240004	A 000 421 52 91	13.0460-0239.2	610239
670 421 01 12	24.0130-0103.1	430103	A 000 420 59 20	13.0460-9029.2	609029	A 000 421 59 98	13.2571-9998.2	210133
670 421 03 12	24.0130-0103.1	430103	A 000 420 59 83	24.3541-1725.5	240003	A 000 421 60 98	13.2571-9999.2	210134
901 420 01 20	03.0137-4001.2	654001	A 000 420 60 20	13.0460-9029.2	609029	A 000 421 64 91	13.0460-0236.2	610236
901 420 03 20	03.0137-4001.2	654001	A 000 420 60 83	24.3541-1726.5	240004	A 000 421 64 91 64	13.0460-0236.2	610236
901 420 05 20	03.0137-4001.2	654001	A 000 420 62 20	13.0460-3804.2	603804	A 000 421 71 86	13.0441-4214.2	250091
901 540 00 17	24.8190-0407.2	620407	A 000 420 63 20	13.0460-9028.2	609028	A 000 421 71 98	13.2571-9998.2	210133
901 540 01 17	24.8190-0407.2	620407	A 000 420 64 20	13.0460-9028.2	609028	A 000 421 72 86	13.0441-3817.2	250071
902 423 01 12	24.0116-0110.1	416110	A 000 420 65 20	13.0460-9028.2	609028	A 000 421 72 98	13.2571-9999.2	210134
902 423 03 12	24.0116-0110.1	416110	A 000 420 66 20	13.0460-6027.2	606027	A 000 421 73 98	13.2571-9998.2	210133
902 423 04 12	24.0116-0110.1	416110	A 000 420 67 18	03.3228-0502.3	020109	A 000 421 74 98	13.2571-9999.2	210134
902 423 05 12	24.0116-0110.1	416110	A 000 420 67 20	13.0460-6027.2	606027	A 000 421 77 86	13.0441-3606.2	250147
905 420 00 20	13.0460-6015.2	606015	A 000 420 68 20	13.0460-9028.2	609028	A 000 421 78 86	13.0441-4216.2	250093
A 000 000 20 85	03.3517-0300.1	390323	A 000 420 71 20	13.0460-4036.2	604036	A 000 421 79 86	13.0441-4601.2	250099
A 000 290 21 11	03.0450-2311.2	082311	A 000 420 71 83	13.0441-4018.2	250083	A 000 423 00 75	13.0471-5405.2	250136
A 000 290 33 67	03.0450-2311.2	082311	A 000 420 74 20	13.0460-6031.2	606031	A 000 423 04 19	13.0471-5408.2	250138
A 000 295 09 35	24.5901-0225.3	331288	A 000 420 75 20	13.0460-6031.2	606031	A 000 423 11 42	13.8158-0020.1	990113
A 000 295 10 35	24.5901-0225.3	331288	A 000 420 76 20	13.0460-3804.2	603804	A 000 423 12 42	13.8158-0021.1	990114
A 000 295 14 35	24.5901-0517.3	330054	A 000 420 76 20	13.0460-4036.2	604036	A 000 423 13 71	13.0471-5407.2	250137
A 000 295 16 35	24.5901-0517.3	330054	A 000 420 79 83	24.9442-8003.5	230053	A 000 423 23 98	13.2381-8027.2	210033
A 000 295 22 35	24.5901-0225.3	331288	A 000 420 80 83	24.9442-8004.5	230054	A 000 423 24 98	13.2381-8028.2	210034
A 000 295 31 06	24.2419-0934.3	030060	A 000 420 82 83	24.9238-8033.5	230015	A 000 423 25 98	13.2381-8027.2	210033
A 000 295 40 07	03.2523-0811.3	040019	A 000 420 83 83	13.2381-8034.2	210223	A 000 423 26 98	13.2381-8028.2	210034
A 000 295 50 06	24.2419-0937.3	030063	A 000 420 83 83	24.9238-8034.5	230016	A 000 423 31 98	13.2381-8027.2	210033
A 000 295 60 06	24.2419-0937.3	030063	A 000 420 84 18	03.3222-0902.3	020068	A 000 423 32 98	13.2381-8028.2	210034
A 000 295 65 07	03.2523-0811.3	040019	A 000 420 87 83	24.9246-8001.5	230021	A 000 423 33 98	13.2381-8027.2	210033
A 000 295 66 06	24.2419-0937.3	030063	A 000 420 88 20	13.0460-4030.2	604030	A 000 423 34 98	13.2381-8028.2	210034
A 000 295 68 06	03.2423-0603.3	030036	A 000 420 88 83	24.9246-8002.5	230022	A 000 423 47 98	13.2381-8027.2	210033
A 000 295 76 07	03.2523-0812.3	040020	A 000 420 89 20	13.0460-2923.2	602923	A 000 423 48 98	13.2381-8028.2	210034
A 000 295 77 06	24.2419-0937.3	030063	A 000 420 90 20	13.0460-4030.2	604030	A 000 423 58 98	13.2381-8027.2	210033
A 000 295 78 06	24.2419-0937.3	030063	A 000 420 90 83	24.9571-7005.5	230061	A 000 423 59 98	13.2381-8028.2	210034
A 000 295 79 07	03.2538-0104.3	040035	A 000 420 91 20	13.0460-2923.2	602923	A 000 423 60 98	13.2381-8029.2	210035
A 000 295 80 07	03.2525-2602.3	040029	A 000 420 91 83	24.9571-7006.5	230062	A 000 423 61 98	13.2381-8030.2	210036
A 000 295 82 07	03.2523-0811.3	040019	A 000 420 92 83	13.2401-8013.2	210051	A 000 423 63 98	13.2381-8027.2	210033
A 000 295 89 07	03.2525-2602.3	040029	A 000 420 92 83	24.9240-8013.5	230019	A 000 423 64 98	13.2381-8028.2	210034
A 000 295 91 06	24.2419-0901.3	030041	A 000 420 93 83	13.2401-8014.2	210052	A 000 423 70 98	13.2381-8027.2	210033
A 000 295 96 06	24.2419-0911.3	030043	A 000 420 93 83	24.9240-8014.5	230020	A 000 423 71 98	13.2381-8028.2	210034
A 000 295 97 06	24.2419-0911.3	030043	A 000 420 94 20	13.0460-9029.2	609029	A 000 423 72 98	13.2381-8027.2	210033
A 000 296 01 07	03.2524-0400.3	040024	A 000 420 95 20	13.0460-9029.2	609029	A 000 423 73 98	13.2381-8028.2	210034
A 000 420 00 76	11.0101-5407.2	260011	A 000 420 95 83	13.0441-4020.2	250084	A 000 423 82 98	13.2381-8029.2	210035
A 000 420 01 20	13.0460-4030.2	604030	A 000 420 97 20	13.0460-3990.2	603990	A 000 423 83 98	13.2381-8030.2	210036
A 000 420 01 44	13.0441-3505.2	250051	A 000 420 98 20	13.0460-4034.2	604034	A 000 423 89 98	13.2421-8021.2	210057
A 000 420 02 44	11.0441-5404.2	250029	A 000 420 99 20	13.0460-2927.2	602927	A 000 423 89 98	24.9242-8021.5	230031
A 000 420 03 44	13.0441-5417.2	250118	A 000 420 99 20	13.0470-2927.2	LD2927	A 000 423 90 98	24.9242-8022.5	230032
A 000 420 04 42	24.8190-0029.2	990156	A 000 420 99 83	13.0441-5721.2	250123	A 000 423 91 98	13.2381-8027.2	210033
A 000 420 05 42	24.8190-0030.2	990157	A 000 421 02 91	13.0460-0026.2	610026	A 000 423 92 98	13.2381-8028.2	210034
A 000 420 07 42	13.0471-5409.2	250139	A 000 421 08 18	11.8171-0008.1	990049	A 000 423 95 98	13.2353-8003.2	210016
A 000 420 11 44	13.0441-6012.2	250133	A 000 421 14 20	13.0460-0214.2	610214	A 000 423 96 98	13.2353-8004.2	210017
A 000 420 12 44	13.0441-4016.2	250081	A 000 421 23 91	13.0460-0131.2	610131	A 000 426 63 98	13.2381-8027.2	210033
A 000 420 14 01	13.9441-0041.2	210279	A 000 421 24 91	13.0460-0132.2	610132	A 000 428 00 32	03.3517-0300.1	390323
A 000 420 14 44	11.0441-6002.2	250036	A 000 421 24 98	13.2571-9998.2	210133	A 000 428 01 35	83.6103-0450.3	330228
A 000 420 15 01	13.9441-0042.2	210280	A 000 421 25 98	13.2571-9999.2	210134	A 000 428 02 35	83.6103-0500.3	330230
A 000 420 15 44	13.0441-5724.2	250125	A 000 421 28 91	13.0460-0158.2	610158	A 000 428 07 35	83.6123-0381.3	330262
A 000 420 17 55	03.3518-6100.2	390364	A 000 421 29 91	13.0460-0158.2	610158	A 000 428 08 35	83.6103-0240.3	330220
A 000 420 20 51	03.0401-2031.2	052031	A 000 421 30 88	13.0460-0158.2	610158	A 000 428 14 35	83.6103-0650.3	330235
A 000 420 24 44	13.0441-6012.2	250133	A 000 421 30 91	13.0460-0171.2	610171	A 000 428 16 35	83.6103-0450.3	330228
A 000 420 25 44	13.0441-5721.2	250123	A 000 421 32 91	13.0460-0214.2	610214	A 000 428 26 35	83.6204-0240.3	330718
A 000 420 29 55	03.3518-8000.2	390373	A 000 421 33 91	13.0460-0186.2	610186	A 000 428 28 35	24.5170-0426.3	331452
A 000 420 46 83	13.2423-8009.2	210063	A 000 421 34 88	13.0460-0160.2	610160	A 000 428 29 35	83.7704-0320.3	330851
A 000 420 47 83	13.2423-8010.2	210064	A 000 421 36 91	13.0460-0197.2	610197	A 000 428 30 35	83.6104-0210.3	330473
A 000 420 50 83	24.3541-1631.5	240413	A 000 421 39 91	13.0460-0219.2	610219	A 000 428 31 35	83.6204-0220.3	330308
A 000 420 51 83	24.3541-1632.5	240414	A 000 421 39 98	13.2571-9998.2	210133	A 000 428 35 35	83.7704-0281.3	330804
A 000 420 52 83	24.3541-1631.5	240413	A 000 421 40 91	13.0460-0215.2	610215	A 000 428 36 35	83.6192-0250.3	330726
A 000 420 53 83	24.3541-1632.5	240414	A 000 421 40 98	13.2571-9999.2	210134	A 000 428 38 35	83.6203-0250.3	330299
A 000 420 55 83	24.3541-1603.5	240037	A 000 421 41 91	13.0460-0160.2	610160	A 000 428 39 35	83.6203-0260.3	330300
A 000 420 56 83	24.3541-1604.5	240038	A 000 421 41 98	13.2571-9998.2	210133	A 000 428 40 35	83.6103-0320.3	330224
A 000 420 57 20	13.0460-3804.2	603804	A 000 421 42 98	13.2571-9999.2	210134	A 000 428 42 35	83.6103-0400.3	330226
A 000 420 57 20	13.0460-4036.2	604036	A 000 421 43 98	13.2571-9998.2	210133	A 000 428 43 35	83.6103-0600.3	330233
A 000 420 57 83	24.3541-1725.5	240003	A 000 421 44 98	13.2571-9999.2	210134	A 000 428 44 35	83.6103-0190.3	330218
A 000 420 58 20	13.0460-3804.2	603804	A 000 421 46 86	11.0101-5403.2	260010	A 000 428 45 35	83.6203-0200.3	330298



Vergleichsliste

Cross reference list - Tabella di conversione codici

Liste des correspondances - Lista referencias



MERCEDES BENZ 			MERCEDES BENZ 			MERCEDES BENZ 		
A 000 428 47 35	83.6103-0550.3	330231	A 000 586 76 42	13.0460-3804.2	603804	A 001 420 19 83	24.3541-1604.5	240038
A 000 428 48 35	83.6123-0381.3	330262	A 000 586 76 42	13.0460-4036.2	604036	A 001 420 23 83	11.0441-6007.2	250146
A 000 428 58 35	83.6204-0350.3	330382	A 000 586 91 42	03.4002-1128.2	060027	A 001 420 33 18	03.2728-2101.3	020008
A 000 428 67 35	83.6104-0440.3	330714	A 000 991 03 60	13.0460-0026.2	610026	A 001 420 34 18	03.2728-2201.3	020009
A 000 428 70 35	83.6203-0300.3	330386	A 000 991 20 60	13.0460-0214.2	610214	A 001 420 37 83	13.2421-8025.2	210061
A 000 428 71 35	24.5201-0220.3	331272	A 000 991 32 60	13.0460-0158.2	610158	A 001 420 38 83	13.2421-8026.2	210062
A 000 428 76 35	83.6133-0500.3	330272	A 000 991 39 60	13.0460-0131.2	610131	A 001 420 39 83	24.9246-8001.5	230021
A 000 428 79 35	83.6104-0241.3	330731	A 000 991 40 60	13.0460-0132.2	610132	A 001 420 40 83	24.9246-8002.5	230022
A 000 428 80 35	24.5170-0426.3	331452	A 000 991 73 60	13.0460-0197.2	610197	A 001 420 75 20	13.0460-9029.2	609029
A 000 428 82 35	83.6133-0551.3	330273	A 000 991 97 60	13.0460-0171.2	610171	A 001 420 76 20	13.0460-4037.2	604037
A 000 428 89 35	83.6133-0651.3	330274	A 000 991 97 60	13.0460-0186.2	610186	A 001 420 77 20	13.0460-6027.2	606027
A 000 428 91 35	83.6133-0551.3	330273	A 000 991 97 60	13.0460-0215.2	610215	A 001 420 78 20	13.0460-9028.2	609028
A 000 428 93 35	83.6104-0220.3	330474	A 000 991 98 60	13.0460-0219.2	610219	A 001 420 79 20	13.0460-4036.2	604036
A 000 430 00 81	03.3318-0800.2	390112	A 000 997 08 86	03.3304-0700.1	390082	A 001 420 81 20	13.0460-2923.2	602923
A 000 430 03 81	03.3318-0800.2	390112	A 000 997 50 30	03.3517-0101.2	390322	A 001 420 85 20	13.0460-4037.2	604037
A 000 430 47 02	03.3508-0264.3	310009	A 000 997 78 30	03.3517-0101.2	390322	A 001 420 92 20	13.0460-6031.2	606031
A 000 430 64 01	03.3125-0401.3	010290	A 001 295 02 06	24.2419-0942.3	030068	A 001 420 93 20	13.0460-3804.2	603804
A 000 430 72 01	03.3126-0505.3	010294	A 001 295 03 07	03.2538-0104.3	040035	A 001 420 93 20	13.0460-4036.2	604036
A 000 430 92 30	03.6850-0202.4	300043	A 001 295 11 06	24.2419-0917.3	030047	A 001 420 94 20	13.0460-4201.2	604201
A 000 430 95 30	03.6855-1202.4	300056	A 001 295 13 07	24.2523-1210.3	040105	A 001 420 95 20	13.0460-3805.2	603805
A 000 431 12 02	03.3508-3600.3	310030	A 001 295 14 06	24.2419-0901.3	030041	A 001 420 95 20	13.0470-3805.2	LD3805
A 000 431 13 02	03.3509-0100.3	310057	A 001 295 14 07	24.2523-1210.3	040105	A 001 420 96 20	13.0460-2923.2	602923
A 000 431 15 02	03.3508-0501.3	310017	A 001 295 15 06	24.2419-0937.3	030063	A 001 420 98 20	13.0460-4201.2	604201
A 000 431 16 02	03.3508-0401.3	310014	A 001 295 17 06	24.2419-0917.3	030047	A 001 420 99 20	13.0460-9029.2	609029
A 000 431 21 02	03.3508-0801.3	310023	A 001 295 24 06	24.2419-0932.3	030058	A 001 421 02 98	13.2571-9998.2	210133
A 000 431 24 02	03.3509-0600.3	310065	A 001 295 27 07	24.2523-1210.3	040105	A 001 421 03 98	13.2571-9999.2	210134
A 000 431 36 07	24.7718-7301.2	990024	A 001 295 29 06	03.2423-0603.3	030036	A 001 421 29 98	13.2571-8013.2	210123
A 000 431 47 02	03.3508-0264.3	310009	A 001 295 29 07	24.2523-1210.3	040105	A 001 421 30 98	13.2571-8014.2	210124
A 000 431 53 02	03.3508-4903.3	310032	A 001 295 30 06	24.2426-0902.3	030073	A 001 421 36 98	24.9260-8025.5	230041
A 000 431 64 02	03.3508-8753.3	310049	A 001 295 30 07	24.2523-1210.3	040105	A 001 421 37 98	24.9260-8026.5	230042
A 000 431 69 02	03.3508-0264.3	310009	A 001 295 38 06	24.2419-0942.3	030068	A 001 421 47 98	13.2571-9998.2	210133
A 000 431 70 12	03.6521-0012.3	320094	A 001 295 40 06	24.2419-0921.3	030050	A 001 421 48 98	13.2571-9999.2	210134
A 000 431 89 02	03.3508-8753.3	310049	A 001 295 43 06	24.2419-0942.3	030068	A 001 421 51 98	13.2571-8013.2	210123
A 000 540 02 17	24.8190-0401.2	620401	A 001 295 44 06	24.2419-0935.3	030061	A 001 421 52 98	13.2571-8014.2	210124
A 000 545 01 09	03.3526-2002.3	340010	A 001 295 44 06	24.2419-0936.3	030062	A 001 421 73 98	13.2571-9998.2	210133
A 000 545 05 09	24.3526-0100.3	340017	A 001 295 51 06	24.2419-0934.3	030060	A 001 421 74 98	13.2571-9999.2	210134
A 000 545 13 09	24.3526-0100.3	340017	A 001 295 52 06	24.2419-0932.3	030058	A 001 421 77 98	24.9260-8025.5	230041
A 000 545 17 09	24.3526-0100.3	340017	A 001 295 53 07	03.2538-0104.3	040035	A 001 421 78 98	24.9260-8026.5	230042
A 000 545 22 09	24.3526-0100.3	340017	A 001 295 54 07	24.2528-0907.3	040054	A 001 421 79 98	13.2601-9996.2	210176
A 000 545 34 09	24.3526-0100.3	340017	A 001 295 60 06	03.2423-0603.3	030036	A 001 421 80 98	13.2601-9997.2	210177
A 000 545 42 09	24.3526-0100.3	340017	A 001 295 61 07	24.2523-1210.3	040105	A 001 421 81 98	13.2571-9998.2	210133
A 000 545 43 09	24.3526-0810.3	340037	A 001 295 68 06	24.2419-0915.3	030045	A 001 421 82 98	13.2571-9999.2	210134
A 000 545 51 09	24.3526-0810.3	340037	A 001 295 68 07	03.2523-0811.3	040019	A 001 421 86 98	24.9260-8025.5	230041
A 000 545 55 09	24.3526-1900.0	340038	A 001 295 76 06	24.2419-0917.3	030047	A 001 421 87 98	24.9260-8026.5	230042
A 000 545 61 09	24.3526-0100.3	340017	A 001 295 79 06	24.2419-0917.3	030047	A 001 421 98 98	13.4571-8005.3	210205
A 000 586 01 43	03.0101-3501.2	390001	A 001 295 80 06	24.2419-0942.3	030068	A 001 421 99 98	13.4571-8006.3	210206
A 000 586 06 42	13.0460-6027.2	606027	A 001 295 86 06	24.2419-0917.3	030047	A 001 423 46 98	24.9235-8005.5	230023
A 000 586 11 43	03.0370-1131.2	051131	A 001 295 87 06	24.2419-0937.3	030063	A 001 423 47 98	24.9235-8006.5	230024
A 000 586 13 43	13.0441-5718.2	250120	A 001 295 88 07	03.2538-0104.3	040035	A 001 428 02 35	83.6103-0300.3	330223
A 000 586 15 43	13.0441-4206.2	250087	A 001 295 96 07	24.2528-0907.3	040054	A 001 428 03 35	83.6104-0470.3	330253
A 000 586 21 29	03.0450-2311.2	082311	A 001 420 01 20	13.0460-4030.2	604030	A 001 428 04 35	24.5201-0220.3	331272
A 000 586 22 42	13.0460-4036.2	604036	A 001 420 02 20	13.0460-3805.2	603805	A 001 428 07 35	83.6203-0300.3	330386
A 000 586 25 42	13.0460-3804.2	603804	A 001 420 02 20	13.0470-3805.2	LD3805	A 001 428 09 35	83.6203-0250.3	330299
A 000 586 25 42	13.0460-4036.2	604036	A 001 420 03 20	13.0460-4037.2	604037	A 001 428 14 35	83.6204-0280.3	330732
A 000 586 27 88	03.4002-1128.2	060027	A 001 420 04 18	03.3223-0102.3	020090	A 001 428 17 35	24.5201-0220.3	331272
A 000 586 28 88	03.4002-1128.2	060027	A 001 420 05 20	13.0460-9029.2	609029	A 001 428 18 35	83.6103-0200.3	330219
A 000 586 29 42	13.0460-6027.2	606027	A 001 420 06 20	13.0460-3804.2	603804	A 001 428 21 35	83.6123-0465.3	330379
A 000 586 31 29	03.0450-3801.2	083801	A 001 420 06 20	13.0460-4036.2	604036	A 001 428 36 35	83.6103-0450.3	330228
A 000 586 33 29	03.0450-2509.2	082509	A 001 420 06 83	13.2421-8025.2	210061	A 001 428 48 35	83.6133-0651.3	330274
A 000 586 37 42	13.0460-6027.2	606027	A 001 420 07 20	13.0460-2927.2	602927	A 001 428 53 35	83.6123-0465.3	330379
A 000 586 38 29	03.0450-2805.2	082805	A 001 420 07 20	13.0470-2927.2	LD2927	A 001 428 54 35	83.6123-0465.3	330379
A 000 586 39 29	03.0450-2311.2	082311	A 001 420 07 83	13.2421-8026.2	210062	A 001 428 55 35	83.6133-0500.3	330272
A 000 586 41 42	13.0460-4036.2	604036	A 001 420 08 20	13.0460-4037.2	604037	A 001 428 87 35	83.6203-0250.3	330299
A 000 586 46 29	03.0450-2510.2	082510	A 001 420 09 20	13.0460-6031.2	606031	A 001 428 88 35	83.6104-0360.3	330475
A 000 586 48 43	03.0370-1038.2	051038	A 001 420 10 20	13.0460-2923.2	602923	A 001 428 94 35	24.5170-0426.3	331452
A 000 586 48 43	03.0370-9998.2	059998	A 001 420 13 20	13.0460-3805.2	603805	A 001 428 95 35	24.5201-0474.3	331434
A 000 586 53 43	13.0441-3504.2	250050	A 001 420 13 20	13.0470-3805.2	LD3805	A 001 430 36 30	03.6850-0202.4	300043
A 000 586 64 42	13.0441-5718.2	250120	A 001 420 13 83	11.0101-5403.2	260010	A 001 430 43 60	13.0441-6010.2	250132
A 000 586 72 42	13.0460-6027.2	606027	A 001 420 14 20	13.0460-4401.2	604401	A 001 430 48 01	03.3131-0601.3	010299
A 000 586 74 42	13.0441-6001.2	250126	A 001 420 15 20	13.0460-6015.2	606015	A 001 430 52 01	03.2123-0609.3	010171
A 000 586 75 42	13.0460-9028.2	609028	A 001 420 18 83	24.3541-1603.5	240037	A 001 430 63 01	03.2123-0609.3	010171



Vergleichsliste

Cross reference list - Tabella di conversione codici

Liste des correspondances - Lista referencias



MERCEDES BENZ 			MERCEDES BENZ 			MERCEDES BENZ 		
A 001 430 64 01	03.2123-0614.3	010172	A 002 421 31 98	24.9260-8030.5	230044	A 003 421 10 98	24.9260-8031.5	230045
A 001 430 66 30	03.6850-0202.4	300043	A 002 421 38 98	13.4441-8015.2	210263	A 003 421 11 98	24.9260-8032.5	230046
A 001 430 79 01	03.3138-2001.3	010310	A 002 421 39 98	13.4441-8016.2	210264	A 003 421 24 98	13.2601-8034.2	210166
A 001 430 81 01	03.2320-0201.3	010234	A 002 421 40 98	13.4441-8013.2	210261	A 003 421 25 98	13.2601-8033.2	210165
A 001 430 84 30	03.6855-1202.4	300056	A 002 421 41 98	13.4441-8014.2	210262	A 003 421 39 98	13.4441-8013.2	210261
A 001 430 89 01	03.2123-0614.3	010172	A 002 421 54 98	13.2571-8011.2	210121	A 003 421 40 98	13.4441-8014.2	210262
A 001 431 05 02	03.3508-0503.3	310018	A 002 421 55 98	13.2571-8012.2	210122	A 003 421 41 98	13.4441-8015.2	210263
A 001 431 06 02	03.3508-8753.3	310049	A 002 421 56 98	13.2571-8013.2	210123	A 003 421 42 98	13.4441-8016.2	210264
A 001 431 07 02	03.3508-8753.3	310049	A 002 421 57 98	13.2571-8014.2	210124	A 003 421 43 98	13.4441-8015.2	210263
A 001 431 08 12	03.6511-0030.3	320076	A 002 423 11 98	13.9544-0022.2	210258	A 003 421 44 98	13.4441-8016.2	210264
A 001 431 09 12	03.6511-0030.3	320076	A 002 423 12 98	13.9544-0021.2	210257	A 003 421 45 98	13.4441-8013.2	210261
A 001 431 39 12	03.6513-0340.3	320084	A 002 423 94 98	13.2421-8025.2	210061	A 003 421 46 98	13.4441-8014.2	210262
A 001 431 42 02	03.3508-8753.3	310049	A 002 423 95 98	13.2421-8026.2	210062	A 003 421 47 98	13.4441-8013.2	210261
A 001 431 45 02	03.3508-8753.3	310049	A 002 428 05 35	83.6133-0500.3	330272	A 003 421 48 98	13.4441-8014.2	210262
A 001 431 69 12	03.6515-0305.3	320087	A 002 428 20 35	83.6203-0250.3	330299	A 003 421 49 98	13.4441-8015.2	210263
A 001 586 18 42	13.0460-9028.2	609028	A 002 428 57 35	24.5201-0220.3	331272	A 003 421 50 98	13.4441-8016.2	210264
A 001 586 19 42	13.0460-6027.2	606027	A 002 428 58 35	83.6203-0250.3	330299	A 003 430 04 01	03.2122-4902.3	010144
A 001 586 31 42	13.0460-6027.2	606027	A 002 430 02 30	03.6850-2602.4	300049	A 003 430 06 01	03.2125-1302.3	010203
A 001 586 32 42	13.0460-9028.2	609028	A 002 430 14 01	03.3134-0300.3	010308	A 003 430 06 30	03.6855-1902.4	300059
A 001 586 33 42	13.0460-9028.2	609028	A 002 430 21 01	03.3138-2001.3	010310	A 003 430 07 01	03.2125-1102.3	010202
A 001 586 36 42	13.0460-9028.2	609028	A 002 430 22 01	03.3134-0300.3	010308	A 003 430 15 30	03.7760-2702.4	300090
A 001 586 37 42	03.0403-0341.2	060031	A 002 430 28 01	03.2123-1003.3	010175	A 003 430 22 01	03.2123-1003.3	010175
A 001 586 48 42	13.0441-5417.2	250118	A 002 430 36 01	03.3138-2001.3	010310	A 003 430 24 30	03.7760-2702.4	300090
A 001 586 53 42	13.0441-5721.2	250123	A 002 430 41 01	03.3134-0300.3	010308	A 003 430 34 30	03.6855-2202.4	300061
A 001 586 54 42	13.0441-5721.2	250123	A 002 430 44 30	03.6855-1202.4	300056	A 003 430 60 01	03.2023-0166.3	010015
A 001 586 64 42	13.0460-3804.2	603804	A 002 430 68 30	03.6855-1202.4	300056	A 003 430 78 01	03.2023-0166.3	010015
A 001 586 70 42	13.0460-4401.2	604401	A 002 430 84 01	03.3138-2001.3	010310	A 003 430 79 01	03.2123-6002.3	010184
A 001 586 73 43	13.0441-3811.2	250067	A 002 430 85 01	03.3134-0300.3	010308	A 003 430 82 01	03.2123-6002.3	010184
A 001 586 89 42	13.0460-4401.2	604401	A 002 430 86 01	03.2125-1102.3	010202	A 003 430 98 01	24.2123-0901.3	010382
A 001 991 16 60	13.0460-0239.2	610239	A 002 430 91 01	03.3138-2001.3	010310	A 003 430 99 01	03.2023-0166.3	010015
A 001 991 27 60	13.0460-0236.2	610236	A 002 430 92 01	03.3134-0300.3	010308	A 003 542 47 17	24.3526-1900.0	340038
A 001 991 27 60 ⁶⁴	13.0460-0236.2	610236	A 002 430 93 01	03.2123-3402.3	010181	A 004 420 14 20	13.0460-4401.2	604401
A 001 997 55 30	03.3517-5100.1	390326	A 002 430 99 30	03.6855-1402.4	300057	A 004 420 16 20	13.0460-4047.2	604047
A 002 295 04 07	03.2538-0104.3	040035	A 002 431 13 12	03.6513-0340.3	320084	A 004 420 16 20	13.0470-4047.2	LD4047
A 002 295 13 07	03.2523-0812.3	040020	A 002 586 17 42	13.0441-6010.2	250132	A 004 420 37 18	24.3223-1705.3	020418
A 002 420 00 20	13.0460-3504.2	603504	A 002 586 20 42	13.0460-6031.2	606031	A 004 420 41 83	13.2601-0145.2	210247
A 002 420 01 20	13.0460-3504.2	603504	A 002 586 41 42	13.0460-6031.2	606031	A 004 420 42 83	13.2601-0146.2	210248
A 002 420 02 20	13.0460-2923.2	602923	A 002 586 44 42	13.0441-6003.2	250128	A 004 420 43 83	13.2544-0019.2	210251
A 002 420 03 20	13.0460-6036.2	606036	A 002 586 45 42	13.0460-9029.2	609029	A 004 420 44 83	13.9571-0003.2	210277
A 002 420 04 20	13.0460-9033.2	609033	A 002 586 46 42	13.0460-9029.2	609029	A 004 420 45 83	13.9574-7005.2	210275
A 002 420 05 20	13.0460-4047.2	604047	A 002 586 47 42	13.0460-3804.2	603804	A 004 420 48 83	13.2544-0020.2	210252
A 002 420 05 20	13.0470-4047.2	LD4047	A 002 586 47 42	13.0460-4036.2	604036	A 004 420 49 83	13.9571-0004.2	210278
A 002 420 08 18	03.3220-0905.3	020059	A 002 586 48 42	13.0460-3804.2	603804	A 004 420 50 83	13.9574-7006.2	210276
A 002 420 12 20	13.0460-9033.2	609033	A 002 586 48 42	13.0460-4036.2	604036	A 004 420 62 18	03.3222-5804.3	020083
A 002 420 15 20	13.0460-4201.2	604201	A 002 586 53 42	13.0441-4408.2	250096	A 004 420 81 83	13.9441-0041.2	210279
A 002 420 16 20	13.0460-4047.2	604047	A 003 420 03 18	03.3220-0905.3	020059	A 004 420 82 83	13.9441-0042.2	210280
A 002 420 16 20	13.0470-4047.2	LD4047	A 003 420 04 18	03.3222-4007.3	020074	A 004 421 78 98	13.4441-8013.2	210261
A 002 420 18 20	13.0460-9033.2	609033	A 003 420 07 20	13.0460-4401.2	604401	A 004 421 79 98	13.4441-8014.2	210262
A 002 420 19 20	13.0460-4202.2	604202	A 003 420 14 20	03.0137-4001.2	654001	A 004 421 82 98	13.4441-8015.2	210263
A 002 420 23 20	13.0460-2927.2	602927	A 003 420 15 20	13.0460-6015.2	606015	A 004 421 83 98	13.4441-8016.2	210264
A 002 420 23 20	13.0470-2927.2	LD2927	A 003 420 20 83	13.2601-8035.2	210167	A 004 430 08 30	03.7760-2702.4	300090
A 002 420 26 20	13.0460-9033.2	609033	A 003 420 24 20	13.0460-3990.2	603990	A 004 430 09 01	03.2023-0166.3	010015
A 002 420 37 20	13.0460-4202.2	604202	A 003 420 30 20	13.0460-4047.2	604047	A 004 430 12 01	24.2123-0901.3	010382
A 002 420 46 20	13.0460-4047.2	604047	A 003 420 30 20	13.0470-4047.2	LD4047	A 004 430 17 01	24.2022-1601.3	010340
A 002 420 46 20	13.0470-4047.2	LD4047	A 003 420 33 83	13.2601-8036.2	210168	A 004 430 22 01	03.2126-0512.3	010217
A 002 420 49 18	03.3219-3401.3	020049	A 003 420 34 20	03.0137-4001.2	654001	A 004 430 23 01	03.2023-0166.3	010015
A 002 420 57 20	13.0460-6015.2	606015	A 003 420 34 83	13.2601-8037.2	210169	A 004 430 24 01	24.2022-1601.3	010340
A 002 420 58 20	03.0137-4001.2	654001	A 003 420 35 83	13.2601-8038.2	210170	A 004 430 25 01	03.2023-0166.3	010015
A 002 420 81 18	03.3241-1801.3	020130	A 003 420 36 20	13.0460-6031.2	606031	A 004 430 26 01	03.2025-0111.3	010033
A 002 420 88 18	03.3222-5804.3	020083	A 003 420 44 20	13.0460-6015.2	606015	A 004 430 28 01	03.2125-1902.3	010206
A 002 421 00 98	13.9574-7005.2	210275	A 003 420 48 20	13.0460-4047.2	604047	A 004 430 29 01	03.2125-2102.3	010207
A 002 421 01 98	13.9574-7006.2	210276	A 003 420 48 20	13.0470-4047.2	LD4047	A 004 430 30 01	03.2123-6002.3	010184
A 002 421 05 98	24.9260-8029.5	230043	A 003 420 49 20	13.0460-4047.2	604047	A 004 430 31 30	03.7760-2702.4	300090
A 002 421 06 98	24.9260-8030.5	230044	A 003 420 49 20	13.0470-4047.2	LD4047	A 004 430 33 01	03.2023-0230.3	010019
A 002 421 18 98	24.9260-8025.5	230041	A 003 420 74 20	13.0460-6031.2	606031	A 004 430 34 01	03.2023-0825.3	010028
A 002 421 19 98	24.9260-8026.5	230042	A 003 420 77 20	13.0460-6015.2	606015	A 004 430 35 30	03.7760-2702.4	300090
A 002 421 23 98	24.9260-8025.5	230041	A 003 420 77 20 ¹⁰	13.0460-6015.2	606015	A 004 430 38 01	03.2025-0211.3	010034
A 002 421 24 98	24.9260-8026.5	230042	A 003 421 00 98	24.9260-8029.5	230043	A 004 430 39 01	03.2023-0825.3	010028
A 002 421 28 98	13.2601-8027.2	210159	A 003 421 01 98	24.9260-8030.5	230044	A 004 430 48 01	24.2133-0901.3	010387
A 002 421 29 98	13.2601-8028.2	210160	A 003 421 06 98	24.9260-8029.5	230043	A 004 430 50 01	03.2130-0102.3	010221
A 002 421 30 98	24.9260-8029.5	230043	A 003 421 07 98	24.9260-8030.5	230044	A 004 430 53 01	03.2130-0102.3	010221



Vergleichsliste

Cross reference list - Tabella di conversione codici



Liste des correspondances - Lista referencias

MERCEDES BENZ 			MERCEDES BENZ 			MERCEDES BENZ 		
A 004 430 55 01	03.2025-0211.3	010034	A 115 420 26 85	24.3727-0407.2	580407	A 126 420 04 83	13.2381-8029.2	210035
A 004 430 75 01	03.2025-0211.3	010034	A 115 420 27 85	24.3727-0407.2	580407	A 126 420 05 83	13.2381-8030.2	210036
A 005 420 17 20	13.0460-3805.2	603805	A 115 421 11 12	24.0113-0112.1	413112	A 126 420 06 83	13.2571-8023.2	210127
A 005 420 17 20	13.0470-3805.2	LD3805	A 115 421 13 12	24.0113-0113.1	413113	A 126 420 07 83	13.2571-8024.2	210128
A 005 420 78 18	03.3222-7802.3	020088	A 115 421 14 12	24.0113-0137.1	413137	A 126 420 16 85	24.3727-0416.2	580416
A 005 420 79 18	24.3223-1705.3	020418	A 115 423 02 12	24.0110-0185.1	410185	A 126 420 17 85	24.3727-0417.2	580417
A 005 420 81 18	24.3215-0902.3	020153	A 115 423 04 12	24.0110-0185.1	410185	A 126 421 00 12	24.0122-0116.1	422116
A 005 420 98 20	13.0460-4401.2	604401	A 116 420 00 83	24.9260-8025.5	230041	A 126 421 04 12	24.0128-0102.1	428102
A 005 430 24 01	03.2023-0825.3	010028	A 116 420 01 72	24.0122-0106.1	422106	A 126 421 05 12	24.0128-0102.1	428102
A 005 430 26 01	03.2023-0230.3	010019	A 116 420 01 83	24.9260-8026.5	230042	A 126 423 00 12	24.0110-0185.1	410185
A 005 430 54 01	03.2026-0512.3	010038	A 116 420 02 05	24.0122-0106.1	422106	A 126 428 01 35	83.6204-0282.3	330309
A 005 430 55 01	03.2026-0462.3	010728	A 116 428 01 35	83.6204-0280.3	330732	A 126 428 03 35	83.7704-0281.3	330804
A 005 430 59 01	24.2022-1601.3	010340	A 123 420 00 72	24.0113-0137.1	413137	A 126 540 20 17	24.8190-0401.2	620401
A 005 430 69 01	03.2026-0462.3	010728	A 123 420 01 20	03.0137-0171.2	650171	A 126 997 02 32	03.3517-5100.1	390326
A 005 586 72 42	13.0460-6027.2	606027	A 123 420 01 83	24.9260-8029.5	230043	A 129 420 00 83	24.9442-8003.5	230053
A 006 420 15 18	03.2524-0400.3	040024	A 123 420 02 83	24.9260-8030.5	230044	A 129 420 01 83	24.9442-8004.5	230054
A 006 421 17 98	13.4441-8015.2	210263	A 123 420 02 85	24.3727-0403.2	580403	A 129 420 02 83	24.9238-8035.5	230025
A 006 421 18 98	13.4441-8016.2	210264	A 123 420 03 83	24.9260-8029.5	230043	A 129 420 03 83	24.9238-8036.5	230026
A 006 421 21 98	13.4441-8013.2	210261	A 123 420 04 83	24.9260-8030.5	230044	A 129 420 08 85	24.3727-0468.2	580468
A 006 421 22 98	13.4441-8014.2	210262	A 123 420 04 85	24.3727-0401.2	580401	A 129 420 09 85	24.3727-0469.2	580469
A 006 421 23 98	13.4441-8013.2	210261	A 123 420 05 83	13.2381-8027.2	210033	A 129 420 26 85	24.3727-0464.2	580464
A 006 421 24 98	13.4441-8014.2	210262	A 123 420 05 85	24.3727-0402.2	580402	A 129 420 27 85	24.3727-0464.2	580464
A 006 421 29 98	13.4441-8015.2	210263	A 123 420 06 83	13.2381-8028.2	210034	A 129 421 02 12	24.0122-0123.1	422123
A 006 421 30 98	13.4441-8016.2	210264	A 123 420 07 83	13.2381-8027.2	210033	A 129 421 03 12	24.0122-0123.1	422123
A 006 421 31 98	13.4441-8015.2	210263	A 123 420 08 83	13.2381-8028.2	210034	A 129 421 06 12	24.0128-0103.1	428103
A 006 421 32 98	13.4441-8016.2	210264	A 123 420 09 83	13.2381-8027.2	210033	A 129 421 10 12	24.0128-0103.1	428103
A 007 420 09 18	24.3217-1109.3	020173	A 123 420 10 83	13.2381-8028.2	210034	A 129 421 15 12	24.0130-0121.1	430121
A 007 420 21 18	03.2524-0400.3	040024	A 123 420 11 83	13.2421-8021.2	210057	A 129 421 16 12	24.0130-0122.1	430122
A 007 421 03 98	13.2601-7015.2	210230	A 123 420 11 83	24.9242-8021.5	230031	A 129 421 17 12	24.0130-0121.1	430121
A 007 421 04 98	13.2601-8037.2	210169	A 123 420 12 83	24.9242-8022.5	230032	A 129 421 18 12	24.0130-0122.1	430122
A 007 421 05 98	13.2601-7016.2	210231	A 123 420 14 83	13.2381-8027.2	210033	A 129 421 20 12	24.0128-0103.1	428103
A 007 421 06 98	13.2601-8038.2	210170	A 123 420 15 83	13.2381-8028.2	210034	A 129 423 00 12	24.0109-0103.1	409103
A 007 421 15 98	13.4441-8015.2	210263	A 123 421 00 12	24.0113-0137.1	413137	A 129 423 03 12	24.0122-0218.1	422218
A 007 421 16 98	13.4441-8016.2	210264	A 123 428 01 35	83.7704-0281.3	330804	A 129 428 00 35	24.5101-0346.3	331406
A 007 421 83 98	13.4441-8013.2	210261	A 123 428 02 35	83.6104-0360.3	330475	A 140 420 00 48	24.5113-0540.3	331301
A 007 421 84 98	13.4441-8014.2	210262	A 123 428 03 35	24.5170-0426.3	331452	A 140 420 04 20	03.0137-0244.2	650244
A 008 420 24 18	24.3222-1732.3	020537	A 123 428 05 35	24.5170-0426.3	331452	A 140 420 08 20	03.0137-0244.2	650244
A 008 420 42 18	24.3215-0902.3	020153	A 123 428 06 35	24.5101-0346.3	331406	A 140 420 09 20	03.0137-0244.2	650244
A 008 420 43 18	24.3217-1109.3	020173	A 123 540 00 17	24.8190-0401.2	620401	A 140 420 09 85	24.3727-0456.2	580456
A 008 420 44 18	24.3222-1732.3	020537	A 124 420 00 83	24.9238-8035.5	230025	A 140 420 10 85	24.3727-0455.2	580455
A 008 421 18 98	13.4441-8013.2	210261	A 124 420 01 48	83.6154-0526.3	330285	A 140 420 18 85	24.3727-0462.2	580462
A 008 421 19 98	13.4441-8014.2	210262	A 124 420 01 83	24.9238-8036.5	230026	A 140 420 19 85	24.3727-0456.2	580456
A 008 421 20 98	13.4441-8013.2	210261	A 124 420 02 83	24.9235-8005.5	230023	A 140 420 20 85	24.3727-0455.2	580455
A 008 421 21 98	13.4441-8014.2	210262	A 124 420 03 20	03.0137-0170.2	650170	A 140 420 38 85	24.3727-0462.2	580462
A 009 420 11 18	24.3222-1732.3	020537	A 124 420 03 83	24.9235-8006.5	230024	A 140 420 44 85	24.3727-0462.2	580462
A 009 420 15 18	24.3244-0904.3	020301	A 124 420 05 20	03.0137-0170.2	650170	A 140 421 02 12	24.0130-0100.1	430100
A 009 420 70 18	24.3244-0904.3	020301	A 124 420 07 20	03.0137-0170.2	650170	A 140 421 03 12	24.0128-0127.1	428127
A 009 420 82 18	03.3222-5804.3	020083	A 124 420 10 85	24.3727-0411.2	580411	A 140 421 09 12	24.0130-0100.1	430100
A 009 420 83 18	03.3222-7802.3	020088	A 124 420 11 85	24.3727-0409.2	580409	A 140 421 10 12	24.0130-0100.1	430100
A 009 420 84 18	24.3223-1705.3	020418	A 124 420 26 85	24.3727-0411.2	580411	A 140 423 04 12	24.0122-0133.1	422133
A 010 420 08 18	24.3244-0904.3	020301	A 124 421 00 71	13.8190-0242.1	990124	A 140 423 06 12	24.0112-0129.1	412129
A 011 420 00 18	24.3222-1732.3	020537	A 124 421 01 71	13.8190-0330.1	990134	A 140 540 12 17	24.8190-0401.2	620401
A 011 420 01 18	24.3222-1732.3	020537	A 124 421 05 71	13.8190-0330.1	990134	A 201 290 00 11	24.2523-1210.3	040105
A 011 420 16 18	24.3244-0904.3	020301	A 124 421 13 12	24.0112-0117.1	412117	A 201 290 01 11	24.2523-1210.3	040105
A 011 420 88 18	24.3217-1109.3	020173	A 124 421 14 12	24.0122-0134.1	422134	A 201 290 03 11	24.2523-1210.3	040105
A 107 420 00 83	13.2601-8034.2	210166	A 124 421 15 12	24.0122-0136.1	422136	A 201 290 04 11	24.2523-1310.3	040106
A 107 420 01 83	13.2601-8033.2	210165	A 124 421 16 12	24.0122-0123.1	422123	A 201 290 05 11	24.2523-1310.3	040106
A 107 420 02 83	13.2601-8027.2	210159	A 124 421 23 12	24.0122-0134.1	422134	A 201 420 00 83	24.9235-8005.5	230023
A 107 420 03 83	13.2601-8028.2	210160	A 124 421 24 12	24.0125-0107.1	425107	A 201 420 01 83	24.9235-8006.5	230024
A 107 420 04 83	24.9440-8027.5	230051	A 124 421 26 12	24.0128-0103.1	428103	A 201 420 02 83	24.9235-8005.5	230023
A 107 420 05 83	24.9440-8028.5	230052	A 124 421 27 12	24.0122-0123.1	422123	A 201 420 03 83	24.9235-8006.5	230024
A 108 423 02 12	24.0110-0185.1	410185	A 124 423 05 12	24.0109-0114.1	409114	A 201 420 04 83	24.9235-8005.5	230023
A 110 420 00 72	24.0113-0111.1	413111	A 124 423 05 12	24.0309-0114.1	509114	A 201 420 04 85	24.3727-0410.2	580410
A 110 421 01 12	24.0113-0111.1	413111	A 124 423 06 12	24.0120-0199.1	420199	A 201 420 05 83	24.9235-8006.5	230024
A 114 421 00 12	24.0113-0137.1	413137	A 124 423 08 12	24.0124-0188.1	424188	A 201 420 06 85	24.3727-0409.2	580409
A 115 290 01 15	03.3508-1706.3	310024	A 124 423 10 12	24.0120-0199.1	420199	A 201 420 07 85	24.3727-0409.2	580409
A 115 420 00 72	24.0110-0185.1	410185	A 126 423 00 05	24.0122-0116.1	422116	A 201 421 08 12	24.0111-0137.1	411137
A 115 420 01 72	24.0113-0112.1	413112	A 126 420 00 83	24.9260-8031.5	230045	A 201 421 12 12	24.0111-0137.1	411137
A 115 420 02 72	24.0113-0113.1	413113	A 126 420 01 20	03.0137-0171.2	650171	A 201 421 13 12	24.0122-0124.1	422124
A 115 420 16 85	24.3727-0406.2	580406	A 126 420 01 72	24.0122-0116.1	422116	A 201 421 15 12	24.0122-0124.1	422124
A 115 420 20 85	24.3727-0407.2	580407	A 126 420 01 83	24.9260-8032.5	230046	A 201 423 09 12	24.0109-0120.1	409120

Vergleichsliste

Cross reference list - Tabella di conversione codici



Liste des correspondances - Lista referencias

MERCEDES BENZ			MERCEDES BENZ			MERCEDES BENZ		
A 201 423 09 12	24.0309-0120.1	509120	A 435 421 12 98	13.2601-7015.2	210230	A 608 430 07 01	03.2123-3302.3	010180
A 201 423 11 12	24.0109-0120.1	409120	A 435 421 13 98	13.2601-7016.2	210231	A 608 431 00 49	03.3304-0700.1	390082
A 201 423 11 12	24.0309-0120.1	509120	A 435 421 14 98	13.2601-8037.2	210169	A 608 545 00 09	24.3526-0810.3	340037
A 201 423 12 12	24.0109-0120.1	409120	A 435 421 15 98	13.2601-8038.2	210170	A 631 290 00 12	24.2419-1729.3	030118
A 201 423 12 12	24.0309-0120.1	509120	A 435 542 00 17	24.8190-0403.2	620403	A 631 420 00 18	24.3225-1102.3	020318
A 201 540 03 17	24.8190-0402.2	620402	A 437 421 01 98	13.4571-8005.3	210205	A 631 420 00 82	13.0460-0918.2	610918
A 202 290 00 11	24.2523-1310.3	040106	A 437 421 02 98	13.4571-8006.3	210206	A 631 420 01 20	13.0460-3945.2	603945
A 202 290 01 12	24.2419-1703.3	030097	A 437 421 04 98	13.9574-7005.2	210275	A 631 420 03 20	13.0460-3945.2	603945
A 202 423 00 12	24.0109-0120.1	409120	A 437 421 05 98	13.9574-7006.2	210276	A 631 420 03 72	24.0116-0107.2	416107
A 202 423 00 12	24.0309-0120.1	509120	A 437 421 07 98	13.4571-8005.3	210205	A 631 420 04 83	24.3481-1759.5	240339
A 203 423 01 12	24.0109-0114.1	409114	A 437 421 08 98	13.4571-8006.3	210206	A 631 420 05 83	24.3481-1759.5	240339
A 203 423 01 12	24.0309-0114.1	509114	A 437 421 10 98	13.9574-7005.2	210275	A 631 420 10 83	24.3481-1759.5	240339
A 210 423 01 12	24.0109-0114.1	409114	A 437 421 11 98	13.9574-7006.2	210276	A 631 420 11 83	24.3481-1759.5	240339
A 210 423 01 12	24.0309-0114.1	509114	A 437 421 12 98	13.9571-0003.2	210277	A 631 420 12 85	24.3727-0415.2	580415
A 210 423 04 12	24.0109-0114.1	409114	A 437 421 13 98	13.9571-0004.2	210278	A 631 420 19 85	24.3727-0414.2	580414
A 210 423 04 12	24.0309-0114.1	509114	A 437 421 14 98	13.9574-7005.2	210275	A 631 420 20 85	24.3727-0413.2	580413
A 210 423 09 12	24.0109-0114.1	409114	A 437 421 15 98	13.9574-7006.2	210276	A 631 420 21 85	24.3727-0415.2	580415
A 310 420 00 18	24.3238-0901.3	020298	A 437 421 16 98	13.9571-0003.2	210277	A 631 420 32 83	24.3481-1759.5	240339
A 310 420 03 18	24.3238-0901.3	020298	A 437 421 17 98	13.9571-0004.2	210278	A 631 420 33 83	24.3481-1759.5	240339
A 310 420 05 18	24.3238-0901.3	020298	A 437 421 18 98	13.9574-7005.2	210275	A 631 423 00 01	24.0225-4003.1	480049
A 310 420 08 18	24.3238-0901.3	020298	A 437 421 19 98	13.9574-7006.2	210276	A 631 423 00 07	03.0137-0245.2	650245
A 316 420 01 18	03.3241-1801.3	020130	A 437 421 20 98	13.2601-0146.2	210248	A 631 423 00 88	03.0137-9145.2	650245
A 316 420 02 18	03.3241-1801.3	020130	A 437 421 21 98	13.2601-0145.2	210247	A 631 423 01 07	03.0137-0245.2	650245
A 405 421 00 98	13.2601-0145.2	210247	A 437 421 22 98	13.2544-0019.2	210251	A 631 428 00 35	24.5232-0388.3	330580
A 405 421 01 98	13.2601-0146.2	210248	A 437 421 23 98	13.2544-0020.2	210252	A 631 430 11 01	24.2125-1719.3	010666
A 405 421 02 98	13.2544-0019.2	210251	A 437 421 25 98	13.2544-0019.2	210251	A 667 290 02 12	24.2419-0933.3	030059
A 405 421 03 98	13.2544-0020.2	210252	A 437 421 26 98	13.2544-0020.2	210252	A 667 420 29 01	13.4441-8013.2	210261
A 405 421 06 98	13.2544-0019.2	210251	A 440 421 00 98	13.2601-8035.2	210167	A 667 420 30 01	13.4441-8014.2	210262
A 405 421 07 98	13.2544-0020.2	210252	A 440 421 01 98	13.2601-8036.2	210168	A 667 420 31 01	13.4441-8013.2	210261
A 415 423 00 23	03.0137-9228.2	669228	A 440 421 02 98	13.2601-8037.2	210169	A 667 420 32 01	13.4441-8014.2	210262
A 416 421 00 98	13.2601-8035.2	210167	A 440 421 03 98	13.2601-8038.2	210170	A 667 420 35 01	13.4441-8013.2	210261
A 416 421 01 98	13.2601-8037.2	210169	A 460 295 00 06	24.2419-0942.3	030068	A 667 420 36 01	13.4441-8014.2	210262
A 416 421 02 98	13.9544-0022.2	210258	A 460 420 00 20	13.0460-4401.2	604401	A 667 420 37 01	13.4441-8013.2	210261
A 416 421 03 98	13.9544-0021.2	210257	A 460 420 50 48	24.5224-0460.3	331264	A 667 420 38 01	13.4441-8014.2	210262
A 416 421 04 98	13.2601-8038.2	210170	A 460 421 00 12	24.0116-0133.1	416133	A 667 420 47 01	13.4441-8017.2	210265
A 416 421 05 98	13.2601-8036.2	210168	A 460 428 51 35	24.5165-0450.3	331259	A 667 420 48 01	13.4441-8018.2	210266
A 416 421 06 98	13.9544-0022.2	210258	A 460 428 54 35	24.5224-0460.3	331264	A 667 428 01 35	83.6104-0470.3	330253
A 416 421 07 98	13.9544-0021.2	210257	A 460 540 06 17	24.8190-0406.2	620406	A 668 420 01 18	03.3230-0401.3	020115
A 418 421 01 98	13.2544-0019.2	210251	A 461 420 07 02	13.9441-0041.2	210279	A 668 420 02 18	03.3230-0401.3	020115
A 418 421 02 98	13.2544-0020.2	210252	A 461 420 08 02	13.9441-0042.2	210280	A 668 420 03 18	03.3230-0401.3	020115
A 418 421 15 98	13.2601-0145.2	210247	A 461 421 00 12	24.0116-0133.1	416133	A 668 421 01 12	24.0130-0198.1	430198
A 418 421 16 98	13.2601-0146.2	210248	A 463 420 50 85	24.3727-0477.2	580477	A 668 421 02 12	24.0130-0103.1	430103
A 419 421 00 98	13.2601-8035.2	210167	A 463 420 51 85	24.3727-0476.2	580476	A 668 421 06 12	24.0130-0198.1	430198
A 419 421 01 98	13.2601-8037.2	210169	A 463 421 00 12	24.0130-0217.1	430217	A 669 420 00 20	13.0460-6015.2	606015
A 419 421 02 98	13.2601-8036.2	210168	A 463 421 01 12	24.0130-0217.1	430217	A 669 420 01 20	13.0460-6015.2	606015
A 419 421 03 98	13.2601-8038.2	210170	A 463 421 03 12	24.0130-0217.1	430217	A 669 421 01 12	24.0130-0198.1	430198
A 419 421 04 98	13.9544-0022.2	210258	A 601 420 00 72	24.0116-0100.1	416100	A 669 421 06 12	24.0130-0198.1	430198
A 419 421 05 98	13.9544-0021.2	210257	A 601 420 01 72	24.0122-0140.1	422140	A 669 540 04 17	24.8190-0415.2	620415
A 419 421 06 98	13.2601-8035.2	210167	A 601 420 02 72	24.0116-0100.1	416100	A 669 540 05 17	24.8190-0415.2	620415
A 419 421 07 98	13.2601-8036.2	210168	A 601 420 03 72	24.0122-0140.1	422140	A 669 540 06 17	24.8190-0415.2	620415
A 419 421 08 98	13.2601-8037.2	210169	A 601 420 11 85	24.3727-0420.2	580420	A 670 420 01 18	03.3231-3401.3	020120
A 419 421 09 98	13.2601-8038.2	210170	A 601 420 33 85	24.3727-0459.2	580459	A 670 420 02 18	03.3231-3401.3	020120
A 419 421 10 98	13.9544-0021.2	210257	A 601 420 34 85	24.3727-0460.2	580460	A 670 420 03 18	03.3231-3401.3	020120
A 419 421 11 98	13.9544-0022.2	210258	A 601 420 36 85	24.3727-0459.2	580459	A 670 420 28 20	13.0460-6015.2	606015
A 427 421 00 98	13.2601-8035.2	210167	A 601 420 37 85	24.3727-0460.2	580460	A 670 421 01 12	24.0130-0103.1	430103
A 427 421 01 98	13.2601-8037.2	210169	A 601 420 46 85	24.3727-0459.2	580459	A 670 421 03 12	24.0130-0103.1	430103
A 427 421 02 98	13.2601-8036.2	210168	A 601 420 47 85	24.3727-0460.2	580460	A 901 420 01 20	03.0137-4001.2	654001
A 427 421 03 98	13.2601-8038.2	210170	A 601 420 76 20	13.0460-4401.2	604401	A 901 420 03 20	03.0137-4001.2	654001
A 427 421 04 98	13.9544-0022.2	210258	A 601 420 87 20	13.0460-4401.2	604401	A 901 420 05 20	03.0137-4001.2	654001
A 427 421 05 98	13.9544-0021.2	210257	A 601 421 03 12	24.0122-0140.1	422140	A 901 540 00 17	24.8190-0407.2	620407
A 427 421 17 98	13.9574-7005.2	210275	A 601 421 04 12	24.0116-0100.1	416100	A 901 540 01 17	24.8190-0407.2	620407
A 427 421 18 98	13.9574-7006.2	210276	A 601 421 05 12	24.0122-0140.1	422140	A 902 423 01 12	24.0116-0110.1	416110
A 427 421 19 98	13.2601-8035.2	210167	A 601 421 50 12	24.0116-0100.1	416100	A 902 423 03 12	24.0116-0110.1	416110
A 427 421 20 98	13.2601-8036.2	210168	A 601 421 51 12	24.0116-0100.1	416100	A 902 423 04 12	24.0116-0110.1	416110
A 427 421 21 98	13.2601-8037.2	210169	A 601 423 50 01	24.0226-0001.1	480050	A 902 423 05 12	24.0116-0110.1	416110
A 427 421 22 98	13.2601-8038.2	210170	A 601 423 51 01	24.0223-0009.1	480039	A 905 420 00 20	13.0460-6015.2	606015
A 427 421 23 98	13.9544-0021.2	210257	A 601 586 00 42	13.0460-4401.2	604401			
A 427 421 24 98	13.9544-0022.2	210258	A 603 420 00 18	24.3222-1733.3	020538			
A 435 421 04 98	13.9544-0021.2	210257	A 608 420 03 18	03.3222-4401.3	020076			
A 435 421 05 98	13.9544-0022.2	210258	A 608 428 00 35	83.6123-0465.3	330379</			

Vergleichsliste

Cross reference list - Tabella di conversione codici



Liste des correspondances - Lista referencias

 MG ROVER		 MITSUBISHI		 MITSUBISHI				
SFP100520	13.0470-3605.2	LD3605	MB668083	24.0110-0240.1	410240	MR249965	24.3431-1702.5	240438
SXS100000	03.0137-9701.2	669701	MB668108	24.0124-0142.1	424142	MR370775	24.3431-1701.5	240437
MINI			MB668336	03.0137-0288.2	650288	MR370776	24.3431-1702.5	240438
34 11 0 141 338	11.0101-5402.2	260009	MB668337	03.0137-0288.2	650288	MR389541	13.0460-5952.2	605952
34 11 0 141 349	11.8171-0008.1	990049	MB668338	03.0137-0288.2	650288	MR389546	13.0460-5958.2	605958
MITSUBISHI			MB668745	03.0137-0255.2	650255	MR389548	13.0460-5958.2	605958
4605A458	13.0460-5744.2	605744	MB668746	03.0137-0255.2	650255	MR389549	13.0460-5958.2	605958
4605A492	13.0460-5958.2	605958	MB669172	03.0137-0255.2	650255	MR389569	13.0460-5826.2	605826
MB058553	24.3219-1716.3	020071	MB669173	24.3541-1815.5	240383	MR389578	13.0460-5980.2	605980
MB150810	24.0120-0139.1	420139	MB669174	24.3541-1816.5	240384	MR389599	13.0460-0235.2	610235
MB151387	24.0120-0130.1	420130	MB669177	13.0460-5952.2	605952	MR449769	24.0118-0120.1	418120
MB193411	24.3219-1716.3	020071	MB669266	13.0460-5952.2	605952	MR493392	24.3223-1712.3	020571
MB238076	24.0113-0159.1	413159	MB669280	24.0113-0186.1	413186	MR493393	24.3223-1713.3	020572
MB238114	03.0137-0188.2	650188	MB669281	24.0113-0186.1	413186	MR569597	13.0460-5958.2	605958
MB238495	24.0120-0139.1	420139	MB669282	24.0118-0120.1	418120	MZ690007	13.0460-5958.2	605958
MB238520	03.0137-0188.2	650188	MB669283	24.0118-0120.1	418120	MZ690010	13.0460-5980.2	605980
MB238521	03.0137-0188.2	650188	MB669291	24.0220-3017.1	480108	MZ690343	13.0460-5826.2	605826
MB238522	03.0137-0188.2	650188	MB669334	03.0137-0289.2	650289	X3511002	13.0460-5952.2	605952
MB238523	03.0137-0188.2	650188	MB669335	03.0137-0289.2	650289	X3511003	13.0460-5958.2	605958
MB238615	24.0118-0109.1	418109	MB669336	03.0137-0289.2	650289	X3516001	13.0460-5980.2	605980
MB316529	24.0220-3018.2	480121	MB669464	13.0460-5953.2	605953	X3516003	13.0460-5826.2	605826
MB316558	24.0220-3018.2	480121	MB669473	13.0460-0233.2	610233	NISSAN		
MB316676	24.0113-0159.1	413159	MB669474	13.0460-5953.2	605953	30770-62Y01	24.3728-1703.2	591703
MB316677	24.0118-0109.1	418109	MB857336	13.0460-5980.2	605980	30770-62Y10	24.3728-1703.2	591703
MB366080	24.0124-0114.1	424114	MB857762	24.0110-0266.1	410266	30770-94J11	24.3728-1706.2	591706
MB366434	24.0118-0109.1	418109	MB857763	24.0110-0266.1	410266	36402-50J10	24.3727-1701.2	581701
MB366443	03.0137-0216.2	650216	MB857978	24.0110-0240.1	410240	36402-70J00	24.3727-1701.2	581701
MB366444	03.0137-0216.2	650216	MB858375	13.0460-5952.2	605952	36530-51Y10	24.3727-1711.2	581711
MB366445	03.0137-0216.2	650216	MB858380	13.0460-5980.2	605980	36530-71J10	24.3727-1708.2	581708
MB366446	03.0137-0216.2	650216	MB858398	13.0460-0235.2	610235	36531-71J10	24.3727-1709.2	581709
MB407030	24.0122-0155.1	422155	MB858400	24.3431-1705.5	240365	40206-00Q0D	24.0120-0125.1	420125
MB407639	24.0124-0136.1	424136	MB858405	24.3431-1706.5	240366	40206-00Q0E	24.0121-0106.1	421106
MB500555	24.0110-0238.1	410238	MB858583	13.0460-5952.2	605952	40206-00Q0K	24.0121-0106.1	421106
MB500556	24.0110-0238.1	410238	MB858665	03.0137-0255.2	650255	40206-00QAA	24.0121-0106.1	421106
MB500738	24.3223-1712.3	020571	MB858666	03.0137-0216.2	650216	40206-00QAJ	24.0120-0125.1	420125
MB500739	24.3223-1713.3	020572	MB858667	03.0137-0216.2	650216	40206-01B00	24.0112-0121.1	412121
MB500807	13.0460-0335.2	610335	MB858668	03.0137-0216.2	650216	40206-01B01	24.0112-0121.1	412121
MB500813	13.0460-5940.2	605940	MB858669	03.0137-0216.2	650216	40206-04C01	24.0122-0167.1	422167
MB500816	13.0460-5940.2	605940	MB858685	03.0137-0255.2	650255	40206-05A00	24.0112-0115.1	412115
MB500819	13.0460-5940.2	605940	MB858686	03.0137-0255.2	650255	40206-05A01	24.0112-0115.1	412115
MB500968	24.0124-0114.1	424114	MB858799	24.0124-0144.1	424144	40206-0F000	24.0126-0109.1	426109
MB500969	24.0124-0114.1	424114	MB895072	13.0460-5952.2	605952	40206-0F001	24.0126-0109.1	426109
MB515996	24.0220-3018.2	480121	MB895250	13.0460-5952.2	605952	40206-10W00	24.0122-0180.1	422180
MB534318	24.3571-1737.5	240387	MB928067	13.0460-5958.2	605958	40206-10W01	24.0122-0180.1	422180
MB534319	24.3571-1738.5	240388	MB928314	13.0460-5980.2	605980	40206-15E00	24.0122-0129.1	422129
MB534594	03.0137-0216.2	650216	MB928697	13.0460-5826.2	605826	40206-15E01	24.0122-0129.1	422129
MB534595	03.0137-0216.2	650216	MB928816	24.0124-0140.1	424140	40206-21B01	24.0112-0139.1	412139
MB534596	03.0137-0216.2	650216	MB928817	13.0460-5953.2	605953	40206-27B01	24.0115-0106.1	415106
MB534597	03.0137-0216.2	650216	MB928818	13.0460-5953.2	605953	40206-2F500	24.0122-0179.1	422179
MB534653	13.0460-5980.2	605980	MB928995	24.0124-0136.1	424136	40206-2F501	24.0122-0179.1	422179
MB587432	24.0110-0243.1	410243	MB950064	03.0137-0289.2	650289	40206-2L903	24.0122-0174.1	422174
MB587433	24.0110-0243.1	410243	MB950065	03.0137-0288.2	650288	40206-31G00	24.0126-0109.1	426109
MB58758	24.0220-3017.1	480108	MB950176	24.3431-1701.5	240437	40206-31G01	24.0126-0109.1	426109
MB587659	03.0137-0188.2	650188	MB950177	24.3431-1702.5	240438	40206-35G00	24.0122-0180.1	422180
MB587660	03.0137-0188.2	650188	MB950211	03.0137-0452.2	650452	40206-35G01	24.0122-0180.1	422180
MB587661	03.0137-0188.2	650188	MB950922	24.0118-0120.1	418120	40206-37J01	24.0120-0119.1	420119
MB597721	13.0460-5940.2	605940	MN102611	13.0460-5958.2	605958	40206-54C01	24.0126-0112.1	426112
MB618192	03.0137-0289.2	650289	MN102634	03.0137-0452.2	650452	40206-55F01	24.0122-0179.1	422179
MB618193	03.0137-0289.2	650289	MN116923	13.0460-5958.2	605958	40206-55F03	24.0122-0179.1	422179
MB618194	03.0137-0289.2	650289	MR128153	24.0124-0136.1	424136	40206-58A00	24.0118-0107.1	418107
MB618344	24.0124-0144.1	424144	MR129103	13.0460-5958.2	605958	40206-58A01	24.0118-0107.1	418107
MB618716	24.0124-0140.1	424140	MR129104	13.0460-5958.2	605958	40206-60Y01	24.0118-0107.1	418107
MB618734	24.0118-0112.1	418112	MR129648	24.0124-0140.1	424140	40206-61A01	24.0112-0123.1	412123
MB618735	24.0118-0112.1	418112	MR129649	24.0124-0140.1	424140	40206-61A11	24.0112-0123.1	412123
MB618737	24.0113-0183.1	413183	MR205377	13.0460-5826.2	605826	40206-71E01	24.0122-0146.1	422146
MB618799	24.0124-0142.1	424142	MR205584	24.0124-0136.1	424136	40206-71E02	24.0122-0146.1	422146
MB618981	24.3219-1752.3	020505	MR205585	24.0124-0136.1	424136	40206-71E05	24.0122-0146.1	422146
			MR249357	24.0110-0266.1	410266	40206-71E06	24.0122-0146.1	422146
			MR249964	24.3431-1701.5	240437	40206-88E01	24.0122-0174.1	422174

Vergleichsliste

Cross reference list - Tabella di conversione codici



Liste des correspondances - Lista referencias

NISSAN		NISSAN		NISSAN				
40206-88E03	24.0122-0174.1	422174	41060-60S85	13.0460-5937.2	605937	43206-99J01	24.0110-0215.1	410215
40206-88E04	24.0122-0174.1	422174	41060-60S87	13.0460-5937.2	605937	43206-VB000	24.0118-0136.1	418136
40206-88E05	24.0122-0174.1	422174	41060-61A86	13.0460-5963.2	605963	44001-70J00	24.3344-1702.5	240088
40206-90J01	24.0120-0152.1	420152	41060-62A90	13.0460-5963.2	605963	44011-70J00	24.3344-1701.5	240087
40206-93J00	24.0122-0146.1	422146	41060-62A92	13.0460-5963.2	605963	44060-05N25	03.0137-0310.2	650310
40206-93J01	24.0122-0146.1	422146	41060-62C90	13.0460-5941.2	605941	44060-08G25	03.0137-0310.2	650310
40206-C7000	24.0120-0119.1	420119	41060-63C90	13.0460-5941.2	605941	44060-0F026	03.0137-0376.2	650376
40206-C7001	24.0120-0119.1	420119	41060-63Y90	13.0460-5941.2	605941	44060-0F027	03.0137-0376.2	650376
40206-G9500	24.0120-0119.1	420119	41060-67A90	13.0460-5963.2	605963	44060-0N690	13.0460-5983.2	605983
40206-Y9503	24.0122-0167.1	422167	41060-71J25	13.0460-5950.2	605950	44060-0W725	03.0137-0319.2	650319
41001-60Y00	24.3481-1726.5	240188	41060-71J26	13.0460-5950.2	605950	44060-0W726	03.0137-0319.2	650319
41001-60Y01	24.3481-1726.5	240188	41060-72J25	13.0460-5949.2	605949	44060-0W727	03.0137-0319.2	650319
41001-60Y02	24.3481-1726.5	240188	41060-80N90	13.0460-5933.2	605933	44060-16C25	03.0137-0310.2	650310
41060-01A25	13.0460-5963.2	605963	41060-89A90	13.0460-5963.2	605963	44060-16C26	03.0137-0310.2	650310
41060-01A85	13.0460-5963.2	605963	41060-89A91	13.0460-5963.2	605963	44060-20J25	03.0137-0297.2	650297
41060-04B25	13.0460-5962.2	605962	41060-9C125	13.0460-5959.2	605959	44060-28N25	03.0137-0310.2	650310
41060-04B90	13.0460-5962.2	605962	41060-9C525	13.0460-5959.2	605959	44060-2S425	03.0137-0310.2	650310
41060-04C85	13.0460-5937.2	605937	41060-9C526	13.0460-5959.2	605959	44060-37G25	03.0137-0319.2	650319
41060-05B25	13.0460-5962.2	605962	41060-A1987	13.0460-5937.2	605937	44060-3F025	13.0460-5986.2	605986
41060-05B26	13.0460-5962.2	605962	41060-BM425	13.0460-5950.2	605950	44060-3F085	13.0460-5986.2	605986
41060-05B90	13.0460-5962.2	605962	41060-C7025	13.0460-5960.2	605960	44060-47L25	03.0137-0210.2	650210
41060-08N90	13.0460-5957.2	605957	41060-C8186	13.0460-5960.2	605960	44060-47L26	03.0137-0210.2	650210
41060-08N91	13.0460-5957.2	605957	41060-D4690	13.0460-5937.2	605937	44060-48L25	03.0137-0210.2	650210
41060-08N92	13.0460-5957.2	605957	41060-G9800	13.0460-5960.2	605960	44060-48L26	03.0137-0210.2	650210
41060-09W25	13.0460-5937.2	605937	41060-T7893	13.0460-5960.2	605960	44060-50Y25	03.0137-0265.2	650265
41060-09W26	13.0460-5937.2	605937	41060-V5025	13.0460-5937.2	605937	44060-54C91	13.0460-5983.2	605983
41060-09W27	13.0460-5937.2	605937	41060-V5026	13.0460-5937.2	605937	44060-55L25	03.0137-0210.2	650210
41060-09W92	13.0460-5937.2	605937	41060-V5090	13.0460-5937.2	605937	44060-56L25	03.0137-0210.2	650210
41060-09W93	13.0460-5937.2	605937	41060-V5091	13.0460-5937.2	605937	44060-56L26	03.0137-0210.2	650210
41060-0H090	13.0460-5937.2	605937	41060-V5093	13.0460-5937.2	605937	44060-56L27	03.0137-0210.2	650210
41060-0H890	13.0460-5937.2	605937	41060-V5094	13.0460-5937.2	605937	44060-5M490	13.0460-5983.2	605983
41060-11P25	13.0460-5937.2	605937	41060-V5785	13.0460-5937.2	605937	44060-60Y25	03.0137-0210.2	650210
41060-11P26	13.0460-5937.2	605937	41060-V5787	13.0460-5937.2	605937	44060-63C90	13.0460-5983.2	605983
41060-11P29	13.0460-5937.2	605937	41060-V6786	13.0460-5937.2	605937	44060-70J26	13.0460-5986.2	605986
41060-11P85	13.0460-5937.2	605937	41060-V6787	13.0460-5937.2	605937	44060-70J28	03.0137-0276.2	650276
41060-11P86	13.0460-5937.2	605937	41060-V6790	13.0460-5937.2	605937	44060-70N25	03.0137-0210.2	650210
41060-11P91	13.0460-5937.2	605937	41060-V6791	13.0460-5937.2	605937	44060-73C91	13.0460-5983.2	605983
41060-11P92	13.0460-5937.2	605937	41060-V6793	13.0460-5937.2	605937	44060-75C90	13.0460-5983.2	605983
41060-11P93	13.0460-5937.2	605937	41060-V6794	13.0460-5937.2	605937	44060-78N91	13.0460-5983.2	605983
41060-11P94	13.0460-5937.2	605937	41060-V7085	13.0460-5957.2	605957	44060-87N90	13.0460-5983.2	605983
41060-13A25	13.0460-5963.2	605963	41060-V7091	13.0460-5957.2	605957	44060-9C025	03.0137-0269.2	650269
41060-13A90	13.0460-5963.2	605963	41060-VJ490	13.0460-5957.2	605957	44060-BM425	13.0460-5986.2	605986
41060-13E85	13.0460-5937.2	605937	41080-09G27	13.0460-0289.2	610289	44060-BM426	13.0460-5986.2	605986
41060-13E90	13.0460-5937.2	605937	41080-09G28	13.0460-0289.2	610289	44060-D5725	03.0137-0210.2	650210
41060-13V90	13.0460-5937.2	605937	41080-37J25	13.0460-0448.2	610448	44080-4U025	13.0460-0295.2	610295
41060-13V91	13.0460-5937.2	605937	41080-60Y25	13.0460-0336.2	610336	44080-54C25	13.0460-0295.2	610295
41060-16C90	13.0460-5937.2	605937	41080-C7126	13.0460-0448.2	610448	44080-58Y25	13.0460-0295.2	610295
41060-19V85	13.0460-5937.2	605937	41083-01B02	13.0460-0319.2	610319	44081-9C025	03.0137-9169.2	669169
41060-2F025	13.0460-5950.2	605950	41083-01B03	13.0460-0319.2	610319	44081-9C026	03.0137-9169.2	669169
41060-2S790	13.0460-5957.2	605957	41083-01B13	13.0460-0319.2	610319	44090-00QAD	03.0137-9228.2	669228
41060-2X825	13.0460-5959.2	605959	41083-09W20	13.0460-0322.2	610322	44090-37G10	03.0137-9290.2	669290
41060-31E85	13.0460-5937.2	605937	41083-41L10	13.0460-0322.2	610322	44090-9C025	03.0137-9169.2	669169
41060-31E87	13.0460-5937.2	605937	41083-Y9525	13.0460-0322.2	610322	44090-V0200	03.0137-9273.2	669273
41060-31E88	13.0460-5937.2	605937	41083-Y9526	13.0460-0322.2	610322	44091-70J20	03.0137-9181.2	669181
41060-31E90	13.0460-5937.2	605937	41139-9F500	11.8171-0008.1	990049	44091-70J25	03.0137-9181.2	669181
41060-31E91	13.0460-5937.2	605937	41139-9F525	11.0101-5407.2	260011	44100-04B00	24.3215-1107.3	020352
41060-31E92	13.0460-5937.2	605937	41142-9F525	11.0101-5407.2	260011	44100-04B02	24.3215-1107.3	020352
41060-31E93	13.0460-5937.2	605937	43202-09E00	24.0222-8025.2	480109	44100-04B04	24.3215-1107.3	020352
41060-32E90	13.0460-5937.2	605937	43203-09E00	24.0222-8025.2	480109	44100-0F000	24.3223-1709.3	020444
41060-32E92	13.0460-5937.2	605937	43204-01B00	24.0218-0021.1	480067	44100-0F001	24.3222-1717.3	020443
41060-32E94	13.0460-5937.2	605937	43204-01B01	24.0218-0021.1	480067	44100-0X800	24.3222-1124.3	020344
41060-32R94	13.0460-5933.2	605933	43206-05J03	24.0118-0136.1	418136	44100-0X810	24.3220-1121.3	020343
41060-37G93	13.0460-5937.2	605937	43206-05J04	24.0118-0136.1	418136	44100-17C10	24.3220-1703.3	020391
41060-3S590	13.0460-5957.2	605957	43206-0F001	24.0225-4014.1	480155	44100-17C11	24.3220-1703.3	020391
41060-41B91	13.0460-5962.2	605962	43206-21B10	24.0218-0022.1	480076	44100-17C12	24.3220-1703.3	020391
41060-44F92	13.0460-5933.2	605933	43206-50Y10	24.0218-0025.1	480082	44100-50C10	24.3215-1107.3	020352
41060-48R91	13.0460-5933.2	605933	43206-58Y00	24.0107-0108.1	407108	44100-50C11	24.3215-1107.3	020352
41060-4M525	13.0460-5950.2	605950	43206-58Y01	24.0107-0108.1	407108	44100-50C12	24.3215-1107.3	020352
41060-4M526	13.0460-5950.2	605950	43206-5M311	24.0110-0215.1	410215	44100-50C13	24.3215-1107.3	020352
41060-50Y94	13.0460-5941.2	605941	43206-88E03	24.0110-0244.1	410244	44100-7F000	24.3223-1709.3	020444
41060-56L25	13.0460-5937.2	605937	43206-99J00	24.0110-0215.1	410215	44100-U9200	24.3220-1703.3	020391

Vergleichsliste

Cross reference list - Tabella di conversione codici



Liste des correspondances - Lista referencias

NISSAN 			OPEL 			OPEL 		
44101-70J20	24.3220-1625.3	020377	8967754	24.3223-1104.3	020291	90086194	24.0220-0011.2	480016
46010-0F002	24.2123-1726.3	010557	8982484	24.0111-0116.1	411116	90094816	11.0441-4803.2	250018
46201-00QAF	24.5111-0386.3	330503	9108323	03.0137-0330.2	650330	90095703	24.3217-1102.3	020168
46242-00QAA	24.5111-0386.3	330503	9109408	03.0137-0153.2	650153	90095704	24.3214-1101.3	020148
D1060-11P26	13.0460-5937.2	605937	9110883	24.3225-1601.3	020359	90114542	13.0460-4048.2	604048
D1060-11P28	13.0460-5937.2	605937	9110961	24.3223-1106.3	020317	90114623	13.0460-4048.2	604048
D1060-11P29	13.0460-5937.2	605937	9111271	13.0460-3969.2	603969	90114693	03.2123-6207.3	010185
D1060-11P85	13.0460-5937.2	605937	9121272	13.0460-3969.2	603969	90114901	13.0460-7048.2	607048
D1060-11P86	13.0460-5937.2	605937	9111283	24.0124-0103.1	424103	90121718	83.6267-0195.3	330737
D1060-11P87	13.0460-5937.2	605937	9192123	13.0460-7080.2	607080	90135264	24.0223-0008.2	480038
D1060-11P88	13.0460-5937.2	605937	9192124	13.0460-2815.2	602815	90142096	03.3219-6301.3	020056
D1060-11P90	13.0460-5937.2	605937	9192125	13.0460-4040.2	604040	90147349	83.6288-0314.3	330338
D1060-11P91	13.0460-5937.2	605937	9192126	13.0460-4040.2	604040	90166278	13.0460-7048.2	607048
D1060-11P92	13.0460-5937.2	605937	9193476	13.0460-4040.2	604040	90166854	11.0101-4802.2	260007
D1060-11P93	13.0460-5937.2	605937	9195057	13.0441-4216.2	250093	90167334	13.0460-7048.2	607048
D1060-2S790	13.0460-5957.2	605957	9195058	13.0460-4040.2	604040	90167528	03.3219-4202.3	020050
D1060-32E93	13.0460-5937.2	605937	9195077	13.0460-2815.2	602815	90167529	03.3222-6903.3	020084
D1060-32E94	13.0460-5937.2	605937	9195146	13.0460-7091.2	607091	90167540	03.3222-6903.3	020084
D1060-37G94	13.0460-5937.2	605937	9197912	24.0125-0119.1	425119	90167765	13.0460-7048.2	607048
D1060-3C490	13.0460-5933.2	605933	9197912	24.0325-0119.1	525119	90168040	24.3214-1101.3	020148
D1060-79E92	13.0460-5933.2	605933	9198688	13.0460-7091.2	607091	90168041	24.3217-1102.3	020168
D1060-V6725	13.0460-5937.2	605937	9201292	11.0101-6004.2	260014	90168396	24.3214-1101.3	020148
D1060-V6790	13.0460-5937.2	605937	9201354	13.0460-4040.2	604040	90168958	24.0220-0001.2	480013
D1060-V6793	13.0460-5937.2	605937	9293027	03.0137-9014.2	669014	90184270	24.3727-0720.2	580720
D1060-V6794	13.0460-5937.2	605937	24404062	24.3727-0725.2	580725	90184271	24.3727-0741.2	580741
D4060-0W727	03.0137-0319.2	650319	24407363	24.3219-1111.3	020194	90187499	03.0137-0166.2	650166
D4060-5M490	13.0460-5983.2	605983	24407364	03.3217-3512.3	020032	90187568	24.3217-1102.3	020168
NSU			24407365	24.3217-1102.3	020168	90187656	03.0137-0167.2	650167
			90006691	03.2122-8806.3	010157	90187869	03.0137-0165.2	650165
40 51 01 529	03.3219-0203.3	020037	90006694	03.2120-2598.3	010116	90187870	03.0137-0165.2	650165
56 56 00 900	13.0460-3010.2	603010	90006865	03.2120-0538.3	010077	90188047	03.0137-0167.2	650167
56 56 00 904	13.0441-3801.2	250058	90006866	03.2123-4911.3	010182	90189396	24.3214-1101.3	020148
56 56 02 902	13.0460-3010.2	603010	90007217	03.3510-0059.1	390270	90189473	03.3219-6301.3	020056
67 53 00 511	03.3115-2651.3	010250	90007425	24.3219-1111.3	020194	90189474	03.3219-4202.3	020050
67 56 00 509	03.3217-0401.3	020023	90007526	24.0220-0012.1	480017	90189718	24.3727-0727.2	580727
67 57 00 518	03.3215-0221.3	020013	90007526	24.0220-0712.2	480208	90189719	24.3727-0734.2	580734
9-8380-57-753	13.0460-3010.2	603010	90008001	24.0113-0125.1	413125	90193039	24.3727-0728.2	580728
OPEL			90008002	24.0113-0126.1	413126	90193357	24.3727-0732.2	580732
			90008003	24.0110-0152.1	410152	90193915	24.0220-0011.2	480016
			90008004	24.0122-0109.1	422109	90199759	83.6267-0195.3	330737
			90008005	24.0113-0161.1	413161	90209335	24.3728-0711.2	590711
1240581	24.3526-0100.3	340017	90008005	24.0313-0161.1	513161	90216275	83.6294-0315.3	330738
2866166	24.3215-1101.3	020155	90008006	24.0120-0115.1	420115	90217234	24.3727-0723.2	580723
2894563	13.0441-5411.2	250114	90008006	24.0320-0115.1	520115	90222437	24.3727-0725.2	580725
3469270	13.0441-4825.2	250107	90008007	24.0122-0126.1	422126	90223402	24.3728-0714.2	590714
3476450	03.2120-1981.3	010105	90008007	24.0113-0125.1	413125	90223404	24.3727-0729.2	580729
3476971	03.2120-2381.3	010111	90008029	24.0110-0152.1	410152	90235420	03.3217-3512.3	020032
3476987	03.2120-2421.3	010112	90008030	24.0122-0109.1	422109	90235422	24.3219-1767.3	020552
3487272	24.0101-4801.2	990131	90008031	24.0113-0161.1	413161	90235472	03.6565-0130.3	320098
3487273	24.0101-4801.2	990131	90008031	24.0313-0161.1	513161	90235567	24.5232-0283.3	331323
3487287	13.0460-7048.2	607048	90008032	24.0120-0115.1	420115	90235568	24.5298-0322.3	331314
3487290	24.3481-0708.5	240024	90008032	24.0320-0115.1	520115	90235729	24.3728-0710.2	590710
3487291	24.3481-0707.5	240023	90008033	24.0122-0126.1	422126	90235948	24.3727-0730.2	580730
3487299	13.0460-7048.2	607048	90009095	11.0101-4802.2	260007	90235999	24.5233-0200.3	330425
3487331	24.3481-0705.5	240021	90009164	11.8171-0008.1	990049	90236355	24.5299-0309.3	331315
3487332	24.3481-0706.5	240022	90009273	11.0441-6003.2	250037	90250704	24.8190-0703.2	620703
3487380	24.3481-0705.5	240021	90009274	11.0101-5407.2	260011	90250705	24.8190-0702.2	620702
3487381	24.3481-0706.5	240022	90009433	24.0123-0100.1	423100	90271037	03.2120-2597.3	010115
3487991	24.3521-1701.5	240001	90009592	03.3217-3512.3	020032	90271041	03.0101-0014.2	320004
3487992	24.3521-1702.5	240002	90009594	24.3219-1767.3	020552	90271133	24.0124-0110.1	424110
3488811	03.2120-2381.3	010111	90010584	13.0460-7048.2	607048	90271134	24.0124-0111.1	424111
3488812	03.2120-2421.3	010112	90010585	13.0460-7048.2	607048	90271135	24.0113-0174.1	413174
3492361	24.2120-0913.3	010392	90017053	24.0113-0126.1	413126	90271938	03.0137-0165.2	650165
3492467	24.2120-0702.3	010361	90017982	13.0460-4048.2	604048	90272326	24.0111-0116.1	411116
3494033	13.0460-0127.2	610127	90018692	13.0460-5030.2	605030	90272328	24.0110-0191.1	410191
3494034	13.0460-0205.2	610205	90019946	03.0137-0108.2	650108	90272329	24.0111-0127.1	411127
3495732	03.0101-0038.2	320245	90063339	03.0137-0172.2	650172	90272330	24.0111-0127.1	411127
8967747	03.3215-1701.3	020015	90077721	24.0223-0008.2	480038	90272646	03.2023-0642.3	010026
8967751	03.3219-4202.3	020050	90077917	83.6267-0330.3	330333	90272647	03.2022-0602.3	010006
8967752	03.3222-6903.3	020084	90079377	83.6267-0285.3	330332	90272648	03.2022-0702.3	010007
8967753	24.3223-1103.3	020290	90086193	24.0110-0152.1	410152	90272649	03.2022-1602.3	010011

Vergleichsliste

Cross reference list - Tabella di conversione codici

Liste des correspondances - Lista referencias



OPEL		OPEL		OPEL				
90272651	03.2022-1402.3	010010	90369385	24.3571-1706.5	240070	90468320	24.5117-0195.3	330565
90272779	03.2122-8806.3	010157	90369713	24.3727-0733.2	580733	90485136	13.0460-4043.2	604043
90273259	03.0137-0172.2	650172	90369714	24.3727-0739.2	580739	90485138	13.0460-4040.2	604040
90273260	13.0460-4040.2	604040	90372058	24.8190-0947.2	620947	90485140	13.0460-7051.2	607051
90273262	03.0137-0166.2	650166	90373178	24.2419-0938.3	030064	90487042	24.3521-1701.5	240001
90278217	24.3728-0717.2	590717	90373856	24.3727-0732.2	580732	90487043	24.3521-1702.5	240002
90295005	13.0441-3506.2	250052	90373926	24.3727-0737.2	580737	90487271	13.0460-4040.2	604040
90295087	24.0124-0115.1	424115	90373927	24.3727-0738.2	580738	90487402	24.0124-0115.1	424115
90295087	24.0324-0115.1	524115	90374075	03.3217-3512.3	020032	90487402	24.0324-0115.1	524115
90295416	03.2120-2597.3	010115	90374076	24.3219-1767.3	020552	90495223	24.3727-0733.2	580733
90295577	13.0460-7048.2	607048	90374106	24.5298-0322.3	331314	90495224	24.3727-0740.2	580740
90295578	13.0460-7048.2	607048	90374841	24.3727-0725.2	580725	90496327	24.0125-0119.1	425119
90296446	03.2120-2598.3	010116	90374902	24.3727-0736.2	580736	90496327	24.0325-0119.1	525119
90297357	13.0460-7048.2	607048	90375403	24.3727-0739.2	580739	90498300	24.3219-1715.3	020122
90297358	13.0460-7048.2	607048	90375404	24.3727-0740.2	580740	90509590	24.0110-0249.1	410249
90297376	03.2122-0264.3	010129	90375405	24.3727-0734.2	580734	90509606	03.0137-0172.2	650172
90297407	13.0460-4035.2	604035	90375406	24.3727-0733.2	580733	90510227	11.0101-5407.2	260011
90297409	13.0460-4035.2	604035	90392559	24.0128-0104.1	428104	90510331	13.0460-7051.2	607051
90297410	13.0460-5030.2	605030	90397655	03.0137-0165.2	650165	90511111	24.0120-0115.1	420115
90297411	13.0460-5030.2	605030	90398116	13.0460-2815.2	602815	90511111	24.0320-0115.1	520115
90297412	13.0460-5030.2	605030	90398235	13.0460-7048.2	607048	90511128	24.0120-0140.1	420140
90297415	13.0460-4048.2	604048	90398758	13.0460-7048.2	607048	90511162	13.0460-7052.2	607052
90297419	13.0460-4048.2	604048	90398759	13.0460-7048.2	607048	90511254	10.0515-0515.3	340024
90297473	03.0137-0108.2	650108	90398760	13.0460-7052.2	607052	90512029	24.0125-0119.1	425119
90297533	13.2351-0014.2	210011	90398800	13.0460-7048.2	607048	90512029	24.0325-0119.1	525119
90297533	24.9235-0014.5	230002	90399218	03.0137-0166.2	650166	90512037	13.0460-7091.2	607091
90297534	13.2351-0013.2	210010	90399437	13.0460-7048.2	607048	90512907	03.0137-0172.2	650172
90297534	24.9235-0013.5	230001	90399472	10.0515-0515.3	340024	90538302	24.8190-0713.2	620713
90297537	13.0460-4043.2	604043	90399495	13.0460-7052.2	607052	90538629	24.3727-0732.2	580732
90297553	03.2022-1402.3	010010	90421528	13.0460-4040.2	604040	90540167	24.3571-1762.5	240462
90297554	03.2022-1602.3	010011	90421602	13.0460-0127.2	610127	90540168	24.3571-1761.5	240461
90297557	03.2023-0642.3	010026	90421603	13.0460-0205.2	610205	90540169	11.0441-5704.2	250034
90297753	03.0137-0108.2	650108	90421703	24.3727-0734.2	580734	90540177	13.0460-4040.2	604040
90297765	24.3521-1701.5	240001	90421704	24.3727-0733.2	580733	90541257	13.0460-5942.2	605942
90297766	24.3521-1702.5	240002	90421727	24.0120-0140.1	420140	90541293	13.0460-2815.2	602815
90297767	11.0441-5202.2	250026	90421729	11.9481-9871.2	220681	90541931	03.0137-0172.2	650172
90297768	11.0101-5407.2	260011	90421730	11.9481-9872.2	220682	90542862	03.0137-0266.2	650266
90297770	13.0460-7052.2	607052	90421731	11.0441-4811.2	250024	90542863	03.0137-0267.2	650267
90297771	11.8171-0008.1	990049	90421736	13.0460-7051.2	607051	91149506	03.0137-0267.2	650267
90297772	11.8116-0097.1	390590	90421738	11.8116-0129.1	390591	91158366	03.0137-0267.2	650267
90297777	11.0441-5402.2	250028	90421739	11.9481-9871.2	220681	91166506	24.5111-0386.3	330503
90297927	24.3727-0739.2	580739	90421740	11.9481-9872.2	220682	93173733	11.8116-0292.1	390521
90297932	24.0110-0205.1	410205	90421744	24.3481-1733.5	240213	93176120	13.0460-7051.2	607051
90305792	24.8190-0706.2	620706	90421745	24.3481-1734.5	240214	93182283	24.0128-0104.1	428104
90305918	24.8190-0708.2	620708	90421796	03.0137-0266.2	650266	93182290	24.0113-0161.1	413161
90334416	24.3728-0712.2	590712	90421797	03.0137-0267.2	650267	93182290	24.0313-0161.1	513161
90334462	24.3727-0736.2	580736	90421834	03.0101-0025.2	320014	93191802	13.0460-7091.2	607091
90335198	24.3728-0717.2	590717	90421842	03.0101-0027.2	320022	93853917	24.5111-0386.3	330503
90335385	24.3728-0719.2	590719	90421872	24.0110-0204.1	410204	94172376	24.0122-0156.1	422156
90335547	24.3727-0725.2	580725	90425239	24.5117-0195.3	330565	94230541	24.3225-1702.3	020425
90335784	24.8190-0705.2	620705	90425247	03.0101-0025.2	320014	94483220	13.0460-5942.2	605942
90335785	24.8190-0704.2	620704	90425491	24.8190-0707.2	620707	95511282	24.0122-0145.1	422145
90335899	24.3727-0732.2	580732	90425708	03.0101-0027.2	320022	97114300	13.0460-5942.2	605942
90335900	24.3727-0741.2	580741	90442385	13.0460-7048.2	607048	97127616	24.3225-1702.3	020425
90335983	24.2520-0904.3	040037	90442513	24.0124-0133.1	424133	12 38 342	24.8190-0703.2	620703
90342177	24.8190-0703.2	620703	90442651	24.0110-0253.1	410253	12 38 343	24.8190-0702.2	620702
90343961	24.8190-0709.2	620709	90442995	13.0460-7051.2	607051	12 38 348	24.8190-0705.2	620705
90343962	24.8190-0712.2	620712	90443259	03.3217-3512.3	020032	12 38 349	24.8190-0704.2	620704
90344249	24.3728-0715.2	590715	90443261	24.3219-1767.3	020552	12 38 353	24.8190-0701.2	620701
90344548	24.2419-0938.3	030064	90443861	03.2123-1121.3	010176	12 38 369	24.8190-0703.2	620703
90345102	24.8190-0716.2	620716	90443867	24.3541-8085.5	240525	12 38 403	24.8190-0706.2	620706
90345229	24.3728-0712.2	590712	90443868	24.3541-8086.5	240526	12 38 404	24.8190-0708.2	620708
90345232	24.3728-0717.2	590717	90443871	11.8116-0292.1	390521	12 38 408	24.8190-0712.2	620712
90345528	24.3727-0728.2	580728	90443873	13.0460-7080.2	607080	12 38 409	24.8190-0709.2	620709
90348213	03.2122-0282.3	010130	90443885	03.0101-0038.2	320245	12 38 421	24.8190-0947.2	620947
90348319	24.0110-0144.1	410144	90443902	13.0460-7048.2	607048	12 38 783	24.8190-0716.2	620716
90349868	03.0137-0172.2	650172	90444681	03.0137-0167.2	650167	12 38 984	24.8190-0707.2	620707
90350122	03.0137-0108.2	650108	90444700	24.3571-1705.5	240069	16 05 003	13.0460-7080.2	607080
90350153	03.0137-0108.2	650108	90444701	24.3571-1706.5	240070	16 05 004	13.0460-2815.2	602815
90350169	03.0137-0166.2	650166	90445758	24.5233-0200.3	330425	16 05 005	13.0460-4040.2	604040
90369384	24.3571-1705.5	240069	90468319	24.5298-0322.3	331314	16 05 006	13.0460-4040.2	604040



Vergleichsliste

Cross reference list - Tabella di conversione codici



Liste des correspondances - Lista referencias

OPEL		OPEL		OPEL				
16 05 007	13.0460-0347.2	610347	16 05 674	03.0137-0165.2	650165	16 05 938	03.0137-0172.2	650172
16 05 014	13.0441-5411.2	250114	16 05 686	03.0137-0172.2	650172	16 05 952	03.0137-0266.2	650266
16 05 026	13.0460-4040.2	604040	16 05 687	13.0460-4040.2	604040	16 05 953	03.0137-0267.2	650267
16 05 030	13.0441-4216.2	250093	16 05 689	03.0137-0166.2	650166	16 05 966	13.0460-7091.2	607091
16 05 031	13.0460-4040.2	604040	16 05 694	13.0441-3506.2	250052	4 18 117	24.0220-0012.1	480017
16 05 033	13.0460-2815.2	602815	16 05 696	13.0460-7048.2	607048	4 18 117	24.0220-0712.2	480208
16 05 036	13.0460-7091.2	607091	16 05 697	13.0460-7048.2	607048	44 00 323	03.0137-0330.2	650330
16 05 044	11.0101-6004.2	260014	16 05 699	13.0460-0127.2	610127	44 01 408	03.0137-0153.2	650153
16 05 047	13.0460-4040.2	604040	16 05 700	13.0460-0205.2	610205	44 02 883	24.3225-1601.3	020359
16 05 056	03.0137-0267.2	650267	16 05 703	13.0460-7048.2	607048	44 02 961	24.3223-1106.3	020317
16 05 087	13.0460-7051.2	607051	16 05 704	13.0460-7048.2	607048	44 03 271	13.0460-3969.2	603969
16 05 141	13.0441-4825.2	250107	16 05 710	13.0460-4035.2	604035	44 03 272	13.0460-3969.2	603969
16 05 142	13.0441-4206.2	250087	16 05 712	13.0460-4035.2	604035	44 03 283	24.0124-0103.1	424103
16 05 144	13.0460-4035.2	604035	16 05 713	13.0460-5030.2	605030	44 03 294	03.0137-0330.2	650330
16 05 147	13.0460-3010.2	603010	16 05 714	13.0460-5030.2	605030	44 09 164	24.5111-0386.3	330503
16 05 148	13.0460-3010.2	603010	16 05 715	13.0460-5030.2	605030	44 16 297	24.5111-0386.3	330503
16 05 162	13.0441-4819.2	250104	16 05 718	13.0460-4048.2	604048	44 67 098	13.0460-0217.2	610217
16 05 183	13.0460-4035.2	604035	16 05 722	13.0460-4048.2	604048	5 22 527	24.3727-0725.2	580725
16 05 189	13.0460-6027.2	606027	16 05 728	13.0460-4043.2	604043	5 22 545	24.3727-0711.2	580711
16 05 192	13.0460-4035.2	604035	16 05 739	03.0137-0108.2	650108	5 22 546	24.3727-0712.2	580712
16 05 201	13.0460-4035.2	604035	16 05 744	03.0137-0108.2	650108	5 22 548	24.3727-0721.2	580721
16 05 204	13.0460-3010.2	603010	16 05 746	13.0460-7052.2	607052	5 22 549	24.3727-0722.2	580722
16 05 212	13.0460-4035.2	604035	16 05 747	11.0101-5407.2	260011	5 22 559	24.3727-0720.2	580720
16 05 216	13.0441-4825.2	250107	16 05 748	11.0441-5202.2	250026	5 22 560	24.3727-0741.2	580741
16 05 219	13.0460-4035.2	604035	16 05 749	11.0441-5402.2	250028	5 22 561	24.3727-0732.2	580732
16 05 291	13.0460-5030.2	605030	16 05 764	03.0137-0172.2	650172	5 22 562	24.3727-0723.2	580723
16 05 300	13.0460-5030.2	605030	16 05 769	03.0137-0108.2	650108	5 22 568	24.3727-0730.2	580730
16 05 305	03.0137-9014.2	669014	16 05 772	03.0137-0108.2	650108	5 22 569	24.3727-0734.2	580734
16 05 324	13.0460-3010.2	603010	16 05 774	03.0137-0166.2	650166	5 22 570	24.3727-0727.2	580727
16 05 327	13.0460-4035.2	604035	16 05 779	11.0441-5402.2	250028	5 22 571	24.3727-0728.2	580728
16 05 328	13.0460-4035.2	604035	16 05 781	03.0137-0165.2	650165	5 22 572	24.3727-0729.2	580729
16 05 382	03.0137-0108.2	650108	16 05 782	13.0460-2815.2	602815	5 22 575	24.3727-0725.2	580725
16 05 398	13.0460-5030.2	605030	16 05 783	13.0460-7048.2	607048	5 22 578	24.3727-0725.2	580725
16 05 431	13.0460-4048.2	604048	16 05 787	13.0460-7048.2	607048	5 22 579	24.3727-0741.2	580741
16 05 433	13.0460-4048.2	604048	16 05 788	13.0460-7048.2	607048	5 22 580	24.3727-0732.2	580732
16 05 448	13.0460-4035.2	604035	16 05 789	13.0460-7052.2	607052	5 22 581	24.3727-0739.2	580739
16 05 449	13.0460-4035.2	604035	16 05 791	13.0460-7048.2	607048	5 22 585	24.3727-0736.2	580736
16 05 454	13.0460-7052.2	607052	16 05 792	03.0137-0166.2	650166	5 22 587	24.3727-0728.2	580728
16 05 455	13.0460-7051.2	607051	16 05 795	13.0460-7048.2	607048	5 22 588	24.3727-0733.2	580733
16 05 463	13.0460-7048.2	607048	16 05 799	13.0460-4040.2	604040	5 22 589	24.3727-0739.2	580739
16 05 470	13.0460-4035.2	604035	16 05 803	13.0460-0205.2	610205	5 22 592	24.3727-0725.2	580725
16 05 484	11.0441-4803.2	250018	16 05 804	13.0460-0127.2	610127	5 22 593	24.3727-0737.2	580737
16 05 485	13.0460-7048.2	607048	16 05 808	13.0460-7052.2	607052	5 22 594	24.3727-0738.2	580738
16 05 496	13.0460-7048.2	607048	16 05 809	11.0441-4811.2	250024	5 22 595	24.3727-0736.2	580736
16 05 504	13.0460-7048.2	607048	16 05 810	13.0460-7051.2	607051	5 22 596	24.3727-0733.2	580733
16 05 516	13.0460-4048.2	604048	16 05 811	03.0137-0266.2	650266	5 22 597	24.3727-0734.2	580734
16 05 533	13.0460-4048.2	604048	16 05 812	03.0137-0267.2	650267	5 22 598	24.3727-0740.2	580740
16 05 534	24.0101-4801.2	990131	16 05 815	03.0101-0027.2	320022	5 22 599	24.3727-0739.2	580739
16 05 535	24.0101-4801.2	990131	16 05 817	03.0101-0025.2	320014	5 22 600	24.3727-0732.2	580732
16 05 536	13.0460-7048.2	607048	16 05 820	13.0460-7048.2	607048	5 22 601	24.3727-0734.2	580734
16 05 544	13.0460-7048.2	607048	16 05 824	13.0460-7051.2	607051	5 22 602	24.3727-0733.2	580733
16 05 546	13.0460-7048.2	607048	16 05 825	13.0460-5942.2	605942	5 22 620	24.3727-0733.2	580733
16 05 556	13.0460-5030.2	605030	16 05 855	13.0460-7080.2	607080	5 22 621	24.3727-0740.2	580740
16 05 557	13.0460-5030.2	605030	16 05 870	13.0460-7048.2	607048	5 22 640	24.3727-0732.2	580732
16 05 562	13.0460-7048.2	607048	16 05 877	13.0460-4043.2	604043	5 42 073	24.3481-0707.5	240023
16 05 563	13.0460-7048.2	607048	16 05 879	13.0460-4040.2	604040	5 42 074	24.3481-0708.5	240024
16 05 576	11.0101-4802.2	260007	16 05 881	13.0460-7051.2	607051	5 42 079	24.3481-0705.5	240021
16 05 582	13.0460-7048.2	607048	16 05 883	13.0460-4040.2	604040	5 42 080	24.3481-0706.5	240022
16 05 586	13.0460-7048.2	607048	16 05 887	03.0137-0167.2	650167	5 42 099	24.3541-8085.5	240525
16 05 590	03.0137-0166.2	650166	16 05 897	03.0137-0172.2	650172	5 42 100	24.3541-8086.5	240526
16 05 591	03.0137-0167.2	650167	16 05 905	11.0101-5407.2	260011	5 42 101	24.3571-1705.5	240069
16 05 592	03.0137-0165.2	650165	16 05 907	13.0460-7051.2	607051	5 42 102	24.3571-1706.5	240070
16 05 593	03.0137-0165.2	650165	16 05 910	03.0137-0267.2	650267	5 42 215	24.3481-0705.5	240021
16 05 594	03.0137-0167.2	650167	16 05 911	13.0460-7052.2	607052	5 42 216	24.3481-0706.5	240022
16 05 654	13.0460-7091.2	607091	16 05 912	13.0460-7091.2	607091	5 42 225	24.3521-1701.5	240001
16 05 656	11.0101-4802.2	260007	16 05 916	13.0460-5942.2	605942	5 42 226	24.3521-1702.5	240002
16 05 657	11.0441-6003.2	250037	16 05 921	03.0137-0172.2	650172	5 42 229	13.2351-0013.2	210010
16 05 658	11.0101-5407.2	260011	16 05 923	11.0441-5704.2	250034	5 42 229	24.9235-0013.5	230001
16 05 668	13.0460-7048.2	607048	16 05 924	13.0460-4040.2	604040	5 42 230	13.2351-0014.2	210011
16 05 670	13.0460-7048.2	607048	16 05 931	13.0460-5942.2	605942	5 42 230	24.9235-0014.5	230002
16 05 671	13.0460-7048.2	607048	16 05 932	13.0460-2815.2	602815	5 42 231	24.3521-1701.5	240001

Vergleichsliste

Cross reference list - Tabella di conversione codici

Liste des correspondances - Lista referencias



OEPEL		OEPEL		OEPEL				
5 42 232	24.3521-1702.5	240002	5 58 099	03.2122-0282.3	010130	5 69 031	24.0120-0115.1	420115
5 42 241	11.9481-9871.2	220681	5 58 100	24.2120-0913.3	010392	5 69 031	24.0320-0115.1	520115
5 42 242	11.9481-9872.2	220682	5 58 102	24.2120-0702.3	010361	5 69 032	24.0122-0126.1	422126
5 42 243	11.9481-9871.2	220681	5 58 103	03.2120-1981.3	010105	5 69 036	24.0123-0100.1	423100
5 42 244	11.9481-9872.2	220682	5 58 105	03.2123-1121.3	010176	5 69 038	24.0124-0110.1	424110
5 42 245	24.3481-1733.5	240213	5 58 128	03.2120-2598.3	010116	5 69 039	24.0124-0111.1	424111
5 42 246	24.3481-1734.5	240214	5 58 132	03.2123-4911.3	010182	5 69 040	24.0113-0174.1	413174
5 42 250	24.3521-1702.5	240002	5 58 137	03.2120-2421.3	010112	5 69 041	24.0111-0116.1	411116
5 42 251	24.3521-1701.5	240001	5 58 147	03.2122-8806.3	010157	5 69 042	24.0124-0115.1	424115
5 42 273	24.3571-1761.5	240461	5 58 179	03.2122-8806.3	010157	5 69 042	24.0324-0115.1	524115
5 42 274	24.3571-1762.5	240462	5 58 182	03.2120-2598.3	010116	5 69 044	24.0128-0104.1	428104
5 42 450	24.3571-1705.5	240069	5 58 184	03.2120-2381.3	010111	5 69 046	24.0120-0140.1	420140
5 42 451	24.3571-1706.5	240070	5 58 185	03.2120-2421.3	010112	5 69 047	24.0124-0133.1	424133
5 42 529	11.8116-0097.1	390590	5 58 187	03.2120-2598.3	010116	5 69 054	24.0120-0115.1	420115
5 42 530	11.8116-0129.1	390591	5 58 191	03.2120-0538.3	010077	5 69 054	24.0320-0115.1	520115
5 42 531	11.8116-0292.1	390521	5 58 192	03.2123-4911.3	010182	5 69 055	24.0120-0140.1	420140
5 42 535	11.8116-0292.1	390521	5 58 250	03.3318-0800.2	390112	5 69 056	24.0125-0119.1	425119
5 42 880	11.8171-0008.1	990049	5 58 325	03.3304-0700.1	390082	5 69 056	24.0325-0119.1	525119
5 42 881	11.8171-0008.1	990049	5 58 631	03.3517-0101.2	390322	5 69 086	24.0122-0145.1	422145
5 45 205	24.7718-7301.2	990024	5 59 031	03.3508-8302.3	310046	5 69 101	24.0110-0191.1	410191
5 50 006	24.3219-1111.3	020194	5 59 037	03.3508-7504.3	310045	5 69 102	24.0110-0205.1	410205
5 50 008	03.3217-3512.3	020032	5 59 045	03.3508-8302.3	310046	5 69 105	24.0110-0249.1	410249
5 50 009	24.3217-1102.3	020168	5 59 055	03.3304-0700.1	390082	5 69 201	24.0111-0127.1	411127
5 50 012	24.3215-1101.3	020155	5 59 060	03.3304-1400.1	390088	5 69 203	24.0111-0127.1	411127
5 50 036	24.3223-1103.3	020290	5 59 522	03.3510-0059.1	390270	5 69 204	24.0110-0144.1	410144
5 50 037	24.3223-1104.3	020291	5 62 094	24.5233-0200.3	330425	5 69 206	24.0110-0204.1	410204
5 50 040	03.3215-1701.3	020015	5 62 229	83.6123-0381.3	330262	5 69 207	24.0110-0253.1	410253
5 50 056	03.3215-1701.3	020015	5 62 306	83.6267-0330.3	330333	5 69 801	24.0122-0156.1	422156
5 50 058	03.3222-6903.3	020084	5 62 314	83.6267-0285.3	330332	6 69 071	24.3728-0706.2	590706
5 50 061	24.3223-1103.3	020290	5 62 321	83.6267-0195.3	330737	6 69 088	24.3728-0708.2	590708
5 50 062	24.3223-1104.3	020291	5 62 325	83.6288-0314.3	330338	6 69 096	24.3728-0706.2	590706
5 50 066	03.3219-4202.3	020050	5 62 331	83.6267-0195.3	330737	6 69 124	24.3728-0708.2	590708
5 50 113	24.3214-1101.3	020148	5 62 336	03.6294-0315.3	330738	6 69 130	24.3728-0709.2	590709
5 50 114	24.3217-1102.3	020168	5 62 343	24.5232-0283.3	331323	6 69 132	24.3728-0710.2	590710
5 50 118	03.3219-6301.3	020056	5 62 344	24.5299-0309.3	331315	6 69 136	24.3728-0708.2	590708
5 50 119	24.3214-1101.3	020148	5 62 345	24.5298-0322.3	331314	6 69 142	24.3728-0711.2	590711
5 50 120	24.3217-1102.3	020168	5 62 346	24.5233-0200.3	330425	6 69 149	24.3728-0714.2	590714
5 50 121	03.3222-6903.3	020084	5 62 350	24.5298-0322.3	331314	6 69 155	24.3728-0717.2	590717
5 50 122	03.3219-4202.3	020050	5 62 352	24.5117-0195.3	330565	6 69 157	24.3728-0710.2	590710
5 50 123	03.3219-4202.3	020050	5 62 358	24.5298-0322.3	331314	6 69 159	24.3728-0719.2	590719
5 50 124	03.3222-6903.3	020084	5 62 359	24.5117-0195.3	330565	6 69 161	24.3728-0712.2	590712
5 50 127	03.3219-6301.3	020056	5 65 074	03.6565-0130.3	320098	6 69 165	24.3728-0717.2	590717
5 50 128	24.3214-1101.3	020148	5 65 081	03.0101-0014.2	320004	6 69 166	24.3728-0715.2	590715
5 50 129	24.3217-1102.3	020168	5 65 137	03.0101-0038.2	320245	6 69 168	24.3728-0717.2	590717
5 50 130	24.3219-1111.3	020194	5 65 138	03.0101-0038.2	320245	6 69 170	24.3728-0712.2	590712
5 50 133	24.3219-1767.3	020552	5 68 038	24.0223-0008.2	480038	6 79 305	24.2419-0938.3	030064
5 50 135	03.3217-3512.3	020032	5 68 039	24.0220-0001.2	480013	6 79 307	24.2520-0904.3	040037
5 50 140	03.3217-3512.3	020032	5 68 051	24.0223-0008.2	480038	6 79 316	24.2419-0938.3	030064
5 50 141	24.3219-1767.3	020552	5 68 053	24.0220-0011.2	480016	62 38 399	24.8190-0713.2	620713
5 50 142	24.3225-1702.3	020425	5 68 054	24.0220-0001.2	480013	7 80 350	10.0515-0515.3	340024
5 50 143	03.3217-3512.3	020032	5 68 056	24.0223-0008.2	480038	7 80 351	10.0515-0515.3	340024
5 50 144	24.3219-1767.3	020552	5 68 057	24.0220-0001.2	480013	PEUGEOT		
5 50 152	24.3225-1702.3	020425	5 68 058	24.0220-0011.2	480016			
5 50 153	24.3219-1715.3	020122	5 69 001	24.0124-0115.1	424115			
5 52 152	03.0137-0172.2	650172	5 69 001	24.0324-0115.1	524115	2086 11	24.2528-1601.3	040063
5 58 017	03.2120-2597.3	010115	5 69 009	24.0122-0109.1	422109	2086 13	24.2528-1601.3	040063
5 58 025	03.2123-6207.3	010185	5 69 013	24.0111-0116.1	411116	2095 15	24.2419-0929.3	030057
5 58 043	03.2023-0642.3	010026	5 69 013	24.0113-0161.1	413161	2095 17	24.2419-0929.3	030057
5 58 044	03.2022-0602.3	010006	5 69 013	24.0313-0161.1	513161	2095 18	24.2419-0929.3	030057
5 58 045	03.2022-0702.3	010007	5 69 015	24.0113-0125.1	413125	2150 55	24.3728-0515.2	590515
5 58 046	03.2022-1602.3	010011	5 69 016	24.0128-0104.1	428104	2150 71	24.3728-0803.2	590803
5 58 050	03.2120-2597.3	010115	5 69 017	24.0110-0152.1	410152	2150 79	24.3728-0818.2	590818
5 58 055	03.2122-8806.3	010157	5 69 020	24.0113-0161.1	413161	2150 93	24.3728-0807.2	590807
5 58 056	03.2120-2598.3	010116	5 69 020	24.0313-0161.1	513161	2150 96	24.3728-0806.2	590806
5 58 058	03.2122-0264.3	010129	5 69 022	24.0122-0126.1	422126	2150 98	24.3728-0806.2	590806
5 58 062	03.2120-1981.3	010105	5 69 026	24.0113-0125.1	413125	2150 A6	24.3728-0813.2	590813
5 58 069	03.2123-6207.3	010185	5 69 027	24.0113-0126.1	413126	2150 A8	24.3728-0810.2	590810
5 58 070	03.2120-2381.3	010111	5 69 028	24.0110-0152.1	410152	2150 C0	24.3728-0811.2	590811
5 58 082	03.2022-1402.3	010010	5 69 029	24.0122-0109.1	422109	2150 C9	24.3728-0819.2	590819
5 58 089	03.2022-1602.3	010011	5 69 030	24.0113-0161.1	413161	2150 E0	24.3728-0812.2	590812
5 58 095	03.2023-0642.3	010026	5 69 030	24.0313-0161.1	513161	2150 E7	24.3728-0814.2	590814



Vergleichsliste

Cross reference list - Tabella di conversione codici

Liste des correspondances - Lista referencias



PEUGEOT		PEUGEOT		PEUGEOT				
2150 G2	24.3728-0843.2	590843	4246 B3	24.0113-0168.1	413168	4250 87	13.0460-2971.2	602971
2150 L8	24.3728-0315.2	590315	4246 B4	24.0116-0105.1	416105	4250 88	13.0460-3911.2	603911
4224 03	03.0137-9700.2	669700	4246 B8	24.0114-0107.1	414107	4250 90	13.0460-4042.2	604042
4238 07	03.0137-0124.2	650124	4246 E7	24.0122-0141.1	422141	4250 91	13.0460-3943.2	603943
4241 17	03.0137-0139.2	650139	4246 E8	24.0122-0141.1	422141	4250 92	13.0460-3943.2	603943
4241 21	03.0137-0196.2	650196	4246 F4	24.0126-0100.1	426100	4250 95	13.0460-2971.2	602971
4241 23	03.0137-0197.2	650197	4246 F6	24.0126-0100.1	426100	4250 97	13.0460-3911.2	603911
4241 25	03.0137-0201.2	650201	4246 F8	24.0108-0107.1	408107	4251 02	13.0460-3952.2	603952
4241 3L	03.0520-2620.3	692620	4246 G0	24.0108-0107.1	408107	4251 04	13.0460-3954.2	603954
4241 3Q	03.0520-1220.3	691220	4246 G1	24.0122-0142.1	422142	4251 05	13.0460-2902.2	602902
4241 4L	03.0520-5720.3	695720	4246 G6	24.0108-0106.1	408106	4251 06	13.0460-2901.2	602901
4241 55	03.0137-0202.2	650202	4246 G9	24.0110-0199.1	410199	4251 08	13.0460-2842.2	602842
4241 56	03.0137-0271.2	650271	4246 H0	24.0108-0105.1	408105	4251 20	13.0460-3943.2	603943
4241 57	03.0137-0203.2	650203	4246 H3	24.0116-0106.1	416106	4251 32	13.0460-2817.2	602817
4241 58	03.0137-0330.2	650330	4246 N0	24.0126-0106.1	426106	4251 34	13.0460-7088.2	607088
4241 59	03.0137-0269.2	650269	4246 N0	24.0326-0106.1	526106	4251 41	13.0460-3962.2	603962
4241 6L	03.0520-0619.3	690619	4246 N8	24.0126-0100.1	426100	4251 42	13.0460-7088.2	607088
4241 6N	03.0520-1220.3	691220	4246 R3	24.0120-0133.1	420133	4251 43	13.0460-2817.2	602817
4241 6R	03.0520-1619.3	691619	4246 R3	24.0320-0133.1	520133	4251 48	13.0460-3954.2	603954
4241 6T	03.0520-0519.3	690519	4246 R7	24.0126-0106.1	426106	4251 60	13.0460-2817.2	602817
4241 71	03.0137-0201.2	650201	4246 R7	24.0326-0106.1	526106	4251 64	13.0460-4066.2	604066
4241 72	03.0137-0197.2	650197	4246 V3	24.0122-0142.1	422142	4251 65	13.0460-3962.2	603962
4241 73	03.0137-0196.2	650196	4246 W5	24.0120-0133.1	420133	4251 67	13.0460-7088.2	607088
4241 7F	03.0520-0419.3	690419	4246 W5	24.0320-0133.1	520133	4251 96	13.0460-3823.2	603823
4241 7J	03.0520-4120.3	694120	4247 22	24.0225-4002.1	480048	4252 56	13.0460-3954.2	603954
4241 7N	03.0520-5420.3	695420	4247 24	24.0222-8017.1	480071	4252 71	13.0460-3823.2	603823
4241 7P	03.0520-0919.3	690919	4247 25	24.0218-0014.1	480009	4252 86	13.0460-4066.2	604066
4241 8R	03.0520-2620.3	692620	4247 30	24.0218-0015.1	480010	4253 14	13.0460-3952.2	603952
4241 91	03.0137-0271.2	650271	4247 31	24.0218-0014.1	480009	4253 87	13.0460-5958.2	605958
4241 94	03.0137-0124.2	650124	4247 32	24.0218-0016.1	480011	4254 30	13.0460-5958.2	605958
4241 A4	03.0137-0285.2	650285	4247 32	24.0218-0716.2	480203	4254 42	13.0460-3823.2	603823
4241 E5	03.0137-0197.2	650197	4247 33	24.0216-5001.1	480001	4254 82	13.0460-7088.2	607088
4241 E6	03.0137-0201.2	650201	4247 33	24.0216-5701.2	480212	4254 93	13.0460-4066.2	604066
4241 E7	03.0137-0195.2	650195	4247 34	24.0218-0017.1	480060	4308 30	03.0137-9032.2	669032
4241 E8	03.0137-0196.2	650196	4247 35	24.0218-0020.1	480074	4308 34	03.0137-9055.2	669055
4241 G3	03.0137-0261.2	650261	4247 35	24.0218-0720.2	480205	4308 38	03.0137-9228.2	669228
4241 H6	03.0137-0347.2	650347	4247 40	24.0220-3014.1	480090	4308 40	03.0137-9079.2	669079
4241 H8	03.0137-0330.2	650330	4247 42	24.0216-5001.1	480001	4308 45	03.0137-9027.2	669027
4241 H9	03.0137-0269.2	650269	4247 42	24.0216-5701.2	480212	4308 50	03.0137-9169.2	669169
4241 J1	03.0137-0312.2	650312	4247 43	24.0216-5001.1	480001	4308 52	03.0137-9086.2	669086
4241 J5	03.0137-0312.2	650312	4247 43	24.0216-5701.2	480212	4308 53	03.0137-9175.2	669175
4241 J9	03.0137-0196.2	650196	4247 44	24.0218-0020.1	480074	4308 55	03.0137-9220.2	669220
4241 L3	03.0137-0196.2	650196	4247 44	24.0218-0720.2	480205	4308 57	03.0137-9228.2	669228
4241 L4	03.0137-0261.2	650261	4248 33	13.0460-2901.2	602901	4308 58	03.0137-9158.2	669158
4242 25	03.0520-0519.3	690519	4248 64	13.0460-3928.2	603928	4308 59	03.0137-9228.2	669228
4242 26	03.0520-2620.3	692620	4249 75	24.0122-0147.1	422147	4308 61	03.0137-9228.2	669228
4242 29	03.0520-1619.3	691619	4249 95	24.0110-0187.1	410187	4308 62	03.0137-9088.2	669088
4246 42	24.0113-0128.1	413128	4249 96	24.0120-0132.1	420132	4315 13	03.0137-9089.2	669089
4246 69	24.0114-0107.1	414107	4249 96	24.0320-0132.1	520132	4315 14	03.0137-9055.2	669055
4246 85	24.0113-0168.1	413168	4249 F0	24.0120-0133.1	420133	4400 83	24.3481-1609.7	220197
4246 88	24.0110-0183.1	410183	4249 F0	24.0320-0133.1	520133	4400 84	24.3481-1610.7	220198
4246 89	24.0110-0187.1	410187	4249 F5	24.0108-0106.1	408106	4400 A5	24.3481-1707.5	240073
4246 90	24.0120-0131.1	420131	4249 L1	24.0116-0105.1	416105	4400 A6	24.3481-1708.5	240074
4246 94	24.0120-0132.1	420132	4250 35	13.0460-3911.2	603911	4400 E4	11.3481-9833.2	220561
4246 94	24.0320-0132.1	520132	4250 37	13.0460-2956.2	602956	4400 E4	24.3481-9833.5	240479
4246 95	24.0116-0105.1	416105	4250 39	13.0460-2956.2	602956	4400 E5	11.3481-9834.2	220562
4246 96	24.0113-0168.1	413168	4250 41	13.0460-2955.2	602955	4400 E5	24.3481-9834.5	240480
4246 97	24.0120-0133.1	420133	4250 43	13.0460-3911.2	603911	4400 G7	11.3481-9833.2	220561
4246 97	24.0320-0133.1	520133	4250 50	13.0460-3911.2	603911	4400 G7	24.3481-9833.5	240479
4246 99	24.0108-0105.1	408105	4250 51	13.0460-3911.2	603911	4400 G8	11.3481-9834.2	220562
4246 A0	24.0116-0106.1	416106	4250 54	13.0460-2901.2	602901	4400 G8	24.3481-9834.5	240480
4246 A1	24.0110-0199.1	410199	4250 55	13.0460-2971.2	602971	4400 J4	11.3481-9833.2	220561
4246 A2	24.0110-0199.1	410199	4250 56	13.0460-2937.2	602937	4400 J4	24.3481-9833.5	240479
4246 A5	24.0110-0187.1	410187	4250 58	13.0460-2902.2	602902	4400 J5	11.3481-9834.2	220562
4246 A6	24.0120-0131.1	420131	4250 67	13.0460-3928.2	603928	4400 J5	24.3481-9834.5	240480
4246 A7	24.0120-0132.1	420132	4250 69	13.0460-3911.2	603911	4400 T9	24.3431-1701.5	240437
4246 A7	24.0320-0132.1	520132	4250 70	13.0460-2955.2	602955	4400 V0	24.3431-1702.5	240438
4246 A9	24.0110-0183.1	410183	4250 71	13.0460-3954.2	603954	4401 63	24.3481-1615.5	240031
4246 B1	24.0120-0133.1	420133	4250 72	13.0460-3911.2	603911	4401 64	24.3481-1616.5	240032
4246 B1	24.0320-0133.1	520133	4250 76	13.0460-3911.2	603911	4401 70	24.3384-1605.5	240295
4246 B2	24.0113-0128.1	413128	4250 82	13.0460-2956.2	602956	4401 71	24.3384-1606.5	240296



Vergleichsliste

Cross reference list - Tabella di conversione codici

Liste des correspondances - Lista referencias



PEUGEOT		PEUGEOT		PEUGEOT				
4402 21	24.3219-1114.3	020323	4601 A3	03.2120-2031.3	010106	4861 32	24.6513-1701.3	320160
4402 30	24.3222-1102.3	020257	4601 F1	24.2120-1722.3	010544	4861 35	03.6513-0340.3	320084
4402 38	24.3225-0903.3	020327	4601 F4	24.2120-1722.3	010544	4861 45	24.6043-1701.3	320150
4402 43	24.3223-1105.3	020292	4601 H4	03.2120-2031.3	010106	4861 46	03.6583-0037.3	320107
4402 48	24.3222-1107.3	020262	4601 H8	03.2120-2031.3	010106	4861 47	03.6583-0037.3	320107
4402 50	24.3222-1102.3	020257	4745 63	24.3727-0802.2	580802	4861 49	24.6042-1701.3	320149
4402 51	24.3220-1105.3	020216	4745 64	24.3727-0801.2	580801			
4402 52	24.3222-1708.3	020407	4745 65	24.3727-0806.2	580806			
4402 53	24.3220-1105.3	020216	4745 66	24.3727-0805.2	580805			
4402 57	24.3220-1619.3	020246	4745 67	24.3727-0810.2	580810	PORSCHE		
4402 59	24.3222-1615.3	020285	4745 68	24.3727-0811.2	580811	1750 312 211	24.3526-0100.3	340017
4402 62	24.3220-0905.3	020207	4745 71	24.3727-0831.2	580831	191 611 776 A	83.6301-0150.3	330342
4402 65	24.3219-1605.3	020202	4745 73	24.3727-0804.2	580804	298 609 723	03.0137-9700.2	669700
4402 66	24.3219-1606.3	020203	4745 74	24.3727-0803.2	580803	356 42 020	03.3119-0211.3	010258
4402 67	24.3220-1609.3	020236	4745 75	24.3727-0809.2	580809	356 42 028	83.6101-0520.3	330215
4402 68	24.3220-1610.3	020237	4745 76	24.3727-0808.2	580808	356 42 125	03.2719-0209.3	020002
4402 70	24.3225-1101.3	020294	4745 89	24.3727-0807.2	580807	356 42 126	03.2719-0309.3	020003
4402 73	24.3219-1601.3	020198	4745 F6	24.3727-0304.2	580304	477 405 083 A	24.0120-0103.1	420103
4402 74	24.3219-1602.3	020199	4745 F8	24.3727-0307.2	580307	477 405 583 B	24.0113-0170.1	413170
4402 75	24.3219-1118.3	020332	4745 F9	24.3727-0305.2	580305	477 501 615 A	24.0223-0004.1	480034
4402 79	24.3222-1709.3	020111	4745 G1	24.3727-0306.2	580306	477 609 537 B	03.0137-0041.2	650041
4402 80	24.3222-1710.3	020112	4745 H7	24.3727-0816.2	580816	477 609 720	24.3727-0902.2	580902
4402 81	24.3226-1101.3	020296	4745 T4	24.3727-0816.2	580816	477 611 015 A	03.2120-0322.3	010074
4402 82	24.3220-1611.3	020238	4806 15	24.5112-0405.3	330428	477 611 017	03.2123-7902.3	010191
4402 83	24.3220-1612.3	020239	4806 21	24.5122-0460.3	330493	477 611 017 A	03.2123-8902.3	010197
4402 86	24.3220-1607.3	020234	4806 24	24.5112-0381.3	330711	477 611 055 E	24.3219-0906.3	020187
4402 87	24.3220-1608.3	020235	4806 29	24.5112-0362.3	330512	477 611 071 A	24.5171-0393.3	331311
4402 88	24.3220-1609.3	020236	4806 31	24.5112-0325.3	330415	477 611 071 B	83.6101-0412.3	330212
4402 89	24.3220-1610.3	020237	4806 32	24.5112-0405.3	330428	477 611 775	83.6201-0175.3	330663
4402 90	24.3219-1603.3	020200	4806 35	24.5112-0230.3	330508	477 612 107 F	03.7750-5702.4	300083
4402 91	24.3219-1604.3	020201	4806 36	24.5112-0435.3	330524	477 698 151 A	13.0460-3612.2	603612
4402 92	24.3219-1112.3	020311	4806 37	24.5112-0436.3	330574	477 698 151 B	13.0460-3612.2	603612
4402 93	24.3219-1609.3	020319	4806 39	24.5112-0327.3	330417	477 721 171	24.2419-0926.3	030054
4402 94	24.3219-1610.3	020320	4806 40	24.5118-0470.3	330462	550 23 407	83.6101-0520.3	330215
4402 97	24.3220-1617.3	020244	4806 41	24.5229-0181.3	330533	550 42 332	24.5165-0425.3	331258
4402 98	24.3220-1618.3	020245	4806 42	24.5111-0235.3	330477	550 42 335	24.5224-0330.3	331263
4402 A0	24.3220-1615.3	020242	4806 46	24.5118-0420.3	330444	644 351 912 00	03.0470-2619.2	060051
4402 A1	24.3220-1616.3	020243	4806 47	24.5118-0420.3	330444	644 352 513 01	03.3219-0102.3	020036
4402 A6	24.3220-1715.3	020412	4806 48	24.5229-0181.3	330533	644 42 311	24.5165-0350.3	331257
4402 A8	24.3220-1711.3	020409	4806 50	24.5111-0235.3	330477	644 552 513 00	03.3219-0102.3	020036
4402 C3	24.3220-1711.3	020409	4806 52	24.5112-0405.3	330428	655 352 513 01	03.3219-0102.3	020036
4427 26	13.0460-0402.2	610402	4806 53	24.5112-0155.3	330507	695 351 511 00	03.2719-0209.3	020002
4427 30	13.0460-0404.2	610404	4806 54	24.5228-0255.3	330409	695 351 512 00	03.2719-0309.3	020003
4427 55	13.0460-0435.2	610435	4806 55	24.5112-0327.3	330417	695 351 681 90	24.5225-0300.3	331266
4427 65	13.0460-0403.2	610403	4806 56	24.5111-0330.3	330160	695 352 513 01	03.3219-0102.3	020036
4427 66	13.0460-0424.2	610424	4806 57	24.5111-0290.3	330108	695 352 631 00	83.6101-0240.3	330202
4427 70	11.8116-0073.1	390498	4806 61	24.5229-0199.3	330534	695 355 011 00	03.3119-6551.3	010270
4427 84	11.8116-0129.1	390591	4806 64	24.5229-0199.3	330534	695 355 919 00	03.3304-0700.1	390082
4427 94	13.0460-0424.2	610424	4806 65	24.5228-0245.3	330531	803 698 471 C	11.0441-4802.2	250017
4439 14	11.0101-5407.2	260011	4806 68	24.5228-0195.3	330469	875 128 900 01	03.0370-1131.2	051131
4439 33	11.8171-0008.1	990049	4806 74	24.5111-0301.3	330499	901 351 041 16	24.0120-0103.1	420103
4448 34	11.0441-5401.2	250027	4806 75	24.5112-0325.3	330415	901 351 041 18	24.0120-0103.1	420103
4448 70	11.0441-4501.2	250015	4806 81	24.5229-0211.3	330573	901 351 963 22	13.0462-4855.2	600018
4448 74	11.0441-4811.2	250024	4806 85	24.5111-0301.3	330499	901 351 963 25	13.0462-4855.2	600018
4448 76	11.0441-3602.2	250008	4806 86	24.5111-0438.3	330568	901 351 964 00	13.0441-4801.2	250100
4575 08	24.7718-7301.2	990024	4806 93	24.5229-0255.3	330581	901 351 964 11	13.0441-4815.2	250102
4601 65	24.2119-1503.3	010404	4806 99	24.5229-0240.3	330400	901 351 998 00	13.0441-4806.2	250101
4601 71	03.2120-1122.3	010084	4806 A2	24.5228-0180.3	330761	901 352 041 14	24.0120-0185.1	420185
4601 75	24.2117-1501.3	010398	4806 A9	24.5228-0180.3	330761	901 352 964 11	13.0441-3502.2	250049
4601 76	24.2119-1704.3	010339	4806 C4	24.5111-0460.3	330603	901 352 985 10	13.2381-9996.2	210039
4601 83	24.2122-0801.3	010373	4806 E0	83.6401-0159.3	330746	901 352 986 10	13.2381-9997.2	210040
4601 84	03.2119-1281.3	010054	4816 19	24.5111-0460.3	330603	901 352 997 00	13.0462-4855.2	600018
4601 85	03.2120-2031.3	010106	4816 20	24.5228-0216.3	330908	901 352 998 00	13.0441-3805.2	250061
4601 87	03.2119-3389.3	010057	4816 26	24.5228-0216.3	330908	901 355 011 01	03.3119-7251.3	010272
4601 88	24.2122-0801.3	010373	4816 27	24.5228-0185.3	330107	901 355 012 00	03.2119-2301.3	010055
4601 89	03.2119-3389.3	010057	4816 29	24.5112-0260.3	330577	901 355 012 02	03.2119-0881.3	010053
4601 92	03.2119-3389.3	010057	4816 31	24.5228-0255.3	330409	901 355 631 00	24.5225-0240.3	331321
4601 94	24.2120-1701.3	010427	4816 32	24.5112-0285.3	330604	901 355 631 01	24.5225-0240.3	331321
4601 97	03.2119-3389.3	010057	4816 36	24.5112-0155.3	330507	901 355 632 01	24.5225-0300.3	331266
4601 98	24.2122-1704.3	010423	4834 76	24.5112-0315.3	330509	901 355 929 00	03.3304-0700.1	390082
4601 A2	03.2119-3389.3	010057	4861 20	24.3727-0527.2	580527	901 399 500 51	13.2381-9996.2	210039
				03.6515-0600.3	320088	901 399 500 52	13.2381-9997.2	210040



Vergleichsliste

Cross reference list - Tabella di conversione codici

Liste des correspondances - Lista referencias



PORSCHE			PORSCHE			PORSCHE		
901 613 401 00	24.3526-0810.3	340037	928 355 011 23	03.2023-0183.3	010017	964 355 139 00	83.6220-0296.3	330324
904 351 964 00	13.0441-4819.2	250104	928 355 011 24	03.2023-0262.3	010020	964 612 211 00	24.8190-0917.2	620917
906 355 632 00	24.5165-0425.3	331258	928 355 023 06	03.7760-0402.4	300087	964 612 363 00	24.8190-0917.2	620917
910 355 634 00	24.5165-0425.3	331258	928 355 023 09	03.7760-0402.4	300087	964 612 363 01	24.8190-0917.2	620917
911 351 041 20	24.0120-0103.1	420103	928 355 079 00	83.6121-0340.3	330261	964 612 365 01	24.8190-0918.2	620918
911 351 041 22	24.0124-0189.1	424189	928 355 080 01	83.6121-0250.3	330260	993 351 043 01	24.0132-0142.1	432142
911 351 425 00	13.2481-8067.2	210098	928 355 080 02	83.6121-0250.3	330260	993 351 044 01	24.0132-0143.1	432143
911 351 425 01	13.2481-8067.2	210098	928 355 081 01	83.6289-0391.3	330341	993 351 045 10	24.0132-0163.2	432163
911 351 425 02	13.2481-8067.2	210098	928 355 081 02	83.6289-0391.3	330341	993 351 046 10	24.0132-0164.2	432164
911 351 425 03	13.2481-0075.2	210081	928 355 626 00	83.6101-0250.3	330203	993 351 949 00	13.0460-4056.2	604056
911 351 426 00	13.2481-8068.2	210099	928 612 311 01	24.8190-0903.2	620903	993 352 041 02	24.0124-0183.1	424183
911 351 426 01	13.2481-8068.2	210099	928 612 311 02	24.8190-0903.2	620903	993 352 071 00	03.0137-9700.2	669700
911 351 426 02	13.2481-8068.2	210099	928 612 311 03	24.8190-0903.2	620903	993 355 129 00	83.6116-0226.3	330454
911 351 426 03	13.2481-0076.2	210082	928 612 313 02	24.8190-0910.2	620910	993 355 139 00	83.6220-0296.3	330324
911 351 907 00	13.2481-9999.2	210103	928 612 315 02	24.8190-0909.2	620909	993 612 365 01	24.8190-0920.2	620920
911 351 908 00	13.2481-9998.2	210102	928 612 363 00	24.8190-0919.2	620919	993 612 368 00	24.8190-0926.2	620926
911 351 938 00	13.0462-4855.2	600018	928 612 363 01	24.8190-0919.2	620919	993 612 965 00	24.8190-0927.2	620927
911 351 946 00	13.0441-4819.2	250104	928 612 365 00	24.8190-0915.2	620915	993 612 965 01	24.8190-0927.2	620927
911 351 949 01	13.0460-4048.2	604048	928 612 365 01	24.8190-0915.2	620915	996 352 993 00	03.0137-3002.2	653002
911 351 950 00	13.0460-4048.2	604048	928 612 366 00	24.8190-0925.2	620925	996 352 993 01	03.0137-3002.2	653002
911 351 950 01	13.0460-4048.2	604048	930 351 047 02	24.0132-0140.1	432140	996 352 993 02	03.0137-3002.2	653002
911 351 950 02	13.0460-4048.2	604048	930 351 048 02	24.0132-0146.1	432146			
911 351 950 06	13.0460-4048.2	604048	930 352 045 01	24.0128-0171.1	428171			
911 352 041 08	24.0124-0190.1	424190	930 352 046 01	24.0128-0172.1	428172			
911 352 425 00	13.2421-0026.2	210146	930 355 011 01	03.2123-0162.3	010162	PROTON		
911 352 426 00	13.2421-0025.2	210145	930 355 011 02	03.2123-0162.3	010162	MB618981	24.3219-1752.3	020505
911 352 903 00	13.0462-4855.2	600018	930 355 011 03	03.2123-0162.3	010162	MB699280	24.0113-0186.1	413186
911 352 905 00	13.0441-4206.2	250087	937 355 011 00	03.2023-0172.3	010016	MB699281	24.0113-0186.1	413186
911 352 907 00	13.2381-9996.2	210039	944 116 237 00	24.2523-0903.3	040045	MB699283	24.0118-0120.1	418120
911 352 908 00	13.2381-9997.2	210040	944 351 011 11	03.2023-0562.3	010025	MB858375	13.0460-5952.2	605952
911 352 949 00	13.0462-4855.2	600018	944 351 023 11	03.7750-5702.4	300083	MB895072	13.0460-5952.2	605952
911 352 950 00	13.0462-4855.2	600018	944 351 041 05	24.0121-0112.1	421112	MB928314	13.0460-5826.2	605826
911 352 950 01	13.0462-4855.2	600018	944 351 950 06	13.0460-4048.2	604048	MB928817	13.0460-5953.2	605953
911 352 950 02	13.0462-4855.2	600018	944 352 041 02	24.0120-0112.1	420112			
911 352 950 03	13.0462-4855.2	600018	944 352 041 03	24.0120-0104.1	420104			
911 352 950 06	13.0462-4855.2	600018	944 352 951 00	13.0460-3612.2	603612	RENAULT		
911 352 951 00	13.0460-0192.2	610192	944 352 951 01	13.0460-3612.2	603612	08 54 697 500	24.3223-1102.3	020289
911 352 951 01	13.0460-0193.2	610193	944 352 951 02	13.0460-3612.2	603612	08 54 697 600	24.3223-1101.3	020288
911 352 998 00	13.0441-3801.2	250058	944 355 011 00	03.2023-0172.3	010016	08 55 860 900	24.3120-1702.3	010467
911 355 011 10	03.2120-2462.3	010113	944 355 011 01	03.2023-0172.3	010016	08 70 313 300	24.3223-1102.3	020289
911 355 011 11	03.2120-2462.3	010113	944 355 011 11	03.2023-0172.3	010016	08 70 313 400	24.3223-1101.3	020288
911 355 011 12	03.2120-2462.3	010113	944 355 023 00	03.2023-0562.3	010025	08 70 313 500	24.3219-1101.3	020189
911 355 012 01	03.2119-0881.3	010053	944 355 023 01	03.7750-5702.4	300083	41 06 021 92R	13.0460-2834.2	602834
911 355 012 02	03.2119-0881.3	010053	944 355 023 11	03.7750-5702.4	300083	41 06 093 42R	13.0460-2834.2	602834
911 355 087 00	83.6205-0252.3	330315	944 355 079 00	24.5165-0415.3	331320	44 0A 088 07R	11.0101-5407.2	260011
914 355 012 00	03.2117-1601.3	010039	944 355 079 01	24.5165-0415.3	331320	50 00 240 867	24.3526-0100.3	340017
914 355 130 00	03.3304-0700.1	390082	944 355 081 00	83.6201-0175.3	330663	50 00 241 153	24.3526-0100.3	340017
914 355 929 00	03.3304-0700.1	390082	944 355 081 01	83.6201-0175.3	330663	50 00 388 496	24.5112-0315.3	330509
928 116 237 20	24.2522-0908.3	040044	944 612 211 00	24.8190-0904.2	620904	50 00 988 565	24.3526-0100.3	340017
928 116 237 22	24.2522-0908.3	040044	944 612 211 01	24.8190-0905.2	620905	50 01 000 446	24.3225-1101.3	020294
928 351 043 01	24.0132-0127.1	432127	944 612 211 02	24.8190-0905.2	620905	55 16 017 643	24.3526-1900.0	340038
928 351 043 03	24.0132-0151.1	432151	944 612 212 01	24.8190-0904.2	620904	60 01 006 990	24.3727-1017.2	581017
928 351 043 04	24.0132-0151.1	432151	944 612 365 00	24.8190-0913.2	620913	60 01 547 616	24.3481-1611.5	240029
928 351 043 60	24.0132-0151.1	432151	944 612 365 01	24.8190-0916.2	620916	60 01 547 617	24.3481-1612.5	240030
928 351 044 01	24.0132-0128.1	432128	950 116 237 07	24.8190-0916.2	620916	60 01 547 619	13.0460-2834.2	602834
928 351 044 03	24.0132-0150.1	432150	950 116 237 10	24.2523-0909.3	040050	60 01 547 630	03.0137-0312.2	650312
928 351 044 04	24.0132-0150.1	432150	950 116 237 11	24.2523-0909.3	040050	60 01 547 684	24.0112-0116.1	412116
928 351 044 60	24.0132-0150.1	432150	950 116 237 12	24.2523-0909.3	040050	60 01 547 703	24.0220-3021.1	480127
928 351 941 00	11.0441-5401.2	250027	951 351 041 00	24.2523-0909.3	040050	60 01 547 816	24.5111-0300.3	330407
928 351 943 00	11.0441-5402.2	250028	951 351 041 01	24.0128-0165.1	428165	60 01 547 819	24.5111-0300.3	330407
928 351 947 00	11.8171-0008.1	990049	951 351 041 02	24.0128-0167.1	428167	60 01 547 820	24.5229-0285.3	330032
928 351 949 00	11.0101-5407.2	260011	951 352 041 01	24.0128-0167.1	428167	60 01 547 911	13.0460-2834.2	602834
928 351 949 02	13.0460-4056.2	604056	951 352 041 02	24.0124-0116.1	424116	60 01 548 126	24.0218-0032.1	480118
928 351 949 03	13.0460-4056.2	604056	951 352 041 02	24.0124-0117.1	424117	60 01 549 211	24.0112-0116.1	412116
928 352 041 02	24.0120-0112.1	420112	951 355 011 01	03.2023-0542.3	010024	60 01 551 097	24.5229-0285.3	330032
928 352 941 00	11.0441-3601.2	250007	951 355 079 30	83.6251-0301.3	330556	60 06 004 557	24.3728-1006.2	591006
928 352 951 00	13.0460-3612.2	603612	951 355 079 31	83.6251-0301.3	330556	60 25 001 018	03.6583-0005.3	320099
928 352 951 02	13.0460-3612.2	603612	955 352 098 00	03.0137-9700.2	669700	60 25 002 627	24.3727-1031.2	581031
928 352 952 01	13.0460-3612.2	603612	964 351 041 02	24.0128-0174.1	428174	60 25 002 628	24.3727-1031.2	581031
928 355 011 03	03.2123-9002.3	010198	964 352 949 01	13.0460-4070.2	604070	60 25 004 479	03.2120-2031.3	010106
928 355 011 04	03.2123-9002.3	010198	964 352 949 03	13.0460-4070.2	604070	60 25 071 042	13.0460-2834.2	602834
			964 352 969 03	13.0460-4070.2	604070	60 25 103 090	24.3728-1015.2	591015



Vergleichsliste

Cross reference list - Tabella di conversione codici

Liste des correspondances - Lista referencias



RENAULT		RENAULT		RENAULT				
60 25 103 091	24.3728-1015.2	591015	77 00 780 077	24.0108-0108.1	408108	77 01 033 599	24.3220-1714.3	020411
60 25 105 202	03.6750-2902.4	300037	77 00 780 078	24.0108-0108.1	408108	77 01 033 600	24.3220-1713.3	020410
60 25 105 918	24.3727-1024.2	581024	77 00 780 892	24.0121-0106.1	421106	77 01 033 706	24.3220-1618.3	020245
60 25 105 919	24.3727-1024.2	581024	77 00 781 393	24.3727-1012.2	581012	77 01 033 707	24.3220-1617.3	020244
60 25 170 170	13.0460-2810.2	602810	77 00 781 394	24.3727-1011.2	581011	77 01 034 172	24.3223-1106.3	020317
60 25 170 405	24.2123-1701.3	010424	77 00 783 030	24.0218-0032.1	480118	77 01 034 173	24.3222-1118.3	020315
60 25 170 586	13.0460-3961.2	603961	77 00 783 030	24.0218-0732.2	480207	77 01 035 310	24.3220-1624.3	020354
60 25 170 698	03.0137-0271.2	650271	77 00 783 392	24.0218-0013.1	480008	77 01 035 311	24.3220-1623.3	020353
60 25 170 727	24.3728-1015.2	591015	77 00 787 470	24.3728-1005.2	591005	77 01 035 405	24.3220-1615.3	020242
60 25 170 728	24.3728-1015.2	591015	77 00 787 630	03.2120-2031.3	010106	77 01 035 406	24.3220-1616.3	020243
60 25 170 860	13.0460-3961.2	603961	77 00 787 634	03.2119-3389.3	010057	77 01 035 464	24.3220-1713.3	020410
60 25 170 972	03.2122-0626.3	010539	77 00 793 047	24.0121-0101.1	421101	77 01 035 465	24.3220-1714.3	020411
60 25 171 255	24.3728-1015.2	591015	77 00 793 558	03.2120-2031.3	010106	77 01 035 467	24.3222-1617.3	020324
60 25 171 256	24.3728-1026.2	591026	77 00 793 631	24.0112-0133.1	412133	77 01 035 468	24.3222-1618.3	020325
60 25 171 456	13.0460-2810.2	602810	77 00 799 541	03.2125-3801.3	010215	77 01 035 471	24.3220-1617.3	020244
60 25 171 471	24.3727-1031.2	581031	77 00 801 101	24.0121-0101.1	421101	77 01 035 472	24.3220-1618.3	020245
60 25 171 473	24.3727-1024.2	581024	77 00 801 213	24.0121-0103.1	421103	77 01 035 473	24.3220-1623.3	020353
60 25 307 608	24.5111-0260.3	330408	77 00 804 076	03.2122-9631.3	010160	77 01 035 474	24.3220-1624.3	020354
60 25 308 186	13.0460-4957.2	604957	77 00 804 356	24.5111-0241.3	330680	77 01 035 475	24.3222-1709.3	020111
60 25 370 305	03.0137-0347.2	650347	77 00 804 813	24.5229-0220.3	330399	77 01 035 476	24.3222-1710.3	020112
77 00 308 909	24.5111-0300.3	330407	77 00 804 899	24.2120-1725.3	010579	77 01 035 477	24.3222-1615.3	020285
77 00 419 824	24.0218-0032.1	480118	77 00 804 900	03.2120-2031.3	010106	77 01 036 385	24.3220-1623.3	020353
77 00 419 824	24.0218-0732.2	480207	77 00 804 901	03.2119-3389.3	010057	77 01 036 386	24.3220-1624.3	020354
77 00 421 739	24.0222-8019.2	480087	77 00 811 013	24.3728-1005.2	591005	77 01 039 388	24.3220-1623.3	020353
77 00 428 821	24.0220-3021.1	480127	77 00 811 705	24.5111-0386.3	330503	77 01 039 389	24.3220-1624.3	020354
77 00 502 515	24.0110-0139.1	410139	77 00 813 549	24.0121-0106.1	421106	77 01 039 390	24.3222-1617.3	020324
77 00 525 690	24.3119-1703.3	010466	77 00 816 858	24.3727-1012.2	581012	77 01 039 391	24.3222-1618.3	020325
77 00 543 284	24.3222-1125.3	020356	77 00 817 136	24.3727-1011.2	581011	77 01 039 392	24.3220-1617.3	020244
77 00 561 367	24.0124-0103.1	424103	77 00 818 346	24.0220-3021.1	480127	77 01 039 393	24.3220-1618.3	020245
77 00 571 639	24.3727-1036.2	581036	77 00 824 736	24.5111-0241.3	330680	77 01 039 394	24.3220-1623.3	020353
77 00 571 640	24.3727-1037.2	581037	77 00 827 866	24.0220-3021.1	480127	77 01 039 395	24.3220-1624.3	020354
77 00 588 892	24.2528-0908.3	040065	77 00 829 553	24.0108-0108.1	408108	77 01 041 021	24.3220-1711.3	020409
77 00 617 298	24.2120-1715.3	010469	77 00 832 611	24.5111-0280.3	330389	77 01 043 789	24.3220-1713.3	020410
77 00 617 708	03.2119-0781.3	010052	77 00 834 725	24.3728-1005.2	591005	77 01 043 790	24.3220-1714.3	020411
77 00 618 661	03.2119-0781.3	010052	77 00 839 322	24.0220-3021.1	480127	77 01 049 101	11.8171-0008.1	990049
77 00 618 662	24.2120-1503.3	010397	77 00 842 116	24.6583-1710.3	320166	77 01 049 280	11.8116-0301.1	390610
77 00 624 692	03.2119-0781.3	010052	77 00 842 131	24.0121-0106.1	421106	77 01 049 765	11.8116-0301.1	390610
77 00 659 282	24.7718-7301.2	990024	77 00 845 510	24.5111-0396.3	330609	77 01 200 355	13.0460-3928.2	603928
77 00 660 977	24.2119-1703.3	010323	77 00 859 233	24.3728-1006.2	591006	77 01 200 360	13.0460-3961.2	603961
77 00 665 654	24.2120-1709.3	010276	77 01 001 628	24.3223-1102.3	020289	77 01 201 159	13.0460-2967.2	602967
77 00 666 325	03.2119-1281.3	010054	77 01 001 629	24.3223-1101.3	020288	77 01 201 208	03.0137-0082.2	650082
77 00 685 063	03.6512-0100.3	320077	77 01 002 948	24.3220-1101.3	020212	77 01 201 209	03.0137-0082.2	650082
77 00 692 363	24.0225-4019.1	480305	77 01 002 994	24.3223-1101.3	020288	77 01 201 229	03.0137-0271.2	650271
77 00 694 069	03.2119-1281.3	010054	77 01 002 995	24.3223-1102.3	020289	77 01 201 321	13.0460-3961.2	603961
77 00 701 834	03.2120-1142.3	010085	77 01 004 720	03.0137-9039.2	669039	77 01 201 381	03.0137-0124.2	650124
77 00 704 705	24.0112-0116.1	412116	77 01 007 119	24.3119-1702.3	010465	77 01 201 399	03.0137-0271.2	650271
77 00 710 511	24.0222-8015.1	480055	77 01 010 665	03.0137-9020.2	669020	77 01 201 533	03.0137-9211.2	669211
77 00 710 664	24.0122-0143.1	422143	77 01 012 340	03.0137-9028.2	669028	77 01 201 534	13.0460-3968.2	603968
77 00 715 081	24.0120-0126.1	420126	77 01 024 247	24.3222-1108.3	020263	77 01 201 542	13.0460-3911.2	603911
77 00 715 165	24.0112-0133.1	412133	77 01 024 248	24.3222-1109.3	020264	77 01 201 551	03.0137-9032.2	669032
77 00 715 166	24.0112-0134.1	412134	77 01 024 260	24.3222-1103.3	020258	77 01 201 617	03.0137-0036.2	650036
77 00 716 684	24.2123-1702.3	010431	77 01 024 266	24.3222-1107.3	020262	77 01 201 618	03.0137-9013.2	669013
77 00 716 947	24.0108-0104.1	408104	77 01 025 933	24.3222-1118.3	020315	77 01 201 664	24.3541-1625.5	240045
77 00 717 331	24.2123-1702.3	010431	77 01 025 935	24.3223-1106.3	020317	77 01 201 665	24.3541-1626.5	240046
77 00 723 303	03.2125-3801.3	010215	77 01 026 367	24.3222-1710.3	020112	77 01 201 669	13.0460-2834.2	602834
77 00 724 410	24.2117-1503.3	010400	77 01 026 368	24.3222-1709.3	020111	77 01 201 687	03.0137-9055.2	669055
77 00 724 411	03.2119-3389.3	010057	77 01 026 418	24.3223-1101.3	020288	77 01 201 769	24.3481-1611.5	240029
77 00 726 005	03.2119-3389.3	010057	77 01 026 419	24.3223-1102.3	020289	77 01 201 770	24.3481-1612.5	240030
77 00 732 756	24.2528-0908.3	040065	77 01 027 198	24.3222-1710.3	020112	77 01 201 823	03.0137-9056.2	669056
77 00 734 129	03.2120-2682.3	010118	77 01 027 199	24.3222-1709.3	020111	77 01 201 836	13.0460-0411.2	610411
77 00 737 184	24.2120-1709.3	010276	77 01 030 155	24.3225-1601.3	020359	77 01 201 864	13.0460-3961.2	603961
77 00 754 882	24.3727-1005.2	581005	77 01 031 504	24.3222-1709.3	020111	77 01 201 965	24.3481-1615.5	240031
77 00 756 572	24.0120-0125.1	420125	77 01 031 505	24.3222-1710.3	020112	77 01 201 966	24.3481-1616.5	240032
77 00 757 354	24.0218-0013.1	480008	77 01 032 318	24.3222-1122.3	020335	77 01 201 984	24.3481-1505.5	240047
77 00 758 901	24.0120-0135.1	420135	77 01 032 319	24.3222-1123.3	020336	77 01 201 985	24.3481-1506.5	240048
77 00 764 192	24.0111-0122.1	411122	77 01 032 924	24.3220-1603.3	020230	77 01 201 987	13.0460-0411.2	610411
77 00 764 193	24.0120-0134.1	420134	77 01 032 925	24.3220-1604.3	020231	77 01 202 050	13.0460-2983.2	602983
77 00 766 098	24.3727-1010.2	581010	77 01 033 311	24.3222-1618.3	020325	77 01 202 057	13.0460-3911.2	603911
77 00 767 602	24.0122-0143.1	422143	77 01 033 312	24.3222-1617.3	020324	77 01 202 141	13.0460-0435.2	610435
77 00 773 916	24.0711-1403.3	360100	77 01 033 390	24.3220-1623.3	020353	77 01 202 148	13.0460-3961.2	603961
77 00 778 708	24.0111-0150.1	411150	77 01 033 391	24.3220-1624.3	020354	77 01 202 205	03.0137-0153.2	650153



Vergleichsliste

Cross reference list - Tabella di conversione codici

Liste des correspondances - Lista referencias

RENAULT		RENAULT		RENAULT				
77 01 202 206	24.3451-1501.5	240263	77 01 203 563	03.0137-0271.2	650271	77 01 205 098	03.0520-1020.3	691020
77 01 202 207	24.3451-1502.5	240264	77 01 203 633	13.0460-4957.2	604957	77 01 205 099	03.0520-1022.3	691022
77 01 202 210	13.0460-3954.2	603954	77 01 203 668	13.0460-3822.2	603822	77 01 205 104	03.0520-3122.3	693122
77 01 202 213	13.0460-3955.2	603955	77 01 203 716	03.0137-0151.2	650151	77 01 205 105	03.0520-0522.3	690522
77 01 202 227	13.0460-3955.2	603955	77 01 203 719	24.2123-1701.3	010424	77 01 205 132	03.2125-3801.3	010215
77 01 202 283	13.0460-3911.2	603911	77 01 203 726	13.0460-4957.2	604957	77 01 205 308	03.0520-2422.3	692422
77 01 202 284	13.0460-2834.2	602834	77 01 203 728	13.0460-0438.2	610438	77 01 205 309	03.0520-1722.3	691722
77 01 202 285	13.0460-2834.2	602834	77 01 203 730	13.0460-2983.2	602983	77 01 205 311	03.0520-1122.3	691122
77 01 202 288	03.0137-0201.2	650201	77 01 203 775	13.0460-2834.2	602834	77 01 205 312	03.0520-1122.3	691122
77 01 202 289	13.0460-2834.2	602834	77 01 203 795	13.0460-2834.2	602834	77 01 205 315	03.0520-6320.3	696320
77 01 202 308	13.0460-3954.2	603954	77 01 203 796	13.0460-2834.2	602834	77 01 205 355	13.0460-2834.2	602834
77 01 202 347	03.0137-9086.2	669086	77 01 203 797	13.0460-2834.2	602834	77 01 205 462	03.0520-6320.3	696320
77 01 202 380	03.0137-9027.2	669027	77 01 203 862	03.0420-1020.3	681020	77 01 205 495	13.0460-0438.2	610438
77 01 202 381	03.0137-0271.2	650271	77 01 203 913	13.0460-3969.2	603969	77 01 205 496	13.0460-0438.2	610438
77 01 202 384	03.0137-0271.2	650271	77 01 203 918	13.0460-3969.2	603969	77 01 205 518	03.0137-9228.2	669228
77 01 202 475	13.0460-3911.2	603911	77 01 203 919	13.0460-3822.2	603822	77 01 205 653	24.0121-0106.1	421106
77 01 202 481	13.0460-3933.2	603933	77 01 203 968	13.0460-2983.2	602983	77 01 205 663	03.0520-0825.3	690825
77 01 202 516	13.0460-2834.2	602834	77 01 203 979	03.0137-0312.2	650312	77 01 205 689	03.0137-0153.2	650153
77 01 202 517	13.0460-3955.2	603955	77 01 203 980	03.0137-9158.2	669158	77 01 205 720	03.0137-0312.2	650312
77 01 202 518	13.0460-3911.2	603911	77 01 204 036	13.0460-3822.2	603822	77 01 205 725	03.0520-0825.3	690825
77 01 202 542	03.0137-0209.2	650209	77 01 204 066	13.0460-2834.2	602834	77 01 205 756	03.0137-9088.2	669088
77 01 202 543	03.0137-0211.2	650211	77 01 204 087	13.0460-3933.2	603933	77 01 205 915	03.0137-0330.2	650330
77 01 202 550	03.0137-9125.2	669125	77 01 204 216	03.0137-0201.2	650201	77 01 205 916	03.0520-0825.3	690825
77 01 202 598	03.0137-0153.2	650153	77 01 204 220	13.0460-2983.2	602983	77 01 205 917	03.0137-0036.2	650036
77 01 202 662	13.0460-3954.2	603954	77 01 204 236	03.0520-0922.3	690922	77 01 206 082	13.0460-2834.2	602834
77 01 202 709	13.0460-3968.2	603968	77 01 204 268	03.0137-0209.2	650209	77 01 206 288	13.0460-2983.2	602983
77 01 202 710	13.0460-3955.2	603955	77 01 204 281	24.0124-0103.1	424103	77 01 206 339	24.0121-0106.1	421106
77 01 202 711	13.0460-3911.2	603911	77 01 204 282	24.0112-0116.1	412116	77 01 206 962	03.0137-0312.2	650312
77 01 202 712	13.0460-2834.2	602834	77 01 204 283	24.0120-0126.1	420126	77 01 206 972	03.0137-9158.2	669158
77 01 202 713	13.0460-3969.2	603969	77 01 204 285	24.0108-0104.1	408104	77 01 207 066	13.0460-2834.2	602834
77 01 202 785	13.0460-3933.2	603933	77 01 204 286	24.0120-0125.1	420125	77 01 207 958	24.3481-1615.5	240031
77 01 202 788	13.0460-3961.2	603961	77 01 204 288	24.0111-0122.1	411122	77 01 207 959	24.3481-1616.5	240032
77 01 202 815	13.0460-3933.2	603933	77 01 204 289	24.0122-0143.1	422143	77 01 207 960	13.0460-2834.2	602834
77 01 202 820	03.0137-0209.2	650209	77 01 204 291	24.0111-0150.1	411150	77 01 208 111	03.0137-0312.2	650312
77 01 202 847	13.0460-3911.2	603911	77 01 204 293	24.0108-0108.1	408108	77 01 208 171	24.3481-1611.5	240029
77 01 202 848	13.0460-2834.2	602834	77 01 204 294	24.0108-0108.1	408108	77 01 208 172	24.3481-1612.5	240030
77 01 202 890	13.0460-3928.2	603928	77 01 204 298	24.0121-0101.1	421101	77 01 208 265	13.0460-2834.2	602834
77 01 202 891	13.0460-3955.2	603955	77 01 204 299	24.0121-0103.1	421103	77 01 210 130	13.0460-2834.2	602834
77 01 202 892	13.0460-3911.2	603911	77 01 204 304	24.0121-0106.1	421106	77 01 210 142	13.0460-2834.2	602834
77 01 202 893	13.0460-2967.2	602967	77 01 204 357	13.0460-2834.2	602834	77 01 348 071	13.0460-3928.2	603928
77 01 202 894	13.0460-2834.2	602834	77 01 204 358	13.0460-2834.2	602834	77 01 348 206	03.2119-0781.3	010052
77 01 202 895	13.0460-2834.2	602834	77 01 204 523	24.0108-0108.1	408108	77 01 348 224	24.2120-1718.3	010491
77 01 202 896	13.0460-2983.2	602983	77 01 204 530	13.0460-3911.2	603911	77 01 348 286	24.3119-1703.3	010466
77 01 202 897	03.0137-0036.2	650036	77 01 204 605	03.2120-2031.3	010106	77 01 348 468	24.2120-1715.3	010469
77 01 202 898	03.0137-0201.2	650201	77 01 204 608	03.2120-2031.3	010106	77 01 348 483	24.3119-1702.3	010465
77 01 202 899	03.0137-0201.2	650201	77 01 204 609	24.2120-1725.3	010579	77 01 348 682	13.0460-3968.2	603968
77 01 202 900	03.0137-0153.2	650153	77 01 204 626	13.0460-3954.2	603954	77 01 348 684	13.0460-3928.2	603928
77 01 202 903	13.0460-3961.2	603961	77 01 204 634	03.0137-0330.2	650330	77 01 348 689	13.0460-3961.2	603961
77 01 202 919	03.0137-0211.2	650211	77 01 204 635	03.0137-9216.2	669216	77 01 348 726	24.2119-1703.3	010323
77 01 202 921	03.0137-0271.2	650271	77 01 204 637	03.0137-0330.2	650330	77 01 348 863	13.0460-3928.2	603928
77 01 202 922	03.0137-0124.2	650124	77 01 204 638	03.0137-0036.2	650036	77 01 349 049	13.0460-3928.2	603928
77 01 202 954	13.0460-3928.2	603928	77 01 204 639	03.0137-0330.2	650330	77 01 349 122	24.3222-1710.3	020112
77 01 202 967	03.0137-0203.2	650203	77 01 204 664	13.0460-3954.2	603954	77 01 349 123	24.3222-1709.3	020111
77 01 202 973	13.0460-2983.2	602983	77 01 204 673	03.0520-0125.3	690125	77 01 349 150	24.3222-1101.3	020256
77 01 202 985	24.3481-1505.5	240047	77 01 204 708	13.0460-3911.2	603911	77 01 349 254	03.2119-1281.3	010054
77 01 202 986	24.3481-1506.5	240048	77 01 204 828	24.0121-0106.1	421106	77 01 349 391	24.3223-1101.3	020288
77 01 202 987	24.0101-4803.2	260049	77 01 204 831	24.5111-0405.3	330410	77 01 349 392	24.3223-1102.3	020289
77 01 203 068	13.0460-3961.2	603961	77 01 204 833	13.0460-2834.2	602834	77 01 349 448	13.0460-3928.2	603928
77 01 203 069	13.0460-3933.2	603933	77 01 204 840	03.0137-9125.2	669125	77 01 349 537	24.2120-1503.3	010397
77 01 203 070	13.0460-2983.2	602983	77 01 204 845	13.0460-3954.2	603954	77 01 349 648	03.0137-0201.2	650201
77 01 203 072	03.0137-0036.2	650036	77 01 204 885	03.0137-9220.2	669220	77 01 349 649	03.0137-0203.2	650203
77 01 203 124	13.0460-4957.2	604957	77 01 204 901	24.0108-0108.1	408108	77 01 349 705	03.0137-0124.2	650124
77 01 203 129	13.0460-2834.2	602834	77 01 204 903	13.0460-3911.2	603911	77 01 349 706	03.0137-0271.2	650271
77 01 203 275	24.2122-1501.3	010403	77 01 204 918	03.2120-2031.3	010106	77 01 349 735	03.6583-0007.3	320101
77 01 203 276	24.2120-1709.3	010276	77 01 204 954	24.0120-0135.1	420135	77 01 349 751	13.0460-2834.2	602834
77 01 203 277	24.2123-1702.3	010431	77 01 204 978	03.0137-0153.2	650153	77 01 349 762	03.2119-3389.3	010057
77 01 203 282	13.0460-2834.2	602834	77 01 205 014	13.0460-3968.2	603968	77 01 349 780	03.0137-0209.2	650209
77 01 203 418	13.0460-0438.2	610438	77 01 205 015	13.0460-4957.2	604957	77 01 349 871	03.2120-2031.3	010106
77 01 203 443	03.0520-0522.3	690522	77 01 205 053	03.0520-0622.3	690622	77 01 349 928	03.0137-0271.2	650271
77 01 203 545	03.0137-0271.2	650271	77 01 205 094	03.2119-3389.3	010057	77 01 349 969	13.0460-3911.2	603911
77 01 203 546	03.0137-9027.2	669027	77 01 205 096	03.0520-1020.3	691020	77 01 349 970	13.0460-2834.2	602834



Vergleichsliste

Cross reference list - Tabella di conversione codici



Liste des correspondances - Lista referencias

RENAULT		RENAULT		ROVER				
77 01 349 973	13.0460-2834.2	602834	85 46 97 700	24.3219-1101.3	020189	SDB000990	24.0121-0105.1	421105
77 01 365 004	24.3119-1703.3	010466	86 71 000 083	24.0112-0116.1	412116	SDB100600	24.0121-0105.1	421105
77 01 365 033	24.3222-1101.3	020256	86 71 000 085	24.0120-0125.1	420125	SEG000080	24.3541-1814.5	240382
77 01 365 089	24.3222-1125.3	020356	86 71 000 107	13.0460-2834.2	602834	SEG000090	24.3541-1813.5	240381
77 01 365 142	24.3223-1102.3	020289	86 71 005 952	13.0460-4957.2	604957	SFP000390	13.0460-2803.2	602803
77 01 365 143	24.3223-1101.3	020288	86 71 005 976	24.0121-0106.1	421106	SFP000410	13.0460-2803.2	602803
77 01 365 265	24.3223-1101.3	020288	86 71 016 173	13.0460-2834.2	602834	SFP100220EVA	13.0460-5929.2	605929
77 01 365 266	24.3223-1102.3	020289	86 71 016 191	13.0460-4957.2	604957	SFP100260	13.0460-2803.2	602803
77 01 365 340	24.3119-1702.3	010465	86 71 016 841	24.5229-0285.3	330032	SFP100520	13.0460-3605.2	603605
77 01 365 377	24.3222-1125.3	020356	87 03 13 500	24.3219-1101.3	020189	SFP100520	13.0470-3605.2	LD3605
77 01 365 379	24.3222-1101.3	020256				SFS100090	03.0137-0339.2	650339
77 01 365 380	24.3223-1102.3	020289	ROVER			SML000020	24.3219-1743.3	020485
77 01 365 381	24.3223-1101.3	020288	AEU1947	13.0460-6910.2	606910	SML000030	24.3219-1743.3	020485
77 01 365 382	24.3219-1101.3	020189	DBP3169	24.0112-0102.1	412102	SML100080	24.3219-1743.3	020485
77 01 365 383	24.3220-1101.3	020212	DBP7954	24.0117-0101.1	417101	SML100090	24.3219-1743.3	020485
77 01 365 389	24.3223-1101.3	020288	EGP1254	24.0110-0212.1	410212	SXS100000	03.0137-9701.2	669701
77 01 365 390	24.3223-1102.3	020289	EJP1423	24.3304-1701.5	240113			
77 01 365 465	24.3222-1709.3	020111	EJP1424	24.3304-1702.5	240114	SAAB		
77 01 365 466	24.3222-1710.3	020112	EJP1430	24.3304-1701.5	240113	891031	13.0460-4035.2	604035
77 01 365 519	24.3222-1118.3	020315	EJP1431	24.3304-1702.5	240114	891048	13.0460-4035.2	604035
77 01 365 777	24.3222-1125.3	020356	EJP1437	13.0460-5998.2	605998	4001517	24.0711-1154.1	360009
77 01 454 307	13.0460-3961.2	603961	EJP1439	24.3541-1813.5	240381	4001525	24.0711-1155.1	360010
77 01 454 308	13.0460-3961.2	603961	EJP1440	24.3541-1814.5	240382	4001541	24.0711-1157.1	360012
77 01 457 999	03.0137-0082.2	650082	GBC154	24.3541-1814.5	240382	4002143	24.0125-0125.1	425125
77 01 458 153	03.0137-0271.2	650271	GBC156	24.3541-1813.5	240381	4002150	24.0123-0101.1	423101
77 01 458 154	03.0137-0271.2	650271	GBC158	24.3304-1701.5	240113	4002341	83.6169-0505.3	330288
77 01 466 540	24.0110-0139.1	410139	GBC161	24.3304-1702.5	240114	4004123	13.0460-2811.2	602811
77 01 467 306	24.0112-0134.1	412134	GBD90800	24.0121-0100.1	421100	4106720	83.6169-0505.3	330288
77 01 467 307	24.0112-0133.1	412133	GBD90802	24.0110-0255.1	410255	4107116	13.0460-2811.2	602811
77 01 467 954	24.0120-0135.1	420135	GBD90803	24.0117-0101.1	417101	4196317	13.0460-3306.2	603306
77 01 467 955	24.0120-0134.1	420134	GBD90806	24.0110-0239.1	410239	4198438	10.6123-0522.3	010633
77 01 499 274	24.3481-1611.5	240029	GBD90810	24.0112-0102.1	412102	4199438	10.6123-0522.3	010633
77 01 499 275	24.3481-1612.5	240030	GBD90814	24.0117-0101.1	417101	4241428	24.0124-0133.1	424133
77 04 001 812	24.3727-1004.2	581004	GBD90817	24.0110-0212.1	410212	4241444	24.5298-0322.3	331314
77 04 001 925	24.5115-0400.3	330413	GBD90818	24.0112-0102.1	412102	4241469	13.2351-0014.2	210011
77 04 001 932	24.5228-0350.3	330396	GBD90819	24.0113-0188.1	413188	4241469	24.9235-0014.5	230002
77 04 001 939	24.5112-0220.3	330613	GBD90822	24.0121-0100.1	421100	4241477	24.0110-0249.1	410249
77 04 001 947	24.5112-0385.3	330392	GBD90825	24.0117-0101.1	417101	4243218	13.2351-0013.2	210010
77 04 001 948	24.5112-0385.3	330392	GBD90827	24.0112-0102.1	412102	4243218	24.9235-0013.5	230001
77 04 001 950	24.5229-0240.3	330400	GBD90829	24.0113-0188.1	413188	4244422	11.8116-0292.1	390521
77 04 001 951	24.5229-0220.3	330399	GBD90830	24.0121-0107.1	421107	4426474	83.6169-0505.3	330288
77 04 001 952	24.5111-0320.3	330487	GBD90835	24.0110-0233.1	410233	4426490	83.6169-0505.3	330288
77 04 001 953	24.5111-0320.3	330487	GBD90836	24.0123-0103.1	423103	4426508	83.6155-0327.3	330287
77 04 001 954	24.5111-0345.3	330406	GBD90840	24.0121-0105.1	421105	4467049	13.0460-7080.2	607080
77 04 001 955	24.5111-0386.3	330503	GBP90213	13.0460-6914.2	606914	4467064	11.0101-5407.2	260011
77 04 002 443	24.5111-0150.3	330497	GBP90293	13.0460-5999.2	605999	4467072	13.0460-4043.2	604043
77 04 002 447	24.5111-0386.3	330503	GBP90297	13.0460-6914.2	606914	4467080	13.0441-3506.2	250052
77 04 002 450	24.5111-0320.3	330487	GBP90300	13.0460-2800.2	602800	4478254	13.0460-7091.2	607091
77 04 003 549	24.5229-0240.3	330400	GBP90307	13.0460-6914.2	606914	4482543	24.3541-8086.5	240526
77 04 003 765	24.5229-0285.3	330032	GBP90313	13.0460-2803.2	602803	4482550	24.3541-8085.5	240525
77 04 003 846	24.5111-0405.3	330410	GBP90314	13.0460-2805.2	602805	4483285	24.5117-0195.3	330565
77 04 003 887	24.5111-0241.3	330680	GBP90315AF	13.0460-0142.2	610142	4483723	13.0460-7080.2	607080
77 04 003 905	24.5229-0285.3	330032	GBP90315AF	13.0460-2803.2	602803	4543419	03.0137-0172.2	650172
77 04 003 913	24.5111-0300.3	330407	GBP90316	13.0460-5998.2	605998	4543930	03.2123-1121.3	010176
77 04 003 949	24.5111-0241.3	330680	GBP90316AF	13.0460-5998.2	605998	4544326	03.0137-0172.2	650172
77 04 003 955	24.5111-0320.3	330487	GBP90330AF	13.0460-5955.2	605955	4565719	24.5233-0200.3	330425
77 04 003 958	24.5111-0260.3	330408	GBP90336AF	13.0460-2803.2	602803	4566840	24.0125-0119.1	425119
77 04 003 959	24.5111-0317.3	330501	GBP90340AF	13.0460-2803.2	602803	4566840	24.0325-0119.1	525119
77 04 003 961	24.5229-0255.3	330581	GBP90341AF	13.0460-3605.2	603605	4611554	24.3571-1761.5	240461
77 11 130 008	13.0460-3911.2	603911	GBP90341AF	13.0470-3605.2	LD3605	4611562	24.3571-1762.5	240462
77 11 130 034	13.0460-3911.2	603911	GBS90821	03.0137-0179.2	650179	4646899	13.0460-7080.2	607080
77 11 130 036	13.0460-2834.2	602834	GBS90834AF	03.0137-0080.2	650080	4648457	13.0460-7080.2	607080
77 11 130 038	24.0121-0106.1	421106	GBS90836AF	03.0137-0339.2	650339	4778262	11.0441-5704.2	250034
77 11 130 071	13.0460-2834.2	602834	GWC1102	24.3219-1401.3	020351	4836441	03.0137-0172.2	650172
82 00 003 478	24.5111-0386.3	330503	GWC1150	24.3219-1121.3	020363	4836987	13.0460-4040.2	604040
82 00 020 558	24.5229-0285.3	330032	GWC1151	24.3219-1122.3	020364	4837019	24.0125-0119.1	425119
82 00 131 598	24.5111-0241.3	330680	GWC126	24.2723-1402.3	020350	4837019	24.0325-0119.1	525119
82 00 171 690	24.0222-8019.2	480087	GWC127	24.2723-1401.3	020342	4837241	13.0460-4040.2	604040
82 00 245 920	24.5111-0317.3	330501	GWC901634	24.3219-1743.3	020485	4838660	03.0137-0172.2	650172
82 00 404 264	24.5111-0386.3	330503	GWC901635	24.3219-1743.3	020485	4838967	24.3571-1761.5	240461
82 00 653 904	24.5111-0317.3	330501						

Vergleichsliste

Cross reference list - Tabella di conversione codici

Liste des correspondances - Lista referencias

SKODA 	SKODA 	STEYR-DAIMLER-PUCH 
116 595 322	03.6584-0107.3 320110	6U0 501 615 B 24.0220-0718.2 480209
193 595 294	03.3526-2002.3 340010	6U0 609 721 24.3727-2500.2 582500
1H0 501 615	24.0220-0018.1 480019	6U0 611 019 24.2122-1731.3 010656
1H0 501 615 A	24.0220-0018.1 480019	6U0 611 053 A 24.3222-1712.3 020424
1H0 501 615 A	24.0220-0718.2 480209	6U0 611 053 B 24.3219-1721.3 020422
1H0 609 525	03.0137-0268.2 650268	6U0 611 701 A 24.5166-0325.3 331293
1H0 609 525 B	03.0137-0268.2 650268	6U0 611 701 B 24.5166-0325.3 331293
1H0 609 525 D	03.0137-0268.2 650268	6U0 612 151 A 03.6584-0107.3 320110
1H0 609 526	03.0137-0268.2 650268	6U0 615 123 24.3541-1737.5 240197
1H0 609 526 B	03.0137-0268.2 650268	6U0 615 124 24.3541-1738.5 240198
1H0 609 526 D	03.0137-0268.2 650268	6U0 615 301 24.0113-0182.1 413182
1H0 609 527	03.0137-0268.2 650268	6U0 698 019 03.2123-1428.3 010476
1H0 609 527 B	03.0137-0268.2 650268	6U0 698 151 13.0460-2964.2 602964
1H0 609 527 D	03.0137-0268.2 650268	6U0 698 151 A 13.0460-2964.2 602964
1H0 609 528	03.0137-0268.2 650268	6U0 698 151 D 13.0460-2964.2 602964
1H0 609 528 B	03.0137-0268.2 650268	6U0 698 151 E 13.0460-2964.2 602964
1H0 609 528 D	03.0137-0268.2 650268	6U0 698 525 03.0137-0268.2 650268
1H0 611 053	24.3219-0909.3 020188	6U0 698 525 A 03.0137-0268.2 650268
1H0 612 151	03.6584-0107.3 320110	6U0 698 545 03.0137-9168.2 669168
1H0 612 151 D	03.6584-0107.3 320110	6U0 721 335 24.3728-2500.2 592500
1H0 612 151 F	03.6584-0107.3 320110	6U0 927 807 A 24.0721-1951.3 360367
1H0 698 151 B	13.0460-7101.2 607101	6U7 612 151 03.6583-0167.3 320140
1H0 698 545 A	03.0137-9168.2 669168	6U7 615 105 24.3541-1737.5 240197
1H0 698 545 B	03.0137-9168.2 669168	6U7 615 105 A 24.3541-1737.5 240197
1J0 611 053	24.3220-0909.3 020210	6U7 615 106 24.3541-1738.5 240198
1J0 698 151 L	13.0460-7081.2 607081	6U7 615 106 A 24.3541-1738.5 240198
1J0 698 151 L	13.0470-7081.2 LD7081	6Y0 609 525 A 03.0137-0268.2 650268
1J0 698 545	03.0137-9149.2 669149	6Y0 609 526 A 03.0137-0268.2 650268
1J0 927 803	24.0711-1361.3 360022	6Y0 609 527 A 03.0137-0268.2 650268
1J0 927 804	24.0711-1362.3 360023	6Y0 609 528 A 03.0137-0268.2 650268
251 615 219	11.8171-0008.1 990049	811 609 525 E 03.0137-0268.2 650268
251 615 219 A	11.8171-0008.1 990049	811 609 526 E 03.0137-0268.2 650268
331 501 615 A	24.0220-0018.1 480019	8E0 615 301 Q 24.0125-0105.1 425105
3A0 611 053	24.3220-0909.3 020210	8E0 615 301 Q 24.0325-0105.1 525105
3A0 615 123	24.3541-8523.5 240551	8E0 615 601 24.0110-0201.1 410201
3A0 615 123 A	24.3541-8523.5 240551	8E0 615 601 24.0310-0201.1 510201
3A0 615 124 A	24.3541-8524.5 240552	8N0 698 151 13.0460-7081.2 607081
3A0 615 124 A	24.3541-8524.5 240552	8N0 698 151 13.0470-7081.2 LD7081
3A0 615 125	11.8170-0306.1 260102	
3A0 615 125 A	11.8170-0306.1 260102	
3A0 698 151	13.0460-7081.2 607081	SMART (MCC)
3A0 698 151	13.0470-7081.2 LD7081	000 4162 V001 000000 24.5112-0315.3 330509
3A0 698 151 A	13.0460-7081.2 607081	451 420 00 48 24.5112-0285.3 330604
3A0 698 151 A	13.0470-7081.2 LD7081	
3A0 698 471	11.0441-5409.2 250031	STEYR-DAIMLER-PUCH
3B0 615 125	11.8170-0306.1 260102	
4A0 615 125 A	11.8170-0306.1 260102	300 12 535 24.5165-0450.3 331259
4A0 615 269	11.8116-0143.1 390513	300 14 050 03.3219-0203.3 020037
4A0 615 301 C	24.0125-0105.1 425105	377 00 34 9702 13.0441-6001.2 250126
4A0 615 301 C	24.0325-0105.1 525105	380 23 35 83.6103-0350.3 330225
4A0 615 301 D	24.0125-0105.1 425105	395 35 0024 03.3115-2102.3 010247
4A0 615 301 D	24.0325-0105.1 525105	395 35 0080 03.2419-3307.3 030014
4A0 615 301 E	24.0125-0105.1 425105	395 35 59 03.3517-0300.1 390323
4A0 615 301 E	24.0325-0105.1 525105	480 23 0750 03.0350-1906.2 071906
4A0 615 601 A	24.0110-0201.1 410201	501 1 36 060 24.3526-0100.3 340017
4A0 615 601 A	24.0310-0201.1 510201	501 1 36 070 03.3215-0221.3 020013
4A0 698 471	11.0441-5704.2 250034	501 1 36 262 83.6204-0220.3 330308
4B0 615 125	11.8170-0306.1 260102	504 1 36 001 0 03.3217-0401.3 020023
4D0 698 647	11.0101-5409.2 260035	520 7 29 181 000 03.3517-0300.1 390323
5U0 501 615 B	24.0220-0018.1 480019	527 1 31 256 000 03.2122-4902.3 010144
6Q0 611 053 B	24.3219-0909.3 020188	536 1 29 201 000 03.3508-0501.3 310017
6Q0 611 053 C	24.3217-0908.3 020167	559 0 00 150 221 03.2123-6002.3 010184
6Q0 698 525	03.0137-0268.2 650268	559 0 00 150 285 13.0441-4825.2 250107
6Q0 698 525 A	03.0137-0268.2 650268	559 0 00 150 286 13.0460-5032.2 605032
6Q0 698 525 B	03.0137-0268.2 650268	586 36 0771 03.3318-0800.2 390112
6QE 611 053	24.3217-0908.3 020167	680 G 36 005 8 83.6103-0550.3 330231
6QE 611 053 A	24.3219-0909.3 020188	700 1 36 004 2 83.6204-0400.3 330311
6R0 698 525 A	03.0137-0268.2 650268	700 1 36 005 2 24.5170-0201.3 331450
6U0 501 615 A	24.0220-0018.1 480019	710 1 26 510 0 03.3508-0401.3 310014
6U0 501 615 A	24.0220-0718.2 480209	710 1 36 373 1 03.2515-1101.3 040001
6U0 501 615 B	24.0220-0018.1 480019	710 1 36 442 2 83.6103-0320.3 330224
		710 1 36 443 2
		710 1 36 601 0
		710 1 36 606 2
		721 1 36 060 0
		780 36 35
		791 00 36 0046
		900 03 55 9720
		SUBARU
		725178170
		725178480
		725178481
		725191220
		725191631
		725191990
		725193121
		725431150
		725431290
		725431300
		725431312
		725431321
		5320060841
		5520061880
		5520080E10
		2371071C10
		25191GA560
		25191GA720
		25191GA930
		25193GA130
		25431GA170
		25431GA171
		25431GA200
		26257AA030
		26257AA040
		26257AA050
		26296AA010
		26296AA120
		26296AA121
		26296AA142
		26296AA143
		26296FA000
		26296FA001
		26298AA010
		26298AA011
		26298AA040
		26300AE050
		26300AE070
		26300AE071
		26300AE091
		26310AA021
		26310AA031
		26310AA032
		26310AA091
		26310AA092
		26310AA120
		26310AA121
		26310AC060
		4351163B00
		4351163B10
		5320080EC0
		5340163B00
		5340263B00
		5531180F01
		5531180F02
		5531180F03
		SUZUKI
		23710-60B10
		23710-71C10
		83.6203-0400.3 330302
		03.2123-1003.3 010175
		24.3526-0810.3 340037
		03.6513-0340.3 320084
		03.3508-0401.3 310014
		03.3508-0801.3 310023
		83.6103-0450.3 330228
		03.0137-0222.2 650222
		03.0137-0222.2 650222
		03.0137-0222.2 650222
		13.0460-5963.2 605963
		13.0460-5963.2 605963
		13.0460-5963.2 605963
		13.0460-5963.2 605963
		24.0118-0115.1 418115
		24.0118-0116.1 418116
		24.0118-0115.1 418115
		24.0118-0115.1 418115
		24.0118-0116.1 418116
		03.0137-0315.2 650315
		13.0460-5985.2 605985
		13.0460-5837.2 605837
		24.3728-2201.2 592201
		13.0460-5991.2 605991
		13.0460-5991.2 605991
		13.0460-5991.2 605991
		13.0460-5991.2 605991
		24.0118-0104.1 418104
		24.0118-0104.1 418104
		24.0118-0104.1 418104
		03.0137-0302.2 650302
		03.0137-0302.2 650302
		03.0137-0302.2 650302
		13.0460-5978.2 605978
		13.0460-5978.2 605978
		13.0460-5978.2 605978
		13.0460-5978.2 605978
		13.0460-5978.2 605978
		13.0460-5978.2 605978
		13.0460-5978.2 605978
		03.0137-0302.2 650302
		03.0137-0302.2 650302
		03.0137-0302.2 650302
		03.0137-0302.2 650302
		24.0124-0145.1 424145
		24.0124-0145.1 424145
		24.0124-0145.1 424145
		24.0124-0141.1 424141
		24.0124-0141.1 424141
		24.0124-0141.1 424141
		24.0124-0141.1 424141
		24.0124-0145.1 424145
		24.0124-0145.1 424145
		24.0124-0145.1 424145
		24.0124-0141.1 424141
		24.0220-0040.1 480166
		24.0220-0040.1 480166
		03.0137-0500.2 605000
		24.3217-1726.3 020513
		24.3217-1725.3 020512
		24.0117-0103.1 417103
		24.0117-0103.1 417103
		24.0117-0103.1 417103
		24.3728-2003.2 592003
		24.3728-2201.2 592201

Vergleichsliste

Cross reference list - Tabella di conversione codici

Liste des correspondances - Lista referencias



SUZUKI			TALBOT			TOYOTA		
23710-80E00	24.3728-2003.2	592003	135828 00	13.0460-3010.2	603010	04465-42010	13.0460-5951.2	605951
43511-62B00	24.0218-0042.1	480164	136424 00	13.0441-4819.2	250104	04465-42011	13.0460-5951.2	605951
43511-63B00	24.0220-0040.1	480166	168063 00	13.0460-4033.2	604033	04465-42012	13.0460-5951.2	605951
43511-63B10	24.0220-0040.1	480166	168308 00	13.0460-4035.2	604035	04465-42050	13.0460-5951.2	605951
53200-60821	03.0137-0414.2	650414	168374 00	13.0460-3010.2	603010	04465-44020	13.0460-5951.2	605951
53200-60841	03.0137-0315.2	650315	168440 00	13.0460-4033.2	604033	04465-44040	13.0460-5951.2	605951
53200-69G00	03.0137-0315.2	650315	17 689 400	24.3222-1118.3	020315	04465-44120	13.0460-5951.2	605951
53200-69G10	03.0137-0315.2	650315	175826 00	03.0137-0124.2	650124	04465-44130	13.0460-5951.2	605951
53200-69G11	03.0137-0315.2	650315	175916 00	03.0137-0271.2	650271	04465-60020	13.0460-5745.2	605745
53200-69G12	03.0137-0315.2	650315	176798 00	11.8171-0008.1	990049	04466-12031	13.0460-5835.2	605835
53200-80840	03.0137-0306.2	650306	306349 00	13.0460-4035.2	604035	04466-12040	13.0460-5835.2	605835
53200-80EC0	03.0137-0500.2	650500	306401 00	13.0460-3961.2	603961	04466-12070	13.0460-5835.2	605835
53200-81A01	03.0137-0287.2	650287	306662 00	13.0460-4035.2	604035	04466-12110	13.0460-5835.2	605835
53200-81A11	03.0137-0287.2	650287	306663 00	13.0460-3961.2	603961	04466-20110	13.0460-5835.2	605835
53210-56A50	03.0137-0222.2	650222	309920 00	13.0460-3961.2	603961	04466-32010	13.0460-5835.2	605835
53210-60B00	03.0137-0414.2	650414	327082 00	13.0460-3961.2	603961	04466-60010	13.0460-5744.2	605744
53210-60B10	03.0137-0414.2	650414	327960 00	13.0460-3961.2	603961	04466-60020	13.0460-5744.2	605744
53210-70C00	03.0137-0315.2	650315	328635 00	13.0460-3961.2	603961	04466-60080	13.0460-5744.2	605744
53210-70C10	03.0137-0315.2	650315	33123 00	13.0460-3010.2	603010	04466-60090	13.0460-5744.2	605744
53210-84010	03.0137-0222.2	650222	33123 E	13.0460-3010.2	603010	04466-60140	13.0460-5744.2	605744
53401-63B00	24.3217-1726.3	020513	37129 00	24.3526-0810.3	340037	04466-YZZC5	13.0460-5835.2	605835
53401-86040	24.3215-1704.3	020532	38213 V	13.0460-3010.2	603010	04491-05010	13.0460-5951.2	605951
53402-63B00	24.3217-1725.3	020512	4238 07	03.0137-0124.2	650124	04491-06010	13.0460-5951.2	605951
53402-81A00	24.3219-1723.3	020427	4238 86	03.0137-0271.2	650271	04491-10131	13.0460-5969.2	605969
53800-50800	03.0137-0222.2	650222	4246 42	24.0113-0128.1	413128	04491-10141	13.0460-5969.2	605969
55110-70A00	13.0460-5966.2	605966	4246 B2	24.0113-0128.1	413128	04491-10160	13.0460-5976.2	605976
55110-80000	13.0460-5966.2	605966	4248 61	13.0460-3928.2	603928	04491-10161	13.0460-5976.2	605976
55110-80010	13.0460-5966.2	605966	4248 64	13.0460-3928.2	603928	04491-12170	13.0460-5976.2	605976
55110-80020	13.0460-5966.2	605966	4250 67	13.0460-3928.2	603928	04491-12230	13.0460-5976.2	605976
55200-60A41	13.0460-5967.2	605967	432009 00	24.3222-1708.3	020407	04491-12231	13.0460-5976.2	605976
55200-60B11	13.0460-5985.2	605985	432030 00	11.0101-5407.2	260011	04491-12250	13.0460-5976.2	605976
55200-61880	13.0460-5985.2	605985	432036 00	11.0441-5402.2	250028	04491-12251	13.0460-5976.2	605976
55200-63810	13.0460-5967.2	605967	432763 00	03.2120-2031.3	010106	04491-12270	13.0460-5976.2	605976
55200-70810	13.0460-5966.2	605966	4402 21	24.3219-1114.3	020323	04491-12320	13.0460-5976.2	605976
55200-70862	13.0460-5916.2	605916	4402 50	24.3222-1102.3	020257	04491-12321	13.0460-5976.2	605976
55200-80E10	13.0460-5837.2	605837	4402 52	24.3222-1708.3	020407	04491-12322	13.0460-5976.2	605976
55200-81A10	13.0460-5966.2	605966	4402 62	24.3220-0905.3	020207	04491-12330	13.0460-5976.2	605976
55200-81A31	13.0460-5966.2	605966	4448 34	11.0441-5401.2	250027	04491-12331	13.0460-5976.2	605976
55200-82830	13.0460-5961.2	605961	45164 00	03.3518-6100.2	390364	04491-12421	13.0460-5976.2	605976
55200-86810	13.0460-5985.2	605985	4601 65	24.2119-1503.3	010404	04491-12422	13.0460-5976.2	605976
55200-86820	13.0460-5985.2	605985	47891 00	13.0460-4033.2	604033	04491-12432	13.0460-5976.2	605976
55210-56A50	13.0460-5916.2	605916	550552 00	24.3219-1114.3	020323	04491-12440	13.0460-5976.2	605976
55210-78450	13.0460-5916.2	605916	559477 00	24.2525-1601.3	040062	04491-12490	13.0460-5976.2	605976
55210-78460	13.0460-5916.2	605916	559477 14	24.2525-1601.3	040062	04491-12540	13.0460-5976.2	605976
55210-82020	13.0460-5961.2	605961	78515310 00	24.0113-0128.1	413128	04491-12541	13.0460-5976.2	605976
55210-84500	13.0460-5916.2	605916	79100289 92	24.3222-1102.3	020257	04491-12560	13.0460-5976.2	605976
55210-85000	13.0460-5916.2	605916	91505280 80	24.2119-1503.3	010404	04491-12561	13.0460-5976.2	605976
55211-60A00	24.0110-0242.1	410242	91506320 80	24.3220-1619.3	020246	04491-12580	13.0460-5976.2	605976
55211-80000	24.0110-0192.1	410192	94044483 48	11.0441-5401.2	250027	04491-12581	13.0460-5976.2	605976
55300-86810	13.0460-5985.2	605985				04491-12630	13.0460-5976.2	605976
55300-86820	13.0460-5985.2	605985	TOYOTA			04491-12640	13.0460-5951.2	605951
55311-60B20	24.0117-0103.1	417103	04465-10040	13.0460-5976.2	605976	04491-12650	13.0460-5951.2	605951
55311-60B30	24.0117-0103.1	417103	04465-10070	13.0460-5976.2	605976	04491-12651	13.0460-5951.2	605951
55311-72F00	24.0117-0103.1	417103	04465-12040	13.0460-5969.2	605969	04491-16052	13.0460-5976.2	605976
55311-80F00	24.0117-0103.1	417103	04465-12090	13.0460-5976.2	605976	04491-17020	13.0460-5976.2	605976
55311-80F01	24.0117-0103.1	417103	04465-12240	13.0460-5976.2	605976	04491-17021	13.0460-5976.2	605976
55311-80F02	24.0117-0103.1	417103	04465-12540	13.0460-5976.2	605976	04491-17022	13.0460-5976.2	605976
55311-80F03	24.0117-0103.1	417103	04465-16120	13.0460-5951.2	605951	04491-17030	13.0460-5976.2	605976
55311-M72F00	24.0117-0103.1	417103	04465-20120	13.0460-5976.2	605976	04491-17040	13.0460-5976.2	605976
55511-82000	24.0110-0136.1	410136	04465-26300	13.0460-5951.2	605951	04491-17050	13.0460-5976.2	605976
55511-82001	24.0110-0136.1	410136	04465-26301	13.0460-5722.2	605722	04491-17060	13.0460-5976.2	605976
55800-62G01	13.0460-5972.2	605972	04465-26370	13.0460-5722.2	605722	04491-17070	13.0460-5976.2	605976
55800-62G11	13.0460-5972.2	605972	04465-26390	13.0460-5722.2	605722	04491-17080	13.0460-5976.2	605976
55800-80J00	13.0460-5929.2	605929	04465-33040	13.0460-5951.2	605951	04491-17081	13.0460-5976.2	605976
55800-80J01	13.0460-5929.2	605929	04465-35031	13.0460-5992.2	605992	04491-20191	13.0460-5976.2	605976
55800-80J02	13.0460-5929.2	605929	04465-35080	13.0460-5992.2	605992	04491-20220	13.0460-5976.2	605976
			04465-35220	13.0460-5892.2	605892	04491-20310	13.0460-5976.2	605976
TALBOT			04465-35260	13.0460-5992.2	605992	04491-20390	13.0460-5938.2	605938
135336 00	24.2419-1601.3	030080	04465-35270	13.0460-5892.2	605892	04491-20451	13.0460-5976.2	605976
135455 00	24.3220-0905.3	020207	04465-35280	13.0460-5992.2	605992	04491-20470	13.0460-5976.2	605976



Vergleichsliste

Cross reference list - Tabella di conversione codici



Liste des correspondances - Lista referencias

TOYOTA		TOYOTA		TOYOTA				
04491-20471	13.0460-5976.2	605976	04495-33020	03.0137-0318.2	650318	43512-33020	24.0128-0114.1	428114
04491-20500	13.0460-5976.2	605976	04495-34010	03.0137-0308.2	650308	43512-33040	24.0128-0115.1	428115
04491-20501	13.0460-5976.2	605976	04495-35051	03.0137-0226.2	650226	43512-33041	24.0128-0115.1	428115
04491-20580	13.0460-5976.2	605976	04495-35090	03.0137-0226.2	650226	43512-33042	24.0128-0115.1	428115
04491-20620	13.0460-5976.2	605976	04495-35100	03.0137-0226.2	650226	43512-33050	24.0128-0114.1	428114
04491-20820	13.0460-5976.2	605976	04495-35120	03.0137-0226.2	650226	43512-33060	24.0128-0115.1	428115
04491-20880	13.0460-5951.2	605951	04495-35121	03.0137-0226.2	650226	43512-35070	24.0113-0105.1	413105
04491-20890	13.0460-5951.2	605951	04495-35122	03.0137-0226.2	650226	43512-35110	24.0120-0168.1	420168
04491-22370	13.0460-5951.2	605951	04495-35131	03.0137-0193.2	650193	43512-35170	24.0125-0118.1	425118
04491-26030	13.0460-5938.2	605938	04495-35150	03.0137-0308.2	650308	43512-35180	24.0125-0118.1	425118
04491-26040	13.0460-5938.2	605938	04495-35151	03.0137-0308.2	650308	43512-35190	24.0120-0168.1	420168
04491-26070	13.0460-5938.2	605938	04495-35230	03.0137-0308.2	650308	43512-35200	24.0125-0135.1	425135
04491-26130	13.0460-5938.2	605938	04495-42010	03.0137-0318.2	650318	43512-44020	24.0128-0115.1	428115
04491-26151	13.0460-5938.2	605938	04495-42030	03.0137-0318.2	650318	43512-44021	24.0128-0115.1	428115
04491-26191	13.0460-5938.2	605938	04495-42040	03.0137-0318.2	650318	43512-60011	24.0120-0153.1	420153
04491-2B010	13.0460-5951.2	605951	04495-42070	03.0137-0318.2	650318	43512-60040	24.0120-0153.1	420153
04491-32010	13.0460-5976.2	605976	04497-26070	03.0137-0308.2	650308	43512-60090	24.0132-0111.1	432111
04491-32011	13.0460-5976.2	605976	04497-26071	03.0137-0308.2	650308	43512-69015	24.0120-0153.1	420153
04491-32030	13.0460-5976.2	605976	04497-26090	03.0137-0308.2	650308	43512-69016	24.0120-0153.1	420153
04491-32080	13.0460-5976.2	605976	04947-22010	13.0460-0441.2	610441	46420-05010	24.3727-1933.2	581933
04491-32190	13.0460-5976.2	605976	04947-32010	13.0460-0325.2	610325	46420-12340	24.3727-1902.2	581902
04491-33010	13.0460-5951.2	605951	04947-32030	13.0460-0325.2	610325	46420-12390	24.3727-1923.2	581923
04491-33011	13.0460-5951.2	605951	04947-32070	13.0460-0325.2	610325	46420-12400	24.3727-1908.2	581908
04491-33030	13.0460-5951.2	605951	04947-32080	13.0460-0325.2	610325	46420-20351	24.3727-1933.2	581933
04491-33060	13.0460-5951.2	605951	04947-33040	13.0460-0441.2	610441	46430-05010	24.3727-1932.2	581932
04491-35050	13.0460-5938.2	605938	04947-33090	13.0460-0441.2	610441	46430-12290	24.3727-1922.2	581922
04491-35060	13.0460-5938.2	605938	04947-42010	13.0460-0441.2	610441	46430-12300	24.3727-1907.2	581907
04491-35061	13.0460-5938.2	605938	04947-42030	13.0460-0441.2	610441	46430-20361	24.3727-1932.2	581932
04491-35070	13.0460-5935.2	605935	04951-05010	11.0101-5407.2	260011	46540-20060	03.0137-0402.2	650402
04491-35080	13.0460-5935.2	605935	42431-12090	24.0109-0128.1	409128	46540-20070	03.0137-0402.2	650402
04491-35160	13.0460-5992.2	605992	42431-12120	24.0109-0128.1	409128	46540-28010	03.0137-0400.2	650400
04491-35200	13.0460-5938.2	605938	42431-12130	24.0220-0023.1	480084	46540-44010	03.0137-0400.2	650400
04491-60010	13.0460-5935.2	605935	42431-12150	24.0109-0159.1	409159	46540-50010	03.0137-0400.2	650400
04491-60040	13.0460-5935.2	605935	42431-12170	24.0109-0159.1	409159	46550-20060	03.0137-0402.2	650402
04491-60050	13.0460-5935.2	605935	42431-12180	24.0220-0023.1	480084	46550-28010	03.0137-0400.2	650400
04491-60080	13.0460-5992.2	605992	42431-14100	24.0118-0119.1	418119	46550-33020	03.0137-0402.2	650402
04491-60160	13.0460-5745.2	605745	42431-14110	24.0118-0119.1	418119	46550-44010	03.0137-0400.2	650400
04491-60180	13.0460-5745.2	605745	42431-14120	24.0118-0119.1	418119	46550-50010	03.0137-0400.2	650400
04492-20100	13.0460-5835.2	605835	42431-20090	24.0110-0241.1	410241	46590-20060	03.0137-0402.2	650402
04492-60010	13.0460-5744.2	605744	42431-20160	24.0110-0241.1	410241	46590-28010	03.0137-0400.2	650400
04492-60020	13.0460-5744.2	605744	42431-20190	24.0220-0022.1	480083	46590-33020	03.0137-0402.2	650402
04495-02020	03.0137-0375.2	650375	42431-20250	24.0220-0023.1	480084	46590-44010	03.0137-0400.2	650400
04495-02110	03.0137-0375.2	650375	42431-33010	24.0110-0700.1	410700	46590-50010	03.0137-0400.2	650400
04495-05010	03.0137-0375.2	650375	42431-35180	24.0229-5004.1	480312	47550-12090	24.3217-1734.3	020560
04495-10110	03.0137-0257.2	650257	43512-05010	24.0128-0113.1	428113	47550-16030	24.3217-1734.3	020560
04495-10120	03.0137-0257.2	650257	43512-05020	24.0128-0116.1	428116	47550-16060	24.3217-1734.3	020560
04495-12110	03.0137-0221.2	650221	43512-07020	24.0128-0115.1	428115	47550-19155	24.3217-1734.3	020560
04495-12111	03.0137-0221.2	650221	43512-12250	24.0118-0110.1	418110	47550-20120	24.3217-1734.3	020560
04495-12171	03.0137-0221.2	650221	43512-12300	24.0118-0110.1	418110	47550-20130	24.3219-1712.3	020388
04495-12210	03.0137-0313.2	650313	43512-12310	24.0118-0110.1	418110	47550-20141	24.3219-1712.3	020388
04495-12220	03.0137-0313.2	650313	43512-12330	24.0118-0110.1	418110	47550-20150	24.3219-1730.3	020447
04495-20090	03.0137-0313.2	650313	43512-12340	24.0118-0110.1	418110	47550-26090	24.3222-1740.3	020566
04495-20091	03.0137-0313.2	650313	43512-12440	24.0118-0110.1	418110	47550-29265	24.3222-1740.3	020566
04495-20092	03.0137-0313.2	650313	43512-12480	24.0118-0110.1	418110	47550-32010	24.3219-1712.3	020388
04495-20100	03.0137-0313.2	650313	43512-12490	24.0122-0188.1	422188	47550-39115	24.3222-1740.3	020566
04495-20101	03.0137-0313.2	650313	43512-12550	24.0122-0158.1	422158	47550-39285	24.3219-1712.3	020388
04495-20150	03.0137-0313.2	650313	43512-16070	24.0118-0124.1	418124	47570-12030	24.3217-1733.3	020559
04495-26020	03.0137-0226.2	650226	43512-16120	24.0118-0124.1	418124	47570-16010	24.3217-1733.3	020559
04495-26040	03.0137-0226.2	650226	43512-20260	24.0122-0153.1	422153	47570-16040	24.3217-1733.3	020559
04495-26050	03.0137-0308.2	650308	43512-20360	24.0122-0178.1	422178	47570-19035	24.3217-1733.3	020559
04495-26051	03.0137-0308.2	650308	43512-20380	24.0122-0178.1	422178	47570-20030	24.3217-1733.3	020559
04495-26060	03.0137-0308.2	650308	43512-20390	24.0125-0144.1	425144	47570-20060	24.3219-1729.3	020446
04495-26061	03.0137-0308.2	650308	43512-20470	24.0125-0124.1	425124	47715-05010	11.8171-0008.1	990049
04495-26080	03.0137-0193.2	650193	43512-20480	24.0125-0124.1	425124	47716-32010	13.0460-0325.2	610325
04495-26090	03.0137-0193.2	650193	43512-20500	24.0128-0116.1	428116	47716-32040	13.0460-0333.2	610333
04495-26100	03.0137-0308.2	650308	43512-20580	24.0125-0124.1	425124	47717-32010	13.0460-0325.2	610325
04495-26120	03.0137-0193.2	650193	43512-20700	24.0125-0124.1	425124	47717-32040	13.0460-0333.2	610333
04495-26121	03.0137-0193.2	650193	43512-26040	24.0125-0118.1	425118	47730-12450	24.3541-1706.5	240112
04495-32010	03.0137-0313.2	650313	43512-26070	24.0125-0118.1	425118	47730-12451	24.3541-1706.5	240112
04495-32030	03.0137-0313.2	650313	43512-32090	24.0122-0154.1	422154	47730-20480	24.3571-1714.5	240202
04495-32031	03.0137-0313.2	650313	43512-32180	24.0122-0154.1	422154	47743-32010	13.0460-0325.2	610325

Vergleichsliste

Cross reference list - Tabella di conversione codici

Liste des correspondances - Lista referencias

TOYOTA 	VAG 	VAG 						
47743-32030	13.0460-0333.2	610333	113 611 021 F	03.3117-1408.3	010255	171 611 019 D	03.2120-1531.3	010092
47748-60010	13.0460-0327.2	610327	113 611 021 G	03.3117-1408.3	010255	171 611 019 H	03.2120-1531.3	010092
47750-12450	24.3541-1705.5	240111	113 611 023 B	03.3117-1408.3	010255	171 611 019 N	03.2120-1491.3	010089
47750-12451	24.3541-1705.5	240111	113 611 053	03.3217-0211.3	020021	171 611 051 B	03.3214-0812.3	020011
47750-20480	24.3571-1713.5	240201	113 611 053 A	03.3217-1811.3	020026	171 611 053	03.3214-0812.3	020011
47771-12050	13.0460-0333.2	610333	113 611 053 B	03.3217-1811.3	020026	171 611 053 A	03.3214-0812.3	020011
47771-32010	13.0460-0325.2	610325	113 611 055	03.3219-0411.3	020038	171 611 701 A	83.6104-0325.3	330246
90080-94029	24.5235-0275.3	331179	113 611 055 C	03.3219-3211.3	020048	171 611 701 B	83.6104-0325.3	330246
90080-94067	24.5260-0280.3	330883	113 611 057 B	03.3222-5211.3	020081	171 611 701 G	24.5170-0315.3	331309
90240-06158	13.0460-0327.2	610327	113 611 067	03.3223-0611.3	020091	171 611 701 H	24.5170-0315.3	331309
90468-12003	13.0460-0327.2	610327	113 611 701	24.5165-0450.3	331259	171 611 701 J	24.5108-0266.3	330038
90947-02809	24.5235-0275.3	331179	113 611 701 D	24.5165-0350.3	331257	171 611 701 K	24.5108-0266.3	330038
90947-02887	24.5264-0525.3	330926	113 611 701 E	03.3219-3211.3	331322	171 611 701 L	24.5170-0315.3	331309
90947-02888	24.5264-0526.3	330927	113 611 775	24.5224-0240.3	331260	171 611 775	24.5201-0164.3	331414
90947-02921	24.5260-0280.3	330883	113 611 775 A	24.5165-0215.3	331319	171 615 269 B	13.0460-0184.2	610184
			113 611 775 B	24.5224-0295.3	331261	171 615 270 B	13.0460-0184.2	610184
			113 611 775 E	24.5165-0215.3	331319	171 698 151 B	13.0460-4029.2	604029
			113 615 107	13.2401-8007.2	210047	171 698 151 C	13.0460-4029.2	604029
			113 615 107 A	13.2401-8007.2	210047	171 698 151 D	13.0460-4029.2	604029
			113 615 108	13.2401-8008.2	210048	171 698 151 E	13.0460-4028.2	604028
			113 615 108 A	13.2401-8008.2	210048	171 698 151 F	13.0460-7032.2	607032
			113 698 273	03.0470-2619.2	060051	171 698 151 G	13.0460-7032.2	607032
			113 698 537 CX	03.0137-0041.2	650041	171 698 151 H	13.0460-4029.2	604029
			113 698 537 QX	03.0137-0041.2	650041	171 698 447	11.0101-4801.2	260006
			113 945 515	24.3526-0100.3	340017	171 698 447 A	11.0101-4801.2	260006
			113 945 515 D	24.3526-1900.0	340038	171 698 471 A	11.0441-4804.2	250019
			113 945 515 F	24.3526-0810.3	340037	171 698 471 B	11.0441-4808.2	250022
			113 945 515 G	24.3526-1900.0	340038	171 698 525 AV	03.0137-0126.2	650126
			113 945 515 H	03.3526-2002.3	340010	171 698 525 AX	03.0137-0126.2	650126
			113 945 515 HS	03.3526-2002.3	340010	171 698 525 BV	03.0137-0126.2	650126
			114 611 015 BC	03.2119-8611.3	010063	171 698 525 BX	03.0137-0126.2	650126
			114 611 015 BG	03.2119-9011.3	010067	171 698 545	03.0137-9008.2	669008
			114 611 015 BN	03.2119-9011.3	010067	171 721 335 D	24.3728-0107.2	590107
			115 430 200	24.3541-1737.5	240197	171 721 335 E	24.3728-0108.2	590108
			115 430 201	24.3541-1738.5	240198	172 611 019 A	03.2120-1491.3	010089
			115 430 202	24.3541-1737.5	240197	175 609 721	24.3727-0102.2	580102
			115 430 203	24.3541-1738.5	240198	175 611 025	03.2120-1821.3	010100
			115 430 204	24.3541-1737.5	240197	175 611 025 A	03.2120-1821.3	010100
			115 430 205	24.3541-1738.5	240198	175 611 701 A	24.5170-0315.3	331309
			115 430 980	24.3541-1737.5	240197	175 611 775	24.5201-0164.3	331414
			115 430 981	24.3541-1738.5	240198	175 615 301	24.0112-0106.1	412106
			131 611 055	03.3219-3211.3	020048	175 615 301	24.0312-0106.1	512106
			131 611 057	03.3222-5211.3	020081	175 698 151	13.0460-7032.2	607032
			133 609 721	24.3727-0101.2	580101	176 698 151	13.0460-7032.2	607032
			141 615 107	13.2401-8007.2	210047	176 698 471 B	11.0441-4808.2	250022
			141 615 108	13.2401-8008.2	210048	179 609 721	24.3727-0150.2	580150
			147 611 775	83.6299-0807.3	330901	181 609 237 B	03.0137-0041.2	650041
			147 611 775 A	83.6299-0807.3	330901	181 611 701	24.5171-0393.3	331311
			171 501 615	24.0218-0007.1	480003	191 501 615	24.0218-0007.1	480003
			171 501 615	24.0218-0707.2	480211	191 501 615	24.0218-0707.2	480211
			171 501 615 A	24.0218-0007.1	480003	191 501 615 A	24.0220-0018.1	480019
			171 501 615 A	24.0218-0707.2	480211	191 501 615 A	24.0220-0718.2	480209
			171 501 615 B	24.0218-0007.1	480003	191 501 615 B	24.0218-0007.1	480003
			171 501 615 B	24.0218-0707.2	480211	191 501 615 B	24.0218-0707.2	480211
			171 501 615 C	24.0218-0007.1	480003	191 609 617 A	24.0223-0017.1	480135
			171 501 615 C	24.0218-0707.2	480211	191 609 721	24.3727-0118.2	580118
			171 609 525 A	03.0137-0126.2	650126	191 609 721 A	24.3727-0123.2	580123
			171 609 525 AV	03.0137-0126.2	650126	191 609 721 C	24.3727-0166.2	580166
			171 609 525 AX	03.0137-0126.2	650126	191 609 721 D	24.3727-0124.2	580124
			171 609 526 A	03.0137-0126.2	650126	191 609 721 E	24.3727-0132.2	580132
			171 609 526 AV	03.0137-0126.2	650126	191 609 721 F	24.3727-0133.2	580133
			171 609 526 AX	03.0137-0126.2	650126	191 611 019	03.2120-0313.3	010106
			171 609 527 F	03.0137-0126.2	650126	191 611 701	24.5170-0315.3	331309
			171 609 527 FV	03.0137-0126.2	650126	191 611 701 A	83.6225-0287.3	330735
			171 609 527 FX	03.0137-0126.2	650126	191 612 107 A	03.6750-0202.4	300033
			171 609 528 F	03.0137-0126.2	650126	191 612 151	03.6584-0015.3	320109
			171 609 528 FV	03.0137-0126.2	650126	191 612 151 A	03.6584-0015.3	320109
			171 609 528 FX	03.0137-0126.2	650126	191 612 151 C	03.6584-0015.3	320109
			171 609 721 C	24.3727-0102.2	580102	191 615 123	24.3481-1745.5	240277
			171 611 019	03.2120-1531.3	010092	191 615 124	24.3481-1746.5	240278
			171 611 019 B	03.2120-1531.3	010092	191 615 423	24.3384-1603.5	240015

Vergleichsliste

Cross reference list - Tabella di conversione codici



Liste des correspondances - Lista referencias

191 615 423 A	24.3364-1605.5	240011						
191 615 423 AX	24.3364-1605.5	240011	1H0 609 721 D	24.3727-0169.2	580160	1H1 698 019 A	10.6123-0674.3	010639
191 615 423 B	24.3384-1603.5	240015	1H0 609 721 E	24.3727-0169.2	580156	1H1 698 019 B	03.2122-1113.3	010636
191 615 424	24.3384-1604.5	240016	1H0 611 053	24.3219-0909.3	020188	1H1 698 107	10.6360-1003.4	300156
191 615 424 A	24.3364-1606.5	240012	1H0 611 053 A	24.3215-0903.3	020154	1H1 698 107 A	10.6360-1003.4	300156
191 615 424 AX	24.3364-1606.5	240012	1H0 611 053 B	24.3214-0902.3	020147	1H1 721 335	24.3728-0130.2	590130
191 615 424 B	24.3384-1604.5	240016	1H0 611 053 C	24.3222-0913.3	020255	1H1 721 335 A	24.3728-0127.2	590127
191 615 601	24.0110-0111.1	410111	1H0 611 701	24.5105-0442.3	331432	1H1 721 335 B	24.3728-0127.2	590127
191 615 601	24.0110-0275.2	410275	1H0 611 701 A	83.6232-0465.3	330736	1H1 721 335 C	24.3728-0130.2	590130
191 615 601 A	24.0110-0111.1	410111	1H0 611 701 B	83.6232-0465.3	330736	1H1 721 335 G	24.3728-0127.2	590127
191 615 601 A	24.0110-0275.2	410275	1H0 611 701 F	24.5105-0442.3	331432	1H1 721 335 H	24.3728-0130.2	590130
191 615 601 B	24.0110-0111.1	410111	1H0 611 775	83.7836-0135.3	330816	1H1 721 335 K	24.3728-0130.2	590130
191 615 601 B	24.0110-0275.2	410275	1H0 612 151	03.6584-0107.3	320110	1H1 721 335 M	24.3728-0130.2	590130
191 698 151	13.0460-7030.2	607030	1H0 612 151 A	03.0101-0025.2	320014	1H1 721 401	03.2419-9510.3	030028
191 698 151 A	13.0460-7030.2	607030	1H0 612 151 C	03.6584-0113.3	320111	1H1 721 401 B	03.2419-9510.3	030028
191 698 151 B	13.0460-7033.2	607033	1H0 612 151 D	03.6584-0107.3	320110	1H2 611 019	03.2120-3943.3	010532
191 698 151 C	13.0460-7032.2	607032	1H0 612 151 E	03.6584-0113.3	320111	1H2 698 019	03.2122-1184.3	010592
191 698 151 D	13.0460-7032.2	607032	1H0 612 151 F	03.6584-0107.3	320110	1H2 721 401	03.2419-9910.3	030031
191 698 151 E	13.0460-7030.2	607030	1H0 615 123 B	24.3541-1739.5	240223	1HM 609 721	24.3727-0160.2	580160
191 698 151 F	13.0460-7030.2	607030	1H0 615 123 BV	24.3541-1739.5	240223	1HM 615 601	24.0110-0111.1	410111
191 698 151 G	13.0460-7033.2	607033	1H0 615 123 BX	24.3541-1739.5	240223	1HM 615 601	24.0110-0275.2	410275
191 698 151 H	13.0460-7032.2	607032	1H0 615 124 B	24.3541-1740.5	240224	1HM 698 151	13.0460-2821.2	602821
191 698 151 J	13.0460-7032.2	607032	1H0 615 124 BV	24.3541-1740.5	240224	1HM 698 151 A	13.0460-2821.2	602821
191 698 151 K	13.0460-7032.2	607032	1H0 615 124 BX	24.3541-1740.5	240224	1J0 611 053	13.0460-2821.2	602821
191 698 447	11.0101-4803.2	260008	1H0 615 301	24.0122-0100.1	422100	1J0 698 151 L	13.0460-7081.2	607081
191 698 451	13.0460-2937.2	602937	1H0 615 301	24.0322-0100.1	522100	1J0 698 151 L	13.0470-7081.2	LD7081
191 698 451 A	13.0460-2937.2	602937	1H0 615 301 A	24.0122-0100.1	422100	1J0 927 803	24.0711-1361.3	360022
191 698 451 B	13.0460-2937.2	602937	1H0 615 301 A	24.0322-0100.1	522100	1J0 927 804	24.0711-1362.3	360023
191 698 451 C	13.0460-2937.2	602937	1H0 615 423	24.3384-1707.5	240171	200 611 021	03.3119-0507.3	010264
191 698 451 D	13.0460-2937.2	602937	1H0 615 423 A	24.3384-1707.5	240171	211 609 537 N	03.0137-0055.2	650055
191 721 335	24.3728-0113.2	590113	1H0 615 423 B	24.3384-1707.5	240171	211 609 537 NX	03.0137-0055.2	650055
191 721 335 A	24.3728-0111.2	590111	1H0 615 423 C	24.3384-1707.5	240171	211 609 537 S	03.0137-0055.2	650055
191 721 335 AB	24.3728-0121.2	590121	1H0 615 423 D	24.3384-1707.5	240171	211 609 615	24.0225-2001.2	480045
191 721 335 C	24.3728-0111.2	590111	1H0 615 423 DX	24.3384-1707.5	240171	211 609 701 T	24.3727-0107.2	580107
191 721 335 D	24.3728-0121.2	590121	1H0 615 424	24.3384-1708.5	240172	211 611 021 AA	03.2123-2604.3	010178
191 721 335 E	24.3728-0113.2	590113	1H0 615 424 A	24.3384-1708.5	240172	211 611 021 AE	03.2120-8411.3	010125
191 721 335 F	24.3728-0120.2	590120	1H0 615 424 B	24.3384-1708.5	240172	211 611 021 AG	03.2120-8411.3	010125
191 721 335 G	24.3728-0121.2	590121	1H0 615 424 C	24.3384-1708.5	240172	211 611 021 AJ	03.2120-8411.3	010125
191 721 335 H	24.3728-0113.2	590113	1H0 615 424 D	24.3384-1708.5	240172	211 611 021 K	03.2122-0903.3	010136
191 721 335 J	24.3728-0113.2	590113	1H0 615 424 DX	24.3384-1708.5	240172	211 611 021 L	03.2122-0903.3	010136
191 721 335 M	24.3728-0111.2	590111	1H0 698 071	03.0137-0268.2	650268	211 611 021 N	03.2123-2604.3	010178
191 721 335 N	24.3728-0121.2	590121	1H0 698 151	13.0460-7032.2	607032	211 611 021 Q	03.2122-0903.3	010136
191 721 335 Q	24.3728-0121.2	590121	1H0 698 151 A	13.0460-7072.2	607072	211 611 021 T	03.2122-2905.3	010141
191 721 335 R	24.3728-0113.2	590113	1H0 698 151 B	13.0460-7101.2	607101	211 611 047	03.3222-0801.3	020067
191 721 335 S	24.3728-0113.2	590113	1H0 698 401	03.0101-0025.2	320014	211 611 047 C	03.3222-0801.3	020067
191 721 355 A	24.3728-0111.2	590111	1H0 698 451	13.0460-2984.2	602984	211 611 047 D	03.3223-1112.3	020092
191 927 807 A	24.0711-1313.3	360016	1H0 698 451 A	13.0460-2984.2	602984	211 611 047 F	03.3223-1112.3	020092
191 927 807 D	24.0721-1925.1	360039	1H0 698 451 B	13.0460-2937.2	602937	211 611 049 B	24.2725-0903.3	020145
192 611 019	03.2120-2031.3	010106	1H0 698 451 C	13.0460-2937.2	602937	211 611 050 B	24.2725-0904.3	020146
192 611 019 B	03.2122-1042.3	010137	1H0 698 451 D	13.0460-2984.2	602984	211 611 069 C	24.2725-0903.3	020145
1E0 698 451	13.0460-2984.2	602984	1H0 698 451 E	13.0460-2937.2	602937	211 611 070 C	24.2725-0904.3	020146
1E0 698 451 A	13.0460-2937.2	602937	1H0 698 451 F	13.0460-2937.2	602937	211 611 301 E	03.3508-8302.3	310046
1E0 698 451 C	13.0460-2984.2	602984	1H0 698 451 G	13.0460-2984.2	602984	211 611 701	24.5165-0425.3	331258
1E0 698 451 D	13.0460-2984.2	602984	1H0 698 451 H	13.0460-2937.2	602937	211 611 775	83.6101-0250.3	330203
1E0 698 451 E	13.0460-2984.2	602984	1H0 698 520 V	03.0137-0268.2	650268	211 611 775 A	24.5224-0295.3	331261
1E0 698 451 G	13.0460-2984.2	602984	1H0 698 520 X	03.0137-0268.2	650268	211 611 775 B	24.5224-0240.3	331260
1GD 698 151	13.0460-7032.2	607032	1H0 698 525 V	03.0137-0268.2	650268	211 611 775 C	83.6101-0250.3	330203
1H0 501 615	24.0220-0018.1	480019	1H0 698 525 X	03.0137-0268.2	650268	211 612 103 A	03.6850-0502.4	300044
1H0 501 615 A	24.0220-0018.1	480019	1H0 698 545	03.0137-9168.2	669168	211 615 107 A	13.2541-8002.2	210111
1H0 501 615 A	24.0220-0718.2	480209	1H0 698 545 A	03.0137-9168.2	669168	211 615 107 B	13.2541-8002.2	210111
1H0 609 525	03.0137-0268.2	650268	1H0 698 545 B	03.0137-9168.2	669168	211 615 108 A	13.2541-8001.2	210110
1H0 609 525 B	03.0137-0268.2	650268	1H0 927 807	24.0711-1361.3	360022	211 615 108 B	13.2541-8001.2	210110
1H0 609 525 D	03.0137-0268.2	650268	1H0 927 807 A	24.0721-1937.1	360040	211 615 301 B	24.0113-0132.1	413132
1H0 609 526	03.0137-0268.2	650268	1H0 927 807 B	24.0721-1919.1	360091	211 698 151	13.0460-6027.2	606027
1H0 609 526 B	03.0137-0268.2	650268	1H0 927 807 C	24.0751-1139.3	360295	211 698 151 A	13.0460-6027.2	606027
1H0 609 526 D	03.0137-0268.2	650268	1H0 927 807 D	24.0721-1191.3	360091	211 698 151 B	13.0460-6027.2	606027
1H0 609 527	03.0137-0268.2	650268	1H0 927 807 E	24.0751-1139.3	360295	211 698 151 C	13.0460-6028.2	606028
1H0 609 527 B	03.0137-0268.2	650268	1H0 927 808	24.0711-1362.3	360023	211 698 151 D	13.0460-6027.2	606027
1H0 609 527 D	03.0137-0268.2	650268	1H1 611 019 A	03.2120-3943.3	010532	211 698 151 E	13.0460-6028.2	606028
1H0 609 528	03.0137-0268.2	650268	1H1 611 019 B	03.2122-1042.3	010137	211 698 151 F	13.0460-6027.2	606027
1H0 609 528 B	03.0137-0268.2	650268	1H1 611 019 C	03.2120-3943.3	010532	211 698 471	13.0441-5415.2	250116
1H0 609 528 D	03.0137-0268.2	650268	1H1 612 107 A	03.7750-5502.4	300081	211 698 471 A	13.0441-5416.2	250117
1H0 609 721	24.3727-0135.2	580135	1H1 612 107 C	03.7750-5502.4	300081	211 698 471 C	13.0441-5415.2	250116
1H0								

Vergleichsliste

Cross reference list - Tabella di conversione codici



Liste des correspondances - Lista referencias

VAG 	VAG 	VAG 						
211 698 537 SX	03.0137-0055.2	650055	251 698 151 E	13.0460-6028.2	606028	281 721 335 B	24.3728-0126.2	590126
251 407 615 B	24.0116-0109.1	416109	251 698 151 F	13.0460-2903.2	602903	281 721 335 E	24.3728-0126.2	590126
251 407 615 Q	24.0116-0109.1	416109	251 698 447	11.0101-6004.2	260014	291 609 527 B	03.0137-0252.2	650252
251 407 617	24.0113-0142.1	413142	251 698 471	13.0441-5416.2	250117	291 609 527 E	03.0137-0252.2	650252
251 407 617 A	24.0113-0142.1	413142	251 698 471 B	11.0441-6003.2	250037	291 609 527 F	03.0137-0252.2	650252
251 407 617 D	24.0116-0104.1	416104	251 698 477	11.0101-6004.2	260014	291 609 527 G	03.0137-0252.2	650252
251 407 617 G	24.0116-0104.1	416104	251 698 531 EV	03.0137-0148.2	650148	291 609 527 H	03.0137-0252.2	650252
251 407 617 K	24.0116-0104.1	416104	251 698 531 EX	03.0137-0148.2	650148	291 609 528 B	03.0137-0252.2	650252
251 407 617 M	24.0116-0104.1	416104	251 698 531 LV	03.0137-0148.2	650148	291 609 528 E	03.0137-0252.2	650252
251 609 531	03.0137-0148.2	650148	251 698 531 LX	03.0137-0148.2	650148	291 609 528 F	03.0137-0252.2	650252
251 609 531 B	03.0137-0148.2	650148	251 698 545	03.0137-9035.2	669035	291 609 528 G	03.0137-0252.2	650252
251 609 531 BV	03.0137-0148.2	650148	251 721 263 A	03.2525-2711.3	040030	291 609 528 H	03.0137-0252.2	650252
251 609 531 BX	03.0137-0148.2	650148	251 721 335	24.3728-0123.2	590123	291 609 531 D	03.0137-0252.2	650252
251 609 531 E	03.0137-0148.2	650148	251 721 401 A	03.2419-8212.3	030020	291 609 531 E	03.0137-0252.2	650252
251 609 531 EV	03.0137-0148.2	650148	251 721 477	24.5803-0325.3	330051	291 609 531 F	03.0137-0252.2	650252
251 609 531 EX	03.0137-0148.2	650148	251 721 477 A	24.5803-0325.3	330051	291 609 531 H	03.0137-0252.2	650252
251 609 531 G	03.0137-0148.2	650148	251 721 477 D	24.5803-0325.3	330051	291 609 531 J	03.0137-0252.2	650252
251 609 531 K	03.0137-0148.2	650148	251 798 041	03.0450-2510.2	082510	291 609 532 E	03.0137-0252.2	650252
251 609 531 L	03.0137-0148.2	650148	281 609 527	03.0137-0259.2	650259	291 609 532 F	03.0137-0252.2	650252
251 609 531 M	03.0137-0148.2	650148	281 609 527 AV	03.0137-0259.2	650259	291 609 532 H	03.0137-0252.2	650252
251 609 531 N	03.0137-0148.2	650148	281 609 527 AX	03.0137-0259.2	650259	291 609 617	24.0227-0001.1	480052
251 609 531 P	03.0137-0148.2	650148	281 609 527 G	03.0137-0259.2	650259	291 611 047	03.3225-5512.3	020103
251 609 531 V	03.0137-0148.2	650148	281 609 527 H	03.0137-0259.2	650259	291 611 047 A	24.3226-0901.3	020295
251 609 531 X	03.0137-0148.2	650148	281 609 528	03.0137-0259.2	650259	291 611 047 B	24.3226-0901.3	020295
251 609 532	03.0137-0148.2	650148	281 609 528 A	03.0137-0259.2	650259	291 611 771	83.7724-0467.3	331274
251 609 532 B	03.0137-0148.2	650148	281 609 528 AV	03.0137-0259.2	650259	291 611 775	24.5224-0440.3	331378
251 609 532 BV	03.0137-0148.2	650148	281 609 528 AX	03.0137-0259.2	650259	291 615 107	13.9571-0041.2	210259
251 609 532 BX	03.0137-0148.2	650148	281 609 528 D	03.0137-0259.2	650259	291 615 107	24.9257-0041.5	230049
251 609 532 E	03.0137-0148.2	650148	281 609 528 G	03.0137-0259.2	650259	291 615 107 B	13.9571-0041.2	210259
251 609 532 EV	03.0137-0148.2	650148	281 609 528 H	03.0137-0259.2	650259	291 615 107 B	24.9257-0041.5	230049
251 609 532 EX	03.0137-0148.2	650148	281 609 531	03.0137-0259.2	650259	291 615 108	13.9571-0042.2	210260
251 609 532 G	03.0137-0148.2	650148	281 609 531 C	03.0137-0259.2	650259	291 615 108	24.9257-0042.5	230050
251 609 532 K	03.0137-0148.2	650148	281 609 531 F	03.0137-0259.2	650259	291 615 108 B	13.9571-0042.2	210260
251 609 532 L	03.0137-0148.2	650148	281 609 531 H	03.0137-0259.2	650259	291 615 108 B	24.9257-0042.5	230050
251 609 532 M	03.0137-0148.2	650148	281 609 531 J	03.0137-0259.2	650259	291 698 527 EV	03.0137-0252.2	650252
251 609 532 P	03.0137-0148.2	650148	281 609 532 C	03.0137-0259.2	650259	291 698 527 EX	03.0137-0252.2	650252
251 609 532 Q	03.0137-0148.2	650148	281 609 532 F	03.0137-0259.2	650259	291 698 527 GV	03.0137-0252.2	650252
251 609 532 V	03.0137-0148.2	650148	281 609 532 H	03.0137-0259.2	650259	291 698 527 GX	03.0137-0252.2	650252
251 609 532 X	03.0137-0148.2	650148	281 609 532 J	03.0137-0259.2	650259	293 609 701 A	24.3727-0120.2	580120
251 609 615	24.0225-2002.2	480046	281 609 617	24.0225-2003.1	480047	293 609 701 C	24.3727-0120.2	580120
251 609 701	24.3727-0109.2	580109	281 609 701	24.3727-0112.2	580112	293 609 701 D	24.3727-0120.2	580120
251 609 701 A	24.3727-0109.2	580109	281 609 701 B	24.3727-0112.2	580112	293 609 701 E	24.3727-0120.2	580120
251 609 701 B	24.3727-0109.2	580109	281 609 701 C	24.3727-0112.2	580112	2D0 609 525	03.0137-4001.2	654001
251 609 701 C	24.3727-0109.2	580109	281 609 702	24.3727-0113.2	580113	2D0 609 538	03.0137-4001.2	654001
251 611 021	03.2120-0851.3	010082	281 609 702 B	24.3727-0113.2	580113	2D0 615 601 A	24.0116-0110.1	416110
251 611 021 B	03.2123-0291.3	010165	281 609 702 C	24.3727-0113.2	580113	2D0 615 601 D	24.0116-0110.1	416110
251 611 021 C	03.2123-0271.3	010164	281 609 702 D	24.3727-0113.2	580113	2D0 698 451 B	13.0460-3990.2	603990
251 611 021 D	03.2123-0271.3	010164	281 611 011	03.2123-5212.3	010183	2D0 698 471	11.0441-6007.2	250146
251 611 021 E	03.2123-0271.3	010164	281 611 011 A	03.2123-5212.3	010183	2D0 698 525	03.0137-4001.2	654001
251 611 775	83.7824-0383.3	330856	281 611 011 B	03.2125-1712.3	010204	2D0 698 525 B	03.0137-4001.2	654001
251 611 775 A	83.7824-0383.3	330856	281 611 011 C	03.2125-1712.3	010204	2D0 919 351	24.8190-0407.2	620407
251 611 775 B	24.5224-0440.3	331378	281 611 011 D	03.2123-5212.3	010183	311 405 583 A	24.0110-0142.1	410142
251 611 775 D	24.5224-0440.3	331378	281 611 047	03.3225-5511.3	020102	311 611 015 K	03.2119-6713.3	010061
251 615 107	13.2541-8002.2	210111	281 611 771	83.6301-0355.3	330343	311 611 015 L	03.2119-6713.3	010061
251 615 107 A	13.2541-8002.2	210111	281 611 771 C	83.6124-0362.3	330715	311 611 023	03.3119-6457.3	010269
251 615 107 B	24.3601-1601.5	240203	281 611 775	24.5224-0299.3	331262	311 611 067 B	03.3222-5011.3	020462
251 615 108	13.2541-8001.2	210110	281 611 775 B	24.5224-0299.3	331262	311 611 067 C	03.3222-5011.3	020462
251 615 108 A	13.2541-8001.2	210110	281 612 105	03.6850-5402.4	300055	311 611 701 A	24.5165-0350.3	331257
251 615 108 B	24.3601-1602.5	240204	281 615 107	24.9257-8027.5	230039	311 611 701 B	83.6101-0325.3	330206
251 615 123 B	24.3601-1601.5	240203	281 615 107 B	24.9257-8027.5	230039	311 698 151 A	13.0460-3010.2	603010
251 615 123 D	24.3601-1601.5	240203	281 615 108	24.9257-8028.5	230040	311 698 151 B	13.0460-3010.2	603010
251 615 124 B	24.3601-1602.5	240204	281 615 108 B	24.9257-8028.5	230040	311 698 151 C	13.0460-4033.2	604033
251 615 124 C	24.3601-1710.5	240276	281 615 283 A	24.0120-0114.2	420114	311 698 151 E	13.0460-4033.2	604033
251 615 124 D	24.3601-1602.5	240204	281 698 151	13.0460-5701.2	605701	311 698 471	13.0441-4205.2	250086
251 615 219	11.8171-0008.1	990049	281 698 151 A	13.0460-5701.2	605701	321 609 721 C	24.3727-0108.2	580108
251 615 219 A	11.8171-0008.1	990049	281 698 151 B	13.0460-5701.2	605701	321 611 053 A	03.3217-2112.3	020027
251 698 151	13.0460-6028.2	606028	281 698 471	13.0441-5720.2	250122	321 611 701 B	24.5170-0315.3	331309
251 698 151 A	13.0460-6028.2	606028	281 698 527 AV	03.0137-0259.2	650259	321 611 701 C	24.5108-0266.3	330038
251 698 151 B	13.0460-6028.2	606028	281 698 527 AX	03.0137-0259.2	650259	321 611 701 D	24.5108-0266.3	330038
251 698 151 C	13.0460-2903.2	602903	281 698 527 GV	03.0137-0259.2	650259	321 611 701 F	24.5170-0315.3	331309
251 698 151 D	13.0460-6028.2	606028	281 698 527 GX	03.0137-0259.2	650259	321 611 775	24.5204-0180.3	331461

Vergleichsliste

Cross reference list - Tabella di conversione codici

Liste des correspondances - Lista referencias

VAG		VAG		VAG				
321 611 775 A	24.5201-0164.3	331414	357 615 123 D	24.3541-1731.5	240061	431 609 526 V	03.0137-0264.2	650264
321 611 775 B	24.5204-0180.3	331461	357 615 124 A	24.3541-1610.5	240040	431 609 526 X	03.0137-0264.2	650264
321 612 105	03.7750-0302.4	300071	357 615 124 AV	24.3541-1610.5	240040	431 609 527 E	03.0137-0264.2	650264
321 615 301	24.0112-0106.1	412106	357 615 124 AX	24.3541-1610.5	240040	431 609 527 EV	03.0137-0264.2	650264
321 615 301	24.0312-0106.1	512106	357 615 124 B	24.3541-1732.5	240062	431 609 527 EX	03.0137-0264.2	650264
321 615 301 A	24.0120-0123.1	420123	357 615 124 BX	24.3541-1732.5	240062	431 609 528 E	03.0137-0264.2	650264
321 615 301 A	24.0320-0123.1	520123	357 615 124 C	24.3541-1732.5	240062	431 609 528 EV	03.0137-0264.2	650264
321 615 301 B	24.0120-0123.1	420123	357 615 124 D	24.3541-1732.5	240062	431 609 528 EX	03.0137-0264.2	650264
321 615 301 B	24.0320-0123.1	520123	357 615 301	24.0113-0178.1	413178	431 611 707	83.6124-0362.3	330715
321 615 301 C	24.0120-0123.1	420123	357 615 301	24.0313-0178.1	513178	431 611 707 A	83.6134-0332.3	330716
321 615 301 C	24.0320-0123.1	520123	357 615 601	24.0110-0111.1	410111	431 611 775 A	24.5204-0180.3	331461
321 615 301 D	24.0120-0128.1	420128	357 615 601	24.0110-0275.2	410275	431 611 775 B	83.6224-0300.3	330730
321 615 301 D	24.0320-0128.1	520128	357 615 601 B	24.0110-0203.1	410203	431 615 301	24.0113-0160.1	413160
321 698 151	13.0460-7032.2	607032	357 615 601 B	24.0110-0276.2	410276	431 615 301 A	24.0122-0118.1	422118
321 698 151 B	13.0460-7033.2	607033	357 698 151	13.0460-2958.2	602958	431 698 071 C	03.0137-0268.2	650268
321 698 151 C	13.0460-7032.2	607032	357 698 151 A	13.0460-2957.2	602957	431 698 071 E	03.0137-0268.2	650268
321 698 151 D	13.0460-7033.2	607033	357 698 151 B	13.0460-2958.2	602958	431 698 073 C	03.0137-0268.2	650268
321 698 151 E	13.0460-7033.2	607033	357 698 151 C	13.0460-2806.2	602806	431 698 073 E	03.0137-0268.2	650268
321 698 151 F	13.0460-7032.2	607032	357 698 151 D	13.0460-2957.2	602957	431 698 151 D	13.0460-2934.2	602934
321 698 151 G	13.0460-7032.2	607032	357 698 151 E	13.0460-2821.2	602821	431 698 151 F	13.0460-2934.2	602934
321 698 151 H	13.0460-7033.2	607033	357 698 151 F	13.0460-2806.2	602806	431 698 151 G	13.0460-2934.2	602934
321 698 151 J	13.0460-7032.2	607032	357 698 525 CV	03.0137-0264.2	650264	431 698 471	11.0441-5401.2	250027
321 698 445	13.0460-0905.2	610905	357 698 525 CX	03.0137-0264.2	650264	431 698 525 V	03.0137-0264.2	650264
321 698 545	03.0137-9041.2	669041	357 698 525 V	03.0137-0268.2	650268	431 698 525 X	03.0137-0264.2	650264
321 721 335 H	24.3728-0114.2	590114	357 698 525 X	03.0137-0268.2	650268	431 721 261	03.2522-4211.3	040017
322 611 019	03.2120-2331.3	010110	357 721 261	24.2523-0908.3	040049	431 721 401	03.2419-9610.3	030029
322 611 019 A	03.2122-9612.3	010159	357 721 261 A	24.2523-0908.3	040049	431 721 401 A	03.2419-9610.3	030029
323 501 615	24.0220-0018.1	480019	357 721 261 B	24.2523-0908.3	040049	433 611 707	83.6134-0332.3	330716
323 501 615	24.0220-0718.2	480209	357 721 335	24.3728-0124.2	590124	433 611 775 A	24.5204-0180.3	331461
325 615 301 2	24.0112-0106.1	412106	357 721 335 E	24.3728-0124.2	590124	437 611 775	24.5170-0161.3	331308
325 615 301 2	24.0312-0106.1	512106	357 721 401	03.2419-9310.3	030027	437 615 301	24.0122-0120.1	422120
331 501 615 A	24.0220-0018.1	480019	357 721 401	24.0721-1925.1	360039	437 615 301 A	24.0122-0120.1	422120
331 609 525	03.0137-0146.2	650146	358 912 107	03.7750-4902.4	300079	437 615 601	24.0110-0154.1	410154
331 609 525 V	03.0137-0146.2	650146	358 612 107 B	03.7750-4902.4	300079	437 698 151	13.0460-2934.2	602934
331 609 525 X	03.0137-0146.2	650146	361 611 067 A	03.3223-0611.3	020091	437 698 451	13.0460-3602.2	603602
331 609 526	03.0137-0146.2	650146	3A0 609 721	24.3727-0153.2	580153	438 612 099	10.0124-3202.3	340011
331 609 526 V	03.0137-0146.2	650146	3A0 609 721 A	24.3727-0152.2	580152	438 612 099 A	10.0124-3202.3	340011
331 609 526 X	03.0137-0146.2	650146	3A0 609 721 B	24.3727-0153.2	580153	441 611 021	03.2125-3210.3	010212
331 609 527 F	03.0137-0146.2	650146	3A0 609 721 C	24.3727-0152.2	580152	441 611 021 A	03.2125-3210.3	010212
331 609 527 FV	03.0137-0146.2	650146	3A0 611 053	24.3220-0909.3	020210	441 611 021 B	03.2125-3610.3	010214
331 609 527 FX	03.0137-0146.2	650146	3A0 611 701	24.5147-0385.3	331427	441 611 707	83.7813-0252.3	330796
331 609 528 F	03.0137-0146.2	650146	3A0 615 123	24.3541-8523.5	240551	441 612 099 B	10.0124-3202.3	340011
331 609 528 FV	03.0137-0146.2	650146	3A0 615 123 A	24.3541-8523.5	240551	441 612 099 C	10.0124-3202.3	340011
331 609 528 FX	03.0137-0146.2	650146	3A0 615 124	24.3541-8524.5	240552	441 612 101 A	10.0124-3202.3	340011
331 611 051 A	03.3217-2112.3	020027	3A0 615 124 A	24.3541-8524.5	240552	441 612 101 B	10.0124-3202.3	340011
331 611 053	03.3217-2112.3	020027	3A0 615 125	11.8170-0306.1	260102	441 615 301 AA	24.0130-0104.1	430104
331 611 053 A	03.3217-2112.3	020027	3A0 615 125 A	11.8170-0306.1	260102	441 698 151	13.0460-2847.2	602847
357 501 615	24.0223-0012.1	480042	3A0 615 269	11.8116-0143.1	390513	441 698 151 A	13.0460-2847.2	602847
357 609 525 C	03.0137-0264.2	650264	3A0 615 301	24.0125-0108.1	425108	441 698 151 B	13.0460-2847.2	602847
357 609 526 C	03.0137-0264.2	650264	3A0 615 301 A	24.0125-0108.1	425108	441 698 151 D	13.0460-2847.2	602847
357 609 527 E	03.0137-0264.2	650264	3A0 698 151	13.0460-7081.2	607081	441 919 351 A	24.8190-0105.2	620105
357 609 528 E	03.0137-0264.2	650264	3A0 698 151	13.0470-7081.2	LD7081	443 501 615	24.0223-0007.1	480037
357 609 721	24.3727-0125.2	580125	3A0 698 151 A	13.0460-7081.2	607081	443 501 615 A	24.0223-0007.1	480037
357 609 721 A	24.3727-0126.2	580126	3A0 698 151 A	13.0470-7081.2	LD7081	443 501 615 B	24.0223-0011.1	480041
357 609 721 C	24.3727-0167.2	580167	3A0 698 471	11.0441-5409.2	250031	443 609 525	03.0137-0146.2	650146
357 609 721 D	24.3727-0126.2	580126	3A0 698 545	03.0137-9149.2	669149	443 609 525 A	03.0137-0264.2	650264
357 609 721 E	24.3727-0126.2	580126	3A0 927 807	24.0721-1193.3	360092	443 609 525 V	03.0137-0146.2	650146
357 611 019	03.2120-3943.3	010532	3A1 698 019	03.2123-1424.3	010637	443 609 525 X	03.0137-0146.2	650146
357 611 019 A	03.2122-1042.3	010137	3A1 721 388	03.2419-1206.3	030074	443 609 526	03.0137-0146.2	650146
357 611 019 B	03.2122-1042.3	010137	3A2 698 019	03.2123-1484.3	010595	443 609 526 A	03.0137-0264.2	650264
357 611 053 B	24.3220-0909.3	020210	3B0 615 125	11.8170-0306.1	260102	443 609 526 V	03.0137-0146.2	650146
357 612 107	03.7750-4302.4	300076	3D0 615 301 G	24.0130-0183.1	430183	443 609 526 X	03.0137-0146.2	650146
357 612 107 A	03.7750-4302.4	300076	411 698 151 B	13.0460-4033.2	604033	443 609 527	03.0137-0146.2	650146
357 612 151	03.6584-0015.3	320109	411 698 151 C	13.0460-4033.2	604033	443 609 527 A	03.0137-0264.2	650264
357 612 151 A	03.6584-0015.3	320109	411 698 471	13.0441-4205.2	250086	443 609 527 V	03.0137-0146.2	650146
357 615 123 A	24.3541-1609.5	240039	431 501 615	24.0223-0007.1	480037	443 609 527 X	03.0137-0146.2	650146
357 615 123 AV	24.3541-1609.5	240039	431 501 615 A	03.0137-0264.2	650264	443 609 528	03.0137-0146.2	650146
357 615 123 AX	24.3541-1609.5	240039	431 609 525	03.0137-0264.2	650264	443 609 528 A	03.0137-0264.2	650264
357 615 123 B	24.3541-1731.5	240061	431 609 525 V	03.0137-0264.2	650264	443 609 528 V	03.0137-0146.2	650146
357 615 123 BX	24.3541-1731.5	240061	431 609 525 X	03.0137-0264.2	650264	443 609 528 X	03.0137-0146.2	650146
357 615 123 C	24.3541-1731.5	240061	431 609 526	03.0137-0264.2	650264	443 609 721	24.3727-0119.2	580119

Vergleichsliste

Cross reference list - Tabella di conversione codici

Liste des correspondances - Lista referencias



VAG		VAG		VAG				
443 609 721 A	24.3727-0138.2	580138	443 721 261	03.2522-4211.3	040017	4A0 698 151 B	13.0460-2717.2	602717
443 609 721 E	24.3727-0130.2	580130	443 721 335 C	24.3728-0115.2	590115	4A0 698 151 C	13.0460-7050.2	607050
443 609 721 F	24.3727-0119.2	580119	443 721 335 D	24.3728-0115.2	590115	4A0 698 151 D	13.0460-2717.2	602717
443 609 721 G	24.3727-0130.2	580130	443 721 401 A	03.2419-9610.3	030029	4A0 698 451	13.0460-3602.2	603602
443 609 721 K	24.3727-0119.2	580119	443 919 081 D	10.0522-4005.1	340029	4A0 698 471	11.0441-5704.2	250034
443 611 019	03.2122-8012.3	010156	447 611 021	03.2125-2510.3	010209	4A0 721 261	24.2522-1707.3	040103
443 611 019 A	03.2122-8012.3	010156	447 615 301 A	24.0125-0102.1	425102	4A0 721 401	03.2419-9610.3	030029
443 611 021	03.2123-8512.3	010194	447 615 301 B	24.0125-0102.1	425102	4A1 612 097 B	10.0124-3202.3	340011
443 611 190	03.3517-5100.1	390326	447 615 423	24.3434-1701.5	240357	4A1 721 401	24.2419-1731.3	030121
443 611 707	83.6134-0332.3	330716	447 615 424	24.3434-1702.5	240358	4B0 615 125	11.8170-0306.1	260102
443 611 707 C	24.5113-0380.3	331344	447 615 601 A	24.0120-0137.1	420137	4D0 615 301 A	24.0130-0183.1	430183
443 611 775	83.6224-0300.3	330730	447 698 151	13.0460-2963.2	602963	4D0 615 301 F	24.0130-0183.1	430183
443 611 775 A	83.6204-0240.3	330718	447 698 151 A	13.0460-2963.2	602963	4D0 615 301 J	24.0130-0183.1	430183
443 611 775 B	83.6301-0150.3	330342	447 698 151 B	13.0460-2963.2	602963	4D0 698 151 B	13.0460-2717.2	602717
443 611 775 D	24.5204-0180.3	331461	447 698 151 C	13.0460-5403.2	605403	4D0 698 151 D	13.0460-2717.2	602717
443 611 775 F	24.5113-0220.3	331318	447 698 151 E	13.0460-2963.2	602963	4D0 698 451	13.0460-3602.2	603602
443 612 099	10.0124-3202.3	340011	447 698 151 F	13.0460-2963.2	602963	4D0 698 451 A	13.0460-3602.2	603602
443 612 099 B	10.0124-3202.3	340011	447 698 447	11.0101-5409.2	260035	4D0 698 451 B	13.0460-3602.2	603602
443 612 099 C	10.0124-3202.3	340011	447 698 451	13.0460-3602.2	603602	4D0 698 451 F	13.0460-3602.2	603602
443 614 151 A	03.6585-0108.3	320115	447 698 451 A	13.0460-3602.2	603602	4D0 698 451 G	13.0460-3602.2	603602
443 614 151 H	03.6585-0108.3	320115	447 698 451 B	13.0460-3602.2	603602	4D0 698 647	11.0101-5409.2	260035
443 615 107 C	11.3541-8521.2	220113	447 698 451 C	13.0460-3602.2	603602	531 609 525	03.0137-0126.2	650126
443 615 123	24.3541-1609.5	240039	477 611 775	83.6201-0175.3	330663	531 609 525 V	03.0137-0126.2	650126
443 615 123 A	24.3541-1719.5	240057	477 612 107 F	03.7750-5702.4	300083	531 609 525 X	03.0137-0126.2	650126
443 615 123 E	11.3541-8521.2	220113	477 698 151 A	13.0460-3612.2	603612	531 609 526	03.0137-0126.2	650126
443 615 123 EX	11.3541-8521.2	220113	481 611 701	83.6104-0250.3	330720	531 609 526 V	03.0137-0126.2	650126
443 615 123 F	24.3541-1719.5	240057	481 611 775	24.5170-0161.3	331308	531 609 526 X	03.0137-0126.2	650126
443 615 123 FV	24.3541-1719.5	240057	481 611 776	24.5201-0164.3	331414	531 609 527	03.0137-0126.2	650126
443 615 123 FX	24.3541-1719.5	240057	481 698 151 C	13.0460-5029.2	605029	531 609 527 V	03.0137-0126.2	650126
443 615 124	24.3541-1610.5	240040	481 698 151 E	13.0460-5029.2	605029	531 609 527 X	03.0137-0126.2	650126
443 615 124 A	24.3541-1720.5	240058	481 698 471	13.0441-3401.2	250044	531 609 528	03.0137-0126.2	650126
443 615 124 F	24.3541-1720.5	240058	4A0 501 615 A	24.0223-0014.1	480065	531 609 528 V	03.0137-0126.2	650126
443 615 124 FV	24.3541-1720.5	240058	4A0 501 615 B	24.0223-0014.1	480065	531 609 528 X	03.0137-0126.2	650126
443 615 124 FX	24.3541-1720.5	240058	4A0 609 721 B	24.3727-0141.2	580141	531 698 525 V	03.0137-0126.2	650126
443 615 301	24.0113-0160.1	413160	4A0 609 721 C	24.3727-0142.2	580142	531 698 525 X	03.0137-0126.2	650126
443 615 301 A	24.0122-0118.1	422118	4A0 609 721 D	24.3727-0154.2	580154	531 721 335 C	24.3728-0109.2	590109
443 615 301 B	24.0122-0118.1	422118	4A0 609 721 E	24.3727-0141.2	580141	533 611 019	03.2122-9812.3	010161
443 615 423 A	24.3384-1601.5	240013	4A0 609 721 F	24.3727-0142.2	580142	533 698 151	13.0460-2957.2	602957
443 615 423 AX	24.3384-1601.5	240013	4A0 611 019	03.2123-0491.3	010167	533 698 151 A	13.0460-2957.2	602957
443 615 424 A	24.3384-1602.5	240014	4A0 611 019 A	24.2123-1602.3	010384	535 609 721 A	24.3727-0134.2	580134
443 615 424 AX	24.3384-1602.5	240014	4A0 611 019 C	03.2123-0491.3	010167	535 611 701	24.5237-0333.3	331425
443 615 601	24.0110-0178.1	410178	4A0 611 019 D	24.2123-1602.3	010384	535 615 301	24.0122-0101.1	422101
443 615 601 A	24.0110-0207.1	410207	4A0 611 021 A	24.2123-1602.3	010384	535 615 423	24.3384-1603.5	240015
443 615 601 B	24.0110-0116.1	410116	4A0 611 021 B	03.2123-0491.3	010167	535 615 423 X	24.3384-1603.5	240015
443 615 601 E	24.0110-0200.1	410200	4A0 611 021 D	24.2123-1602.3	010384	535 615 424	24.3384-1604.5	240016
443 698 151	13.0460-2925.2	602925	4A0 611 021 E	24.2123-1731.3	010621	535 615 424 X	24.3384-1604.5	240016
443 698 151 A	13.0460-2925.2	602925	4A0 611 707	24.5237-0273.3	331444	5U0 501 615 B	24.0220-0018.1	480019
443 698 151 C	13.0460-2925.2	602925	4A0 611 775	24.5113-0209.3	331300	695 352 631	83.6101-0240.3	330202
443 698 151 D	13.0460-2925.2	602925	4A0 611 775 B	83.6104-0180.3	330510	6K0 611 701	24.5105-0442.3	331432
443 698 151 E	13.0460-2925.2	602925	4A0 615 123	24.3571-8505.5	240489	6N0 611 053	24.3217-0908.3	020167
443 698 151 F	13.0460-2925.2	602925	4A0 615 123 A	24.3571-8507.5	240555	6N0 611 701	24.5147-0385.3	331427
443 698 151 G	13.0460-2925.2	602925	4A0 615 124	24.3571-8506.5	240490	6N0 611 701 A	24.5147-0385.3	331427
443 698 151 H	13.0460-2925.2	602925	4A0 615 124 A	11.3571-8508.2	220128	6N0 611 701 B	24.5147-0385.3	331427
443 698 151 J	13.0460-2925.2	602925	4A0 615 124 A	24.3571-8508.5	240556	6N0 614 019	03.2122-1184.3	010592
443 698 151 K	13.0460-2925.2	602925	4A0 615 125 A	11.8170-0306.1	260102	6N0 614 019 A	03.2123-1484.3	010595
443 698 447	11.0101-5409.2	260035	4A0 615 269	11.8116-0143.1	390513	6N0 615 301 D	24.0120-0128.1	420128
443 698 451	13.0460-3602.2	603602	4A0 615 301 B	24.0115-0105.1	415105	6N0 615 301 D	24.0320-0128.1	520128
443 698 451 A	13.0460-3602.2	603602	4A0 615 301 B	24.0315-0105.1	515105	6N0 615 601	24.0110-0111.1	410111
443 698 451 B	13.0460-3602.2	603602	4A0 615 301 C	24.0125-0105.1	425105	6N0 615 601	24.0110-0275.2	410275
443 698 451 C	13.0460-3602.2	603602	4A0 615 301 C	24.0325-0105.1	525105	6N0 698 151 A	13.0460-2821.2	602821
443 698 470	11.0101-5403.2	260010	4A0 615 301 D	24.0125-0105.1	425105	6N0 698 151 B	13.0460-2821.2	602821
443 698 471	11.0441-5405.2	250030	4A0 615 301 D	24.0325-0105.1	525105	6Q0 609 525 A	03.0137-0268.2	650268
443 698 525 AV	03.0137-0264.2	650264	4A0 615 301 E	24.0125-0105.1	425105	6Q0 609 525 B	03.0137-0268.2	650268
443 698 525 AX	03.0137-0264.2	650264	4A0 615 301 E	24.0325-0105.1	525105	6Q0 609 526 A	03.0137-0268.2	650268
443 698 525 BV	03.0137-0264.2	650264	4A0 615 423	24.3384-1709.5	240257	6Q0 609 526 B	03.0137-0268.2	650268
443 698 525 BX	03.0137-0264.2	650264	4A0 615 423 X	24.3384-1709.5	240257	6Q0 609 527 A	03.0137-0268.2	650268
443 698 525 CX	03.0137-0264.2	650264	4A0 615 424	24.3384-1710.5	240258	6Q0 609 527 B	03.0137-0268.2	650268
443 698 525 V	03.0137-0146.2	650146	4A0 615 424 X	24.3384-1710.5	240258	6Q0 609 528 A	03.0137-0268.2	650268
443 698 525 X	03.0137-0146.2	650146	4A0 615 601 A	24.0110-0201.1	410201	6Q0 609 528 B	03.0137-0268.2	650268
443 698 545	03.0137-9044.2	669044	4A0 615 601 A	24.0310-0201.1	510201	6Q0 611 053 B	24.3219-0909.3	020188
443 698 647	11.0101-5409.2	260035	4A0 698 151	13.0460-7050.2	607050	6Q0 611 053 C	24.3217-0908.3	020167



Vergleichsliste

Cross reference list - Tabella di conversione codici



Liste des correspondances - Lista referencias

VAG		VAG		VAG				
6Q0 698 525	03.0137-0268.2	650268	811 609 722 E	24.3727-0139.2	580139	857 721 401 A	03.2419-8150.3	030019
6Q0 698 525 A	03.0137-0268.2	650268	811 611 019	03.2120-1531.3	010092	857 919 457	10.0522-4005.1	340029
6Q0 698 525 B	03.0137-0268.2	650268	811 611 019 B	03.2120-1531.3	010092	857 919 457 A	10.0522-4002.1	340028
6Q0 698 545	03.0137-9168.2	669168	811 611 019 D	03.2120-1531.3	010092	857 919 457 B	10.0522-4002.1	340028
6QE 611 053	24.3217-0908.3	020167	811 611 019 P	03.2120-2331.3	010110	861 609 721	24.3727-0103.2	580103
6QE 611 053 A	24.3219-0909.3	020188	811 611 019 Q	03.2120-2331.3	010110	861 609 721 A	24.3727-0103.2	580103
6R0 698 525 A	03.0137-0268.2	650268	811 611 775	83.6224-0200.3	330729	861 609 721 B	24.3727-0103.2	580103
6U0 501 615 B	24.0220-0018.1	480019	811 611 775 A	83.7804-0150.3	330853	861 609 729	24.3727-0146.2	580146
6U0 501 615 B	24.0220-0718.2	480209	811 611 817	03.3304-1400.1	390088	861 611 019 A	03.2117-3311.3	010040
6U0 611 019	24.2122-1731.3	010656	811 612 107 C	03.7750-0302.4	300071	861 611 019 B	03.2120-1531.3	010092
6U0 611 053 A	24.3222-1712.3	020424	811 614 151	03.6565-0101.3	320097	861 611 053	24.3219-0909.3	020188
6U0 611 053 B	24.3219-1721.3	020422	811 615 301	24.0110-0151.1	410151	861 611 053 A	03.3215-2311.3	020018
6U0 611 701	24.5166-0325.3	331293	811 615 301	24.0310-0151.1	510151	861 611 707	24.5225-0240.3	331321
6U0 611 701 A	24.5166-0325.3	331293	811 615 301 B	24.0110-0151.1	410151	861 611 707 A	24.5170-0296.3	331451
6U0 611 701 B	24.5166-0325.3	331293	811 615 301 B	24.0310-0151.1	510151	861 611 707 B	24.5170-0296.3	331451
6U0 612 151 A	03.6584-0107.3	320110	811 698 071	03.0137-0268.2	650268	861 611 707 C	24.5170-0296.3	331451
6U0 615 123	24.3541-1737.5	240197	811 698 073	03.0137-0268.2	650268	861 611 775	24.5204-0180.3	331461
6U0 615 124	24.3541-1738.5	240198	811 698 151	13.0460-4028.2	604028	861 615 301	24.0108-0100.1	408100
6U0 615 301	24.0113-0182.1	413182	811 698 525 AV	03.0137-0146.2	650146	861 615 301 B	24.0108-0100.1	408100
6U0 698 019	03.2123-1428.3	010476	811 698 525 AX	03.0137-0146.2	650146	861 698 151	13.0460-4028.2	604028
6U0 698 151	13.0460-2964.2	602964	812 612 107 C	03.7750-0302.4	300071	861 698 151 A	13.0460-4028.2	604028
6U0 698 151 A	13.0460-2964.2	602964	823 501 615 B	24.0218-0007.1	480003	861 698 471	11.0441-4402.2	250014
6U0 698 525	03.0137-0268.2	650268	823 501 615 B	24.0218-0707.2	480211	861 721 335 A	24.3728-0101.2	590101
6U0 698 525 A	03.0137-0268.2	650268	823 611 707	24.5170-0315.3	331309	861 721 335 C	24.3728-0118.2	590118
6U0 698 545	03.0137-9168.2	669168	823 611 775	24.5204-0180.3	331461	867 609 525	03.0137-0126.2	650126
6U0 721 335	24.3728-2500.2	592500	823 615 301	24.0110-0151.1	410151	867 609 525 X	03.0137-0126.2	650126
6U7 612 151	03.6583-0167.3	320140	823 615 301	24.0310-0151.1	510151	867 609 526	03.0137-0126.2	650126
6U7 615 105	24.3541-1737.5	240197	823 698 151	13.0460-4028.2	604028	867 609 527	03.0137-0126.2	650126
6U7 615 105 A	24.3541-1737.5	240197	823 698 151 A	13.0460-4028.2	604028	867 609 528	03.0137-0126.2	650126
6U7 615 106	24.3541-1738.5	240198	823 698 445	13.0460-0115.2	610115	867 609 701	24.3727-0129.2	580129
6U7 615 106 A	24.3541-1738.5	240198	823 698 471	11.0441-4402.2	250014	867 609 721	24.3727-0137.2	580137
7D0 698 471	11.0441-5704.2	250034	827 698 151 A	13.0460-4029.2	604029	867 698 151	13.0460-7059.2	607059
7L0 609 201	03.0137-9700.2	669700	827 698 471	11.0441-4402.2	250014	867 698 520 X	03.0137-0126.2	650126
7M0 615 423	24.3384-1707.5	240171	839 615 301	24.0112-0106.1	412106	867 698 525 V	03.0137-0126.2	650126
7M0 615 424	24.3384-1708.5	240172	839 615 301	24.0312-0106.1	512106	867 698 525 X	03.0137-0126.2	650126
803 611 051	03.3215-0221.3	020013	841 501 615 A	24.0220-0018.1	480019	867 721 335 A	24.3728-0101.2	590101
803 611 051 A	03.3217-0401.3	020023	841 501 615 A	24.0220-0718.2	480209	867 721 335 C	24.3728-0101.2	590101
803 611 301	03.3508-8302.3	310046	841 612 151	03.6565-0101.3	320097	867 721 335 E	24.3728-0118.2	590118
803 611 707	24.5113-0220.3	331318	841 615 301	24.0120-0123.1	420123	867 721 335 F	24.3728-0118.2	590118
803 611 707 A	83.6104-0180.3	330510	841 615 301	24.0320-0123.1	520123	867 721 335 H	24.3728-0118.2	590118
803 611 707 B	83.6124-0362.3	330715	849 611 701 G	24.5170-0315.3	331309	893 501 615	24.0220-0016.1	480018
803 611 775	24.5113-0220.3	331318	849 611 707 A	24.5170-0315.3	331309	893 501 615 A	24.0220-0017.1	480053
803 612 303	03.6058-0301.3	320072	849 698 151	13.0460-4029.2	604029	893 609 721	24.3727-0128.2	580128
803 698 151 A	13.0460-4033.2	604033	853 611 019	03.2122-9612.3	010159	893 609 721 A	24.3727-0143.2	580143
803 698 151 C	13.0460-4033.2	604033	853 611 019 A	03.2122-9612.3	010159	893 609 721 F	24.3727-0143.2	580143
803 698 471	13.0441-4801.2	250100	853 611 021	03.2123-0566.3	010169	893 609 721 G	24.3727-0128.2	580128
803 698 471 C	11.0441-4802.2	250017	853 611 775	83.6104-0250.3	330720	893 609 722	24.3727-0127.2	580127
803 945 515	24.3526-0810.3	340037	853 612 099	10.0124-3202.3	340011	893 609 722 A	24.3727-0144.2	580144
810 611 707	83.6124-0362.3	330715	853 612 107 A	03.7750-0302.4	300071	893 609 722 F	24.3727-0144.2	580144
811 501 615 B	24.0220-0016.1	480018	853 612 107 B	03.7750-0302.4	300071	893 609 722 G	24.3727-0127.2	580127
811 609 525	03.0137-0126.2	650126	853 612 107 D	03.7750-0302.4	300071	893 611 019	03.2122-9612.3	010159
811 609 525 A	03.0137-0146.2	650146	853 615 301 A	24.0120-0120.1	420120	893 611 019 A	03.2122-9612.3	010159
811 609 525 E	03.0137-0268.2	650268	853 615 301 C	24.0120-0120.1	420120	893 611 019 E	03.2122-9612.3	010159
811 609 526	03.0137-0126.2	650126	853 615 423 A	24.3384-1703.5	240055	893 611 021	03.2123-0566.3	010169
811 609 526 A	03.0137-0146.2	650146	853 615 423 AX	24.3384-1703.5	240055	893 611 021 B	03.2122-9612.3	010159
811 609 526 E	03.0137-0268.2	650268	853 615 424 A	24.3384-1704.5	240056	893 611 707	24.5237-0288.3	331442
811 609 527	03.0137-0126.2	650126	853 615 424 AX	24.3384-1704.5	240056	893 611 775	83.6104-0250.3	330720
811 609 527 A	03.0137-0146.2	650146	853 615 601	24.0110-0182.1	410182	893 611 775 A	24.5170-0161.3	331308
811 609 527 E	03.0137-0146.2	650146	853 698 151	13.0460-2926.2	602926	893 612 099	10.0124-3202.3	340011
811 609 528	03.0137-0126.2	650126	853 698 151 A	13.0460-2926.2	602926	893 612 107 A	03.7750-0302.4	300071
811 609 528 A	03.0137-0146.2	650146	855 698 151	13.0460-2936.2	602936	893 612 107 B	03.7750-0302.4	300071
811 609 528 E	03.0137-0146.2	650146	855 698 151 A	13.0460-2936.2	602936	893 615 108 A	11.3541-8521.2	220113
811 609 721	24.3727-0136.2	580136	855 698 151 B	13.0460-2936.2	602936	893 615 123	24.3541-1609.5	240039
811 609 721 A	24.3727-0136.2	580136	857 612 085	10.0515-0515.3	340024	893 615 124	24.3541-1610.5	240040
811 609 721 B	24.3727-0136.2	580136	857 612 085 A	10.0515-0515.3	340024	893 615 124 B	11.3541-8521.2	220113
811 609 721 C	24.3727-0136.2	580136	857 615 123	24.3541-1719.5	240057	893 721 261	24.5222-1707.3	040103
811 609 721 H	24.3727-0136.2	580136	857 615 124	24.3541-1720.5	240058	893 721 261 A	24.5222-1707.3	040103
811 609 721 J	24.3727-0136.2	580136	857 615 601	24.0120-0172.1	420172	893 721 401 A	03.2419-9210.3	030026
811 609 722 A	24.3727-0139.2	580139	857 698 451	13.0460-3602.2	603602	893 721 401 B	03.2419-9210.3	030026
811 609 722 B	24.3727-0139.2	580139	857 721 261	03.2522-4211.3	040017	893 721 401 D	03.2419-9210.3	030026
811 609 722 D	24.3727-0139.2	580139	857 721 401	03.2419-8150.3	030019	894 611 021	03.2123-0566.3	010169

Vergleichsliste

Cross reference list - Tabella di conversione codici

Liste des correspondances - Lista referencias



								
VAG			VOLVO			VOLVO		
895 615 301	24.0113-0166.1	413166	J04 476 350 80	24.3222-1740.3	020566	272691	13.0460-0422.2	610422
895 615 301 A	24.0122-0108.1	422108	J04 491 351 30	13.0460-5938.2	605938	272774	13.0460-3401.2	603401
895 615 301 B	24.0125-0106.1	425106	J04 491 352 00	13.0460-5938.2	605938	272779	13.0460-2953.2	602953
895 615 301 D	24.0125-0139.1	425139	J04 495 351 20	03.0137-0226.2	650226	272780	13.0460-2954.2	602954
895 615 601 A	24.0110-0261.1	410261	J04 495 351 21	03.0137-0226.2	650226	272809	13.0460-2943.2	602943
895 615 601 A	24.0310-0261.1	510261	J04 495 351 22	03.0137-0226.2	650226	272827	13.0460-3914.2	603914
895 698 151	13.0460-2963.2	602963	J43 512 351 80	24.0125-0118.1	425118	272831	13.0460-2953.2	602953
895 698 151 A	13.0460-2963.2	602963	J43 512 351 90	24.0120-0168.1	420168	272867	13.0460-2953.2	602953
895 698 151 B	13.0460-2963.2	602963	J47 550 260 90	24.3222-1740.3	020566	272868	13.0460-2954.2	602954
8A0 609 525	03.0137-0264.2	650264	ZBA 615 301	24.0112-0106.1	412106	272871	13.0460-2943.2	602943
8A0 609 525 A	03.0137-0264.2	650264	ZBA 615 301	24.0312-0106.1	512106	272873	13.0460-2953.2	602953
8A0 609 525 B	03.0137-0264.2	650264	VOLVO			272876	13.0460-2954.2	602954
8A0 609 526	03.0137-0264.2	650264	76801	24.3526-0100.3	340017	272903	13.0441-4014.2	250079
8A0 609 526 A	03.0137-0264.2	650264	270163	13.0460-2953.2	602953	272911	13.0460-3401.2	603401
8A0 609 526 B	03.0137-0264.2	650264	270164	13.0460-2954.2	602954	273171	03.0137-9173.2	669173
8A0 609 527	03.0137-0264.2	650264	270195	13.0460-2943.2	602943	274267	03.0137-0260.2	650260
8A0 609 527 A	03.0137-0264.2	650264	270736	24.0110-0189.1	410189	274270	03.0137-0260.2	650260
8A0 609 527 B	03.0137-0264.2	650264	270737	24.0114-0101.1	414101	275895	13.0460-2954.2	602954
8A0 609 528	03.0137-0264.2	650264	270739	24.0122-0127.1	422127	293421	03.6058-0501.3	320074
8A0 609 528 A	03.0137-0264.2	650264	270876	24.0114-0101.1	414101	436710	03.0101-0014.2	320004
8A0 609 528 B	03.0137-0264.2	650264	270902	24.0122-0217.2	422217	673766	03.2122-1906.3	010761
8A0 609 701 A	24.3727-0191.2	580191	270923	13.0441-3815.2	250069	678921	03.2122-1906.3	010761
8A0 609 702 A	24.3727-0148.2	580148	271179	13.0460-2935.2	602935	688048	03.3304-0700.1	390082
8A0 609 721 AE	24.3727-0147.2	580147	271182	13.0460-3914.2	603914	1205743	24.3727-1313.2	581313
8A0 609 721 AF	24.3727-0148.2	580148	271184	13.0460-3914.2	603914	1205780	24.0114-0101.1	414101
8A0 609 721 S	24.3727-0147.2	580147	271336	13.0460-2943.2	602943	1205782	24.0110-0189.1	410189
8A0 609 721 T	03.2123-0491.3	010167	271349	13.0460-2935.2	602935	1205893	03.2022-0111.3	010004
8A0 611 021	83.7812-0200.3	330846	271477	13.0460-3401.2	603401	1205894	03.2022-0109.3	010003
8A0 611 775	83.6212-0160.3	330318	271497	13.0460-2985.2	602985	1205977	83.6383-0300.3	330371
8A0 611 775 A	83.7724-0202.3	330852	271573	13.0460-3403.2	603403	1228153	24.0122-0127.1	422127
8A0 615 123	24.3541-1743.5	240219	271583	24.0110-0216.1	410216	1228272	24.7718-7301.2	990024
8A0 615 123 X	24.3541-1743.5	240219	271584	13.0460-2935.2	602935	1228942	24.0114-0101.1	414101
8A0 615 124	24.3541-1744.5	240220	271588	11.0441-5702.2	250033	1229100	83.6383-0300.3	330371
8A0 615 124 X	24.3541-1744.5	240220	271587	11.0101-5407.2	260011	1229347	83.6204-0286.3	330733
8A0 615 301	24.0113-0179.1	413179	271587	13.0460-3401.2	603401	1229428	03.0137-0169.2	650169
8A0 615 301 A	24.0122-0139.1	422139	271587	13.0460-7053.2	607053	1229549	13.2381-0039.2	210020
8A0 615 301 C	24.0125-0106.1	425106	271590	13.0470-7053.2	LD7053	1229550	13.2381-0040.2	210021
8A0 615 301 D	24.0113-0179.1	413179	271737	24.0126-0101.1	426101	1229551	13.2381-0039.2	210020
8A0 615 301 E	24.0122-0139.1	422139	271739	13.0460-2985.2	602985	1229552	13.2381-0040.2	210021
8A0 615 423	24.3384-1701.5	240169	271758	13.0460-2953.2	602953	1229785	24.3727-1306.2	581306
8A0 615 423 X	24.3384-1701.5	240169	271788	13.0460-3403.2	603403	1272323	24.2419-0928.3	030056
8A0 615 424	24.3384-1702.5	240170	271794	24.0126-0102.1	426102	1272362	83.6124-0305.3	330723
8A0 615 424 X	24.3384-1702.5	240170	271824	24.0110-0214.1	410214	1272758	13.2381-0039.2	210020
8A0 615 601	24.0110-0182.1	410182	271824	13.0460-3401.2	603401	1272759	13.2381-0040.2	210021
8A0 698 151	13.0460-2934.2	602934	271829	13.0460-2935.2	602935	1273678	24.2419-0928.3	030056
8A0 698 151 A	13.0460-2934.2	602934	271831	13.0460-0088.2	610088	1273681	03.2522-0420.3	040086
8A0 698 151 B	13.0460-2934.2	602934	271859	13.0460-7053.2	607053	1329594	83.6124-0305.3	330723
8A0 698 151 C	13.0460-2934.2	602934	271859	13.0470-7053.2	LD7053	1329611	83.6134-0335.3	330277
8A1 612 099	10.0124-3202.3	340011	271892	03.0655-0003.2	370003	1329740	03.2023-0164.3	010014
8A2 612 107	03.7750-0302.4	300071	271895	24.0110-0289.1	410289	1330248	24.2419-0928.3	030056
8D0 611 775 C	83.6212-0160.3	330318	271915	24.3728-1301.2	591301	1330249	24.2419-0928.3	030056
8D0 611 775 D	24.5113-0220.3	331318	271958	13.0460-2935.2	602935	1330310	03.0137-0169.2	650169
8D0 698 151	13.0460-2934.2	602934	271959	13.0460-3401.2	603401	1330414	24.9236-0001.5	230005
8D0 698 151 E	13.0460-2934.2	602934	271962	13.0460-3403.2	603403	1330415	24.9236-0002.5	230006
8D0 698 151 L	13.0460-2934.2	602934	271979	13.0460-2985.2	602985	1330416	24.9238-0087.5	230035
8E0 615 301 Q	24.0125-0105.1	425105	271997	03.0137-0169.2	650169	1330417	24.9238-0088.5	230036
8E0 615 301 Q	24.0325-0105.1	525105	271998	03.0137-0260.2	650260	1330419	13.2401-0028.2	210046
8E0 615 601	24.0110-0201.1	410201	272134	03.0137-0299.2	650299	1330799	03.2022-0111.3	010004
8E0 615 601	24.0310-0201.1	510201	272248	24.0110-0292.1	410292	1330800	03.2022-0112.3	010005
8E0 615 601 B	24.0110-0261.1	410261	272249	03.0137-0449.2	650449	1359131	24.0122-0127.1	422127
8E0 615 601 B	24.0310-0261.1	510261	272288	03.0137-0260.2	650260	1359156	24.0122-0217.2	422217
8E0 615 601 P	24.0110-0261.1	410261	272291	13.0460-2935.2	602935	1359229	13.2381-0039.2	210020
8E0 615 601 P	24.0310-0261.1	510261	272312	24.0126-0102.1	426102	1359230	13.2381-0040.2	210021
8E0 698 470 B	11.0101-5403.2	260010	272343	13.0460-7053.2	607053	1359290	24.0110-0206.1	410206
8N0 698 151	13.0460-7081.2	607081	272343	13.0470-7053.2	LD7053	1359291	83.6134-0300.3	330725
8N0 698 151	13.0460-7081.2	LD7081	272365	24.3728-1301.2	591301	1359543	03.2023-0503.3	010022
8V0 698 647	11.0101-5407.2	260011	272566	13.0460-2953.2	602953	1359906	24.0122-0138.1	422138
9-8380-57-753	13.0460-3010.2	603010	272567	13.0460-2954.2	602954	1359908	24.0122-0137.1	422137
J04 465 350 20	13.0460-5938.2	605938	272604	13.0441-3812.2	250068	1387506	03.3517-5100.1	390326
J04 465 353 20	13.0460-5938.2	605938	272643	13.0460-0088.2	610088	1387779	03.2023-0164.3	010014
			272673	13.0460-2953.2	602953	1387798	03.0137-0299.2	650299



Vergleichsliste

Cross reference list - Tabella di conversione codici

Liste des correspondances - Lista referencias

VOLVO 	VOLVO 	VOLVO 						
1387946	13.2401-0028.2	210046	3516881	03.0137-0260.2	650260	8602457	24.3571-9971.5	240617
3100021	13.0460-3010.2	603010	3516987	03.2023-0164.3	010014	8602458	11.9571-9972.2	220606
3100437	03.3217-0401.3	020023	3524365	13.2381-0097.2	210239	8602498	24.3571-9971.5	240617
3101749	24.3526-0810.3	340037	3524365	24.9238-0097.5	230037	8602499	11.9571-9972.2	220606
3104421	83.6104-0220.3	330474	3524366	13.2381-0098.2	210240	8603304	03.2023-0503.3	010022
3104544	03.3508-8302.3	310046	3524366	24.9238-0098.5	230038	8603305	03.2023-0164.3	010014
3104998	03.3508-8302.3	310046	3524397	83.6134-0270.3	330779	8603306	03.2023-0875.3	010890
3107114	03.3508-8302.3	310046	3530352	03.2023-0875.3	010890	9031502	11.9541-9806.2	220504
3202403	03.6055-0303.3	320064	3530354	03.2023-0875.3	010890	9031512	11.9541-9806.2	220504
3204990	24.5113-0280.3	330393	3530755	24.9236-0001.5	230005	9140175	10.6123-0445.3	010957
3205643	83.6104-0241.3	330731	3530756	24.9236-0002.5	230006	9140393	13.2401-0028.2	210046
3210674	24.0113-0172.1	413172	3530757	24.9238-0087.5	230035	9140449	10.6123-0445.3	010957
3267314	24.3219-0903.3	020184	3530758	24.9238-0088.5	230036	9140759	24.0126-0102.1	426102
3268705	83.6204-0240.3	330718	3530760	13.2401-0028.2	210046	9142039	24.3571-9971.5	240617
3277830	03.0137-0271.2	650271	3546359	83.6134-0335.3	330277	9142040	11.9571-9972.2	220606
3291141	83.6104-0241.3	330731	3546381	11.8116-0073.1	390498	9157386	83.6124-0380.3	330268
3293421	03.6058-0501.3	320074	3546491	13.2381-0097.2	210239	9157434	24.3571-9971.5	240617
3293451	24.0113-0172.1	413172	3546491	24.9238-0097.5	230037	9157435	11.9571-9972.2	220606
3296176	24.5113-0280.3	330393	3546492	13.2381-0098.2	210240	9157439	13.2381-0097.2	210239
3298167	24.0113-0172.1	413172	3546492	24.9238-0098.5	230038	9157440	13.2381-0098.2	210240
3342305	03.0137-0271.2	650271	3546535	83.6134-0335.3	330277	9157440	24.9238-0098.5	230038
3342534	13.0460-3306.2	603306	3546590	24.3727-1308.2	581308	9157451	24.3571-1707.5	240079
3342535	11.0101-5402.2	260009	3546634	03.6055-0430.3	320065	9157452	24.3571-1708.5	240080
3342541	11.8171-0008.1	990049	3546635	03.6055-0431.3	320142	9157737	03.2023-1084.3	010591
3343365	03.0101-0014.2	320004	3546813	83.6134-0335.3	330277	9157885	03.2023-1044.3	010590
3343433	13.0460-2846.2	602846	3549550	24.2419-0939.3	030065	9162612	24.0741-1105.1	360195
3343436	03.0137-0258.2	650258	4540510	03.3215-0221.3	020013	9163880	24.2419-0939.3	030065
3343437	24.3220-1113.3	020224	4737154	03.3508-4903.3	310032	9173299	24.3571-9971.5	240617
3343838	13.0460-3010.2	603010	4831249	03.3508-5951.3	310041	9173300	11.9571-9972.2	220606
3344061	13.0460-2812.2	602812	4872075	24.3526-0810.3	340037	9173855	83.6134-0270.3	330779
3344685	11.9541-9806.2	220504	5002010	13.2381-0039.2	210020	9181017	24.2522-0907.3	040043
3344689	11.8116-0073.1	390498	5002011	13.2381-0040.2	210021	9209756	24.3727-1308.2	581308
3344703	13.0460-7146.2	607146	5003514	24.9238-0087.5	230035	9209896	83.6134-0270.3	330779
3344787	13.0460-2812.2	602812	5003515	24.9238-0088.5	230036	9438036	03.7760-3602.4	300176
3344984	10.6120-0287.3	010334	5003811	11.9571-9972.2	220606	9438220	13.2401-0028.2	210046
3410294	24.0112-0135.1	412135	5003812	24.3571-9971.5	240617	9485265	24.3571-9971.5	240617
3412685	83.6124-0285.3	330722	5003813	13.2381-0098.2	210240	9485266	11.9571-9972.2	220606
3430032	24.0109-0125.1	409125	5003813	24.9238-0098.5	230038	9485267	13.0460-7053.2	607053
3430185	24.3727-1307.2	581307	5003814	13.2381-0097.2	210239	9485267	13.0470-7053.2	LD7053
3430408	83.6104-0336.3	330451	5003814	24.9238-0097.5	230037	9485593	13.0460-7053.2	607053
3432616	24.0109-0125.1	409125	6642028	24.3526-0110.3	340018	9485593	13.0470-7053.2	LD7053
3432618	24.0109-0125.1	409125	6806787	24.0721-1113.1	360193	30645136	13.0460-4964.2	604964
3446569	83.6104-0295.3	330244	6814279	24.3728-1301.2	591301	30648017	11.8171-0008.1	990049
3447432	24.5170-0465.3	331331	6814592	24.2520-0905.3	040057	30648381	13.0460-7053.2	607053
3450386	24.0109-0125.1	409125	6814719	24.2419-0941.3	030067	30648381	13.0470-7053.2	LD7053
3450387	24.0220-3015.1	480091	6819671	03.2023-0503.3	010022	30666345	03.0137-0449.2	650449
3455719	24.0122-0164.1	422164	6819749	03.2023-0164.3	010014	30666829	11.8171-0008.1	990049
3456981	24.3727-1309.2	581309	6819771	03.2023-0875.3	010890	30683788	11.0101-5407.2	260011
3457229	24.3727-1310.2	581310	6843128	24.2522-0907.3	040043	30683858	13.0460-4964.2	604964
3459661	24.0112-0135.1	412135	6843913	03.2522-0420.3	040086	30714429	83.6383-0300.3	330371
3459868	24.3728-1303.2	591303	6843914	24.2520-0905.3	040057	30714432	83.6124-0380.3	330268
3460736	24.3728-1303.2	591303	6848902	24.0126-0105.1	426105	30793799	13.0460-7053.2	607053
3465982	24.0721-1915.3	360149	6849311	24.0711-1146.1	360060	30793799	13.0470-7053.2	LD7053
3465983	24.0721-1916.3	360150	6849312	24.0721-1113.1	360193	30872926	24.0124-0136.1	424136
3470372	24.3728-1303.2	591303	8111057	24.3571-1707.5	240079	31261183	13.0460-2985.2	602985
3485043	24.5170-0465.3	331331	8111058	24.3571-1708.5	240080	31262209	24.0126-0105.1	426105
3502522	24.2419-0939.3	030065	8111101	24.3571-9971.5	240617	WARTBURG		
3502600	24.2522-0907.3	040043	8111102	11.9571-9972.2	220606			
3516312	10.6123-0445.3	010957	8602006	13.2381-0097.2	210239	08 31143 007	24.3219-1201.3	020197
3516317	13.2381-0097.2	210239	8602006	24.9238-0097.5	230037			
3516317	24.9238-0097.5	230037	8602007	13.2381-0098.2	210240			
3516318	13.2381-0098.2	210240	8602007	24.9238-0098.5	230038			
3516318	24.9238-0098.5	230038	8602016	03.2023-0503.3	010022			
3516392	03.6055-0431.3	320142	8602017	03.2023-0164.3	010014			
3516530	03.6055-0430.3	320065	8602018	03.2023-0875.3	010890			
3516565	24.3571-1707.5	240079	8602023	10.6120-0287.3	010334			
3516566	24.3571-1708.5	240080	8602302	10.6123-0445.3	010957			
3516567	24.0126-0105.1	426105	8602303	03.2023-1084.3	010591			
3516568	24.5201-0204.3	331400	8602304	03.2023-1044.3	010590			
3516840	24.3571-9971.5	240617	8602344	24.3571-9971.5	240617			
3516841	11.9571-9972.2	220606	8602345	11.9571-9972.2	220606			



Ⓓ Technische Übersetzungen

Ⓔ Technical translations

Ⓕ Traductions techniques

Ⓖ Traducciones técnicas

1-Kammer-Druckluftbremse	single-chamber air brake
1-Kolbensattel D=xx	single-piston caliper D=xx
2-Kolbensattel D=xx	2-piston caliper D=xx
4-Kolbensattel	4-piston caliper
1-Kreis-Bremse	single-circuit brake
2-Kreis-Bremse	two-circuit-brake
1-Kreis-Sättel	single-circuit caliper
2-Kreis-Sättel	two-circuit-caliper
1. Hinterachse	first rear axle
1. und 2. Hinterachse	first and second rear axle
4-Loch-Bremsscheibe	4-bore brake disc
6-Loch-Bremsscheibe	6-bore brake disc
3-Loch-Felge	3-bore wheel rim
4-Loch-Felge	4-bore wheel rim
5-Loch-Felge	5-bore wheel rim
6kt-Schraube	hexagon head screw
6kt-Schraube (innen)	hexagon socket screw
6"-Tandem	6"-tandem
8"-Tandem mit Gabelkopf	8"-tandem with yoke
8"-Tandem ohne Gabelkopf	8"-tandem without yoke
ABS	ABS (anti-lock brake system)
ABS-Dichtungssatz	ABS-gasket kit
Achtung: Kolbenstellung ändern !	attention: change piston position !
Adapter für Bördel E	adapter for bead type E
alle Typen	all types
Alu-Pumpe	alu-pump
Alu-Sättel	alu-calipers
am Bremssattel	on the brake caliper
am Hauptzylinder	on the master cylinder
A-Motor	A engine
Anschlagschraube oben	stop screw, top
Anschluß/Anschlüsse	connection/connections
Anti-Noise-Blech	shim
ASC (Automatische Stabilitäts Control)	ASC (automatic stability control)
ASR (Antriebsschlupfregelsystem)	ASR (traction control system TCS)
ATE nur über VAG erhältlich	ATE only available through VAG
auf Typenschild	on identification plate
aufgeschraubt	screwed on
Auslaß seitlich links	outlet lateral left-hand
Auslaß seitlich rechts	outlet lateral right-hand
außen	outer
automatische Nachstellung	automatic adjustment
Behälter	reservoir
Behälter Doppel-WE	reservoir with double warning device
Behälterbefestigung	reservoir fastening
Behälterstopfen	reservoir plug
Behälterverschraubung	reservoir cap
Behörde	authority cars
Beläge	brake pads
belüftete Scheiben	ventilated discs
Betätigungseinheit	actuation unit
blau	blue
Bodenventil	residual pressure center valve
Bodenventile tauschen	change residual pressure center valve
Bördel x	flare type x
braun	brown
breite Ausführung	wide design
Bremse	brake
Bremsergät	booster unit
Bremskraftregler	brake pressure regulator
Bremsleitungen erneuern !	renew brake lines !
Bremslichtschalter	stop-light switch
Bremsscheiben	brake discs
Bremsschlauch beachten !	notice brake hose !
Buchse + Ausgleichbügel	bushing + compensating clip
Bus	bus (van)
Bypassregler	by-pass regulator
Citroen-Bremse	Citroen-brake
D (Durchmesser) =	D (diameter) =
Dichtring	sealing ring
Dichtung	seal
Dichtungssatz	gasket kit
Differentialsperre	differential lock
Differenzdruckschalter	differential-pressure switch
Differenzdruckventil	differential pressure valve
diverse Typen	various types
Doppelbereifung	twin tyres



frein pneumatique à 1 chambre	freno de aire de 1 cámara
étrier à 1 piston D=xx	mordaza de freno D=xx
étrier à 2 pistons D=xx	mordaza con dos pistones D=xx
étrier à 4 pistons	mordaza con 4 pistones
frein à 1 circuit	freno de 1 circuito
frein à deux circuits	freno de 2 circuitos
étriers frein à 1 circuit	pinza de 1 circuito
étriers frein à 2 circuits	pinza de 2 circuitos
1. essieu arrière	1. eje trasero
1. et 2. essieu arrière	1. + 2. eje trasero
disques de frein à 4 trous	disco freno con 4 taladros
disques de frein à 6 trous	disco freno con 6 taladros
jante à 3 trous	Llantas de 3 taladros
jante à 4 trous	Llantas de 4 taladros
jante à 5 trous	Llantas de 5 taladros
vis hex.	tornillo hexagonal
vis hex. (intérieure)	tornillo hexagonal (interior)
6"-tandem	6"-tándem
8"-tandem avec chape	8"-tándem con cabeza de horquilla
8"-tandem sauf chape	8"-tándem sin cabeza de horquilla
ABS (système anti-blocage)	ABS (sistema de frenado antibloqueo)
jeu de joints de ABS	juego de reparación de juntas ABS
attention: position du piston à changer !	atención: cambiar posición pistón !
adaptateur pour colet E	adaptador para rebordes E
tous types	todos tipo
pompe en alu	bomba de aluminio
étriers en alu	mordaza de freno de aluminio
sur l'étrier de frein	a la pinza de freno
sur le maître-cylindre	a la bomba principal de freno
moteur A	motor de A
vis de butée en haut	tornillo de tope arriba
raccordement/raccordements	conexion/conexiones
tôle anti-bruit	placa anti-ruidos
ASC (contrôle de stabilité)	ASC (control automático de estabilidad)
ASR (anti-patinage)	ASR (sistemas antiderrapaje)
ATE (Teves) en vente chez VAG seulement	ATE solamente através de VAG
sur plaque d'identification	placa de identificación
vissé	fijado
échappement latéral gauche	salida lateral izquierda
échappement latéral droit	salida lateral derecha
mâle	exterior
ajustage automatique	reajuste automatico
réservoir	recipiente
réservoir avec témoin d'usure double	recipiente con doble aparato de aviso
fixation réservoir	recipiente de fijación
bouchon de réservoir	tapon
vissage de réservoir	fijación depósito
véhicule communal	vehiculos oficiales
plaquettes de frein	pastillas de freno
disques ventilés	disco ventilado
unité de commande	unidad de accionamiento
bleu	azul
soupape de pression résiduelle	válvula de fondo
soupape de pression résiduelle à changer	cambiar válvula de fondo
colet x	reborde x
marron	marron
exécution large	variante ancha
frein	freno
servo-frein	servofreno
correcteur de freinage	corrector de frenado
conduits de frein à renouveler !	renovar latiguillos de freno !
contacteur stop	interruptor de luz de freno
disques de frein	discos de freno
faire attention flexible de frein !	atención al latiguillo de freno !
douille + étrier de compensation	casquillo + estribo de compensación
autobus/car	autobus
régulateur à by-pass	regulador de by-pass
freins Citroen	freno Citroen
D (diamètre) =	D (diámetro) =
rondelle d'étanchéité	reten
joint	junta
jeu de joints	juego de reparación de juntas
blocaje de différentiel	bloqueo diferencial
interrupteur à pression différentielle	interruptor de presión diferencial
pression différentielle de soupape	valvula de presión diferencial
types diverses	diversos tipo
pneu double	cubierta doble

Doppelkabine	double cab
Druckbegrenzungsventil	pressure limiting valve
Druckbolzen	tappet
Druckbolzen (kurz)	tappet (short)
Druckbolzen (lang)	tappet (long)
Druckluftbremse	air brake
Druckluftleitung	compressed-air line
Druckluftunterstützung	air brake assistance
Druckluftverstärker	air brake booster
Druck-Warnschalter	pressure warning switch
DS-Regler	DS-valve
EDS	EDS (electronic differential lock)
EDS-Ventilblock	EDS-valve block
EG-Vorschrift	accordance with EC regulation
Einbau hinter der Achse	installation aft of axle
Einbau vor der Achse	installation forward of axle
Einbausatz	installation kit
Einfachbereifung	single tyre
Einknöpfmaß xx mm	button-in dimension xx mm
Einlaß D=xx mm	inlet diameter=xx mm
Einlaß mit Gummistopfen	inlet with rubber plug
Einschraubregler	screw-in proportioning valve
elektr. Vergaser	electr. carburetor
Entlüfteranschluß	bleeding connection
Entlüfterventil	bleeder valve
erhöhte Zuladung	increased payload
Ersatz für Sättel D=xx	replacement for calipers D=xx
ETS	ETS (electronic trac control system)
Europa	Europe
Export	Export
Fahrschule	driving school
Faltenbalgsatz	bellow seal set
Faustsättel	fist-type calipers
Fenster	window
Festsättel	fixed calipers
Flanschdicke x mm	flange thickness x mm
Flanschmaß = xx,x	flange dimension = xx,x
Fuller-Getriebe	fuller-gearbox
für Belagsätze ohne Zubehör	for brake pads without accessories
für Bremsättel/Vorgänger	for calipers/predecessor
für Doppelmembran-Gerät	for twin diaphragm booster
Gabelkopfsatz	yoke kit
Gehäuse L=	housing L=
gelb	yellow
gepanzerte Fahrzeuge	armoured vehicles
Getriebe	gearbox
Getriebe-Nr.	gearbox-no.
GG-Pumpe	cast-iron-pump
GG-Sättel	cast iron-caliper
GG-THz/Vorgänger	cast-iron-TMC/predecessor
Golf-Staaten	Gulf States
Gz mit senkrechtem Flansch	CC with vertical flange
Gz (Geberzylinder)	CC (clutch cylinder)
Gz-Reparatursatz	CC-repair kit
HA (Hinterachse)	RA (rear axle)
Haltefeder	retaining spring
Halter	anchor
Haltersatz	anchor set
Halterschraube	anchor screw
Handbremsbetätigung	hand brake actuation
Handbremshebel	handbrake lever
HA-Scheibenbremse	rear axle disc brake
HA-Trommelbremse	rear axle drum brake
Hebel	lever
Hochdach	high roof
Hohlschraube	hollow screw
Hosei-Bremse	Hosei brake
Hub	stroke
Hülsensatz	sleeve kit
Hydraulikspeicher	hydraulic accumulator
Hydraulikverstärker	hydraulic booster
Hydraulikzylinder	hydraulic cylinder
Hydr. Steuereinheit	hydraulic unit
Hz (Hauptzylinder)	MC (master cylinder)
Hz-Reparatursatz	MC-repair kit
im Fahrerhaus	in cab
im Motorraum	in engine compartment



cabine double	cabina doble
soupape à réglage de pression	válvula de limitación de presión
boulon de pression	perno de presión
boulon de pression (court)	perno de presión (corto)
boulon de pression (long)	perno de presión (largo)
frein à pneumatique	freno de aire comprimido
conduite pneumatique	aire comprimido de flexible
assistance à pneumatique	freno de aire auxiliar
amplificateur à pneumatique	servo de aire a presión
avertisseur d'alerte de pression	interruptor de aviso de presión
correcteur de DS	regulador DS
EDS (blocage de différentiel électronique)	EDS (bloqueo diferencial electrónico)
EDS-bloc de vannes	EDS válvula de bloqueo
aux prescriptions CEE	según normativa CEE
montage derrière l'essieu	instalación después del eje
montage devant l'essieu	instalación antes del eje
lot de montage	juego de montaje
pneu simple	cubierta simple
mesure à boutonner xx mm	medida de alojamiento xx mm
admission diamètre=xx mm	admisión diámetro = xx mm
admission avec bouchon de caoutchouc	admisión con tapon de goma
compensateurs à visser	regulador roscado
carburateur électrique	carburador eléctrico
raccordement de purge	conexión de purga
soupape de purge	válvula de purga
charge utile augmentée	incremento de carga
remplacement pour étriers D=xx	sustitución para pinzas D=xx
ETS (contrôle trajectoire)	ETS (sistema de control electr. de tracción)
Europe	Europa
Export	Exportación
auto-école	escuela de conducción
jeu de joints-soufflets	juego de reparac. de suspensión neumática
étriers à griffe	pinza de puno
fenêtre	ventana
étriers fixes	pinza de fija
épaisseur de la bride x mmm	grosor de la brida x mm
dimension de la bride = xx,x	medida de brida = xx,x
boîte à vitesse fuller	Fuller caja de cambios
pour garnitures de frein sauf accessoire	para juego de pastilla sin accesorios
pour étriers de frein/prédécesseur	para pinza/avisador
pour appareil à double membrane	para servo freno con doble membrana
jeu de chape	juego de cabeza de horquilla
corps L=	carcasa L=
jaune	amarillo
véhicule blindé	vehículo blindado
boîte de vitesse	caja de cambios
no. boîte de vitesse	número de caja de cambios
pompe en fonte/prise	bomba de fundición de gris
étriers en fonte/prise	pinza de fundición de gris
MCT fonte/prise/prédécesseur	cil. principal de fundición de gris/avisador
pays du Golfe Persique	estados del Golfo Pérsico
émetteur d'embrayage avec bride	cilindro distribuidor con brida vertical
EE (émetteur d'embrayage)	CTR (cilindro distribuidor)
néc. de réparation EE	juego de reparación de juntas CTR
AR (essieu arrière)	HA (eje trasero)
ressort à retenu	muelle de sujeción
support	soporte
jeu de support	juego de soporte
vis de support	tornillo de soporte
frein à main	activación de freno de mano
levier de frein à main	palanca freno de mano
frein à disque essieu AR	eje trasero disco de freno
frein à tambour essieu AR	eje trasero tambores de freno
levier	palanca
toit surélevé	techo sobrealzado
vis creuse	tornillo hueco
freins Hosei	freno de Hosei
course	elevación
jeu de douilles	juego de vaina
accumulateur hydraulique	acumulador de hidráulico
amplificateur hydraulique	servo hidráulico
cylindre de hydraulique	cilindro de hidráulico
modulateur	modulador de hidráulico
MC (maître cylindre)	CM (cilindro maestro)
néc. de réparation MC	juego de reparación CM
dans la cabine du conducteur	en cabina
dans compartiment moteur	en compartimento de motor

innen	inside
Innengewinde	inner thread
Kastenwagen	van
Katalysator	catalytic converter
Kennzeichen: xx	registration number: xx
Kerbe am Flansch	notch on flange
Klasse	class
Kleinbus	minibus
Klimaanlage	air conditioning
Kolbenstange D=	piston rod diameter=
Kolbenstange L=	piston rod length=
Kombiwagen	station wagon
Kompakt THz	compact TMC
Krankenwagen	ambulance
Kupplung	clutch
Kupplungsabgang	outlet port for clutch connection
Kupplungsverstärker	clutch booster
kurzer Radstand	short wheel base
kurzes Bremsgerät	short brake booster
L (Länge) =	L (length) =
langer Radstand	long wheel base
Leckageanzeige	leakage indicator
lieferbar	available
links oben und rechts unten	upper left and lower right
links vor und rechts hinter der Achse	left in front and right behind axle
Linkslenker	left hand drive
Luftfederung	pneumatic suspension
luftgekühlt	air-cooled
M8-Führungsbolzen	M8-guide pin
MA-Getriebe	MA gearbox
mit 1 Haltestift	with 1 retaining pin
mit 2 Haltestiften	with 2 retaining pins
mit Alufelgen	with alu wheel rim
mit angegossenem Behälter	with cast-on reservoir
mit geregelter Katalysator	with controlled catalytic converter
mit Laschen	with straps
mit Leichtmetallrädern	with light alloy rims
MKII-Aggregat kpl.	MKII complete unit
Mod. (Modell)	Mod. (model)
Motor	engine
Motor-Nr.	engine number
Motor-Pumpen-Aggregat	motor pump unit
Multi-Link-Achse	multi-link axle
m.Z. (mit Zubehör)	m.Z. (with accessories)
Nachstellteile-Satz	adjuster parts set
ND-Schlauch	ND low pressure hose
Nebenabtrieb	power take-off
Niveauregulierung	suspension level-control
Nz (Nehmerzylinder)	SC (slave cylinder)
Nz-Reparaturatz	SC-repair kit
ohne Alufelgen	without alu wheel rim
ohne geregelten Katalysator	uncontrolled catalytic converter
ohne Laschen	without straps
ohne Leichtmetallräder	without light alloy rim
O-Ring	O-ring
Pedal Feststeller	lockable pedal
Polizei	Police
Rad	wheel
Radsensor	wheel sensor
Radstand xxxx mm	wheel base xxxx mm
rechts oben und links unten	upper right and lower left
Rechtslenker	right hand drive
Regler	regulator
Reihenmotor	R engine
Reisebus/Hochdecker	tourist bus/high decker
Reparaturatz	repair kit
Ringstutzen-Satz	ring type nipple set
Rohrleitung	pipe line
rot	red
roter Sattel	red caliper
Rückschlagventil	non-return valve
Rückstellwellen-Satz	resetting shaft set
Rz (Radzylinder)	WC (wheel cylinder)
Rz-Dichtungssatz	WC-seal kit
Rz-Reparaturatz	WC-repair kit
Salisbury-Achse	Salisbury axle
Sattel mit 1 Haltestift	caliper with 1 retaining pin

intérieur	interior
taraudage intérieure	rosca interior
fourgonnette	furgon
catalyseur	catalizador
indice: xx	distintivo: xx
entaille sur la bride	muesca en brida
classe	clase
petit autobus	mini-bus
air conditionné	aire acondicionado
tige de commande diamètre=	varilla de pistón diámetro =
tige de commande longueur=	varilla de pistón largo=
voiture familière	break (familiar)
MCT compact	cilindro maestro tandem compacto
véhicule à ambulance	ambulancia
embrayage	embrague
sortie d'embrayage	salida conexión embrague
amplificateur d'embrayage	refuerzo embrague
empattement court	distancia corta entre ejes
servo-frein court	servofreno corto
L (longueur) =	L (largo) =
empattement long	distancia larga entre ejes
avertissement de fuite	indicador pérdida liquido de freno
disponible	suministrable
à gauche, en haut et à droite, en bas	izquierda arriba + derecha abajo
à gauche devant essieu et à droite derrière essieu	izquierda adelante+derecha atrás de eje
direction à gauche	volante a la izquierda
suspension pneumatique	suspensión neumática
refroidir par air	refrigeración por aire
boulon de guidage M8	perno de guía M8
boîte de vitesse MA	caja de cambios MA
avec 1 bouchon d'arrêt	con 1 pasador
avec 2 bouchon d'arrêts	con 2 pasadores
avec jante en alu	con Llantas de aluminio
réservoir en fonte commun	con depósito anadido
avec cataliseur réglé	con catalizador regulado
avec collier	con brida
avec jantes en aluminium	con Llantas de aluminio
agrégat MKII complet	MKII sistema completo
Mod. (modèle)	Mod. (modelo)
moteur	motor
numéro de moteur	número de motor
agrégat moteur pompe	systema motor-bomba
essieu multi-link	eje Multi-Link
m.Z. (avec accessoire)	m.Z. (con accesorios)
jeu de pièces d'ajustage	juego de acoplamiento
flexible de ND	ND flexible
propulsion secondaire	potencia adicional
correcteur d'assiette	regulación de altura de suspensión
RE (récepteur d'embrayage)	CRE (cilindro receptor)
néc. de réparation RE	juego de reparación de juntas CRE
sauf jante en alu	sin Llantas de aluminio
sauf cataliseur réglé	sin catalizador regulado
sans collier	sin brida
sauf jantes en aluminium	sin Llantas de aluminio
joint torique	junta torica
fixation des pédales	eje pedal
Police	Police
roue	rueda
capteur de roue	sensores de rueda
empattement xxxx mm	distancia entre rueda xxxx mm
à droite, en haut et à gauche, en bas	derecha arriba + izquierda abajo
direction à droite	volante a la derecha
régulateur	regulador
moteur en ligne	motor de R
autobus/car avec cabine élevée	autobús
néc. de réparation	juego de reparación
jeux de raccord annulaire	juego de tubuladura anular
conduite tube	latiguillo
rouge	rojo
étrier rouge	pinza roja
clapet antiretour	valvula de retención
jeu d'arbres de rappel	juego de onda de retroceso
CR (cylindre roue)	CR (cilindro de rueda)
jeu de joints CR	juego de reparación de juntas CR
néc. de réparation CR	juego de reparación CR
essieu Salisbury	Salisbury eje
étrier avec 1 bouchon d'arrêt	pinza con 1 pasador

D Technische Übersetzungen
EN Technical translations

Sattel mit 2 Haltestiften	caliper with 2 retaining pins
Sättel mit Gussnoppen	calipers with cast-naps
Sattelschraube	caliper screw
Scheibenbremse	disc brake
Scheibenkupplung	disc clutch
Scheibenschraube	disc screw
Schlauchleitung	line hose
Schraubstutzen	screw neck
schwarz	black
Schwimmsättel	floating caliper
Schwingblech WE	sheet metal warning device
SCS	SCS (stop control system)
separater Behälter	separate reservoir
separates Druckstück/Vorgänger	separate thrust member/predecessor
Servolenkung	power steering
Skandinavien	Scandinavia
Sitzplätze	seats
Sonderfahrzeuge	special vehicle
Spezialaufbau	special body
Sportfahrwerk	sports suspension
Spur	track
Standard-Bremsgerät	standard booster unit
Standard-THz	standard tandem master cylinder
staubfeste Ausführung	dustproof design
Stufenheck	saloon
T50-Reparatursatz	T50-repair kit
Tandemregler	tandem proportioning valve
THz mit 3 Anschlüssen	TMC with 3 connections
THz mit Anschlagsschraube	TMC with stop screw
THz (Tandemhauptzylinder)	TMC (tandem master cylinder)
THz-Reparatursatz	TMC-repair kit
THz-RS (Montagehülse)	TMC-repair kit (assembly sleeve)
Timken-Achse	Timken axle
Topfmanschette	pot seal
Tragbolzensatz	supporting bolt set
Transporter	transporters
Triebkopf	drive head
Trommelbremse	drum brake
TBB (Trommelbremsbacken)	DBS (drum brake shoes)
Umbau 1-teilig auf 2-teilig	reconstruction 1-piece to 2-piece
Unterdruckverstärker	vacuum booster
ursprüngl. verschraubte Beläge	initial screwed pads
VA (Vorderachse)	FA (front axle)
VA-Girling-Bremse	front axle girling-brake
VA-Scheibenbremse	front axle disc brake
VA-Trommelbremse	front axle brake drums
Ventilblock	valve block
Ventilblock kpl.	valve block complete
Verbindungsschrauben	connection screws
Verschlusschraube	screw plug
Verschraubung	screw fitting
Verschraubung kpl.	screw fitting cpl.
verstärkte Bremse	heavy-duty brake
verstärkte Stoßdämpfer	reinforced dampers (shock absorber)
verstärktes Fahrwerk	reinforced suspension
Verteilerstück wiederverwenden	reuse distributor piece
V-Motor	V engine
Vorder- und Hinterachse	front and rear axle
Vorderachse	front axle
Vorderachse und 2. Hinterachse	front axle and second rear axle
Vordruckventil	residual pressure valve
Vorgänger	predecessor
Vorgänger / Abschirmkappe	predecessor / deflector cap
Vorgänger-THz, Einlaß D=xx	predecessor-TMC, inlet diameter=xx
Vorspannzylinder	pre-loaded cylinder
WK (Warnkontakt)	WI (wear indicator)
Warnkontakt 1-polig	wear indicator single connector
Warnkontakt 2-polig	wear indicator twin connector
Warnschalter	warning switch
WE (Warneinrichtung)	WD (warning device)
WE-Befestigung	WD fixture
Wegsensor	travel sensor
weiß	white
Zylinderschraube	cylinder screw

étrier avec 2 bouchon d'arrêt	pinza con 2 pasadores
étriers avec nopés en fonte	pinzas con protuberancias de fundición
vis d'étrier	tornillo de pinza
disques de frein	disco de freno
embrayage du disque	disco de embrague
disque vis	tornillo de disco
conduite flexible	latiguillo flexible
raccordement à vis	tornillo de fijación
noir	negro
étrier flottant	pinza flotante
tôle oscillante dispositif d'avertissement	chapa para avisador de desgaste
SCS (système de contrôle stop)	SCS (sistema de control de frenada)
réservoir séparé	depósito independiente
pièce d'appui/prédécesseur	tubería de presión independiente/avisador
direction assistée	dirección asistida
Scandinavie	Escandinavia
sièges	plazas
véhicule spécial	vehículos especial
carrosserie spéciale	construcción carrocería especial
châssis sport	suspensión deportiva
voie	distancia entre ruedas
servo-frein standard	servo freno standard
MC-tandem standard	cilindro tandem standard
exécution anti poussière	versión antipolución
à coffre	parte trasera escalonada
néc. de réparation T50	juego de reparación T50
compensateur tandem	tandem regulador
MCT avec 3 raccords	cilindro tandem con 3 conexions
MCT avec vis de butée	cilindro tandem con tornillo de tope
MCT (maître cylindre tandem)	CMT (cilindro tandem)
néc. de réparation MCT	juego de reparación CMT
néc. de réparation MCT (douille d'assemblage)	juego de reparación CMT (vaina de montaje)
essieu Timken	Timken eje
coupelle	retén
jeu de boulons de suspension	juego de tornillo de soporte
transporter	furgoneta
tête de propulsion	grupo motriz
frein à tambour	tambores de freno
SGT (mâchoires de frein à tambour)	ZDF (zapatas de freno)
reconstruction 1 partie sur 2 parties	reconstrucción de 1 a 2 piezas
amplificateur à dépression	amplificador de depresion
à l'origine garnitures vissés	pastillas inicialmente montadas
VA (essieu avant)	VA (eje delantero)
frein à girling essieu avant	eje delantero - Girling freno
frein à disque essieu avant	eje delantero - disco de freno
tambours de frein essieu avant	eje delantero - tambores de freno
bloc de vannes	válvula de bloqueo
bloc de vannes complet	bloque de valvulas completo
vis de raccordement	tornillo de conexión
vis de fermeture	tornillo de cierre
couvercle	tornillo de fijación
couvercle complet	fijación completa
frein renforcé	freno reforzado
amortisseurs renforcés	amortiguadores reforzados
châssis renforcé	suspensión reforzada
distributeur à remettre	distribuidor de reemplazo
moteur en V	motor de V
essieu avant et essieu arrière	eje delantero + eje trasero
essieu avant	eje delantero
essieu avant et 2. essieu arrière	eje delantero + 2. eje trasero
soupape pression d'admission	válvula de presión previa
prédécesseur	predecesor
prédécesseur/défecteur	predecesor / tapa deflector
MCT prédécesseur, admission diamètre=xx	predecesor cilindro principal, admision D=xx
cylindre relais	cilindro preajustado
TU (témoin d'usure)	CD (contacto de desgaste)
témoin d'usure 1-borne	contacto de desgaste con 1 conexión
témoin d'usure 2-bornes	contacto de desgaste con 2 conexiones
interrupteur d'avertissement	interruptor de desgaste
DA (dispositif d'avertissement)	DD (dispositivo de desgaste)
fixation de DA	fijación del dispositivo de desgaste
capteur de course	sensor de ruta
blanc	blanco
vis cylindre	tornillo cilindrico

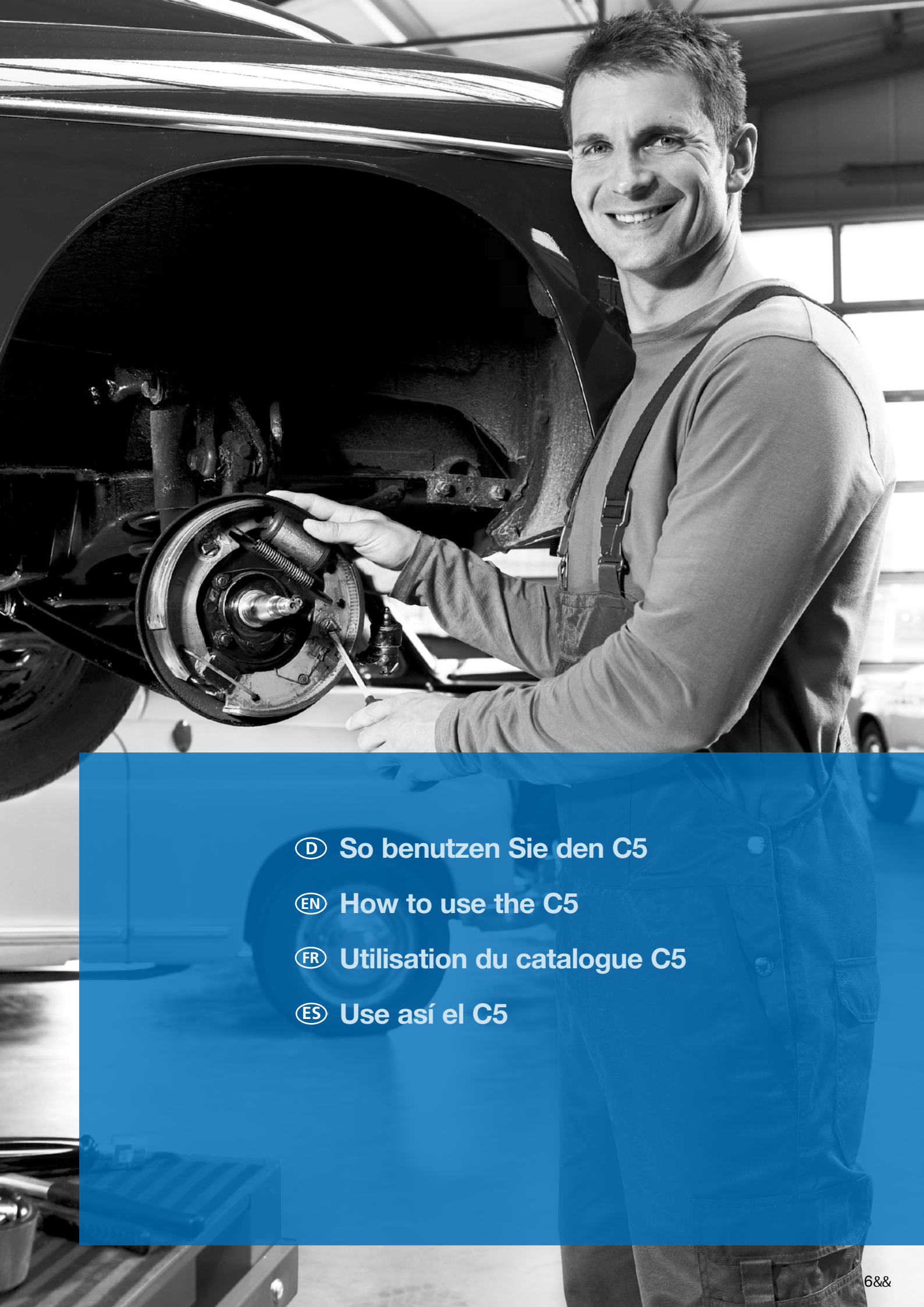

Ⓛ Ⓛ So benutzen Sie den C5

Ⓛ Ⓛ How to use the C5

Ⓛ Ⓛ Utilisation du catalogue C5

Ⓛ Ⓛ Use así el C5

How to use the C5

Product groups		Type of vehicle		Installation period (from/to)		ATE number		Remark (spare part)		
Front/rear axle		Chassis number		Remark (car)		Short number		Definition		
		kW								
AUDI A4 CABRIO (02-)										
	1,8 T 1,8 T Quattro 2,0 2,0 TFSI	◀ 120 ◀ 120 ◀ 96 ◀ 120	8E-55-999999 8E-55-400001	04.02 05.03 08.06 08.06	PR: 1LB,1LE PR: 1LB,1LE PR: 1LB,1LE PR: 1LB,1LE	11.3571-8522.2 11.3571-8521.2 11.0441-5704.2 11.0101-5409.2	220320 220319 250034 260035	+ ESP + ESP	D=57, - Halter D=57, - Halter Dichtungssatz Hülsensatz	ATE ATE ATE ATE
		**				***		****		

*Product groups

	Booster unit		Brake drum
	Master cylinder		ATE Original Kit ATE Original TopKit
	Reservoir		Drum brake shoes for parking brake
	Brake caliper		Handbrake cable
	Disc brake pads		Brake pressure regulator
	Brake disc ATE PowerDisc		Clutch cylinder
	Brake hose		Kupplungs-Nehmerzylinder
	Wheel sensor		Clutch hose
	Wheel cylinder		Clutch cable
	Drum brake shoes		

**Hand drive

- ◀ Left hand drive
- ▶ Right hand drive

***Manufacturer

ATE	Continental Teves (ATE)
AKE	Akebono
AP	AP Lockheed
BDX	Bendix
BOS	Bosch
BRE	Brembo
CIT	Citroën
DEL	Delco
FI	Fiat
FTE	FTE Automotive
LUC	Lucas (TRW)
PER	Perrot
SUM	Sumitomo
TOK	Tokico
VW	Volkswagen

***Installation Position



























- front
- rear
- left
- right
- upper left
- lower left
- upper right
- lower right
- center
- top
- bottom
- front axle
- front left
- front right
- rear axle
- rear left
- rear right

All position details are based on vehicle facing forwards

Abbreviations

-	Without / not	L=	Length
+	With / only / for	Nz	Slave cylinder
AUT	Automatic adjustment	PD	PowerDisc
B	Coated	Rz	Wheel cylinder
BG	Brake force limiter	RzR	Wheel cylinder with built-in corrector
BR	Brake pressure regulator	S	Fixing screw / caliper screw
BRE	Screw-in regulator	THz	Tandem master cylinder
BRES	Screw-in regulator set	V	Ventilated
BRL	Brake pressure regulator, load sensitive	WE	Warning device
D=	Diameter	WK	Wear indicator
Gz	Clutch cylinder	Zub	Accessories
HEB	Lever		
HZ	Master cylinder		
L	Alloyed / highly carburized		

Parts information

		SHORT NUMBER				SHORT NUMBER	
	03.6199-xxxx.4 → 03.61dy-xxxx.4 → 03.67dy-xxxx.4 → 03.68dy-xxxx.4 → 03.69dy-xxxx.4 → 03.77dy-xxxx.4 →	30nnnn 30nnnn 30nnnn 30nnnn 30nnnn 30nnnn	Brake booster T50 T51 T52/3 T52 T53 T52/4		24.02dd-dxxx.x → 230/231×47	48nnnn	Brake drums (e.g. 24.0223-0: Ø=230) Diameter / max. diameter × depth
	03.78dy-xxxx.4 → 03.78dy-xxxx.4 → 03.78dy-xxxx.4 → 03.78dy-xxxx.4 → 03.78dy-xxxx.4 → 03.78dy-xxxx.4 →	30nnnn 30nnnn 30nnnn 30nnnn 30nnnn 30nnnn	T52/4 T52/4Z T52/5 T52/5Z T55/1 T55/1Z		▲ 03.27dd-xxxx.3 → ▲ 03.32dd-xxxx.3 → 03.040x-xxdd.2 → 03.0470-xxdd.2 →	02nnnn 02nnnn 06nnnn 06nnnn	Single piston wheel cylinder Wheel cylinder Repair kit (with pistons) Gasket kit (without pistons)
	03.78dy-xxxx.4 → 03.78dy-xxxx.4 → 03.78dy-xxxx.4 → 03.78dy-xxxx.4 → 03.78dy-xxxx.4 →	30nnnn 30nnnn 30nnnn 30nnnn 30nnnn	T52/4 T52/4Z T52/5 T52/5Z T55/1 T55/1Z		03.0137-0xxx.2 → 03.0137-9xxx.2 →	650xxx 669xxx	Drum brake shoes Brake shoe accessories
	03.78dy-xxxx.4 → 03.78dy-xxxx.4 → 03.78dy-xxxx.4 → 03.78dy-xxxx.4 →	30nnnn 30nnnn 30nnnn 30nnnn	T52/4 T52/4Z T52/5 T52/5Z		185×31 AUT HEB Zub		Diameter × width With automatic adjustment With lever With accessories
	▲ 03.20dd-xxxx.3 → ▲ 03.21dd-xxxx.3 → ▲ 03.23dd-xxxx.3 → ▲ 03.31dd-xxxx.3 → 03.0370-xxdd.2 →	01nnnn 01nnnn 01nnnn 01nnnn 05xxdd	Step-bore tandem master cylinder Tandem master cylinder Step-bore master cylinder Master cylinder (e.g. 03.2122-: Ø=22,20) Repair kit		03.0420-xxdd.3 → 03.0520-xxdd.3 →	68xxdd 69xxdd	ATE original Kit ATE original TopKit (wheel cylinder + drum brake shoes + installation kit) dd = nominal dimension wheel cylinder
	03.3508-xxxx.x → 03.3509-xxxx.x → 03.3558-xxxx.x → 03.0101-xxxx.2 →	31nnnn 31nnnn 31nnnn 39nnnn	Reservoir Reservoir Reservoir Repair kit		03.0137-0xxx.2 → 03.0137-9xxx.2 →	650xxx 669xxx	Parking brake (drum brake shoes) Installation kit
	▲ 11.3ddx-xxxx.2 → 11.9ddx-xxxx.2 → ▲ 13.2ddx-xxxx.2 → ▲ 13.4ddx-xxxx.2 → 13.9ddx-xxxx.2 → 24.3ddx-xxxx.5 → 11.0441-ddxx.2 → 13.0441-ddxx.2 → 11.0230-xxxx.2 → 24.0101-xxxx.2 → ▲ 11.0101-xxxx.2 → 11.8116-xxxx.1 →	22nnnn 22nnnn 21nnnn 21nnnn 21nnnn 24nnnn 25nnnn 25nnnn 26nnnn 26nnnn 26nnnn 39nnnn	Fist-type caliper Fist-type caliper 2 cyl. fixed caliper 4 cyl. fixed caliper Fixed caliper Remanufactured fist-type caliper Gasket kit Gasket kit Fist caliper holder set (holder, sliding sleeve set, guide pins) Brake calliper accessories (sliding sleeve set, guide pins) Sliding sleeve set Retaining spring		185×31 AUT HEB Zub		Diameter × width With automatic adjustment With lever With accessories
	▲ 11.0101-xxxx.2 → 11.8116-xxxx.1 →	26nnnn 39nnnn	Sliding sleeve set Retaining spring		24.3727-xxxx.2 →	58xxxx	Handbrake cable
	13.0460-xxxx.2 → 13.0460-0xxx.2 → 24.8190-xxxx.2 → 20034 15,0 + WE WK S Zub	60xxxx 610xxx 62xxxx	Disc brake pad Accessories for brake pad set Wear indicator		83.5yxx-LLLL.3 → 83.6yxx-LLLL.3 → 83.7yxx-LLLL.3 →	33nnnn 33nnnn 33nnnn	Brake/clutch hose Brake/clutch hose Brake/clutch hose y = 1: Thread 1× inner/1× outer y = 2: Thread 2× inner y = 3: Thread 2× outer
	13.0460-xxxx.2 → 13.0460-0xxx.2 → 24.8190-xxxx.2 →	60xxxx 610xxx 62xxxx	Disc brake pad Accessories for brake pad set Wear indicator		03.60xx-xxxx.3 → 03.65xx-xxxx.3 → 03.0101-xxxx.2 →	32nnnn 32nnnn 32nnnn	Brake pressure regulator (BR) Brake force limiter (BG) Screw-in regulator (BRE) Brake pressure regulator, load-sensitive (BRL) Screw-in regulator set (BRES)
	20034 15,0 + WE WK S Zub		WVA no. / thickness For further WVA no's. see appendix Warning device With wear indicator With caliper screw With accessories		35/3 braun (4)		Markings, coloured markings (number of connections)
	Brake pads have homologation by German Federal Road Safty Department (ABE), or homologation according to regulation ECE-R 90 i.e. the brake pads are from the same production and subject to the same quality assurance procedures as the pad provided by the vehicle manufacturer.				▲ 03.24dd-xxxx.3 → 03.0350-ddxx.2 →	03nnnn 07ddxx	Clutch cylinder (e.g. 03.2419-: Ø=19,05) Gasket kit
	24.01dd-xxxx.x → 24.03dd-xxxx.x →	4ddxxx 5ddxxx	Brake disc ATE PowerDisc dd = thickness (e.g. 24.0322- : thickness = 22)		▲ 03.25dd-xxxx.3 → 03.0450-ddxx.2 →	04nnnn 08ddxx	Slave cylinder (e.g. 03.2525-: Ø=25,40) Gasket kit
	284 22 20 V L PD B V L S PD		Diameter / thickness / minimum thickness Coated Ventilated Alloyed / highly carburized Fixing screw ATE PowerDisc		24.3728-xxxx.2 →	59xxxx	Clutch cable
					24.07xx-xxxx.x →	36nnnn	Wheel sensor

nnnn = The last four digits correspond to a running number.

dd = Nominal dimension

▲ 24. also possible using same numbering system.
■ 03. and 24. also possible using same numbering system.

Complete copies or extracts of this catalog only by permission. Damage claims on the basis of data in this catalog cannot be recognized. The right of modification in construction or design is reserved. As far as we refer in our documents to part numbers of the vehicle makers, this is for comparison purposes only. The use of such information on invoices to the vehicle owner is not admissible.

The multitude of car models and spare parts from numerous vehicle manufacturers do not always allow an exact allocation. Therefore please pay attention to the corresponding remarks and spare part descriptions. Please therefore pay attention to the corresponding comments and spare parts descriptions.

Utilisation du catalogue C5

Groupes de produit		Type de véhicule	Date de montage (du/au)		Référence ATE		Remarque (référence)				
Essieu avant/arrière		No. de châssis (du/au)	Remarque (véhicule)		Référence Courte		Indication				
kW											
AUDI A4 CABRIO (02-)											
	1,8 T 1,8 T Quattro 2,0 2,0 TFSI	◀ 120 ◀ 120 ◀ 96 ◀ 120	8E-55-999999 8E-55-400001	04.02 05.03 08.06 08.06	PR: 1LB,1LE PR: 1LB,1LE PR: 1LB,1LE PR: 1LB,1LE	11.3571-8522.2 11.3571-8521.2 11.0441-5704.2 11.0101-5409.2	220320 220319 250034 260035		+ ESP + ESP	D=57, - Halter D=57, - Halter Dichtungssatz Hülzensatz	ATE ATE ATE ATE
*		**				***		****			

*Groupes de produit

	Servo-frein		Tambour de frein
	Maître cylindre		Kit d'origine ATE TopKit d'origine ATE
	Réservoir		Mâchoires de frein à tambour pour frein à main
	Etrier de frein		Câble de frein à main
	Plaquettes de frein		Correcteur de freinage
	Disque de frein ATE PowerDisc		Emetteur d'embrayage
	Flexible de frein		Récepteur d'embrayage
	Capteur ABS		Flexible d'embrayage
	Cylindre de roue		Câble d'embrayage
	Mâchoires de frein à tambour		

**Direction

- ◀ Conduite à gauche
- ▶ Conduite à droite

****Fabricant

ATE	Continental Teves (ATE)
AKE	Akebono
AP	AP Lockheed
BDX	Bendix
BOS	Bosch
BRE	Brembo
CIT	Citroën
DEL	Delco
FI	Fiat
FTE	FTE Automotive
LUC	Lucas (TRW)
PER	Perrot
SUM	Sumitomo
TOK	Tokico
VW	Volkswagen

***Positionnement























-
-
-
-
-
-
-
-
-
-
-
-
-
-
-
-
-

Toutes positions vues en position de conduite

Abréviations

-	Sauf / sans	L=	Longueur
+	Avec / seulement / pour	Nz	Récepteur d'embrayage
AUT	Ajustage Automatique	PD	PowerDisc
B	Revêtu	Rz	Cylindre de roue
BG	Limiteur de freinage	RzR	Cylindre de roue avec correcteur intégré
BR	Correcteur de freinage	S	Vis d'étrier / vis de fixation
BRE	Correcteur à visser	THz	Maître cylindre tandem
BRES	Jeu de correcteur à visser	V	Ventil
BRL	Correcteur de freinage asservi à la charge	WE	Dispositif d'avertissement
D=	Diamètre	WK	Témoin d'usure
Gz	Emetteur ,embrayage	Zub	Accessoires
HEB	Levier		
HZ	Maître cylindre		
L	Allié / carbonise		

Explications des références

		RÉF. COURTE																							
		03.6199-xxxx.4 → 30nnnn 03.61dy-xxxx.4 → 30nnnn 03.67dy-xxxx.4 → 30nnnn 03.68dy-xxxx.4 → 30nnnn 03.69dy-xxxx.4 → 30nnnn 03.77dy-xxxx.4 → 30nnnn 03.78dy-xxxx.4 → 30nnnn 03.78dy-xxxx.4 → 30nnnn 03.78dy-xxxx.4 → 30nnnn 03.78dy-xxxx.4 → 30nnnn 03.78dy-xxxx.4 → 30nnnn 03.78dy-xxxx.4 → 30nnnn	Servo-frein T50 T51 T52/3 T52 T53 T52/4 T52/4 T52/4Z T52/5 T52/5Z T55/1 T55/1Z	<table border="1"> <tr> <td>d</td> <td>y</td> </tr> <tr> <td>2 = 6"</td> <td>0 = Appareil simple</td> </tr> <tr> <td>3 = 7"</td> <td>5 = Appareil tandem</td> </tr> <tr> <td>4 = 8"</td> <td>0 = Appareil simple</td> </tr> <tr> <td>5 = 9"</td> <td>3 = Appareil simple BA</td> </tr> <tr> <td>6 = 10"</td> <td>5 = Appareil simple</td> </tr> <tr> <td></td> <td>8 = Appareil simple BA</td> </tr> <tr> <td></td> <td>BA = Assistance de freinage avec AFU</td> </tr> <tr> <td></td> <td>Z = Servo-frein à tirant</td> </tr> </table>	d	y	2 = 6"	0 = Appareil simple	3 = 7"	5 = Appareil tandem	4 = 8"	0 = Appareil simple	5 = 9"	3 = Appareil simple BA	6 = 10"	5 = Appareil simple		8 = Appareil simple BA		BA = Assistance de freinage avec AFU		Z = Servo-frein à tirant		24.02dd-dxxx.x → 48nnnn 230/231×47 03.27dd-xxxx.3 → 02nnnn 03.32dd-xxxx.3 → 02nnnn 03.040x-xxdd.2 → 06nnnn 03.0470-xxdd.2 → 06nnnn 03.0137-0xxx.2 → 650xxx 03.0137-9xxx.2 → 669xxx 185×31 AUT HEB Zub	Tambours de frein (p.ex. 24.0223-0: Ø=230) Diamètre / diamètre max. x largeur Cylindre de roue borgne Cylindre de roue Néc. de réparation (avec pistons) Jeu de joints (sans pistons) Mâchoires de frein à tambour Accessoires pour mâchoires de frein Diamètre x largeur avec ajustage automatique avec levier avec accessoires
					d	y																			
					2 = 6"	0 = Appareil simple																			
					3 = 7"	5 = Appareil tandem																			
					4 = 8"	0 = Appareil simple																			
					5 = 9"	3 = Appareil simple BA																			
					6 = 10"	5 = Appareil simple																			
						8 = Appareil simple BA																			
						BA = Assistance de freinage avec AFU																			
						Z = Servo-frein à tirant																			
	▲ 03.20dd-xxxx.3 → 01nnnn ▲ 03.21dd-xxxx.3 → 01nnnn ▲ 03.23dd-xxxx.3 → 01nnnn ▲ 03.31dd-xxxx.3 → 01nnnn 03.0370-xxdd.2 → 05xxdd	Maître cylindre tandem étagé Maître cylindre tandem Maître cylindre étagé Maître cylindre simple circuit (p.ex. 03.2122-: Ø=22,20) Néc. de réparation		03.0420-xxdd.3 → 68xxdd 03.0520-xxdd.3 → 69xxdd	Kit d'origine ATE TopKit d'origine ATE (cylindre de roue + mâchoires de frein à tambour + lot de montage) dd = dimension nominal cylindre de roue																				
							03.3508-xxxx.x → 31nnnn 03.3509-xxxx.x → 31nnnn 03.3558-xxxx.x → 31nnnn 03.0101-xxxx.2 → 39nnnn	Réservoir Réservoir Réservoir Néc. de réparation		03.0137-0xxx.2 → 650xxx 03.0137-9xxx.2 → 669xxx	Frein à main (mâchoires de frein à tambour) Lot de montage														
													▲ 11.3ddx-xxxx.2 → 22nnnn 11.9ddx-xxxx.2 → 22nnnn ▲ 13.2ddx-xxxx.2 → 21nnnn ▲ 13.4ddx-xxxx.2 → 21nnnn 13.9ddx-xxxx.2 → 21nnnn 24.3ddx-xxxx.5 → 24nnnn 11.0441-ddxx.2 → 25nnnn 13.0441-ddxx.2 → 25nnnn 11.0230-xxxx.2 → 26nnnn 24.0101-xxxx.2 → 26nnnn ▲ 11.0101-xxxx.2 → 26nnnn 11.8116-xxxx.1 → 39nnnn	Etrier à griffe Etrier à griffe Etrier à 2 pistons Etrier à 4 pistons Etrier fixe Etrier à griffe de réchange Jeu de joints Jeu de joints Jeu de supports d'étriers à griffe (support, jeu de douilles de guidage, boulon de guidage) Accessoires pour étriers de frein (jeu de douilles de guidage, boulon de guidage) Jeu de douilles de guidage Ressort à retenu		185×31 AUT HEB Zub	Diamètre x largeur avec ajustage automatique avec levier avec accessoires								
																			24.3727-xxxx.2 → 58xxxx	Câble de frein à main					
	■ 83.5yx-LLLL.3 → 33nnnn ■ 83.6yx-LLLL.3 → 33nnnn ■ 83.7yx-LLLL.3 → 33nnnn	Flexible de frein-/d'embrayages Flexible de frein-/d'embrayages Flexible de frein-/d'embrayages y = 1: Raccordement 1x femelle/1x mâle y = 2: Raccordement 2x femelle y = 3: Raccordement 2x mâle																							
				13.0460-xxxx.2 → 60xxxx 13.0460-0xxx.2 → 610xxx 24.8190-xxxx.2 → 62xxxx 20034 15,0 + WE WK S Zub	Plaquette de frein Accessoires pour jeux de garnitures Témoin d'usure Code no. de WVA/épaisseur autres no. de WVA voir annexe Dispositif d'avertissement avec témoin d'usure avec vis d'étrier avec accessoires		03.60xx-xxxx.3 → 32nnnn 03.65xx-xxxx.3 → 32nnnn 03.0101-xxxx.2 → 32nnnn 35/3 braun (4)	Correcteur de freinage (BR) Limiteur de freinage (BG) Correcteur à visser (BRE) Correcteur de freinage asservi à la charge (BRL) Jeu de correcteur à visser (BRES) Indice, repère de couleur (nombre de raccords)																	
										▲ 03.24dd-xxxx.3 → 03nnnn 03.0350-ddxx.2 → 07ddxx	Emetteur d'embrayage (p. ex. 03.2419-: Ø=19,05) Jeu de joints														
	▲ 03.25dd-xxxx.3 → 04nnnn 03.0450-ddxx.2 → 08ddxx	Récepteur d'embrayage (e.g. 03.2525-: Ø=25,40) Jeu de joints																							
										24.3728-xxxx.2 → 59xxxx	Câble d'embrayage														
	24.07xx-xxxx.x → 36nnnn	Capteur de roue																							

nnnn = Les quatre derniers chiffres correspondent à un ordre numérique.

dd = Dimension nominale

▲ Le préfixe de ces familles de produit peut également être 03. ou 24.

■ Le préfixe de ces familles de produit peut également être 03., 24. ou 83.

Toute reproduction totale ou partielle de ce catalogue est interdite sauf notre autorisation préalable. Une demande de dommages et intérêts qui se baserait ou aurait pour objet un renseignement donné par le présent catalogue ne saurait être retenue. Nous nous réservons le droit de modifier les spécifications de nos produits sans préavis et, si cela est nécessaire, pour assurer les performances optimales de nos gammes de produits. Les références constructeurs fournies dans le présent catalogue sont données seulement à titre indicatif. L'utilisation de telles informations dans les factures d'un détenteur de véhicule n'est pas admise.

La diversité des modèles et des pièces de rechange ne permet pas toujours une affectation correcte. Par conséquent nous vous prions de bien vouloir tenir compte des observations et des descriptions contenues dans ce catalogue.

Grupo de producto		Modelo	periodo de montaje (desde/hasta)		Referencias ATE		Indicaciones (repuesto)				
Eje delantero-/ trasero	Número de chasis (desde/hasta)	Indicaciones (vehículo)	Referencia corta	Información adicional							
kW											
AUDI A4 CABRIO (02-)											
	1,8 T	◀ 120	8E-55-999999	04.02	PR: 1LB,1LE	11.3571-8522.2	220320	☐ + ESP	D=57, - Halter	ATE	
	1,8 T Quattro	◀ 120		05.03	08.06	PR: 1LB,1LE	11.3571-8521.2	220319		D=57, - Halter	ATE
	2,0	◀ 96		05.04	08.06	PR: 1LB,1LE	11.0441-5704.2	250034	☐ + ESP	Dichtungssatz	ATE
	2,0 TFSI	◀ 120	8E-55-400001		08.06	PR: 1LB,1LE	11.0101-5409.2	260035		Hülsensatz	ATE

*

**

*Grupo de producto

	Servofreno		Tambores de freno
	Cilindro maestro		ATE Original Kit ATE Original TopKit
	Depósito		Zapatas de freno para freno de estacionamiento (mano)
	Pinza de freno		Cable de freno de mano
	Pastillas		Corrector de frenado
	Disco de freno ATE PowerDisc		Cilindro transmisor de embrague
	Tubo flexible de freno		Cilindro receptor de embrague
	Sensor de rueda		Cables de embrague
	Cilindro de rueda		Cable de embrague
	Zapatas de freno		

**Dirección

- ◀ Volante a la izquierda
- ▶ Volante a la derecha

***Fabricante

ATE	Continental Teves (ATE)
AKE	Akebono
AP	AP Lockheed
BDX	Bendix
BOS	Bosch
BRE	Brembo
CIT	Citroën
DEL	Delco
FI	Fiat
FTE	FTE Automotive
LUC	Lucas (TRW)
PER	Perrot
SUM	Sumitomo
TOK	Tokico
VW	Volkswagen

***Posición de montaje























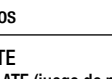



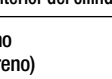









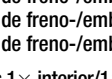

- ☐ adelante
- ☐ atrás
- ☐ izquierda
- ☐ derecha
- ☐ izquierda arriba
- ☐ izquierda abajo
- ☐ derecha arriba
- ☐ derecha abajo
- ☐ medio
- ☐ arriba
- ☐ abajo
- ☐ eje delantero
- ☐ izquierda adelante
- ☐ derecha adelante
- ☐ eje trasero
- ☐ izquierda atrás
- ☐ derecha atrás

Todas las indicaciones de posición se refieren siempre al sentido de la marcha.

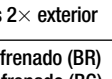
Abreviaturas

-	Sin / no	L=	Largo
+	Con / solo / para	Nz	Cilindro receptor de embrague
AUT	Reajuste automático	PD	PowerDisc
B	Recubierto	Rz	Cilindro de rueda
BG	Limitador de frenado	RzR	Cilindro de rueda con regulador integrado
BR	Corrector de frenado	S	Tornillo para pinza / tornillo quierfija
BRE	Regulador de rosca	THz	Cilindro maestro tandem
BRES	Juego regulador de rosca	V	Ventilado
BRL	Corrector de frenado dependiente de carga	WE	Dispositivo de desgaste
D=	Diámetro	WK	Contactode desgaste
Gz	Cilindro transmisor de embrague	Zub	Accesorios
HEB	Palanca		
HZ	Cilindro maestro		
L	Aleación especial		

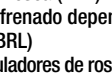
Información artículos

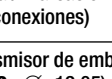
		NUEVA REFER.				NUEVA REFER.										
		03.6199-xxxx.4 → 30nnnn 03.61dy-xxxx.4 → 30nnnn 03.67dy-xxxx.4 → 30nnnn 03.68dy-xxxx.4 → 30nnnn 03.69dy-xxxx.4 → 30nnnn 03.77dy-xxxx.4 → 30nnnn	Refuerzo de la presión de frenada T50 T51 T52/3 T52 T53 T52/4			24.02dd-dxxx.x → 48nnnn 230/231 × 47		Tambores de freno (p. ej. 24.0223-0: Ø=230) Diámetro / diámetro max. x ancho								
									03.78dy-xxxx.4 → 30nnnn 03.78dy-xxxx.4 → 30nnnn 03.78dy-xxxx.4 → 30nnnn 03.78dy-xxxx.4 → 30nnnn 03.78dy-xxxx.4 → 30nnnn 03.78dy-xxxx.4 → 30nnnn	T52/4 T52/4Z T52/5 T52/5Z T55/1 T55/1Z	<table border="1" style="font-size: small;"> <tr> <th>d</th> <th>y</th> </tr> <tr> <td>2 = 6"</td> <td>0 = Simple 5 = Tandem</td> </tr> <tr> <td>3 = 7"</td> <td>0 = Simple 3 = Simple BA</td> </tr> <tr> <td>4 = 8"</td> <td>0 = Simple 5 = Simple 8 = Simple BA</td> </tr> <tr> <td>5 = 9"</td> <td>0 = Simple 5 = Simple 8 = Simple BA</td> </tr> <tr> <td>6 = 10"</td> <td>BA = Asistente de frenado Z = Aparato de freno por tirante</td> </tr> </table>	d	y	2 = 6"	0 = Simple 5 = Tandem	3 = 7"
d	y															
2 = 6"	0 = Simple 5 = Tandem															
3 = 7"	0 = Simple 3 = Simple BA															
4 = 8"	0 = Simple 5 = Simple 8 = Simple BA															
5 = 9"	0 = Simple 5 = Simple 8 = Simple BA															
6 = 10"	BA = Asistente de frenado Z = Aparato de freno por tirante															
03.0137-0xxx.2 → 650xxx 03.0137-9xxx.2 → 669xxx	Zapatas de freno Accesorios para zapatas de freno															
			▲ 03.20dd-xxxx.3 → 01nnnn ▲ 03.21dd-xxxx.3 → 01nnnn ▲ 03.23dd-xxxx.3 → 01nnnn ▲ 03.31dd-xxxx.3 → 01nnnn 03.0370-xxdd.2 → 05xxdd	Cilindro maestro escalonado tandem Cilindro maestro tandem Cilindro escalonado maestro Cilindro maestro (p. ej. 03.2122-: Ø=22,20) Juego de reparación		03.0420-xxdd.3 → 68xxdd 03.0520-xxdd.3 → 69xxdd		Kit original ATE TopKit original ATE (juego de piezas de freno) (Cilindros de rueda + zapatas de freno + juego de montaje) dd = medida interior del cilindro de rueda								
	03.3508-xxxx.x → 31nnnn 03.3509-xxxx.x → 31nnnn 03.3558-xxxx.x → 31nnnn 03.0101-xxxx.2 → 39nnnn								Depósito Depósito Depósito Juego de reparación			03.0137-0xxx.2 → 650xxx 03.0137-9xxx.2 → 669xxx		Freno de mano (zapatas de freno) Juego de montaje		
			▲ 11.3ddx-xxxx.2 → 22nnnn 11.9ddx-xxxx.2 → 22nnnn ▲ 13.2ddx-xxxx.2 → 21nnnn ▲ 13.4ddx-xxxx.2 → 21nnnn 13.9ddx-xxxx.2 → 21nnnn 24.3ddx-xxxx.5 → 24nnnn 11.0441-ddxx.2 → 25nnnn 13.0441-ddxx.2 → 25nnnn 11.0230-xxxx.2 → 26nnnn 24.0101-xxxx.2 → 26nnnn ▲ 11.0101-xxxx.2 → 26nnnn 11.8116-xxxx.1 → 39nnnn	Pinza de puño Pinza de puño Pinza fija 2-cilindros Pinza fija 4-cilindros Pinza fija Pinza de puño refabricada Juego de reparación de juntas Juego de reparación de juntas Juego de soportes de pinza de puño (soporte, juego de casquillos corredizos, perno de guía) Accesorios para pinza de freno (juego de casquillos corredizos, perno de guía) Juego casquillos corredizos Muelle de sujeción			185 × 31 AUT HEB Zub								Diámetro x ancho con reajuste automático con palanca con accesorios	
	13.0460-xxxx.2 → 60xxxx 13.0460-0xxx.2 → 610xxx 24.8190-xxxx.2 → 62xxxx 20034 15,0 + WE WK S Zub								Pastilla de freno Accesorios para juego de pastillas Contacto de desgaste No. WVA/espesor para otros números WVA, véase suplemento Dispositivo de desgaste con contacto de desgaste con tornillo para pinza con accesorios			24.3727-xxxx.2 → 58xxxx		Cable de freno mano		
			▲ 83.5yxx-LLLL.3 → 33nnnn ▲ 83.6yxx-LLLL.3 → 33nnnn ▲ 83.7yxx-LLLL.3 → 33nnnn y = 1: Roscas 1 × interior / 1 × exterior y = 2: Roscas 2 × interior y = 3: Roscas 2 × exterior	Tubo flexible de freno-/embrague Tubo flexible de freno-/embrague Tubo flexible de freno-/embrague			03.60xx-xxxx.3 → 32nnnn 03.65xx-xxxx.3 → 32nnnn 03.0101-xxxx.2 → 32nnnn 35/3 marrón (4)								Corrector de frenado (BR) Limitador de frenado (BG) Regulador de rosca (BRE) Corrector de frenado dependiente de la carga (BRL) Juego de reguladores de rosca (BRES) Característica / marcación de color (número de conexiones)	
	▲ 03.24dd-xxxx.3 → 03nnnn 03.0350-ddxx.2 → 07ddxx								Cilindro transmisor de embrague (p.ej. 03.2419-: Ø=19,05) Juego de reparación de juntas			▲ 03.25dd-xxxx.3 → 04nnnn 03.0450-ddxx.2 → 08ddxx		Cilindro receptor de embrague (e.ej. 03.2525-: Ø=25,40) Juego de reparación de juntas		
			24.01dd-xxxx.x → 4dxxxx 24.03dd-xxxx.x → 5dxxxx	Disco de freno ATE PowerDisc dd = espesor (p.ex. 24.0322 : espesor = 22)			24.3728-xxxx.2 → 59xxxx								Cable de embrague	
284 22 20 V L PD B V L S PD	Diámetro / espesor / grosor mínimo Recubierta ventilado aleación especial Tornillo para pinza ATE PowerDisc										24.07xx-xxxx.x → 36nnnn		Sensor de rueda			

nnnn = Las cuatro últimas cifras son números correlativos.

dd = Medida nominal

▲ También posible el 24. en caso del mismo sistema de numeración.

■ También posible el 03. y 24. en caso del mismo sistema de numeración de numeración.

Sólo se permite la reproducción total o parcial con nuestra autorización. No se atenderán reclamaciones motivadas por los datos contenidos en este catálogo. Quedan reservados los derechos de modificaciones en la construcción. Si en nuestros documentos hacemos referencia a números de piezas de recambio de los constructores de vehículos, esto únicamente es para establecer una comparación. No está permitido el uso de datos de este tipo en las facturas emitidas al propietario del vehículo.

La variedad de modelos y de piezas de recambio de algunos constructores de vehículos no permite siempre una distribución exacta. Por este motivo, por favor fíjese atentamente en las observaciones y descripciones de las piezas de recambio detalladas en el catálogo.

ATE Classic Anfrage



Datum : *

Continental Aftermarket GmbH
 Guerickestraße 7
 60488 Frankfurt a. M.

www.ate-classic.de

Kontaktdaten :

Firma :

Name : *

Vorname :

Straße und Nr : *

PLZ : *

Ort : *

Land : *

E-Mail :

Telefon : *

Telefax :

Fahrzeugdaten :

Marke - Modell :

Typ :

Hubraum cc :

Kraftstoff :

Baujahr :

Leistung : PS KW

KBA Zu 2 : Zu 3 :

Lenkungsseite :

Produktdaten:

	Artikel 1	Artikel 2	Artikel 3	Artikel 4
Produktbezeichnung : *				
ATE-Nummer :				
sonstige Referenz Nr.:				
Einbauseite :				
Einbauposition :				
Menge : *				
Bemerkung :				

Ihre Nachricht an uns:

* Pflichtfelder
 Um Rückfragen zu vermeiden, füllen Sie bitte möglichst alle Felder aus.



ATE Classic Request



Date : *

Continental Aftermarket GmbH
Guerickestraße 7
60488 Frankfurt a. M.
Germany

www.ate-classic.de

Contact data :

Company :

Surname : *

First name :

Street and No. : *

Post (Zip) Code : *

City : *

Country : *

E-Mail :

Telephone : *

Telefax :

Vehicle data :

Make - Model :

Type :

Engine displ. cc :

Fuel :

Year :

Performance HP KW

Steering side :

Product data:

	Article 1	Article 2	Article 3	Article 4
Productname : *				
ATE-Number :				
Other reference No.				
Install. Pos. left- right :				
Install. Pos. front-rear :				
Quantity : *				
Comment :				

Your message to us :

* Mandatory fields
To avoid callbacks, please fill all possible fields.

ATE – A Trademark of the
Continental Corporation

Continental Aftermarket GmbH

Guerickestraße 7
D-60488 Frankfurt am Main
Tel. +49 (0) 69 7603-1
Fax +49 (0) 69 761061

www.ate.de

**Continental Automotive Trading
Italia S.r.l.**

Divisione ATE
Via Matteotti, 62
I-20092 Cinisello Balsamo (MI)
Tel. +39 02 35680 1
Fax +39 02 35680 325
E-Mail: [info.consumatori@
continental-corporation.com](mailto:info.consumatori@continental-corporation.com)

www.ate-freni.it

Continental AutomotiveFrance SAS

Parc Ariane Bâtiment Vénus
Rue Hélène Boucher
F-78280 Guyancourt
Tél. +33 (0)1 39 44 10 30
Fax +33 (0)1 39 44 10 40
E-Mail: [07GYFMAte-technique@
continental-corporation.com](mailto:07GYFMAte-technique@continental-corporation.com)

www.ate-freinage.fr

Continental Automotive Spain, S.A.

C/ Sepúlveda, 11
E-28108 Alcobendas (Madrid)
Phone +34 (0) 657 21 21
Fax +34 (0)91 657 21 49

www.frenos-ate.es

