

Nouvelles références disponibles
par applications



02/2012



www.ate.de









					description	Références OE par référence ATE.		Références remplacées / divers
--	--	--	--	--	-------------	----------------------------------	--	--------------------------------

AUDI

100 (91-94)	2,6	AvG	04.1992	07.1994	24.3571-8507.5	240555	ETRIER A GRIFFE	4A0 615 123 A	
	2,8	AvG	12.1990	07.1994	24.3571-8507.5	240555	ETRIER A GRIFFE	4A0 615 123 A	
100 Quattro (91-94)	2,6	AvG	03.1992	07.1994	24.3571-8507.5	240555	ETRIER A GRIFFE	4A0 615 123 A	
	2,8	AvG	12.1990	07.1994	24.3571-8507.5	240555	ETRIER A GRIFFE	4A0 615 123 A	
A3 / A3 Sportback (03-)	1,2 TSI		04.2010		83.7849-0502.3	331125	FLEXIBLE FREIN	1K0 611 701 N , 1K0 611 701 L , 1K0 611 701 A , 1Q0 611 701 E , 1K0 611 701 C , 1K0 611 701 J	83.7849-0504.3
	1,4 TFSI		07.2007		83.7849-0502.3	331125	FLEXIBLE FREIN	1K0 611 701 N , 1K0 611 701 L , 1K0 611 701 A , 1Q0 611 701 E , 1K0 611 701 C , 1K0 611 701 J	83.7849-0504.3
	1,6		05.2003		83.7849-0502.3	331125	FLEXIBLE FREIN	1K0 611 701 N , 1K0 611 701 L , 1K0 611 701 A , 1Q0 611 701 E , 1K0 611 701 C , 1K0 611 701 J	83.7849-0504.3
	1,6 FSI		08.2003		83.7849-0502.3	331125	FLEXIBLE FREIN	1K0 611 701 N , 1K0 611 701 L , 1K0 611 701 A , 1Q0 611 701 E , 1K0 611 701 C , 1K0 611 701 J	83.7849-0504.3
	1,6 TDI		05.2009		83.7849-0502.3	331125	FLEXIBLE FREIN	1K0 611 701 N , 1K0 611 701 L , 1K0 611 701 A , 1Q0 611 701 E , 1K0 611 701 C , 1K0 611 701 J	83.7849-0504.3
	1,8 TFSI		01.2007		83.7849-0502.3	331125	FLEXIBLE FREIN	1K0 611 701 N , 1K0 611 701 L , 1K0 611 701 A , 1Q0 611 701 E , 1K0 611 701 C , 1K0 611 701 J	83.7849-0504.3



		 		<p>description</p>	<p>Références OE par référence ATE.</p>	 <p>Références remplacées / divers</p>
---	---	---	---	--------------------	---	---

AUDI

A3 / A3 Sportback (03-)	1,9 TDI		06.2003		83.7849-0502.3	331125	FLEXIBLE FREIN	1K0 611 701 N, 1K0 611 701 L, 1K0 611 701 A, 1Q0 611 701 E, 1K0 611 701 C, 1K0 611 701 J	83.7849-0504.3
	2,0 FSI		05.2003		83.7849-0502.3	331125	FLEXIBLE FREIN	1K0 611 701 N, 1K0 611 701 L, 1K0 611 701 A, 1Q0 611 701 E, 1K0 611 701 C, 1K0 611 701 J	83.7849-0504.3
	2,0 TDI		06.2006		83.7849-0502.3	331125	FLEXIBLE FREIN	1K0 611 701 N, 1K0 611 701 L, 1K0 611 701 A, 1Q0 611 701 E, 1K0 611 701 C, 1K0 611 701 J	83.7849-0504.3
			05.2003		83.7849-0502.3	331125	FLEXIBLE FREIN	1K0 611 701 N, 1K0 611 701 L, 1K0 611 701 A, 1Q0 611 701 E, 1K0 611 701 C, 1K0 611 701 J	83.7849-0504.3
			03.2006		83.7849-0502.3	331125	FLEXIBLE FREIN	1K0 611 701 N, 1K0 611 701 L, 1K0 611 701 A, 1Q0 611 701 E, 1K0 611 701 C, 1K0 611 701 J	83.7849-0504.3
	2,0 TDI quattro		05.2003		83.7849-0502.3	331125	FLEXIBLE FREIN	1K0 611 701 N, 1K0 611 701 L, 1K0 611 701 A, 1Q0 611 701 E, 1K0 611 701 C, 1K0 611 701 J	83.7849-0504.3
			08.2004		83.7849-0502.3	331125	FLEXIBLE FREIN	1K0 611 701 N, 1K0 611 701 L, 1K0 611 701 A, 1Q0 611 701 E, 1K0 611 701 C, 1K0 611 701 J	83.7849-0504.3
			03.2006		83.7849-0502.3	331125	FLEXIBLE FREIN	1K0 611 701 N, 1K0 611 701 L, 1K0 611 701 A, 1Q0 611 701 E, 1K0 611 701 C, 1K0 611 701 J	83.7849-0504.3



					description	Références OE par référence ATE.		Références remplacées / divers
--	--	--	--	--	-------------	----------------------------------	--	--------------------------------

AUDI

A3 / A3 Sportback (03-)	2,0 TFSI		06.2004		83.7849-0502.3	331125	FLEXIBLE FREIN	1K0 611 701 N , 1K0 611 701 L , 1K0 611 701 A , 1Q0 611 701 E , 1K0 611 701 C , 1K0 611 701 J	83.7849-0504.3
	2,0 TFSI quattro		06.2004		83.7849-0502.3	331125	FLEXIBLE FREIN	1K0 611 701 N , 1K0 611 701 L , 1K0 611 701 A , 1Q0 611 701 E , 1K0 611 701 C , 1K0 611 701 J	83.7849-0504.3
	3,2 quattro		07.2003		83.7849-0502.3	331125	FLEXIBLE FREIN	1K0 611 701 N , 1K0 611 701 L , 1K0 611 701 A , 1Q0 611 701 E , 1K0 611 701 C , 1K0 611 701 J	83.7849-0504.3
	S3 quattro		11.2006		83.7849-0502.3	331125	FLEXIBLE FREIN	1K0 611 701 N , 1K0 611 701 L , 1K0 611 701 A , 1Q0 611 701 E , 1K0 611 701 C , 1K0 611 701 J	83.7849-0504.3
			07.2008		83.7849-0502.3	331125	FLEXIBLE FREIN	1K0 611 701 N , 1K0 611 701 L , 1K0 611 701 A , 1Q0 611 701 E , 1K0 611 701 C , 1K0 611 701 J	83.7849-0504.3
A6 / A6 Avant (4A/C4) (94-97)	2,5 TDI	AvG	10.1994	12.1997	24.3571-8507.5	240555	ETRIER A GRIFFE	4A0 615 123 A	
	2,5 TDI Quattro	AvG	07.1995	12.1997	24.3571-8507.5	240555	ETRIER A GRIFFE	4A0 615 123 A	
	2,6	AvG	06.1994	12.1997	24.3571-8507.5	240555	ETRIER A GRIFFE	4A0 615 123 A	
	2,6 Quattro	AvG	06.1994	12.1997	24.3571-8507.5	240555	ETRIER A GRIFFE	4A0 615 123 A	
	2,8	AvG	10.1995	12.1997	24.3571-8507.5	240555	ETRIER A GRIFFE	4A0 615 123 A	
		AvG	06.1994	12.1997	24.3571-8507.5	240555	ETRIER A GRIFFE	4A0 615 123 A	
	2,8 Quattro	AvG	06.1994	12.1997	24.3571-8507.5	240555	ETRIER A GRIFFE	4A0 615 123 A	
Q3 (11-)	2,0 TDI	AvD	06.2011		11.9571-9760.2	220848	ETRIER A GRIFFE	5N0 615 124	



					description	Références OE par référence ATE.		Références remplacées / divers
--	--	--	--	--	-------------	----------------------------------	--	--------------------------------







AUDI

Q3 (11-)	2,0 TDI quattro	AvD	06.2011		11.9571-9760.2	220848	ETRIER A GRIFFE	5N0 615 124	
	2,0 TFSI quattro	AvD	06.2011		11.9571-9760.2	220848	ETRIER A GRIFFE	5N0 615 124	
Q7 (06-)	3,0 TDI		05.2010		03.7868-4503.4	300245	BREMSGERAET T55	7L8 612 105 D , 7L8 612 105	
			05.2011		03.7868-4503.4	300245	BREMSGERAET T55	7L8 612 105 D , 7L8 612 105	
			11.2007		03.7868-4503.4	300245	BREMSGERAET T55	7L8 612 105 D , 7L8 612 105	
			03.2006		03.7868-4503.4	300245	BREMSGERAET T55	7L8 612 105 D , 7L8 612 105	
			06.2009	05.2010	03.7868-4503.4	300245	BREMSGERAET T55	7L8 612 105 D , 7L8 612 105	
	3,0 TFSI		05.2010		03.7868-4503.4	300245	BREMSGERAET T55	7L8 612 105 D , 7L8 612 105	
	3,6 FSI		08.2006		03.7868-4503.4	300245	BREMSGERAET T55	7L8 612 105 D , 7L8 612 105	
	4,2 FSI		03.2006		03.7868-4503.4	300245	BREMSGERAET T55	7L8 612 105 D , 7L8 612 105	
	4,2 TDI		03.2007		03.7868-4503.4	300245	BREMSGERAET T55	7L8 612 105 D , 7L8 612 105	
	6,0 TDI		09.2008		03.7868-4503.4	300245	BREMSGERAET T55	7L8 612 105 D , 7L8 612 105	

Nouvelles références disponibles - par applications

02/2012



					description	Références OE par référence ATE.	 Références remplacées / divers
---	---	---	---	---	--------------------	---	--







BMW

Série 3/E36 (91-00)	316 i Touring		05.1997	10.1999	11.0230-0233.2	260093	JEU SUPPORTS	34 11 1 162 413 , 34 11 1 160 350 , 34 11 1 163 701 , 34 10 6 758 104	
	318 i		12.1990	02.1998	11.0230-0233.2	260093	JEU SUPPORTS	34 11 1 162 413 , 34 11 1 160 350 , 34 11 1 163 701 , 34 10 6 758 104	
	318 i Touring		02.1995	10.1999	11.0230-0233.2	260093	JEU SUPPORTS	34 11 1 162 413 , 34 11 1 160 350 , 34 11 1 163 701 , 34 10 6 758 104	
	318 iS		01.1992	02.1998	11.0230-0233.2	260093	JEU SUPPORTS	34 11 1 162 413 , 34 11 1 160 350 , 34 11 1 163 701 , 34 10 6 758 104	
	318 iS Coupe		01.1992	04.1999	11.0230-0233.2	260093	JEU SUPPORTS	34 11 1 162 413 , 34 11 1 160 350 , 34 11 1 163 701 , 34 10 6 758 104	
	318 tds		01.1994	02.1998	11.0230-0233.2	260093	JEU SUPPORTS	34 11 1 162 413 , 34 11 1 160 350 , 34 11 1 163 701 , 34 10 6 758 104	
	318 ti Compact		04.1998	08.2000	11.0230-0233.2	260093	JEU SUPPORTS	34 11 1 162 413 , 34 11 1 160 350 , 34 11 1 163 701 , 34 10 6 758 104	
	320 i		12.1990	02.1998	11.0230-0233.2	260093	JEU SUPPORTS	34 11 1 162 413 , 34 11 1 160 350 , 34 11 1 163 701 , 34 10 6 758 104	
	320 i Cabrio		11.1993	04.1999	11.0230-0233.2	260093	JEU SUPPORTS	34 11 1 162 413 , 34 11 1 160 350 , 34 11 1 163 701 , 34 10 6 758 104	
	320 i Coupe		01.1992	04.1999	11.0230-0233.2	260093	JEU SUPPORTS	34 11 1 162 413 , 34 11 1 160 350 , 34 11 1 163 701 , 34 10 6 758 104	

Nouvelles références disponibles - par applications

02/2012



					description	Références OE par référence ATE.	 Références remplacées / divers
---	---	---	---	---	--------------------	---	--

BMW

Série 3/E36 (91-00)	320 i Touring		05.1994	10.1999	11.0230-0233.2	260093	JEU SUPPORTS	34 11 1 162 413 , 34 11 1 160 350 , 34 11 1 163 701 , 34 10 6 758 104	
	323 i		03.1995	02.1998	11.0230-0233.2	260093	JEU SUPPORTS	34 11 1 162 413 , 34 11 1 160 350 , 34 11 1 163 701 , 34 10 6 758 104	
	323 i Cabrio		03.1995	04.1999	11.0230-0233.2	260093	JEU SUPPORTS	34 11 1 162 413 , 34 11 1 160 350 , 34 11 1 163 701 , 34 10 6 758 104	
	323 i Coupe		03.1995	04.1999	11.0230-0233.2	260093	JEU SUPPORTS	34 11 1 162 413 , 34 11 1 160 350 , 34 11 1 163 701 , 34 10 6 758 104	
	323 i Touring		07.1995	10.1999	11.0230-0233.2	260093	JEU SUPPORTS	34 11 1 162 413 , 34 11 1 160 350 , 34 11 1 163 701 , 34 10 6 758 104	
	323 ti Compact		08.1997	08.2000	11.0230-0233.2	260093	JEU SUPPORTS	34 11 1 162 413 , 34 11 1 160 350 , 34 11 1 163 701 , 34 10 6 758 104	
	325 i		12.1990	02.1998	11.0230-0233.2	260093	JEU SUPPORTS	34 11 1 162 413 , 34 11 1 160 350 , 34 11 1 163 701 , 34 10 6 758 104	
	325 i Cabrio		08.1992	03.1995	11.0230-0233.2	260093	JEU SUPPORTS	34 11 1 162 413 , 34 11 1 160 350 , 34 11 1 163 701 , 34 10 6 758 104	
	325 i Coupe		01.1992	04.1999	11.0230-0233.2	260093	JEU SUPPORTS	34 11 1 162 413 , 34 11 1 160 350 , 34 11 1 163 701 , 34 10 6 758 104	
	325 td		09.1991	02.1998	11.0230-0233.2	260093	JEU SUPPORTS	34 11 1 162 413 , 34 11 1 160 350 , 34 11 1 163 701 , 34 10 6 758 104	

Nouvelles références disponibles - par applications

02/2012



					description	Références OE par référence ATE.		Références remplacées / divers
--	--	--	--	--	-------------	-------------------------------------	--	-----------------------------------







BMW

Série 3/E36 (91-00)	325 tds		03.1993	02.1998	11.0230-0233.2	260093	JEU SUPPORTS	34 11 1 162 413 , 34 11 1 160 350 , 34 11 1 163 701 , 34 10 6 758 104
	325 tds Touring		10.1994	10.1999	11.0230-0233.2	260093	JEU SUPPORTS	34 11 1 162 413 , 34 11 1 160 350 , 34 11 1 163 701 , 34 10 6 758 104
	328 i		11.1994	02.1998	11.0230-0233.2	260093	JEU SUPPORTS	34 11 1 162 413 , 34 11 1 160 350 , 34 11 1 163 701 , 34 10 6 758 104
	328 i Cabrio		11.1994	04.1999	11.0230-0233.2	260093	JEU SUPPORTS	34 11 1 162 413 , 34 11 1 160 350 , 34 11 1 163 701 , 34 10 6 758 104
	328 i Coupe		11.1994	04.1999	11.0230-0233.2	260093	JEU SUPPORTS	34 11 1 162 413 , 34 11 1 160 350 , 34 11 1 163 701 , 34 10 6 758 104
	328 i Touring		10.1994	10.1999	11.0230-0233.2	260093	JEU SUPPORTS	34 11 1 162 413 , 34 11 1 160 350 , 34 11 1 163 701 , 34 10 6 758 104
Série 3/E46 (98-06)	316 i		12.1998	02.2005	11.0230-0233.2	260093	JEU SUPPORTS	34 11 1 162 413 , 34 11 1 160 350 , 34 11 1 163 701 , 34 10 6 758 104
	316 i 1,9		12.1998	02.2005	11.0230-0233.2	260093	JEU SUPPORTS	34 11 1 162 413 , 34 11 1 160 350 , 34 11 1 163 701 , 34 10 6 758 104
	316 i Coupe		04.2000	08.2006	11.0230-0233.2	260093	JEU SUPPORTS	34 11 1 162 413 , 34 11 1 160 350 , 34 11 1 163 701 , 34 10 6 758 104
	316 i Touring		03.2002	07.2005	11.0230-0233.2	260093	JEU SUPPORTS	34 11 1 162 413 , 34 11 1 160 350 , 34 11 1 163 701 , 34 10 6 758 104

Nouvelles références disponibles - par applications

02/2012



					description	Références OE par référence ATE.	 Références remplacées / divers
---	---	---	---	---	--------------------	---	--







BMW

Série 3/E46 (98-06)	316 ti Compact		07.2001	02.2005	11.0230-0233.2	260093	JEU SUPPORTS	34 11 1 162 413 , 34 11 1 160 350 , 34 11 1 163 701 , 34 10 6 758 104	
	318 Ci Cabrio		02.2005	12.2006	11.0230-0233.2	260093	JEU SUPPORTS	34 11 1 162 413 , 34 11 1 160 350 , 34 11 1 163 701 , 34 10 6 758 104	
			09.2001	12.2006	11.0230-0233.2	260093	JEU SUPPORTS	34 11 1 162 413 , 34 11 1 160 350 , 34 11 1 163 701 , 34 10 6 758 104	
	318 d		09.2001	02.2005	11.0230-0233.2	260093	JEU SUPPORTS	34 11 1 162 413 , 34 11 1 160 350 , 34 11 1 163 701 , 34 10 6 758 104	
	318 d Touring		03.2002	07.2005	11.0230-0233.2	260093	JEU SUPPORTS	34 11 1 162 413 , 34 11 1 160 350 , 34 11 1 163 701 , 34 10 6 758 104	
	318 i		04.1998	02.2005	11.0230-0233.2	260093	JEU SUPPORTS	34 11 1 162 413 , 34 11 1 160 350 , 34 11 1 163 701 , 34 10 6 758 104	
	318 i Coupe		08.1999	08.2006	11.0230-0233.2	260093	JEU SUPPORTS	34 11 1 162 413 , 34 11 1 160 350 , 34 11 1 163 701 , 34 10 6 758 104	
	318 i Touring		10.1999	07.2005	11.0230-0233.2	260093	JEU SUPPORTS	34 11 1 162 413 , 34 11 1 160 350 , 34 11 1 163 701 , 34 10 6 758 104	
	318 td Compact		03.2003	02.2005	11.0230-0233.2	260093	JEU SUPPORTS	34 11 1 162 413 , 34 11 1 160 350 , 34 11 1 163 701 , 34 10 6 758 104	
	318 ti Compact		09.2001	02.2005	11.0230-0233.2	260093	JEU SUPPORTS	34 11 1 162 413 , 34 11 1 160 350 , 34 11 1 163 701 , 34 10 6 758 104	

Nouvelles références disponibles - par applications

02/2012



					description	Références OE par référence ATE.	 Références remplacées / divers
---	---	---	---	---	-------------	-------------------------------------	--

BMW

Série 3/E46 (98-06)	320 Ci Coupe		06.1999	08.2006	11.0230-0233.2	260093	JEU SUPPORTS	34 11 1 162 413 , 34 11 1 160 350 , 34 11 1 163 701 , 34 10 6 758 104	
	320 d		04.1998	08.2001	11.0230-0233.2	260093	JEU SUPPORTS	34 11 1 162 413 , 34 11 1 160 350 , 34 11 1 163 701 , 34 10 6 758 104	
	320 d Touring		03.2000	07.2005	11.0230-0233.2	260093	JEU SUPPORTS	34 11 1 162 413 , 34 11 1 160 350 , 34 11 1 163 701 , 34 10 6 758 104	
	320 i		04.1998	02.2005	11.0230-0233.2	260093	JEU SUPPORTS	34 11 1 162 413 , 34 11 1 160 350 , 34 11 1 163 701 , 34 10 6 758 104	
	320 i Touring		10.1999	07.2005	11.0230-0233.2	260093	JEU SUPPORTS	34 11 1 162 413 , 34 11 1 160 350 , 34 11 1 163 701 , 34 10 6 758 104	
	323 Ci Cabrio		05.2000	08.2000	11.0230-0233.2	260093	JEU SUPPORTS	34 11 1 162 413 , 34 11 1 160 350 , 34 11 1 163 701 , 34 10 6 758 104	
	323 Ci Coupe		04.1999	08.2000	11.0230-0233.2	260093	JEU SUPPORTS	34 11 1 162 413 , 34 11 1 160 350 , 34 11 1 163 701 , 34 10 6 758 104	
	323 i		04.1998	08.2000	11.0230-0233.2	260093	JEU SUPPORTS	34 11 1 162 413 , 34 11 1 160 350 , 34 11 1 163 701 , 34 10 6 758 104	
	M3 Cabrio	ArG	05.2001	12.2006	11.9421-9953.2	220837	ETRIER A GRIFFE	34 21 2 282 195	
	M3 Coupe	ArG	06.2000	08.2006	11.9421-9953.2	220837	ETRIER A GRIFFE	34 21 2 282 195	
	M3 CSL Coupe	ArG	05.2003	08.2006	11.9421-9953.2	220837	ETRIER A GRIFFE	34 21 2 282 195	
Série 5/E34 (88-96)	518 i Touring	ArD	11.1992	11.1996	24.3401-8504.5	240522	ETRIER A GRIFFE	34 21 1 160 928	

Nouvelles références disponibles - par applications

02/2012



					description	Références OE par référence ATE.		Références remplacées / divers
--	--	--	--	--	-------------	----------------------------------	--	--------------------------------

BMW

Série 5/E34 (88-96)	518 i Touring	ArG	11.1992	11.1996	24.3401-8503.5	240521	ETRIER A GRIFFE	34 21 1 160 927	
	520 i Touring	ArD	11.1991	11.1996	24.3401-8504.5	240522	ETRIER A GRIFFE	34 21 1 160 928	
		ArG	11.1991	11.1996	24.3401-8503.5	240521	ETRIER A GRIFFE	34 21 1 160 927	
	525 i Touring	ArD	11.1991	11.1996	24.3401-8504.5	240522	ETRIER A GRIFFE	34 21 1 160 928	
		ArG	11.1991	11.1996	24.3401-8503.5	240521	ETRIER A GRIFFE	34 21 1 160 927	
	525 ix Touring	ArD	02.1992	11.1996	24.3401-8504.5	240522	ETRIER A GRIFFE	34 21 1 160 928	
		ArG	02.1992	11.1996	24.3401-8503.5	240521	ETRIER A GRIFFE	34 21 1 160 927	
	525 td Touring	ArD	03.1993	11.1996	24.3401-8504.5	240522	ETRIER A GRIFFE	34 21 1 160 928	
		ArG	03.1993	11.1996	24.3401-8503.5	240521	ETRIER A GRIFFE	34 21 1 160 927	
	525 tds Touring	ArD	12.1991	11.1996	24.3401-8504.5	240522	ETRIER A GRIFFE	34 21 1 160 928	
		ArG	12.1991	11.1996	24.3401-8503.5	240521	ETRIER A GRIFFE	34 21 1 160 927	
	530 i V8 Touring	ArD	05.1992	11.1996	24.3401-8504.5	240522	ETRIER A GRIFFE	34 21 1 160 928	
		ArG	05.1992	11.1996	24.3401-8503.5	240521	ETRIER A GRIFFE	34 21 1 160 927	
Série 7/E38 (93-01)	725 tds	ArD	05.1996	11.2001	24.3401-9978.5	240524	ETRIER A GRIFFE	34 21 1 164 580 , 34 21 1 163 322	
		ArG	05.1996	11.2001	24.3401-9977.5	240523	ETRIER A GRIFFE	34 21 1 164 579 , 34 21 1 163 321	
	728 i	ArD	07.1995	11.2001	24.3401-9978.5	240524	ETRIER A GRIFFE	34 21 1 164 580 , 34 21 1 163 322	
		ArG	07.1995	11.2001	24.3401-9977.5	240523	ETRIER A GRIFFE	34 21 1 164 579 , 34 21 1 163 321	



					description	Références OE par référence ATE.		Références remplacées / divers
--	--	--	--	--	-------------	----------------------------------	--	--------------------------------

BMW

Série 7/E38 (93-01)		ArD	01.1996	11.2001	24.3401-9978.5	240524	ETRIER A GRIFFE	34 21 1 164 580 , 34 21 1 163 322	
	728 iL	ArG	01.1996	11.2001	24.3401-9977.5	240523	ETRIER A GRIFFE	34 21 1 164 579 , 34 21 1 163 321	
	730 d	ArD	09.1998	11.2001	24.3401-9978.5	240524	ETRIER A GRIFFE	34 21 1 164 580 , 34 21 1 163 322	
		ArG	09.1998	11.2001	24.3401-9977.5	240523	ETRIER A GRIFFE	34 21 1 164 579 , 34 21 1 163 321	
	730 i	ArG	07.1993	11.2001	24.3401-9977.5	240523	ETRIER A GRIFFE	34 21 1 164 579 , 34 21 1 163 321	
		ArD	07.1993	11.2001	24.3401-9978.5	240524	ETRIER A GRIFFE	34 21 1 164 580 , 34 21 1 163 322	
	730 iL	ArG	05.1994	11.2001	24.3401-9977.5	240523	ETRIER A GRIFFE	34 21 1 164 579 , 34 21 1 163 321	
		ArD	05.1994	11.2001	24.3401-9978.5	240524	ETRIER A GRIFFE	34 21 1 164 580 , 34 21 1 163 322	
	735 i	ArG	01.1996	11.2001	24.3401-9977.5	240523	ETRIER A GRIFFE	34 21 1 164 579 , 34 21 1 163 321	
		ArD	01.1996	11.2001	24.3401-9978.5	240524	ETRIER A GRIFFE	34 21 1 164 580 , 34 21 1 163 322	
	735 iL	ArG	01.1996	11.2001	24.3401-9977.5	240523	ETRIER A GRIFFE	34 21 1 164 579 , 34 21 1 163 321	
		ArD	01.1996	11.2001	24.3401-9978.5	240524	ETRIER A GRIFFE	34 21 1 164 580 , 34 21 1 163 322	
	740 i	ArG	09.1996	11.2001	24.3401-9977.5	240523	ETRIER A GRIFFE	34 21 1 164 579 , 34 21 1 163 321	

Nouvelles références disponibles - par applications

02/2012







					description	Références OE par référence ATE.		Références remplacées / divers
--	--	--	--	--	-------------	----------------------------------	--	--------------------------------

BMW

Série 7/E38 (93-01)	740 i	ArD	09.1996	11.2001	24.3401-9978.5	240524	ETRIER A GRIFFE	34 21 1 164 580 , 34 21 1 163 322	
	740 iL	ArG	09.1996	11.2001	24.3401-9977.5	240523	ETRIER A GRIFFE	34 21 1 164 579 , 34 21 1 163 321	
		ArD	09.1996	11.2001	24.3401-9978.5	240524	ETRIER A GRIFFE	34 21 1 164 580 , 34 21 1 163 322	
Z3 (95-02)	2		04.1999	08.2000	11.0230-0233.2	260093	JEU SUPPORTS	34 11 1 162 413 , 34 11 1 160 350 , 34 11 1 163 701 , 34 10 6 758 104	
	2,2		10.2000	12.2002	11.0230-0233.2	260093	JEU SUPPORTS	34 11 1 162 413 , 34 11 1 160 350 , 34 11 1 163 701 , 34 10 6 758 104	
	2,8 Coupe		07.1997	06.2000	11.0230-0233.2	260093	JEU SUPPORTS	34 11 1 162 413 , 34 11 1 160 350 , 34 11 1 163 701 , 34 10 6 758 104	
	2,8 Roadster		05.1997	06.2000	11.0230-0233.2	260093	JEU SUPPORTS	34 11 1 162 413 , 34 11 1 160 350 , 34 11 1 163 701 , 34 10 6 758 104	
Z4 Roadster/E85 (03-08)	2,0 i		04.2005	12.2008	11.0230-0233.2	260093	JEU SUPPORTS	34 11 1 162 413 , 34 11 1 160 350 , 34 11 1 163 701 , 34 10 6 758 104	
	2,2 i		10.2003	12.2008	11.0230-0233.2	260093	JEU SUPPORTS	34 11 1 162 413 , 34 11 1 160 350 , 34 11 1 163 701 , 34 10 6 758 104	
	2,5 i		01.2006	12.2008	11.0230-0233.2	260093	JEU SUPPORTS	34 11 1 162 413 , 34 11 1 160 350 , 34 11 1 163 701 , 34 10 6 758 104	
			12.2002	12.2008	11.0230-0233.2	260093	JEU SUPPORTS	34 11 1 162 413 , 34 11 1 160 350 , 34 11 1 163 701 , 34 10 6 758 104	



				<p>description</p>	<p>Références OE par référence ATE.</p>	 <p>Références remplacées / divers</p>
---	---	--	---	--------------------	---	---







BMW

Z4 Roadster/E85 (03-08)	2,5 si		01.2006	12.2008	11.0230-0233.2	260093	JEU SUPPORTS	34 11 1 162 413 , 34 11 1 160 350 , 34 11 1 163 701 , 34 10 6 758 104	
-------------------------	--------	--	---------	---------	----------------	--------	--------------	---	--

Nouvelles références disponibles - par applications

02/2012



					description	Références OE par référence ATE.	 Références remplacées / divers
---	---	---	---	---	--------------------	---	--

CITROEN

C1 (05-)	1	AvG	06.2005		24.5295-0496.3	331033	FLEXIBLE FREIN	4806 E2 , 90947-W2003	
	1,4 HDi	AvG	06.2005	12.2008	24.5295-0496.3	331033	FLEXIBLE FREIN	4806 E2 , 90947-W2003	
C5 III Break (X7) (08-)	1,6 HDi	ArG			24.5151-0638.3	331141	FLEXIBLE FREIN	4806 K2	
		ArD	02.2008		24.5151-0584.3	331020	FLEXIBLE FREIN	4806 E8	
		ArG	02.2008		24.5151-0583.3	331019	FLEXIBLE FREIN	4806 E7	
		ArD			24.5151-0639.3	331142	FLEXIBLE FREIN	4806 K3	
		AvG	02.2008		11.9601-9731.2	220853	ETRIER A GRIFFE	4400 V3	
		AvD	02.2008		11.9601-9732.2	220854	ETRIER A GRIFFE	4400 V4	
	1,6 HDi 110	ArD	07.2010		24.5151-0584.3	331020	FLEXIBLE FREIN	4806 E8	
		ArD			24.5151-0639.3	331142	FLEXIBLE FREIN	4806 K3	
		ArG	07.2010		24.5151-0583.3	331019	FLEXIBLE FREIN	4806 E7	
		ArG			24.5151-0638.3	331141	FLEXIBLE FREIN	4806 K2	
		AvD	07.2010		11.9601-9732.2	220854	ETRIER A GRIFFE	4400 V4	
		AvG	07.2010		11.9601-9731.2	220853	ETRIER A GRIFFE	4400 V3	
	1,6 THP 155	ArG	04.2009		24.5151-0583.3	331019	FLEXIBLE FREIN	4806 E7	
		ArD			24.5151-0639.3	331142	FLEXIBLE FREIN	4806 K3	
		ArG			24.5151-0638.3	331141	FLEXIBLE FREIN	4806 K2	
		ArD	04.2009		24.5151-0584.3	331020	FLEXIBLE FREIN	4806 E8	
	1,6 VTI 120	ArD			24.5151-0639.3	331142	FLEXIBLE FREIN	4806 K3	

Nouvelles références disponibles - par applications

02/2012



					description	Références OE par référence ATE.		Références remplacées / divers
--	--	--	--	--	-------------	----------------------------------	--	--------------------------------

CITROEN

Modèle	Motorisation	Code	Date	Part	ATE Ref	ATE Ref	Description	OE Ref	Remplacés
C5 III Break (X7) (08-)	1,6 VTI 120	ArG	07.2010		24.5151-0583.3	331019	FLEXIBLE FREIN	4806 E7	
		ArD	07.2010		24.5151-0584.3	331020	FLEXIBLE FREIN	4806 E8	
		ArG			24.5151-0638.3	331141	FLEXIBLE FREIN	4806 K2	
	1,8 16V	ArG	02.2008		24.5151-0583.3	331019	FLEXIBLE FREIN	4806 E7	
		ArD	02.2008		24.5151-0584.3	331020	FLEXIBLE FREIN	4806 E8	
		ArG			24.5151-0638.3	331141	FLEXIBLE FREIN	4806 K2	
		ArD			24.5151-0639.3	331142	FLEXIBLE FREIN	4806 K3	
		AvG	02.2008		11.9601-9731.2	220853	ETRIER A GRIFFE	4400 V3	
	2,0 16V	AvD	02.2008		11.9601-9732.2	220854	ETRIER A GRIFFE	4400 V4	
		ArG	02.2008		24.5151-0583.3	331019	FLEXIBLE FREIN	4806 E7	
		ArD			24.5151-0639.3	331142	FLEXIBLE FREIN	4806 K3	
		ArD	02.2008		24.5151-0584.3	331020	FLEXIBLE FREIN	4806 E8	
ArG				24.5151-0638.3	331141	FLEXIBLE FREIN	4806 K2		
AvD		02.2008		11.9601-9732.2	220854	ETRIER A GRIFFE	4400 V4		
2,0 16V BioFlex	AvG	02.2008		11.9601-9731.2	220853	ETRIER A GRIFFE	4400 V3		
	ArG	02.2008		24.5151-0583.3	331019	FLEXIBLE FREIN	4806 E7		
	ArD	02.2008		24.5151-0584.3	331020	FLEXIBLE FREIN	4806 E8		
	ArD			24.5151-0639.3	331142	FLEXIBLE FREIN	4806 K3		
	ArG			24.5151-0638.3	331141	FLEXIBLE FREIN	4806 K2		



					description	Références OE par référence ATE.		Références remplacées / divers
--	--	--	--	--	-------------	----------------------------------	--	--------------------------------

CITROEN

CITROEN	Application	Version	Date	ATE Ref 1	ATE Ref 2	Description	Ref OE	
C5 III Break (X7) (08-)	2,0 16V BioFlex	AvD	02.2008	11.9601-9732.2	220854	ETRIER A GRIFFE	4400 V4	
		AvG	02.2008	11.9601-9731.2	220853	ETRIER A GRIFFE	4400 V3	
	2,0 HDi	ArG		24.5151-0638.3	331141	FLEXIBLE FREIN	4806 K2	
		ArG	02.2008	24.5151-0583.3	331019	FLEXIBLE FREIN	4806 E7	
		ArG	04.2009	24.5151-0583.3	331019	FLEXIBLE FREIN	4806 E7	
		ArD	02.2008	24.5151-0584.3	331020	FLEXIBLE FREIN	4806 E8	
		ArD	04.2009	24.5151-0584.3	331020	FLEXIBLE FREIN	4806 E8	
		ArD		24.5151-0639.3	331142	FLEXIBLE FREIN	4806 K3	
		AvD	02.2008	11.9601-9732.2	220854	ETRIER A GRIFFE	4400 V4	
		AvG	02.2008	11.9601-9731.2	220853	ETRIER A GRIFFE	4400 V3	
	2,0 HDi 140	ArG		24.5151-0638.3	331141	FLEXIBLE FREIN	4806 K2	
		ArG	11.2008	24.5151-0583.3	331019	FLEXIBLE FREIN	4806 E7	
		ArD	11.2008	24.5151-0584.3	331020	FLEXIBLE FREIN	4806 E8	
		ArD		24.5151-0639.3	331142	FLEXIBLE FREIN	4806 K3	
		AvD	11.2008	11.9601-9732.2	220854	ETRIER A GRIFFE	4400 V4	
		AvG	11.2008	11.9601-9731.2	220853	ETRIER A GRIFFE	4400 V3	
	2,0 HDi 165	AvD	04.2009	11.9601-9732.2	220854	ETRIER A GRIFFE	4400 V4	
		AvG	04.2009	11.9601-9731.2	220853	ETRIER A GRIFFE	4400 V3	
	2,2 HDi	ArD	02.2008	24.5151-0584.3	331020	FLEXIBLE FREIN	4806 E8	

Nouvelles références disponibles - par applications

02/2012



					description	Références OE par référence ATE.		Références remplacées / divers
--	--	--	--	--	-------------	----------------------------------	--	--------------------------------

CITROEN

C5 III Break (X7) (08-)	2,2 HDi	ArG	02.2008		24.5151-0583.3	331019	FLEXIBLE FREIN	4806 E7	
		ArG			24.5151-0638.3	331141	FLEXIBLE FREIN	4806 K2	
		ArD			24.5151-0639.3	331142	FLEXIBLE FREIN	4806 K3	
	2,2 HDi 200	ArG	07.2010		24.5151-0583.3	331019	FLEXIBLE FREIN	4806 E7	
		ArG			24.5151-0638.3	331141	FLEXIBLE FREIN	4806 K2	
		ArD	07.2010		24.5151-0584.3	331020	FLEXIBLE FREIN	4806 E8	
		ArD			24.5151-0639.3	331142	FLEXIBLE FREIN	4806 K3	
	2,7 HDi	ArD	02.2008		24.5151-0584.3	331020	FLEXIBLE FREIN	4806 E8	
		ArG			24.5151-0638.3	331141	FLEXIBLE FREIN	4806 K2	
		ArD			24.5151-0639.3	331142	FLEXIBLE FREIN	4806 K3	
		ArG	02.2008		24.5151-0583.3	331019	FLEXIBLE FREIN	4806 E7	
	3	ArG			24.5151-0638.3	331141	FLEXIBLE FREIN	4806 K2	
		ArD	02.2008		24.5151-0584.3	331020	FLEXIBLE FREIN	4806 E8	
		ArD			24.5151-0639.3	331142	FLEXIBLE FREIN	4806 K3	
		ArG	02.2008		24.5151-0583.3	331019	FLEXIBLE FREIN	4806 E7	
	3,0 HDi 240	ArG			24.5151-0638.3	331141	FLEXIBLE FREIN	4806 K2	
		ArD			24.5151-0639.3	331142	FLEXIBLE FREIN	4806 K3	
		ArD	04.2009		24.5151-0584.3	331020	FLEXIBLE FREIN	4806 E8	
		ArG	04.2009		24.5151-0583.3	331019	FLEXIBLE FREIN	4806 E7	



					description	Références OE par référence ATE.		Références remplacées / divers
--	--	--	--	--	-------------	----------------------------------	--	--------------------------------







CITROEN

C5 III Break (X7) (08-)	3,0 V6	ArD	02.2008		24.5151-0584.3	331020	FLEXIBLE FREIN	4806 E8	
		ArD			24.5151-0639.3	331142	FLEXIBLE FREIN	4806 K3	
		ArG	02.2008		24.5151-0583.3	331019	FLEXIBLE FREIN	4806 E7	
		ArG			24.5151-0638.3	331141	FLEXIBLE FREIN	4806 K2	
C5 III Berline (X7) (08-)	1,6 HDi	ArG			24.5151-0638.3	331141	FLEXIBLE FREIN	4806 K2	
		ArG	02.2008		24.5151-0583.3	331019	FLEXIBLE FREIN	4806 E7	
		ArD	02.2008		24.5151-0584.3	331020	FLEXIBLE FREIN	4806 E8	
		ArD			24.5151-0639.3	331142	FLEXIBLE FREIN	4806 K3	
		AvD	02.2008		11.9601-9732.2	220854	ETRIER A GRIFFE	4400 V4	
		AvG	02.2008		11.9601-9731.2	220853	ETRIER A GRIFFE	4400 V3	
	1,6 HDi 110	ArD	07.2010		24.5151-0584.3	331020	FLEXIBLE FREIN	4806 E8	
		ArG	07.2010		24.5151-0583.3	331019	FLEXIBLE FREIN	4806 E7	
		ArG			24.5151-0638.3	331141	FLEXIBLE FREIN	4806 K2	
		ArD			24.5151-0639.3	331142	FLEXIBLE FREIN	4806 K3	
		AvD	07.2010		11.9601-9732.2	220854	ETRIER A GRIFFE	4400 V4	
		AvG	07.2010		11.9601-9731.2	220853	ETRIER A GRIFFE	4400 V3	
	1,6 THP 155	ArG	04.2009		24.5151-0583.3	331019	FLEXIBLE FREIN	4806 E7	
		ArD	04.2009		24.5151-0584.3	331020	FLEXIBLE FREIN	4806 E8	
		ArG			24.5151-0638.3	331141	FLEXIBLE FREIN	4806 K2	

Nouvelles références disponibles - par applications

02/2012



					description	Références OE par référence ATE.	 Références remplacées / divers
---	---	---	---	---	--------------------	---	--

CITROEN

C5 III Berline (X7) (08-)	1,6 THP 155	ArD			24.5151-0639.3	331142	FLEXIBLE FREIN	4806 K3	
	1,6 VTI 120	ArD	07.2010		24.5151-0584.3	331020	FLEXIBLE FREIN	4806 E8	
		ArG			24.5151-0638.3	331141	FLEXIBLE FREIN	4806 K2	
		ArD			24.5151-0639.3	331142	FLEXIBLE FREIN	4806 K3	
		ArG	07.2010		24.5151-0583.3	331019	FLEXIBLE FREIN	4806 E7	
	1,8 16V	ArG			24.5151-0638.3	331141	FLEXIBLE FREIN	4806 K2	
		ArD			24.5151-0639.3	331142	FLEXIBLE FREIN	4806 K3	
		ArD	02.2008		24.5151-0584.3	331020	FLEXIBLE FREIN	4806 E8	
		ArG	02.2008		24.5151-0583.3	331019	FLEXIBLE FREIN	4806 E7	
		AvG	02.2008		11.9601-9731.2	220853	ETRIER A GRIFFE	4400 V3	
		AvD	02.2008		11.9601-9732.2	220854	ETRIER A GRIFFE	4400 V4	
	2,0 16V	ArD			24.5151-0639.3	331142	FLEXIBLE FREIN	4806 K3	
		ArG			24.5151-0638.3	331141	FLEXIBLE FREIN	4806 K2	
		ArG	02.2008		24.5151-0583.3	331019	FLEXIBLE FREIN	4806 E7	
		ArD	02.2008		24.5151-0584.3	331020	FLEXIBLE FREIN	4806 E8	
		AvD	02.2008		11.9601-9732.2	220854	ETRIER A GRIFFE	4400 V4	
		AvG	02.2008		11.9601-9731.2	220853	ETRIER A GRIFFE	4400 V3	
	2,0 16V BioFlex	ArD	02.2008		24.5151-0584.3	331020	FLEXIBLE FREIN	4806 E8	
		ArD			24.5151-0639.3	331142	FLEXIBLE FREIN	4806 K3	



					description	Références OE par référence ATE.		Références remplacées / divers
--	--	--	--	--	-------------	----------------------------------	--	--------------------------------

CITROEN

CITROEN	Application	Code	Date	ATE Ref 1	ATE Ref 2	Description	Ref OE	Ref Divers	
C5 III Berline (X7) (08-)	2,0 16V BioFlex	ArG		24.5151-0638.3	331141	FLEXIBLE FREIN	4806 K2		
		ArG	02.2008	24.5151-0583.3	331019	FLEXIBLE FREIN	4806 E7		
		AvD	02.2008	11.9601-9732.2	220854	ETRIER A GRIFFE	4400 V4		
		AvG	02.2008	11.9601-9731.2	220853	ETRIER A GRIFFE	4400 V3		
		ArG	02.2008	24.5151-0583.3	331019	FLEXIBLE FREIN	4806 E7		
		ArG	04.2009	24.5151-0583.3	331019	FLEXIBLE FREIN	4806 E7		
	2,0 HDi	ArD		24.5151-0639.3	331142	FLEXIBLE FREIN	4806 K3		
		ArG		24.5151-0638.3	331141	FLEXIBLE FREIN	4806 K2		
		ArD	02.2008	24.5151-0584.3	331020	FLEXIBLE FREIN	4806 E8		
		ArD	04.2009	24.5151-0584.3	331020	FLEXIBLE FREIN	4806 E8		
		AvD	02.2008	11.9601-9732.2	220854	ETRIER A GRIFFE	4400 V4		
		AvD	04.2009	11.9601-9732.2	220854	ETRIER A GRIFFE	4400 V4		
		AvG	04.2009	11.9601-9731.2	220853	ETRIER A GRIFFE	4400 V3		
		AvG	02.2008	11.9601-9731.2	220853	ETRIER A GRIFFE	4400 V3		
		2,0 HDi 140	ArD		24.5151-0639.3	331142	FLEXIBLE FREIN	4806 K3	
			ArD	11.2008	24.5151-0584.3	331020	FLEXIBLE FREIN	4806 E8	
			ArG	11.2008	24.5151-0583.3	331019	FLEXIBLE FREIN	4806 E7	
			ArG		24.5151-0638.3	331141	FLEXIBLE FREIN	4806 K2	
		AvD	11.2008	11.9601-9732.2	220854	ETRIER A GRIFFE	4400 V4		



					description	Références OE par référence ATE.		Références remplacées / divers
--	--	--	--	--	-------------	----------------------------------	--	--------------------------------

CITROEN

C5 III Berline (X7) (08-)	2,0 HDi 140	AvG	11.2008		11.9601-9731.2	220853	ETRIER A GRIFFE	4400 V3	
	2,0 HDi 165	AvD	04.2009		11.9601-9732.2	220854	ETRIER A GRIFFE	4400 V4	
		AvG	04.2009		11.9601-9731.2	220853	ETRIER A GRIFFE	4400 V3	
	2,2 HDi	ArG	02.2008		24.5151-0583.3	331019	FLEXIBLE FREIN	4806 E7	
		ArD	02.2008		24.5151-0584.3	331020	FLEXIBLE FREIN	4806 E8	
		ArD			24.5151-0639.3	331142	FLEXIBLE FREIN	4806 K3	
		ArG			24.5151-0638.3	331141	FLEXIBLE FREIN	4806 K2	
	2,2 HDi 200	ArG	07.2010		24.5151-0583.3	331019	FLEXIBLE FREIN	4806 E7	
		ArD	07.2010		24.5151-0584.3	331020	FLEXIBLE FREIN	4806 E8	
		ArD			24.5151-0639.3	331142	FLEXIBLE FREIN	4806 K3	
		ArG			24.5151-0638.3	331141	FLEXIBLE FREIN	4806 K2	
	2,7 HDi	ArG	02.2008		24.5151-0583.3	331019	FLEXIBLE FREIN	4806 E7	
		ArD	02.2008		24.5151-0584.3	331020	FLEXIBLE FREIN	4806 E8	
		ArD			24.5151-0639.3	331142	FLEXIBLE FREIN	4806 K3	
		ArG			24.5151-0638.3	331141	FLEXIBLE FREIN	4806 K2	
	3	ArD			24.5151-0639.3	331142	FLEXIBLE FREIN	4806 K3	
		ArG	02.2008		24.5151-0583.3	331019	FLEXIBLE FREIN	4806 E7	
		ArG			24.5151-0638.3	331141	FLEXIBLE FREIN	4806 K2	
		ArD	02.2008		24.5151-0584.3	331020	FLEXIBLE FREIN	4806 E8	









					description	Références OE par référence ATE.		Références remplacées / divers
--	--	--	--	--	-------------	----------------------------------	--	--------------------------------

CITROEN

C5 III Berline (X7) (08-)	3,0 HDi 240	ArD	04.2009		24.5151-0584.3	331020	FLEXIBLE FREIN	4806 E8		
		ArD			24.5151-0639.3	331142	FLEXIBLE FREIN	4806 K3		
			ArG	04.2009		24.5151-0583.3	331019	FLEXIBLE FREIN	4806 E7	
			ArG			24.5151-0638.3	331141	FLEXIBLE FREIN	4806 K2	
	3,0 V6	ArG			24.5151-0638.3	331141	FLEXIBLE FREIN	4806 K2		
		ArD	02.2008		24.5151-0584.3	331020	FLEXIBLE FREIN	4806 E8		
			ArD			24.5151-0639.3	331142	FLEXIBLE FREIN	4806 K3	
			ArG	02.2008		24.5151-0583.3	331019	FLEXIBLE FREIN	4806 E7	
C6 (05-)	2,2 HDi	ArD	06.2006		24.5151-0639.3	331142	FLEXIBLE FREIN	4806 K3		
		ArG	06.2006		24.5151-0583.3	331019	FLEXIBLE FREIN	4806 E7		
		ArD	06.2006		24.5151-0584.3	331020	FLEXIBLE FREIN	4806 E8		
			ArG	06.2006		24.5151-0638.3	331141	FLEXIBLE FREIN	4806 K2	
			2,7 HDi	ArG	09.2005		24.5151-0583.3	331019	FLEXIBLE FREIN	4806 E7
				ArG	09.2005		24.5151-0638.3	331141	FLEXIBLE FREIN	4806 K2
			ArD	09.2005		24.5151-0639.3	331142	FLEXIBLE FREIN	4806 K3	
			ArD	09.2005		24.5151-0584.3	331020	FLEXIBLE FREIN	4806 E8	
			3,0 HDi	ArD	07.2009		24.5151-0639.3	331142	FLEXIBLE FREIN	4806 K3
				ArD	07.2009		24.5151-0584.3	331020	FLEXIBLE FREIN	4806 E8
		ArG	07.2009		24.5151-0583.3	331019	FLEXIBLE FREIN	4806 E7		



					description	Références OE par référence ATE.	 Références remplacées / divers
---	---	---	---	---	--------------------	---	--

CITROEN

C6 (05-)	3,0 HDi	ArG	07.2009		24.5151-0638.3	331141	FLEXIBLE FREIN	4806 K2	
	3,0 V6	ArG	09.2005		24.5151-0638.3	331141	FLEXIBLE FREIN	4806 K2	
		ArD	09.2005		24.5151-0639.3	331142	FLEXIBLE FREIN	4806 K3	
		ArD	09.2005		24.5151-0584.3	331020	FLEXIBLE FREIN	4806 E8	
		ArG	09.2005		24.5151-0583.3	331019	FLEXIBLE FREIN	4806 E7	
C8 (02-)	2,2 HDi		09.2007		24.5144-0500.3	331169	FLEXIBLE FREIN	4806 J6	
C-CROSSER (07-)		AvD	02.2007		24.5286-0601.3	331174	FLEXIBLE FREIN	4806 H9	
	2,4	AvD	08.2008		24.5286-0601.3	331174	FLEXIBLE FREIN	4806 H9	
JUMPY (07-)	1,6 HDi 90		01.2007		24.5239-0260.3	331171	FLEXIBLE FREIN	4806 H1	
					24.5239-0240.3	331170	FLEXIBLE FREIN	4806 H5	
	2,0 HDi 120				24.5239-0240.3	331170	FLEXIBLE FREIN	4806 H5	
			01.2007		24.5239-0260.3	331171	FLEXIBLE FREIN	4806 H1	
	2,0 HDi 125		07.2011		24.5239-0240.3	331170	FLEXIBLE FREIN	4806 H5	
	2,0 HDi 140				24.5239-0240.3	331170	FLEXIBLE FREIN	4806 H5	
			01.2007		24.5239-0260.3	331171	FLEXIBLE FREIN	4806 H1	
	2,0 HDi 165		07.2010		24.5239-0260.3	331171	FLEXIBLE FREIN	4806 H1	
					24.5239-0240.3	331170	FLEXIBLE FREIN	4806 H5	
	2,0 HDi 95		07.2011		24.5239-0240.3	331170	FLEXIBLE FREIN	4806 H5	
	2,0 i				24.5239-0240.3	331170	FLEXIBLE FREIN	4806 H5	



					description	Références OE par référence ATE.		Références remplacées / divers
--	--	--	--	--	-------------	----------------------------------	--	--------------------------------

CITROEN

JUMPY (07-)	2,0 i		01.2007		24.5239-0260.3	331171	FLEXIBLE FREIN	4806 H1	
-------------	-------	--	---------	--	----------------	--------	----------------	---------	--

Classic PKW

LAND ROVER DEFENDER (LD) (90-)	2,4 Td4				13.0460-6924.2	606924	PLAQUETTES DE FREIN	SFP000130 , SFP000250	cf. Photo
	2,5 TD5				13.0460-6924.2	606924	PLAQUETTES DE FREIN	SFP000130 , SFP000250	cf. Photo
	2,5 TDI				13.0460-6924.2	606924	PLAQUETTES DE FREIN	SFP000130 , SFP000250	cf. Photo
	3,9 V8				13.0460-6924.2	606924	PLAQUETTES DE FREIN	SFP000130 , SFP000250	cf. Photo









					description	Références OE par référence ATE.		Références remplacées / divers
--	--	--	--	--	-------------	----------------------------------	--	--------------------------------

FIAT

BRAVO (07-)	1,4 16V		04.2008		24.5112-0187.3	331150	FLEXIBLE FREIN	51783802	
			04.2008		24.5112-0413.3	331151	FLEXIBLE FREIN	46554126	
	1,4 i 16V		04.2007		24.5112-0187.3	331150	FLEXIBLE FREIN	51783802	
			04.2007		24.5112-0413.3	331151	FLEXIBLE FREIN	46554126	
	1,4 LPG		11.2009		24.5112-0413.3	331151	FLEXIBLE FREIN	46554126	
			11.2009		24.5112-0187.3	331150	FLEXIBLE FREIN	51783802	
	1,4 T-Jet		09.2007		24.5112-0413.3	331151	FLEXIBLE FREIN	46554126	
			09.2007		24.5112-0187.3	331150	FLEXIBLE FREIN	51783802	
	1,6 D Multijet		03.2008		24.5112-0413.3	331151	FLEXIBLE FREIN	46554126	
			03.2008		24.5112-0187.3	331150	FLEXIBLE FREIN	51783802	
	1,9 D Multijet		04.2007		24.5112-0187.3	331150	FLEXIBLE FREIN	51783802	
			04.2007	12.2008	24.5112-0187.3	331150	FLEXIBLE FREIN	51783802	
			04.2007	12.2008	24.5112-0413.3	331151	FLEXIBLE FREIN	46554126	
			04.2007		24.5112-0413.3	331151	FLEXIBLE FREIN	46554126	
	2,0 D Multijet		09.2008		24.5112-0413.3	331151	FLEXIBLE FREIN	46554126	
			09.2008		24.5112-0187.3	331150	FLEXIBLE FREIN	51783802	
DOBLO (10-)	1,3 D Multijet	AvD	02.2010		11.9571-9954.2	220872	ETRIER A GRIFFE	77365310 , 77364967	
		AvG	02.2010		11.9571-9953.2	220871	ETRIER A GRIFFE	77365309 , 77364966	
	1,4	AvD	02.2010		11.9571-9954.2	220872	ETRIER A GRIFFE	77365310 , 77364967	









					<p>description</p>	<p>Références OE par référence ATE.</p>	 <p>Références remplacées / divers</p>
---	---	---	---	---	---------------------------	--	--

FIAT

Model	Engine	Code	Year	ATE Ref 1	ATE Ref 2	Description	OE Refs	Other Refs
DOBLO (10-)	1,4	AvG	02.2010		11.9571-9953.2	220871	ETRIER A GRIFFE	77365309 , 77364966
	1,4 Natural Power	AvD	02.2010		11.9571-9954.2	220872	ETRIER A GRIFFE	77365310 , 77364967
		AvG	02.2010		11.9571-9953.2	220871	ETRIER A GRIFFE	77365309 , 77364966
	1,6 D 16V Multijet	AvD	02.2010		11.9571-9954.2	220872	ETRIER A GRIFFE	77365310 , 77364967
		AvG	02.2010		11.9571-9953.2	220871	ETRIER A GRIFFE	77365309 , 77364966
	1,6 D Multijet	AvG	02.2010		11.9571-9953.2	220871	ETRIER A GRIFFE	77365309 , 77364966
		AvD	02.2010		11.9571-9954.2	220872	ETRIER A GRIFFE	77365310 , 77364967
	2,0 D Multijet	AvD	02.2010		11.9571-9954.2	220872	ETRIER A GRIFFE	77365310 , 77364967
		AvG	02.2010		11.9571-9953.2	220871	ETRIER A GRIFFE	77365309 , 77364966









		 		<p>description</p>	<p>Références OE par référence ATE.</p>	 <p>Références remplacées / divers</p>
---	---	---	---	--------------------	---	---

FORD

KA II (09-)	1,3 TDCi		02.2009		24.3728-0628.2	590628	CABLE D'EMBRAYAGE	1558931 , 9S51-7K553-BA	
TRANSIT (06-)	2,2 TDCi		05.2006		24.5141-0320.3	330949	FLEXIBLE FREIN	1383533 , 6C11-2078-AB , 1371515 , 6C11-2078-AA	
	2,2 TDCi 4x4		10.2011		24.5141-0320.3	330949	FLEXIBLE FREIN	1383533 , 6C11-2078-AB , 1371515 , 6C11-2078-AA	
	2,2 TDCi RWD		10.2011		24.5141-0320.3	330949	FLEXIBLE FREIN	1383533 , 6C11-2078-AB , 1371515 , 6C11-2078-AA	
	2,3 16V RWD		05.2006		24.5141-0320.3	330949	FLEXIBLE FREIN	1383533 , 6C11-2078-AB , 1371515 , 6C11-2078-AA	
	2,4 TDCi 4x4		05.2006		24.5141-0320.3	330949	FLEXIBLE FREIN	1383533 , 6C11-2078-AB , 1371515 , 6C11-2078-AA	
	2,4 TDCi RWD		05.2006		24.5141-0320.3	330949	FLEXIBLE FREIN	1383533 , 6C11-2078-AB , 1371515 , 6C11-2078-AA	
	3,2 TDCi RWD		09.2007		24.5141-0320.3	330949	FLEXIBLE FREIN	1383533 , 6C11-2078-AB , 1371515 , 6C11-2078-AA	









		 		<p>description</p>	<p>Références OE par référence ATE.</p>	 <p>Références remplacées / divers</p>
---	---	---	---	---------------------------	--	--

HONDA

Modèle	Motorisation	Date	Code	Description	Références OE	Références ATE	Description	Références OE	Références ATE
CIVIC Hatchback (FK/FN) (05-)	1,4 i-Vtec (FK1/FN4)	10.2008		MAITRE CYL. TANDEM	24.2119-1709.3	010876	MAITRE CYL. TANDEM	46100-SNA-A01	
	1,6 i 16V (FK4)	09.2005		MAITRE CYL. TANDEM	24.2119-1709.3	010876	MAITRE CYL. TANDEM	46100-SNA-A01	
CIVIC Stufenheck (FD) (05-)	1,6 16V (FD4)	09.2005		MAITRE CYL. TANDEM	24.2119-1709.3	010876	MAITRE CYL. TANDEM	46100-SNA-A01	
	1,6 16V (FD4/FD6)	01.2006		MAITRE CYL. TANDEM	24.2119-1709.3	010876	MAITRE CYL. TANDEM	46100-SNA-A01	
	1,8 16V (FD1)	02.2006		MAITRE CYL. TANDEM	24.2119-1709.3	010876	MAITRE CYL. TANDEM	46100-SNA-A01	
		01.2006		MAITRE CYL. TANDEM	24.2119-1709.3	010876	MAITRE CYL. TANDEM	46100-SNA-A01	
	1,8 i-Vtec (FD1/FD7)	09.2005		MAITRE CYL. TANDEM	24.2119-1709.3	010876	MAITRE CYL. TANDEM	46100-SNA-A01	



					description	Références OE par référence ATE.	 Références remplacées / divers
---	---	---	---	---	--------------------	---	--

HYUNDAI

GALLOPER (98-03)	2,5 TcI D	AvD	08.1998	06.2003	24.5290-0440.3	331177	FLEXIBLE FREIN	HB407506	
		AvG	08.1998	06.2003	24.5290-0439.3	331176	FLEXIBLE FREIN	HB407505	
	2,5 TD	AvG	08.1998	06.2003	24.5290-0439.3	331176	FLEXIBLE FREIN	HB407505	
		AvD	08.1998	06.2003	24.5290-0440.3	331177	FLEXIBLE FREIN	HB407506	
	2,5 TD Intercooler	AvD	08.1998	06.2003	24.5290-0440.3	331177	FLEXIBLE FREIN	HB407506	
		AvG	08.1998	06.2003	24.5290-0439.3	331176	FLEXIBLE FREIN	HB407505	
	2,6 TD Allrad		08.1998	06.2003	24.5260-0155.3	331156	FLEXIBLE FREIN	MR129770	
	3,0 i V6	AvD	08.1998	06.2003	24.5290-0440.3	331177	FLEXIBLE FREIN	HB407506	
		AvG	08.1998	06.2003	24.5290-0439.3	331176	FLEXIBLE FREIN	HB407505	
MATRIX (01-08)	1,5 CRDi	AvD	10.2001	02.2005	24.5298-0515.3	331166	FLEXIBLE FREIN	58732-17000	
		AvD	12.2004	04.2008	24.5298-0515.3	331166	FLEXIBLE FREIN	58732-17000	
	1,5 CRDi VGT	AvD	08.2005	04.2008	24.5298-0515.3	331166	FLEXIBLE FREIN	58732-17000	
	1,6 i 16V	AvD	06.2001	04.2008	24.5298-0515.3	331166	FLEXIBLE FREIN	58732-17000	
	1,8 i 16V	AvD	06.2001	04.2008	24.5298-0515.3	331166	FLEXIBLE FREIN	58732-17000	



					description	Références OE par référence ATE.		Références remplacées / divers
--	--	--	--	--	-------------	-------------------------------------	--	-----------------------------------

LANCIA

DELTA (08-)	1,4 16V		07.2010		24.5112-0187.3	331150	FLEXIBLE FREIN	51783802	
			08.2008		24.5112-0187.3	331150	FLEXIBLE FREIN	51783802	
	1,4 16V Turbo		08.2008		24.5112-0187.3	331150	FLEXIBLE FREIN	51783802	
	1,6 D Multijet		04.2011		24.5112-0187.3	331150	FLEXIBLE FREIN	51783802	
			08.2008		24.5112-0187.3	331150	FLEXIBLE FREIN	51783802	
	1,8 16V		02.2009		24.5112-0187.3	331150	FLEXIBLE FREIN	51783802	
		AvD	02.2009		11.9571-9954.2	220872	ETRIER A GRIFFE	77365310 , 77364967	
		AvG	02.2009		11.9571-9953.2	220871	ETRIER A GRIFFE	77365309 , 77364966	
	1,8 Di 16V		01.2009		24.5112-0187.3	331150	FLEXIBLE FREIN	51783802	
		AvG	01.2009		11.9571-9953.2	220871	ETRIER A GRIFFE	77365309 , 77364966	
		AvD	01.2009		11.9571-9954.2	220872	ETRIER A GRIFFE	77365310 , 77364967	
	1,9 D Multijet		08.2008		24.5112-0187.3	331150	FLEXIBLE FREIN	51783802	
		AvD	08.2008		11.9571-9954.2	220872	ETRIER A GRIFFE	77365310 , 77364967	
		AvG	08.2008		11.9571-9953.2	220871	ETRIER A GRIFFE	77365309 , 77364966	
	2,0 D Multijet		08.2008		24.5112-0187.3	331150	FLEXIBLE FREIN	51783802	
		AvG	08.2008		11.9571-9953.2	220871	ETRIER A GRIFFE	77365309 , 77364966	
		AvD	08.2008		11.9571-9954.2	220872	ETRIER A GRIFFE	77365310 , 77364967	



					description	Références OE par référence ATE.		Références remplacées / divers
--	--	--	--	--	-------------	----------------------------------	--	--------------------------------

MERCEDES BENZ

Classe E (S211) Break (03-09)	E 240 4-Matic	AvG	07.2003	10.2009	11.9601-9770.2	220878	ETRIER A GRIFFE	002 420 63 83	
	E 280 4-Matic	AvG	05.2005	10.2009	11.9601-9770.2	220878	ETRIER A GRIFFE	002 420 63 83	
	E 280 CDI 4-Matic	AvG	05.2005	10.2009	11.9601-9770.2	220878	ETRIER A GRIFFE	002 420 63 83	
	E 320 4-Matic	AvG	07.2003	10.2009	11.9601-9770.2	220878	ETRIER A GRIFFE	002 420 63 83	
	E 320 CDI 4-Matic	AvG	05.2005	10.2009	11.9601-9770.2	220878	ETRIER A GRIFFE	002 420 63 83	
	E 350 4-Matic	AvG	12.2004	10.2009	11.9601-9770.2	220878	ETRIER A GRIFFE	002 420 63 83	
	E 500 4-Matic	AvG	10.2003	10.2009	11.9601-9770.2	220878	ETRIER A GRIFFE	002 420 63 83	
Classe E (W211) Berline (02-09)	E 240 4-Matic	AvG	03.2003	02.2009	11.9601-9770.2	220878	ETRIER A GRIFFE	002 420 63 83	
	E 280 4-Matic	AvG	05.2005	02.2009	11.9601-9770.2	220878	ETRIER A GRIFFE	002 420 63 83	
	E 280 CDI 4-Matic	AvG	05.2005	02.2009	11.9601-9770.2	220878	ETRIER A GRIFFE	002 420 63 83	
	E 320 4-Matic	AvG	03.2003	02.2009	11.9601-9770.2	220878	ETRIER A GRIFFE	002 420 63 83	
	E 320 CDI 4-Matic	AvG	05.2005	02.2009	11.9601-9770.2	220878	ETRIER A GRIFFE	002 420 63 83	
	E 350 4-Matic	AvG	12.2004	02.2009	11.9601-9770.2	220878	ETRIER A GRIFFE	002 420 63 83	
	E 500 4-Matic	AvG	10.2003	02.2009	11.9601-9770.2	220878	ETRIER A GRIFFE	002 420 63 83	
Classe S (W220) (98-06)	S 350 4-Matic	AvG	06.2003	03.2006	11.9601-9770.2	220878	ETRIER A GRIFFE	002 420 63 83	
Transporter (BM 906) SPRINTER (06-)	209 CDI		04.2006		24.5137-0490.3	330964	FLEXIBLE FREIN	906 428 09 35	
	210 CDI		03.2009		24.5137-0490.3	330964	FLEXIBLE FREIN	906 428 09 35	
	211 CDI		04.2006		24.5137-0490.3	330964	FLEXIBLE FREIN	906 428 09 35	
	213 CDI		04.2006		24.5137-0490.3	330964	FLEXIBLE FREIN	906 428 09 35	



					description	Références OE par référence ATE.		Références remplacées / divers
--	--	--	--	--	-------------	----------------------------------	--	--------------------------------

MERCEDES BENZ

Transporter (BM 906) SPRINTER (06-)								
215 CDI		04.2006		24.5137-0490.3	330964	FLEXIBLE FREIN	906 428 09 35	
216		09.2008		24.5137-0490.3	330964	FLEXIBLE FREIN	906 428 09 35	
216 CDI		03.2009		24.5137-0490.3	330964	FLEXIBLE FREIN	906 428 09 35	
218 CDI		04.2006		24.5137-0490.3	330964	FLEXIBLE FREIN	906 428 09 35	
224		04.2006		24.5137-0490.3	330964	FLEXIBLE FREIN	906 428 09 35	
309 CDI		04.2006		24.5137-0490.3	330964	FLEXIBLE FREIN	906 428 09 35	
310 CDI		03.2009		24.5137-0490.3	330964	FLEXIBLE FREIN	906 428 09 35	
311 CDI		04.2006		24.5137-0490.3	330964	FLEXIBLE FREIN	906 428 09 35	
311 CDI 4x4		02.2008		24.5137-0490.3	330964	FLEXIBLE FREIN	906 428 09 35	
313 CDI		04.2006		24.5137-0490.3	330964	FLEXIBLE FREIN	906 428 09 35	
313 CDI 4x4		06.2006		24.5137-0490.3	330964	FLEXIBLE FREIN	906 428 09 35	
315 CDI		04.2006		24.5137-0490.3	330964	FLEXIBLE FREIN	906 428 09 35	
315 CDI 4x4		02.2008		24.5137-0490.3	330964	FLEXIBLE FREIN	906 428 09 35	
316		09.2008		24.5137-0490.3	330964	FLEXIBLE FREIN	906 428 09 35	
316 CDI		03.2009		24.5137-0490.3	330964	FLEXIBLE FREIN	906 428 09 35	
316 CDI 4x4		03.2009		24.5137-0490.3	330964	FLEXIBLE FREIN	906 428 09 35	
316 NGT		09.2008		24.5137-0490.3	330964	FLEXIBLE FREIN	906 428 09 35	
318 CDI		04.2006		24.5137-0490.3	330964	FLEXIBLE FREIN	906 428 09 35	
318 CDI 4x4		02.2008		24.5137-0490.3	330964	FLEXIBLE FREIN	906 428 09 35	









	i				description	Références OE par référence ATE.	i Références remplacées / divers
--	----------	--	--	--	--------------------	---	---

MERCEDES BENZ

Transporter (BM 906) SPRINTER (06-)	319 CDI		03.2009		24.5137-0490.3	330964	FLEXIBLE FREIN	906 428 09 35	
	319 CDI 4x4		03.2009		24.5137-0490.3	330964	FLEXIBLE FREIN	906 428 09 35	
	324		04.2006		24.5137-0490.3	330964	FLEXIBLE FREIN	906 428 09 35	



					description	Références OE par référence ATE.	 Références remplacées / divers
---	---	---	---	---	--------------------	---	--

MITSUBISHI

GALANT (96-03)	2,0 TDi (EA6)		10.1996	07.2001	24.5230-0243.3	331155	FLEXIBLE FREIN	MR129796	
L 200 (96-06)	2,5 TD 4WD (K74T)		06.1996	07.2001	24.5260-0155.3	331156	FLEXIBLE FREIN	MR129770	
			08.2001	04.2006	24.5260-0155.3	331156	FLEXIBLE FREIN	MR129770	
	2,5 TDi 4WD (K74T)		08.2001	04.2006	24.5260-0155.3	331156	FLEXIBLE FREIN	MR129770	
PAJERO PININ / SHOGUN PININ (GB) (99-05)	1,8 i 16V (H67W)		11.2001	02.2005	24.5279-0225.3	331163	FLEXIBLE FREIN	MR475178	
	1,8 i 16V GDi (H66W)		10.1999	10.2001	24.5279-0225.3	331163	FLEXIBLE FREIN	MR475178	
	2,0 16V GDi (H77W)		09.2000	02.2005	24.5279-0225.3	331163	FLEXIBLE FREIN	MR475178	
PAJERO SPORT / MONTERO (USA) (98-)	2,5 TDCi (K94W)		08.2003		24.5159-0195.3	331153	FLEXIBLE FREIN	MR129745	
			07.2002		24.5159-0195.3	331153	FLEXIBLE FREIN	MR129745	
			11.1998	06.2002	24.5158-0164.3	331152	FLEXIBLE FREIN	MR370634	
			08.2003		24.5158-0164.3	331152	FLEXIBLE FREIN	MR370634	
			07.2002		24.5158-0164.3	331152	FLEXIBLE FREIN	MR370634	
			11.1998	06.2002	24.5159-0195.3	331153	FLEXIBLE FREIN	MR129745	
	3,0 i V6 (K96W)		06.2000		24.5159-0195.3	331153	FLEXIBLE FREIN	MR129745	
			11.1998	09.2001	24.5159-0195.3	331153	FLEXIBLE FREIN	MR129745	
			11.1998	09.2001	24.5158-0164.3	331152	FLEXIBLE FREIN	MR370634	
			06.2000		24.5158-0164.3	331152	FLEXIBLE FREIN	MR370634	

Nouvelles références disponibles - par applications

02/2012



					description	Références OE par référence ATE.		Références remplacées / divers
--	--	--	--	--	-------------	----------------------------------	--	--------------------------------

NISSAN

ALMERA (N15) (95-00)	1,4 i	AvD	07.1995	04.2000	24.5283-0470.3	330959	FLEXIBLE FREIN	46210-0M011 , 46210-0M000 , 46210-0M010
			07.1995	04.2000	24.5281-0556.3	330955	FLEXIBLE FREIN	46210-0M300 , 46210-0M310 , 46210-0M311
		AvG	07.1995	04.2000	24.5283-0471.3	330960	FLEXIBLE FREIN	46210-0M005 , 46210-0M015 , 46210-0M017
	1,6 i		07.1995	04.2000	24.5281-0556.3	330955	FLEXIBLE FREIN	46210-0M300 , 46210-0M310 , 46210-0M311
		AvD	07.1995	04.2000	24.5283-0470.3	330959	FLEXIBLE FREIN	46210-0M011 , 46210-0M000 , 46210-0M010
		AvG	07.1995	04.2000	24.5283-0471.3	330960	FLEXIBLE FREIN	46210-0M005 , 46210-0M015 , 46210-0M017
	2,0 D		07.1995	04.2000	24.5281-0556.3	330955	FLEXIBLE FREIN	46210-0M300 , 46210-0M310 , 46210-0M311
		AvD	07.1995	04.2000	24.5283-0470.3	330959	FLEXIBLE FREIN	46210-0M011 , 46210-0M000 , 46210-0M010
		AvG	07.1995	04.2000	24.5283-0471.3	330960	FLEXIBLE FREIN	46210-0M005 , 46210-0M015 , 46210-0M017
	2,0 i		04.1996	04.2000	24.5281-0556.3	330955	FLEXIBLE FREIN	46210-0M300 , 46210-0M310 , 46210-0M311
		AvD	04.1996	04.2000	24.5283-0470.3	330959	FLEXIBLE FREIN	46210-0M011 , 46210-0M000 , 46210-0M010
		AvG	04.1996	04.2000	24.5283-0471.3	330960	FLEXIBLE FREIN	46210-0M005 , 46210-0M015 , 46210-0M017
ALMERA (N16) (00-06)	1,5 i	ArD	03.2000	03.2001	24.5281-0557.3	330956	FLEXIBLE FREIN	46210-4M416 , 46210-4M411 , 46210-4M41A

Nouvelles références disponibles - par applications

02/2012



					description	Références OE par référence ATE.		Références remplacées / divers
--	--	--	--	--	-------------	----------------------------------	--	--------------------------------

NISSAN

ALMERA (N16) (00-06)	1,8 i	ArD	03.2000	03.2001	24.5281-0557.3	330956	FLEXIBLE FREIN	46210-4M416 , 46210-4M411 , 46210-4M41A
	2,2 Di	ArD	03.2000	03.2001	24.5281-0557.3	330956	FLEXIBLE FREIN	46210-4M416 , 46210-4M411 , 46210-4M41A
PRIMERA (P12E) Berline (02-08)	1,6	ArG	03.2002	10.2008	24.5281-0641.3	330969	FLEXIBLE FREIN	46211-AV710 , 46211-AV715
		ArD	03.2002	04.2006	24.5281-0640.3	330968	FLEXIBLE FREIN	46210-AV710 , 46210-AV715
		ArD	03.2002	10.2008	24.5281-0640.3	330968	FLEXIBLE FREIN	46210-AV710 , 46210-AV715
		ArG	03.2002	04.2006	24.5281-0641.3	330969	FLEXIBLE FREIN	46211-AV710 , 46211-AV715
	1,8	ArG	03.2002	10.2008	24.5281-0641.3	330969	FLEXIBLE FREIN	46211-AV710 , 46211-AV715
		ArD	03.2002	10.2008	24.5281-0640.3	330968	FLEXIBLE FREIN	46210-AV710 , 46210-AV715
	1,9 dCi	ArG	04.2003	10.2007	24.5281-0641.3	330969	FLEXIBLE FREIN	46211-AV710 , 46211-AV715
		ArD	04.2003	10.2007	24.5281-0640.3	330968	FLEXIBLE FREIN	46210-AV710 , 46210-AV715
	2	ArD	03.2002	10.2008	24.5281-0640.3	330968	FLEXIBLE FREIN	46210-AV710 , 46210-AV715
		ArG	03.2002	10.2008	24.5281-0641.3	330969	FLEXIBLE FREIN	46211-AV710 , 46211-AV715
	2,2 dCi	ArD	04.2003	10.2007	24.5281-0640.3	330968	FLEXIBLE FREIN	46210-AV710 , 46210-AV715
		ArG	04.2003	10.2007	24.5281-0641.3	330969	FLEXIBLE FREIN	46211-AV710 , 46211-AV715
	2,2 Di	ArD	03.2002	04.2003	24.5281-0640.3	330968	FLEXIBLE FREIN	46210-AV710 , 46210-AV715
		ArG	03.2002	04.2003	24.5281-0641.3	330969	FLEXIBLE FREIN	46211-AV710 , 46211-AV715
	2,5	ArD	03.2002	04.2006	24.5281-0640.3	330968	FLEXIBLE FREIN	46210-AV710 , 46210-AV715
		ArG	03.2002	04.2006	24.5281-0641.3	330969	FLEXIBLE FREIN	46211-AV710 , 46211-AV715

Nouvelles références disponibles - par applications

02/2012



					description	Références OE par référence ATE.		Références remplacées / divers
--	--	--	--	--	-------------	----------------------------------	--	--------------------------------

NISSAN

PRIMERA (W12) Break (02-08)	1,6	ArG	03.2002	10.2008	24.5281-0641.3	330969	FLEXIBLE FREIN	46211-AV710 , 46211-AV715
		ArD	03.2002	04.2006	24.5281-0640.3	330968	FLEXIBLE FREIN	46210-AV710 , 46210-AV715
		ArD	03.2002	10.2008	24.5281-0640.3	330968	FLEXIBLE FREIN	46210-AV710 , 46210-AV715
		ArG	03.2002	04.2006	24.5281-0641.3	330969	FLEXIBLE FREIN	46211-AV710 , 46211-AV715
	1,8	ArG	03.2002	10.2008	24.5281-0641.3	330969	FLEXIBLE FREIN	46211-AV710 , 46211-AV715
		ArD	03.2002	10.2008	24.5281-0640.3	330968	FLEXIBLE FREIN	46210-AV710 , 46210-AV715
	1,9 dCi	ArG	04.2003	10.2007	24.5281-0641.3	330969	FLEXIBLE FREIN	46211-AV710 , 46211-AV715
		ArD	04.2003	10.2007	24.5281-0640.3	330968	FLEXIBLE FREIN	46210-AV710 , 46210-AV715
	2	ArG	03.2002	10.2008	24.5281-0641.3	330969	FLEXIBLE FREIN	46211-AV710 , 46211-AV715
		ArD	03.2002	10.2008	24.5281-0640.3	330968	FLEXIBLE FREIN	46210-AV710 , 46210-AV715
	2,2 dCi	ArD	04.2003	10.2007	24.5281-0640.3	330968	FLEXIBLE FREIN	46210-AV710 , 46210-AV715
		ArG	04.2003	10.2007	24.5281-0641.3	330969	FLEXIBLE FREIN	46211-AV710 , 46211-AV715
	2,2 Di	ArD	03.2002	04.2003	24.5281-0640.3	330968	FLEXIBLE FREIN	46210-AV710 , 46210-AV715
		ArG	03.2002	04.2003	24.5281-0641.3	330969	FLEXIBLE FREIN	46211-AV710 , 46211-AV715
	2,5	ArD	03.2002	04.2006	24.5281-0640.3	330968	FLEXIBLE FREIN	46210-AV710 , 46210-AV715
		ArG	03.2002	04.2006	24.5281-0641.3	330969	FLEXIBLE FREIN	46211-AV710 , 46211-AV715
QASHQAI (J10E) (07-)	1,5 dCi	AvG	11.2010		24.5266-0600.3	331161	FLEXIBLE FREIN	46210-JD005
		AvG	07.2008		24.5266-0600.3	331161	FLEXIBLE FREIN	46210-JD005
		AvG	02.2007		24.5266-0600.3	331161	FLEXIBLE FREIN	46210-JD005

Nouvelles références disponibles - par applications

02/2012



					description	Références OE par référence ATE.		Références remplacées / divers
--	--	--	--	--	-------------	----------------------------------	--	--------------------------------







NISSAN

QASHQAI (J10E) (07-)	1,6 i 16V	AvG	02.2007		24.5266-0600.3	331161	FLEXIBLE FREIN	46210-JD005	
		AvG	11.2010		24.5266-0600.3	331161	FLEXIBLE FREIN	46210-JD005	
	2,0 dCi	AvG	02.2007		24.5266-0600.3	331161	FLEXIBLE FREIN	46210-JD005	
	2,0 dCi Allrad	AvG	02.2007		24.5266-0600.3	331161	FLEXIBLE FREIN	46210-JD005	
	2,0 i 16V	AvG	11.2010		24.5266-0600.3	331161	FLEXIBLE FREIN	46210-JD005	
		AvG	02.2007		24.5266-0600.3	331161	FLEXIBLE FREIN	46210-JD005	
	2,0 i 16V Allrad	AvG	02.2007		24.5266-0600.3	331161	FLEXIBLE FREIN	46210-JD005	
		AvG	11.2010		24.5266-0600.3	331161	FLEXIBLE FREIN	46210-JD005	
TERRANO II (R20) (93-06)	2,4 i 4WD	AvG	09.2000	11.2005	24.5290-0414.3	331175	FLEXIBLE FREIN	46211-0X800	
	2,7 TD 4WD	AvG	09.2000	01.2002	24.5290-0414.3	331175	FLEXIBLE FREIN	46211-0X800	
	2,7 TDi 4WD	AvG	09.2000	11.2005	24.5290-0414.3	331175	FLEXIBLE FREIN	46211-0X800	
	3,0 Di 4WD	AvG	05.2002	04.2006	24.5290-0414.3	331175	FLEXIBLE FREIN	46211-0X800	
X-TRAIL (T30) (01-07)	2,0 i 16V	ArG	07.2001	02.2007	24.5290-0486.3	331178	FLEXIBLE FREIN	46210-8H515	
	2,0 i 16V 4x4	ArG	07.2001	02.2007	24.5290-0486.3	331178	FLEXIBLE FREIN	46210-8H515	
	2,2 dCi	ArG	12.2003	02.2007	24.5290-0486.3	331178	FLEXIBLE FREIN	46210-8H515	
	2,2 dCi 4x4	ArG	12.2003	02.2007	24.5290-0486.3	331178	FLEXIBLE FREIN	46210-8H515	
	2,2 TDi 4x4	ArG	07.2001	11.2003	24.5290-0486.3	331178	FLEXIBLE FREIN	46210-8H515	
	2,5 i 16V 4x4	ArG	01.2003	02.2007	24.5290-0486.3	331178	FLEXIBLE FREIN	46210-8H515	

Nouvelles références disponibles - par applications

02/2012



					description	Références OE par référence ATE.	 Références remplacées / divers
---	---	---	---	---	--------------------	---	--

OPEL

AGILA (00-07)	1		08.2003	07.2007	03.0137-9300.2	669300	ACC. MACHOIRE		
	1,0 12V			07.2007	03.0137-9300.2	669300	ACC. MACHOIRE		
	1,2 16V			07.2007	03.0137-9300.2	669300	ACC. MACHOIRE		
	1,3 CDTI		08.2003	07.2007	03.0137-9300.2	669300	ACC. MACHOIRE		
ASTRA H / GTC / Vauxhall Astra MKV (04-10)	1,2		08.2005	11.2010	24.5241-0430.3	330918	FLEXIBLE FREIN	55 62 260 , 13136715	
	1,3 CDTI		08.2005	11.2010	24.5241-0430.3	330918	FLEXIBLE FREIN	55 62 260 , 13136715	
	1,4		01.2004	11.2010	24.5241-0430.3	330918	FLEXIBLE FREIN	55 62 260 , 13136715	
	1,6		01.2004	11.2010	24.5241-0430.3	330918	FLEXIBLE FREIN	55 62 260 , 13136715	
			01.2007	11.2010	24.5241-0430.3	330918	FLEXIBLE FREIN	55 62 260 , 13136715	
	1,6 Turbo		01.2007	11.2010	24.5241-0430.3	330918	FLEXIBLE FREIN	55 62 260 , 13136715	
	1,7 CDTI		01.2004	11.2010	24.5241-0430.3	330918	FLEXIBLE FREIN	55 62 260 , 13136715	
			04.2007	11.2010	24.5241-0430.3	330918	FLEXIBLE FREIN	55 62 260 , 13136715	
	1,8		01.2004	11.2010	24.5241-0430.3	330918	FLEXIBLE FREIN	55 62 260 , 13136715	
			01.2006	11.2010	24.5241-0430.3	330918	FLEXIBLE FREIN	55 62 260 , 13136715	
	1,9 CDTI		09.2004	11.2010	24.5241-0430.3	330918	FLEXIBLE FREIN	55 62 260 , 13136715	
			09.2005	11.2010	24.5241-0430.3	330918	FLEXIBLE FREIN	55 62 260 , 13136715	
	2,0 Turbo		01.2004	11.2010	24.5241-0430.3	330918	FLEXIBLE FREIN	55 62 260 , 13136715	
			09.2004	11.2010	24.5241-0430.3	330918	FLEXIBLE FREIN	55 62 260 , 13136715	
ASTRA H Caravan/Vau. Astra MKV Estate (04-10)	1,3 CDTI		08.2005	11.2010	24.5241-0430.3	330918	FLEXIBLE FREIN	55 62 260 , 13136715	
	1,4		08.2004	11.2010	24.5241-0430.3	330918	FLEXIBLE FREIN	55 62 260 , 13136715	









					description	Références OE par référence ATE.		Références remplacées / divers
--	--	--	--	--	-------------	----------------------------------	--	--------------------------------

OPEL

ASTRA H Caravan/Vau. Astra MKV Estate (04-10)	1,6		08.2004	11.2010	24.5241-0430.3	330918	FLEXIBLE FREIN	55 62 260 , 13136715	
			01.2007	11.2010	24.5241-0430.3	330918	FLEXIBLE FREIN	55 62 260 , 13136715	
	1,6 LPG		08.2009	11.2010	24.5241-0430.3	330918	FLEXIBLE FREIN	55 62 260 , 13136715	
	1,6 Turbo		01.2007	11.2010	24.5241-0430.3	330918	FLEXIBLE FREIN	55 62 260 , 13136715	
	1,7 CDTI		04.2007	11.2010	24.5241-0430.3	330918	FLEXIBLE FREIN	55 62 260 , 13136715	
			08.2004	11.2010	24.5241-0430.3	330918	FLEXIBLE FREIN	55 62 260 , 13136715	
	1,8		08.2005	11.2010	24.5241-0430.3	330918	FLEXIBLE FREIN	55 62 260 , 13136715	
			09.2004	11.2010	24.5241-0430.3	330918	FLEXIBLE FREIN	55 62 260 , 13136715	
	1,9 CDTI		08.2004	11.2010	24.5241-0430.3	330918	FLEXIBLE FREIN	55 62 260 , 13136715	
			09.2004	11.2010	24.5241-0430.3	330918	FLEXIBLE FREIN	55 62 260 , 13136715	
			09.2005	11.2010	24.5241-0430.3	330918	FLEXIBLE FREIN	55 62 260 , 13136715	
	2,0 Turbo		08.2004	11.2010	24.5241-0430.3	330918	FLEXIBLE FREIN	55 62 260 , 13136715	
			09.2004	11.2010	24.5241-0430.3	330918	FLEXIBLE FREIN	55 62 260 , 13136715	
ASTRA H TwinTop (06-)	1,6		03.2006		24.5241-0430.3	330918	FLEXIBLE FREIN	55 62 260 , 13136715	
			12.2006		24.5241-0430.3	330918	FLEXIBLE FREIN	55 62 260 , 13136715	
	1,6 Turbo		02.2007		24.5241-0430.3	330918	FLEXIBLE FREIN	55 62 260 , 13136715	
	1,8		03.2006		24.5241-0430.3	330918	FLEXIBLE FREIN	55 62 260 , 13136715	
	1,9 CDTI		03.2006		24.5241-0430.3	330918	FLEXIBLE FREIN	55 62 260 , 13136715	
	2,0 Turbo		03.2006		24.5241-0430.3	330918	FLEXIBLE FREIN	55 62 260 , 13136715	



					description	Références OE par référence ATE.	 Références remplacées / divers
---	---	---	---	---	--------------------	---	--

OPEL

FRONTERA B (98-04)	2,2 DTI		10.1998	02.2004	24.5277-0420.3	330944	FLEXIBLE FREIN	97124879 , 5 62 339	
	2,2 i		10.1998	02.2004	24.5277-0420.3	330944	FLEXIBLE FREIN	97124879 , 5 62 339	
	3,2 i		10.1998	02.2004	24.5277-0420.3	330944	FLEXIBLE FREIN	97124879 , 5 62 339	
ZAFIRA II / Vauxhall Zafira II (05-11)	1,6		07.2005	10.2011	24.5241-0430.3	330918	FLEXIBLE FREIN	55 62 260 , 13136715	
			12.2007	10.2011	24.5241-0430.3	330918	FLEXIBLE FREIN	55 62 260 , 13136715	
	1,6 CNG		01.2006	10.2011	24.5241-0430.3	330918	FLEXIBLE FREIN	55 62 260 , 13136715	
	1,6 CNG Turbo		02.2009	10.2011	24.5241-0430.3	330918	FLEXIBLE FREIN	55 62 260 , 13136715	
	1,7 CDTI		12.2007	10.2011	24.5241-0430.3	330918	FLEXIBLE FREIN	55 62 260 , 13136715	
	1,8		07.2005	10.2011	24.5241-0430.3	330918	FLEXIBLE FREIN	55 62 260 , 13136715	
	1,9 CDTI		07.2005	10.2011	24.5241-0430.3	330918	FLEXIBLE FREIN	55 62 260 , 13136715	
	2		07.2005	10.2011	24.5241-0430.3	330918	FLEXIBLE FREIN	55 62 260 , 13136715	
	2,0 Turbo		07.2005	10.2011	24.5241-0430.3	330918	FLEXIBLE FREIN	55 62 260 , 13136715	
	2,2		07.2005	10.2011	24.5241-0430.3	330918	FLEXIBLE FREIN	55 62 260 , 13136715	

Nouvelles références disponibles - par applications

02/2012



					description	Références OE par référence ATE.		Références remplacées / divers
--	--	--	--	--	-------------	----------------------------------	--	--------------------------------

PEUGEOT

107 (05-)	1	AvG	06.2005		24.5295-0496.3	331033	FLEXIBLE FREIN	4806 E2 , 90947-W2003	
	1,4 HDi	AvG	06.2005		24.5295-0496.3	331033	FLEXIBLE FREIN	4806 E2 , 90947-W2003	
4007 (07-)	2,2 HDi	AvD	02.2007		24.5286-0601.3	331174	FLEXIBLE FREIN	4806 H9	
	2,4	AvD	07.2007		24.5286-0601.3	331174	FLEXIBLE FREIN	4806 H9	
407 Coupé (05-)	2,0 HDi	ArG	06.2009		24.5151-0583.3	331019	FLEXIBLE FREIN	4806 E7	
		ArD	06.2009		24.5151-0639.3	331142	FLEXIBLE FREIN	4806 K3	
		ArG	07.2007		24.5151-0638.3	331141	FLEXIBLE FREIN	4806 K2	
		ArG	06.2009		24.5151-0638.3	331141	FLEXIBLE FREIN	4806 K2	
		ArG	07.2007		24.5151-0583.3	331019	FLEXIBLE FREIN	4806 E7	
		ArD	07.2007		24.5151-0639.3	331142	FLEXIBLE FREIN	4806 K3	
		ArD	06.2009		24.5151-0584.3	331020	FLEXIBLE FREIN	4806 E8	
		ArD	07.2007		24.5151-0584.3	331020	FLEXIBLE FREIN	4806 E8	
	2,2 16V	ArD	10.2005		24.5151-0584.3	331020	FLEXIBLE FREIN	4806 E8	
		ArG	10.2005		24.5151-0638.3	331141	FLEXIBLE FREIN	4806 K2	
		ArD	10.2005		24.5151-0639.3	331142	FLEXIBLE FREIN	4806 K3	
		ArG	10.2005		24.5151-0583.3	331019	FLEXIBLE FREIN	4806 E7	
	2,7 HDi	ArG	10.2005		24.5151-0583.3	331019	FLEXIBLE FREIN	4806 E7	
		ArD	10.2005		24.5151-0584.3	331020	FLEXIBLE FREIN	4806 E8	
		ArD	10.2005		24.5151-0639.3	331142	FLEXIBLE FREIN	4806 K3	

Nouvelles références disponibles - par applications

02/2012



					description	Références OE par référence ATE.		Références remplacées / divers
--	--	--	--	--	-------------	----------------------------------	--	--------------------------------

PEUGEOT

407 Coupé (05-)	2,7 HDi	ArG	10.2005		24.5151-0638.3	331141	FLEXIBLE FREIN	4806 K2	
	3,0 HDi	ArG	06.2009		24.5151-0583.3	331019	FLEXIBLE FREIN	4806 E7	
		ArD	06.2009		24.5151-0584.3	331020	FLEXIBLE FREIN	4806 E8	
		ArG	06.2009		24.5151-0638.3	331141	FLEXIBLE FREIN	4806 K2	
		ArD	06.2009		24.5151-0639.3	331142	FLEXIBLE FREIN	4806 K3	
	3,0 V6	ArD	10.2005		24.5151-0584.3	331020	FLEXIBLE FREIN	4806 E8	
		ArG	10.2005		24.5151-0583.3	331019	FLEXIBLE FREIN	4806 E7	
		ArG	10.2005		24.5151-0638.3	331141	FLEXIBLE FREIN	4806 K2	
		ArD	10.2005		24.5151-0639.3	331142	FLEXIBLE FREIN	4806 K3	
407 Limousine (04-11)	1,6 HDi 110	ArD	05.2004		24.5151-0584.3	331020	FLEXIBLE FREIN	4806 E8	
		ArG		02.2011	24.5151-0638.3	331141	FLEXIBLE FREIN	4806 K2	
		ArD		02.2011	24.5151-0639.3	331142	FLEXIBLE FREIN	4806 K3	
		ArG	05.2004		24.5151-0583.3	331019	FLEXIBLE FREIN	4806 E7	
	1,8 16V	ArD	09.2005		24.5151-0584.3	331020	FLEXIBLE FREIN	4806 E8	
		ArD	05.2004		24.5151-0584.3	331020	FLEXIBLE FREIN	4806 E8	
		ArD		02.2011	24.5151-0639.3	331142	FLEXIBLE FREIN	4806 K3	
		ArG		02.2011	24.5151-0638.3	331141	FLEXIBLE FREIN	4806 K2	
		ArG	09.2005		24.5151-0583.3	331019	FLEXIBLE FREIN	4806 E7	
		ArG	05.2004		24.5151-0583.3	331019	FLEXIBLE FREIN	4806 E7	



					description	Références OE par référence ATE.		Références remplacées / divers
--	--	--	--	--	-------------	----------------------------------	--	--------------------------------

PEUGEOT

407 Limousine (04-11)	2,0 16V	ArG	09.2005		24.5151-0583.3	331019	FLEXIBLE FREIN	4806 E7
		ArG	05.2004		24.5151-0583.3	331019	FLEXIBLE FREIN	4806 E7
		ArG		02.2011	24.5151-0638.3	331141	FLEXIBLE FREIN	4806 K2
		ArD	05.2004		24.5151-0584.3	331020	FLEXIBLE FREIN	4806 E8
		ArD		02.2011	24.5151-0639.3	331142	FLEXIBLE FREIN	4806 K3
		ArD	09.2005		24.5151-0584.3	331020	FLEXIBLE FREIN	4806 E8
	2,0 Bioflex	ArD	09.2007		24.5151-0639.3	331142	FLEXIBLE FREIN	4806 K3
		ArG	09.2007		24.5151-0638.3	331141	FLEXIBLE FREIN	4806 K2
	2,0 HDi 135	ArD		02.2011	24.5151-0639.3	331142	FLEXIBLE FREIN	4806 K3
		ArD	05.2004		24.5151-0584.3	331020	FLEXIBLE FREIN	4806 E8
		ArG		02.2011	24.5151-0638.3	331141	FLEXIBLE FREIN	4806 K2
		ArG	05.2004		24.5151-0583.3	331019	FLEXIBLE FREIN	4806 E7
	2,0 HDi 140	ArD		02.2011	24.5151-0639.3	331142	FLEXIBLE FREIN	4806 K3
		ArG	08.2008		24.5151-0583.3	331019	FLEXIBLE FREIN	4806 E7
		ArD	08.2008		24.5151-0584.3	331020	FLEXIBLE FREIN	4806 E8
		ArG		02.2011	24.5151-0638.3	331141	FLEXIBLE FREIN	4806 K2
	2,2 16V	ArD	05.2004		24.5151-0584.3	331020	FLEXIBLE FREIN	4806 E8
		ArG		02.2011	24.5151-0638.3	331141	FLEXIBLE FREIN	4806 K2
		ArG	09.2005		24.5151-0583.3	331019	FLEXIBLE FREIN	4806 E7

Nouvelles références disponibles - par applications

02/2012



					description	Références OE par référence ATE.		Références remplacées / divers
--	--	--	--	--	-------------	----------------------------------	--	--------------------------------

PEUGEOT

407 Limousine (04-11)	2,2 16V	ArG	05.2004		24.5151-0583.3	331019	FLEXIBLE FREIN	4806 E7	
		ArD	09.2005		24.5151-0584.3	331020	FLEXIBLE FREIN	4806 E8	
		ArD		02.2011	24.5151-0639.3	331142	FLEXIBLE FREIN	4806 K3	
	2,2 HDi	ArG		02.2011	24.5151-0638.3	331141	FLEXIBLE FREIN	4806 K2	
		ArD		02.2011	24.5151-0639.3	331142	FLEXIBLE FREIN	4806 K3	
		ArG	06.2008		24.5151-0583.3	331019	FLEXIBLE FREIN	4806 E7	
		ArD	06.2008		24.5151-0584.3	331020	FLEXIBLE FREIN	4806 E8	
	2,2 HDi 170	ArG	05.2006		24.5151-0583.3	331019	FLEXIBLE FREIN	4806 E7	
		ArG		02.2011	24.5151-0638.3	331141	FLEXIBLE FREIN	4806 K2	
		ArD		02.2011	24.5151-0639.3	331142	FLEXIBLE FREIN	4806 K3	
		ArD	05.2006		24.5151-0584.3	331020	FLEXIBLE FREIN	4806 E8	
	2,7 HDi	ArD		02.2011	24.5151-0639.3	331142	FLEXIBLE FREIN	4806 K3	
		ArG		02.2011	24.5151-0638.3	331141	FLEXIBLE FREIN	4806 K2	
		ArD	10.2005		24.5151-0584.3	331020	FLEXIBLE FREIN	4806 E8	
		ArG	10.2005		24.5151-0583.3	331019	FLEXIBLE FREIN	4806 E7	
	3,0 V6	ArD	05.2004		24.5151-0584.3	331020	FLEXIBLE FREIN	4806 E8	
		ArG		02.2011	24.5151-0638.3	331141	FLEXIBLE FREIN	4806 K2	
		ArD		02.2011	24.5151-0639.3	331142	FLEXIBLE FREIN	4806 K3	
		ArG	05.2004		24.5151-0583.3	331019	FLEXIBLE FREIN	4806 E7	

Nouvelles références disponibles - par applications

02/2012



					description	Références OE par référence ATE.		Références remplacées / divers
--	--	--	--	--	-------------	----------------------------------	--	--------------------------------

PEUGEOT

Modèle	Moteur	Code	Date	ATE Ref.	ATE Ref.	Description	Ref. OE	
407 SW (04-11)	1,6 HDi 110	ArD		02.2011	24.5151-0639.3	331142	FLEXIBLE FREIN	4806 K3
		ArD	05.2004		24.5151-0584.3	331020	FLEXIBLE FREIN	4806 E8
		ArG	05.2004		24.5151-0583.3	331019	FLEXIBLE FREIN	4806 E7
		ArG		02.2011	24.5151-0638.3	331141	FLEXIBLE FREIN	4806 K2
	1,8 16V	ArG		02.2011	24.5151-0638.3	331141	FLEXIBLE FREIN	4806 K2
		ArG	05.2004		24.5151-0583.3	331019	FLEXIBLE FREIN	4806 E7
		ArD	05.2004		24.5151-0584.3	331020	FLEXIBLE FREIN	4806 E8
		ArD		02.2011	24.5151-0639.3	331142	FLEXIBLE FREIN	4806 K3
		ArG	09.2005		24.5151-0583.3	331019	FLEXIBLE FREIN	4806 E7
		ArD	09.2005		24.5151-0584.3	331020	FLEXIBLE FREIN	4806 E8
		ArG	09.2005		24.5151-0583.3	331019	FLEXIBLE FREIN	4806 E7
		ArD	09.2005		24.5151-0584.3	331020	FLEXIBLE FREIN	4806 E8
	2,0 16V	ArG	09.2005		24.5151-0583.3	331019	FLEXIBLE FREIN	4806 E7
		ArD	09.2005		24.5151-0584.3	331020	FLEXIBLE FREIN	4806 E8
		ArG		02.2011	24.5151-0638.3	331141	FLEXIBLE FREIN	4806 K2
		ArG	05.2004		24.5151-0583.3	331019	FLEXIBLE FREIN	4806 E7
		ArD	05.2004		24.5151-0584.3	331020	FLEXIBLE FREIN	4806 E8
		ArD		02.2011	24.5151-0639.3	331142	FLEXIBLE FREIN	4806 K3
		ArD	01.2008		24.5151-0584.3	331020	FLEXIBLE FREIN	4806 E8
		ArG	01.2008		24.5151-0583.3	331019	FLEXIBLE FREIN	4806 E7
	2,0 BioFlex	ArD		02.2011	24.5151-0639.3	331142	FLEXIBLE FREIN	4806 K3
ArD			02.2011	24.5151-0639.3	331142	FLEXIBLE FREIN	4806 K3	

Nouvelles références disponibles - par applications

02/2012



					description	Références OE par référence ATE.		Références remplacées / divers
--	--	--	--	--	-------------	----------------------------------	--	--------------------------------

PEUGEOT

407 SW (04-11)	2,0 BioFlex	ArG		02.2011	24.5151-0638.3	331141	FLEXIBLE FREIN	4806 K2	
	2,0 HDi	ArG		02.2011	24.5151-0638.3	331141	FLEXIBLE FREIN	4806 K2	
		ArG	05.2004		24.5151-0583.3	331019	FLEXIBLE FREIN	4806 E7	
		ArD	05.2004		24.5151-0584.3	331020	FLEXIBLE FREIN	4806 E8	
		ArD		02.2011	24.5151-0639.3	331142	FLEXIBLE FREIN	4806 K3	
	2,0 HDi 135	ArG		02.2011	24.5151-0638.3	331141	FLEXIBLE FREIN	4806 K2	
		ArG	05.2004		24.5151-0583.3	331019	FLEXIBLE FREIN	4806 E7	
		ArD	05.2004		24.5151-0584.3	331020	FLEXIBLE FREIN	4806 E8	
		ArD		02.2011	24.5151-0639.3	331142	FLEXIBLE FREIN	4806 K3	
		AvG	05.2004	02.2011	11.9601-9731.2	220853	ETRIER A GRIFFE	4400 V3	
		AvD	05.2004	02.2011	11.9601-9732.2	220854	ETRIER A GRIFFE	4400 V4	
	2,0 HDi 140	ArG		02.2011	24.5151-0638.3	331141	FLEXIBLE FREIN	4806 K2	
		ArD		02.2011	24.5151-0639.3	331142	FLEXIBLE FREIN	4806 K3	
		ArD	08.2008		24.5151-0584.3	331020	FLEXIBLE FREIN	4806 E8	
		ArG	08.2008		24.5151-0583.3	331019	FLEXIBLE FREIN	4806 E7	
	2,2 16V	ArG	09.2005		24.5151-0583.3	331019	FLEXIBLE FREIN	4806 E7	
		ArD	09.2005		24.5151-0584.3	331020	FLEXIBLE FREIN	4806 E8	
		ArD	05.2004		24.5151-0584.3	331020	FLEXIBLE FREIN	4806 E8	
		ArD		02.2011	24.5151-0639.3	331142	FLEXIBLE FREIN	4806 K3	

Nouvelles références disponibles - par applications

02/2012



					description	Références OE par référence ATE.		Références remplacées / divers
--	--	--	--	--	-------------	----------------------------------	--	--------------------------------

PEUGEOT

407 SW (04-11)	2,2 16V	ArG	05.2004		24.5151-0583.3	331019	FLEXIBLE FREIN	4806 E7	
		ArG		02.2011	24.5151-0638.3	331141	FLEXIBLE FREIN	4806 K2	
	2,2 HDi	ArG	06.2008		24.5151-0583.3	331019	FLEXIBLE FREIN	4806 E7	
		ArD		02.2011	24.5151-0639.3	331142	FLEXIBLE FREIN	4806 K3	
		ArG		02.2011	24.5151-0638.3	331141	FLEXIBLE FREIN	4806 K2	
		ArD	06.2008		24.5151-0584.3	331020	FLEXIBLE FREIN	4806 E8	
	2,2 HDi 170	ArD	05.2006		24.5151-0584.3	331020	FLEXIBLE FREIN	4806 E8	
		ArG		02.2011	24.5151-0638.3	331141	FLEXIBLE FREIN	4806 K2	
		ArG	05.2006		24.5151-0583.3	331019	FLEXIBLE FREIN	4806 E7	
		ArD		02.2011	24.5151-0639.3	331142	FLEXIBLE FREIN	4806 K3	
	2,7 HDi	ArD		02.2011	24.5151-0639.3	331142	FLEXIBLE FREIN	4806 K3	
		ArG		02.2011	24.5151-0638.3	331141	FLEXIBLE FREIN	4806 K2	
		ArG	10.2005		24.5151-0583.3	331019	FLEXIBLE FREIN	4806 E7	
		ArD	10.2005		24.5151-0584.3	331020	FLEXIBLE FREIN	4806 E8	
	3,0 V6	ArG		02.2011	24.5151-0638.3	331141	FLEXIBLE FREIN	4806 K2	
		ArD	05.2004		24.5151-0584.3	331020	FLEXIBLE FREIN	4806 E8	
		ArD		02.2011	24.5151-0639.3	331142	FLEXIBLE FREIN	4806 K3	
		ArG	05.2004		24.5151-0583.3	331019	FLEXIBLE FREIN	4806 E7	
508 (10-)	1,6 HDi	ArD	11.2010		24.5151-0639.3	331142	FLEXIBLE FREIN	4806 K3	

Nouvelles références disponibles - par applications

02/2012



					description	Références OE par référence ATE.		Références remplacées / divers
--	--	--	--	--	-------------	----------------------------------	--	--------------------------------







PEUGEOT

508 (10-)	1,6 HDi	ArG	11.2010		24.5151-0638.3	331141	FLEXIBLE FREIN	4806 K2	
	1,6 THP	ArD	11.2010		24.5151-0639.3	331142	FLEXIBLE FREIN	4806 K3	
		ArG	11.2010		24.5151-0638.3	331141	FLEXIBLE FREIN	4806 K2	
	1,6 VTi	ArG	11.2010		24.5151-0638.3	331141	FLEXIBLE FREIN	4806 K2	
		ArD	11.2010		24.5151-0639.3	331142	FLEXIBLE FREIN	4806 K3	
	2,0 HDi	ArG	11.2010		24.5151-0638.3	331141	FLEXIBLE FREIN	4806 K2	
		ArD	11.2010		24.5151-0639.3	331142	FLEXIBLE FREIN	4806 K3	
	2,2 HDi	ArG	11.2010		24.5151-0638.3	331141	FLEXIBLE FREIN	4806 K2	
		ArD	11.2010		24.5151-0639.3	331142	FLEXIBLE FREIN	4806 K3	
508 SW (10-)	1,6 HDi	ArG	11.2010		24.5151-0638.3	331141	FLEXIBLE FREIN	4806 K2	
		ArD	11.2010		24.5151-0639.3	331142	FLEXIBLE FREIN	4806 K3	
	1,6 THP	ArD	11.2010		24.5151-0639.3	331142	FLEXIBLE FREIN	4806 K3	
		ArG	11.2010		24.5151-0638.3	331141	FLEXIBLE FREIN	4806 K2	
	1,6 VTi	ArD	11.2010		24.5151-0639.3	331142	FLEXIBLE FREIN	4806 K3	
		ArG	11.2010		24.5151-0638.3	331141	FLEXIBLE FREIN	4806 K2	
	2,0 HDi	ArG	11.2010		24.5151-0638.3	331141	FLEXIBLE FREIN	4806 K2	
		ArD	11.2010		24.5151-0639.3	331142	FLEXIBLE FREIN	4806 K3	
	2,2 HDi	ArD	11.2010		24.5151-0639.3	331142	FLEXIBLE FREIN	4806 K3	
		ArG	11.2010		24.5151-0638.3	331141	FLEXIBLE FREIN	4806 K2	

Nouvelles références disponibles - par applications

02/2012



		 		description	Références OE par référence ATE.	 Références remplacées / divers
---	---	---	---	--------------------	---	---

PEUGEOT

Modèle	Motorisation	Date	ATE Ref. 1	ATE Ref. 2	Description	Références OE
807 (02-)	2,2 HDi	10.2007	24.5144-0500.3	331169	FLEXIBLE FREIN	4806 J6
EXPERT Tepee (07-)	1,6 HDi 90		24.5239-0240.3	331170	FLEXIBLE FREIN	4806 H5
		01.2007	24.5239-0260.3	331171	FLEXIBLE FREIN	4806 H1
	2,0 HDi 120		24.5239-0240.3	331170	FLEXIBLE FREIN	4806 H5
		01.2007	24.5239-0260.3	331171	FLEXIBLE FREIN	4806 H1
	2,0 HDi 140	01.2007	24.5239-0260.3	331171	FLEXIBLE FREIN	4806 H1
			24.5239-0240.3	331170	FLEXIBLE FREIN	4806 H5
	2,0 i	01.2007	24.5239-0260.3	331171	FLEXIBLE FREIN	4806 H1
			24.5239-0240.3	331170	FLEXIBLE FREIN	4806 H5

Nouvelles références disponibles - par applications

02/2012



					description	Références OE par référence ATE.		Références remplacées / divers
--	--	--	--	--	-------------	----------------------------------	--	--------------------------------

SEAT

ALHAMBRA II (10-)	1,4 TSI	AvD	09.2010		11.9571-9760.2	220848	ETRIER A GRIFFE	5N0 615 124	
	2,0 TDI	AvD	04.2011		11.9571-9760.2	220848	ETRIER A GRIFFE	5N0 615 124	
		AvD	09.2010		11.9571-9760.2	220848	ETRIER A GRIFFE	5N0 615 124	
	2,0 TDI 4motion	AvD	04.2011		11.9571-9760.2	220848	ETRIER A GRIFFE	5N0 615 124	
	2,0 TSI	AvD	09.2010		11.9571-9760.2	220848	ETRIER A GRIFFE	5N0 615 124	
LEON II (1P1) (05-)	1,2 TSI		02.2010		83.7849-0502.3	331125	FLEXIBLE FREIN	1K0 611 701 N, 1K0 611 701 L, 1K0 611 701 A, 1Q0 611 701 E, 1K0 611 701 C, 1K0 611 701 J	83.7849-0504.3
	1,4 i 16V		08.2005		83.7849-0502.3	331125	FLEXIBLE FREIN	1K0 611 701 N, 1K0 611 701 L, 1K0 611 701 A, 1Q0 611 701 E, 1K0 611 701 C, 1K0 611 701 J	83.7849-0504.3
			06.2006		83.7849-0502.3	331125	FLEXIBLE FREIN	1K0 611 701 N, 1K0 611 701 L, 1K0 611 701 A, 1Q0 611 701 E, 1K0 611 701 C, 1K0 611 701 J	83.7849-0504.3
	1,4 TSI		11.2007		83.7849-0502.3	331125	FLEXIBLE FREIN	1K0 611 701 N, 1K0 611 701 L, 1K0 611 701 A, 1Q0 611 701 E, 1K0 611 701 C, 1K0 611 701 J	83.7849-0504.3
	1,6 i		08.2005		83.7849-0502.3	331125	FLEXIBLE FREIN	1K0 611 701 N, 1K0 611 701 L, 1K0 611 701 A, 1Q0 611 701 E, 1K0 611 701 C, 1K0 611 701 J	83.7849-0504.3
	1,6 i 16V		08.2005		83.7849-0502.3	331125	FLEXIBLE FREIN	1K0 611 701 N, 1K0 611 701 L, 1K0 611 701 A, 1Q0 611 701 E, 1K0 611 701 C, 1K0 611 701 J	83.7849-0504.3

Nouvelles références disponibles - par applications

02/2012









					description	Références OE par référence ATE.		Références remplacées / divers
--	--	--	--	--	-------------	----------------------------------	--	--------------------------------

SEAT

LEON II (1P1) (05-)	1,6 LPG		12.2009		83.7849-0502.3	331125	FLEXIBLE FREIN	1K0 611 701 N, 1K0 611 701 L, 1K0 611 701 A, 1Q0 611 701 E, 1K0 611 701 C, 1K0 611 701 J	83.7849-0504.3
	1,6 TDI		11.2010		83.7849-0502.3	331125	FLEXIBLE FREIN	1K0 611 701 N, 1K0 611 701 L, 1K0 611 701 A, 1Q0 611 701 E, 1K0 611 701 C, 1K0 611 701 J	83.7849-0504.3
	1,6 TDI Ecomotive		02.2010		83.7849-0502.3	331125	FLEXIBLE FREIN	1K0 611 701 N, 1K0 611 701 L, 1K0 611 701 A, 1Q0 611 701 E, 1K0 611 701 C, 1K0 611 701 J	83.7849-0504.3
	1,8 T 20V		08.2005		83.7849-0502.3	331125	FLEXIBLE FREIN	1K0 611 701 N, 1K0 611 701 L, 1K0 611 701 A, 1Q0 611 701 E, 1K0 611 701 C, 1K0 611 701 J	83.7849-0504.3
	1,8 TSI		06.2007		83.7849-0502.3	331125	FLEXIBLE FREIN	1K0 611 701 N, 1K0 611 701 L, 1K0 611 701 A, 1Q0 611 701 E, 1K0 611 701 C, 1K0 611 701 J	83.7849-0504.3
	1,9 TDI		08.2005		83.7849-0502.3	331125	FLEXIBLE FREIN	1K0 611 701 N, 1K0 611 701 L, 1K0 611 701 A, 1Q0 611 701 E, 1K0 611 701 C, 1K0 611 701 J	83.7849-0504.3
	2,0 FSI		08.2005		83.7849-0502.3	331125	FLEXIBLE FREIN	1K0 611 701 N, 1K0 611 701 L, 1K0 611 701 A, 1Q0 611 701 E, 1K0 611 701 C, 1K0 611 701 J	83.7849-0504.3
	2,0 i 16V		08.2005		83.7849-0502.3	331125	FLEXIBLE FREIN	1K0 611 701 N, 1K0 611 701 L, 1K0 611 701 A, 1Q0 611 701 E, 1K0 611 701 C, 1K0 611 701 J	83.7849-0504.3









					description	Références OE par référence ATE.		Références remplacées / divers
---	---	---	---	---	-------------	----------------------------------	---	--------------------------------

SEAT

LEON II (1P1) (05-)	2,0 TDI		08.2005		83.7849-0502.3	331125	FLEXIBLE FREIN	1K0 611 701 N, 1K0 611 701 L, 1K0 611 701 A, 1Q0 611 701 E, 1K0 611 701 C, 1K0 611 701 J	83.7849-0504.3
			02.2006		83.7849-0502.3	331125	FLEXIBLE FREIN	1K0 611 701 N, 1K0 611 701 L, 1K0 611 701 A, 1Q0 611 701 E, 1K0 611 701 C, 1K0 611 701 J	83.7849-0504.3
	2,0 TFSI		08.2005		83.7849-0502.3	331125	FLEXIBLE FREIN	1K0 611 701 N, 1K0 611 701 L, 1K0 611 701 A, 1Q0 611 701 E, 1K0 611 701 C, 1K0 611 701 J	83.7849-0504.3
			09.2005		83.7849-0502.3	331125	FLEXIBLE FREIN	1K0 611 701 N, 1K0 611 701 L, 1K0 611 701 A, 1Q0 611 701 E, 1K0 611 701 C, 1K0 611 701 J	83.7849-0504.3
			11.2006		83.7849-0502.3	331125	FLEXIBLE FREIN	1K0 611 701 N, 1K0 611 701 L, 1K0 611 701 A, 1Q0 611 701 E, 1K0 611 701 C, 1K0 611 701 J	83.7849-0504.3



					description	Références OE par référence ATE.		Références remplacées / divers
---	---	---	---	---	-------------	-------------------------------------	---	-----------------------------------

SKODA

SUPERB II (08-)	1,4 TSI		08.2008		83.7849-0502.3	331125	FLEXIBLE FREIN	1K0 611 701 N, 1K0 611 701 L, 1K0 611 701 A, 1Q0 611 701 E, 1K0 611 701 C, 1K0 611 701 J	83.7849-0504.3
	1,6 i 16V		08.2008		83.7849-0502.3	331125	FLEXIBLE FREIN	1K0 611 701 N, 1K0 611 701 L, 1K0 611 701 A, 1Q0 611 701 E, 1K0 611 701 C, 1K0 611 701 J	83.7849-0504.3
	1,6 TDI		09.2010		83.7849-0502.3	331125	FLEXIBLE FREIN	1K0 611 701 N, 1K0 611 701 L, 1K0 611 701 A, 1Q0 611 701 E, 1K0 611 701 C, 1K0 611 701 J	83.7849-0504.3
	1,8 TFSI		08.2008		83.7849-0502.3	331125	FLEXIBLE FREIN	1K0 611 701 N, 1K0 611 701 L, 1K0 611 701 A, 1Q0 611 701 E, 1K0 611 701 C, 1K0 611 701 J	83.7849-0504.3
	1,8 TFSI 4x4		10.2008		83.7849-0502.3	331125	FLEXIBLE FREIN	1K0 611 701 N, 1K0 611 701 L, 1K0 611 701 A, 1Q0 611 701 E, 1K0 611 701 C, 1K0 611 701 J	83.7849-0504.3
	1,9 TDI		08.2008		83.7849-0502.3	331125	FLEXIBLE FREIN	1K0 611 701 N, 1K0 611 701 L, 1K0 611 701 A, 1Q0 611 701 E, 1K0 611 701 C, 1K0 611 701 J	83.7849-0504.3
	2,0 TDI		08.2008		83.7849-0502.3	331125	FLEXIBLE FREIN	1K0 611 701 N, 1K0 611 701 L, 1K0 611 701 A, 1Q0 611 701 E, 1K0 611 701 C, 1K0 611 701 J	83.7849-0504.3
	2,0 TDI 4x4		10.2008		83.7849-0502.3	331125	FLEXIBLE FREIN	1K0 611 701 N, 1K0 611 701 L, 1K0 611 701 A, 1Q0 611 701 E, 1K0 611 701 C, 1K0 611 701 J	83.7849-0504.3









					description	Références OE par référence ATE.		Références remplacées / divers
--	--	--	--	--	-------------	----------------------------------	--	--------------------------------

SKODA

SUPERB II (08-)	2,0 TSI		05.2010		83.7849-0502.3	331125	FLEXIBLE FREIN	1K0 611 701 N, 1K0 611 701 L, 1K0 611 701 A, 1Q0 611 701 E, 1K0 611 701 C, 1K0 611 701 J	83.7849-0504.3
	3,6 FSI V6 4x4		10.2008		83.7849-0502.3	331125	FLEXIBLE FREIN	1K0 611 701 N, 1K0 611 701 L, 1K0 611 701 A, 1Q0 611 701 E, 1K0 611 701 C, 1K0 611 701 J	83.7849-0504.3
SUPERB Break (09-)	1,4 TSI		11.2009		83.7849-0502.3	331125	FLEXIBLE FREIN	1K0 611 701 N, 1K0 611 701 L, 1K0 611 701 A, 1Q0 611 701 E, 1K0 611 701 C, 1K0 611 701 J	83.7849-0504.3
	1,6 TDI		09.2010		83.7849-0502.3	331125	FLEXIBLE FREIN	1K0 611 701 N, 1K0 611 701 L, 1K0 611 701 A, 1Q0 611 701 E, 1K0 611 701 C, 1K0 611 701 J	83.7849-0504.3
	1,8 TSI		11.2009		83.7849-0502.3	331125	FLEXIBLE FREIN	1K0 611 701 N, 1K0 611 701 L, 1K0 611 701 A, 1Q0 611 701 E, 1K0 611 701 C, 1K0 611 701 J	83.7849-0504.3
	1,8 TSI 4x4		11.2009		83.7849-0502.3	331125	FLEXIBLE FREIN	1K0 611 701 N, 1K0 611 701 L, 1K0 611 701 A, 1Q0 611 701 E, 1K0 611 701 C, 1K0 611 701 J	83.7849-0504.3
	2,0 TDI		11.2009		83.7849-0502.3	331125	FLEXIBLE FREIN	1K0 611 701 N, 1K0 611 701 L, 1K0 611 701 A, 1Q0 611 701 E, 1K0 611 701 C, 1K0 611 701 J	83.7849-0504.3
	2,0 TDI 4x4		11.2009		83.7849-0502.3	331125	FLEXIBLE FREIN	1K0 611 701 N, 1K0 611 701 L, 1K0 611 701 A, 1Q0 611 701 E, 1K0 611 701 C, 1K0 611 701 J	83.7849-0504.3



					description	Références OE par référence ATE.	 Références remplacées / divers
---	---	---	---	---	--------------------	---	--

SKODA

SUPERB Break (09-)	2,0 TSI		05.2010		83.7849-0502.3	331125	FLEXIBLE FREIN	1K0 611 701 N, 1K0 611 701 L, 1K0 611 701 A, 1Q0 611 701 E, 1K0 611 701 C, 1K0 611 701 J	83.7849-0504.3
	3,6 V6 4x4		11.2009		83.7849-0502.3	331125	FLEXIBLE FREIN	1K0 611 701 N, 1K0 611 701 L, 1K0 611 701 A, 1Q0 611 701 E, 1K0 611 701 C, 1K0 611 701 J	83.7849-0504.3

SUBARU

JUSTY (G3X) (03-07)	1,3 i 16V		09.2003	08.2007	03.0137-9300.2	669300	ACC. MACHOIRE		
	1,3 i 16V 4WD		09.2003	08.2007	03.0137-9300.2	669300	ACC. MACHOIRE		
	1,5 i 16V 4WD		09.2003	08.2007	03.0137-9300.2	669300	ACC. MACHOIRE		



					description	Références OE par référence ATE.		Références remplacées / divers
--	--	--	--	--	--------------------	---	--	---------------------------------------

SUZUKI

IGNIS II (03-)	1,3 DDIS		09.2003		03.0137-9300.2	669300	ACC. MACHOIRE	
	1,5 i 16V		09.2003		03.0137-9300.2	669300	ACC. MACHOIRE	
	1,5 i 16V 4x4		09.2003		03.0137-9300.2	669300	ACC. MACHOIRE	
JIMNY (98-)	1,3 4x4	AvD	09.1998	08.2000	24.5291-0345.3	331165	FLEXIBLE FREIN	51540-81A00
		AvD	09.2000	08.2002	24.5291-0345.3	331165	FLEXIBLE FREIN	51540-81A00
	1,3 i 16V	AvD	09.1998		24.5291-0345.3	331165	FLEXIBLE FREIN	51540-81A00
		AvD	02.2001		24.5291-0345.3	331165	FLEXIBLE FREIN	51540-81A00
	1,3 i 16V 4x4	AvD	09.1998		24.5291-0345.3	331165	FLEXIBLE FREIN	51540-81A00
		AvD	08.2005		24.5291-0345.3	331165	FLEXIBLE FREIN	51540-81A00
		AvD	02.2001		24.5291-0345.3	331165	FLEXIBLE FREIN	51540-81A00
	1,5 DDiS 4x4	AvD	08.2005		24.5291-0345.3	331165	FLEXIBLE FREIN	51540-81A00
		AvD	12.2003		24.5291-0345.3	331165	FLEXIBLE FREIN	51540-81A00
SPLASH (08-)	1,0 i 12V		01.2008		24.5273-0490.3	330940	FLEXIBLE FREIN	51550-62J00
	1,2 i 16V		01.2008		24.5273-0490.3	330940	FLEXIBLE FREIN	51550-62J00
	1,3 CDTi		01.2008		24.5273-0490.3	330940	FLEXIBLE FREIN	51550-62J00
SWIFT III (05-)	1,3 16V		02.2005		24.5273-0490.3	330940	FLEXIBLE FREIN	51550-62J00
	1,3 16V 4x4		01.2006		24.5273-0490.3	330940	FLEXIBLE FREIN	51550-62J00
			02.2005		24.5273-0490.3	330940	FLEXIBLE FREIN	51550-62J00
	1,3 DDIS		08.2005		24.5273-0490.3	330940	FLEXIBLE FREIN	51550-62J00
			08.2005	09.2007	24.5273-0490.3	330940	FLEXIBLE FREIN	51550-62J00

Nouvelles références disponibles - par applications

02/2012



	i				description	Références OE par référence ATE.	i Références remplacées / divers
--	----------	--	--	--	--------------------	---	---

SUZUKI

Modèle	Motorisation	Année	Année	Code OE	Code ATE	Description	Références OE	Références ATE	
SWIFT III (05-)	1,5 16V 4x4	02.2005		24.5273-0490.3	330940	FLEXIBLE FREIN	51550-62J00		
	1,5 VVTi	02.2005		24.5273-0490.3	330940	FLEXIBLE FREIN	51550-62J00		
WAGON R+ (00-)	1,0 i 12V	06.2004		03.0137-9300.2	669300	ACC. MACHOIRE			
	1,2 i 16V	06.2004		03.0137-9300.2	669300	ACC. MACHOIRE			
	1,3 DDiS	09.2003	04.2008	03.0137-9300.2	669300	ACC. MACHOIRE			
	1,3 i 16V	09.2003		03.0137-9300.2	669300	ACC. MACHOIRE			
			08.2001		03.0137-9300.2	669300	ACC. MACHOIRE		
	1,3 i 16V 4WD	09.2003		03.0137-9300.2	669300	ACC. MACHOIRE			
	1,3 VVTi 4WD	09.2003		03.0137-9300.2	669300	ACC. MACHOIRE			

Nouvelles références disponibles - par applications

02/2012



					description	Références OE par référence ATE.		Références remplacées / divers
--	--	--	--	--	-------------	----------------------------------	--	--------------------------------

TOYOTA

AYGO (05-)	1,0 i 12V	AvG	07.2005		24.5295-0496.3	331033	FLEXIBLE FREIN	4806 E2 , 90947-W2003	
	1,0 i 12V GPL	AvG	07.2005		24.5295-0496.3	331033	FLEXIBLE FREIN	4806 E2 , 90947-W2003	
	1,4 HDi	AvG	07.2005		24.5295-0496.3	331033	FLEXIBLE FREIN	4806 E2 , 90947-W2003	
CARINA E (92-97)	1,6 i (AT190)		01.1996	09.1997	03.0137-9301.2	669301	ACC. MACHOIRE		
	1,8 i (AT191)		01.1996	09.1997	03.0137-9301.2	669301	ACC. MACHOIRE		
	2,0 D (CT190)		01.1996	09.1997	03.0137-9301.2	669301	ACC. MACHOIRE		
	2,0 i (ST191)		01.1996	09.1997	03.0137-9301.2	669301	ACC. MACHOIRE		
COROLLA (97-02)	1,4 i (EE111)		05.1997	01.2000	03.0137-9301.2	669301	ACC. MACHOIRE		
	1,4 i 16V (ZZE111)		02.2000	12.2001	03.0137-9301.2	669301	ACC. MACHOIRE		
	1,6 i (AE111)		05.1997	01.2000	03.0137-9301.2	669301	ACC. MACHOIRE		
	1,6 i 16V (ZZE112)		02.2000	12.2001	03.0137-9301.2	669301	ACC. MACHOIRE		
	1,8 i 16V AWD (AE115)		05.1997	12.2001	03.0137-9301.2	669301	ACC. MACHOIRE		
	1,9 D (WZE110)		02.2000	12.2001	03.0137-9301.2	669301	ACC. MACHOIRE		
	2,0 D (CE110)		05.1997	01.2000	03.0137-9301.2	669301	ACC. MACHOIRE		
HIACE (06-)	2,5 D-4D	AvG	09.2006		24.5265-0263.3	331157	FLEXIBLE FREIN	90947-02C15	
		AvD	09.2006		24.5265-0264.3	331158	FLEXIBLE FREIN	90947-02C16	









				description	Références OE par référence ATE.	Références remplacées / divers
--	--	--	--	--------------------	---	---

VOLKSWAGEN

EOS (06-)	1,4 TSI		10.2007		83.7849-0502.3	331125	FLEXIBLE FREIN	1K0 611 701 N, 1K0 611 701 L, 1K0 611 701 A, 1Q0 611 701 E, 1K0 611 701 C, 1K0 611 701 J	83.7849-0504.3
	1,6 FSI		05.2006		83.7849-0502.3	331125	FLEXIBLE FREIN	1K0 611 701 N, 1K0 611 701 L, 1K0 611 701 A, 1Q0 611 701 E, 1K0 611 701 C, 1K0 611 701 J	83.7849-0504.3
	2,0 FSI		05.2006		83.7849-0502.3	331125	FLEXIBLE FREIN	1K0 611 701 N, 1K0 611 701 L, 1K0 611 701 A, 1Q0 611 701 E, 1K0 611 701 C, 1K0 611 701 J	83.7849-0504.3
	2,0 TDI		05.2006		83.7849-0502.3	331125	FLEXIBLE FREIN	1K0 611 701 N, 1K0 611 701 L, 1K0 611 701 A, 1Q0 611 701 E, 1K0 611 701 C, 1K0 611 701 J	83.7849-0504.3
	2,0 TFSI		05.2006		83.7849-0502.3	331125	FLEXIBLE FREIN	1K0 611 701 N, 1K0 611 701 L, 1K0 611 701 A, 1Q0 611 701 E, 1K0 611 701 C, 1K0 611 701 J	83.7849-0504.3
	2,0 TSI		11.2009		83.7849-0502.3	331125	FLEXIBLE FREIN	1K0 611 701 N, 1K0 611 701 L, 1K0 611 701 A, 1Q0 611 701 E, 1K0 611 701 C, 1K0 611 701 J	83.7849-0504.3
	3,2 V6		05.2006		83.7849-0502.3	331125	FLEXIBLE FREIN	1K0 611 701 N, 1K0 611 701 L, 1K0 611 701 A, 1Q0 611 701 E, 1K0 611 701 C, 1K0 611 701 J	83.7849-0504.3
	3,6 V6		05.2009		83.7849-0502.3	331125	FLEXIBLE FREIN	1K0 611 701 N, 1K0 611 701 L, 1K0 611 701 A, 1Q0 611 701 E, 1K0 611 701 C, 1K0 611 701 J	83.7849-0504.3









					description	Références OE par référence ATE.	 Références remplacées / divers
---	---	---	---	---	--------------------	---	--

VOLKSWAGEN

GOLF V (03-08)	1,9 TDI 4motion		08.2004	09.2008	83.7849-0502.3	331125	FLEXIBLE FREIN	1K0 611 701 N, 1K0 611 701 L, 1K0 611 701 A, 1Q0 611 701 E, 1K0 611 701 C, 1K0 611 701 J	83.7849-0504.3
	2,0 FSI 4motion		08.2004	09.2008	83.7849-0502.3	331125	FLEXIBLE FREIN	1K0 611 701 N, 1K0 611 701 L, 1K0 611 701 A, 1Q0 611 701 E, 1K0 611 701 C, 1K0 611 701 J	83.7849-0504.3
	2,0 TDI 4motion		08.2004	09.2008	83.7849-0502.3	331125	FLEXIBLE FREIN	1K0 611 701 N, 1K0 611 701 L, 1K0 611 701 A, 1Q0 611 701 E, 1K0 611 701 C, 1K0 611 701 J	83.7849-0504.3
	3,2 R32		11.2005	09.2008	83.7849-0502.3	331125	FLEXIBLE FREIN	1K0 611 701 N, 1K0 611 701 L, 1K0 611 701 A, 1Q0 611 701 E, 1K0 611 701 C, 1K0 611 701 J	83.7849-0504.3
GOLF VI (08-)	1,2 TSI		05.2009		83.7849-0502.3	331125	FLEXIBLE FREIN	1K0 611 701 N, 1K0 611 701 L, 1K0 611 701 A, 1Q0 611 701 E, 1K0 611 701 C, 1K0 611 701 J	83.7849-0504.3
	1,4		10.2008		83.7849-0502.3	331125	FLEXIBLE FREIN	1K0 611 701 N, 1K0 611 701 L, 1K0 611 701 A, 1Q0 611 701 E, 1K0 611 701 C, 1K0 611 701 J	83.7849-0504.3
	1,4 TSI		10.2008		83.7849-0502.3	331125	FLEXIBLE FREIN	1K0 611 701 N, 1K0 611 701 L, 1K0 611 701 A, 1Q0 611 701 E, 1K0 611 701 C, 1K0 611 701 J	83.7849-0504.3
	1,6		10.2008		83.7849-0502.3	331125	FLEXIBLE FREIN	1K0 611 701 N, 1K0 611 701 L, 1K0 611 701 A, 1Q0 611 701 E, 1K0 611 701 C, 1K0 611 701 J	83.7849-0504.3



					description	Références OE par référence ATE.	 Références remplacées / divers
---	---	---	---	---	--------------------	---	--

VOLKSWAGEN

GOLF VI (08-)	1,6 Bi-Fuel		03.2009		83.7849-0502.3	331125	FLEXIBLE FREIN	1K0 611 701 N, 1K0 611 701 L, 1K0 611 701 A, 1Q0 611 701 E, 1K0 611 701 C, 1K0 611 701 J	83.7849-0504.3
	1,6 TDI		02.2009		83.7849-0502.3	331125	FLEXIBLE FREIN	1K0 611 701 N, 1K0 611 701 L, 1K0 611 701 A, 1Q0 611 701 E, 1K0 611 701 C, 1K0 611 701 J	83.7849-0504.3
	1,8 TSI		06.2009		83.7849-0502.3	331125	FLEXIBLE FREIN	1K0 611 701 N, 1K0 611 701 L, 1K0 611 701 A, 1Q0 611 701 E, 1K0 611 701 C, 1K0 611 701 J	83.7849-0504.3
	2		03.2009		83.7849-0502.3	331125	FLEXIBLE FREIN	1K0 611 701 N, 1K0 611 701 L, 1K0 611 701 A, 1Q0 611 701 E, 1K0 611 701 C, 1K0 611 701 J	83.7849-0504.3
	2,0 R 4motion		11.2009		83.7849-0502.3	331125	FLEXIBLE FREIN	1K0 611 701 N, 1K0 611 701 L, 1K0 611 701 A, 1Q0 611 701 E, 1K0 611 701 C, 1K0 611 701 J	83.7849-0504.3
	2,0 TDI		10.2008		83.7849-0502.3	331125	FLEXIBLE FREIN	1K0 611 701 N, 1K0 611 701 L, 1K0 611 701 A, 1Q0 611 701 E, 1K0 611 701 C, 1K0 611 701 J	83.7849-0504.3
			04.2009		83.7849-0502.3	331125	FLEXIBLE FREIN	1K0 611 701 N, 1K0 611 701 L, 1K0 611 701 A, 1Q0 611 701 E, 1K0 611 701 C, 1K0 611 701 J	83.7849-0504.3
	2,0 TDI 4motion		10.2008		83.7849-0502.3	331125	FLEXIBLE FREIN	1K0 611 701 N, 1K0 611 701 L, 1K0 611 701 A, 1Q0 611 701 E, 1K0 611 701 C, 1K0 611 701 J	83.7849-0504.3









					description	Références OE par référence ATE.		Références remplacées / divers
--	--	--	--	--	-------------	----------------------------------	--	--------------------------------

VOLKSWAGEN

GOLF VI (08-)	2,0 TSI		07.2009		83.7849-0502.3	331125	FLEXIBLE FREIN	1K0 611 701 N, 1K0 611 701 L, 1K0 611 701 A, 1Q0 611 701 E, 1K0 611 701 C, 1K0 611 701 J	83.7849-0504.3
	2,5 FSI		08.2009		83.7849-0502.3	331125	FLEXIBLE FREIN	1K0 611 701 N, 1K0 611 701 L, 1K0 611 701 A, 1Q0 611 701 E, 1K0 611 701 C, 1K0 611 701 J	83.7849-0504.3
PASSAT (97-05)	2,3 4motion		10.2000	06.2005	24.5142-0290.3	330950	FLEXIBLE FREIN	3B0 611 775	
	2,5 TDI 4motion		10.2000	06.2005	24.5142-0290.3	330950	FLEXIBLE FREIN	3B0 611 775	
	2,8 4motion		10.2000	06.2005	24.5142-0290.3	330950	FLEXIBLE FREIN	3B0 611 775	
SCIROCCO (08-)	1,4 TSI		08.2008		83.7849-0502.3	331125	FLEXIBLE FREIN	1K0 611 701 N, 1K0 611 701 L, 1K0 611 701 A, 1Q0 611 701 E, 1K0 611 701 C, 1K0 611 701 J	83.7849-0504.3
			09.2008		83.7849-0502.3	331125	FLEXIBLE FREIN	1K0 611 701 N, 1K0 611 701 L, 1K0 611 701 A, 1Q0 611 701 E, 1K0 611 701 C, 1K0 611 701 J	83.7849-0504.3
	2,0 R		11.2009		83.7849-0502.3	331125	FLEXIBLE FREIN	1K0 611 701 N, 1K0 611 701 L, 1K0 611 701 A, 1Q0 611 701 E, 1K0 611 701 C, 1K0 611 701 J	83.7849-0504.3
	2,0 TDI		05.2009		83.7849-0502.3	331125	FLEXIBLE FREIN	1K0 611 701 N, 1K0 611 701 L, 1K0 611 701 A, 1Q0 611 701 E, 1K0 611 701 C, 1K0 611 701 J	83.7849-0504.3
			10.2008		83.7849-0502.3	331125	FLEXIBLE FREIN	1K0 611 701 N, 1K0 611 701 L, 1K0 611 701 A, 1Q0 611 701 E, 1K0 611 701 C, 1K0 611 701 J	83.7849-0504.3



					description	Références OE par référence ATE.	 Références remplacées / divers
---	---	---	---	---	--------------------	---	--

VOLKSWAGEN

SCIROCCO (08-)	2,0 TSI		08.2008		83.7849-0502.3	331125	FLEXIBLE FREIN	1K0 611 701 N , 1K0 611 701 L , 1K0 611 701 A , 1Q0 611 701 E , 1K0 611 701 C , 1K0 611 701 J	83.7849-0504.3
SHARAN II (10-)	1,4 TSI	AvD	07.2010		11.9571-9760.2	220848	ETRIER A GRIFFE	5N0 615 124	
	2,0 TDI	AvD	07.2010		11.9571-9760.2	220848	ETRIER A GRIFFE	5N0 615 124	
	2,0 TDI 4motion	AvD	05.2011		11.9571-9760.2	220848	ETRIER A GRIFFE	5N0 615 124	
	2,0 TSI	AvD	10.2010		11.9571-9760.2	220848	ETRIER A GRIFFE	5N0 615 124	
TIGUAN (07-)	1,4 TSI	AvD	08.2010		11.9571-9760.2	220848	ETRIER A GRIFFE	5N0 615 124	
		AvD	11.2007		11.9571-9760.2	220848	ETRIER A GRIFFE	5N0 615 124	
	1,4 TSI 4motion	AvD	09.2007		11.9571-9760.2	220848	ETRIER A GRIFFE	5N0 615 124	
	2,0 TDI	AvD	03.2008		11.9571-9760.2	220848	ETRIER A GRIFFE	5N0 615 124	
		AvD	04.2010		11.9571-9760.2	220848	ETRIER A GRIFFE	5N0 615 124	
	2,0 TDI 4motion	AvD	11.2007		11.9571-9760.2	220848	ETRIER A GRIFFE	5N0 615 124	
		AvD	01.2008		11.9571-9760.2	220848	ETRIER A GRIFFE	5N0 615 124	
	2,0 TFSI 4motion	AvD	02.2008		11.9571-9760.2	220848	ETRIER A GRIFFE	5N0 615 124	
	2,0 TSI 4motion	AvD	11.2007		11.9571-9760.2	220848	ETRIER A GRIFFE	5N0 615 124	

Ate.

13.0460-6924.2 606924

Applications:

Classic PKW LAND ROVER DEFENDER (LD) (90-)

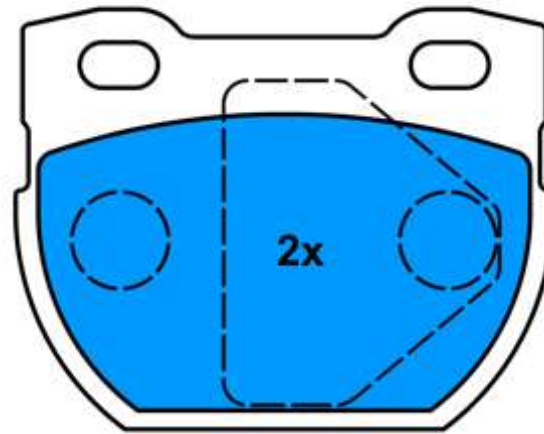
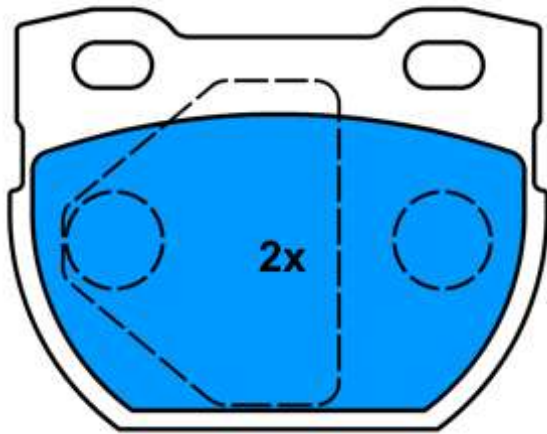

23471 17,5

23471 17,5

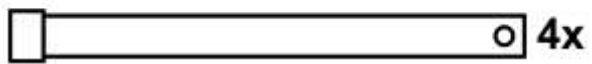

88,4 x 68,9