

Nouvelles références disponibles
par applications



09/2008



www.ate.de



| | | | | | | | | |
|--|--|--|--|--|-------------|----------------------------------|--|--------------------------------|
| | | | | | description | Références OE par référence ATE. | | Références remplacées / divers |
|--|--|--|--|--|-------------|----------------------------------|--|--------------------------------|

ALFA ROMEO

| | | | | | | | | | |
|-------------|-------------------|--|---------|---------|----------------|--------|----------------|---------------------|--|
| 156 (97-05) | 1,6 i 16V T,Spark | | 10.1997 | 07.2005 | 24.5112-0437.3 | 330886 | FLEXIBLE FREIN | 46556045 , 51700558 | |
| | 1,8 i 16V T,Spark | | 10.1997 | 07.2005 | 24.5112-0437.3 | 330886 | FLEXIBLE FREIN | 46556045 , 51700558 | |
| | 1,9 JTD | | 10.1997 | 07.2005 | 24.5112-0437.3 | 330886 | FLEXIBLE FREIN | 46556045 , 51700558 | |
| | 1,9 JTD 16V | | 11.2002 | 07.2005 | 24.5112-0437.3 | 330886 | FLEXIBLE FREIN | 46556045 , 51700558 | |
| | 2,0 i 16V T,Spark | | 10.1997 | 07.2005 | 24.5112-0437.3 | 330886 | FLEXIBLE FREIN | 46556045 , 51700558 | |
| | 2,0 JTS | | 03.2002 | 07.2005 | 24.5112-0437.3 | 330886 | FLEXIBLE FREIN | 46556045 , 51700558 | |
| | 2,4 JTD | | 10.2000 | 07.2005 | 24.5112-0437.3 | 330886 | FLEXIBLE FREIN | 46556045 , 51700558 | |
| | | | 10.1997 | 10.2000 | 24.5112-0437.3 | 330886 | FLEXIBLE FREIN | 46556045 , 51700558 | |
| | 2,5 i V6 | | 10.1997 | 07.2005 | 24.5112-0437.3 | 330886 | FLEXIBLE FREIN | 46556045 , 51700558 | |
| GT (04-) | 1,8 TS | | 11.2003 | | 24.5112-0437.3 | 330886 | FLEXIBLE FREIN | 46556045 , 51700558 | |
| | 1,9 JTD | | 11.2003 | | 24.5112-0437.3 | 330886 | FLEXIBLE FREIN | 46556045 , 51700558 | |
| | 2,0 JTS | | 11.2003 | | 24.5112-0437.3 | 330886 | FLEXIBLE FREIN | 46556045 , 51700558 | |
| | 3,2 i V6 | | 11.2003 | | 24.5112-0437.3 | 330886 | FLEXIBLE FREIN | 46556045 , 51700558 | |

Nouvelles références disponibles - par applications

09/2008



| | | | | | | | | |
|--|--|--|--|--|-------------|----------------------------------|--|--------------------------------|
| | | | | | description | Références OE par référence ATE. | | Références remplacées / divers |
|--|--|--|--|--|-------------|----------------------------------|--|--------------------------------|

AUDI

| | | | | | | | | | |
|-------------------------|----------|-----|---------|--|----------------|--------|-----------------|---|--|
| A3 / A3 Sportback (03-) | 1,4 TFSI | ArG | 07.2007 | | 24.3384-1755.7 | 220635 | ETRIER A GRIFFE | 1K0 615 423 D , 1K0 615 423 J , 1K0 615 423 A | |
| | | ArD | 07.2007 | | 24.3414-1710.7 | 220632 | ETRIER A GRIFFE | 1K0 615 424 C , 1K0 615 424 H , 1K0 615 424 F , 1K0 615 424 | |
| | | ArG | 07.2007 | | 24.3414-1709.7 | 220631 | ETRIER A GRIFFE | 1K0 615 423 C , 1K0 615 423 H , 1K0 615 423 F , 1K0 615 423 | |
| | | ArD | 07.2007 | | 24.3384-1756.7 | 220636 | ETRIER A GRIFFE | 1K0 615 424 D , 1K0 615 424 J , 1K0 615 424 A | |
| | | | 07.2007 | | 24.0325-0158.1 | 525158 | POWER-DISC | 1K0 615 301 AA | |
| | 1,6 | ArD | 05.2003 | | 24.3384-1756.7 | 220636 | ETRIER A GRIFFE | 1K0 615 424 D , 1K0 615 424 J , 1K0 615 424 A | |
| | | ArG | 05.2003 | | 24.3384-1755.7 | 220635 | ETRIER A GRIFFE | 1K0 615 423 D , 1K0 615 423 J , 1K0 615 423 A | |
| | | ArD | 05.2003 | | 24.3414-1710.7 | 220632 | ETRIER A GRIFFE | 1K0 615 424 C , 1K0 615 424 H , 1K0 615 424 F , 1K0 615 424 | |
| | | ArG | 05.2003 | | 24.3414-1709.7 | 220631 | ETRIER A GRIFFE | 1K0 615 423 C , 1K0 615 423 H , 1K0 615 423 F , 1K0 615 423 | |
| | | | 05.2003 | | 24.0325-0158.1 | 525158 | POWER-DISC | 1K0 615 301 AA | |
| | 1,6 FSI | ArD | 08.2003 | | 24.3384-1756.7 | 220636 | ETRIER A GRIFFE | 1K0 615 424 D , 1K0 615 424 J , 1K0 615 424 A | |
| | | ArG | 08.2003 | | 24.3384-1755.7 | 220635 | ETRIER A GRIFFE | 1K0 615 423 D , 1K0 615 423 J , 1K0 615 423 A | |

Nouvelles références disponibles - par applications

09/2008



| | | | | | | | | |
|--|--|--|--|--|-------------|----------------------------------|--|--------------------------------|
| | | | | | description | Références OE par référence ATE. | | Références remplacées / divers |
|--|--|--|--|--|-------------|----------------------------------|--|--------------------------------|

AUDI

| | | | | | | | | | |
|-------------------------|------------------|-----|---------|--|----------------|--------|-----------------|---|--|
| A3 / A3 Sportback (03-) | 1,6 FSI | ArG | 08.2003 | | 24.3414-1709.7 | 220631 | ETRIER A GRIFFE | 1K0 615 423 C , 1K0 615 423 H , 1K0 615 423 F , 1K0 615 423 | |
| | | ArD | 08.2003 | | 24.3414-1710.7 | 220632 | ETRIER A GRIFFE | 1K0 615 424 C , 1K0 615 424 H , 1K0 615 424 F , 1K0 615 424 | |
| | | | 08.2003 | | 24.0325-0158.1 | 525158 | POWER-DISC | 1K0 615 301 AA | |
| | 1,8 TFSI | ArD | 01.2007 | | 24.3384-1756.7 | 220636 | ETRIER A GRIFFE | 1K0 615 424 D , 1K0 615 424 J , 1K0 615 424 A | |
| | | ArG | 01.2007 | | 24.3384-1755.7 | 220635 | ETRIER A GRIFFE | 1K0 615 423 D , 1K0 615 423 J , 1K0 615 423 A | |
| | | ArG | 01.2007 | | 24.3414-1709.7 | 220631 | ETRIER A GRIFFE | 1K0 615 423 C , 1K0 615 423 H , 1K0 615 423 F , 1K0 615 423 | |
| | | ArD | 01.2007 | | 24.3414-1710.7 | 220632 | ETRIER A GRIFFE | 1K0 615 424 C , 1K0 615 424 H , 1K0 615 424 F , 1K0 615 424 | |
| | | | 01.2007 | | 24.0325-0158.1 | 525158 | POWER-DISC | 1K0 615 301 AA | |
| | 1,8 TFSI Quattro | ArD | 05.2008 | | 24.3414-1710.7 | 220632 | ETRIER A GRIFFE | 1K0 615 424 C , 1K0 615 424 H , 1K0 615 424 F , 1K0 615 424 | |
| | | ArG | 05.2008 | | 24.3414-1709.7 | 220631 | ETRIER A GRIFFE | 1K0 615 423 C , 1K0 615 423 H , 1K0 615 423 F , 1K0 615 423 | |
| | | | 05.2008 | | 24.0325-0158.1 | 525158 | POWER-DISC | 1K0 615 301 AA | |
| | 1,9 TDI | ArD | 06.2003 | | 24.3384-1756.7 | 220636 | ETRIER A GRIFFE | 1K0 615 424 D , 1K0 615 424 J , 1K0 615 424 A | |



| | | | | | | | | |
|--|--|--|--|--|-------------|----------------------------------|--|--------------------------------|
| | | | | | description | Références OE par référence ATE. | | Références remplacées / divers |
|--|--|--|--|--|-------------|----------------------------------|--|--------------------------------|

AUDI

| | | | | | | | | | |
|-------------------------|---------|-----|---------|--|----------------|--------|-----------------|---|--|
| A3 / A3 Sportback (03-) | 1,9 TDI | ArG | 06.2003 | | 24.3414-1709.7 | 220631 | ETRIER A GRIFFE | 1K0 615 423 C , 1K0 615 423 H , 1K0 615 423 F , 1K0 615 423 | |
| | | ArD | 06.2003 | | 24.3414-1710.7 | 220632 | ETRIER A GRIFFE | 1K0 615 424 C , 1K0 615 424 H , 1K0 615 424 F , 1K0 615 424 | |
| | | ArG | 06.2003 | | 24.3384-1755.7 | 220635 | ETRIER A GRIFFE | 1K0 615 423 D , 1K0 615 423 J , 1K0 615 423 A | |
| | | | 06.2003 | | 24.0325-0158.1 | 525158 | POWER-DISC | 1K0 615 301 AA | |
| | 2,0 FSI | ArD | 05.2003 | | 24.3384-1756.7 | 220636 | ETRIER A GRIFFE | 1K0 615 424 D , 1K0 615 424 J , 1K0 615 424 A | |
| | | ArD | 05.2003 | | 24.3414-1710.7 | 220632 | ETRIER A GRIFFE | 1K0 615 424 C , 1K0 615 424 H , 1K0 615 424 F , 1K0 615 424 | |
| | | ArG | 05.2003 | | 24.3384-1755.7 | 220635 | ETRIER A GRIFFE | 1K0 615 423 D , 1K0 615 423 J , 1K0 615 423 A | |
| | | ArG | 05.2003 | | 24.3414-1709.7 | 220631 | ETRIER A GRIFFE | 1K0 615 423 C , 1K0 615 423 H , 1K0 615 423 F , 1K0 615 423 | |
| | | | 05.2003 | | 24.0325-0158.1 | 525158 | POWER-DISC | 1K0 615 301 AA | |
| | 2,0 TDI | ArG | 03.2006 | | 24.3414-1709.7 | 220631 | ETRIER A GRIFFE | 1K0 615 423 C , 1K0 615 423 H , 1K0 615 423 F , 1K0 615 423 | |
| | | ArD | 03.2006 | | 24.3384-1756.7 | 220636 | ETRIER A GRIFFE | 1K0 615 424 D , 1K0 615 424 J , 1K0 615 424 A | |
| | | ArD | 05.2003 | | 24.3414-1710.7 | 220632 | ETRIER A GRIFFE | 1K0 615 424 C , 1K0 615 424 H , 1K0 615 424 F , 1K0 615 424 | |

Nouvelles références disponibles - par applications

09/2008



| | | | | | | | | |
|--|--|--|--|--|-------------|----------------------------------|--|--------------------------------|
| | | | | | description | Références OE par référence ATE. | | Références remplacées / divers |
|--|--|--|--|--|-------------|----------------------------------|--|--------------------------------|

AUDI

| | | | | | | | | | |
|-------------------------|-----------------|-----|---------|--|----------------|--------|-----------------|---|--|
| A3 / A3 Sportback (03-) | 2,0 TDI | ArG | 03.2006 | | 24.3384-1755.7 | 220635 | ETRIER A GRIFFE | 1K0 615 423 D , 1K0 615 423 J , 1K0 615 423 A | |
| | | ArG | 05.2003 | | 24.3414-1709.7 | 220631 | ETRIER A GRIFFE | 1K0 615 423 C , 1K0 615 423 H , 1K0 615 423 F , 1K0 615 423 | |
| | | ArD | 05.2003 | | 24.3384-1756.7 | 220636 | ETRIER A GRIFFE | 1K0 615 424 D , 1K0 615 424 J , 1K0 615 424 A | |
| | | ArG | 05.2003 | | 24.3384-1755.7 | 220635 | ETRIER A GRIFFE | 1K0 615 423 D , 1K0 615 423 J , 1K0 615 423 A | |
| | | ArD | 03.2006 | | 24.3414-1710.7 | 220632 | ETRIER A GRIFFE | 1K0 615 424 C , 1K0 615 424 H , 1K0 615 424 F , 1K0 615 424 | |
| | | | 03.2006 | | 24.0325-0158.1 | 525158 | POWER-DISC | 1K0 615 301 AA | |
| | | | 05.2003 | | 24.0325-0158.1 | 525158 | POWER-DISC | 1K0 615 301 AA | |
| | 2,0 TDI Quattro | ArG | 03.2006 | | 24.3414-1709.7 | 220631 | ETRIER A GRIFFE | 1K0 615 423 C , 1K0 615 423 H , 1K0 615 423 F , 1K0 615 423 | |
| | | ArG | 05.2003 | | 24.3414-1709.7 | 220631 | ETRIER A GRIFFE | 1K0 615 423 C , 1K0 615 423 H , 1K0 615 423 F , 1K0 615 423 | |
| | | ArG | 08.2004 | | 24.3414-1709.7 | 220631 | ETRIER A GRIFFE | 1K0 615 423 C , 1K0 615 423 H , 1K0 615 423 F , 1K0 615 423 | |
| | | ArD | 03.2006 | | 24.3414-1710.7 | 220632 | ETRIER A GRIFFE | 1K0 615 424 C , 1K0 615 424 H , 1K0 615 424 F , 1K0 615 424 | |
| | | ArD | 05.2003 | | 24.3414-1710.7 | 220632 | ETRIER A GRIFFE | 1K0 615 424 C , 1K0 615 424 H , 1K0 615 424 F , 1K0 615 424 | |



| | | | | | | | | |
|--|--|--|--|--|-------------|----------------------------------|--|--------------------------------|
| | | | | | description | Références OE par référence ATE. | | Références remplacées / divers |
|--|--|--|--|--|-------------|----------------------------------|--|--------------------------------|

AUDI

| | | | | | | | | | |
|-------------------------|------------------|-----|---------|--|----------------|--------|-----------------|---|--|
| A3 / A3 Sportback (03-) | 2,0 TDI Quattro | ArD | 08.2004 | | 24.3414-1710.7 | 220632 | ETRIER A GRIFFE | 1K0 615 424 C , 1K0 615 424 H , 1K0 615 424 F , 1K0 615 424 | |
| | | | 08.2004 | | 24.0325-0158.1 | 525158 | POWER-DISC | 1K0 615 301 AA | |
| | | | 05.2003 | | 24.0325-0158.1 | 525158 | POWER-DISC | 1K0 615 301 AA | |
| | | | 03.2006 | | 24.0325-0158.1 | 525158 | POWER-DISC | 1K0 615 301 AA | |
| | 2,0 TFSI | ArD | 06.2004 | | 24.3384-1756.7 | 220636 | ETRIER A GRIFFE | 1K0 615 424 D , 1K0 615 424 J , 1K0 615 424 A | |
| | | ArD | 06.2004 | | 24.3414-1710.7 | 220632 | ETRIER A GRIFFE | 1K0 615 424 C , 1K0 615 424 H , 1K0 615 424 F , 1K0 615 424 | |
| | | ArG | 06.2004 | | 24.3414-1709.7 | 220631 | ETRIER A GRIFFE | 1K0 615 423 C , 1K0 615 423 H , 1K0 615 423 F , 1K0 615 423 | |
| | | ArG | 06.2004 | | 24.3384-1755.7 | 220635 | ETRIER A GRIFFE | 1K0 615 423 D , 1K0 615 423 J , 1K0 615 423 A | |
| | | | 06.2004 | | 24.0325-0158.1 | 525158 | POWER-DISC | 1K0 615 301 AA | |
| | 2,0 TFSI Quattro | ArD | 06.2004 | | 24.3414-1710.7 | 220632 | ETRIER A GRIFFE | 1K0 615 424 C , 1K0 615 424 H , 1K0 615 424 F , 1K0 615 424 | |
| | | ArG | 06.2004 | | 24.3414-1709.7 | 220631 | ETRIER A GRIFFE | 1K0 615 423 C , 1K0 615 423 H , 1K0 615 423 F , 1K0 615 423 | |
| | | | 06.2004 | | 24.0325-0158.1 | 525158 | POWER-DISC | 1K0 615 301 AA | |
| | 3,2 Quattro | | 07.2003 | | 24.0325-0158.1 | 525158 | POWER-DISC | 1K0 615 301 AA | |
| A3 Cabrio (08-) | 1,8 TFSI | ArD | 04.2008 | | 24.3384-1756.7 | 220636 | ETRIER A GRIFFE | 1K0 615 424 D , 1K0 615 424 J , 1K0 615 424 A | |



| | | | | | | | | |
|--|--|--|--|--|-------------|----------------------------------|--|--------------------------------|
| | | | | | description | Références OE par référence ATE. | | Références remplacées / divers |
|--|--|--|--|--|-------------|----------------------------------|--|--------------------------------|

AUDI

| | | | | | | | | | |
|-----------------|----------|-----|---------|---------|----------------|--------|-----------------|---|----------------|
| A3 Cabrio (08-) | 1,8 TFSI | ArG | 04.2008 | | 24.3384-1755.7 | 220635 | ETRIER A GRIFFE | 1K0 615 423 D , 1K0 615 423 J , 1K0 615 423 A | |
| | 1,9 TDI | ArG | 04.2008 | | 24.3384-1755.7 | 220635 | ETRIER A GRIFFE | 1K0 615 423 D , 1K0 615 423 J , 1K0 615 423 A | |
| | | ArD | 04.2008 | | 24.3384-1756.7 | 220636 | ETRIER A GRIFFE | 1K0 615 424 D , 1K0 615 424 J , 1K0 615 424 A | |
| | 2,0 TDI | ArG | 04.2008 | | 24.3384-1755.7 | 220635 | ETRIER A GRIFFE | 1K0 615 423 D , 1K0 615 423 J , 1K0 615 423 A | |
| | | ArD | 04.2008 | | 24.3384-1756.7 | 220636 | ETRIER A GRIFFE | 1K0 615 424 D , 1K0 615 424 J , 1K0 615 424 A | |
| | 2,0 TFSI | ArD | 04.2008 | | 24.3384-1756.7 | 220636 | ETRIER A GRIFFE | 1K0 615 424 D , 1K0 615 424 J , 1K0 615 424 A | |
| | | ArG | 04.2008 | | 24.3384-1755.7 | 220635 | ETRIER A GRIFFE | 1K0 615 423 D , 1K0 615 423 J , 1K0 615 423 A | |
| A4 (B5) (95-01) | 1,6 | | 11.1994 | | 83.7812-0180.3 | 330854 | FLEXIBLE FREIN | 8D0 611 775 E , 4E0 611 775 F , 8E0 611 775 | 83.6212-0180.3 |
| | | | | 04.2001 | 83.7812-0180.3 | 330854 | FLEXIBLE FREIN | 8D0 611 775 E , 4E0 611 775 F , 8E0 611 775 | 83.6212-0180.3 |
| | 1,8 | | 11.1994 | | 83.7812-0180.3 | 330854 | FLEXIBLE FREIN | 8D0 611 775 E , 4E0 611 775 F , 8E0 611 775 | 83.6212-0180.3 |
| | | | | 04.2001 | 83.7812-0180.3 | 330854 | FLEXIBLE FREIN | 8D0 611 775 E , 4E0 611 775 F , 8E0 611 775 | 83.6212-0180.3 |
| | 1,8 T | | 05.1995 | | 83.7812-0180.3 | 330854 | FLEXIBLE FREIN | 8D0 611 775 E , 4E0 611 775 F , 8E0 611 775 | 83.6212-0180.3 |
| | | | | 04.2001 | 83.7812-0180.3 | 330854 | FLEXIBLE FREIN | 8D0 611 775 E , 4E0 611 775 F , 8E0 611 775 | 83.6212-0180.3 |



| | | | | | | | | |
|--|--|--|--|--|-------------|----------------------------------|--|--------------------------------|
| | | | | | description | Références OE par référence ATE. | | Références remplacées / divers |
|--|--|--|--|--|-------------|----------------------------------|--|--------------------------------|

AUDI

| | | | | | | | | | |
|-----------------|---------|--|---------|---------|----------------|--------|----------------|---|----------------|
| A4 (B5) (95-01) | 1,9 TDI | | 01.1998 | 04.2001 | 83.7812-0180.3 | 330854 | FLEXIBLE FREIN | 8D0 611 775 E , 4E0 611 775 F , 8E0 611 775 | 83.6212-0180.3 |
| | | | | 04.2001 | 83.7812-0180.3 | 330854 | FLEXIBLE FREIN | 8D0 611 775 E , 4E0 611 775 F , 8E0 611 775 | 83.6212-0180.3 |
| | | | 03.1996 | | 83.7812-0180.3 | 330854 | FLEXIBLE FREIN | 8D0 611 775 E , 4E0 611 775 F , 8E0 611 775 | 83.6212-0180.3 |
| | | | 02.1996 | | 83.7812-0180.3 | 330854 | FLEXIBLE FREIN | 8D0 611 775 E , 4E0 611 775 F , 8E0 611 775 | 83.6212-0180.3 |
| | | | 01.1995 | | 83.7812-0180.3 | 330854 | FLEXIBLE FREIN | 8D0 611 775 E , 4E0 611 775 F , 8E0 611 775 | 83.6212-0180.3 |
| | 2,4 | | 07.1995 | | 83.7812-0180.3 | 330854 | FLEXIBLE FREIN | 8D0 611 775 E , 4E0 611 775 F , 8E0 611 775 | 83.6212-0180.3 |
| | | | | 07.1997 | 83.7812-0180.3 | 330854 | FLEXIBLE FREIN | 8D0 611 775 E , 4E0 611 775 F , 8E0 611 775 | 83.6212-0180.3 |
| | | | 08.1997 | 04.2001 | 83.7812-0180.3 | 330854 | FLEXIBLE FREIN | 8D0 611 775 E , 4E0 611 775 F , 8E0 611 775 | 83.6212-0180.3 |
| | 2,5 TDI | | 08.1997 | 04.2001 | 83.7812-0180.3 | 330854 | FLEXIBLE FREIN | 8D0 611 775 E , 4E0 611 775 F , 8E0 611 775 | 83.6212-0180.3 |
| | 2,6 | | 11.1994 | | 83.7812-0180.3 | 330854 | FLEXIBLE FREIN | 8D0 611 775 E , 4E0 611 775 F , 8E0 611 775 | 83.6212-0180.3 |
| | | | | 04.2001 | 83.7812-0180.3 | 330854 | FLEXIBLE FREIN | 8D0 611 775 E , 4E0 611 775 F , 8E0 611 775 | 83.6212-0180.3 |
| | 2,8 | | 11.1994 | | 83.7812-0180.3 | 330854 | FLEXIBLE FREIN | 8D0 611 775 E , 4E0 611 775 F , 8E0 611 775 | 83.6212-0180.3 |
| | | | | 04.2001 | 83.7812-0180.3 | 330854 | FLEXIBLE FREIN | 8D0 611 775 E , 4E0 611 775 F , 8E0 611 775 | 83.6212-0180.3 |

Nouvelles références disponibles - par applications

09/2008



| | | | | | | | | |
|--|--|--|--|--|-------------|----------------------------------|--|--------------------------------|
| | | | | | description | Références OE par référence ATE. | | Références remplacées / divers |
|--|--|--|--|--|-------------|----------------------------------|--|--------------------------------|

AUDI

| | | | | | | | | | |
|--------------------|---------------|--|---------|---------|----------------|--------|----------------|--|----------------|
| A4 (B5) (95-01) | 2,8 | | | 07.1997 | 83.7812-0180.3 | 330854 | FLEXIBLE FREIN | 8D0 611 775 E , 4E0 611 775 F , 8E0 611 775 | 83.6212-0180.3 |
| | | | 03.1996 | | 83.7812-0180.3 | 330854 | FLEXIBLE FREIN | 8D0 611 775 E , 4E0 611 775 F , 8E0 611 775 | 83.6212-0180.3 |
| | S4 2,7 | | 10.1997 | 04.2001 | 24.0330-0113.1 | 530113 | POWER-DISC | 8E0 615 301 AD , 8D0 615 301 M , 8D0 615 301 K | |
| A4 (B6/B7) (01-08) | 1,6 | | 12.2000 | | 24.0330-0113.1 | 530113 | POWER-DISC | 8E0 615 301 AD , 8D0 615 301 M , 8D0 615 301 K | |
| | 1,8 T | | 11.2002 | | 24.0330-0113.1 | 530113 | POWER-DISC | 8E0 615 301 AD , 8D0 615 301 M , 8D0 615 301 K | |
| | | | 12.2000 | | 24.0330-0113.1 | 530113 | POWER-DISC | 8E0 615 301 AD , 8D0 615 301 M , 8D0 615 301 K | |
| | | | 07.2001 | | 24.0330-0113.1 | 530113 | POWER-DISC | 8E0 615 301 AD , 8D0 615 301 M , 8D0 615 301 K | |
| | | | 07.2002 | | 24.0330-0113.1 | 530113 | POWER-DISC | 8E0 615 301 AD , 8D0 615 301 M , 8D0 615 301 K | |
| | 1,8 T Quattro | | 07.2001 | | 24.0330-0113.1 | 530113 | POWER-DISC | 8E0 615 301 AD , 8D0 615 301 M , 8D0 615 301 K | |
| | | | 07.2002 | | 24.0330-0113.1 | 530113 | POWER-DISC | 8E0 615 301 AD , 8D0 615 301 M , 8D0 615 301 K | |
| | | | 11.2002 | | 24.0330-0113.1 | 530113 | POWER-DISC | 8E0 615 301 AD , 8D0 615 301 M , 8D0 615 301 K | |
| | | | 12.2000 | | 24.0330-0113.1 | 530113 | POWER-DISC | 8E0 615 301 AD , 8D0 615 301 M , 8D0 615 301 K | |
| | 1,9 TDI | | 06.2004 | | 24.0330-0113.1 | 530113 | POWER-DISC | 8E0 615 301 AD , 8D0 615 301 M , 8D0 615 301 K | |



| | | | | | | | | |
|--|--|--|--|--|-------------|----------------------------------|--|--------------------------------|
| | | | | | description | Références OE par référence ATE. | | Références remplacées / divers |
|--|--|--|--|--|-------------|----------------------------------|--|--------------------------------|

AUDI

| | | | | | | | | | |
|--------------------|------------------|--|---------|--|----------------|--------|------------|--|--|
| A4 (B6/B7) (01-08) | 1,9 TDI | | 12.2000 | | 24.0330-0113.1 | 530113 | POWER-DISC | 8E0 615 301 AD , 8D0 615 301 M , 8D0 615 301 K | |
| | | | 04.2001 | | 24.0330-0113.1 | 530113 | POWER-DISC | 8E0 615 301 AD , 8D0 615 301 M , 8D0 615 301 K | |
| | 1,9 TDI Quattro | | 12.2000 | | 24.0330-0113.1 | 530113 | POWER-DISC | 8E0 615 301 AD , 8D0 615 301 M , 8D0 615 301 K | |
| | 2 | | 12.2000 | | 24.0330-0113.1 | 530113 | POWER-DISC | 8E0 615 301 AD , 8D0 615 301 M , 8D0 615 301 K | |
| | 2,0 FSI | | 07.2002 | | 24.0330-0113.1 | 530113 | POWER-DISC | 8E0 615 301 AD , 8D0 615 301 M , 8D0 615 301 K | |
| | 2,0 TDI | | 06.2006 | | 24.0330-0113.1 | 530113 | POWER-DISC | 8E0 615 301 AD , 8D0 615 301 M , 8D0 615 301 K | |
| | | | 11.2004 | | 24.0330-0113.1 | 530113 | POWER-DISC | 8E0 615 301 AD , 8D0 615 301 M , 8D0 615 301 K | |
| | 2,0 TDI Quattro | | 01.2006 | | 24.0330-0113.1 | 530113 | POWER-DISC | 8E0 615 301 AD , 8D0 615 301 M , 8D0 615 301 K | |
| | | | 06.2006 | | 24.0330-0113.1 | 530113 | POWER-DISC | 8E0 615 301 AD , 8D0 615 301 M , 8D0 615 301 K | |
| | 2,0 TFSI | | 11.2004 | | 24.0330-0113.1 | 530113 | POWER-DISC | 8E0 615 301 AD , 8D0 615 301 M , 8D0 615 301 K | |
| | | | 06.2005 | | 24.0330-0113.1 | 530113 | POWER-DISC | 8E0 615 301 AD , 8D0 615 301 M , 8D0 615 301 K | |
| | 2,0 TFSI Quattro | | 11.2004 | | 24.0330-0113.1 | 530113 | POWER-DISC | 8E0 615 301 AD , 8D0 615 301 M , 8D0 615 301 K | |
| | | | 06.2005 | | 24.0330-0113.1 | 530113 | POWER-DISC | 8E0 615 301 AD , 8D0 615 301 M , 8D0 615 301 K | |



| | | | | | | | | |
|--|--|--|--|--|-------------|----------------------------------|--|--------------------------------|
| | | | | | description | Références OE par référence ATE. | | Références remplacées / divers |
|--|--|--|--|--|-------------|----------------------------------|--|--------------------------------|

AUDI

| | | | | | | | | | |
|----------------------|-----------------|--|---------|--|----------------|--------|------------|--|--|
| A4 (B6/B7) (01-08) | 2,4 | | 09.2001 | | 24.0330-0113.1 | 530113 | POWER-DISC | 8E0 615 301 AD , 8D0 615 301 M , 8D0 615 301 K | |
| | 2,5 TDI | | 12.2000 | | 24.0330-0113.1 | 530113 | POWER-DISC | 8E0 615 301 AD , 8D0 615 301 M , 8D0 615 301 K | |
| | 2,5 TDI Quattro | | 12.2000 | | 24.0330-0113.1 | 530113 | POWER-DISC | 8E0 615 301 AD , 8D0 615 301 M , 8D0 615 301 K | |
| | 2,7 TDI | | 01.2006 | | 24.0330-0113.1 | 530113 | POWER-DISC | 8E0 615 301 AD , 8D0 615 301 M , 8D0 615 301 K | |
| | 3 | | 12.2000 | | 24.0330-0113.1 | 530113 | POWER-DISC | 8E0 615 301 AD , 8D0 615 301 M , 8D0 615 301 K | |
| | 3,0 Quattro | | 12.2000 | | 24.0330-0113.1 | 530113 | POWER-DISC | 8E0 615 301 AD , 8D0 615 301 M , 8D0 615 301 K | |
| | 3,0 TDI Quattro | | 11.2004 | | 24.0330-0113.1 | 530113 | POWER-DISC | 8E0 615 301 AD , 8D0 615 301 M , 8D0 615 301 K | |
| | | | 01.2006 | | 24.0330-0113.1 | 530113 | POWER-DISC | 8E0 615 301 AD , 8D0 615 301 M , 8D0 615 301 K | |
| | 3,2 FSI | | 01.2005 | | 24.0330-0113.1 | 530113 | POWER-DISC | 8E0 615 301 AD , 8D0 615 301 M , 8D0 615 301 K | |
| | 3,2 FSI Quattro | | 01.2005 | | 24.0330-0113.1 | 530113 | POWER-DISC | 8E0 615 301 AD , 8D0 615 301 M , 8D0 615 301 K | |
| A4 DECAPOTABLE (02-) | 1,8 T | | 04.2002 | | 24.0330-0113.1 | 530113 | POWER-DISC | 8E0 615 301 AD , 8D0 615 301 M , 8D0 615 301 K | |
| | 1,8 T Quattro | | 05.2003 | | 24.0330-0113.1 | 530113 | POWER-DISC | 8E0 615 301 AD , 8D0 615 301 M , 8D0 615 301 K | |
| | 2 | | 05.2004 | | 24.0330-0113.1 | 530113 | POWER-DISC | 8E0 615 301 AD , 8D0 615 301 M , 8D0 615 301 K | |



| | | | | | | | | |
|--|--|--|--|--|-------------|----------------------------------|--|--------------------------------|
| | | | | | description | Références OE par référence ATE. | | Références remplacées / divers |
|--|--|--|--|--|-------------|----------------------------------|--|--------------------------------|

AUDI

| | | | | | | | | | |
|----------------------|-----------------|--|---------|---------|----------------|--------|------------|--|--|
| A4 DECAPOTABLE (02-) | 2,0 TDI | | 10.2005 | | 24.0330-0113.1 | 530113 | POWER-DISC | 8E0 615 301 AD , 8D0 615 301 M , 8D0 615 301 K | |
| | 2,0 TFSI | | 01.2006 | | 24.0330-0113.1 | 530113 | POWER-DISC | 8E0 615 301 AD , 8D0 615 301 M , 8D0 615 301 K | |
| | | | 10.2005 | | 24.0330-0113.1 | 530113 | POWER-DISC | 8E0 615 301 AD , 8D0 615 301 M , 8D0 615 301 K | |
| | 2,4 | | 04.2002 | | 24.0330-0113.1 | 530113 | POWER-DISC | 8E0 615 301 AD , 8D0 615 301 M , 8D0 615 301 K | |
| | 2,5 TDI | | 08.2002 | | 24.0330-0113.1 | 530113 | POWER-DISC | 8E0 615 301 AD , 8D0 615 301 M , 8D0 615 301 K | |
| | 2,7 TDI | | 06.2006 | | 24.0330-0113.1 | 530113 | POWER-DISC | 8E0 615 301 AD , 8D0 615 301 M , 8D0 615 301 K | |
| | 3 | | 04.2002 | | 24.0330-0113.1 | 530113 | POWER-DISC | 8E0 615 301 AD , 8D0 615 301 M , 8D0 615 301 K | |
| | 3,0 Quattro | | 05.2003 | | 24.0330-0113.1 | 530113 | POWER-DISC | 8E0 615 301 AD , 8D0 615 301 M , 8D0 615 301 K | |
| | 3,0 TDI Quattro | | 10.2005 | | 24.0330-0113.1 | 530113 | POWER-DISC | 8E0 615 301 AD , 8D0 615 301 M , 8D0 615 301 K | |
| | | | 01.2006 | | 24.0330-0113.1 | 530113 | POWER-DISC | 8E0 615 301 AD , 8D0 615 301 M , 8D0 615 301 K | |
| | 3,2 FSI | | 10.2005 | | 24.0330-0113.1 | 530113 | POWER-DISC | 8E0 615 301 AD , 8D0 615 301 M , 8D0 615 301 K | |
| | 3,2 FSI Quattro | | 10.2005 | | 24.0330-0113.1 | 530113 | POWER-DISC | 8E0 615 301 AD , 8D0 615 301 M , 8D0 615 301 K | |
| A6 (C5) (97-05) | 1,8 T | | 04.1997 | 01.2005 | 24.0330-0113.1 | 530113 | POWER-DISC | 8E0 615 301 AD , 8D0 615 301 M , 8D0 615 301 K | |



| | | | | | | | | |
|--|--|--|--|--|-------------|----------------------------------|--|--------------------------------|
| | | | | | description | Références OE par référence ATE. | | Références remplacées / divers |
|--|--|--|--|--|-------------|----------------------------------|--|--------------------------------|

AUDI

| | | | | | | | | | |
|-----------------------|-----------------|--|---------|---------|----------------|--------|-----------------|--|--|
| A6 (C5) (97-05) | 1,8 T Quattro | | 06.2001 | 01.2005 | 24.0330-0113.1 | 530113 | POWER-DISC | 8E0 615 301 AD , 8D0 615 301 M , 8D0 615 301 K | |
| | 2,4 Quattro | | 06.2001 | 01.2005 | 24.0330-0113.1 | 530113 | POWER-DISC | 8E0 615 301 AD , 8D0 615 301 M , 8D0 615 301 K | |
| | 2,5 TDI | | 02.2000 | 01.2005 | 24.0330-0113.1 | 530113 | POWER-DISC | 8E0 615 301 AD , 8D0 615 301 M , 8D0 615 301 K | |
| | | | 04.1997 | 01.2005 | 24.0330-0113.1 | 530113 | POWER-DISC | 8E0 615 301 AD , 8D0 615 301 M , 8D0 615 301 K | |
| | | | 07.2002 | 01.2005 | 24.0330-0113.1 | 530113 | POWER-DISC | 8E0 615 301 AD , 8D0 615 301 M , 8D0 615 301 K | |
| | 2,5 TDI Quattro | | 06.2001 | 01.2005 | 24.0330-0113.1 | 530113 | POWER-DISC | 8E0 615 301 AD , 8D0 615 301 M , 8D0 615 301 K | |
| | 2,7 T | | 03.1998 | 01.2005 | 24.0330-0113.1 | 530113 | POWER-DISC | 8E0 615 301 AD , 8D0 615 301 M , 8D0 615 301 K | |
| | 2,7 T Quattro | | 10.1997 | 01.2005 | 24.0330-0113.1 | 530113 | POWER-DISC | 8E0 615 301 AD , 8D0 615 301 M , 8D0 615 301 K | |
| | 3 | | 06.2001 | 01.2005 | 24.0330-0113.1 | 530113 | POWER-DISC | 8E0 615 301 AD , 8D0 615 301 M , 8D0 615 301 K | |
| | 3,0 Quattro | | 06.2001 | 01.2005 | 24.0330-0113.1 | 530113 | POWER-DISC | 8E0 615 301 AD , 8D0 615 301 M , 8D0 615 301 K | |
| A6 (C6) Avant (05-) | S6 | | 06.2005 | | 24.0136-0107.1 | 436107 | DISQUE DE FREIN | 4F0 615 301 J | |
| A6 (C6) Berline (04-) | | | 03.2006 | | 24.0136-0107.1 | 436107 | DISQUE DE FREIN | 4F0 615 301 J | |
| A6 Allroad (00-05) | 2,5 TDI | | 05.2000 | 07.2005 | 24.0330-0113.1 | 530113 | POWER-DISC | 8E0 615 301 AD , 8D0 615 301 M , 8D0 615 301 K | |
| | 2,7 T | | 05.2000 | 07.2005 | 24.0330-0113.1 | 530113 | POWER-DISC | 8E0 615 301 AD , 8D0 615 301 M , 8D0 615 301 K | |



| | | | | | | | | |
|--|--|--|--|--|-------------|----------------------------------|--|--------------------------------|
| | | | | | description | Références OE par référence ATE. | | Références remplacées / divers |
|--|--|--|--|--|-------------|----------------------------------|--|--------------------------------|

AUDI

| | | | | | | | | | |
|--------------------|-----------------|--|---------|---------|----------------|--------|----------------|--|----------------|
| A6 Allroad (00-05) | 4,2 | | 07.2002 | 07.2005 | 24.0330-0113.1 | 530113 | POWER-DISC | 8E0 615 301 AD , 8D0 615 301 M , 8D0 615 301 K | |
| A8 (03-) | 2,8 FSI | | 08.2007 | | 83.7812-0180.3 | 330854 | FLEXIBLE FREIN | 8D0 611 775 E , 4E0 611 775 F , 8E0 611 775 | 83.6212-0180.3 |
| | 3 | | | | 83.7812-0180.3 | 330854 | FLEXIBLE FREIN | 8D0 611 775 E , 4E0 611 775 F , 8E0 611 775 | 83.6212-0180.3 |
| | | | 07.2003 | | 83.7812-0180.3 | 330854 | FLEXIBLE FREIN | 8D0 611 775 E , 4E0 611 775 F , 8E0 611 775 | 83.6212-0180.3 |
| | 3,0 TDI Quattro | | | | 83.7812-0180.3 | 330854 | FLEXIBLE FREIN | 8D0 611 775 E , 4E0 611 775 F , 8E0 611 775 | 83.6212-0180.3 |
| | | | 11.2003 | | 83.7812-0180.3 | 330854 | FLEXIBLE FREIN | 8D0 611 775 E , 4E0 611 775 F , 8E0 611 775 | 83.6212-0180.3 |
| | 3,2 FSI | | | | 83.7812-0180.3 | 330854 | FLEXIBLE FREIN | 8D0 611 775 E , 4E0 611 775 F , 8E0 611 775 | 83.6212-0180.3 |
| | | | 06.2005 | | 83.7812-0180.3 | 330854 | FLEXIBLE FREIN | 8D0 611 775 E , 4E0 611 775 F , 8E0 611 775 | 83.6212-0180.3 |
| | 3,2 FSI Quattro | | 06.2005 | | 83.7812-0180.3 | 330854 | FLEXIBLE FREIN | 8D0 611 775 E , 4E0 611 775 F , 8E0 611 775 | 83.6212-0180.3 |
| | | | | | 83.7812-0180.3 | 330854 | FLEXIBLE FREIN | 8D0 611 775 E , 4E0 611 775 F , 8E0 611 775 | 83.6212-0180.3 |
| | 3,7 Quattro | | 11.2002 | | 83.7812-0180.3 | 330854 | FLEXIBLE FREIN | 8D0 611 775 E , 4E0 611 775 F , 8E0 611 775 | 83.6212-0180.3 |
| | | | | | 83.7812-0180.3 | 330854 | FLEXIBLE FREIN | 8D0 611 775 E , 4E0 611 775 F , 8E0 611 775 | 83.6212-0180.3 |
| | 4,0 TDI Quattro | | 03.2003 | | 83.7812-0180.3 | 330854 | FLEXIBLE FREIN | 8D0 611 775 E , 4E0 611 775 F , 8E0 611 775 | 83.6212-0180.3 |

Nouvelles références disponibles - par applications

09/2008



| | | | | | | | | |
|--|--|--|--|--|-------------|----------------------------------|--|--------------------------------|
| | | | | | description | Références OE par référence ATE. | | Références remplacées / divers |
|--|--|--|--|--|-------------|----------------------------------|--|--------------------------------|

AUDI

| | | | | | | | | | |
|------------------|-----------------|--|---------|---------|----------------|--------|--------------------|---|----------------|
| A8 (03-) | 4,0 TDI Quattro | | | | 83.7812-0180.3 | 330854 | FLEXIBLE FREIN | 8D0 611 775 E , 4E0 611 775 F , 8E0 611 775 | 83.6212-0180.3 |
| | 4,2 FSI Quattro | | 06.2006 | | 83.7812-0180.3 | 330854 | FLEXIBLE FREIN | 8D0 611 775 E , 4E0 611 775 F , 8E0 611 775 | 83.6212-0180.3 |
| | | | | | 83.7812-0180.3 | 330854 | FLEXIBLE FREIN | 8D0 611 775 E , 4E0 611 775 F , 8E0 611 775 | 83.6212-0180.3 |
| | 4,2 Quattro | | 11.2002 | | 83.7812-0180.3 | 330854 | FLEXIBLE FREIN | 8D0 611 775 E , 4E0 611 775 F , 8E0 611 775 | 83.6212-0180.3 |
| | | | | | 83.7812-0180.3 | 330854 | FLEXIBLE FREIN | 8D0 611 775 E , 4E0 611 775 F , 8E0 611 775 | 83.6212-0180.3 |
| | 4,2 TDI Quattro | | 07.2005 | | 83.7812-0180.3 | 330854 | FLEXIBLE FREIN | 8D0 611 775 E , 4E0 611 775 F , 8E0 611 775 | 83.6212-0180.3 |
| | | | | | 83.7812-0180.3 | 330854 | FLEXIBLE FREIN | 8D0 611 775 E , 4E0 611 775 F , 8E0 611 775 | 83.6212-0180.3 |
| | 6,0 W12 Quattro | | | | 83.7812-0180.3 | 330854 | FLEXIBLE FREIN | 8D0 611 775 E , 4E0 611 775 F , 8E0 611 775 | 83.6212-0180.3 |
| | | | 02.2004 | | 83.7812-0180.3 | 330854 | FLEXIBLE FREIN | 8D0 611 775 E , 4E0 611 775 F , 8E0 611 775 | 83.6212-0180.3 |
| | S8 | | | | 83.7812-0180.3 | 330854 | FLEXIBLE FREIN | 8D0 611 775 E , 4E0 611 775 F , 8E0 611 775 | 83.6212-0180.3 |
| | | | 06.2006 | | 83.7812-0180.3 | 330854 | FLEXIBLE FREIN | 8D0 611 775 E , 4E0 611 775 F , 8E0 611 775 | 83.6212-0180.3 |
| TT Coupe (06-) | 2,0 TDI Quattro | | 06.2008 | | 24.0325-0158.1 | 525158 | POWER-DISC | 1K0 615 301 AA | |
| | 2,0 TFSI | | 07.2006 | | 24.0325-0158.1 | 525158 | POWER-DISC | 1K0 615 301 AA | |
| | 3,2 Quattro | | 07.2006 | | 24.0325-0158.1 | 525158 | POWER-DISC | 1K0 615 301 AA | |
| TT Coupe (98-06) | 1,8 T | | 09.2002 | 06.2006 | 24.3727-0189.2 | 580189 | CABLE FREIN A MAIN | 8N0 609 721 F | |

Nouvelles références disponibles - par applications

09/2008



| | | | | | | |
|--|----------|--|--|-------------|----------------------------------|--|
| | i | | | description | Références OE par référence ATE. | i Références remplacées / divers |
|--|----------|--|--|-------------|----------------------------------|--|







AUDI

| | | | | | | | | | |
|---------------------|-----------------|--|---------|---------|----------------|--------|--------------------|----------------|--|
| TT Coupe (98-06) | 1,8 T | | 09.2005 | 06.2006 | 24.3727-0189.2 | 580189 | CABLE FREIN A MAIN | 8N0 609 721 F | |
| | | | 10.1998 | | 24.3727-0190.2 | 580190 | CABLE FREIN A MAIN | 8N0 609 721 C | |
| | | | | 06.2006 | 24.3727-0189.2 | 580189 | CABLE FREIN A MAIN | 8N0 609 721 F | |
| TT Roadster (07-) | 2,0 TDI Quattro | | 06.2008 | | 24.0325-0158.1 | 525158 | POWER-DISC | 1K0 615 301 AA | |
| | 2,0 TFSI | | 02.2007 | | 24.0325-0158.1 | 525158 | POWER-DISC | 1K0 615 301 AA | |
| | 3,2 Quattro | | 02.2007 | | 24.0325-0158.1 | 525158 | POWER-DISC | 1K0 615 301 AA | |
| TT Roadster (99-06) | 1,8 T | | | 06.2006 | 24.3727-0189.2 | 580189 | CABLE FREIN A MAIN | 8N0 609 721 F | |
| | | | 01.2001 | 06.2006 | 24.3727-0189.2 | 580189 | CABLE FREIN A MAIN | 8N0 609 721 F | |
| | | | 09.2005 | 06.2006 | 24.3727-0189.2 | 580189 | CABLE FREIN A MAIN | 8N0 609 721 F | |
| | | | 04.1999 | | 24.3727-0190.2 | 580190 | CABLE FREIN A MAIN | 8N0 609 721 C | |

Nouvelles références disponibles - par applications

09/2008



| | | | | | | | |
|---|---|---|---|---|-------------|----------------------------------|--|
|  |  |  |  |  | description | Références OE par référence ATE. |  Références remplacées / divers |
|---|---|---|---|---|-------------|----------------------------------|--|







BMW

| Série | Modèle | 09.2004 | 09.2007 | 24.3727-0234.2 | 580234 | description | Références OE par référence ATE. | Références remplacées / divers |
|-------------------------------|--------|---------|---------|----------------|--------|--------------------|----------------------------------|--------------------------------|
| Série 1/E81/E87 Berline (04-) | 116 i | | | | | CABLE FREIN A MAIN | 34 40 6 760 443 | |
| | | | | | | CABLE FREIN A MAIN | 34 40 6 760 443 | |
| | 118 d | | | | | CABLE FREIN A MAIN | 34 40 6 760 443 | |
| | | | | | | CABLE FREIN A MAIN | 34 40 6 760 443 | |
| | 118 i | | | | | CABLE FREIN A MAIN | 34 40 6 760 443 | |
| | | | | | | CABLE FREIN A MAIN | 34 40 6 760 443 | |
| | 120 d | | | | | CABLE FREIN A MAIN | 34 40 6 760 443 | |
| | | | | | | CABLE FREIN A MAIN | 34 40 6 760 443 | |
| | 120 i | | | | | CABLE FREIN A MAIN | 34 40 6 760 443 | |
| | | | | | | CABLE FREIN A MAIN | 34 40 6 760 443 | |
| | 123 d | | | | | CABLE FREIN A MAIN | 34 40 6 760 443 | |
| | | | | | | CABLE FREIN A MAIN | 34 40 6 760 443 | |
| 1er Reihe/E82 Coupe (07-) | 120 d | | | | | CABLE FREIN A MAIN | 34 40 6 760 443 | |
| | | | | | | CABLE FREIN A MAIN | 34 40 6 760 443 | |
| | 125 i | | | | | CABLE FREIN A MAIN | 34 40 6 760 443 | |
| | 135 i | | | | | CABLE FREIN A MAIN | 34 40 6 760 443 | |
| 1er Reihe/E88 Cabrio (08-) | 118 i | | | | | CABLE FREIN A MAIN | 34 40 6 760 443 | |
| | 120 d | | | | | CABLE FREIN A MAIN | 34 40 6 760 443 | |
| | 120 i | | | | | CABLE FREIN A MAIN | 34 40 6 760 443 | |

Nouvelles références disponibles - par applications

09/2008



| | | | | | | | | |
|---|---|---|---|---|-------------|----------------------------------|---|--------------------------------|
|  |  |  |  |  | description | Références OE par référence ATE. |  | Références remplacées / divers |
|---|---|---|---|---|-------------|----------------------------------|---|--------------------------------|

BMW

| 1er Reih | Modèle | Année | Année | ATE | ATE | Description | Références OE | Références |
|-------------|--------|---------|---------|----------------|--------|--------------------|-----------------|------------|
| 1er Reih | 125 i | 03.2008 | | 24.3727-0234.2 | 580234 | CABLE FREIN A MAIN | 34 40 6 760 443 | |
| | 135 i | 03.2008 | | 24.3727-0234.2 | 580234 | CABLE FREIN A MAIN | 34 40 6 760 443 | |
| Série 3/E90 | 316 i | 01.2005 | 08.2007 | 24.3727-0233.2 | 580233 | CABLE FREIN A MAIN | 34 40 6 760 444 | |
| | | 09.2007 | | 24.3727-0233.2 | 580233 | CABLE FREIN A MAIN | 34 40 6 760 444 | |
| | 318 d | 09.2007 | | 24.3727-0233.2 | 580233 | CABLE FREIN A MAIN | 34 40 6 760 444 | |
| | | 09.2005 | 08.2007 | 24.3727-0233.2 | 580233 | CABLE FREIN A MAIN | 34 40 6 760 444 | |
| | 318 i | 09.2007 | | 24.3727-0233.2 | 580233 | CABLE FREIN A MAIN | 34 40 6 760 444 | |
| | | 09.2005 | 08.2007 | 24.3727-0233.2 | 580233 | CABLE FREIN A MAIN | 34 40 6 760 444 | |
| | 320 d | 09.2007 | | 24.3727-0233.2 | 580233 | CABLE FREIN A MAIN | 34 40 6 760 444 | |
| | | 12.2004 | 08.2007 | 24.3727-0233.2 | 580233 | CABLE FREIN A MAIN | 34 40 6 760 444 | |
| | 320 i | 12.2004 | 08.2007 | 24.3727-0233.2 | 580233 | CABLE FREIN A MAIN | 34 40 6 760 444 | |
| | | 09.2007 | | 24.3727-0233.2 | 580233 | CABLE FREIN A MAIN | 34 40 6 760 444 | |
| | 320 si | 06.2006 | | 24.3727-0233.2 | 580233 | CABLE FREIN A MAIN | 34 40 6 760 444 | |
| | 325 d | 09.2006 | | 24.3727-0233.2 | 580233 | CABLE FREIN A MAIN | 34 40 6 760 444 | |
| | 325 i | 12.2004 | | 24.3727-0233.2 | 580233 | CABLE FREIN A MAIN | 34 40 6 760 444 | |
| | 325 xi | 01.2005 | | 24.3727-0233.2 | 580233 | CABLE FREIN A MAIN | 34 40 6 760 444 | |
| | 330 d | 09.2005 | | 24.3727-0233.2 | 580233 | CABLE FREIN A MAIN | 34 40 6 760 444 | |
| | 330 i | 09.2007 | | 24.3727-0233.2 | 580233 | CABLE FREIN A MAIN | 34 40 6 760 444 | |
| | | 12.2004 | 08.2007 | 24.3727-0233.2 | 580233 | CABLE FREIN A MAIN | 34 40 6 760 444 | |

Nouvelles références disponibles - par applications

09/2008



| | | | | | | | | |
|--|--|--|--|--|-------------|----------------------------------|--|--------------------------------|
| | | | | | description | Références OE par référence ATE. | | Références remplacées / divers |
|--|--|--|--|--|-------------|----------------------------------|--|--------------------------------|

BMW

| | | | | | | | | | |
|---------------------------|--------|-----|---------|---------|----------------|--------|--------------------|-----------------|--|
| Série 3/E90 Berline (05-) | 330 xd | | 09.2005 | | 24.3727-0233.2 | 580233 | CABLE FREIN A MAIN | 34 40 6 760 444 | |
| | 330 xi | | 09.2007 | | 24.3727-0233.2 | 580233 | CABLE FREIN A MAIN | 34 40 6 760 444 | |
| | | | 01.2005 | 08.2007 | 24.3727-0233.2 | 580233 | CABLE FREIN A MAIN | 34 40 6 760 444 | |
| | 335 d | | 09.2006 | | 24.3727-0233.2 | 580233 | CABLE FREIN A MAIN | 34 40 6 760 444 | |
| | 335 i | | 09.2006 | | 24.3727-0233.2 | 580233 | CABLE FREIN A MAIN | 34 40 6 760 444 | |
| | 335 xi | | 03.2007 | | 24.3727-0233.2 | 580233 | CABLE FREIN A MAIN | 34 40 6 760 444 | |
| | M3 | | 12.2007 | | 24.3727-0233.2 | 580233 | CABLE FREIN A MAIN | 34 40 6 760 444 | |
| | | AvD | 12.2007 | | 24.8190-0258.2 | 620258 | TEMOIN D'USURE | 34 35 2 283 405 | |
| | | AvG | 12.2007 | | 24.8190-0257.2 | 620257 | TEMOIN D'USURE | 34 35 2 283 335 | |
| Série 3/E91 Touring (05-) | 318 d | | 09.2007 | | 24.3727-0233.2 | 580233 | CABLE FREIN A MAIN | 34 40 6 760 444 | |
| | | | 09.2005 | 08.2007 | 24.3727-0233.2 | 580233 | CABLE FREIN A MAIN | 34 40 6 760 444 | |
| | 318 i | | 09.2007 | | 24.3727-0233.2 | 580233 | CABLE FREIN A MAIN | 34 40 6 760 444 | |
| | | | 01.2006 | 08.2007 | 24.3727-0233.2 | 580233 | CABLE FREIN A MAIN | 34 40 6 760 444 | |
| | 320 d | | 09.2007 | | 24.3727-0233.2 | 580233 | CABLE FREIN A MAIN | 34 40 6 760 444 | |
| | | | 06.2005 | 08.2007 | 24.3727-0233.2 | 580233 | CABLE FREIN A MAIN | 34 40 6 760 444 | |
| | 320 i | | 09.2007 | | 24.3727-0233.2 | 580233 | CABLE FREIN A MAIN | 34 40 6 760 444 | |
| | | | 06.2005 | 08.2007 | 24.3727-0233.2 | 580233 | CABLE FREIN A MAIN | 34 40 6 760 444 | |
| | 323 i | | 06.2005 | | 24.3727-0233.2 | 580233 | CABLE FREIN A MAIN | 34 40 6 760 444 | |
| | 325 d | | 09.2006 | | 24.3727-0233.2 | 580233 | CABLE FREIN A MAIN | 34 40 6 760 444 | |

Nouvelles références disponibles - par applications

09/2008



| | | | | | | | | |
|--|--|--|--|--|-------------|----------------------------------|--|--------------------------------|
| | | | | | description | Références OE par référence ATE. | | Références remplacées / divers |
|--|--|--|--|--|-------------|----------------------------------|--|--------------------------------|

BMW

| | | | | | | | | | |
|---------------------------|--------|--|---------|---------|----------------|--------|--------------------|-----------------|--|
| Série 3/E91 Touring (05-) | 325 i | | 06.2005 | | 24.3727-0233.2 | 580233 | CABLE FREIN A MAIN | 34 40 6 760 444 | |
| | 325 xi | | 06.2005 | | 24.3727-0233.2 | 580233 | CABLE FREIN A MAIN | 34 40 6 760 444 | |
| | 330 d | | 06.2005 | | 24.3727-0233.2 | 580233 | CABLE FREIN A MAIN | 34 40 6 760 444 | |
| | 330 i | | 09.2007 | | 24.3727-0233.2 | 580233 | CABLE FREIN A MAIN | 34 40 6 760 444 | |
| | | | 06.2005 | 08.2007 | 24.3727-0233.2 | 580233 | CABLE FREIN A MAIN | 34 40 6 760 444 | |
| | 330 xd | | 06.2005 | | 24.3727-0233.2 | 580233 | CABLE FREIN A MAIN | 34 40 6 760 444 | |
| | 330 xi | | 09.2007 | | 24.3727-0233.2 | 580233 | CABLE FREIN A MAIN | 34 40 6 760 444 | |
| | | | 06.2005 | 08.2007 | 24.3727-0233.2 | 580233 | CABLE FREIN A MAIN | 34 40 6 760 444 | |
| | 335 d | | 09.2006 | | 24.3727-0233.2 | 580233 | CABLE FREIN A MAIN | 34 40 6 760 444 | |
| | 335 i | | 09.2006 | | 24.3727-0233.2 | 580233 | CABLE FREIN A MAIN | 34 40 6 760 444 | |
| | 335 xi | | 03.2007 | | 24.3727-0233.2 | 580233 | CABLE FREIN A MAIN | 34 40 6 760 444 | |
| Série 3/E92 Coupé (06-) | 320 d | | 03.2007 | | 24.3727-0233.2 | 580233 | CABLE FREIN A MAIN | 34 40 6 760 444 | |
| | 320 i | | 03.2007 | | 24.3727-0233.2 | 580233 | CABLE FREIN A MAIN | 34 40 6 760 444 | |
| | 323 i | | 09.2006 | | 24.3727-0233.2 | 580233 | CABLE FREIN A MAIN | 34 40 6 760 444 | |
| | 325 d | | 03.2007 | | 24.3727-0233.2 | 580233 | CABLE FREIN A MAIN | 34 40 6 760 444 | |
| | 325 i | | 09.2006 | | 24.3727-0233.2 | 580233 | CABLE FREIN A MAIN | 34 40 6 760 444 | |
| | 325 xi | | 09.2006 | | 24.3727-0233.2 | 580233 | CABLE FREIN A MAIN | 34 40 6 760 444 | |
| | 330 d | | 09.2006 | | 24.3727-0233.2 | 580233 | CABLE FREIN A MAIN | 34 40 6 760 444 | |
| | 330 i | | 09.2006 | | 24.3727-0233.2 | 580233 | CABLE FREIN A MAIN | 34 40 6 760 444 | |

Nouvelles références disponibles - par applications

09/2008



| | | | | | | | | |
|--|--|--|--|--|-------------|----------------------------------|--|--------------------------------|
| | | | | | description | Références OE par référence ATE. | | Références remplacées / divers |
|--|--|--|--|--|-------------|----------------------------------|--|--------------------------------|







BMW

| | | | | | | | | | |
|-------------------------------|--------|-----|---------|--|----------------|--------|--------------------|-----------------------------------|--|
| Série 3/E92 Coupé (06-) | 330 xd | | 09.2006 | | 24.3727-0233.2 | 580233 | CABLE FREIN A MAIN | 34 40 6 760 444 | |
| | 330 xi | | 09.2006 | | 24.3727-0233.2 | 580233 | CABLE FREIN A MAIN | 34 40 6 760 444 | |
| | 335 d | | 09.2006 | | 24.3727-0233.2 | 580233 | CABLE FREIN A MAIN | 34 40 6 760 444 | |
| | 335 i | | 09.2006 | | 24.3727-0233.2 | 580233 | CABLE FREIN A MAIN | 34 40 6 760 444 | |
| | 335 xi | | 09.2007 | | 24.3727-0233.2 | 580233 | CABLE FREIN A MAIN | 34 40 6 760 444 | |
| | M3 | | 03.2007 | | 24.3727-0233.2 | 580233 | CABLE FREIN A MAIN | 34 40 6 760 444 | |
| | | AvD | 03.2007 | | 24.8190-0258.2 | 620258 | TEMOIN D'USURE | 34 35 2 283 405 | |
| | | AvG | 03.2007 | | 24.8190-0257.2 | 620257 | TEMOIN D'USURE | 34 35 2 283 335 | |
| Série 3/E93 Décapotable (07-) | 320 d | | 03.2008 | | 24.3727-0233.2 | 580233 | CABLE FREIN A MAIN | 34 40 6 760 444 | |
| | 320 i | | 03.2007 | | 24.3727-0233.2 | 580233 | CABLE FREIN A MAIN | 34 40 6 760 444 | |
| | 325 d | | 09.2007 | | 24.3727-0233.2 | 580233 | CABLE FREIN A MAIN | 34 40 6 760 444 | |
| | 325 i | | 03.2007 | | 24.3727-0233.2 | 580233 | CABLE FREIN A MAIN | 34 40 6 760 444 | |
| | 330 d | | 03.2007 | | 24.3727-0233.2 | 580233 | CABLE FREIN A MAIN | 34 40 6 760 444 | |
| | 330 i | | 03.2007 | | 24.3727-0233.2 | 580233 | CABLE FREIN A MAIN | 34 40 6 760 444 | |
| | 335 i | | 03.2007 | | 24.3727-0233.2 | 580233 | CABLE FREIN A MAIN | 34 40 6 760 444 | |
| | M3 | | 03.2008 | | 24.3727-0233.2 | 580233 | CABLE FREIN A MAIN | 34 40 6 760 444 | |
| | | AvG | 03.2008 | | 24.8190-0257.2 | 620257 | TEMOIN D'USURE | 34 35 2 283 335 | |
| | | AvD | 03.2008 | | 24.8190-0258.2 | 620258 | TEMOIN D'USURE | 34 35 2 283 405 | |
| Série 5/E60 Berline (03-) | 520 d | ArD | 07.2005 | | 24.3727-0237.2 | 580237 | CABLE FREIN A MAIN | 34 40 6 761 098 , 34 40 6 770 602 | |

Nouvelles références disponibles - par applications

09/2008



| | | | | | | | |
|---|---|---|---|---|-------------|----------------------------------|--|
|  |  |  |  |  | description | Références OE par référence ATE. |  Références remplacées / divers |
|---|---|---|---|---|-------------|----------------------------------|--|

BMW

| | | | | | | | | | |
|---------------------------|-------|-----|---------|---------|----------------|--------|--------------------|-----------------------------------|--|
| Série 5/E60 Berline (03-) | 520 d | ArD | 09.2007 | | 24.3727-0237.2 | 580237 | CABLE FREIN A MAIN | 34 40 6 761 098 , 34 40 6 770 602 | |
| | | ArG | 07.2005 | | 24.3727-0236.2 | 580236 | CABLE FREIN A MAIN | 34 40 6 761 097 , 34 40 6 770 603 | |
| | | ArG | 09.2007 | | 24.3727-0236.2 | 580236 | CABLE FREIN A MAIN | 34 40 6 761 097 , 34 40 6 770 603 | |
| | | | 09.2007 | | 24.0330-0173.1 | 530173 | POWER-DISC | 34 11 6 753 221 , 34 11 6 767 269 | |
| | | | 07.2005 | | 24.0324-0181.1 | 524181 | POWER-DISC | 34 11 6 764 021 | |
| | | | 07.2005 | | 24.0330-0173.1 | 530173 | POWER-DISC | 34 11 6 753 221 , 34 11 6 767 269 | |
| | 520 i | ArG | 07.2003 | 03.2005 | 24.3727-0236.2 | 580236 | CABLE FREIN A MAIN | 34 40 6 761 097 , 34 40 6 770 603 | |
| | | ArD | 07.2003 | 03.2005 | 24.3727-0237.2 | 580237 | CABLE FREIN A MAIN | 34 40 6 761 098 , 34 40 6 770 602 | |
| | | | 07.2003 | 03.2005 | 24.0324-0181.1 | 524181 | POWER-DISC | 34 11 6 764 021 | |
| | | | 07.2003 | 03.2005 | 24.0330-0173.1 | 530173 | POWER-DISC | 34 11 6 753 221 , 34 11 6 767 269 | |
| | 523 i | ArG | 03.2007 | | 24.3727-0236.2 | 580236 | CABLE FREIN A MAIN | 34 40 6 761 097 , 34 40 6 770 603 | |
| | | ArD | 03.2007 | | 24.3727-0237.2 | 580237 | CABLE FREIN A MAIN | 34 40 6 761 098 , 34 40 6 770 602 | |
| | | ArD | 07.2005 | 03.2007 | 24.3727-0237.2 | 580237 | CABLE FREIN A MAIN | 34 40 6 761 098 , 34 40 6 770 602 | |
| | | ArG | 07.2005 | 03.2007 | 24.3727-0236.2 | 580236 | CABLE FREIN A MAIN | 34 40 6 761 097 , 34 40 6 770 603 | |

Nouvelles références disponibles - par applications

09/2008



| | | | | | | | | |
|--|--|--|--|--|-------------|----------------------------------|--|--------------------------------|
| | | | | | description | Références OE par référence ATE. | | Références remplacées / divers |
|--|--|--|--|--|-------------|----------------------------------|--|--------------------------------|







BMW

| | | | | | | | | | |
|---------------------------|-------|-----|---------|---------|----------------|--------|--------------------|-----------------------------------|--|
| Série 5/E60 Berline (03-) | 523 i | | 03.2007 | | 24.0330-0173.1 | 530173 | POWER-DISC | 34 11 6 753 221 , 34 11 6 767 269 | |
| | | | 03.2007 | | 24.0324-0181.1 | 524181 | POWER-DISC | 34 11 6 764 021 | |
| | | | 07.2005 | 03.2007 | 24.0324-0181.1 | 524181 | POWER-DISC | 34 11 6 764 021 | |
| | | | 07.2005 | 03.2007 | 24.0330-0173.1 | 530173 | POWER-DISC | 34 11 6 753 221 , 34 11 6 767 269 | |
| | 525 d | ArG | 10.2003 | 03.2007 | 24.3727-0236.2 | 580236 | CABLE FREIN A MAIN | 34 40 6 761 097 , 34 40 6 770 603 | |
| | | ArG | 03.2007 | | 24.3727-0236.2 | 580236 | CABLE FREIN A MAIN | 34 40 6 761 097 , 34 40 6 770 603 | |
| | | ArD | 03.2007 | | 24.3727-0237.2 | 580237 | CABLE FREIN A MAIN | 34 40 6 761 098 , 34 40 6 770 602 | |
| | | ArD | 10.2003 | 03.2007 | 24.3727-0237.2 | 580237 | CABLE FREIN A MAIN | 34 40 6 761 098 , 34 40 6 770 602 | |
| | | | 10.2003 | 03.2007 | 24.0324-0181.1 | 524181 | POWER-DISC | 34 11 6 764 021 | |
| | | | 03.2007 | | 24.0330-0173.1 | 530173 | POWER-DISC | 34 11 6 753 221 , 34 11 6 767 269 | |
| | | | 10.2003 | 03.2007 | 24.0330-0173.1 | 530173 | POWER-DISC | 34 11 6 753 221 , 34 11 6 767 269 | |
| | 525 i | ArG | 07.2003 | 06.2005 | 24.3727-0236.2 | 580236 | CABLE FREIN A MAIN | 34 40 6 761 097 , 34 40 6 770 603 | |
| | | ArG | 07.2005 | | 24.3727-0236.2 | 580236 | CABLE FREIN A MAIN | 34 40 6 761 097 , 34 40 6 770 603 | |
| | | ArD | 07.2003 | 06.2005 | 24.3727-0237.2 | 580237 | CABLE FREIN A MAIN | 34 40 6 761 098 , 34 40 6 770 602 | |

Nouvelles références disponibles - par applications

09/2008



| | | | | | | | | |
|---|---|---|---|---|-------------|----------------------------------|---|--------------------------------|
|  |  |  |  |  | description | Références OE par référence ATE. |  | Références remplacées / divers |
|---|---|---|---|---|-------------|----------------------------------|---|--------------------------------|







BMW

| | | | | | | | | | |
|---------------------------|--------|-----|---------|---------|----------------|--------|--------------------|-----------------------------------|--|
| Série 5/E60 Berline (03-) | 525 i | ArD | 07.2005 | | 24.3727-0237.2 | 580237 | CABLE FREIN A MAIN | 34 40 6 761 098 , 34 40 6 770 602 | |
| | | | 03.2007 | | 24.0330-0173.1 | 530173 | POWER-DISC | 34 11 6 753 221 , 34 11 6 767 269 | |
| | | | 07.2005 | 03.2007 | 24.0330-0173.1 | 530173 | POWER-DISC | 34 11 6 753 221 , 34 11 6 767 269 | |
| | | | 07.2003 | 06.2005 | 24.0324-0181.1 | 524181 | POWER-DISC | 34 11 6 764 021 | |
| | | | 03.2007 | | 24.0324-0181.1 | 524181 | POWER-DISC | 34 11 6 764 021 | |
| | | | 07.2003 | 06.2005 | 24.0330-0173.1 | 530173 | POWER-DISC | 34 11 6 753 221 , 34 11 6 767 269 | |
| | 525 xd | ArG | 03.2007 | | 24.3727-0236.2 | 580236 | CABLE FREIN A MAIN | 34 40 6 761 097 , 34 40 6 770 603 | |
| | | ArD | 03.2007 | | 24.3727-0237.2 | 580237 | CABLE FREIN A MAIN | 34 40 6 761 098 , 34 40 6 770 602 | |
| | | | 03.2007 | | 24.0330-0173.1 | 530173 | POWER-DISC | 34 11 6 753 221 , 34 11 6 767 269 | |
| | 525 xi | ArG | 07.2005 | | 24.3727-0236.2 | 580236 | CABLE FREIN A MAIN | 34 40 6 761 097 , 34 40 6 770 603 | |
| | | ArD | 07.2005 | | 24.3727-0237.2 | 580237 | CABLE FREIN A MAIN | 34 40 6 761 098 , 34 40 6 770 602 | |
| | | | 07.2005 | | 24.0330-0173.1 | 530173 | POWER-DISC | 34 11 6 753 221 , 34 11 6 767 269 | |
| | 530 d | ArG | 07.2003 | 08.2005 | 24.3727-0236.2 | 580236 | CABLE FREIN A MAIN | 34 40 6 761 097 , 34 40 6 770 603 | |
| | | ArG | 03.2007 | | 24.3727-0236.2 | 580236 | CABLE FREIN A MAIN | 34 40 6 761 097 , 34 40 6 770 603 | |

Nouvelles références disponibles - par applications

09/2008



| | | | | | | | | | |
|---|---|---|---|---|--|-------------|----------------------------------|---|--------------------------------|
|  |  |  |  |  | | description | Références OE par référence ATE. |  | Références remplacées / divers |
|---|---|---|---|---|--|-------------|----------------------------------|---|--------------------------------|







BMW

| Série 5/E60 Berline (03-) | 530 d | ArG | 07.2003 | 03.2007 | 24.3727-0236.2 | 580236 | CABLE FREIN A MAIN | 34 40 6 761 097 , 34 40 6 770 603 | |
|---------------------------|-------|-----|---------|---------|----------------|--------|--------------------|-----------------------------------|--|
| | | ArD | 03.2007 | | 24.3727-0237.2 | 580237 | CABLE FREIN A MAIN | 34 40 6 761 098 , 34 40 6 770 602 | |
| | | ArD | 07.2003 | 03.2007 | 24.3727-0237.2 | 580237 | CABLE FREIN A MAIN | 34 40 6 761 098 , 34 40 6 770 602 | |
| | | ArD | 07.2003 | 08.2005 | 24.3727-0237.2 | 580237 | CABLE FREIN A MAIN | 34 40 6 761 098 , 34 40 6 770 602 | |
| | | | 07.2003 | 08.2005 | 24.0330-0173.1 | 530173 | POWER-DISC | 34 11 6 753 221 , 34 11 6 767 269 | |
| | | | 07.2003 | 03.2007 | 24.0330-0173.1 | 530173 | POWER-DISC | 34 11 6 753 221 , 34 11 6 767 269 | |
| | | | 03.2007 | | 24.0330-0173.1 | 530173 | POWER-DISC | 34 11 6 753 221 , 34 11 6 767 269 | |
| | 530 i | ArD | 03.2007 | | 24.3727-0237.2 | 580237 | CABLE FREIN A MAIN | 34 40 6 761 098 , 34 40 6 770 602 | |
| | | ArG | 03.2007 | | 24.3727-0236.2 | 580236 | CABLE FREIN A MAIN | 34 40 6 761 097 , 34 40 6 770 603 | |
| | | ArD | 07.2003 | 03.2005 | 24.3727-0237.2 | 580237 | CABLE FREIN A MAIN | 34 40 6 761 098 , 34 40 6 770 602 | |
| | | ArG | 07.2005 | 03.2007 | 24.3727-0236.2 | 580236 | CABLE FREIN A MAIN | 34 40 6 761 097 , 34 40 6 770 603 | |
| | | ArG | 07.2003 | 03.2005 | 24.3727-0236.2 | 580236 | CABLE FREIN A MAIN | 34 40 6 761 097 , 34 40 6 770 603 | |
| | | ArD | 07.2005 | 03.2007 | 24.3727-0237.2 | 580237 | CABLE FREIN A MAIN | 34 40 6 761 098 , 34 40 6 770 602 | |

Nouvelles références disponibles - par applications

09/2008



| | | | | | | | | |
|---|---|---|---|---|-------------|----------------------------------|---|--------------------------------|
|  |  |  |  |  | description | Références OE par référence ATE. |  | Références remplacées / divers |
|---|---|---|---|---|-------------|----------------------------------|---|--------------------------------|







BMW

| | | | | | | | | | |
|---------------------------|--------|-----|---------|---------|----------------|--------|--------------------|-----------------------------------|--|
| Série 5/E60 Berline (03-) | 530 i | | 07.2005 | 03.2007 | 24.0330-0173.1 | 530173 | POWER-DISC | 34 11 6 753 221 , 34 11 6 767 269 | |
| | | | 03.2007 | | 24.0330-0173.1 | 530173 | POWER-DISC | 34 11 6 753 221 , 34 11 6 767 269 | |
| | | | 07.2003 | 03.2005 | 24.0330-0173.1 | 530173 | POWER-DISC | 34 11 6 753 221 , 34 11 6 767 269 | |
| | 530 xd | ArD | 03.2007 | | 24.3727-0237.2 | 580237 | CABLE FREIN A MAIN | 34 40 6 761 098 , 34 40 6 770 602 | |
| | | ArD | 07.2005 | 03.2007 | 24.3727-0237.2 | 580237 | CABLE FREIN A MAIN | 34 40 6 761 098 , 34 40 6 770 602 | |
| | | ArG | 07.2005 | 03.2007 | 24.3727-0236.2 | 580236 | CABLE FREIN A MAIN | 34 40 6 761 097 , 34 40 6 770 603 | |
| | | ArG | 03.2007 | | 24.3727-0236.2 | 580236 | CABLE FREIN A MAIN | 34 40 6 761 097 , 34 40 6 770 603 | |
| | | | 03.2007 | | 24.0330-0173.1 | 530173 | POWER-DISC | 34 11 6 753 221 , 34 11 6 767 269 | |
| | | | 07.2005 | 03.2007 | 24.0330-0173.1 | 530173 | POWER-DISC | 34 11 6 753 221 , 34 11 6 767 269 | |
| | 530 xi | ArD | 07.2005 | 03.2007 | 24.3727-0237.2 | 580237 | CABLE FREIN A MAIN | 34 40 6 761 098 , 34 40 6 770 602 | |
| | | ArG | 07.2005 | 03.2007 | 24.3727-0236.2 | 580236 | CABLE FREIN A MAIN | 34 40 6 761 097 , 34 40 6 770 603 | |
| | | ArG | 03.2007 | | 24.3727-0236.2 | 580236 | CABLE FREIN A MAIN | 34 40 6 761 097 , 34 40 6 770 603 | |
| | | ArD | 03.2007 | | 24.3727-0237.2 | 580237 | CABLE FREIN A MAIN | 34 40 6 761 098 , 34 40 6 770 602 | |

Nouvelles références disponibles - par applications

09/2008



| | | | | | | | | |
|---|---|---|---|---|-------------|----------------------------------|---|--------------------------------|
|  |  |  |  |  | description | Références OE par référence ATE. |  | Références remplacées / divers |
|---|---|---|---|---|-------------|----------------------------------|---|--------------------------------|







BMW

| | | | | | | | | | |
|---------------------------|--------|-----|---------|---------|----------------|--------|--------------------|-----------------------------------|--|
| Série 5/E60 Berline (03-) | 530 xi | | 03.2007 | | 24.0330-0173.1 | 530173 | POWER-DISC | 34 11 6 753 221 , 34 11 6 767 269 | |
| | | | 07.2005 | 03.2007 | 24.0330-0173.1 | 530173 | POWER-DISC | 34 11 6 753 221 , 34 11 6 767 269 | |
| | 535 d | | 09.2004 | 03.2007 | 24.0136-0106.2 | 436106 | DISQUE DE FREIN | 34 11 6 766 871 , 34 11 6 779 467 | |
| | | | 03.2007 | | 24.0136-0106.2 | 436106 | DISQUE DE FREIN | 34 11 6 766 871 , 34 11 6 779 467 | |
| | | ArG | 03.2007 | | 24.3727-0236.2 | 580236 | CABLE FREIN A MAIN | 34 40 6 761 097 , 34 40 6 770 603 | |
| | | ArD | 03.2007 | | 24.3727-0237.2 | 580237 | CABLE FREIN A MAIN | 34 40 6 761 098 , 34 40 6 770 602 | |
| | | ArG | 09.2004 | 03.2007 | 24.3727-0236.2 | 580236 | CABLE FREIN A MAIN | 34 40 6 761 097 , 34 40 6 770 603 | |
| | | ArD | 09.2004 | 03.2007 | 24.3727-0237.2 | 580237 | CABLE FREIN A MAIN | 34 40 6 761 098 , 34 40 6 770 602 | |
| | 540 i | | 03.2007 | | 24.0136-0106.2 | 436106 | DISQUE DE FREIN | 34 11 6 766 871 , 34 11 6 779 467 | |
| | | ArD | 07.2005 | | 24.3727-0237.2 | 580237 | CABLE FREIN A MAIN | 34 40 6 761 098 , 34 40 6 770 602 | |
| | | ArG | 07.2005 | | 24.3727-0236.2 | 580236 | CABLE FREIN A MAIN | 34 40 6 761 097 , 34 40 6 770 603 | |
| | 545 i | ArD | 07.2003 | 08.2005 | 24.3727-0237.2 | 580237 | CABLE FREIN A MAIN | 34 40 6 761 098 , 34 40 6 770 602 | |
| | | ArG | 07.2003 | 08.2005 | 24.3727-0236.2 | 580236 | CABLE FREIN A MAIN | 34 40 6 761 097 , 34 40 6 770 603 | |

Nouvelles références disponibles - par applications

09/2008



| | | | | | | | |
|---|---|---|---|---|-------------|----------------------------------|--|
|  |  |  |  |  | description | Références OE par référence ATE. |  Références remplacées / divers |
|---|---|---|---|---|-------------|----------------------------------|--|







BMW

| | | | | | | | | | |
|---------------------------|-------|-----|---------|---------|----------------|--------|--------------------|-----------------------------------|--|
| Série 5/E60 Berline (03-) | 550 i | | 07.2005 | 03.2007 | 24.0136-0106.2 | 436106 | DISQUE DE FREIN | 34 11 6 766 871 , 34 11 6 779 467 | |
| | | | 03.2007 | | 24.0136-0106.2 | 436106 | DISQUE DE FREIN | 34 11 6 766 871 , 34 11 6 779 467 | |
| | | ArD | 07.2005 | | 24.3727-0237.2 | 580237 | CABLE FREIN A MAIN | 34 40 6 761 098 , 34 40 6 770 602 | |
| | | ArG | 07.2005 | | 24.3727-0236.2 | 580236 | CABLE FREIN A MAIN | 34 40 6 761 097 , 34 40 6 770 603 | |
| | M5 | ArG | 09.2004 | | 24.3727-0236.2 | 580236 | CABLE FREIN A MAIN | 34 40 6 761 097 , 34 40 6 770 603 | |
| | | ArD | 09.2004 | | 24.3727-0237.2 | 580237 | CABLE FREIN A MAIN | 34 40 6 761 098 , 34 40 6 770 602 | |
| Série 5/E61 Touring (04-) | 520 d | ArG | 09.2007 | | 24.3727-0236.2 | 580236 | CABLE FREIN A MAIN | 34 40 6 761 097 , 34 40 6 770 603 | |
| | | ArG | 07.2005 | | 24.3727-0236.2 | 580236 | CABLE FREIN A MAIN | 34 40 6 761 097 , 34 40 6 770 603 | |
| | | ArD | 09.2007 | | 24.3727-0237.2 | 580237 | CABLE FREIN A MAIN | 34 40 6 761 098 , 34 40 6 770 602 | |
| | | ArD | 07.2005 | | 24.3727-0237.2 | 580237 | CABLE FREIN A MAIN | 34 40 6 761 098 , 34 40 6 770 602 | |
| | | | 07.2005 | | 24.0324-0181.1 | 524181 | POWER-DISC | 34 11 6 764 021 | |
| | | | 09.2007 | | 24.0330-0173.1 | 530173 | POWER-DISC | 34 11 6 753 221 , 34 11 6 767 269 | |
| | | | 07.2005 | | 24.0330-0173.1 | 530173 | POWER-DISC | 34 11 6 753 221 , 34 11 6 767 269 | |
| | 523 i | ArD | 07.2005 | 03.2007 | 24.3727-0237.2 | 580237 | CABLE FREIN A MAIN | 34 40 6 761 098 , 34 40 6 770 602 | |

Nouvelles références disponibles - par applications

09/2008



| | | | | | | | | |
|---|---|---|---|---|-------------|----------------------------------|---|--------------------------------|
|  |  |  |  |  | description | Références OE par référence ATE. |  | Références remplacées / divers |
|---|---|---|---|---|-------------|----------------------------------|---|--------------------------------|







BMW

| | | | | | | | | | |
|---------------------------|-------|-----|---------|---------|----------------|--------|--------------------|-----------------------------------|--|
| Série 5/E61 Touring (04-) | 523 i | ArG | 03.2007 | | 24.3727-0236.2 | 580236 | CABLE FREIN A MAIN | 34 40 6 761 097 , 34 40 6 770 603 | |
| | | ArD | 03.2007 | | 24.3727-0237.2 | 580237 | CABLE FREIN A MAIN | 34 40 6 761 098 , 34 40 6 770 602 | |
| | | ArG | 07.2005 | 03.2007 | 24.3727-0236.2 | 580236 | CABLE FREIN A MAIN | 34 40 6 761 097 , 34 40 6 770 603 | |
| | | | 03.2007 | | 24.0330-0173.1 | 530173 | POWER-DISC | 34 11 6 753 221 , 34 11 6 767 269 | |
| | | | 07.2005 | 03.2007 | 24.0324-0181.1 | 524181 | POWER-DISC | 34 11 6 764 021 | |
| | | | 07.2005 | 03.2007 | 24.0330-0173.1 | 530173 | POWER-DISC | 34 11 6 753 221 , 34 11 6 767 269 | |
| | | | 03.2007 | | 24.0324-0181.1 | 524181 | POWER-DISC | 34 11 6 764 021 | |
| | 525 d | ArG | 05.2004 | 03.2007 | 24.3727-0236.2 | 580236 | CABLE FREIN A MAIN | 34 40 6 761 097 , 34 40 6 770 603 | |
| | | ArG | 03.2007 | | 24.3727-0236.2 | 580236 | CABLE FREIN A MAIN | 34 40 6 761 097 , 34 40 6 770 603 | |
| | | ArD | 03.2007 | | 24.3727-0237.2 | 580237 | CABLE FREIN A MAIN | 34 40 6 761 098 , 34 40 6 770 602 | |
| | | ArD | 05.2004 | 03.2007 | 24.3727-0237.2 | 580237 | CABLE FREIN A MAIN | 34 40 6 761 098 , 34 40 6 770 602 | |
| | | | 05.2004 | 03.2007 | 24.0324-0181.1 | 524181 | POWER-DISC | 34 11 6 764 021 | |
| | | | 05.2004 | 03.2007 | 24.0330-0173.1 | 530173 | POWER-DISC | 34 11 6 753 221 , 34 11 6 767 269 | |
| | | | 03.2007 | | 24.0330-0173.1 | 530173 | POWER-DISC | 34 11 6 753 221 , 34 11 6 767 269 | |

Nouvelles références disponibles - par applications

09/2008



| | | | | | | | | | |
|---|---|---|---|---|--|-------------|----------------------------------|---|--------------------------------|
|  |  |  |  |  | | description | Références OE par référence ATE. |  | Références remplacées / divers |
|---|---|---|---|---|--|-------------|----------------------------------|---|--------------------------------|







BMW

| | | | | | | | | | |
|---------------------------|--------|-----|---------|---------|----------------|--------|--------------------|-----------------------------------|--|
| Série 5/E61 Touring (04-) | 525 i | ArG | 05.2004 | 03.2005 | 24.3727-0236.2 | 580236 | CABLE FREIN A MAIN | 34 40 6 761 097 , 34 40 6 770 603 | |
| | | ArG | 07.2005 | | 24.3727-0236.2 | 580236 | CABLE FREIN A MAIN | 34 40 6 761 097 , 34 40 6 770 603 | |
| | | ArD | 07.2005 | | 24.3727-0237.2 | 580237 | CABLE FREIN A MAIN | 34 40 6 761 098 , 34 40 6 770 602 | |
| | | ArD | 05.2004 | 03.2005 | 24.3727-0237.2 | 580237 | CABLE FREIN A MAIN | 34 40 6 761 098 , 34 40 6 770 602 | |
| | | | 07.2005 | 03.2007 | 24.0330-0173.1 | 530173 | POWER-DISC | 34 11 6 753 221 , 34 11 6 767 269 | |
| | | | 03.2007 | | 24.0330-0173.1 | 530173 | POWER-DISC | 34 11 6 753 221 , 34 11 6 767 269 | |
| | | | 05.2004 | 03.2005 | 24.0330-0173.1 | 530173 | POWER-DISC | 34 11 6 753 221 , 34 11 6 767 269 | |
| | | | 03.2007 | | 24.0324-0181.1 | 524181 | POWER-DISC | 34 11 6 764 021 | |
| | | | 05.2004 | 03.2005 | 24.0324-0181.1 | 524181 | POWER-DISC | 34 11 6 764 021 | |
| | 525 xd | ArG | 03.2007 | | 24.3727-0236.2 | 580236 | CABLE FREIN A MAIN | 34 40 6 761 097 , 34 40 6 770 603 | |
| | | ArD | 03.2007 | | 24.3727-0237.2 | 580237 | CABLE FREIN A MAIN | 34 40 6 761 098 , 34 40 6 770 602 | |
| | | | 03.2007 | | 24.0330-0173.1 | 530173 | POWER-DISC | 34 11 6 753 221 , 34 11 6 767 269 | |
| | 525 xi | ArG | 07.2005 | | 24.3727-0236.2 | 580236 | CABLE FREIN A MAIN | 34 40 6 761 097 , 34 40 6 770 603 | |
| | | ArD | 07.2005 | | 24.3727-0237.2 | 580237 | CABLE FREIN A MAIN | 34 40 6 761 098 , 34 40 6 770 602 | |

Nouvelles références disponibles - par applications

09/2008



| | | | | | | | | |
|---|---|---|---|---|-------------|----------------------------------|---|--------------------------------|
|  |  |  |  |  | description | Références OE par référence ATE. |  | Références remplacées / divers |
|---|---|---|---|---|-------------|----------------------------------|---|--------------------------------|







BMW

| | | | | | | | | | |
|---------------------------|--------|-----|---------|---------|----------------|--------|--------------------|-----------------------------------|--|
| Série 5/E61 Touring (04-) | 525 xi | | 07.2005 | | 24.0330-0173.1 | 530173 | POWER-DISC | 34 11 6 753 221 , 34 11 6 767 269 | |
| | 530 d | ArG | 05.2004 | 08.2005 | 24.3727-0236.2 | 580236 | CABLE FREIN A MAIN | 34 40 6 761 097 , 34 40 6 770 603 | |
| | | ArD | 07.2005 | 03.2007 | 24.3727-0237.2 | 580237 | CABLE FREIN A MAIN | 34 40 6 761 098 , 34 40 6 770 602 | |
| | | ArD | 05.2004 | 08.2005 | 24.3727-0237.2 | 580237 | CABLE FREIN A MAIN | 34 40 6 761 098 , 34 40 6 770 602 | |
| | | ArD | 03.2007 | | 24.3727-0237.2 | 580237 | CABLE FREIN A MAIN | 34 40 6 761 098 , 34 40 6 770 602 | |
| | | ArG | 03.2007 | | 24.3727-0236.2 | 580236 | CABLE FREIN A MAIN | 34 40 6 761 097 , 34 40 6 770 603 | |
| | | ArG | 07.2005 | 03.2007 | 24.3727-0236.2 | 580236 | CABLE FREIN A MAIN | 34 40 6 761 097 , 34 40 6 770 603 | |
| | | | 07.2005 | 03.2007 | 24.0330-0173.1 | 530173 | POWER-DISC | 34 11 6 753 221 , 34 11 6 767 269 | |
| | | | 03.2007 | | 24.0330-0173.1 | 530173 | POWER-DISC | 34 11 6 753 221 , 34 11 6 767 269 | |
| | | | 05.2004 | 08.2005 | 24.0330-0173.1 | 530173 | POWER-DISC | 34 11 6 753 221 , 34 11 6 767 269 | |
| | 530 i | ArG | 03.2007 | | 24.3727-0236.2 | 580236 | CABLE FREIN A MAIN | 34 40 6 761 097 , 34 40 6 770 603 | |
| | | ArD | 03.2007 | | 24.3727-0237.2 | 580237 | CABLE FREIN A MAIN | 34 40 6 761 098 , 34 40 6 770 602 | |
| | | ArD | 07.2005 | 03.2007 | 24.3727-0237.2 | 580237 | CABLE FREIN A MAIN | 34 40 6 761 098 , 34 40 6 770 602 | |

Nouvelles références disponibles - par applications

09/2008



| | | | | | | | |
|---|---|---|---|---|-------------|----------------------------------|--|
|  |  |  |  |  | description | Références OE par référence ATE. |  Références remplacées / divers |
|---|---|---|---|---|-------------|----------------------------------|--|







BMW

| | | | | | | | | | |
|---------------------------|--------|-----|---------|---------|----------------|--------|--------------------|-----------------------------------|--|
| Série 5/E61 Touring (04-) | 530 i | ArG | 07.2005 | 03.2007 | 24.3727-0236.2 | 580236 | CABLE FREIN A MAIN | 34 40 6 761 097 , 34 40 6 770 603 | |
| | | | 03.2007 | | 24.0330-0173.1 | 530173 | POWER-DISC | 34 11 6 753 221 , 34 11 6 767 269 | |
| | | | 07.2005 | 03.2007 | 24.0330-0173.1 | 530173 | POWER-DISC | 34 11 6 753 221 , 34 11 6 767 269 | |
| | 530 xd | ArG | 07.2005 | 03.2007 | 24.3727-0236.2 | 580236 | CABLE FREIN A MAIN | 34 40 6 761 097 , 34 40 6 770 603 | |
| | | ArG | 03.2007 | | 24.3727-0236.2 | 580236 | CABLE FREIN A MAIN | 34 40 6 761 097 , 34 40 6 770 603 | |
| | | ArD | 03.2007 | | 24.3727-0237.2 | 580237 | CABLE FREIN A MAIN | 34 40 6 761 098 , 34 40 6 770 602 | |
| | | ArD | 07.2005 | 03.2007 | 24.3727-0237.2 | 580237 | CABLE FREIN A MAIN | 34 40 6 761 098 , 34 40 6 770 602 | |
| | | | 03.2007 | | 24.0330-0173.1 | 530173 | POWER-DISC | 34 11 6 753 221 , 34 11 6 767 269 | |
| | | | 07.2005 | 03.2007 | 24.0330-0173.1 | 530173 | POWER-DISC | 34 11 6 753 221 , 34 11 6 767 269 | |
| | 530 xi | ArD | 03.2007 | | 24.3727-0237.2 | 580237 | CABLE FREIN A MAIN | 34 40 6 761 098 , 34 40 6 770 602 | |
| | | ArD | 07.2005 | 03.2007 | 24.3727-0237.2 | 580237 | CABLE FREIN A MAIN | 34 40 6 761 098 , 34 40 6 770 602 | |
| | | ArG | 03.2007 | | 24.3727-0236.2 | 580236 | CABLE FREIN A MAIN | 34 40 6 761 097 , 34 40 6 770 603 | |
| | | ArG | 07.2005 | 03.2007 | 24.3727-0236.2 | 580236 | CABLE FREIN A MAIN | 34 40 6 761 097 , 34 40 6 770 603 | |

Nouvelles références disponibles - par applications

09/2008



| | | | | | | | |
|---|---|---|---|---|-------------|----------------------------------|--|
|  |  |  |  |  | description | Références OE par référence ATE. |  Références remplacées / divers |
|---|---|---|---|---|-------------|----------------------------------|--|







BMW

| | | | | | | | | | |
|---------------------------|--------|-----|---------|---------|----------------|--------|--------------------|-----------------------------------|--|
| Série 5/E61 Touring (04-) | 530 xi | | 07.2005 | 03.2007 | 24.0330-0173.1 | 530173 | POWER-DISC | 34 11 6 753 221 , 34 11 6 767 269 | |
| | | | 03.2007 | | 24.0330-0173.1 | 530173 | POWER-DISC | 34 11 6 753 221 , 34 11 6 767 269 | |
| | 535 d | | 09.2004 | 03.2007 | 24.0136-0106.2 | 436106 | DISQUE DE FREIN | 34 11 6 766 871 , 34 11 6 779 467 | |
| | | | 03.2007 | | 24.0136-0106.2 | 436106 | DISQUE DE FREIN | 34 11 6 766 871 , 34 11 6 779 467 | |
| | | ArG | 03.2007 | | 24.3727-0236.2 | 580236 | CABLE FREIN A MAIN | 34 40 6 761 097 , 34 40 6 770 603 | |
| | | ArG | 09.2004 | 03.2007 | 24.3727-0236.2 | 580236 | CABLE FREIN A MAIN | 34 40 6 761 097 , 34 40 6 770 603 | |
| | | ArD | 09.2004 | 03.2007 | 24.3727-0237.2 | 580237 | CABLE FREIN A MAIN | 34 40 6 761 098 , 34 40 6 770 602 | |
| | | ArD | 03.2007 | | 24.3727-0237.2 | 580237 | CABLE FREIN A MAIN | 34 40 6 761 098 , 34 40 6 770 602 | |
| | 545 i | ArG | 05.2004 | 08.2005 | 24.3727-0236.2 | 580236 | CABLE FREIN A MAIN | 34 40 6 761 097 , 34 40 6 770 603 | |
| | | ArD | 05.2004 | 08.2005 | 24.3727-0237.2 | 580237 | CABLE FREIN A MAIN | 34 40 6 761 098 , 34 40 6 770 602 | |
| | 550 i | | 07.2005 | 03.2007 | 24.0136-0106.2 | 436106 | DISQUE DE FREIN | 34 11 6 766 871 , 34 11 6 779 467 | |
| | | | 03.2007 | | 24.0136-0106.2 | 436106 | DISQUE DE FREIN | 34 11 6 766 871 , 34 11 6 779 467 | |
| | | ArG | 07.2005 | | 24.3727-0236.2 | 580236 | CABLE FREIN A MAIN | 34 40 6 761 097 , 34 40 6 770 603 | |

Nouvelles références disponibles - par applications

09/2008



| | | | | | | | |
|---|---|---|---|---|-------------|----------------------------------|--|
|  |  |  |  |  | description | Références OE par référence ATE. |  Références remplacées / divers |
|---|---|---|---|---|-------------|----------------------------------|--|

BMW

| | | | | | | | | | |
|-------------------------------|---------|-----|---------|---------|----------------|--------|--------------------|-----------------------------------|--|
| Série 5/E61 Touring (04-) | 550 i | ArD | 07.2005 | | 24.3727-0237.2 | 580237 | CABLE FREIN A MAIN | 34 40 6 761 098 , 34 40 6 770 602 | |
| | M5 | ArG | 02.2007 | | 24.3727-0236.2 | 580236 | CABLE FREIN A MAIN | 34 40 6 761 097 , 34 40 6 770 603 | |
| | | ArD | 02.2007 | | 24.3727-0237.2 | 580237 | CABLE FREIN A MAIN | 34 40 6 761 098 , 34 40 6 770 602 | |
| Série 6/E63 Coupé (04-) | 630 i | | 07.2004 | 08.2007 | 24.0330-0173.1 | 530173 | POWER-DISC | 34 11 6 753 221 , 34 11 6 767 269 | |
| | 635 d | | 09.2007 | | 24.0136-0106.2 | 436106 | DISQUE DE FREIN | 34 11 6 766 871 , 34 11 6 779 467 | |
| | 650 i | | 07.2005 | | 24.0136-0106.2 | 436106 | DISQUE DE FREIN | 34 11 6 766 871 , 34 11 6 779 467 | |
| Série 6/E64 Décapotable (04-) | 630 i | | 07.2004 | 08.2007 | 24.0330-0173.1 | 530173 | POWER-DISC | 34 11 6 753 221 , 34 11 6 767 269 | |
| | 635 d | | 09.2007 | | 24.0136-0106.2 | 436106 | DISQUE DE FREIN | 34 11 6 766 871 , 34 11 6 779 467 | |
| | 650 i | | 07.2005 | | 24.0136-0106.2 | 436106 | DISQUE DE FREIN | 34 11 6 766 871 , 34 11 6 779 467 | |
| Série 7/E38 (93-01) | 725 tds | ArG | 05.1996 | 11.2001 | 24.3727-0232.2 | 580232 | CABLE FREIN A MAIN | 35 51 1 161 473 | |
| | 728 i | ArG | 07.1995 | 11.2001 | 24.3727-0232.2 | 580232 | CABLE FREIN A MAIN | 35 51 1 161 473 | |
| | 728 iL | ArG | 01.1996 | 11.2001 | 24.3727-0232.2 | 580232 | CABLE FREIN A MAIN | 35 51 1 161 473 | |
| | 730 d | ArG | 09.1998 | 11.2001 | 24.3727-0232.2 | 580232 | CABLE FREIN A MAIN | 35 51 1 161 473 | |
| | 730 i | ArG | 07.1993 | 11.2001 | 24.3727-0232.2 | 580232 | CABLE FREIN A MAIN | 35 51 1 161 473 | |
| | 730 iL | ArG | 05.1994 | 11.2001 | 24.3727-0232.2 | 580232 | CABLE FREIN A MAIN | 35 51 1 161 473 | |

Nouvelles références disponibles - par applications

09/2008



| | | | | | | | | |
|--|--|--|--|--|-------------|----------------------------------|--|--------------------------------|
| | | | | | description | Références OE par référence ATE. | | Références remplacées / divers |
|--|--|--|--|--|-------------|----------------------------------|--|--------------------------------|

BMW

| | | | | | | | | | |
|---------------------|--------|-----|---------|---------|----------------|--------|---------------------|-----------------|-----------|
| Série 7/E38 (93-01) | 735 i | ArG | 01.1996 | 11.2001 | 24.3727-0232.2 | 580232 | CABLE FREIN A MAIN | 35 51 1 161 473 | |
| | 735 iL | ArG | 01.1996 | 11.2001 | 24.3727-0232.2 | 580232 | CABLE FREIN A MAIN | 35 51 1 161 473 | |
| | 740 d | ArG | 05.1999 | 11.2001 | 24.3727-0232.2 | 580232 | CABLE FREIN A MAIN | 35 51 1 161 473 | |
| | 740 i | ArG | 07.1993 | 11.2001 | 24.3727-0232.2 | 580232 | CABLE FREIN A MAIN | 35 51 1 161 473 | |
| | 740 iL | ArG | 05.1994 | 11.2001 | 24.3727-0232.2 | 580232 | CABLE FREIN A MAIN | 35 51 1 161 473 | |
| | 750 i | ArG | 11.1993 | 11.2001 | 24.3727-0232.2 | 580232 | CABLE FREIN A MAIN | 35 51 1 161 473 | |
| | 750 iL | ArG | 01.1994 | 11.2001 | 24.3727-0232.2 | 580232 | CABLE FREIN A MAIN | 35 51 1 161 473 | |
| X3 (03-) | 2,0 d | ArG | 08.2004 | | 24.3727-0235.2 | 580235 | CABLE FREIN A MAIN | 34 40 3 400 795 | |
| | | ArG | 09.2007 | | 24.3727-0235.2 | 580235 | CABLE FREIN A MAIN | 34 40 3 400 795 | |
| | 2,0 i | ArG | 07.2005 | | 24.3727-0235.2 | 580235 | CABLE FREIN A MAIN | 34 40 3 400 795 | |
| | 2,5 i | ArG | 03.2004 | 08.2006 | 24.3727-0235.2 | 580235 | CABLE FREIN A MAIN | 34 40 3 400 795 | |
| | 2,5 si | ArG | 09.2006 | | 24.3727-0235.2 | 580235 | CABLE FREIN A MAIN | 34 40 3 400 795 | |
| | 3,0 d | ArG | 10.2003 | 08.2006 | 24.3727-0235.2 | 580235 | CABLE FREIN A MAIN | 34 40 3 400 795 | |
| | | ArG | 01.2004 | | 24.3727-0235.2 | 580235 | CABLE FREIN A MAIN | 34 40 3 400 795 | |
| | 3,0 i | ArG | 10.2003 | 08.2006 | 24.3727-0235.2 | 580235 | CABLE FREIN A MAIN | 34 40 3 400 795 | |
| | 3,0 sd | ArG | 09.2006 | | 24.3727-0235.2 | 580235 | CABLE FREIN A MAIN | 34 40 3 400 795 | |
| | 3,0 si | ArG | 09.2006 | | 24.3727-0235.2 | 580235 | CABLE FREIN A MAIN | 34 40 3 400 795 | |
| X5 (07-) | 3,0 sd | | 09.2007 | | 13.0460-7239.2 | 607239 | PLAQUETTES DE FREIN | 34 11 6 778 048 | cf. Photo |
| | | | 09.2007 | | 24.8190-0255.2 | 620255 | TEMOIN D'USURE | 34 35 6 773 008 | |

Nouvelles références disponibles - par applications

09/2008



| | | | | | | | | |
|--|--|--|--|--|-------------|----------------------------------|--|--------------------------------|
| | | | | | description | Références OE par référence ATE. | | Références remplacées / divers |
|--|--|--|--|--|-------------|----------------------------------|--|--------------------------------|







BMW

| | | | | | | | | | |
|----------|-------|--|---------|--|----------------|--------|---------------------|-----------------|-----------|
| X5 (07-) | 4,8 i | | 01.2007 | | 13.0460-7239.2 | 607239 | PLAQUETTES DE FREIN | 34 11 6 778 048 | cf. Photo |
| | | | 01.2007 | | 24.8190-0255.2 | 620255 | TEMOIN D'USURE | 34 35 6 773 008 | |
| X6 (08-) | 35 d | | 01.2008 | | 13.0460-7239.2 | 607239 | PLAQUETTES DE FREIN | 34 11 6 778 048 | cf. Photo |
| | | | 01.2008 | | 24.8190-0255.2 | 620255 | TEMOIN D'USURE | 34 35 6 773 008 | |
| | 35 i | | 01.2008 | | 13.0460-7239.2 | 607239 | PLAQUETTES DE FREIN | 34 11 6 778 048 | cf. Photo |
| | | | 01.2008 | | 24.8190-0255.2 | 620255 | TEMOIN D'USURE | 34 35 6 773 008 | |

CITROEN

| | | | | | | | | | |
|--------------|-----------------|--|---------|--|----------------|--------|-----------------|---|--|
| JUMPER (06-) | 2,2 HDi (12/14) | | 04.2006 | | 24.0124-0208.1 | 424208 | DISQUE DE FREIN | 4249 26 , 51728377 , 51740244 , 4249 27 | |
| | 2,2 HDi (16H) | | 04.2006 | | 24.0124-0209.1 | 424209 | DISQUE DE FREIN | 4249 35 , 51728378 , 51740247 , 4249 36 | |
| | | | 04.2006 | | 24.0116-0125.1 | 416125 | DISQUE DE FREIN | 4249 39 , 51749275 , 51740248 , 4249 40 | |
| | 3,0 HDi (12/14) | | 09.2006 | | 24.0124-0208.1 | 424208 | DISQUE DE FREIN | 4249 26 , 51728377 , 51740244 , 4249 27 | |
| | 3,0 HDi (16H) | | 04.2006 | | 24.0116-0125.1 | 416125 | DISQUE DE FREIN | 4249 39 , 51749275 , 51740248 , 4249 40 | |
| | | | 09.2006 | | 24.0124-0209.1 | 424209 | DISQUE DE FREIN | 4249 35 , 51728378 , 51740247 , 4249 36 | |



| | | | | | | | |
|---|---|---|---|---|--------------------|---|---|
|  |  |  |  |  | <p>description</p> | <p>Références OE par référence ATE.</p> |  <p>Références remplacées / divers</p> |
|---|---|---|---|---|--------------------|---|---|

DAEWOO

| Modèle | Version | Année | Année | Code | Code | Description | Références OE | Références divers |
|-----------------|-----------|---------|---------|----------------|--------|-----------------|---------------|-------------------|
| LANOS (97-02) | 1,4 i | 05.1997 | 12.2002 | 24.5233-0180.3 | 330888 | FLEXIBLE FREIN | 96215570 | |
| | 1,5 i | 05.1997 | 12.2002 | 24.5233-0180.3 | 330888 | FLEXIBLE FREIN | 96215570 | |
| | 1,6 i 16V | 05.1997 | 12.2002 | 24.5233-0180.3 | 330888 | FLEXIBLE FREIN | 96215570 | |
| LEGANZA (97-02) | 2,0 i 16V | 06.1997 | 12.2002 | 24.0124-0723.1 | 424723 | DISQUE DE FREIN | 96238673 | |
| | | 07.2000 | 12.2002 | 24.0124-0723.1 | 424723 | DISQUE DE FREIN | 96238673 | |
| | 2,2 i 16V | 04.1999 | 12.2002 | 24.0124-0723.1 | 424723 | DISQUE DE FREIN | 96238673 | |



| | | | | | | | | |
|--|--|--|--|--|-------------|----------------------------------|--|--------------------------------|
| | | | | | description | Références OE par référence ATE. | | Références remplacées / divers |
|--|--|--|--|--|-------------|----------------------------------|--|--------------------------------|

FIAT

| | | | | | | | | | |
|--------------|----------------|--|---------|--|----------------|--------|---------------------|---|-----------|
| ALBEA (02-) | 1,2 i | | 03.2002 | | 13.0460-3849.2 | 603849 | PLAQUETTES DE FREIN | 77363782 | cf. Photo |
| | 1,2 i 16V | | 03.2002 | | 13.0460-3849.2 | 603849 | PLAQUETTES DE FREIN | 77363782 | cf. Photo |
| | 1,3 JTD | | 03.2002 | | 13.0460-3849.2 | 603849 | PLAQUETTES DE FREIN | 77363782 | cf. Photo |
| | 1,4 i | | 03.2002 | | 13.0460-3849.2 | 603849 | PLAQUETTES DE FREIN | 77363782 | cf. Photo |
| | 1,6 i 16V | | 03.2002 | | 13.0460-3849.2 | 603849 | PLAQUETTES DE FREIN | 77363782 | cf. Photo |
| DUCATO (06-) | 2,2 JTD (Q11) | | 07.2006 | | 24.0124-0208.1 | 424208 | DISQUE DE FREIN | 4249 26 , 51728377 , 51740244 , 4249 27 | |
| | 2,2 JTD (Q15) | | 07.2006 | | 24.0124-0208.1 | 424208 | DISQUE DE FREIN | 4249 26 , 51728377 , 51740244 , 4249 27 | |
| | 2,2 JTD (Q17H) | | 07.2006 | | 24.0116-0125.1 | 416125 | DISQUE DE FREIN | 4249 39 , 51749275 , 51740248 , 4249 40 | |
| | | | 07.2006 | | 24.0124-0209.1 | 424209 | DISQUE DE FREIN | 4249 35 , 51728378 , 51740247 , 4249 36 | |
| | 2,3 JTD (Q11) | | 07.2006 | | 24.0124-0208.1 | 424208 | DISQUE DE FREIN | 4249 26 , 51728377 , 51740244 , 4249 27 | |
| | 2,3 JTD (Q15) | | 07.2006 | | 24.0124-0208.1 | 424208 | DISQUE DE FREIN | 4249 26 , 51728377 , 51740244 , 4249 27 | |
| | 2,3 JTD (Q17H) | | 07.2006 | | 24.0124-0209.1 | 424209 | DISQUE DE FREIN | 4249 35 , 51728378 , 51740247 , 4249 36 | |
| | | | 07.2006 | | 24.0116-0125.1 | 416125 | DISQUE DE FREIN | 4249 39 , 51749275 , 51740248 , 4249 40 | |
| | 3,0 JTD (Q11) | | 07.2006 | | 24.0124-0208.1 | 424208 | DISQUE DE FREIN | 4249 26 , 51728377 , 51740244 , 4249 27 | |
| | 3,0 JTD (Q15) | | 07.2006 | | 24.0124-0208.1 | 424208 | DISQUE DE FREIN | 4249 26 , 51728377 , 51740244 , 4249 27 | |



| | | | | | | | | |
|--|--|--|--|--|-------------|----------------------------------|--|--------------------------------|
| | | | | | description | Références OE par référence ATE. | | Références remplacées / divers |
|--|--|--|--|--|-------------|----------------------------------|--|--------------------------------|

FIAT

| | | | | | | | | | |
|--------------------|------------------|--|---------|---------|----------------|--------|-----------------|---|--|
| DUCATO (06-) | 3,0 JTD (Q17H) | | 07.2006 | | 24.0116-0125.1 | 416125 | DISQUE DE FREIN | 4249 39 , 51749275 , 51740248 , 4249 40 | |
| | | | 07.2006 | | 24.0124-0209.1 | 424209 | DISQUE DE FREIN | 4249 35 , 51728378 , 51740247 , 4249 36 | |
| GRANDE PUNTO (06-) | 1,2 i | | 10.2006 | | 24.0112-0184.1 | 412184 | DISQUE DE FREIN | 93188916 , 55700918 , 55700398 , 5 69 022 | |
| IDEA (04-08) | 1,2 i 16V | | 01.2004 | 02.2008 | 83.7201-9173.3 | 330868 | FLEXIBLE FREIN | 46834651 | |
| | 1,3 JTD | | 01.2004 | 02.2008 | 83.7201-9173.3 | 330868 | FLEXIBLE FREIN | 46834651 | |
| | | | 11.2005 | 02.2008 | 83.7201-9173.3 | 330868 | FLEXIBLE FREIN | 46834651 | |
| | 1,4 i | | 11.2005 | 02.2008 | 83.7201-9173.3 | 330868 | FLEXIBLE FREIN | 46834651 | |
| | 1,4 i 16V | | 01.2004 | 02.2008 | 83.7201-9173.3 | 330868 | FLEXIBLE FREIN | 46834651 | |
| | 1,9 JTD | | 01.2004 | 02.2008 | 83.7201-9173.3 | 330868 | FLEXIBLE FREIN | 46834651 | |
| MULTIPLA (98-) | 1,6 i 16V | | 02.1999 | | 24.5112-0437.3 | 330886 | FLEXIBLE FREIN | 46556045 , 51700558 | |
| | 1,9 JTD | | 02.1999 | | 24.5112-0437.3 | 330886 | FLEXIBLE FREIN | 46556045 , 51700558 | |
| PANDA (03-) | 1,1 i | | 09.2003 | | 24.5112-0440.3 | 330887 | FLEXIBLE FREIN | 51718921 | |
| | 1,2 bivalent CNG | | 01.2007 | | 24.5112-0440.3 | 330887 | FLEXIBLE FREIN | 51718921 | |
| | 1,2 i | | 09.2003 | | 24.5112-0440.3 | 330887 | FLEXIBLE FREIN | 51718921 | |
| | 1,3 JTD | | 06.2006 | | 24.5112-0440.3 | 330887 | FLEXIBLE FREIN | 51718921 | |
| | | | 09.2003 | | 24.5112-0440.3 | 330887 | FLEXIBLE FREIN | 51718921 | |
| | 1,4 i 16V | | 11.2006 | | 24.5112-0440.3 | 330887 | FLEXIBLE FREIN | 51718921 | |



| | | | | | | | | |
|--|--|--|--|--|-------------|----------------------------------|--|--------------------------------|
| | | | | | description | Références OE par référence ATE. | | Références remplacées / divers |
|--|--|--|--|--|-------------|----------------------------------|--|--------------------------------|

FORD

| | | | | | | | | | |
|---------------------|------------|--|---------|---------|----------------|--------|--------------------|--|--|
| C-MAX (07-) | 1,6 i 16V | | 03.2007 | | 24.3727-0659.2 | 580659 | CABLE FREIN A MAIN | 1323904 , 1319486 , 1355127 , 1416442 , 1490515 | |
| | 1,6 TDCi | | 03.2007 | | 24.3727-0659.2 | 580659 | CABLE FREIN A MAIN | 1323904 , 1319486 , 1355127 , 1416442 , 1490515 | |
| | 1,8 i 16V | | 03.2007 | | 24.3727-0659.2 | 580659 | CABLE FREIN A MAIN | 1323904 , 1319486 , 1355127 , 1416442 , 1490515 | |
| | 2,0 i 16V | | 03.2007 | | 24.3727-0659.2 | 580659 | CABLE FREIN A MAIN | 1323904 , 1319486 , 1355127 , 1416442 , 1490515 | |
| | 2,0 TDCi | | 02.2008 | | 24.3727-0659.2 | 580659 | CABLE FREIN A MAIN | 1323904 , 1319486 , 1355127 , 1416442 , 1490515 | |
| | | | 03.2007 | | 24.3727-0659.2 | 580659 | CABLE FREIN A MAIN | 1323904 , 1319486 , 1355127 , 1416442 , 1490515 | |
| FOCUS C-MAX (03-07) | 1,6 i 16V | | 08.2003 | 03.2007 | 24.3727-0659.2 | 580659 | CABLE FREIN A MAIN | 1323904 , 1319486 , 1355127 , 1416442 , 1490515 | |
| | 1,6 TDCi | | 01.2005 | 03.2007 | 24.3727-0659.2 | 580659 | CABLE FREIN A MAIN | 1323904 , 1319486 , 1355127 , 1416442 , 1490515 | |
| | | | 08.2003 | 03.2007 | 24.3727-0659.2 | 580659 | CABLE FREIN A MAIN | 1323904 , 1319486 , 1355127 , 1416442 , 1490515 | |
| | 1,6 Ti VCT | | 08.2004 | 03.2007 | 24.3727-0659.2 | 580659 | CABLE FREIN A MAIN | 1323904 , 1319486 , 1355127 , 1416442 , 1490515 | |
| | 1,8 i 16V | | 08.2003 | 03.2007 | 24.3727-0659.2 | 580659 | CABLE FREIN A MAIN | 1323904 , 1319486 , 1355127 , 1416442 , 1490515 | |
| | | | 04.2004 | 03.2007 | 24.3727-0659.2 | 580659 | CABLE FREIN A MAIN | 1323904 , 1319486 , 1355127 , 1416442 , 1490515 | |
| | 1,8 TDCi | | 01.2005 | 03.2007 | 24.3727-0659.2 | 580659 | CABLE FREIN A MAIN | 1323904 , 1319486 , 1355127 , 1416442 , 1490515 | |







| | | | | | | | | |
|--|--|--|--|--|-------------|----------------------------------|--|--------------------------------|
| | | | | | description | Références OE par référence ATE. | | Références remplacées / divers |
|--|--|--|--|--|-------------|----------------------------------|--|--------------------------------|

FORD

| | | | | | | | | | |
|---------------------|------------|--|---------|---------|----------------|--------|--------------------|---|--|
| FOCUS C-MAX (03-07) | 2,0 i 16V | | 04.2004 | 03.2007 | 24.3727-0659.2 | 580659 | CABLE FREIN A MAIN | 1323904 , 1319486 , 1355127 , 1416442 , 1490515 | |
| | 2,0 TDCi | | 08.2003 | 03.2007 | 24.3727-0659.2 | 580659 | CABLE FREIN A MAIN | 1323904 , 1319486 , 1355127 , 1416442 , 1490515 | |
| FOCUS II (05-) | 1,4 i 16V | | 10.2004 | | 24.3727-0659.2 | 580659 | CABLE FREIN A MAIN | 1323904 , 1319486 , 1355127 , 1416442 , 1490515 | |
| | 1,6 i 16V | | 10.2004 | | 24.3727-0659.2 | 580659 | CABLE FREIN A MAIN | 1323904 , 1319486 , 1355127 , 1416442 , 1490515 | |
| | 1,6 TDCi | | 01.2005 | | 24.3727-0659.2 | 580659 | CABLE FREIN A MAIN | 1323904 , 1319486 , 1355127 , 1416442 , 1490515 | |
| | | | 10.2004 | | 24.3727-0659.2 | 580659 | CABLE FREIN A MAIN | 1323904 , 1319486 , 1355127 , 1416442 , 1490515 | |
| | 1,6 Ti VCT | | 10.2004 | | 24.3727-0659.2 | 580659 | CABLE FREIN A MAIN | 1323904 , 1319486 , 1355127 , 1416442 , 1490515 | |
| | 1,8 i 16V | | 01.2006 | | 24.3727-0659.2 | 580659 | CABLE FREIN A MAIN | 1323904 , 1319486 , 1355127 , 1416442 , 1490515 | |
| | 1,8 TDCi | | 01.2005 | | 24.3727-0659.2 | 580659 | CABLE FREIN A MAIN | 1323904 , 1319486 , 1355127 , 1416442 , 1490515 | |
| | 2,0 i 16V | | 10.2004 | | 24.3727-0659.2 | 580659 | CABLE FREIN A MAIN | 1323904 , 1319486 , 1355127 , 1416442 , 1490515 | |
| | 2,0 TDCi | | 10.2004 | | 24.3727-0659.2 | 580659 | CABLE FREIN A MAIN | 1323904 , 1319486 , 1355127 , 1416442 , 1490515 | |
| | 2,5 ST | | 10.2005 | | 24.3727-0659.2 | 580659 | CABLE FREIN A MAIN | 1323904 , 1319486 , 1355127 , 1416442 , 1490515 | |



| | | | | | | |
|---|---|--|---|--------------------|---|---|
|  |  |  |  | <p>description</p> | <p>Références OE par référence ATE.</p> |  <p>Références remplacées / divers</p> |
|---|---|--|---|--------------------|---|---|

HONDA

| Modèle | Moteur | Année | Année | ATE Ref. | ATE Ref. | Description | Références OE | Notes |
|----------------|----------------|---------|---------|----------------|----------|---------------------|---------------|-----------|
| CR-V III (07-) | 2,0 VTEC | 01.2007 | | 13.0460-5753.2 | 605753 | PLAQUETTES DE FREIN | 45022-SWW-G01 | cf. Photo |
| | | 01.2007 | | 13.0460-5754.2 | 605754 | PLAQUETTES DE FREIN | 43022-SWW-G01 | cf. Photo |
| | 2,2 CTDi | 01.2007 | | 13.0460-5754.2 | 605754 | PLAQUETTES DE FREIN | 43022-SWW-G01 | cf. Photo |
| | | 01.2007 | | 13.0460-5753.2 | 605753 | PLAQUETTES DE FREIN | 45022-SWW-G01 | cf. Photo |
| S2000 (99-04) | 2,0 VTEC (AP1) | 06.1999 | 09.2004 | 24.0112-0707.1 | 412707 | DISQUE DE FREIN | 42510-S2A-000 | |

Nouvelles références disponibles - par applications

09/2008



| | | | | | | | | |
|--|--|--|--|--|-------------|----------------------------------|--|--------------------------------|
| | | | | | description | Références OE par référence ATE. | | Références remplacées / divers |
|--|--|--|--|--|-------------|----------------------------------|--|--------------------------------|

HYUNDAI

| SANTA FE (01-06) | 2,0 CRDi | ArD | 11.2003 | 02.2006 | 24.3727-3108.2 | 583108 | CABLE FREIN A MAIN | 59913-26150 | |
|------------------|---------------|-----|---------|---------|----------------|--------|--------------------|-------------|--|
| | | ArD | 08.2001 | 07.2003 | 24.3727-3108.2 | 583108 | CABLE FREIN A MAIN | 59913-26150 | |
| | | ArG | 08.2001 | 07.2003 | 24.3727-3109.2 | 583109 | CABLE FREIN A MAIN | 59912-26150 | |
| | | ArG | 11.2003 | 02.2006 | 24.3727-3109.2 | 583109 | CABLE FREIN A MAIN | 59912-26150 | |
| | | ArG | 08.2003 | 02.2006 | 24.3727-3109.2 | 583109 | CABLE FREIN A MAIN | 59912-26150 | |
| | | ArD | 08.2003 | 02.2006 | 24.3727-3108.2 | 583108 | CABLE FREIN A MAIN | 59913-26150 | |
| | 2,0 CRDi 4x4 | ArG | 08.2003 | 02.2006 | 24.3727-3109.2 | 583109 | CABLE FREIN A MAIN | 59912-26150 | |
| | | ArG | 11.2003 | 02.2006 | 24.3727-3109.2 | 583109 | CABLE FREIN A MAIN | 59912-26150 | |
| | | ArG | 04.2001 | 07.2003 | 24.3727-3109.2 | 583109 | CABLE FREIN A MAIN | 59912-26150 | |
| | | ArD | 04.2001 | 07.2003 | 24.3727-3108.2 | 583108 | CABLE FREIN A MAIN | 59913-26150 | |
| | | ArD | 11.2003 | 02.2006 | 24.3727-3108.2 | 583108 | CABLE FREIN A MAIN | 59913-26150 | |
| | | ArD | 08.2003 | 02.2006 | 24.3727-3108.2 | 583108 | CABLE FREIN A MAIN | 59913-26150 | |
| | 2,0 i 16V | ArG | 02.2001 | 02.2006 | 24.3727-3109.2 | 583109 | CABLE FREIN A MAIN | 59912-26150 | |
| | | ArD | 02.2001 | 02.2006 | 24.3727-3108.2 | 583108 | CABLE FREIN A MAIN | 59913-26150 | |
| | 2,4 i 16V | ArD | 02.2001 | 02.2006 | 24.3727-3108.2 | 583108 | CABLE FREIN A MAIN | 59913-26150 | |
| | | ArG | 02.2001 | 02.2006 | 24.3727-3109.2 | 583109 | CABLE FREIN A MAIN | 59912-26150 | |
| | 2,4 i 16V 4x4 | ArG | 02.2001 | 02.2006 | 24.3727-3109.2 | 583109 | CABLE FREIN A MAIN | 59912-26150 | |
| | | ArD | 02.2001 | 02.2006 | 24.3727-3108.2 | 583108 | CABLE FREIN A MAIN | 59913-26150 | |
| | 2,7 i V6 4x4 | ArG | 02.2001 | 02.2006 | 24.3727-3109.2 | 583109 | CABLE FREIN A MAIN | 59912-26150 | |



| | | | | | | |
|--|----------|--|--|-------------|----------------------------------|--|
| | i | | | description | Références OE par référence ATE. | i Références remplacées / divers |
|--|----------|--|--|-------------|----------------------------------|--|

HYUNDAI

| | | | | | | | | | |
|------------------|--------------|-----|---------|---------|----------------|--------|--------------------|-------------|--|
| SANTA FE (01-06) | 2,7 i V6 4x4 | ArD | 02.2001 | 02.2006 | 24.3727-3108.2 | 583108 | CABLE FREIN A MAIN | 59913-26150 | |
|------------------|--------------|-----|---------|---------|----------------|--------|--------------------|-------------|--|







INFINITI

| | | | | | | | | | |
|-----------------------|------------|--|---------|--|----------------|--------|-----------------|-------------|--|
| FX35/FX45 (S50) (06-) | 3,5 V6 4WD | | 07.2006 | | 24.0116-0122.1 | 416122 | DISQUE DE FREIN | 43206-CA000 | |
| | 4,5 V8 4WD | | 07.2006 | | 24.0116-0122.1 | 416122 | DISQUE DE FREIN | 43206-CA000 | |

Nouvelles références disponibles - par applications

09/2008



| | | | | | | | | |
|---|---|---|---|---|-------------|----------------------------------|---|--------------------------------|
|  |  |  |  |  | description | Références OE par référence ATE. |  | Références remplacées / divers |
|---|---|---|---|---|-------------|----------------------------------|---|--------------------------------|

JEEP

| | | | | | | | | | |
|--|-------------|--|---------|---------|----------------|--------|-----------------|------------------------|--|
| CHEROKEE (KJ) (01-) | 2,4 | | 09.2001 | | 24.0128-0708.1 | 428708 | DISQUE DE FREIN | 5212 8247AA | |
| | 2,5 CRD | | 09.2001 | | 24.0128-0708.1 | 428708 | DISQUE DE FREIN | 5212 8247AA | |
| | 2,8 CRD | | 11.2002 | | 24.0128-0708.1 | 428708 | DISQUE DE FREIN | 5212 8247AA | |
| | 3,7 V6 | | 09.2001 | | 24.0128-0708.1 | 428708 | DISQUE DE FREIN | 5212 8247AA | |
| CHEROKEE(XJ)/WAGON.(XJ)/COMANCHE(MJ) (87-) | 2,1 TD 4x4 | | 01.1990 | 12.1990 | 24.0124-0702.1 | 424702 | DISQUE DE FREIN | 5015 965AA , 5200 5000 | |
| | 2,5 i 4x4 | | 01.1990 | 12.1990 | 24.0124-0702.1 | 424702 | DISQUE DE FREIN | 5015 965AA , 5200 5000 | |
| | 2,5 TD 4x4 | | 01.1990 | 12.1990 | 24.0124-0702.1 | 424702 | DISQUE DE FREIN | 5015 965AA , 5200 5000 | |
| | 4,0 i 4x4 | | 01.1990 | 12.1990 | 24.0124-0702.1 | 424702 | DISQUE DE FREIN | 5015 965AA , 5200 5000 | |
| WRANGLER I (YJ) (87-96) | 2,5 | | 01.1990 | 12.1993 | 24.0124-0702.1 | 424702 | DISQUE DE FREIN | 5015 965AA , 5200 5000 | |
| | 4 | | 01.1990 | 12.1993 | 24.0124-0702.1 | 424702 | DISQUE DE FREIN | 5015 965AA , 5200 5000 | |
| WRANGLER II (TJ) (96-) | 2,4 | | 11.2002 | | 24.0124-0702.1 | 424702 | DISQUE DE FREIN | 5015 965AA , 5200 5000 | |
| | 2,5 | | 08.1996 | | 24.0124-0702.1 | 424702 | DISQUE DE FREIN | 5015 965AA , 5200 5000 | |
| | 4 | | 06.1998 | | 24.0124-0702.1 | 424702 | DISQUE DE FREIN | 5015 965AA , 5200 5000 | |
| | | | 08.1996 | | 24.0124-0702.1 | 424702 | DISQUE DE FREIN | 5015 965AA , 5200 5000 | |
| | 4,0 Rubicon | | 08.2003 | | 24.0124-0702.1 | 424702 | DISQUE DE FREIN | 5015 965AA , 5200 5000 | |



| | | | | | | | | |
|--|--|--|--|--|-------------|----------------------------------|--|--------------------------------|
| | | | | | description | Références OE par référence ATE. | | Références remplacées / divers |
|--|--|--|--|--|-------------|----------------------------------|--|--------------------------------|

KIA

| | | | | | | | | | |
|---------------|-----------|-----|---------|---------|----------------|--------|--------------------|---------------|--|
| RIO I (00-05) | 1,3 i | ArD | 08.2000 | 02.2005 | 24.3727-3201.2 | 583201 | CABLE FREIN A MAIN | OK30A-44-410H | |
| | | ArG | 08.2000 | 02.2005 | 24.3727-3200.2 | 583200 | CABLE FREIN A MAIN | OK30A-44-420H | |
| | 1,5 i 16V | ArG | 09.2002 | 02.2005 | 24.3727-3200.2 | 583200 | CABLE FREIN A MAIN | OK30A-44-420H | |
| | | ArG | 08.2000 | 02.2005 | 24.3727-3200.2 | 583200 | CABLE FREIN A MAIN | OK30A-44-420H | |
| | | ArD | 08.2000 | 02.2005 | 24.3727-3201.2 | 583201 | CABLE FREIN A MAIN | OK30A-44-410H | |
| | | ArD | 09.2002 | 02.2005 | 24.3727-3201.2 | 583201 | CABLE FREIN A MAIN | OK30A-44-410H | |
| SORENTO (02-) | 2,4 i 16V | | 08.2002 | 11.2006 | 24.0120-0202.1 | 420202 | DISQUE DE FREIN | 58411-3E300 | |
| | 2,5 CRDi | | 08.2002 | 11.2006 | 24.0120-0202.1 | 420202 | DISQUE DE FREIN | 58411-3E300 | |
| | 3,5 i V6 | | 08.2002 | | 24.0120-0202.1 | 420202 | DISQUE DE FREIN | 58411-3E300 | |

Nouvelles références disponibles - par applications

09/2008



| | | | | | | | | |
|--|--|--|--|--|-------------|----------------------------------|--|--------------------------------|
| | | | | | description | Références OE par référence ATE. | | Références remplacées / divers |
|--|--|--|--|--|-------------|----------------------------------|--|--------------------------------|







LANCIA

| | | | | | | | | | |
|---------------|-----------|--|---------|--|----------------|--------|----------------|----------|--|
| MUSA (04-) | 1,3 JTD | | 10.2004 | | 83.7201-9173.3 | 330868 | FLEXIBLE FREIN | 46834651 | |
| | | | 09.2006 | | 83.7201-9173.3 | 330868 | FLEXIBLE FREIN | 46834651 | |
| | 1,4 i | | 07.2005 | | 83.7201-9173.3 | 330868 | FLEXIBLE FREIN | 46834651 | |
| | 1,4 i 16V | | 10.2004 | | 83.7201-9173.3 | 330868 | FLEXIBLE FREIN | 46834651 | |
| | 1,6 JTD | | 06.2008 | | 83.7201-9173.3 | 330868 | FLEXIBLE FREIN | 46834651 | |
| | 1,9 JTD | | 10.2004 | | 83.7201-9173.3 | 330868 | FLEXIBLE FREIN | 46834651 | |
| YPSILON (03-) | 1,2 i | | 06.2003 | | 03.0520-7019.3 | 697019 | ATE TOPKIT | | |
| | 1,2 i 16V | | 06.2003 | | 03.0520-9320.3 | 699320 | ATE TOPKIT | | |
| | 1,3 JTD | | 06.2003 | | 03.0520-9320.3 | 699320 | ATE TOPKIT | | |
| | | | 10.2006 | | 03.0520-9320.3 | 699320 | ATE TOPKIT | | |
| | 1,4 i | | 02.2006 | | 03.0520-7019.3 | 697019 | ATE TOPKIT | | |
| | 1,4 i 16V | | 06.2003 | | 03.0520-9320.3 | 699320 | ATE TOPKIT | | |

LAND ROVER

| | | | | | | | | | |
|-------------------------|-------------------|--|---------|--|----------------|--------|-----------------|-----------------------------------|--|
| DISCOVERY III (04-) | 4,4 | | 10.2004 | | 24.0120-0201.1 | 420201 | DISQUE DE FREIN | SDB000644 , SDB000645 , SDB000646 | |
| RANGE ROVER SPORT (05-) | 3,6 TD V8 | | 04.2006 | | 24.0120-0201.1 | 420201 | DISQUE DE FREIN | SDB000644 , SDB000645 , SDB000646 | |
| | 4,2 V8 Kompressor | | 02.2005 | | 24.0120-0201.1 | 420201 | DISQUE DE FREIN | SDB000644 , SDB000645 , SDB000646 | |
| | 4,4 V8 | | 02.2005 | | 24.0120-0201.1 | 420201 | DISQUE DE FREIN | SDB000644 , SDB000645 , SDB000646 | |



| | | | | | | |
|---|---|---|---|-------------|--|---|
|  |  |   |  | description | Références OE par référence ATE. |  Références remplacées / divers |
|---|---|---|---|-------------|--|---|

MAZDA

| | | | | | | | | | |
|---------------|-----------|-----|---------|--|----------------|--------|--------------------|--|--|
| 5 (05-) | 1,8 i 16V | ArD | 03.2005 | | 24.3727-1820.2 | 581820 | CABLE FREIN A MAIN | C236-44-410C , C236-44-410D , C236-44-410E | |
| | 2,0 CITD | ArD | 03.2005 | | 24.3727-1820.2 | 581820 | CABLE FREIN A MAIN | C236-44-410C , C236-44-410D , C236-44-410E | |
| | | ArD | 06.2005 | | 24.3727-1820.2 | 581820 | CABLE FREIN A MAIN | C236-44-410C , C236-44-410D , C236-44-410E | |
| | 2,0 i 16V | ArD | 03.2005 | | 24.3727-1820.2 | 581820 | CABLE FREIN A MAIN | C236-44-410C , C236-44-410D , C236-44-410E | |
| PREMACY (05-) | 1,8 i 16V | ArD | 03.2005 | | 24.3727-1820.2 | 581820 | CABLE FREIN A MAIN | C236-44-410C , C236-44-410D , C236-44-410E | |
| | 2,0 CITD | ArD | 06.2005 | | 24.3727-1820.2 | 581820 | CABLE FREIN A MAIN | C236-44-410C , C236-44-410D , C236-44-410E | |
| | | ArD | 03.2005 | | 24.3727-1820.2 | 581820 | CABLE FREIN A MAIN | C236-44-410C , C236-44-410D , C236-44-410E | |
| | 2,0 i 16V | ArD | 03.2005 | | 24.3727-1820.2 | 581820 | CABLE FREIN A MAIN | C236-44-410C , C236-44-410D , C236-44-410E | |

Nouvelles références disponibles - par applications

09/2008



| | | | | | | | | |
|--|--|--|--|--|-------------|----------------------------------|--|--------------------------------|
| | | | | | description | Références OE par référence ATE. | | Références remplacées / divers |
|--|--|--|--|--|-------------|----------------------------------|--|--------------------------------|

MERCEDES BENZ

| | | | | | | | | | |
|------------------------|-------------|-----|---------|--|----------------|--------|--------------------|---------------|--|
| Classe A (W169) (04-) | A 150 | ArD | 08.2004 | | 24.3727-0451.2 | 580451 | CABLE FREIN A MAIN | 169 420 12 85 | |
| | | ArG | 08.2004 | | 24.3727-0452.2 | 580452 | CABLE FREIN A MAIN | 169 420 11 85 | |
| | A 160 CDI | ArG | 08.2004 | | 24.3727-0452.2 | 580452 | CABLE FREIN A MAIN | 169 420 11 85 | |
| | | ArD | 08.2004 | | 24.3727-0451.2 | 580451 | CABLE FREIN A MAIN | 169 420 12 85 | |
| | A 170 | ArD | 08.2004 | | 24.3727-0451.2 | 580451 | CABLE FREIN A MAIN | 169 420 12 85 | |
| | | ArG | 08.2004 | | 24.3727-0452.2 | 580452 | CABLE FREIN A MAIN | 169 420 11 85 | |
| | A 180 CDI | ArD | 08.2004 | | 24.3727-0451.2 | 580451 | CABLE FREIN A MAIN | 169 420 12 85 | |
| | | ArG | 08.2004 | | 24.3727-0452.2 | 580452 | CABLE FREIN A MAIN | 169 420 11 85 | |
| | A 200 | ArD | 08.2004 | | 24.3727-0451.2 | 580451 | CABLE FREIN A MAIN | 169 420 12 85 | |
| | | ArG | 08.2004 | | 24.3727-0452.2 | 580452 | CABLE FREIN A MAIN | 169 420 11 85 | |
| | A 200 CDI | ArD | 08.2004 | | 24.3727-0451.2 | 580451 | CABLE FREIN A MAIN | 169 420 12 85 | |
| | | ArG | 08.2004 | | 24.3727-0452.2 | 580452 | CABLE FREIN A MAIN | 169 420 11 85 | |
| | A 200 Turbo | ArG | 03.2005 | | 24.3727-0452.2 | 580452 | CABLE FREIN A MAIN | 169 420 11 85 | |
| | | ArD | 03.2005 | | 24.3727-0451.2 | 580451 | CABLE FREIN A MAIN | 169 420 12 85 | |
| Classe B (W245) (05-) | B 150 | ArD | 04.2005 | | 24.3727-0451.2 | 580451 | CABLE FREIN A MAIN | 169 420 12 85 | |
| | | ArG | 04.2005 | | 24.3727-0452.2 | 580452 | CABLE FREIN A MAIN | 169 420 11 85 | |
| | B 170 | ArD | 04.2005 | | 24.3727-0451.2 | 580451 | CABLE FREIN A MAIN | 169 420 12 85 | |
| | | ArG | 04.2005 | | 24.3727-0452.2 | 580452 | CABLE FREIN A MAIN | 169 420 11 85 | |
| | B 180 CDI | ArG | 04.2005 | | 24.3727-0452.2 | 580452 | CABLE FREIN A MAIN | 169 420 11 85 | |

Nouvelles références disponibles - par applications

09/2008



| | | | | | | | | |
|--|--|--|--|--|-------------|----------------------------------|--|--------------------------------|
| | | | | | description | Références OE par référence ATE. | | Références remplacées / divers |
|--|--|--|--|--|-------------|----------------------------------|--|--------------------------------|

MERCEDES BENZ

| | | | | | | | | | |
|-------------------------------------|------------------|-----|---------|---------|----------------|--------|--------------------|-------------------------------|--|
| Classe B (W245) (05-) | B 180 CDI | ArD | 04.2005 | | 24.3727-0451.2 | 580451 | CABLE FREIN A MAIN | 169 420 12 85 | |
| | B 200 | ArG | 04.2005 | | 24.3727-0452.2 | 580452 | CABLE FREIN A MAIN | 169 420 11 85 | |
| | | ArD | 04.2005 | | 24.3727-0451.2 | 580451 | CABLE FREIN A MAIN | 169 420 12 85 | |
| | B 200 CDI | ArG | 04.2005 | | 24.3727-0452.2 | 580452 | CABLE FREIN A MAIN | 169 420 11 85 | |
| | | ArD | 04.2005 | | 24.3727-0451.2 | 580451 | CABLE FREIN A MAIN | 169 420 12 85 | |
| | B 200 Turbo | ArD | 04.2005 | | 24.3727-0451.2 | 580451 | CABLE FREIN A MAIN | 169 420 12 85 | |
| | | ArG | 04.2005 | | 24.3727-0452.2 | 580452 | CABLE FREIN A MAIN | 169 420 11 85 | |
| Classe C (CL203) Sportcoupé (01-08) | C 160 Kompressor | AvD | 04.2005 | 05.2008 | 24.3571-1740.7 | 220668 | ETRIER A GRIFFE | 001 420 95 83 , 003 420 22 83 | |
| | | AvG | 04.2005 | 05.2008 | 24.3571-1739.7 | 220667 | ETRIER A GRIFFE | 001 420 94 83 , 003 420 21 83 | |
| | C 180 | AvD | 03.2001 | 05.2008 | 24.3571-1740.7 | 220668 | ETRIER A GRIFFE | 001 420 95 83 , 003 420 22 83 | |
| | | AvG | 03.2001 | 05.2008 | 24.3571-1739.7 | 220667 | ETRIER A GRIFFE | 001 420 94 83 , 003 420 21 83 | |
| | C 180 Kompressor | AvG | 05.2002 | 05.2008 | 24.3571-1739.7 | 220667 | ETRIER A GRIFFE | 001 420 94 83 , 003 420 21 83 | |
| | | AvD | 05.2002 | 05.2008 | 24.3571-1740.7 | 220668 | ETRIER A GRIFFE | 001 420 95 83 , 003 420 22 83 | |
| | C 200 CDI | AvG | 07.2003 | 05.2008 | 24.3571-1739.7 | 220667 | ETRIER A GRIFFE | 001 420 94 83 , 003 420 21 83 | |
| | | AvD | 07.2003 | 05.2008 | 24.3571-1740.7 | 220668 | ETRIER A GRIFFE | 001 420 95 83 , 003 420 22 83 | |

Nouvelles références disponibles - par applications

09/2008



| | | | | | | | | |
|--|--|--|--|--|-------------|----------------------------------|--|--------------------------------|
| | | | | | description | Références OE par référence ATE. | | Références remplacées / divers |
|--|--|--|--|--|-------------|----------------------------------|--|--------------------------------|







MERCEDES BENZ

| | | | | | | | | | |
|-------------------------------------|----------------------|-----|---------|---------|----------------|--------|-----------------|-------------------------------|--|
| Classe C (CL203) Sportcoupé (01-08) | C 200 CGI Kompressor | AvG | 07.2003 | 05.2008 | 24.3571-1739.7 | 220667 | ETRIER A GRIFFE | 001 420 94 83 , 003 420 21 83 | |
| | | AvD | 07.2003 | 05.2008 | 24.3571-1740.7 | 220668 | ETRIER A GRIFFE | 001 420 95 83 , 003 420 22 83 | |
| | C 200 Kompressor | AvG | 03.2001 | 05.2008 | 24.3571-1739.7 | 220667 | ETRIER A GRIFFE | 001 420 94 83 , 003 420 21 83 | |
| | | AvD | 03.2001 | 05.2008 | 24.3571-1740.7 | 220668 | ETRIER A GRIFFE | 001 420 95 83 , 003 420 22 83 | |
| | C 220 CDI | AvD | 03.2001 | 05.2008 | 24.3571-1740.7 | 220668 | ETRIER A GRIFFE | 001 420 95 83 , 003 420 22 83 | |
| | | AvG | 03.2001 | 05.2008 | 24.3571-1739.7 | 220667 | ETRIER A GRIFFE | 001 420 94 83 , 003 420 21 83 | |
| | C 230 Kompressor | AvG | 03.2001 | 05.2008 | 24.3571-1739.7 | 220667 | ETRIER A GRIFFE | 001 420 94 83 , 003 420 21 83 | |
| | | AvD | 03.2001 | 05.2008 | 24.3571-1740.7 | 220668 | ETRIER A GRIFFE | 001 420 95 83 , 003 420 22 83 | |
| Classe C (CLC204) Coupé (08-) | CLC 180 Kompressor | AvD | 05.2008 | | 24.3571-1740.7 | 220668 | ETRIER A GRIFFE | 001 420 95 83 , 003 420 22 83 | |
| | | AvG | 05.2008 | | 24.3571-1739.7 | 220667 | ETRIER A GRIFFE | 001 420 94 83 , 003 420 21 83 | |
| | CLC 200 CDI | AvG | 05.2008 | | 24.3571-1739.7 | 220667 | ETRIER A GRIFFE | 001 420 94 83 , 003 420 21 83 | |
| | | AvD | 05.2008 | | 24.3571-1740.7 | 220668 | ETRIER A GRIFFE | 001 420 95 83 , 003 420 22 83 | |
| | CLC 200 Kompressor | AvG | 05.2008 | | 24.3571-1739.7 | 220667 | ETRIER A GRIFFE | 001 420 94 83 , 003 420 21 83 | |

Nouvelles références disponibles - par applications

09/2008









| | | | | | | | | |
|---|---|---|---|---|-------------|----------------------------------|---|--------------------------------|
|  |  |  |  |  | description | Références OE par référence ATE. |  | Références remplacées / divers |
|---|---|---|---|---|-------------|----------------------------------|---|--------------------------------|

MERCEDES BENZ

| | | | | | | | | | |
|-------------------------------|----------------------|-----|---------|---------|----------------|--------|-----------------|-------------------------------|--|
| Classe C (CLC204) Coupé (08-) | CLC 200 Kompressor | AvD | 05.2008 | | 24.3571-1740.7 | 220668 | ETRIER A GRIFFE | 001 420 95 83 , 003 420 22 83 | |
| | CLC 220 CDI | AvD | 05.2008 | | 24.3571-1740.7 | 220668 | ETRIER A GRIFFE | 001 420 95 83 , 003 420 22 83 | |
| | | AvG | 05.2008 | | 24.3571-1739.7 | 220667 | ETRIER A GRIFFE | 001 420 94 83 , 003 420 21 83 | |
| Classe C (S203) Break (01-07) | C 180 | AvD | 03.2001 | 09.2007 | 24.3571-1740.7 | 220668 | ETRIER A GRIFFE | 001 420 95 83 , 003 420 22 83 | |
| | | AvG | 03.2001 | 09.2007 | 24.3571-1739.7 | 220667 | ETRIER A GRIFFE | 001 420 94 83 , 003 420 21 83 | |
| | C 180 Kompressor | AvD | 05.2002 | 09.2007 | 24.3571-1740.7 | 220668 | ETRIER A GRIFFE | 001 420 95 83 , 003 420 22 83 | |
| | | AvG | 05.2002 | 09.2007 | 24.3571-1739.7 | 220667 | ETRIER A GRIFFE | 001 420 94 83 , 003 420 21 83 | |
| | C 200 CDI | AvD | 03.2001 | 09.2007 | 24.3571-1740.7 | 220668 | ETRIER A GRIFFE | 001 420 95 83 , 003 420 22 83 | |
| | | AvG | 03.2001 | 09.2007 | 24.3571-1739.7 | 220667 | ETRIER A GRIFFE | 001 420 94 83 , 003 420 21 83 | |
| | C 200 CGI Kompressor | AvD | 07.2003 | 09.2007 | 24.3571-1740.7 | 220668 | ETRIER A GRIFFE | 001 420 95 83 , 003 420 22 83 | |
| | | AvG | 07.2003 | 09.2007 | 24.3571-1739.7 | 220667 | ETRIER A GRIFFE | 001 420 94 83 , 003 420 21 83 | |
| | C 200 Kompressor | AvG | 03.2001 | 09.2007 | 24.3571-1739.7 | 220667 | ETRIER A GRIFFE | 001 420 94 83 , 003 420 21 83 | |
| | | AvD | 03.2001 | 09.2007 | 24.3571-1740.7 | 220668 | ETRIER A GRIFFE | 001 420 95 83 , 003 420 22 83 | |



| | | | | | | | | |
|---|---|---|---|---|-------------|----------------------------------|---|--------------------------------|
|  |  |  |  |  | description | Références OE par référence ATE. |  | Références remplacées / divers |
|---|---|---|---|---|-------------|----------------------------------|---|--------------------------------|

MERCEDES BENZ

| Classe C (S203) Break (01-07) | C 220 CDI | AvD | 03.2001 | 09.2007 | 24.3571-1740.7 | 220668 | ETRIER A GRIFFE | 001 420 95 83 , 003 420 22 83 | |
|---------------------------------|----------------------|-----|---------|---------|----------------|--------|-----------------|-------------------------------|--|
| | | AvG | 03.2001 | 09.2007 | 24.3571-1739.7 | 220667 | ETRIER A GRIFFE | 001 420 94 83 , 003 420 21 83 | |
| | C 320 CDI | AvG | 02.2005 | 09.2007 | 24.3571-1739.7 | 220667 | ETRIER A GRIFFE | 001 420 94 83 , 003 420 21 83 | |
| | | AvD | 02.2005 | 09.2007 | 24.3571-1740.7 | 220668 | ETRIER A GRIFFE | 001 420 95 83 , 003 420 22 83 | |
| Classe C (W203) Berline (00-07) | C 180 | AvG | 04.2000 | 04.2007 | 24.3571-1739.7 | 220667 | ETRIER A GRIFFE | 001 420 94 83 , 003 420 21 83 | |
| | | AvD | 04.2000 | 04.2007 | 24.3571-1740.7 | 220668 | ETRIER A GRIFFE | 001 420 95 83 , 003 420 22 83 | |
| | C 180 Kompressor | AvG | 05.2002 | 04.2007 | 24.3571-1739.7 | 220667 | ETRIER A GRIFFE | 001 420 94 83 , 003 420 21 83 | |
| | | AvD | 05.2002 | 04.2007 | 24.3571-1740.7 | 220668 | ETRIER A GRIFFE | 001 420 95 83 , 003 420 22 83 | |
| | C 200 CDI | AvG | 04.2000 | 04.2007 | 24.3571-1739.7 | 220667 | ETRIER A GRIFFE | 001 420 94 83 , 003 420 21 83 | |
| | | AvD | 04.2000 | 04.2007 | 24.3571-1740.7 | 220668 | ETRIER A GRIFFE | 001 420 95 83 , 003 420 22 83 | |
| | C 200 CGI Kompressor | AvG | 07.2003 | 04.2007 | 24.3571-1739.7 | 220667 | ETRIER A GRIFFE | 001 420 94 83 , 003 420 21 83 | |
| | | AvD | 07.2003 | 04.2007 | 24.3571-1740.7 | 220668 | ETRIER A GRIFFE | 001 420 95 83 , 003 420 22 83 | |
| | C 200 Kompressor | AvD | 04.2000 | 04.2007 | 24.3571-1740.7 | 220668 | ETRIER A GRIFFE | 001 420 95 83 , 003 420 22 83 | |

Nouvelles références disponibles - par applications

09/2008



| | | | | | | | | |
|--|--|--|--|--|-------------|----------------------------------|--|--------------------------------|
| | | | | | description | Références OE par référence ATE. | | Références remplacées / divers |
|--|--|--|--|--|-------------|----------------------------------|--|--------------------------------|

MERCEDES BENZ

| | | | | | | | | | |
|-------------------------------------|--------------------|-----|---------|---------|----------------|--------|-----------------|-------------------------------|--|
| Classe C (W203) Berline (00-07) | C 200 Kompressor | AvG | 04.2000 | 04.2007 | 24.3571-1739.7 | 220667 | ETRIER A GRIFFE | 001 420 94 83 , 003 420 21 83 | |
| | C 220 CDI | AvD | 04.2000 | 04.2007 | 24.3571-1740.7 | 220668 | ETRIER A GRIFFE | 001 420 95 83 , 003 420 22 83 | |
| | | AvG | 04.2000 | 04.2007 | 24.3571-1739.7 | 220667 | ETRIER A GRIFFE | 001 420 94 83 , 003 420 21 83 | |
| | C 230 Kompressor | AvG | 02.2004 | 04.2007 | 24.3571-1739.7 | 220667 | ETRIER A GRIFFE | 001 420 94 83 , 003 420 21 83 | |
| | | AvD | 02.2004 | 04.2007 | 24.3571-1740.7 | 220668 | ETRIER A GRIFFE | 001 420 95 83 , 003 420 22 83 | |
| | C 320 CDI | AvG | 02.2005 | 04.2007 | 24.3571-1739.7 | 220667 | ETRIER A GRIFFE | 001 420 94 83 , 003 420 21 83 | |
| | | AvD | 02.2005 | 04.2007 | 24.3571-1740.7 | 220668 | ETRIER A GRIFFE | 001 420 95 83 , 003 420 22 83 | |
| Classe CLK (A209) Décapotable (03-) | CLK 200 CGI | AvD | 05.2003 | | 24.3571-1740.7 | 220668 | ETRIER A GRIFFE | 001 420 95 83 , 003 420 22 83 | |
| | | AvG | 05.2003 | | 24.3571-1739.7 | 220667 | ETRIER A GRIFFE | 001 420 94 83 , 003 420 21 83 | |
| | CLK 200 Kompressor | AvD | 05.2003 | | 24.3571-1740.7 | 220668 | ETRIER A GRIFFE | 001 420 95 83 , 003 420 22 83 | |
| | | AvG | 05.2003 | | 24.3571-1739.7 | 220667 | ETRIER A GRIFFE | 001 420 94 83 , 003 420 21 83 | |
| Classe CLK (C209) Coupé (02-) | CLK 200 CGI | AvG | 09.2002 | | 24.3571-1739.7 | 220667 | ETRIER A GRIFFE | 001 420 94 83 , 003 420 21 83 | |
| | | AvD | 09.2002 | | 24.3571-1740.7 | 220668 | ETRIER A GRIFFE | 001 420 95 83 , 003 420 22 83 | |



| | | | | | | | | |
|--|--|--|--|--|-------------|----------------------------------|--|--------------------------------|
| | | | | | description | Références OE par référence ATE. | | Références remplacées / divers |
|--|--|--|--|--|-------------|----------------------------------|--|--------------------------------|

MERCEDES BENZ

| | | | | | | | | | |
|-------------------------------|--------------------|-----|---------|--|----------------|--------|--------------------|-------------------------------|--|
| Classe CLK (C209) Coupé (02-) | CLK 200 Kompressor | AvG | 09.2002 | | 24.3571-1739.7 | 220667 | ETRIER A GRIFFE | 001 420 94 83 , 003 420 21 83 | |
| | | AvD | 09.2002 | | 24.3571-1740.7 | 220668 | ETRIER A GRIFFE | 001 420 95 83 , 003 420 22 83 | |
| | CLK 220 CDI | AvD | 05.2005 | | 24.3571-1740.7 | 220668 | ETRIER A GRIFFE | 001 420 95 83 , 003 420 22 83 | |
| | | AvG | 05.2005 | | 24.3571-1739.7 | 220667 | ETRIER A GRIFFE | 001 420 94 83 , 003 420 21 83 | |
| Classe CLS (C219) Coupé (04-) | CLS 280 | ArG | 10.2007 | | 24.3727-0449.2 | 580449 | CABLE FREIN A MAIN | 211 420 02 85 , 211 420 23 85 | |
| | CLS 320 CDI | ArG | 05.2005 | | 24.3727-0449.2 | 580449 | CABLE FREIN A MAIN | 211 420 02 85 , 211 420 23 85 | |
| | CLS 350 | ArG | 08.2004 | | 24.3727-0449.2 | 580449 | CABLE FREIN A MAIN | 211 420 02 85 , 211 420 23 85 | |
| | CLS 350 CGI | ArG | 04.2006 | | 24.3727-0449.2 | 580449 | CABLE FREIN A MAIN | 211 420 02 85 , 211 420 23 85 | |
| | CLS 500 | ArG | 04.2006 | | 24.3727-0449.2 | 580449 | CABLE FREIN A MAIN | 211 420 02 85 , 211 420 23 85 | |
| | | ArG | 08.2004 | | 24.3727-0449.2 | 580449 | CABLE FREIN A MAIN | 211 420 02 85 , 211 420 23 85 | |
| | CLS 55 AMG | | 01.2005 | | 24.0126-0136.1 | 426136 | DISQUE DE FREIN | 211 423 10 12 | |
| | | ArG | 01.2005 | | 24.3727-0449.2 | 580449 | CABLE FREIN A MAIN | 211 420 02 85 , 211 420 23 85 | |
| | CLS 63 AMG | | 04.2006 | | 24.0126-0136.1 | 426136 | DISQUE DE FREIN | 211 423 10 12 | |
| | | ArG | 04.2006 | | 24.3727-0449.2 | 580449 | CABLE FREIN A MAIN | 211 420 02 85 , 211 420 23 85 | |

Nouvelles références disponibles - par applications

09/2008









| | | | | | | | | |
|--|--|--|--|--|-------------|----------------------------------|--|--------------------------------|
| | | | | | description | Références OE par référence ATE. | | Références remplacées / divers |
|--|--|--|--|--|-------------|----------------------------------|--|--------------------------------|

MERCEDES BENZ

| | | | | | | | | | |
|-----------------------------|-------------------|-----|---------|--|----------------|--------|--------------------|-------------------------------|--|
| Classe E (S211) Break (03-) | E 200 Kompressor | ArG | 03.2003 | | 24.3727-0449.2 | 580449 | CABLE FREIN A MAIN | 211 420 02 85 , 211 420 23 85 | |
| | E 220 CDI | ArG | 03.2003 | | 24.3727-0449.2 | 580449 | CABLE FREIN A MAIN | 211 420 02 85 , 211 420 23 85 | |
| | E 240 | ArG | 03.2003 | | 24.3727-0449.2 | 580449 | CABLE FREIN A MAIN | 211 420 02 85 , 211 420 23 85 | |
| | E 240 4-Matic | ArG | 07.2003 | | 24.3727-0449.2 | 580449 | CABLE FREIN A MAIN | 211 420 02 85 , 211 420 23 85 | |
| | E 270 CDI | ArG | 03.2003 | | 24.3727-0449.2 | 580449 | CABLE FREIN A MAIN | 211 420 02 85 , 211 420 23 85 | |
| | E 280 | ArG | 05.2005 | | 24.3727-0449.2 | 580449 | CABLE FREIN A MAIN | 211 420 02 85 , 211 420 23 85 | |
| | E 280 4-Matic | ArG | 05.2005 | | 24.3727-0449.2 | 580449 | CABLE FREIN A MAIN | 211 420 02 85 , 211 420 23 85 | |
| | E 280 CDI | ArG | 05.2004 | | 24.3727-0449.2 | 580449 | CABLE FREIN A MAIN | 211 420 02 85 , 211 420 23 85 | |
| | E 280 CDI 4-Matic | ArG | 05.2005 | | 24.3727-0449.2 | 580449 | CABLE FREIN A MAIN | 211 420 02 85 , 211 420 23 85 | |
| | E 320 | ArG | 03.2003 | | 24.3727-0449.2 | 580449 | CABLE FREIN A MAIN | 211 420 02 85 , 211 420 23 85 | |
| | E 320 4-Matic | ArG | 07.2003 | | 24.3727-0449.2 | 580449 | CABLE FREIN A MAIN | 211 420 02 85 , 211 420 23 85 | |
| | E 320 CDI | ArG | 03.2003 | | 24.3727-0449.2 | 580449 | CABLE FREIN A MAIN | 211 420 02 85 , 211 420 23 85 | |
| | E 320 CDI 4-Matic | ArG | 05.2005 | | 24.3727-0449.2 | 580449 | CABLE FREIN A MAIN | 211 420 02 85 , 211 420 23 85 | |









| | | | | | | | |
|---|---|---|---|---|-------------|----------------------------------|--|
|  |  |  |  |  | description | Références OE par référence ATE. |  Références remplacées / divers |
|---|---|---|---|---|-------------|----------------------------------|--|

MERCEDES BENZ

| | | | | | | | | | |
|-------------------------------|---------------------|-----|---------|--|----------------|--------|--------------------|-------------------------------|--|
| Classe E (S211) Break (03-) | E 350 | ArG | 12.2004 | | 24.3727-0449.2 | 580449 | CABLE FREIN A MAIN | 211 420 02 85 , 211 420 23 85 | |
| | E 350 4-Matic | ArG | 12.2004 | | 24.3727-0449.2 | 580449 | CABLE FREIN A MAIN | 211 420 02 85 , 211 420 23 85 | |
| | E 500 | ArG | 10.2003 | | 24.3727-0449.2 | 580449 | CABLE FREIN A MAIN | 211 420 02 85 , 211 420 23 85 | |
| | E 500 4-Matic | ArG | 10.2003 | | 24.3727-0449.2 | 580449 | CABLE FREIN A MAIN | 211 420 02 85 , 211 420 23 85 | |
| | E 55 Kompressor AMG | | 07.2003 | | 24.0126-0136.1 | 426136 | DISQUE DE FREIN | 211 423 10 12 | |
| | | ArG | 07.2003 | | 24.3727-0449.2 | 580449 | CABLE FREIN A MAIN | 211 420 02 85 , 211 420 23 85 | |
| | E 63 AMG | | 03.2006 | | 24.0126-0136.1 | 426136 | DISQUE DE FREIN | 211 423 10 12 | |
| | | ArG | 03.2006 | | 24.3727-0449.2 | 580449 | CABLE FREIN A MAIN | 211 420 02 85 , 211 420 23 85 | |
| Classe E (W211) Berline (02-) | E 200 CDI | ArG | 05.2002 | | 24.3727-0449.2 | 580449 | CABLE FREIN A MAIN | 211 420 02 85 , 211 420 23 85 | |
| | E 200 Kompressor | ArG | 05.2002 | | 24.3727-0449.2 | 580449 | CABLE FREIN A MAIN | 211 420 02 85 , 211 420 23 85 | |
| | E 220 CDI | ArG | 03.2002 | | 24.3727-0449.2 | 580449 | CABLE FREIN A MAIN | 211 420 02 85 , 211 420 23 85 | |
| | E 230 | ArG | 04.2006 | | 24.3727-0449.2 | 580449 | CABLE FREIN A MAIN | 211 420 02 85 , 211 420 23 85 | |
| | E 240 | ArG | 03.2002 | | 24.3727-0449.2 | 580449 | CABLE FREIN A MAIN | 211 420 02 85 , 211 420 23 85 | |
| | E 240 4-Matic | ArG | 03.2003 | | 24.3727-0449.2 | 580449 | CABLE FREIN A MAIN | 211 420 02 85 , 211 420 23 85 | |



| | | | | | | | |
|---|---|---|---|---|-------------|----------------------------------|--|
|  |  |  |  |  | description | Références OE par référence ATE. |  Références remplacées / divers |
|---|---|---|---|---|-------------|----------------------------------|--|







MERCEDES BENZ

| Classe E (W211) Berline (02-) | E 270 CDI | ArG | 03.2002 | | 24.3727-0449.2 | 580449 | CABLE FREIN A MAIN | 211 420 02 85 , 211 420 23 85 | |
|-------------------------------|-------------------|-----|---------|--|----------------|--------|--------------------|-------------------------------|--|
| | E 280 | ArG | 05.2005 | | 24.3727-0449.2 | 580449 | CABLE FREIN A MAIN | 211 420 02 85 , 211 420 23 85 | |
| | E 280 4-Matic | ArG | 05.2005 | | 24.3727-0449.2 | 580449 | CABLE FREIN A MAIN | 211 420 02 85 , 211 420 23 85 | |
| | E 280 CDI | ArG | 05.2004 | | 24.3727-0449.2 | 580449 | CABLE FREIN A MAIN | 211 420 02 85 , 211 420 23 85 | |
| | E 280 CDI 4-Matic | ArG | 05.2005 | | 24.3727-0449.2 | 580449 | CABLE FREIN A MAIN | 211 420 02 85 , 211 420 23 85 | |
| | E 300 Bluetec | ArG | 09.2007 | | 24.3727-0449.2 | 580449 | CABLE FREIN A MAIN | 211 420 02 85 , 211 420 23 85 | |
| | E 320 | ArG | 03.2002 | | 24.3727-0449.2 | 580449 | CABLE FREIN A MAIN | 211 420 02 85 , 211 420 23 85 | |
| | E 320 4-Matic | ArG | 03.2003 | | 24.3727-0449.2 | 580449 | CABLE FREIN A MAIN | 211 420 02 85 , 211 420 23 85 | |
| | E 320 CDI | ArG | 11.2002 | | 24.3727-0449.2 | 580449 | CABLE FREIN A MAIN | 211 420 02 85 , 211 420 23 85 | |
| | E 320 CDI 4-Matic | ArG | 05.2005 | | 24.3727-0449.2 | 580449 | CABLE FREIN A MAIN | 211 420 02 85 , 211 420 23 85 | |
| | E 350 | ArG | 12.2004 | | 24.3727-0449.2 | 580449 | CABLE FREIN A MAIN | 211 420 02 85 , 211 420 23 85 | |
| | E 350 4-Matic | ArG | 12.2004 | | 24.3727-0449.2 | 580449 | CABLE FREIN A MAIN | 211 420 02 85 , 211 420 23 85 | |
| | E 350 CGI | ArG | 09.2007 | | 24.3727-0449.2 | 580449 | CABLE FREIN A MAIN | 211 420 02 85 , 211 420 23 85 | |

Nouvelles références disponibles - par applications

09/2008



| | | | | | | | |
|---|---|---|---|---|-------------|----------------------------------|---|
|  |  |  |  |  | description | Références OE par référence ATE. |  Références remplacées / divers |
|---|---|---|---|---|-------------|----------------------------------|---|

MERCEDES BENZ

| | | | | | | | | | |
|-------------------------------------|---------------------|-----|---------|--|----------------|--------|---------------------|-------------------------------|-----------|
| Classe E (W211) Berline (02-) | E 400 CDI | ArG | 03.2003 | | 24.3727-0449.2 | 580449 | CABLE FREIN A MAIN | 211 420 02 85 , 211 420 23 85 | |
| | E 500 | ArG | 03.2002 | | 24.3727-0449.2 | 580449 | CABLE FREIN A MAIN | 211 420 02 85 , 211 420 23 85 | |
| | E 500 4-Matic | ArG | 10.2003 | | 24.3727-0449.2 | 580449 | CABLE FREIN A MAIN | 211 420 02 85 , 211 420 23 85 | |
| | E 55 Kompressor AMG | | 10.2002 | | 24.0126-0136.1 | 426136 | DISQUE DE FREIN | 211 423 10 12 | |
| | | ArG | 10.2002 | | 24.3727-0449.2 | 580449 | CABLE FREIN A MAIN | 211 420 02 85 , 211 420 23 85 | |
| | E 63 AMG | | 03.2006 | | 24.0126-0136.1 | 426136 | DISQUE DE FREIN | 211 423 10 12 | |
| | | ArG | 03.2006 | | 24.3727-0449.2 | 580449 | CABLE FREIN A MAIN | 211 420 02 85 , 211 420 23 85 | |
| Classe SLK (R171) (04-) | SLK 200 Kompressor | AvD | 03.2004 | | 24.3571-1740.7 | 220668 | ETRIER A GRIFFE | 001 420 95 83 , 003 420 22 83 | |
| | | AvG | 03.2004 | | 24.3571-1739.7 | 220667 | ETRIER A GRIFFE | 001 420 94 83 , 003 420 21 83 | |
| Transporter (BM 906) SPRINTER (06-) | 209 CDI | | 04.2006 | | 24.0128-0203.1 | 428203 | DISQUE DE FREIN | 906 421 00 12 , 2E0 615 301 | |
| | | | 04.2006 | | 13.0460-3837.2 | 603837 | PLAQUETTES DE FREIN | 004 420 69 20 | cf. Photo |
| | 211 CDI | | 04.2006 | | 24.0128-0203.1 | 428203 | DISQUE DE FREIN | 906 421 00 12 , 2E0 615 301 | |
| | | | 04.2006 | | 13.0460-3837.2 | 603837 | PLAQUETTES DE FREIN | 004 420 69 20 | cf. Photo |
| | 213 CDI | | 04.2006 | | 24.0128-0203.1 | 428203 | DISQUE DE FREIN | 906 421 00 12 , 2E0 615 301 | |
| | | | 04.2006 | | 13.0460-3837.2 | 603837 | PLAQUETTES DE FREIN | 004 420 69 20 | cf. Photo |
| | 215 CDI | | 04.2006 | | 24.0128-0203.1 | 428203 | DISQUE DE FREIN | 906 421 00 12 , 2E0 615 301 | |



| | | | | | | | | |
|--|--|--|--|--|-------------|----------------------------------|--|--------------------------------|
| | | | | | description | Références OE par référence ATE. | | Références remplacées / divers |
|--|--|--|--|--|-------------|----------------------------------|--|--------------------------------|

MERCEDES BENZ

| | | | | | | | | | |
|-------------------------------------|---------|--|---------|--|----------------|--------|---------------------|-----------------------------|-----------|
| Transporter (BM 906) SPRINTER (06-) | 215 CDI | | 04.2006 | | 13.0460-3837.2 | 603837 | PLAQUETTES DE FREIN | 004 420 69 20 | cf. Photo |
| | 218 CDI | | 04.2006 | | 24.0128-0203.1 | 428203 | DISQUE DE FREIN | 906 421 00 12 , 2E0 615 301 | |
| | | | 04.2006 | | 13.0460-3837.2 | 603837 | PLAQUETTES DE FREIN | 004 420 69 20 | cf. Photo |
| | 224 | | 04.2006 | | 24.0128-0203.1 | 428203 | DISQUE DE FREIN | 906 421 00 12 , 2E0 615 301 | |
| | | | 04.2006 | | 13.0460-3837.2 | 603837 | PLAQUETTES DE FREIN | 004 420 69 20 | cf. Photo |
| | 309 CDI | | 04.2006 | | 24.0128-0203.1 | 428203 | DISQUE DE FREIN | 906 421 00 12 , 2E0 615 301 | |
| | | | 04.2006 | | 13.0460-3837.2 | 603837 | PLAQUETTES DE FREIN | 004 420 69 20 | cf. Photo |
| | 311 CDI | | 04.2006 | | 24.0128-0203.1 | 428203 | DISQUE DE FREIN | 906 421 00 12 , 2E0 615 301 | |
| | | | 04.2006 | | 13.0460-3837.2 | 603837 | PLAQUETTES DE FREIN | 004 420 69 20 | cf. Photo |
| | 313 CDI | | 04.2006 | | 24.0128-0203.1 | 428203 | DISQUE DE FREIN | 906 421 00 12 , 2E0 615 301 | |
| | | | 04.2006 | | 13.0460-3837.2 | 603837 | PLAQUETTES DE FREIN | 004 420 69 20 | cf. Photo |
| | 315 CDI | | 04.2006 | | 24.0128-0203.1 | 428203 | DISQUE DE FREIN | 906 421 00 12 , 2E0 615 301 | |
| | | | 04.2006 | | 13.0460-3837.2 | 603837 | PLAQUETTES DE FREIN | 004 420 69 20 | cf. Photo |
| | 318 CDI | | 04.2006 | | 24.0128-0203.1 | 428203 | DISQUE DE FREIN | 906 421 00 12 , 2E0 615 301 | |
| | | | 04.2006 | | 13.0460-3837.2 | 603837 | PLAQUETTES DE FREIN | 004 420 69 20 | cf. Photo |
| | 324 | | 04.2006 | | 24.0128-0203.1 | 428203 | DISQUE DE FREIN | 906 421 00 12 , 2E0 615 301 | |
| | | | 04.2006 | | 13.0460-3837.2 | 603837 | PLAQUETTES DE FREIN | 004 420 69 20 | cf. Photo |
| | 411 CDI | | 04.2006 | | 24.0128-0202.1 | 428202 | DISQUE DE FREIN | 906 423 01 12 , 2E0 615 601 | |
| | | | 04.2006 | | 24.0128-0203.1 | 428203 | DISQUE DE FREIN | 906 421 00 12 , 2E0 615 301 | |



| | | | | | | | | |
|--|--|--|--|--|-------------|----------------------------------|--|--------------------------------|
| | | | | | description | Références OE par référence ATE. | | Références remplacées / divers |
|--|--|--|--|--|-------------|----------------------------------|--|--------------------------------|

MERCEDES BENZ

| | | | | | | | | | |
|-------------------------------------|-------------|--|---------|--|----------------|--------|-----------------|-----------------------------|--|
| Transporter (BM 906) SPRINTER (06-) | 415 CDI | | 04.2006 | | 24.0128-0202.1 | 428202 | DISQUE DE FREIN | 906 423 01 12 , 2E0 615 601 | |
| | | | 04.2006 | | 24.0128-0203.1 | 428203 | DISQUE DE FREIN | 906 421 00 12 , 2E0 615 301 | |
| | 418 CDI | | 04.2006 | | 24.0128-0202.1 | 428202 | DISQUE DE FREIN | 906 423 01 12 , 2E0 615 601 | |
| | | | 04.2006 | | 24.0128-0203.1 | 428203 | DISQUE DE FREIN | 906 421 00 12 , 2E0 615 301 | |
| | 424 | | 04.2006 | | 24.0128-0202.1 | 428202 | DISQUE DE FREIN | 906 423 01 12 , 2E0 615 601 | |
| | | | 04.2006 | | 24.0128-0203.1 | 428203 | DISQUE DE FREIN | 906 421 00 12 , 2E0 615 301 | |
| | 509 CDI | | 04.2006 | | 24.0128-0203.1 | 428203 | DISQUE DE FREIN | 906 421 00 12 , 2E0 615 301 | |
| | | | 04.2006 | | 24.0128-0202.1 | 428202 | DISQUE DE FREIN | 906 423 01 12 , 2E0 615 601 | |
| | 511 CDI | | 04.2006 | | 24.0128-0202.1 | 428202 | DISQUE DE FREIN | 906 423 01 12 , 2E0 615 601 | |
| | | | 04.2006 | | 24.0128-0203.1 | 428203 | DISQUE DE FREIN | 906 421 00 12 , 2E0 615 301 | |
| | 515 CDI | | 04.2006 | | 24.0128-0203.1 | 428203 | DISQUE DE FREIN | 906 421 00 12 , 2E0 615 301 | |
| | | | 04.2006 | | 24.0128-0202.1 | 428202 | DISQUE DE FREIN | 906 423 01 12 , 2E0 615 601 | |
| | 518 CDI | | 04.2006 | | 24.0128-0202.1 | 428202 | DISQUE DE FREIN | 906 423 01 12 , 2E0 615 601 | |
| | | | 04.2006 | | 24.0128-0203.1 | 428203 | DISQUE DE FREIN | 906 421 00 12 , 2E0 615 301 | |
| | 524 | | 04.2006 | | 24.0128-0202.1 | 428202 | DISQUE DE FREIN | 906 423 01 12 , 2E0 615 601 | |
| | | | 04.2006 | | 24.0128-0203.1 | 428203 | DISQUE DE FREIN | 906 421 00 12 , 2E0 615 301 | |
| Transporter VARIO (96-) | VARIO 614 D | | 09.1996 | | 24.0130-0191.1 | 430191 | DISQUE DE FREIN | 668 423 01 12 | |
| | VARIO 615 D | | 09.1998 | | 24.0130-0191.1 | 430191 | DISQUE DE FREIN | 668 423 01 12 | |
| | VARIO 814 D | | 09.1996 | | 24.0130-0191.1 | 430191 | DISQUE DE FREIN | 668 423 01 12 | |



| | | | | | | | | |
|--|--|--|--|--|-------------|----------------------------------|--|--------------------------------|
| | | | | | description | Références OE par référence ATE. | | Références remplacées / divers |
|--|--|--|--|--|-------------|----------------------------------|--|--------------------------------|







MERCEDES BENZ

| | | | | | | | | | |
|-------------------------|-------------|--|---------|--|----------------|--------|--------------------|---------------|--|
| Transporter VARIO (96-) | VARIO 815 D | | 09.1996 | | 24.0130-0191.1 | 430191 | DISQUE DE FREIN | 668 423 01 12 | |
| VANEO (BM414) (02-) | 1,6 | | 02.2002 | | 24.3727-0450.2 | 580450 | CABLE FREIN A MAIN | 414 420 01 85 | |
| | 1,7 CDI | | 02.2002 | | 24.3727-0450.2 | 580450 | CABLE FREIN A MAIN | 414 420 01 85 | |
| | 1,9 | | 02.2002 | | 24.3727-0450.2 | 580450 | CABLE FREIN A MAIN | 414 420 01 85 | |

MINI

| | | | | | | | | | |
|-----------------------|----------------------|--|---------|---------|----------------|--------|---------------------|-----------------|-----------|
| R50/R53 (00-06) | Cooper S Works 1,6 i | | 11.2003 | 11.2006 | 24.0122-0244.1 | 422244 | DISQUE DE FREIN | 34 11 6 768 933 | |
| R52 Décapotable (04-) | | | 11.2003 | | 24.0122-0244.1 | 422244 | DISQUE DE FREIN | 34 11 6 768 933 | |
| R55 Clubman (07-) | Cooper | | 09.2007 | | 13.0460-2714.2 | 602714 | PLAQUETTES DE FREIN | 34 21 6 778 327 | cf. Photo |
| | Cooper D | | 09.2007 | | 13.0460-2714.2 | 602714 | PLAQUETTES DE FREIN | 34 21 6 778 327 | cf. Photo |
| | Cooper S | | 09.2007 | | 13.0460-2714.2 | 602714 | PLAQUETTES DE FREIN | 34 21 6 778 327 | cf. Photo |
| R56 (06-) | Cooper | | 11.2006 | | 13.0460-2714.2 | 602714 | PLAQUETTES DE FREIN | 34 21 6 778 327 | cf. Photo |
| | Cooper D | | 04.2007 | | 13.0460-2714.2 | 602714 | PLAQUETTES DE FREIN | 34 21 6 778 327 | cf. Photo |
| | Cooper S | | 11.2006 | | 13.0460-2714.2 | 602714 | PLAQUETTES DE FREIN | 34 21 6 778 327 | cf. Photo |
| | One 1,4 i | | 04.2007 | | 13.0460-2714.2 | 602714 | PLAQUETTES DE FREIN | 34 21 6 778 327 | cf. Photo |



| | | | | | | | | |
|---|---|---|---|---|-------------|----------------------------------|---|--------------------------------|
|  |  |  |  |  | description | Références OE par référence ATE. |  | Références remplacées / divers |
|---|---|---|---|---|-------------|----------------------------------|---|--------------------------------|

MITSUBISHI

| | | | | | | | | | |
|--------------------------|--------------------|-----|---------|---------|----------------|--------|-----------------|---------------------|--|
| L 200 (92-96) | 2,5 TD 4WD (K34T) | AvG | 05.1993 | 08.1996 | 24.3431-1705.5 | 240365 | ETRIER A GRIFFE | MB858404 | |
| | | AvD | 05.1993 | 08.1996 | 24.3431-1706.5 | 240366 | ETRIER A GRIFFE | MB858405 | |
| L 200 (96-06) | 2,5 TD 4WD (K74T) | AvD | 06.1996 | 07.2001 | 24.3431-1706.5 | 240366 | ETRIER A GRIFFE | MB858405 | |
| | | AvD | 08.2001 | 04.2006 | 24.3431-1706.5 | 240366 | ETRIER A GRIFFE | MB858405 | |
| | | AvG | 08.2001 | 04.2006 | 24.3431-1705.5 | 240365 | ETRIER A GRIFFE | MB858404 | |
| | | AvG | 06.1996 | 07.2001 | 24.3431-1705.5 | 240365 | ETRIER A GRIFFE | MB858404 | |
| | 2,5 TDi 4WD (K74T) | AvD | 08.2001 | 04.2006 | 24.3431-1706.5 | 240366 | ETRIER A GRIFFE | MB858405 | |
| | | AvG | 08.2001 | 04.2006 | 24.3431-1705.5 | 240365 | ETRIER A GRIFFE | MB858404 | |
| LANCER Evolution (04-07) | 2,0 i 16V (CT9A) | | 08.2005 | 08.2007 | 24.0126-0134.1 | 426134 | DISQUE DE FREIN | MR510967 , MR510966 | |
| LANCER Kombi (03-07) | 2,0 i 16V (CS9W) | | 09.2003 | 03.2007 | 24.0126-0134.1 | 426134 | DISQUE DE FREIN | MR510967 , MR510966 | |
| | 2,4 i 16V (CS9W) | | 09.2003 | 03.2007 | 24.0126-0134.1 | 426134 | DISQUE DE FREIN | MR510967 , MR510966 | |
| LANCER Limousine (03-07) | 2,0 i 16V (CS9A) | | 12.2003 | 03.2007 | 24.0126-0134.1 | 426134 | DISQUE DE FREIN | MR510967 , MR510966 | |
| PAJERO (90-00) | 2,4 (V21C/V21W) | AvG | 12.1990 | 03.2000 | 24.3431-1705.5 | 240365 | ETRIER A GRIFFE | MB858404 | |
| | | AvD | 12.1990 | 03.2000 | 24.3431-1706.5 | 240366 | ETRIER A GRIFFE | MB858405 | |
| | 2,4 (V41W) | AvD | 12.1990 | 03.2000 | 24.3431-1706.5 | 240366 | ETRIER A GRIFFE | MB858405 | |
| | | AvG | 12.1990 | 03.2000 | 24.3431-1705.5 | 240365 | ETRIER A GRIFFE | MB858404 | |
| | 2,5 TD (V24C/V24W) | AvG | 12.1990 | 03.2000 | 24.3431-1705.5 | 240365 | ETRIER A GRIFFE | MB858404 | |
| | | AvD | 12.1990 | 03.2000 | 24.3431-1706.5 | 240366 | ETRIER A GRIFFE | MB858405 | |
| | 2,5 TD (V44W) | AvG | 12.1990 | 03.2000 | 24.3431-1705.5 | 240365 | ETRIER A GRIFFE | MB858404 | |

Nouvelles références disponibles - par applications

09/2008



| | | | | | | | | |
|--|--|--|--|--|-------------|----------------------------------|--|--------------------------------|
| | | | | | description | Références OE par référence ATE. | | Références remplacées / divers |
|--|--|--|--|--|-------------|----------------------------------|--|--------------------------------|

MITSUBISHI

| | | | | | | | | | |
|------------------------------------|--------------------|-----|---------|---------|----------------|--------|-----------------|----------|--|
| PAJERO (90-00) | 2,5 TD (V44W) | AvD | 12.1990 | 03.2000 | 24.3431-1706.5 | 240366 | ETRIER A GRIFFE | MB858405 | |
| | 2,8 TD (V26W) | AvD | 11.1993 | 03.2000 | 24.3431-1706.5 | 240366 | ETRIER A GRIFFE | MB858405 | |
| | | AvG | 11.1993 | 03.2000 | 24.3431-1705.5 | 240365 | ETRIER A GRIFFE | MB858404 | |
| | 2,8 TD (V46W) | AvG | 11.1993 | 03.2000 | 24.3431-1705.5 | 240365 | ETRIER A GRIFFE | MB858404 | |
| | | AvD | 11.1993 | 03.2000 | 24.3431-1706.5 | 240366 | ETRIER A GRIFFE | MB858405 | |
| | 3,0 V6 (V23C/V23W) | AvD | 12.1990 | 03.2000 | 24.3431-1706.5 | 240366 | ETRIER A GRIFFE | MB858405 | |
| | | AvG | 12.1990 | 03.2000 | 24.3431-1705.5 | 240365 | ETRIER A GRIFFE | MB858404 | |
| | 3,0 V6 (V43W) | AvD | 12.1990 | 03.2000 | 24.3431-1706.5 | 240366 | ETRIER A GRIFFE | MB858405 | |
| | | AvG | 12.1990 | 03.2000 | 24.3431-1705.5 | 240365 | ETRIER A GRIFFE | MB858404 | |
| PAJERO SPORT / MONTERO (USA) (98-) | 2,5 TDCi (K94W) | AvG | 07.2002 | | 24.3431-1705.5 | 240365 | ETRIER A GRIFFE | MB858404 | |
| | | AvG | 08.2003 | | 24.3431-1705.5 | 240365 | ETRIER A GRIFFE | MB858404 | |
| | | AvG | 11.1998 | | 24.3431-1705.5 | 240365 | ETRIER A GRIFFE | MB858404 | |
| | | AvD | 08.2003 | | 24.3431-1706.5 | 240366 | ETRIER A GRIFFE | MB858405 | |
| | | AvD | 07.2002 | | 24.3431-1706.5 | 240366 | ETRIER A GRIFFE | MB858405 | |
| | | AvD | 11.1998 | | 24.3431-1706.5 | 240366 | ETRIER A GRIFFE | MB858405 | |
| SPACE GEAR (95-00) | 2,4 i 4x4 | AvD | 05.1995 | 05.2000 | 24.3431-1706.5 | 240366 | ETRIER A GRIFFE | MB858405 | |
| | | AvG | 05.1995 | 05.2000 | 24.3431-1705.5 | 240365 | ETRIER A GRIFFE | MB858404 | |
| | 2,5 TDCi 4x4 | AvD | 05.1995 | 05.2000 | 24.3431-1706.5 | 240366 | ETRIER A GRIFFE | MB858405 | |
| | | AvG | 05.1995 | 05.2000 | 24.3431-1705.5 | 240365 | ETRIER A GRIFFE | MB858404 | |



| | | | | | | | | |
|--|--|--|--|--|-------------|----------------------------------|--|--------------------------------|
| | | | | | description | Références OE par référence ATE. | | Références remplacées / divers |
|--|--|--|--|--|-------------|----------------------------------|--|--------------------------------|

MITSUBISHI

| | | | | | | | | | |
|----------------------|--------------------|--|---------|---------|----------------|--------|-----------------|---------------------|--|
| SPACE RUNNER (99-03) | 2,0 i 16V (N63W) | | 05.2000 | 04.2003 | 24.0126-0134.1 | 426134 | DISQUE DE FREIN | MR510967 , MR510966 | |
| | 2,4 16V GDI (N64W) | | 05.2000 | 04.2003 | 24.0126-0134.1 | 426134 | DISQUE DE FREIN | MR510967 , MR510966 | |

NISSAN

| | | | | | | | | | |
|----------------------|--------------|--|---------|---------|----------------|--------|-----------------|-------------|--|
| ALMERA (N15) (95-00) | 1,4 i | | 07.1997 | 04.2000 | 24.0120-0203.1 | 420203 | DISQUE DE FREIN | 40206-2N301 | |
| | 1,6 i | | 07.1997 | 04.2000 | 24.0120-0203.1 | 420203 | DISQUE DE FREIN | 40206-2N301 | |
| | 2,0 D | | 07.1997 | 04.2000 | 24.0120-0203.1 | 420203 | DISQUE DE FREIN | 40206-2N301 | |
| MURANO (Z50) (03-) | 3,5 i V6 4x4 | | 10.2003 | | 24.0116-0122.1 | 416122 | DISQUE DE FREIN | 43206-CA000 | |



| | | | | | | | | |
|--|--|--|--|--|-------------|----------------------------------|--|--------------------------------|
| | | | | | description | Références OE par référence ATE. | | Références remplacées / divers |
|--|--|--|--|--|-------------|----------------------------------|--|--------------------------------|

OPEL

| | | | | | | | | | |
|---------------------------------------|--------------------|-----|---------|---------|----------------|--------|-----------------|--|--|
| ASTRA G / Vauxhall Astra MKIV (98-04) | 1,8 16V Cabrio | ArG | 07.2001 | 12.2004 | 24.3384-1753.7 | 220633 | ETRIER A GRIFFE | 93170606 , 5 42 047 , 5 42 467 , 93176084 | |
| | | ArD | 07.2001 | 12.2004 | 24.3384-1754.7 | 220634 | ETRIER A GRIFFE | 93170607 , 5 42 044 , 5 42 468 , 93176085 | |
| | 1,8 16V Coupe | ArG | 07.2001 | 12.2004 | 24.3384-1753.7 | 220633 | ETRIER A GRIFFE | 93170606 , 5 42 047 , 5 42 467 , 93176084 | |
| | | ArD | 07.2001 | 12.2004 | 24.3384-1754.7 | 220634 | ETRIER A GRIFFE | 93170607 , 5 42 044 , 5 42 468 , 93176085 | |
| | 2,0 16V OPC | ArG | 07.2001 | 12.2004 | 24.3384-1753.7 | 220633 | ETRIER A GRIFFE | 93170606 , 5 42 047 , 5 42 467 , 93176084 | |
| | | ArD | 07.2001 | 12.2004 | 24.3384-1754.7 | 220634 | ETRIER A GRIFFE | 93170607 , 5 42 044 , 5 42 468 , 93176085 | |
| | | | 10.1999 | 12.2004 | 24.0325-0142.1 | 525142 | POWER-DISC | 5055389 , 4567798 , 9184405 , 5 69 061 , 9194477 , 5391560 | |
| | 2,0 16V OPC Cabrio | ArG | 03.2002 | 12.2004 | 24.3384-1753.7 | 220633 | ETRIER A GRIFFE | 93170606 , 5 42 047 , 5 42 467 , 93176084 | |
| | | ArD | 03.2002 | 12.2004 | 24.3384-1754.7 | 220634 | ETRIER A GRIFFE | 93170607 , 5 42 044 , 5 42 468 , 93176085 | |
| | | | 03.2002 | 12.2004 | 24.0325-0142.1 | 525142 | POWER-DISC | 5055389 , 4567798 , 9184405 , 5 69 061 , 9194477 , 5391560 | |
| | 2,0 Turbo | ArG | 07.2001 | 12.2004 | 24.3384-1753.7 | 220633 | ETRIER A GRIFFE | 93170606 , 5 42 047 , 5 42 467 , 93176084 | |
| | | ArD | 07.2001 | 12.2004 | 24.3384-1754.7 | 220634 | ETRIER A GRIFFE | 93170607 , 5 42 044 , 5 42 468 , 93176085 | |

Nouvelles références disponibles - par applications

09/2008



| | | | | | | | | |
|--|--|--|--|--|-------------|----------------------------------|--|--------------------------------|
| | | | | | description | Références OE par référence ATE. | | Références remplacées / divers |
|--|--|--|--|--|-------------|----------------------------------|--|--------------------------------|





OPEL

| | | | | | | | | | |
|--|--------------------|-----|---------|---------|----------------|--------|-----------------|--|--|
| ASTRA G / Vauxhall Astra MKIV (98-04) | 2,0 Turbo | | 03.2000 | 12.2004 | 24.0325-0142.1 | 525142 | POWER-DISC | 5055389 , 4567798 , 9184405 , 5 69 061 , 9194477 , 5391560 | |
| | 2,2 16V Cabrio | ArD | 07.2001 | 12.2004 | 24.3384-1754.7 | 220634 | ETRIER A GRIFFE | 93170607 , 5 42 044 , 5 42 468 , 93176085 | |
| | | ArG | 07.2001 | 12.2004 | 24.3384-1753.7 | 220633 | ETRIER A GRIFFE | 93170606 , 5 42 047 , 5 42 467 , 93176084 | |
| | 2,2 16V Coupe | ArD | 07.2001 | 12.2004 | 24.3384-1754.7 | 220634 | ETRIER A GRIFFE | 93170607 , 5 42 044 , 5 42 468 , 93176085 | |
| | | ArG | 07.2001 | 12.2004 | 24.3384-1753.7 | 220633 | ETRIER A GRIFFE | 93170606 , 5 42 047 , 5 42 467 , 93176084 | |
| | 2,2 DTI 16V Cabrio | ArG | 09.2002 | 12.2004 | 24.3384-1753.7 | 220633 | ETRIER A GRIFFE | 93170606 , 5 42 047 , 5 42 467 , 93176084 | |
| | | ArD | 09.2002 | 12.2004 | 24.3384-1754.7 | 220634 | ETRIER A GRIFFE | 93170607 , 5 42 044 , 5 42 468 , 93176085 | |
| | 2,2 DTI 16V Coupe | ArG | 09.2002 | 12.2004 | 24.3384-1753.7 | 220633 | ETRIER A GRIFFE | 93170606 , 5 42 047 , 5 42 467 , 93176084 | |
| | | ArD | 09.2002 | 12.2004 | 24.3384-1754.7 | 220634 | ETRIER A GRIFFE | 93170607 , 5 42 044 , 5 42 468 , 93176085 | |
| ASTRA H / GTC / Vauxhall Astra MKV (04-) | 1,3 CDTI | | 08.2005 | | 24.0325-0148.1 | 525148 | POWER-DISC | 5 69 006 , 93175376 , 93181113 , 5 69 007 | |
| | 1,4 | | 01.2004 | | 24.0325-0148.1 | 525148 | POWER-DISC | 5 69 006 , 93175376 , 93181113 , 5 69 007 | |
| | 1,6 | | 01.2004 | | 24.0325-0148.1 | 525148 | POWER-DISC | 5 69 006 , 93175376 , 93181113 , 5 69 007 | |
| | | | 01.2007 | | 24.0325-0148.1 | 525148 | POWER-DISC | 5 69 006 , 93175376 , 93181113 , 5 69 007 | |

Nouvelles références disponibles - par applications

09/2008



| | | | | | | |
|---|---|--|---|-------------|--|--|
|  |  |  |  | description | Références OE par référence ATE. |  Références remplacées / divers |
|---|---|--|---|-------------|--|--|

OPEL

| | | | | | | | | | |
|--|-----------|--|---------|--|----------------|--------|------------|--|--|
| ASTRA H / GTC / Vauxhall Astra MKV (04-) | 1,6 Turbo | | 01.2007 | | 24.0325-0148.1 | 525148 | POWER-DISC | 5 69 006 , 93175376 , 93181113 , 5 69 007 | |
| | | | 01.2007 | | 24.0325-0142.1 | 525142 | POWER-DISC | 5055389 , 4567798 , 9184405 , 5 69 061 , 9194477 , 5391560 | |
| | 1,7 CDTI | | 01.2004 | | 24.0325-0148.1 | 525148 | POWER-DISC | 5 69 006 , 93175376 , 93181113 , 5 69 007 | |
| | | | 04.2007 | | 24.0325-0148.1 | 525148 | POWER-DISC | 5 69 006 , 93175376 , 93181113 , 5 69 007 | |
| | | | 04.2007 | | 24.0325-0142.1 | 525142 | POWER-DISC | 5055389 , 4567798 , 9184405 , 5 69 061 , 9194477 , 5391560 | |
| | 1,8 | | 01.2004 | | 24.0325-0148.1 | 525148 | POWER-DISC | 5 69 006 , 93175376 , 93181113 , 5 69 007 | |
| | | | 01.2006 | | 24.0325-0148.1 | 525148 | POWER-DISC | 5 69 006 , 93175376 , 93181113 , 5 69 007 | |
| | 1,9 CDTI | | 09.2004 | | 24.0325-0142.1 | 525142 | POWER-DISC | 5055389 , 4567798 , 9184405 , 5 69 061 , 9194477 , 5391560 | |
| | | | 09.2005 | | 24.0325-0142.1 | 525142 | POWER-DISC | 5055389 , 4567798 , 9184405 , 5 69 061 , 9194477 , 5391560 | |
| | | | 09.2004 | | 24.0325-0148.1 | 525148 | POWER-DISC | 5 69 006 , 93175376 , 93181113 , 5 69 007 | |
| | | | 09.2005 | | 24.0325-0148.1 | 525148 | POWER-DISC | 5 69 006 , 93175376 , 93181113 , 5 69 007 | |
| | 2,0 Turbo | | 01.2004 | | 24.0325-0142.1 | 525142 | POWER-DISC | 5055389 , 4567798 , 9184405 , 5 69 061 , 9194477 , 5391560 | |

Nouvelles références disponibles - par applications

09/2008



| | | | | | | | | |
|--|--|--|--|--|-------------|----------------------------------|--|--------------------------------|
| | | | | | description | Références OE par référence ATE. | | Références remplacées / divers |
|--|--|--|--|--|-------------|----------------------------------|--|--------------------------------|

OPEL

| | | | | | | | | | |
|---|---------------|--|---------|--|----------------|--------|------------|--|--|
| ASTRA H / GTC / Vauxhall Astra MKV (04-) | 2,0 Turbo | | 09.2004 | | 24.0325-0142.1 | 525142 | POWER-DISC | 5055389 , 4567798 , 9184405 , 5 69 061 , 9194477 , 5391560 | |
| | | | 01.2004 | | 24.0325-0148.1 | 525148 | POWER-DISC | 5 69 006 , 93175376 , 93181113 , 5 69 007 | |
| | | | 09.2004 | | 24.0325-0148.1 | 525148 | POWER-DISC | 5 69 006 , 93175376 , 93181113 , 5 69 007 | |
| | 2,0 Turbo OPC | | 03.2005 | | 24.0325-0148.1 | 525148 | POWER-DISC | 5 69 006 , 93175376 , 93181113 , 5 69 007 | |
| ASTRA H Caravan/Vau. Astra MKV Estate (04-) | 1,3 CDTI | | 08.2005 | | 24.0325-0148.1 | 525148 | POWER-DISC | 5 69 006 , 93175376 , 93181113 , 5 69 007 | |
| | 1,4 | | 08.2004 | | 24.0325-0148.1 | 525148 | POWER-DISC | 5 69 006 , 93175376 , 93181113 , 5 69 007 | |
| | 1,6 | | 08.2004 | | 24.0325-0148.1 | 525148 | POWER-DISC | 5 69 006 , 93175376 , 93181113 , 5 69 007 | |
| | | | 01.2007 | | 24.0325-0148.1 | 525148 | POWER-DISC | 5 69 006 , 93175376 , 93181113 , 5 69 007 | |
| | 1,6 Turbo | | 01.2007 | | 24.0325-0148.1 | 525148 | POWER-DISC | 5 69 006 , 93175376 , 93181113 , 5 69 007 | |
| | | | 01.2007 | | 24.0325-0142.1 | 525142 | POWER-DISC | 5055389 , 4567798 , 9184405 , 5 69 061 , 9194477 , 5391560 | |
| | 1,7 CDTI | | 04.2007 | | 24.0325-0148.1 | 525148 | POWER-DISC | 5 69 006 , 93175376 , 93181113 , 5 69 007 | |
| | | | 08.2004 | | 24.0325-0148.1 | 525148 | POWER-DISC | 5 69 006 , 93175376 , 93181113 , 5 69 007 | |

Nouvelles références disponibles - par applications

09/2008



| | | | | | | | | |
|--|--|--|--|--|-------------|----------------------------------|--|--------------------------------|
| | | | | | description | Références OE par référence ATE. | | Références remplacées / divers |
|--|--|--|--|--|-------------|----------------------------------|--|--------------------------------|

OPEL

| | | | | | | | | | |
|---|-----------|--|---------|--|----------------|--------|------------|--|--|
| ASTRA H Caravan/Vau. Astra MKV Estate (04-) | 1,7 CDTI | | 04.2007 | | 24.0325-0142.1 | 525142 | POWER-DISC | 5055389 , 4567798 , 9184405 , 5 69 061 , 9194477 , 5391560 | |
| | 1,8 | | 08.2005 | | 24.0325-0148.1 | 525148 | POWER-DISC | 5 69 006 , 93175376 , 93181113 , 5 69 007 | |
| | | | 09.2004 | | 24.0325-0148.1 | 525148 | POWER-DISC | 5 69 006 , 93175376 , 93181113 , 5 69 007 | |
| | 1,9 CDTI | | 09.2004 | | 24.0325-0148.1 | 525148 | POWER-DISC | 5 69 006 , 93175376 , 93181113 , 5 69 007 | |
| | | | 09.2005 | | 24.0325-0142.1 | 525142 | POWER-DISC | 5055389 , 4567798 , 9184405 , 5 69 061 , 9194477 , 5391560 | |
| | | | 09.2005 | | 24.0325-0148.1 | 525148 | POWER-DISC | 5 69 006 , 93175376 , 93181113 , 5 69 007 | |
| | | | 08.2004 | | 24.0325-0148.1 | 525148 | POWER-DISC | 5 69 006 , 93175376 , 93181113 , 5 69 007 | |
| | | | 09.2004 | | 24.0325-0142.1 | 525142 | POWER-DISC | 5055389 , 4567798 , 9184405 , 5 69 061 , 9194477 , 5391560 | |
| | | | 08.2004 | | 24.0325-0142.1 | 525142 | POWER-DISC | 5055389 , 4567798 , 9184405 , 5 69 061 , 9194477 , 5391560 | |
| | 2,0 Turbo | | 09.2004 | | 24.0325-0148.1 | 525148 | POWER-DISC | 5 69 006 , 93175376 , 93181113 , 5 69 007 | |
| | | | 09.2004 | | 24.0325-0142.1 | 525142 | POWER-DISC | 5055389 , 4567798 , 9184405 , 5 69 061 , 9194477 , 5391560 | |



| | | | | | | | | |
|--|--|--|--|--|-------------|----------------------------------|--|--------------------------------|
| | | | | | description | Références OE par référence ATE. | | Références remplacées / divers |
|--|--|--|--|--|-------------|----------------------------------|--|--------------------------------|

OPEL

| | | | | | | | | | |
|---|-----------|--|---------|--|----------------|--------|------------|--|--|
| ASTRA H Caravan/Vau. Astra MKV Estate (04-) | 2,0 Turbo | | 08.2004 | | 24.0325-0142.1 | 525142 | POWER-DISC | 5055389 , 4567798 , 9184405 , 5 69 061 , 9194477 , 5391560 | |
| | | | 08.2004 | | 24.0325-0148.1 | 525148 | POWER-DISC | 5 69 006 , 93175376 , 93181113 , 5 69 007 | |
| ASTRA TWIN TOP (06-) | 1,6 | | 03.2006 | | 24.0325-0148.1 | 525148 | POWER-DISC | 5 69 006 , 93175376 , 93181113 , 5 69 007 | |
| | | | 12.2006 | | 24.0325-0148.1 | 525148 | POWER-DISC | 5 69 006 , 93175376 , 93181113 , 5 69 007 | |
| | 1,6 Turbo | | 02.2007 | | 24.0325-0148.1 | 525148 | POWER-DISC | 5 69 006 , 93175376 , 93181113 , 5 69 007 | |
| | | | 02.2007 | | 24.0325-0142.1 | 525142 | POWER-DISC | 5055389 , 4567798 , 9184405 , 5 69 061 , 9194477 , 5391560 | |
| | 1,8 | | 03.2006 | | 24.0325-0148.1 | 525148 | POWER-DISC | 5 69 006 , 93175376 , 93181113 , 5 69 007 | |
| | 1,9 CDTI | | 03.2006 | | 24.0325-0142.1 | 525142 | POWER-DISC | 5055389 , 4567798 , 9184405 , 5 69 061 , 9194477 , 5391560 | |
| | | | 03.2006 | | 24.0325-0148.1 | 525148 | POWER-DISC | 5 69 006 , 93175376 , 93181113 , 5 69 007 | |
| | 2,0 Turbo | | 03.2006 | | 24.0325-0142.1 | 525142 | POWER-DISC | 5055389 , 4567798 , 9184405 , 5 69 061 , 9194477 , 5391560 | |
| | | | 03.2006 | | 24.0325-0148.1 | 525148 | POWER-DISC | 5 69 006 , 93175376 , 93181113 , 5 69 007 | |
| COMBO / Vauxhall Combo (01-) | 1,3 CDTI | | | | 24.0325-0148.1 | 525148 | POWER-DISC | 5 69 006 , 93175376 , 93181113 , 5 69 007 | |

Nouvelles références disponibles - par applications

09/2008









| | | | | | | | | |
|--|--|--|--|--|-------------|----------------------------------|--|--------------------------------|
| | | | | | description | Références OE par référence ATE. | | Références remplacées / divers |
|--|--|--|--|--|-------------|----------------------------------|--|--------------------------------|

OPEL

| | | | | | | | | | |
|--|---------------|-----|---------|---------|----------------|--------|-----------------|--|--|
| COMBO / Vauxhall Combo (01-) | 1,4 16V | | | | 24.0325-0148.1 | 525148 | POWER-DISC | 5 69 006 , 93175376 , 93181113 , 5 69 007 | |
| | 1,6 | | | | 24.0325-0148.1 | 525148 | POWER-DISC | 5 69 006 , 93175376 , 93181113 , 5 69 007 | |
| | 1,7 DI 16V | | | | 24.0325-0148.1 | 525148 | POWER-DISC | 5 69 006 , 93175376 , 93181113 , 5 69 007 | |
| | 1,7 DTI 16V | | | | 24.0325-0148.1 | 525148 | POWER-DISC | 5 69 006 , 93175376 , 93181113 , 5 69 007 | |
| CORSA C / Vauxhall Corsa MK II (00-06) | 1,0 12V | AvG | 09.2000 | 09.2006 | 24.3481-1765.5 | 240369 | ETRIER A GRIFFE | 55 42 005 , 9195986 | |
| | | AvD | 09.2000 | 09.2006 | 24.3481-1766.5 | 240370 | ETRIER A GRIFFE | 5 42 085 , 9195987 | |
| | 1,2 16V | AvD | 09.2000 | 09.2006 | 24.3481-1766.5 | 240370 | ETRIER A GRIFFE | 5 42 085 , 9195987 | |
| | | AvG | 09.2000 | 09.2006 | 24.3481-1765.5 | 240369 | ETRIER A GRIFFE | 55 42 005 , 9195986 | |
| | 1,7 DI 16V | AvG | 09.2000 | 09.2006 | 24.3481-1765.5 | 240369 | ETRIER A GRIFFE | 55 42 005 , 9195986 | |
| | | AvD | 09.2000 | 09.2006 | 24.3481-1766.5 | 240370 | ETRIER A GRIFFE | 5 42 085 , 9195987 | |
| CORSA D / Vauxhall Corsa MK III (06-) | 1,0 i | | 10.2006 | | 24.0112-0184.1 | 412184 | DISQUE DE FREIN | 93188916 , 55700918 , 55700398 , 5 69 022 | |
| | 1,6 Turbo OPC | | 03.2007 | | 24.0325-0142.1 | 525142 | POWER-DISC | 5055389 , 4567798 , 9184405 , 5 69 061 , 9194477 , 5391560 | |
| MERIVA / Vauxhall Meriva (02-) | 1,3 CDTI | | 09.2003 | | 24.0325-0148.1 | 525148 | POWER-DISC | 5 69 006 , 93175376 , 93181113 , 5 69 007 | |
| | 1,6 | | 01.2006 | | 24.0325-0148.1 | 525148 | POWER-DISC | 5 69 006 , 93175376 , 93181113 , 5 69 007 | |
| | 1,6 16V | ArG | 05.2003 | | 24.3384-1753.7 | 220633 | ETRIER A GRIFFE | 93170606 , 5 42 047 , 5 42 467 , 93176084 | |



| | | | | | | | | |
|---|---|---|---|---|-------------|----------------------------------|---|--------------------------------|
|  |  |  |  |  | description | Références OE par référence ATE. |  | Références remplacées / divers |
|---|---|---|---|---|-------------|----------------------------------|---|--------------------------------|

OPEL

| | | | | | | | | | |
|--------------------------------------|---------------|-----|---------|---------|----------------|--------|-----------------|--|--|
| MERIVA / Vauxhall Meriva (02-) | 1,6 16V | ArD | 05.2003 | | 24.3384-1754.7 | 220634 | ETRIER A GRIFFE | 93170607 , 5 42 044 , 5 42 468 , 93176085 | |
| | | | 05.2003 | | 24.0325-0148.1 | 525148 | POWER-DISC | 5 69 006 , 93175376 , 93181113 , 5 69 007 | |
| | 1,6 Turbo OPC | | 09.2005 | | 24.0325-0142.1 | 525142 | POWER-DISC | 5055389 , 4567798 , 9184405 , 5 69 061 , 9194477 , 5391560 | |
| | 1,7 CDTI | ArD | 09.2003 | | 24.3384-1754.7 | 220634 | ETRIER A GRIFFE | 93170607 , 5 42 044 , 5 42 468 , 93176085 | |
| | | ArG | 09.2003 | | 24.3384-1753.7 | 220633 | ETRIER A GRIFFE | 93170606 , 5 42 047 , 5 42 467 , 93176084 | |
| | 1,7 DTI 16V | ArG | 09.2002 | | 24.3384-1753.7 | 220633 | ETRIER A GRIFFE | 93170606 , 5 42 047 , 5 42 467 , 93176084 | |
| | | ArD | 09.2002 | | 24.3384-1754.7 | 220634 | ETRIER A GRIFFE | 93170607 , 5 42 044 , 5 42 468 , 93176085 | |
| | | | 09.2002 | | 24.0325-0148.1 | 525148 | POWER-DISC | 5 69 006 , 93175376 , 93181113 , 5 69 007 | |
| | 1,8 16V | ArG | 09.2002 | | 24.3384-1753.7 | 220633 | ETRIER A GRIFFE | 93170606 , 5 42 047 , 5 42 467 , 93176084 | |
| | | ArD | 09.2002 | | 24.3384-1754.7 | 220634 | ETRIER A GRIFFE | 93170607 , 5 42 044 , 5 42 468 , 93176085 | |
| | | | 09.2002 | | 24.0325-0148.1 | 525148 | POWER-DISC | 5 69 006 , 93175376 , 93181113 , 5 69 007 | |
| VECTRA B / Vauxhall Vectra (96-02) | i 500 2,5 | | 05.1998 | 09.2000 | 24.0325-0142.1 | 525142 | POWER-DISC | 5055389 , 4567798 , 9184405 , 5 69 061 , 9194477 , 5391560 | |
| ZAFIRA I / Vauxhall Zafira I (99-05) | 1,6 16V | ArD | 04.1999 | 06.2005 | 24.3384-1754.7 | 220634 | ETRIER A GRIFFE | 93170607 , 5 42 044 , 5 42 468 , 93176085 | |



| | | | | | | | | |
|--|--|--|--|--|-------------|----------------------------------|--|--------------------------------|
| | | | | | description | Références OE par référence ATE. | | Références remplacées / divers |
|--|--|--|--|--|-------------|----------------------------------|--|--------------------------------|

OPEL

| ZAFIRA I / Vauxhall Zafira I (99-05) | 1,6 16V | ArG | 04.1999 | 06.2005 | 24.3384-1753.7 | 220633 | ETRIER A GRIFFE | 93170606 , 5 42 047 , 5 42 467 , 93176084 | |
|--------------------------------------|-------------|-----|---------|---------|----------------|--------|--------------------|--|--|
| | | | | 06.2005 | 24.3727-0784.2 | 580784 | CABLE FREIN A MAIN | 13153655 , 5 22 032 | |
| | 1,8 16V | ArD | 04.1999 | 06.2005 | 24.3384-1754.7 | 220634 | ETRIER A GRIFFE | 93170607 , 5 42 044 , 5 42 468 , 93176085 | |
| | | ArG | 04.1999 | 06.2005 | 24.3384-1753.7 | 220633 | ETRIER A GRIFFE | 93170606 , 5 42 047 , 5 42 467 , 93176084 | |
| | | | | 06.2005 | 24.3727-0784.2 | 580784 | CABLE FREIN A MAIN | 13153655 , 5 22 032 | |
| | 2,0 16V OPC | ArG | 09.2001 | 06.2005 | 24.3384-1753.7 | 220633 | ETRIER A GRIFFE | 93170606 , 5 42 047 , 5 42 467 , 93176084 | |
| | | ArD | 09.2001 | 06.2005 | 24.3384-1754.7 | 220634 | ETRIER A GRIFFE | 93170607 , 5 42 044 , 5 42 468 , 93176085 | |
| | | | | 06.2005 | 24.3727-0784.2 | 580784 | CABLE FREIN A MAIN | 13153655 , 5 22 032 | |
| | | | 09.2001 | 06.2005 | 24.0325-0142.1 | 525142 | POWER-DISC | 5055389 , 4567798 , 9184405 , 5 69 061 , 9194477 , 5391560 | |
| | 2,0 DI 16V | ArG | 10.1999 | 06.2005 | 24.3384-1753.7 | 220633 | ETRIER A GRIFFE | 93170606 , 5 42 047 , 5 42 467 , 93176084 | |
| | | ArD | 10.1999 | 06.2005 | 24.3384-1754.7 | 220634 | ETRIER A GRIFFE | 93170607 , 5 42 044 , 5 42 468 , 93176085 | |
| | | | | 06.2005 | 24.3727-0784.2 | 580784 | CABLE FREIN A MAIN | 13153655 , 5 22 032 | |
| | 2,0 DTI 16V | ArD | 06.2000 | 06.2005 | 24.3384-1754.7 | 220634 | ETRIER A GRIFFE | 93170607 , 5 42 044 , 5 42 468 , 93176085 | |
| | | ArG | 06.2000 | 06.2005 | 24.3384-1753.7 | 220633 | ETRIER A GRIFFE | 93170606 , 5 42 047 , 5 42 467 , 93176084 | |
| | | | | 06.2005 | 24.3727-0784.2 | 580784 | CABLE FREIN A MAIN | 13153655 , 5 22 032 | |







| | | | | | | | | |
|--|--|--|--|--|-------------|----------------------------------|--|--------------------------------|
| | | | | | description | Références OE par référence ATE. | | Références remplacées / divers |
|--|--|--|--|--|-------------|----------------------------------|--|--------------------------------|

OPEL

| | | | | | | | | | |
|--------------------------------------|-------------|-----|---------|---------|----------------|--------|--------------------|--|--|
| ZAFIRA I / Vauxhall Zafira I (99-05) | 2,2 16V | ArD | 09.2000 | 06.2005 | 24.3384-1754.7 | 220634 | ETRIER A GRIFFE | 93170607 , 5 42 044 , 5 42 468 , 93176085 | |
| | | ArG | 09.2000 | 06.2005 | 24.3384-1753.7 | 220633 | ETRIER A GRIFFE | 93170606 , 5 42 047 , 5 42 467 , 93176084 | |
| | | | | 06.2005 | 24.3727-0784.2 | 580784 | CABLE FREIN A MAIN | 13153655 , 5 22 032 | |
| | 2,2 DTI 16V | ArG | 01.2002 | 06.2005 | 24.3384-1753.7 | 220633 | ETRIER A GRIFFE | 93170606 , 5 42 047 , 5 42 467 , 93176084 | |
| | | ArD | 01.2002 | 06.2005 | 24.3384-1754.7 | 220634 | ETRIER A GRIFFE | 93170607 , 5 42 044 , 5 42 468 , 93176085 | |
| | | | | 06.2005 | 24.3727-0784.2 | 580784 | CABLE FREIN A MAIN | 13153655 , 5 22 032 | |
| ZAFIRA II / Vauxhall Zafira II (05-) | 1,7 CDTI | | 12.2007 | | 24.0325-0142.1 | 525142 | POWER-DISC | 5055389 , 4567798 , 9184405 , 5 69 061 , 9194477 , 5391560 | |
| | 1,9 CDTI | | 07.2005 | | 24.0325-0142.1 | 525142 | POWER-DISC | 5055389 , 4567798 , 9184405 , 5 69 061 , 9194477 , 5391560 | |
| | 2,0 Turbo | | 07.2005 | | 24.0325-0142.1 | 525142 | POWER-DISC | 5055389 , 4567798 , 9184405 , 5 69 061 , 9194477 , 5391560 | |
| | 2,2 | | 07.2005 | | 24.0325-0142.1 | 525142 | POWER-DISC | 5055389 , 4567798 , 9184405 , 5 69 061 , 9194477 , 5391560 | |



| | | | | | | |
|---|---|--|---|--------------------|---|---|
|  |  |  |  | <p>description</p> | <p>Références OE par référence ATE.</p> |  <p>Références remplacées / divers</p> |
|---|---|--|---|--------------------|---|---|







PEUGEOT

| | | | | | | | | | |
|-------------|-----------------|--|---------|--|----------------|--------|-----------------|--|--|
| BOXER (06-) | 2,2 HDi (12/14) | | 04.2006 | | 24.0124-0208.1 | 424208 | DISQUE DE FREIN | 4249 26 , 51728377 , 51740244 , 4249 27 | |
| | 2,2 HDi (16H) | | 04.2006 | | 24.0124-0209.1 | 424209 | DISQUE DE FREIN | 4249 35 , 51728378 , 51740247 , 4249 36 | |
| | | | 04.2006 | | 24.0116-0125.1 | 416125 | DISQUE DE FREIN | 4249 39 , 51749275 , 51740248 , 4249 40 | |
| | 3,0 HDi (12/14) | | 04.2006 | | 24.0124-0208.1 | 424208 | DISQUE DE FREIN | 4249 26 , 51728377 , 51740244 , 4249 27 | |
| | 3,0 HDi (16H) | | 04.2006 | | 24.0124-0209.1 | 424209 | DISQUE DE FREIN | 4249 35 , 51728378 , 51740247 , 4249 36 | |
| | | | 04.2006 | | 24.0116-0125.1 | 416125 | DISQUE DE FREIN | 4249 39 , 51749275 , 51740248 , 4249 40 | |

Nouvelles références disponibles - par applications

09/2008



| | | | | | | | |
|---|---|---|---|---|-------------|----------------------------------|--|
|  |  |  |  |  | description | Références OE par référence ATE. |  Références remplacées / divers |
|---|---|---|---|---|-------------|----------------------------------|--|

RENAULT

| Application | Version | Date | Code | Code | Description | Références OE par référence ATE. | Références remplacées / divers | |
|-----------------------------------|--------------------|---------|------|----------------|-------------|----------------------------------|---|----------------|
| LAGUNA II Grandtour (KG_) (01-07) | 1,6 16V | 03.2001 | | 24.0111-0101.2 | 411101 | DISQ+ROULMT+COURON. | 77 01 472 838 , 77 01 713 008 , 82 00 367 094 | 24.0111-0156.1 |
| | 1,8 16V (O4/O6/OV) | 03.2001 | | 24.0111-0101.2 | 411101 | DISQ+ROULMT+COURON. | 77 01 472 838 , 77 01 713 008 , 82 00 367 094 | 24.0111-0156.1 |
| | 1,8 16V (OB/OC/OM) | 03.2001 | | 24.0111-0101.2 | 411101 | DISQ+ROULMT+COURON. | 77 01 472 838 , 77 01 713 008 , 82 00 367 094 | 24.0111-0156.1 |
| | 1,8 16V (OJ) | 03.2001 | | 24.0111-0101.2 | 411101 | DISQ+ROULMT+COURON. | 77 01 472 838 , 77 01 713 008 , 82 00 367 094 | 24.0111-0156.1 |
| | 1,9 dCi | 01.2005 | | 24.0111-0101.2 | 411101 | DISQ+ROULMT+COURON. | 77 01 472 838 , 77 01 713 008 , 82 00 367 094 | 24.0111-0156.1 |
| | | 03.2001 | | 24.0111-0101.2 | 411101 | DISQ+ROULMT+COURON. | 77 01 472 838 , 77 01 713 008 , 82 00 367 094 | 24.0111-0156.1 |
| | | 05.2005 | | 24.0111-0101.2 | 411101 | DISQ+ROULMT+COURON. | 77 01 472 838 , 77 01 713 008 , 82 00 367 094 | 24.0111-0156.1 |
| | 1,9 dCi (O8/10) | 03.2004 | | 24.0111-0101.2 | 411101 | DISQ+ROULMT+COURON. | 77 01 472 838 , 77 01 713 008 , 82 00 367 094 | 24.0111-0156.1 |
| | 1,9 dCi (OE) | 06.2001 | | 24.0111-0101.2 | 411101 | DISQ+ROULMT+COURON. | 77 01 472 838 , 77 01 713 008 , 82 00 367 094 | 24.0111-0156.1 |
| | 1,9 dCi (OG) | 03.2001 | | 24.0111-0101.2 | 411101 | DISQ+ROULMT+COURON. | 77 01 472 838 , 77 01 713 008 , 82 00 367 094 | 24.0111-0156.1 |
| | 1,9 dCi (OR) | 10.2001 | | 24.0111-0101.2 | 411101 | DISQ+ROULMT+COURON. | 77 01 472 838 , 77 01 713 008 , 82 00 367 094 | 24.0111-0156.1 |
| | 2,0 16V | 01.2005 | | 24.0111-0101.2 | 411101 | DISQ+ROULMT+COURON. | 77 01 472 838 , 77 01 713 008 , 82 00 367 094 | 24.0111-0156.1 |
| | 2,0 16V (OO/OK/OW) | 08.2002 | | 24.0111-0101.2 | 411101 | DISQ+ROULMT+COURON. | 77 01 472 838 , 77 01 713 008 , 82 00 367 094 | 24.0111-0156.1 |

Nouvelles références disponibles - par applications

09/2008



| | | | | | | | | |
|--|--|--|--|--|-------------|----------------------------------|--|--------------------------------|
| | | | | | description | Références OE par référence ATE. | | Références remplacées / divers |
|--|--|--|--|--|-------------|----------------------------------|--|--------------------------------|







RENAULT

| | | | | | | | | | |
|-----------------------------------|---------------------|--|---------|--|----------------|--------|---------------------|---|----------------|
| LAGUNA II Grandtour (KG_) (01-07) | 2,0 16V IDE (ON/OP) | | 04.2001 | | 24.0111-0101.2 | 411101 | DISQ+ROULMT+COURON. | 77 01 472 838 , 77 01 713 008 , 82 00 367 094 | 24.0111-0156.1 |
| | 2,0 16V Sport | | 01.2005 | | 24.0111-0101.2 | 411101 | DISQ+ROULMT+COURON. | 77 01 472 838 , 77 01 713 008 , 82 00 367 094 | 24.0111-0156.1 |
| | 2,0 16V Turbo | | 01.2003 | | 24.0111-0101.2 | 411101 | DISQ+ROULMT+COURON. | 77 01 472 838 , 77 01 713 008 , 82 00 367 094 | 24.0111-0156.1 |
| | 2,0 dCi | | 08.2005 | | 24.0111-0101.2 | 411101 | DISQ+ROULMT+COURON. | 77 01 472 838 , 77 01 713 008 , 82 00 367 094 | 24.0111-0156.1 |
| | 2,0 dCi 130 | | 01.2006 | | 24.0111-0101.2 | 411101 | DISQ+ROULMT+COURON. | 77 01 472 838 , 77 01 713 008 , 82 00 367 094 | 24.0111-0156.1 |
| | 2,2 dCi | | 05.2005 | | 24.0111-0101.2 | 411101 | DISQ+ROULMT+COURON. | 77 01 472 838 , 77 01 713 008 , 82 00 367 094 | 24.0111-0156.1 |
| | | | 10.2001 | | 24.0111-0101.2 | 411101 | DISQ+ROULMT+COURON. | 77 01 472 838 , 77 01 713 008 , 82 00 367 094 | 24.0111-0156.1 |
| | 3,0 V6 | | 03.2001 | | 24.0111-0101.2 | 411101 | DISQ+ROULMT+COURON. | 77 01 472 838 , 77 01 713 008 , 82 00 367 094 | 24.0111-0156.1 |
| LAGUNA II Berline (BG_) (01-07) | 1,6 16V | | 03.2001 | | 24.0111-0101.2 | 411101 | DISQ+ROULMT+COURON. | 77 01 472 838 , 77 01 713 008 , 82 00 367 094 | 24.0111-0156.1 |
| | 1,8 16V (O4/O6/OV) | | 03.2001 | | 24.0111-0101.2 | 411101 | DISQ+ROULMT+COURON. | 77 01 472 838 , 77 01 713 008 , 82 00 367 094 | 24.0111-0156.1 |
| | 1,8 16V (OB/OC/OM) | | 03.2001 | | 24.0111-0101.2 | 411101 | DISQ+ROULMT+COURON. | 77 01 472 838 , 77 01 713 008 , 82 00 367 094 | 24.0111-0156.1 |
| | 1,8 16V (OJ) | | 03.2001 | | 24.0111-0101.2 | 411101 | DISQ+ROULMT+COURON. | 77 01 472 838 , 77 01 713 008 , 82 00 367 094 | 24.0111-0156.1 |
| | 1,9 dCi | | 01.2005 | | 24.0111-0101.2 | 411101 | DISQ+ROULMT+COURON. | 77 01 472 838 , 77 01 713 008 , 82 00 367 094 | 24.0111-0156.1 |

Nouvelles références disponibles - par applications

09/2008



| | | | | | | | |
|---|---|---|---|---|-------------|----------------------------------|--|
|  |  |  |  |  | description | Références OE par référence ATE. |  Références remplacées / divers |
|---|---|---|---|---|-------------|----------------------------------|--|

RENAULT

| | | | | | | | | | |
|---------------------------------|---------------------|--|---------|--|----------------|--------|---------------------|---|----------------|
| LAGUNA II Berline (BG_) (01-07) | 1,9 dCi | | 03.2001 | | 24.0111-0101.2 | 411101 | DISQ+ROULMT+COURON. | 77 01 472 838 , 77 01 713 008 , 82 00 367 094 | 24.0111-0156.1 |
| | | | 05.2005 | | 24.0111-0101.2 | 411101 | DISQ+ROULMT+COURON. | 77 01 472 838 , 77 01 713 008 , 82 00 367 094 | 24.0111-0156.1 |
| | 1,9 dCi (08/10) | | 03.2004 | | 24.0111-0101.2 | 411101 | DISQ+ROULMT+COURON. | 77 01 472 838 , 77 01 713 008 , 82 00 367 094 | 24.0111-0156.1 |
| | 1,9 dCi (OE) | | 06.2001 | | 24.0111-0101.2 | 411101 | DISQ+ROULMT+COURON. | 77 01 472 838 , 77 01 713 008 , 82 00 367 094 | 24.0111-0156.1 |
| | 1,9 dCi (OG) | | 03.2001 | | 24.0111-0101.2 | 411101 | DISQ+ROULMT+COURON. | 77 01 472 838 , 77 01 713 008 , 82 00 367 094 | 24.0111-0156.1 |
| | 1,9 dCi (OR) | | 10.2001 | | 24.0111-0101.2 | 411101 | DISQ+ROULMT+COURON. | 77 01 472 838 , 77 01 713 008 , 82 00 367 094 | 24.0111-0156.1 |
| | 2,0 16V | | 01.2005 | | 24.0111-0101.2 | 411101 | DISQ+ROULMT+COURON. | 77 01 472 838 , 77 01 713 008 , 82 00 367 094 | 24.0111-0156.1 |
| | 2,0 16V (OO/OK/OW) | | 08.2002 | | 24.0111-0101.2 | 411101 | DISQ+ROULMT+COURON. | 77 01 472 838 , 77 01 713 008 , 82 00 367 094 | 24.0111-0156.1 |
| | 2,0 16V IDE (ON/OP) | | 04.2001 | | 24.0111-0101.2 | 411101 | DISQ+ROULMT+COURON. | 77 01 472 838 , 77 01 713 008 , 82 00 367 094 | 24.0111-0156.1 |
| | 2,0 16V Sport | | 01.2005 | | 24.0111-0101.2 | 411101 | DISQ+ROULMT+COURON. | 77 01 472 838 , 77 01 713 008 , 82 00 367 094 | 24.0111-0156.1 |
| | 2,0 16V Turbo | | 01.2003 | | 24.0111-0101.2 | 411101 | DISQ+ROULMT+COURON. | 77 01 472 838 , 77 01 713 008 , 82 00 367 094 | 24.0111-0156.1 |
| | 2,0 dCi | | 08.2005 | | 24.0111-0101.2 | 411101 | DISQ+ROULMT+COURON. | 77 01 472 838 , 77 01 713 008 , 82 00 367 094 | 24.0111-0156.1 |
| | 2,0 dCi 130 | | 01.2006 | | 24.0111-0101.2 | 411101 | DISQ+ROULMT+COURON. | 77 01 472 838 , 77 01 713 008 , 82 00 367 094 | 24.0111-0156.1 |

Nouvelles références disponibles - par applications

09/2008



| | | | | | | | | |
|--|--|--|--|--|-------------|----------------------------------|--|--------------------------------|
| | | | | | description | Références OE par référence ATE. | | Références remplacées / divers |
|--|--|--|--|--|-------------|----------------------------------|--|--------------------------------|

RENAULT

| | | | | | | | | | |
|---------------------------------------|-------------|----|---------|---------|----------------|--------|---------------------|---|----------------|
| LAGUNA II Berline (BG_) (01-07) | 2,2 dCi | | 05.2005 | | 24.0111-0101.2 | 411101 | DISQ+ROULMT+COURON. | 77 01 472 838 , 77 01 713 008 , 82 00 367 094 | 24.0111-0156.1 |
| | | | 10.2001 | | 24.0111-0101.2 | 411101 | DISQ+ROULMT+COURON. | 77 01 472 838 , 77 01 713 008 , 82 00 367 094 | 24.0111-0156.1 |
| | 3,0 V6 | | 03.2001 | | 24.0111-0101.2 | 411101 | DISQ+ROULMT+COURON. | 77 01 472 838 , 77 01 713 008 , 82 00 367 094 | 24.0111-0156.1 |
| MASTER II Autobus/car (JD/ND) (98-06) | 1,9 dCi 80 | AR | 11.2001 | 10.2003 | 24.0711-5075.3 | 360232 | CAPTEUR DE ROUE | 82 00 037 443 | |
| | 1,9 dTi | AR | 09.2000 | 10.2003 | 24.0711-5075.3 | 360232 | CAPTEUR DE ROUE | 82 00 037 443 | |
| | 2,2 dCi 90 | AR | 11.2002 | 10.2003 | 24.0711-5075.3 | 360232 | CAPTEUR DE ROUE | 82 00 037 443 | |
| | 2,5 D | AR | 07.1999 | 01.2001 | 24.0711-5075.3 | 360232 | CAPTEUR DE ROUE | 82 00 037 443 | |
| | 2,5 dCi 120 | AR | 10.2001 | 10.2003 | 24.0711-5075.3 | 360232 | CAPTEUR DE ROUE | 82 00 037 443 | |
| | 2,8 dTi | AR | 07.1999 | 10.2001 | 24.0711-5075.3 | 360232 | CAPTEUR DE ROUE | 82 00 037 443 | |
| MASTER II Fourgonnette (FD_) (98-06) | 1,9 dCi 80 | AR | 11.2001 | 10.2003 | 24.0711-5075.3 | 360232 | CAPTEUR DE ROUE | 82 00 037 443 | |
| | 1,9 dTi | AR | 09.2000 | 10.2003 | 24.0711-5075.3 | 360232 | CAPTEUR DE ROUE | 82 00 037 443 | |
| | 2,2 dCi 90 | AR | 11.2002 | 10.2003 | 24.0711-5075.3 | 360232 | CAPTEUR DE ROUE | 82 00 037 443 | |
| | 2,5 D | AR | 07.1999 | 01.2001 | 24.0711-5075.3 | 360232 | CAPTEUR DE ROUE | 82 00 037 443 | |
| | 2,5 dCi 120 | AR | 10.2001 | 10.2003 | 24.0711-5075.3 | 360232 | CAPTEUR DE ROUE | 82 00 037 443 | |
| | 2,8 dTi | AR | 07.1999 | 10.2001 | 24.0711-5075.3 | 360232 | CAPTEUR DE ROUE | 82 00 037 443 | |



| | | | | | | | | |
|--|--|--|--|--|-------------|----------------------------------|--|--------------------------------|
| | | | | | description | Références OE par référence ATE. | | Références remplacées / divers |
|--|--|--|--|--|-------------|----------------------------------|--|--------------------------------|







SAAB

| | | | | | | | | | |
|------------------------|----------------|--|---------|---------|----------------|--------|------------|--|--|
| 9-5 Break (YS3E) (98-) | 2 | | 07.2000 | 07.2001 | 24.0325-0142.1 | 525142 | POWER-DISC | 5055389 , 4567798 , 9184405 , 5 69 061 , 9194477 , 5391560 | |
| | 2,0 t | | 10.1998 | | 24.0325-0142.1 | 525142 | POWER-DISC | 5055389 , 4567798 , 9184405 , 5 69 061 , 9194477 , 5391560 | |
| | 2,3 | | 06.2003 | 08.2005 | 24.0325-0142.1 | 525142 | POWER-DISC | 5055389 , 4567798 , 9184405 , 5 69 061 , 9194477 , 5391560 | |
| | 2,3 T | | 01.2006 | | 24.0325-0142.1 | 525142 | POWER-DISC | 5055389 , 4567798 , 9184405 , 5 69 061 , 9194477 , 5391560 | |
| | | | 07.2003 | | 24.0325-0142.1 | 525142 | POWER-DISC | 5055389 , 4567798 , 9184405 , 5 69 061 , 9194477 , 5391560 | |
| | | | 10.1998 | | 24.0325-0142.1 | 525142 | POWER-DISC | 5055389 , 4567798 , 9184405 , 5 69 061 , 9194477 , 5391560 | |
| | 2,3 T Aero | | 09.2001 | | 24.0325-0142.1 | 525142 | POWER-DISC | 5055389 , 4567798 , 9184405 , 5 69 061 , 9194477 , 5391560 | |
| | | | 10.1999 | 09.2001 | 24.0325-0142.1 | 525142 | POWER-DISC | 5055389 , 4567798 , 9184405 , 5 69 061 , 9194477 , 5391560 | |
| | | | 04.2003 | 03.2004 | 24.0325-0142.1 | 525142 | POWER-DISC | 5055389 , 4567798 , 9184405 , 5 69 061 , 9194477 , 5391560 | |
| | 2,3 t BioPower | | 01.2007 | | 24.0325-0142.1 | 525142 | POWER-DISC | 5055389 , 4567798 , 9184405 , 5 69 061 , 9194477 , 5391560 | |

Nouvelles références disponibles - par applications

09/2008



| | | | | | | | | |
|---|---|---|---|---|-------------|--|---|-----------------------------------|
|  |  |  |  |  | description | Références OE par référence ATE. |  | Références remplacées / divers |
|---|---|---|---|---|-------------|--|---|-----------------------------------|

SAAB

| | | | | | | | | | |
|--------------------------|------------|--|---------|---------|----------------|--------|------------|--|--|
| 9-5 Break (YS3E) (98-) | 3,0 t | | 10.1998 | | 24.0325-0142.1 | 525142 | POWER-DISC | 5055389 , 4567798 , 9184405 , 5 69 061 , 9194477 , 5391560 | |
| | 3,0 TiD | | 07.2001 | | 24.0325-0142.1 | 525142 | POWER-DISC | 5055389 , 4567798 , 9184405 , 5 69 061 , 9194477 , 5391560 | |
| 9-5 Berline (YS3E) (97-) | 2,3 T | | 07.2003 | | 24.0325-0142.1 | 525142 | POWER-DISC | 5055389 , 4567798 , 9184405 , 5 69 061 , 9194477 , 5391560 | |
| | | | 11.2005 | | 24.0325-0142.1 | 525142 | POWER-DISC | 5055389 , 4567798 , 9184405 , 5 69 061 , 9194477 , 5391560 | |
| | 2,3 T Aero | | 09.2001 | | 24.0325-0142.1 | 525142 | POWER-DISC | 5055389 , 4567798 , 9184405 , 5 69 061 , 9194477 , 5391560 | |
| | | | 04.2003 | 03.2004 | 24.0325-0142.1 | 525142 | POWER-DISC | 5055389 , 4567798 , 9184405 , 5 69 061 , 9194477 , 5391560 | |
| | | | 10.1999 | 09.2001 | 24.0325-0142.1 | 525142 | POWER-DISC | 5055389 , 4567798 , 9184405 , 5 69 061 , 9194477 , 5391560 | |
| | 3,0 t | | 01.1998 | | 24.0325-0142.1 | 525142 | POWER-DISC | 5055389 , 4567798 , 9184405 , 5 69 061 , 9194477 , 5391560 | |
| | 3,0 TiD | | 07.2001 | | 24.0325-0142.1 | 525142 | POWER-DISC | 5055389 , 4567798 , 9184405 , 5 69 061 , 9194477 , 5391560 | |

Nouvelles références disponibles - par applications

09/2008



| | | | | | | | | |
|--|--|--|--|--|-------------|----------------------------------|--|--------------------------------|
| | | | | | description | Références OE par référence ATE. | | Références remplacées / divers |
|--|--|--|--|--|-------------|----------------------------------|--|--------------------------------|

SEAT

| | | | | | | | | | |
|-------------------|-----------|-----|---------|--|----------------|--------|-----------------|---|--|
| ALTEA (5P1) (04-) | 1,4 i 16V | ArG | 05.2006 | | 24.3384-1755.7 | 220635 | ETRIER A GRIFFE | 1K0 615 423 D , 1K0 615 423 J , 1K0 615 423 A | |
| | | ArD | 05.2006 | | 24.3384-1756.7 | 220636 | ETRIER A GRIFFE | 1K0 615 424 D , 1K0 615 424 J , 1K0 615 424 A | |
| | | | 05.2006 | | 24.0325-0158.1 | 525158 | POWER-DISC | 1K0 615 301 AA | |
| | 1,4 TSI | ArD | 11.2007 | | 24.3384-1756.7 | 220636 | ETRIER A GRIFFE | 1K0 615 424 D , 1K0 615 424 J , 1K0 615 424 A | |
| | | ArG | 11.2007 | | 24.3384-1755.7 | 220635 | ETRIER A GRIFFE | 1K0 615 423 D , 1K0 615 423 J , 1K0 615 423 A | |
| | | | 11.2007 | | 24.0325-0158.1 | 525158 | POWER-DISC | 1K0 615 301 AA | |
| | 1,6 i 16V | ArD | 03.2004 | | 24.3384-1756.7 | 220636 | ETRIER A GRIFFE | 1K0 615 424 D , 1K0 615 424 J , 1K0 615 424 A | |
| | | ArG | 03.2004 | | 24.3384-1755.7 | 220635 | ETRIER A GRIFFE | 1K0 615 423 D , 1K0 615 423 J , 1K0 615 423 A | |
| | | | 03.2004 | | 24.0325-0158.1 | 525158 | POWER-DISC | 1K0 615 301 AA | |
| | 1,8 TFSI | ArG | 01.2007 | | 24.3384-1755.7 | 220635 | ETRIER A GRIFFE | 1K0 615 423 D , 1K0 615 423 J , 1K0 615 423 A | |
| | | ArD | 01.2007 | | 24.3384-1756.7 | 220636 | ETRIER A GRIFFE | 1K0 615 424 D , 1K0 615 424 J , 1K0 615 424 A | |
| | | | 01.2007 | | 24.0325-0158.1 | 525158 | POWER-DISC | 1K0 615 301 AA | |
| | 1,9 TDI | ArD | 03.2004 | | 24.3384-1756.7 | 220636 | ETRIER A GRIFFE | 1K0 615 424 D , 1K0 615 424 J , 1K0 615 424 A | |
| | | ArG | 03.2004 | | 24.3384-1755.7 | 220635 | ETRIER A GRIFFE | 1K0 615 423 D , 1K0 615 423 J , 1K0 615 423 A | |
| | | | 03.2004 | | 24.0325-0158.1 | 525158 | POWER-DISC | 1K0 615 301 AA | |

Nouvelles références disponibles - par applications

09/2008



| | | | | | | | | |
|--|--|--|--|--|-------------|----------------------------------|--|--------------------------------|
| | | | | | description | Références OE par référence ATE. | | Références remplacées / divers |
|--|--|--|--|--|-------------|----------------------------------|--|--------------------------------|

SEAT

| | | | | | | | | | |
|-------------------|-----------|-----|---------|--|----------------|--------|-----------------|---|--|
| ALTEA (5P1) (04-) | 2,0 FSI | ArD | 03.2004 | | 24.3384-1756.7 | 220636 | ETRIER A GRIFFE | 1K0 615 424 D , 1K0 615 424 J , 1K0 615 424 A | |
| | | ArG | 03.2004 | | 24.3384-1755.7 | 220635 | ETRIER A GRIFFE | 1K0 615 423 D , 1K0 615 423 J , 1K0 615 423 A | |
| | | | 03.2004 | | 24.0325-0158.1 | 525158 | POWER-DISC | 1K0 615 301 AA | |
| | 2,0 i 16V | ArD | 03.2004 | | 24.3384-1756.7 | 220636 | ETRIER A GRIFFE | 1K0 615 424 D , 1K0 615 424 J , 1K0 615 424 A | |
| | | ArG | 03.2004 | | 24.3384-1755.7 | 220635 | ETRIER A GRIFFE | 1K0 615 423 D , 1K0 615 423 J , 1K0 615 423 A | |
| | | | 03.2004 | | 24.0325-0158.1 | 525158 | POWER-DISC | 1K0 615 301 AA | |
| | 2,0 TDI | ArG | 03.2006 | | 24.3384-1755.7 | 220635 | ETRIER A GRIFFE | 1K0 615 423 D , 1K0 615 423 J , 1K0 615 423 A | |
| | | ArD | 03.2006 | | 24.3384-1756.7 | 220636 | ETRIER A GRIFFE | 1K0 615 424 D , 1K0 615 424 J , 1K0 615 424 A | |
| | | ArD | 03.2004 | | 24.3384-1756.7 | 220636 | ETRIER A GRIFFE | 1K0 615 424 D , 1K0 615 424 J , 1K0 615 424 A | |
| | | ArG | 03.2004 | | 24.3384-1755.7 | 220635 | ETRIER A GRIFFE | 1K0 615 423 D , 1K0 615 423 J , 1K0 615 423 A | |
| | | | 03.2004 | | 24.0325-0158.1 | 525158 | POWER-DISC | 1K0 615 301 AA | |
| | | | 03.2006 | | 24.0325-0158.1 | 525158 | POWER-DISC | 1K0 615 301 AA | |
| | 2,0 TFSI | ArG | 03.2006 | | 24.3384-1755.7 | 220635 | ETRIER A GRIFFE | 1K0 615 423 D , 1K0 615 423 J , 1K0 615 423 A | |
| | | ArD | 03.2006 | | 24.3384-1756.7 | 220636 | ETRIER A GRIFFE | 1K0 615 424 D , 1K0 615 424 J , 1K0 615 424 A | |
| | | | 03.2006 | | 24.0325-0158.1 | 525158 | POWER-DISC | 1K0 615 301 AA | |

Nouvelles références disponibles - par applications

09/2008



| | | | | | | | | |
|--|--|--|--|--|-------------|----------------------------------|--|--------------------------------|
| | | | | | description | Références OE par référence ATE. | | Références remplacées / divers |
|--|--|--|--|--|-------------|----------------------------------|--|--------------------------------|

SEAT

| | | | | | | | | | |
|----------------------|-----------|-----|---------|--|----------------|--------|-----------------|---|--|
| ALTEA XL (5P5) (06-) | 1,4 i 16V | ArD | 05.2008 | | 24.3384-1756.7 | 220636 | ETRIER A GRIFFE | 1K0 615 424 D , 1K0 615 424 J , 1K0 615 424 A | |
| | | ArG | 05.2008 | | 24.3384-1755.7 | 220635 | ETRIER A GRIFFE | 1K0 615 423 D , 1K0 615 423 J , 1K0 615 423 A | |
| | | | 05.2008 | | 24.0325-0158.1 | 525158 | POWER-DISC | 1K0 615 301 AA | |
| | 1,4 TSI | ArG | 11.2007 | | 24.3384-1755.7 | 220635 | ETRIER A GRIFFE | 1K0 615 423 D , 1K0 615 423 J , 1K0 615 423 A | |
| | | ArD | 11.2007 | | 24.3384-1756.7 | 220636 | ETRIER A GRIFFE | 1K0 615 424 D , 1K0 615 424 J , 1K0 615 424 A | |
| | | | 11.2007 | | 24.0325-0158.1 | 525158 | POWER-DISC | 1K0 615 301 AA | |
| | 1,6 i 16V | ArG | 10.2006 | | 24.3384-1755.7 | 220635 | ETRIER A GRIFFE | 1K0 615 423 D , 1K0 615 423 J , 1K0 615 423 A | |
| | | ArD | 10.2006 | | 24.3384-1756.7 | 220636 | ETRIER A GRIFFE | 1K0 615 424 D , 1K0 615 424 J , 1K0 615 424 A | |
| | | | 10.2006 | | 24.0325-0158.1 | 525158 | POWER-DISC | 1K0 615 301 AA | |
| | 1,8 TFSI | ArD | 10.2006 | | 24.3384-1756.7 | 220636 | ETRIER A GRIFFE | 1K0 615 424 D , 1K0 615 424 J , 1K0 615 424 A | |
| | | ArG | 10.2006 | | 24.3384-1755.7 | 220635 | ETRIER A GRIFFE | 1K0 615 423 D , 1K0 615 423 J , 1K0 615 423 A | |
| | | | 10.2006 | | 24.0325-0158.1 | 525158 | POWER-DISC | 1K0 615 301 AA | |
| | 1,9 TDI | ArD | 10.2006 | | 24.3384-1756.7 | 220636 | ETRIER A GRIFFE | 1K0 615 424 D , 1K0 615 424 J , 1K0 615 424 A | |
| | | ArG | 10.2006 | | 24.3384-1755.7 | 220635 | ETRIER A GRIFFE | 1K0 615 423 D , 1K0 615 423 J , 1K0 615 423 A | |
| | | | 10.2006 | | 24.0325-0158.1 | 525158 | POWER-DISC | 1K0 615 301 AA | |

Nouvelles références disponibles - par applications

09/2008



| | | | | | | | | |
|--|--|--|--|--|-------------|----------------------------------|--|--------------------------------|
| | | | | | description | Références OE par référence ATE. | | Références remplacées / divers |
|--|--|--|--|--|-------------|----------------------------------|--|--------------------------------|

SEAT

| | | | | | | | | | |
|----------------------|--------------|-----|---------|--|----------------|--------|-----------------|---|--|
| ALTEA XL (5P5) (06-) | 2,0 FSI | ArG | 10.2006 | | 24.3384-1755.7 | 220635 | ETRIER A GRIFFE | 1K0 615 423 D , 1K0 615 423 J , 1K0 615 423 A | |
| | | ArD | 10.2006 | | 24.3384-1756.7 | 220636 | ETRIER A GRIFFE | 1K0 615 424 D , 1K0 615 424 J , 1K0 615 424 A | |
| | | | 10.2006 | | 24.0325-0158.1 | 525158 | POWER-DISC | 1K0 615 301 AA | |
| | 2,0 TDI | ArG | 10.2006 | | 24.3384-1755.7 | 220635 | ETRIER A GRIFFE | 1K0 615 423 D , 1K0 615 423 J , 1K0 615 423 A | |
| | | ArD | 10.2006 | | 24.3384-1756.7 | 220636 | ETRIER A GRIFFE | 1K0 615 424 D , 1K0 615 424 J , 1K0 615 424 A | |
| | | | 10.2006 | | 24.0325-0158.1 | 525158 | POWER-DISC | 1K0 615 301 AA | |
| | 2,0 TDI 4x4 | ArG | 06.2007 | | 24.3384-1755.7 | 220635 | ETRIER A GRIFFE | 1K0 615 423 D , 1K0 615 423 J , 1K0 615 423 A | |
| | | ArD | 06.2007 | | 24.3384-1756.7 | 220636 | ETRIER A GRIFFE | 1K0 615 424 D , 1K0 615 424 J , 1K0 615 424 A | |
| | | | 06.2007 | | 24.0325-0158.1 | 525158 | POWER-DISC | 1K0 615 301 AA | |
| | 2,0 TFSI 4x4 | ArD | 06.2007 | | 24.3384-1756.7 | 220636 | ETRIER A GRIFFE | 1K0 615 424 D , 1K0 615 424 J , 1K0 615 424 A | |
| | | ArG | 06.2007 | | 24.3384-1755.7 | 220635 | ETRIER A GRIFFE | 1K0 615 423 D , 1K0 615 423 J , 1K0 615 423 A | |
| | | | 06.2007 | | 24.0325-0158.1 | 525158 | POWER-DISC | 1K0 615 301 AA | |
| LEON II (1P1) (05-) | 1,4 i 16V | ArD | 06.2006 | | 24.3384-1756.7 | 220636 | ETRIER A GRIFFE | 1K0 615 424 D , 1K0 615 424 J , 1K0 615 424 A | |
| | | ArG | 08.2005 | | 24.3384-1755.7 | 220635 | ETRIER A GRIFFE | 1K0 615 423 D , 1K0 615 423 J , 1K0 615 423 A | |
| | | ArD | 08.2005 | | 24.3384-1756.7 | 220636 | ETRIER A GRIFFE | 1K0 615 424 D , 1K0 615 424 J , 1K0 615 424 A | |



| | | | | | | | | |
|--|--|--|--|--|-------------|----------------------------------|--|--------------------------------|
| | | | | | description | Références OE par référence ATE. | | Références remplacées / divers |
|--|--|--|--|--|-------------|----------------------------------|--|--------------------------------|

SEAT

| | | | | | | | | | |
|---------------------|-----------|-----|---------|--|----------------|--------|-----------------|---|--|
| LEON II (1P1) (05-) | 1,4 i 16V | ArG | 06.2006 | | 24.3384-1755.7 | 220635 | ETRIER A GRIFFE | 1K0 615 423 D , 1K0 615 423 J , 1K0 615 423 A | |
| | | | 06.2006 | | 24.0325-0158.1 | 525158 | POWER-DISC | 1K0 615 301 AA | |
| | | | 08.2005 | | 24.0325-0158.1 | 525158 | POWER-DISC | 1K0 615 301 AA | |
| | 1,4 TSI | ArD | 11.2007 | | 24.3384-1756.7 | 220636 | ETRIER A GRIFFE | 1K0 615 424 D , 1K0 615 424 J , 1K0 615 424 A | |
| | | ArG | 11.2007 | | 24.3384-1755.7 | 220635 | ETRIER A GRIFFE | 1K0 615 423 D , 1K0 615 423 J , 1K0 615 423 A | |
| | | | 11.2007 | | 24.0325-0158.1 | 525158 | POWER-DISC | 1K0 615 301 AA | |
| | 1,6 i | ArD | 08.2005 | | 24.3384-1756.7 | 220636 | ETRIER A GRIFFE | 1K0 615 424 D , 1K0 615 424 J , 1K0 615 424 A | |
| | | ArG | 08.2005 | | 24.3384-1755.7 | 220635 | ETRIER A GRIFFE | 1K0 615 423 D , 1K0 615 423 J , 1K0 615 423 A | |
| | | | 08.2005 | | 24.0325-0158.1 | 525158 | POWER-DISC | 1K0 615 301 AA | |
| | 1,6 i 16V | ArG | 08.2005 | | 24.3384-1755.7 | 220635 | ETRIER A GRIFFE | 1K0 615 423 D , 1K0 615 423 J , 1K0 615 423 A | |
| | | ArD | 08.2005 | | 24.3384-1756.7 | 220636 | ETRIER A GRIFFE | 1K0 615 424 D , 1K0 615 424 J , 1K0 615 424 A | |
| | | | 08.2005 | | 24.0325-0158.1 | 525158 | POWER-DISC | 1K0 615 301 AA | |
| | 1,8 T 20V | ArD | 08.2005 | | 24.3384-1756.7 | 220636 | ETRIER A GRIFFE | 1K0 615 424 D , 1K0 615 424 J , 1K0 615 424 A | |
| | | ArG | 08.2005 | | 24.3384-1755.7 | 220635 | ETRIER A GRIFFE | 1K0 615 423 D , 1K0 615 423 J , 1K0 615 423 A | |
| | | | 08.2005 | | 24.0325-0158.1 | 525158 | POWER-DISC | 1K0 615 301 AA | |

Nouvelles références disponibles - par applications

09/2008



| | | | | | | | | |
|--|--|--|--|--|-------------|----------------------------------|--|--------------------------------|
| | | | | | description | Références OE par référence ATE. | | Références remplacées / divers |
|--|--|--|--|--|-------------|----------------------------------|--|--------------------------------|

SEAT

| | | | | | | | | | |
|---------------------|-----------|-----|---------|--|----------------|--------|-----------------|---|--|
| LEON II (1P1) (05-) | 1,8 TFSI | ArD | 06.2007 | | 24.3384-1756.7 | 220636 | ETRIER A GRIFFE | 1K0 615 424 D , 1K0 615 424 J , 1K0 615 424 A | |
| | | ArG | 06.2007 | | 24.3384-1755.7 | 220635 | ETRIER A GRIFFE | 1K0 615 423 D , 1K0 615 423 J , 1K0 615 423 A | |
| | | | 06.2007 | | 24.0325-0158.1 | 525158 | POWER-DISC | 1K0 615 301 AA | |
| | 1,9 TDI | ArG | 08.2005 | | 24.3384-1755.7 | 220635 | ETRIER A GRIFFE | 1K0 615 423 D , 1K0 615 423 J , 1K0 615 423 A | |
| | | ArD | 08.2005 | | 24.3384-1756.7 | 220636 | ETRIER A GRIFFE | 1K0 615 424 D , 1K0 615 424 J , 1K0 615 424 A | |
| | | | 08.2005 | | 24.0325-0158.1 | 525158 | POWER-DISC | 1K0 615 301 AA | |
| | 2,0 FSI | ArD | 08.2005 | | 24.3384-1756.7 | 220636 | ETRIER A GRIFFE | 1K0 615 424 D , 1K0 615 424 J , 1K0 615 424 A | |
| | | ArG | 08.2005 | | 24.3384-1755.7 | 220635 | ETRIER A GRIFFE | 1K0 615 423 D , 1K0 615 423 J , 1K0 615 423 A | |
| | | | 08.2005 | | 24.0325-0158.1 | 525158 | POWER-DISC | 1K0 615 301 AA | |
| | 2,0 i 16V | ArD | 08.2005 | | 24.3384-1756.7 | 220636 | ETRIER A GRIFFE | 1K0 615 424 D , 1K0 615 424 J , 1K0 615 424 A | |
| | | ArG | 08.2005 | | 24.3384-1755.7 | 220635 | ETRIER A GRIFFE | 1K0 615 423 D , 1K0 615 423 J , 1K0 615 423 A | |
| | | | 08.2005 | | 24.0325-0158.1 | 525158 | POWER-DISC | 1K0 615 301 AA | |
| | 2,0 TDI | ArD | 02.2006 | | 24.3384-1756.7 | 220636 | ETRIER A GRIFFE | 1K0 615 424 D , 1K0 615 424 J , 1K0 615 424 A | |
| | | ArD | 08.2005 | | 24.3384-1756.7 | 220636 | ETRIER A GRIFFE | 1K0 615 424 D , 1K0 615 424 J , 1K0 615 424 A | |
| | | ArG | 08.2005 | | 24.3384-1755.7 | 220635 | ETRIER A GRIFFE | 1K0 615 423 D , 1K0 615 423 J , 1K0 615 423 A | |

Nouvelles références disponibles - par applications

09/2008



| | | | | | | | | |
|--|--|--|--|--|-------------|----------------------------------|--|--------------------------------|
| | | | | | description | Références OE par référence ATE. | | Références remplacées / divers |
|--|--|--|--|--|-------------|----------------------------------|--|--------------------------------|

SEAT

| | | | | | | | | | |
|------------------------|-----------|-----|---------|--|----------------|--------|-----------------|---|--|
| LEON II (1P1) (05-) | 2,0 TDI | ArG | 02.2006 | | 24.3384-1755.7 | 220635 | ETRIER A GRIFFE | 1K0 615 423 D , 1K0 615 423 J , 1K0 615 423 A | |
| | | | 02.2006 | | 24.0325-0158.1 | 525158 | POWER-DISC | 1K0 615 301 AA | |
| | | | 08.2005 | | 24.0325-0158.1 | 525158 | POWER-DISC | 1K0 615 301 AA | |
| | 2,0 TFSI | ArD | 09.2005 | | 24.3384-1756.7 | 220636 | ETRIER A GRIFFE | 1K0 615 424 D , 1K0 615 424 J , 1K0 615 424 A | |
| | | ArD | 11.2006 | | 24.3384-1756.7 | 220636 | ETRIER A GRIFFE | 1K0 615 424 D , 1K0 615 424 J , 1K0 615 424 A | |
| | | ArD | 08.2005 | | 24.3384-1756.7 | 220636 | ETRIER A GRIFFE | 1K0 615 424 D , 1K0 615 424 J , 1K0 615 424 A | |
| | | ArG | 08.2005 | | 24.3384-1755.7 | 220635 | ETRIER A GRIFFE | 1K0 615 423 D , 1K0 615 423 J , 1K0 615 423 A | |
| | | ArG | 11.2006 | | 24.3384-1755.7 | 220635 | ETRIER A GRIFFE | 1K0 615 423 D , 1K0 615 423 J , 1K0 615 423 A | |
| | | ArG | 09.2005 | | 24.3384-1755.7 | 220635 | ETRIER A GRIFFE | 1K0 615 423 D , 1K0 615 423 J , 1K0 615 423 A | |
| | | | 09.2005 | | 24.0325-0158.1 | 525158 | POWER-DISC | 1K0 615 301 AA | |
| | | | 08.2005 | | 24.0325-0158.1 | 525158 | POWER-DISC | 1K0 615 301 AA | |
| | | | 11.2006 | | 24.0325-0158.1 | 525158 | POWER-DISC | 1K0 615 301 AA | |
| TOLEDO III (5P2) (05-) | 1,6 i 16V | ArD | 10.2004 | | 24.3384-1756.7 | 220636 | ETRIER A GRIFFE | 1K0 615 424 D , 1K0 615 424 J , 1K0 615 424 A | |
| | | ArG | 10.2004 | | 24.3384-1755.7 | 220635 | ETRIER A GRIFFE | 1K0 615 423 D , 1K0 615 423 J , 1K0 615 423 A | |
| | 1,8 TFSI | ArD | 01.2007 | | 24.3384-1756.7 | 220636 | ETRIER A GRIFFE | 1K0 615 424 D , 1K0 615 424 J , 1K0 615 424 A | |



| | | | | | | | | |
|--|--|--|--|--|-------------|----------------------------------|--|--------------------------------|
| | | | | | description | Références OE par référence ATE. | | Références remplacées / divers |
|--|--|--|--|--|-------------|----------------------------------|--|--------------------------------|

SEAT

| | | | | | | | | | |
|------------------------|-----------|-----|---------|--|----------------|--------|-----------------|---|--|
| TOLEDO III (5P2) (05-) | 1,8 TFSI | ArG | 01.2007 | | 24.3384-1755.7 | 220635 | ETRIER A GRIFFE | 1K0 615 423 D , 1K0 615 423 J , 1K0 615 423 A | |
| | 1,9 TDI | ArG | 10.2004 | | 24.3384-1755.7 | 220635 | ETRIER A GRIFFE | 1K0 615 423 D , 1K0 615 423 J , 1K0 615 423 A | |
| | | ArD | 10.2004 | | 24.3384-1756.7 | 220636 | ETRIER A GRIFFE | 1K0 615 424 D , 1K0 615 424 J , 1K0 615 424 A | |
| | 2,0 FSI | ArD | 10.2004 | | 24.3384-1756.7 | 220636 | ETRIER A GRIFFE | 1K0 615 424 D , 1K0 615 424 J , 1K0 615 424 A | |
| | | ArG | 10.2004 | | 24.3384-1755.7 | 220635 | ETRIER A GRIFFE | 1K0 615 423 D , 1K0 615 423 J , 1K0 615 423 A | |
| | 2,0 i 16V | ArG | 10.2004 | | 24.3384-1755.7 | 220635 | ETRIER A GRIFFE | 1K0 615 423 D , 1K0 615 423 J , 1K0 615 423 A | |
| | | ArD | 10.2004 | | 24.3384-1756.7 | 220636 | ETRIER A GRIFFE | 1K0 615 424 D , 1K0 615 424 J , 1K0 615 424 A | |
| | 2,0 TDI | ArD | 10.2004 | | 24.3384-1756.7 | 220636 | ETRIER A GRIFFE | 1K0 615 424 D , 1K0 615 424 J , 1K0 615 424 A | |
| | | ArG | 10.2004 | | 24.3384-1755.7 | 220635 | ETRIER A GRIFFE | 1K0 615 423 D , 1K0 615 423 J , 1K0 615 423 A | |
| | | ArG | 01.2006 | | 24.3384-1755.7 | 220635 | ETRIER A GRIFFE | 1K0 615 423 D , 1K0 615 423 J , 1K0 615 423 A | |
| | | ArD | 01.2006 | | 24.3384-1756.7 | 220636 | ETRIER A GRIFFE | 1K0 615 424 D , 1K0 615 424 J , 1K0 615 424 A | |
| | 2,0 TFSI | ArD | 11.2005 | | 24.3384-1756.7 | 220636 | ETRIER A GRIFFE | 1K0 615 424 D , 1K0 615 424 J , 1K0 615 424 A | |
| | | ArG | 11.2005 | | 24.3384-1755.7 | 220635 | ETRIER A GRIFFE | 1K0 615 423 D , 1K0 615 423 J , 1K0 615 423 A | |



| | | | | | | | | |
|--|--|--|--|--|-------------|----------------------------------|--|--------------------------------|
| | | | | | description | Références OE par référence ATE. | | Références remplacées / divers |
|--|--|--|--|--|-------------|----------------------------------|--|--------------------------------|

SKODA

| | | | | | | | | | |
|-----------------------|-----------|-----|---------|--|----------------|--------|-----------------|---|--|
| OCTAVIA II (1Z) (04-) | 1,4 i 16V | ArD | 06.2004 | | 24.3384-1756.7 | 220636 | ETRIER A GRIFFE | 1K0 615 424 D , 1K0 615 424 J , 1K0 615 424 A | |
| | | ArD | 06.2004 | | 24.3414-1710.7 | 220632 | ETRIER A GRIFFE | 1K0 615 424 C , 1K0 615 424 H , 1K0 615 424 F , 1K0 615 424 | |
| | | ArG | 06.2004 | | 24.3384-1755.7 | 220635 | ETRIER A GRIFFE | 1K0 615 423 D , 1K0 615 423 J , 1K0 615 423 A | |
| | | ArG | 06.2004 | | 24.3414-1709.7 | 220631 | ETRIER A GRIFFE | 1K0 615 423 C , 1K0 615 423 H , 1K0 615 423 F , 1K0 615 423 | |
| | 1,6 FSI | ArD | 06.2004 | | 24.3384-1756.7 | 220636 | ETRIER A GRIFFE | 1K0 615 424 D , 1K0 615 424 J , 1K0 615 424 A | |
| | | ArG | 06.2004 | | 24.3414-1709.7 | 220631 | ETRIER A GRIFFE | 1K0 615 423 C , 1K0 615 423 H , 1K0 615 423 F , 1K0 615 423 | |
| | | ArD | 06.2004 | | 24.3414-1710.7 | 220632 | ETRIER A GRIFFE | 1K0 615 424 C , 1K0 615 424 H , 1K0 615 424 F , 1K0 615 424 | |
| | | ArG | 06.2004 | | 24.3384-1755.7 | 220635 | ETRIER A GRIFFE | 1K0 615 423 D , 1K0 615 423 J , 1K0 615 423 A | |
| | 1,6 i 16V | ArG | 06.2004 | | 24.3414-1709.7 | 220631 | ETRIER A GRIFFE | 1K0 615 423 C , 1K0 615 423 H , 1K0 615 423 F , 1K0 615 423 | |
| | | ArD | 06.2004 | | 24.3414-1710.7 | 220632 | ETRIER A GRIFFE | 1K0 615 424 C , 1K0 615 424 H , 1K0 615 424 F , 1K0 615 424 | |
| | | ArG | 06.2004 | | 24.3384-1755.7 | 220635 | ETRIER A GRIFFE | 1K0 615 423 D , 1K0 615 423 J , 1K0 615 423 A | |

Nouvelles références disponibles - par applications

09/2008









| | | | | | | | |
|--|--|--|--|--|-------------|----------------------------------|--------------------------------|
| | | | | | description | Références OE par référence ATE. | Références remplacées / divers |
|--|--|--|--|--|-------------|----------------------------------|--------------------------------|

SKODA

| | | | | | | | | | |
|-----------------------|-----------|-----|---------|--|----------------|--------|-----------------|---|--|
| OCTAVIA II (1Z) (04-) | 1,6 i 16V | ArD | 06.2004 | | 24.3384-1756.7 | 220636 | ETRIER A GRIFFE | 1K0 615 424 D , 1K0 615 424 J , 1K0 615 424 A | |
| | 1,9 TDI | ArD | 06.2004 | | 24.3414-1710.7 | 220632 | ETRIER A GRIFFE | 1K0 615 424 C , 1K0 615 424 H , 1K0 615 424 F , 1K0 615 424 | |
| | | ArG | 06.2004 | | 24.3414-1709.7 | 220631 | ETRIER A GRIFFE | 1K0 615 423 C , 1K0 615 423 H , 1K0 615 423 F , 1K0 615 423 | |
| | | ArG | 06.2004 | | 24.3384-1755.7 | 220635 | ETRIER A GRIFFE | 1K0 615 423 D , 1K0 615 423 J , 1K0 615 423 A | |
| | | ArD | 06.2004 | | 24.3384-1756.7 | 220636 | ETRIER A GRIFFE | 1K0 615 424 D , 1K0 615 424 J , 1K0 615 424 A | |
| | 2,0 FSI | ArD | 11.2004 | | 24.3384-1756.7 | 220636 | ETRIER A GRIFFE | 1K0 615 424 D , 1K0 615 424 J , 1K0 615 424 A | |
| | | ArG | 11.2004 | | 24.3414-1709.7 | 220631 | ETRIER A GRIFFE | 1K0 615 423 C , 1K0 615 423 H , 1K0 615 423 F , 1K0 615 423 | |
| | | ArG | 11.2004 | | 24.3384-1755.7 | 220635 | ETRIER A GRIFFE | 1K0 615 423 D , 1K0 615 423 J , 1K0 615 423 A | |
| | | ArD | 11.2004 | | 24.3414-1710.7 | 220632 | ETRIER A GRIFFE | 1K0 615 424 C , 1K0 615 424 H , 1K0 615 424 F , 1K0 615 424 | |
| | 2,0 TDI | ArD | 06.2004 | | 24.3384-1756.7 | 220636 | ETRIER A GRIFFE | 1K0 615 424 D , 1K0 615 424 J , 1K0 615 424 A | |
| | | ArG | 06.2004 | | 24.3384-1755.7 | 220635 | ETRIER A GRIFFE | 1K0 615 423 D , 1K0 615 423 J , 1K0 615 423 A | |
| | | ArG | 06.2004 | | 24.3414-1709.7 | 220631 | ETRIER A GRIFFE | 1K0 615 423 C , 1K0 615 423 H , 1K0 615 423 F , 1K0 615 423 | |



| | | | | | | | | |
|---|---|---|---|---|-------------|----------------------------------|---|--------------------------------|
|  |  |  |  |  | description | Références OE par référence ATE. |  | Références remplacées / divers |
|---|---|---|---|---|-------------|----------------------------------|---|--------------------------------|

SKODA

| | | | | | | | | | |
|------------------------|-----------------|-----|---------|---------|----------------|--------|-----------------|---|----------------|
| OCTAVIA II (1Z) (04-) | 2,0 TDI | ArD | 06.2004 | | 24.3414-1710.7 | 220632 | ETRIER A GRIFFE | 1K0 615 424 C , 1K0 615 424 H , 1K0 615 424 F , 1K0 615 424 | |
| | RS 2,0 TFSI | | 10.2005 | | 24.0325-0158.1 | 525158 | POWER-DISC | 1K0 615 301 AA | |
| SUPERB I (3U4) (02-08) | 1,8 i 20V Turbo | | 12.2001 | 02.2008 | 83.7812-0180.3 | 330854 | FLEXIBLE FREIN | 8D0 611 775 E , 4E0 611 775 F , 8E0 611 775 | 83.6212-0180.3 |
| | 1,9 TDI | | 10.2005 | 12.2007 | 83.7812-0180.3 | 330854 | FLEXIBLE FREIN | 8D0 611 775 E , 4E0 611 775 F , 8E0 611 775 | 83.6212-0180.3 |
| | | | 08.2002 | 12.2007 | 83.7812-0180.3 | 330854 | FLEXIBLE FREIN | 8D0 611 775 E , 4E0 611 775 F , 8E0 611 775 | 83.6212-0180.3 |
| | | | 01.2007 | 12.2007 | 83.7812-0180.3 | 330854 | FLEXIBLE FREIN | 8D0 611 775 E , 4E0 611 775 F , 8E0 611 775 | 83.6212-0180.3 |
| | | | 12.2001 | 12.2007 | 83.7812-0180.3 | 330854 | FLEXIBLE FREIN | 8D0 611 775 E , 4E0 611 775 F , 8E0 611 775 | 83.6212-0180.3 |
| | 2,0 i | | 12.2001 | 02.2008 | 83.7812-0180.3 | 330854 | FLEXIBLE FREIN | 8D0 611 775 E , 4E0 611 775 F , 8E0 611 775 | 83.6212-0180.3 |
| | 2,0 TDI | | 10.2005 | 12.2007 | 83.7812-0180.3 | 330854 | FLEXIBLE FREIN | 8D0 611 775 E , 4E0 611 775 F , 8E0 611 775 | 83.6212-0180.3 |
| | | | | 12.2007 | 24.0325-0158.1 | 525158 | POWER-DISC | 1K0 615 301 AA | |
| | 2,5 TDI | | 06.2003 | 12.2007 | 83.7812-0180.3 | 330854 | FLEXIBLE FREIN | 8D0 611 775 E , 4E0 611 775 F , 8E0 611 775 | 83.6212-0180.3 |
| | | | 12.2001 | 12.2007 | 83.7812-0180.3 | 330854 | FLEXIBLE FREIN | 8D0 611 775 E , 4E0 611 775 F , 8E0 611 775 | 83.6212-0180.3 |
| | | | | 12.2007 | 24.0325-0158.1 | 525158 | POWER-DISC | 1K0 615 301 AA | |
| | 2,8 i V6 | | 12.2001 | 12.2007 | 83.7812-0180.3 | 330854 | FLEXIBLE FREIN | 8D0 611 775 E , 4E0 611 775 F , 8E0 611 775 | 83.6212-0180.3 |



| | | | | | | | | |
|--|--|--|--|--|-------------|----------------------------------|--|--------------------------------|
| | | | | | description | Références OE par référence ATE. | | Références remplacées / divers |
|--|--|--|--|--|-------------|----------------------------------|--|--------------------------------|

SKODA

| | | | | | | | | | |
|------------------------|----------|--|--|---------|----------------|--------|------------|----------------|--|
| SUPERB I (3U4) (02-08) | 2,8 i V6 | | | 12.2007 | 24.0325-0158.1 | 525158 | POWER-DISC | 1K0 615 301 AA | |
|------------------------|----------|--|--|---------|----------------|--------|------------|----------------|--|

TOYOTA

| | | | | | | | | | |
|------------------------|---------------|-----|---------|---------|----------------|--------|-----------------|---------------------------|--|
| CARINA E (92-97) | 1,6 i (AT190) | AvD | 02.1992 | 09.1997 | 24.3571-1714.5 | 240202 | ETRIER A GRIFFE | 47730-20480 | |
| | | AvG | 02.1992 | 09.1997 | 24.3571-1713.5 | 240201 | ETRIER A GRIFFE | 47750-20480 | |
| | 1,8 i (AT191) | AvD | 02.1992 | 09.1997 | 24.3571-1714.5 | 240202 | ETRIER A GRIFFE | 47730-20480 | |
| | | AvG | 02.1992 | 09.1997 | 24.3571-1713.5 | 240201 | ETRIER A GRIFFE | 47750-20480 | |
| | 2,0 D (CT190) | AvD | 02.1992 | 09.1997 | 24.3571-1714.5 | 240202 | ETRIER A GRIFFE | 47730-20480 | |
| | | AvG | 02.1992 | 09.1997 | 24.3571-1713.5 | 240201 | ETRIER A GRIFFE | 47750-20480 | |
| CELICA (93-99) | 1,8 i (AT200) | AvG | 11.1993 | 11.1999 | 24.3571-1713.5 | 240201 | ETRIER A GRIFFE | 47750-20480 | |
| | | AvD | 11.1993 | 11.1999 | 24.3571-1714.5 | 240202 | ETRIER A GRIFFE | 47730-20480 | |
| LAND CRUISER 120 (03-) | 3,0 D-4D | | 01.2005 | | 24.0128-0194.1 | 428194 | DISQUE DE FREIN | 43512-60150 , 43512-60151 | |
| | | | 01.2003 | | 24.0128-0194.1 | 428194 | DISQUE DE FREIN | 43512-60150 , 43512-60151 | |
| | 4,0 VVTi | | 01.2003 | | 24.0128-0194.1 | 428194 | DISQUE DE FREIN | 43512-60150 , 43512-60151 | |
| YARIS (06-) | 1,0 VVT-i | | 01.2006 | | 24.0122-0246.1 | 422246 | DISQUE DE FREIN | 43512-52120 | |
| | 1,3 VVT-i | | 01.2006 | | 24.0122-0246.1 | 422246 | DISQUE DE FREIN | 43512-52120 | |
| | 1,4 D-4D | | 01.2006 | | 24.0122-0246.1 | 422246 | DISQUE DE FREIN | 43512-52120 | |

Nouvelles références disponibles - par applications

09/2008



| | | | | | | | | |
|--|--|--|--|--|-------------|----------------------------------|--|--------------------------------|
| | | | | | description | Références OE par référence ATE. | | Références remplacées / divers |
|--|--|--|--|--|-------------|----------------------------------|--|--------------------------------|

VOLKSWAGEN

| | | | | | | | | | |
|-----------------|--------------|-----|---------|--|----------------|--------|-----------------|---|--|
| CADDY III (04-) | 1,4 | | 02.2004 | | 24.0325-0158.1 | 525158 | POWER-DISC | 1K0 615 301 AA | |
| | 1,4 16V | | 05.2006 | | 24.0325-0158.1 | 525158 | POWER-DISC | 1K0 615 301 AA | |
| | 1,6 | | 04.2004 | | 24.0325-0158.1 | 525158 | POWER-DISC | 1K0 615 301 AA | |
| | 1,9 TDI | | 02.2004 | | 24.0325-0158.1 | 525158 | POWER-DISC | 1K0 615 301 AA | |
| | | | 09.2005 | | 24.0325-0158.1 | 525158 | POWER-DISC | 1K0 615 301 AA | |
| | 2,0 Eco Fuel | | 04.2006 | | 24.0325-0158.1 | 525158 | POWER-DISC | 1K0 615 301 AA | |
| | 2,0 SDI | | 02.2004 | | 24.0325-0158.1 | 525158 | POWER-DISC | 1K0 615 301 AA | |
| | 2,0 TDI | | 09.2007 | | 24.0325-0158.1 | 525158 | POWER-DISC | 1K0 615 301 AA | |
| CRAFTER (06-) | 2,5 TDI | | 04.2006 | | 24.0128-0203.1 | 428203 | DISQUE DE FREIN | 906 421 00 12 , 2E0 615 301 | |
| | | | 04.2006 | | 24.0128-0202.1 | 428202 | DISQUE DE FREIN | 906 423 01 12 , 2E0 615 601 | |
| EOS (06-) | 1,4 TSI | ArD | 10.2007 | | 24.3384-1756.7 | 220636 | ETRIER A GRIFFE | 1K0 615 424 D , 1K0 615 424 J , 1K0 615 424 A | |
| | | ArG | 10.2007 | | 24.3414-1709.7 | 220631 | ETRIER A GRIFFE | 1K0 615 423 C , 1K0 615 423 H , 1K0 615 423 F , 1K0 615 423 | |
| | | ArD | 10.2007 | | 24.3414-1710.7 | 220632 | ETRIER A GRIFFE | 1K0 615 424 C , 1K0 615 424 H , 1K0 615 424 F , 1K0 615 424 | |
| | | ArG | 10.2007 | | 24.3384-1755.7 | 220635 | ETRIER A GRIFFE | 1K0 615 423 D , 1K0 615 423 J , 1K0 615 423 A | |
| | | | 10.2007 | | 24.0325-0158.1 | 525158 | POWER-DISC | 1K0 615 301 AA | |
| | 1,6 FSI | ArG | 05.2006 | | 24.3384-1755.7 | 220635 | ETRIER A GRIFFE | 1K0 615 423 D , 1K0 615 423 J , 1K0 615 423 A | |

Nouvelles références disponibles - par applications

09/2008



| | | | | | | | | |
|--|--|--|--|--|-------------|----------------------------------|--|--------------------------------|
| | | | | | description | Références OE par référence ATE. | | Références remplacées / divers |
|--|--|--|--|--|-------------|----------------------------------|--|--------------------------------|

VOLKSWAGEN

| | | | | | | | | | |
|-----------|---------|-----|---------|--|----------------|--------|-----------------|---|--|
| EOS (06-) | 1,6 FSI | ArG | 05.2006 | | 24.3414-1709.7 | 220631 | ETRIER A GRIFFE | 1K0 615 423 C , 1K0 615 423 H , 1K0 615 423 F , 1K0 615 423 | |
| | | ArD | 05.2006 | | 24.3384-1756.7 | 220636 | ETRIER A GRIFFE | 1K0 615 424 D , 1K0 615 424 J , 1K0 615 424 A | |
| | | ArD | 05.2006 | | 24.3414-1710.7 | 220632 | ETRIER A GRIFFE | 1K0 615 424 C , 1K0 615 424 H , 1K0 615 424 F , 1K0 615 424 | |
| | | | 05.2006 | | 24.0325-0158.1 | 525158 | POWER-DISC | 1K0 615 301 AA | |
| | 2,0 FSI | ArD | 05.2006 | | 24.3414-1710.7 | 220632 | ETRIER A GRIFFE | 1K0 615 424 C , 1K0 615 424 H , 1K0 615 424 F , 1K0 615 424 | |
| | | ArD | 05.2006 | | 24.3384-1756.7 | 220636 | ETRIER A GRIFFE | 1K0 615 424 D , 1K0 615 424 J , 1K0 615 424 A | |
| | | ArG | 05.2006 | | 24.3384-1755.7 | 220635 | ETRIER A GRIFFE | 1K0 615 423 D , 1K0 615 423 J , 1K0 615 423 A | |
| | | ArG | 05.2006 | | 24.3414-1709.7 | 220631 | ETRIER A GRIFFE | 1K0 615 423 C , 1K0 615 423 H , 1K0 615 423 F , 1K0 615 423 | |
| | | | 05.2006 | | 24.0325-0158.1 | 525158 | POWER-DISC | 1K0 615 301 AA | |
| | 2,0 TDI | ArD | 05.2006 | | 24.3384-1756.7 | 220636 | ETRIER A GRIFFE | 1K0 615 424 D , 1K0 615 424 J , 1K0 615 424 A | |
| | | ArG | 05.2006 | | 24.3384-1755.7 | 220635 | ETRIER A GRIFFE | 1K0 615 423 D , 1K0 615 423 J , 1K0 615 423 A | |
| | | ArG | 05.2006 | | 24.3414-1709.7 | 220631 | ETRIER A GRIFFE | 1K0 615 423 C , 1K0 615 423 H , 1K0 615 423 F , 1K0 615 423 | |



| | | | | | | | | |
|--|--|--|--|--|-------------|----------------------------------|--|--------------------------------|
| | | | | | description | Références OE par référence ATE. | | Références remplacées / divers |
|--|--|--|--|--|-------------|----------------------------------|--|--------------------------------|

VOLKSWAGEN

| | | | | | | | | | |
|-----------|----------|-----|---------|--|----------------|--------|-----------------|---|--|
| EOS (06-) | 2,0 TDI | ArD | 05.2006 | | 24.3414-1710.7 | 220632 | ETRIER A GRIFFE | 1K0 615 424 C , 1K0 615 424 H , 1K0 615 424 F , 1K0 615 424 | |
| | | | 05.2006 | | 24.0325-0158.1 | 525158 | POWER-DISC | 1K0 615 301 AA | |
| | 2,0 TFSI | ArD | 05.2006 | | 24.3384-1756.7 | 220636 | ETRIER A GRIFFE | 1K0 615 424 D , 1K0 615 424 J , 1K0 615 424 A | |
| | | ArG | 05.2006 | | 24.3384-1755.7 | 220635 | ETRIER A GRIFFE | 1K0 615 423 D , 1K0 615 423 J , 1K0 615 423 A | |
| | | ArG | 05.2006 | | 24.3414-1709.7 | 220631 | ETRIER A GRIFFE | 1K0 615 423 C , 1K0 615 423 H , 1K0 615 423 F , 1K0 615 423 | |
| | | ArD | 05.2006 | | 24.3414-1710.7 | 220632 | ETRIER A GRIFFE | 1K0 615 424 C , 1K0 615 424 H , 1K0 615 424 F , 1K0 615 424 | |
| | | | 05.2006 | | 24.0325-0158.1 | 525158 | POWER-DISC | 1K0 615 301 AA | |
| | 3,2 V6 | ArD | 05.2006 | | 24.3384-1756.7 | 220636 | ETRIER A GRIFFE | 1K0 615 424 D , 1K0 615 424 J , 1K0 615 424 A | |
| | | ArG | 05.2006 | | 24.3414-1709.7 | 220631 | ETRIER A GRIFFE | 1K0 615 423 C , 1K0 615 423 H , 1K0 615 423 F , 1K0 615 423 | |
| | | ArG | 05.2006 | | 24.3384-1755.7 | 220635 | ETRIER A GRIFFE | 1K0 615 423 D , 1K0 615 423 J , 1K0 615 423 A | |
| | | ArD | 05.2006 | | 24.3414-1710.7 | 220632 | ETRIER A GRIFFE | 1K0 615 424 C , 1K0 615 424 H , 1K0 615 424 F , 1K0 615 424 | |
| | | | 05.2006 | | 24.0325-0158.1 | 525158 | POWER-DISC | 1K0 615 301 AA | |



| | | | | | | | | |
|--|--|--|--|--|-------------|----------------------------------|--|--------------------------------|
| | | | | | description | Références OE par référence ATE. | | Références remplacées / divers |
|--|--|--|--|--|-------------|----------------------------------|--|--------------------------------|

VOLKSWAGEN

| | | | | | | | | | |
|--------------|---------|-----|---------|--|----------------|--------|-----------------|---|--|
| GOLF V (03-) | 1,4 16V | ArG | 10.2003 | | 24.3414-1709.7 | 220631 | ETRIER A GRIFFE | 1K0 615 423 C , 1K0 615 423 H , 1K0 615 423 F , 1K0 615 423 | |
| | | ArD | 10.2003 | | 24.3384-1756.7 | 220636 | ETRIER A GRIFFE | 1K0 615 424 D , 1K0 615 424 J , 1K0 615 424 A | |
| | | ArD | 10.2003 | | 24.3414-1710.7 | 220632 | ETRIER A GRIFFE | 1K0 615 424 C , 1K0 615 424 H , 1K0 615 424 F , 1K0 615 424 | |
| | | ArG | 10.2003 | | 24.3384-1755.7 | 220635 | ETRIER A GRIFFE | 1K0 615 423 D , 1K0 615 423 J , 1K0 615 423 A | |
| | | | 10.2003 | | 24.0325-0158.1 | 525158 | POWER-DISC | 1K0 615 301 AA | |
| | 1,4 FSI | ArG | 10.2003 | | 24.3414-1709.7 | 220631 | ETRIER A GRIFFE | 1K0 615 423 C , 1K0 615 423 H , 1K0 615 423 F , 1K0 615 423 | |
| | | ArG | 10.2003 | | 24.3384-1755.7 | 220635 | ETRIER A GRIFFE | 1K0 615 423 D , 1K0 615 423 J , 1K0 615 423 A | |
| | | ArD | 10.2003 | | 24.3414-1710.7 | 220632 | ETRIER A GRIFFE | 1K0 615 424 C , 1K0 615 424 H , 1K0 615 424 F , 1K0 615 424 | |
| | | ArD | 10.2003 | | 24.3384-1756.7 | 220636 | ETRIER A GRIFFE | 1K0 615 424 D , 1K0 615 424 J , 1K0 615 424 A | |
| | | | 10.2003 | | 24.0325-0158.1 | 525158 | POWER-DISC | 1K0 615 301 AA | |
| | 1,4 TSI | ArD | 05.2007 | | 24.3414-1710.7 | 220632 | ETRIER A GRIFFE | 1K0 615 424 C , 1K0 615 424 H , 1K0 615 424 F , 1K0 615 424 | |
| | | ArD | 05.2006 | | 24.3414-1710.7 | 220632 | ETRIER A GRIFFE | 1K0 615 424 C , 1K0 615 424 H , 1K0 615 424 F , 1K0 615 424 | |



| | | | | | | | | |
|--|--|--|--|--|-------------|----------------------------------|--|--------------------------------|
| | | | | | description | Références OE par référence ATE. | | Références remplacées / divers |
|--|--|--|--|--|-------------|----------------------------------|--|--------------------------------|

VOLKSWAGEN

| | | | | | | | | | |
|--------------|---------|-----|---------|--|----------------|--------|-----------------|---|--|
| GOLF V (03-) | 1,4 TSI | ArG | 05.2006 | | 24.3414-1709.7 | 220631 | ETRIER A GRIFFE | 1K0 615 423 C , 1K0 615 423 H , 1K0 615 423 F , 1K0 615 423 | |
| | | ArG | 05.2007 | | 24.3414-1709.7 | 220631 | ETRIER A GRIFFE | 1K0 615 423 C , 1K0 615 423 H , 1K0 615 423 F , 1K0 615 423 | |
| | | ArG | 11.2005 | | 24.3414-1709.7 | 220631 | ETRIER A GRIFFE | 1K0 615 423 C , 1K0 615 423 H , 1K0 615 423 F , 1K0 615 423 | |
| | | ArG | 11.2005 | | 24.3384-1755.7 | 220635 | ETRIER A GRIFFE | 1K0 615 423 D , 1K0 615 423 J , 1K0 615 423 A | |
| | | ArD | 05.2007 | | 24.3384-1756.7 | 220636 | ETRIER A GRIFFE | 1K0 615 424 D , 1K0 615 424 J , 1K0 615 424 A | |
| | | ArD | 11.2005 | | 24.3414-1710.7 | 220632 | ETRIER A GRIFFE | 1K0 615 424 C , 1K0 615 424 H , 1K0 615 424 F , 1K0 615 424 | |
| | | ArD | 05.2006 | | 24.3384-1756.7 | 220636 | ETRIER A GRIFFE | 1K0 615 424 D , 1K0 615 424 J , 1K0 615 424 A | |
| | | ArG | 05.2006 | | 24.3384-1755.7 | 220635 | ETRIER A GRIFFE | 1K0 615 423 D , 1K0 615 423 J , 1K0 615 423 A | |
| | | ArD | 11.2005 | | 24.3384-1756.7 | 220636 | ETRIER A GRIFFE | 1K0 615 424 D , 1K0 615 424 J , 1K0 615 424 A | |
| | | ArG | 05.2007 | | 24.3384-1755.7 | 220635 | ETRIER A GRIFFE | 1K0 615 423 D , 1K0 615 423 J , 1K0 615 423 A | |
| | | | 05.2007 | | 24.0325-0158.1 | 525158 | POWER-DISC | 1K0 615 301 AA | |
| | | | 11.2005 | | 24.0325-0158.1 | 525158 | POWER-DISC | 1K0 615 301 AA | |
| | | | 05.2006 | | 24.0325-0158.1 | 525158 | POWER-DISC | 1K0 615 301 AA | |

Nouvelles références disponibles - par applications

09/2008



| | | | | | | | | |
|--|--|--|--|--|-------------|----------------------------------|--|--------------------------------|
| | | | | | description | Références OE par référence ATE. | | Références remplacées / divers |
|--|--|--|--|--|-------------|----------------------------------|--|--------------------------------|

VOLKSWAGEN

| | | | | | | | | | |
|--------------|---------|-----|---------|--|----------------|--------|-----------------|---|--|
| GOLF V (03-) | 1,6 16V | ArG | 01.2004 | | 24.3384-1755.7 | 220635 | ETRIER A GRIFFE | 1K0 615 423 D , 1K0 615 423 J , 1K0 615 423 A | |
| | | ArG | 01.2004 | | 24.3414-1709.7 | 220631 | ETRIER A GRIFFE | 1K0 615 423 C , 1K0 615 423 H , 1K0 615 423 F , 1K0 615 423 | |
| | | ArD | 01.2004 | | 24.3384-1756.7 | 220636 | ETRIER A GRIFFE | 1K0 615 424 D , 1K0 615 424 J , 1K0 615 424 A | |
| | | ArD | 01.2004 | | 24.3414-1710.7 | 220632 | ETRIER A GRIFFE | 1K0 615 424 C , 1K0 615 424 H , 1K0 615 424 F , 1K0 615 424 | |
| | | | 01.2004 | | 24.0325-0158.1 | 525158 | POWER-DISC | 1K0 615 301 AA | |
| | 1,6 FSI | ArG | 10.2003 | | 24.3384-1755.7 | 220635 | ETRIER A GRIFFE | 1K0 615 423 D , 1K0 615 423 J , 1K0 615 423 A | |
| | | ArD | 10.2003 | | 24.3384-1756.7 | 220636 | ETRIER A GRIFFE | 1K0 615 424 D , 1K0 615 424 J , 1K0 615 424 A | |
| | | ArD | 10.2003 | | 24.3414-1710.7 | 220632 | ETRIER A GRIFFE | 1K0 615 424 C , 1K0 615 424 H , 1K0 615 424 F , 1K0 615 424 | |
| | | ArG | 10.2003 | | 24.3414-1709.7 | 220631 | ETRIER A GRIFFE | 1K0 615 423 C , 1K0 615 423 H , 1K0 615 423 F , 1K0 615 423 | |
| | | | 10.2003 | | 24.0325-0158.1 | 525158 | POWER-DISC | 1K0 615 301 AA | |
| | 1,9 TDI | ArD | 05.2004 | | 24.3384-1756.7 | 220636 | ETRIER A GRIFFE | 1K0 615 424 D , 1K0 615 424 J , 1K0 615 424 A | |
| | | ArD | 10.2003 | | 24.3384-1756.7 | 220636 | ETRIER A GRIFFE | 1K0 615 424 D , 1K0 615 424 J , 1K0 615 424 A | |

Nouvelles références disponibles - par applications

09/2008



| | | | | | | | | |
|--|--|--|--|--|-------------|----------------------------------|--|--------------------------------|
| | | | | | description | Références OE par référence ATE. | | Références remplacées / divers |
|--|--|--|--|--|-------------|----------------------------------|--|--------------------------------|

VOLKSWAGEN

| | | | | | | | | | |
|--------------|-----------------|-----|---------|--|----------------|--------|-----------------|---|--|
| GOLF V (03-) | 1,9 TDI | ArG | 05.2004 | | 24.3414-1709.7 | 220631 | ETRIER A GRIFFE | 1K0 615 423 C , 1K0 615 423 H , 1K0 615 423 F , 1K0 615 423 | |
| | | ArG | 10.2003 | | 24.3414-1709.7 | 220631 | ETRIER A GRIFFE | 1K0 615 423 C , 1K0 615 423 H , 1K0 615 423 F , 1K0 615 423 | |
| | | ArG | 05.2004 | | 24.3384-1755.7 | 220635 | ETRIER A GRIFFE | 1K0 615 423 D , 1K0 615 423 J , 1K0 615 423 A | |
| | | ArD | 05.2004 | | 24.3414-1710.7 | 220632 | ETRIER A GRIFFE | 1K0 615 424 C , 1K0 615 424 H , 1K0 615 424 F , 1K0 615 424 | |
| | | ArD | 10.2003 | | 24.3414-1710.7 | 220632 | ETRIER A GRIFFE | 1K0 615 424 C , 1K0 615 424 H , 1K0 615 424 F , 1K0 615 424 | |
| | | ArG | 10.2003 | | 24.3384-1755.7 | 220635 | ETRIER A GRIFFE | 1K0 615 423 D , 1K0 615 423 J , 1K0 615 423 A | |
| | | | 05.2004 | | 24.0325-0158.1 | 525158 | POWER-DISC | 1K0 615 301 AA | |
| | | | 10.2003 | | 24.0325-0158.1 | 525158 | POWER-DISC | 1K0 615 301 AA | |
| | 1,9 TDI 4motion | ArD | 08.2004 | | 24.3414-1710.7 | 220632 | ETRIER A GRIFFE | 1K0 615 424 C , 1K0 615 424 H , 1K0 615 424 F , 1K0 615 424 | |
| | | ArG | 08.2004 | | 24.3414-1709.7 | 220631 | ETRIER A GRIFFE | 1K0 615 423 C , 1K0 615 423 H , 1K0 615 423 F , 1K0 615 423 | |
| | | | 08.2004 | | 24.0325-0158.1 | 525158 | POWER-DISC | 1K0 615 301 AA | |
| | 2,0 FSI | ArD | 10.2003 | | 24.3414-1710.7 | 220632 | ETRIER A GRIFFE | 1K0 615 424 C , 1K0 615 424 H , 1K0 615 424 F , 1K0 615 424 | |

Nouvelles références disponibles - par applications

09/2008



| | | | | | | | | |
|--|--|--|--|--|-------------|----------------------------------|--|--------------------------------|
| | | | | | description | Références OE par référence ATE. | | Références remplacées / divers |
|--|--|--|--|--|-------------|----------------------------------|--|--------------------------------|

VOLKSWAGEN

| GOLF V (03-) | 2,0 FSI | ArD | 10.2003 | | 24.3384-1756.7 | 220636 | ETRIER A GRIFFE | 1K0 615 424 D , 1K0 615 424 J , 1K0 615 424 A | |
|--------------|-----------------|-----|---------|--|----------------|--------|-----------------|---|--|
| | | ArG | 10.2003 | | 24.3384-1755.7 | 220635 | ETRIER A GRIFFE | 1K0 615 423 D , 1K0 615 423 J , 1K0 615 423 A | |
| | | ArG | 10.2003 | | 24.3414-1709.7 | 220631 | ETRIER A GRIFFE | 1K0 615 423 C , 1K0 615 423 H , 1K0 615 423 F , 1K0 615 423 | |
| | | | 10.2003 | | 24.0325-0158.1 | 525158 | POWER-DISC | 1K0 615 301 AA | |
| | 2,0 FSI 4motion | ArD | 08.2004 | | 24.3414-1710.7 | 220632 | ETRIER A GRIFFE | 1K0 615 424 C , 1K0 615 424 H , 1K0 615 424 F , 1K0 615 424 | |
| | | ArG | 08.2004 | | 24.3414-1709.7 | 220631 | ETRIER A GRIFFE | 1K0 615 423 C , 1K0 615 423 H , 1K0 615 423 F , 1K0 615 423 | |
| | | | 08.2004 | | 24.0325-0158.1 | 525158 | POWER-DISC | 1K0 615 301 AA | |
| | 2,0 GTI | ArG | 09.2006 | | 24.3384-1755.7 | 220635 | ETRIER A GRIFFE | 1K0 615 423 D , 1K0 615 423 J , 1K0 615 423 A | |
| | | ArD | 09.2004 | | 24.3384-1756.7 | 220636 | ETRIER A GRIFFE | 1K0 615 424 D , 1K0 615 424 J , 1K0 615 424 A | |
| | | ArD | 09.2004 | | 24.3414-1710.7 | 220632 | ETRIER A GRIFFE | 1K0 615 424 C , 1K0 615 424 H , 1K0 615 424 F , 1K0 615 424 | |
| | | ArD | 09.2006 | | 24.3384-1756.7 | 220636 | ETRIER A GRIFFE | 1K0 615 424 D , 1K0 615 424 J , 1K0 615 424 A | |
| | | ArG | 09.2006 | | 24.3414-1709.7 | 220631 | ETRIER A GRIFFE | 1K0 615 423 C , 1K0 615 423 H , 1K0 615 423 F , 1K0 615 423 | |



| | | | | | | | | |
|--|--|--|--|--|-------------|----------------------------------|--|--------------------------------|
| | | | | | description | Références OE par référence ATE. | | Références remplacées / divers |
|--|--|--|--|--|-------------|----------------------------------|--|--------------------------------|

VOLKSWAGEN

| | | | | | | | | | |
|--------------|---------|-----|---------|--|----------------|--------|-----------------|---|--|
| GOLF V (03-) | 2,0 GTI | ArG | 09.2004 | | 24.3384-1755.7 | 220635 | ETRIER A GRIFFE | 1K0 615 423 D , 1K0 615 423 J , 1K0 615 423 A | |
| | | ArG | 09.2004 | | 24.3414-1709.7 | 220631 | ETRIER A GRIFFE | 1K0 615 423 C , 1K0 615 423 H , 1K0 615 423 F , 1K0 615 423 | |
| | | ArD | 09.2006 | | 24.3414-1710.7 | 220632 | ETRIER A GRIFFE | 1K0 615 424 C , 1K0 615 424 H , 1K0 615 424 F , 1K0 615 424 | |
| | | | 09.2006 | | 24.0325-0158.1 | 525158 | POWER-DISC | 1K0 615 301 AA | |
| | | | 09.2004 | | 24.0325-0158.1 | 525158 | POWER-DISC | 1K0 615 301 AA | |
| | 2,0 SDI | ArG | 01.2004 | | 24.3384-1755.7 | 220635 | ETRIER A GRIFFE | 1K0 615 423 D , 1K0 615 423 J , 1K0 615 423 A | |
| | | ArG | 01.2004 | | 24.3414-1709.7 | 220631 | ETRIER A GRIFFE | 1K0 615 423 C , 1K0 615 423 H , 1K0 615 423 F , 1K0 615 423 | |
| | | ArD | 01.2004 | | 24.3384-1756.7 | 220636 | ETRIER A GRIFFE | 1K0 615 424 D , 1K0 615 424 J , 1K0 615 424 A | |
| | | ArD | 01.2004 | | 24.3414-1710.7 | 220632 | ETRIER A GRIFFE | 1K0 615 424 C , 1K0 615 424 H , 1K0 615 424 F , 1K0 615 424 | |
| | | | 01.2004 | | 24.0325-0158.1 | 525158 | POWER-DISC | 1K0 615 301 AA | |
| | 2,0 TDI | ArG | 11.2005 | | 24.3414-1709.7 | 220631 | ETRIER A GRIFFE | 1K0 615 423 C , 1K0 615 423 H , 1K0 615 423 F , 1K0 615 423 | |
| | | ArD | 10.2003 | | 24.3384-1756.7 | 220636 | ETRIER A GRIFFE | 1K0 615 424 D , 1K0 615 424 J , 1K0 615 424 A | |
| | | ArD | 11.2005 | | 24.3384-1756.7 | 220636 | ETRIER A GRIFFE | 1K0 615 424 D , 1K0 615 424 J , 1K0 615 424 A | |



| | | | | | | | | |
|--|--|--|--|--|-------------|----------------------------------|--|--------------------------------|
| | | | | | description | Références OE par référence ATE. | | Références remplacées / divers |
|--|--|--|--|--|-------------|----------------------------------|--|--------------------------------|

VOLKSWAGEN

| | | | | | | | | | |
|--------------|-----------------|-----|---------|--|----------------|--------|-----------------|---|--|
| GOLF V (03-) | 2,0 TDI | ArG | 10.2003 | | 24.3384-1755.7 | 220635 | ETRIER A GRIFFE | 1K0 615 423 D , 1K0 615 423 J , 1K0 615 423 A | |
| | | ArD | 10.2003 | | 24.3414-1710.7 | 220632 | ETRIER A GRIFFE | 1K0 615 424 C , 1K0 615 424 H , 1K0 615 424 F , 1K0 615 424 | |
| | | ArG | 10.2003 | | 24.3414-1709.7 | 220631 | ETRIER A GRIFFE | 1K0 615 423 C , 1K0 615 423 H , 1K0 615 423 F , 1K0 615 423 | |
| | | ArG | 11.2005 | | 24.3384-1755.7 | 220635 | ETRIER A GRIFFE | 1K0 615 423 D , 1K0 615 423 J , 1K0 615 423 A | |
| | | ArD | 11.2005 | | 24.3414-1710.7 | 220632 | ETRIER A GRIFFE | 1K0 615 424 C , 1K0 615 424 H , 1K0 615 424 F , 1K0 615 424 | |
| | | | 11.2005 | | 24.0325-0158.1 | 525158 | POWER-DISC | 1K0 615 301 AA | |
| | | | 10.2003 | | 24.0325-0158.1 | 525158 | POWER-DISC | 1K0 615 301 AA | |
| | 2,0 TDI 4motion | ArD | 08.2004 | | 24.3414-1710.7 | 220632 | ETRIER A GRIFFE | 1K0 615 424 C , 1K0 615 424 H , 1K0 615 424 F , 1K0 615 424 | |
| | | ArG | 08.2004 | | 24.3414-1709.7 | 220631 | ETRIER A GRIFFE | 1K0 615 423 C , 1K0 615 423 H , 1K0 615 423 F , 1K0 615 423 | |
| | | | 08.2004 | | 24.0325-0158.1 | 525158 | POWER-DISC | 1K0 615 301 AA | |
| | 3,2 R32 | ArD | 11.2005 | | 24.3414-1710.7 | 220632 | ETRIER A GRIFFE | 1K0 615 424 C , 1K0 615 424 H , 1K0 615 424 F , 1K0 615 424 | |
| | | ArG | 11.2005 | | 24.3414-1709.7 | 220631 | ETRIER A GRIFFE | 1K0 615 423 C , 1K0 615 423 H , 1K0 615 423 F , 1K0 615 423 | |

Nouvelles références disponibles - par applications

09/2008



| | | | | | | | | |
|--|--|--|--|--|-------------|----------------------------------|--|--------------------------------|
| | | | | | description | Références OE par référence ATE. | | Références remplacées / divers |
|--|--|--|--|--|-------------|----------------------------------|--|--------------------------------|

VOLKSWAGEN

| | | | | | | | | | |
|-------------------|---------|-----|---------|--|----------------|--------|-----------------|---|--|
| GOLF V (03-) | 3,2 R32 | | 11.2005 | | 24.0325-0158.1 | 525158 | POWER-DISC | 1K0 615 301 AA | |
| GOLF V Plus (05-) | 1,4 16V | ArG | 01.2005 | | 24.3384-1755.7 | 220635 | ETRIER A GRIFFE | 1K0 615 423 D , 1K0 615 423 J , 1K0 615 423 A | |
| | | ArD | 01.2005 | | 24.3384-1756.7 | 220636 | ETRIER A GRIFFE | 1K0 615 424 D , 1K0 615 424 J , 1K0 615 424 A | |
| | | ArG | 01.2005 | | 24.3414-1709.7 | 220631 | ETRIER A GRIFFE | 1K0 615 423 C , 1K0 615 423 H , 1K0 615 423 F , 1K0 615 423 | |
| | | ArD | 01.2005 | | 24.3414-1710.7 | 220632 | ETRIER A GRIFFE | 1K0 615 424 C , 1K0 615 424 H , 1K0 615 424 F , 1K0 615 424 | |
| | | | 01.2005 | | 24.0325-0158.1 | 525158 | POWER-DISC | 1K0 615 301 AA | |
| | 1,4 TSI | ArG | 06.2007 | | 24.3414-1709.7 | 220631 | ETRIER A GRIFFE | 1K0 615 423 C , 1K0 615 423 H , 1K0 615 423 F , 1K0 615 423 | |
| | | ArG | 06.2008 | | 24.3414-1709.7 | 220631 | ETRIER A GRIFFE | 1K0 615 423 C , 1K0 615 423 H , 1K0 615 423 F , 1K0 615 423 | |
| | | ArG | 05.2006 | | 24.3414-1709.7 | 220631 | ETRIER A GRIFFE | 1K0 615 423 C , 1K0 615 423 H , 1K0 615 423 F , 1K0 615 423 | |
| | | ArG | 06.2008 | | 24.3384-1755.7 | 220635 | ETRIER A GRIFFE | 1K0 615 423 D , 1K0 615 423 J , 1K0 615 423 A | |
| | | ArG | 05.2006 | | 24.3384-1755.7 | 220635 | ETRIER A GRIFFE | 1K0 615 423 D , 1K0 615 423 J , 1K0 615 423 A | |
| | | ArD | 05.2006 | | 24.3414-1710.7 | 220632 | ETRIER A GRIFFE | 1K0 615 424 C , 1K0 615 424 H , 1K0 615 424 F , 1K0 615 424 | |

Nouvelles références disponibles - par applications

09/2008



| | | | | | | | | |
|--|--|--|--|--|-------------|----------------------------------|--|--------------------------------|
| | | | | | description | Références OE par référence ATE. | | Références remplacées / divers |
|--|--|--|--|--|-------------|----------------------------------|--|--------------------------------|

VOLKSWAGEN

| | | | | | | | | | |
|-------------------|---------|-----|---------|--|----------------|--------|-----------------|---|--|
| GOLF V Plus (05-) | 1,4 TSI | ArD | 06.2007 | | 24.3414-1710.7 | 220632 | ETRIER A GRIFFE | 1K0 615 424 C , 1K0 615 424 H , 1K0 615 424 F , 1K0 615 424 | |
| | | ArD | 06.2008 | | 24.3414-1710.7 | 220632 | ETRIER A GRIFFE | 1K0 615 424 C , 1K0 615 424 H , 1K0 615 424 F , 1K0 615 424 | |
| | | ArD | 05.2006 | | 24.3384-1756.7 | 220636 | ETRIER A GRIFFE | 1K0 615 424 D , 1K0 615 424 J , 1K0 615 424 A | |
| | | ArD | 06.2007 | | 24.3384-1756.7 | 220636 | ETRIER A GRIFFE | 1K0 615 424 D , 1K0 615 424 J , 1K0 615 424 A | |
| | | ArD | 06.2008 | | 24.3384-1756.7 | 220636 | ETRIER A GRIFFE | 1K0 615 424 D , 1K0 615 424 J , 1K0 615 424 A | |
| | | ArG | 06.2007 | | 24.3384-1755.7 | 220635 | ETRIER A GRIFFE | 1K0 615 423 D , 1K0 615 423 J , 1K0 615 423 A | |
| | | | 06.2008 | | 24.0325-0158.1 | 525158 | POWER-DISC | 1K0 615 301 AA | |
| | | | 05.2006 | | 24.0325-0158.1 | 525158 | POWER-DISC | 1K0 615 301 AA | |
| | | | 06.2007 | | 24.0325-0158.1 | 525158 | POWER-DISC | 1K0 615 301 AA | |
| | 1,6 | ArD | 05.2005 | | 24.3384-1756.7 | 220636 | ETRIER A GRIFFE | 1K0 615 424 D , 1K0 615 424 J , 1K0 615 424 A | |
| | | ArG | 05.2005 | | 24.3384-1755.7 | 220635 | ETRIER A GRIFFE | 1K0 615 423 D , 1K0 615 423 J , 1K0 615 423 A | |
| | | ArD | 05.2005 | | 24.3414-1710.7 | 220632 | ETRIER A GRIFFE | 1K0 615 424 C , 1K0 615 424 H , 1K0 615 424 F , 1K0 615 424 | |
| | | ArG | 05.2005 | | 24.3414-1709.7 | 220631 | ETRIER A GRIFFE | 1K0 615 423 C , 1K0 615 423 H , 1K0 615 423 F , 1K0 615 423 | |









| | | | | | | | | |
|--|--|--|--|--|-------------|----------------------------------|--|--------------------------------|
| | | | | | description | Références OE par référence ATE. | | Références remplacées / divers |
|--|--|--|--|--|-------------|----------------------------------|--|--------------------------------|

VOLKSWAGEN

| | | | | | | | | | |
|-------------------|---------|-----|---------|--|----------------|--------|-----------------|---|--|
| GOLF V Plus (05-) | 1,6 | | 05.2005 | | 24.0325-0158.1 | 525158 | POWER-DISC | 1K0 615 301 AA | |
| | 1,6 FSI | ArD | 01.2005 | | 24.3414-1710.7 | 220632 | ETRIER A GRIFFE | 1K0 615 424 C , 1K0 615 424 H , 1K0 615 424 F , 1K0 615 424 | |
| | | ArG | 01.2005 | | 24.3414-1709.7 | 220631 | ETRIER A GRIFFE | 1K0 615 423 C , 1K0 615 423 H , 1K0 615 423 F , 1K0 615 423 | |
| | | ArD | 01.2005 | | 24.3384-1756.7 | 220636 | ETRIER A GRIFFE | 1K0 615 424 D , 1K0 615 424 J , 1K0 615 424 A | |
| | | ArG | 01.2005 | | 24.3384-1755.7 | 220635 | ETRIER A GRIFFE | 1K0 615 423 D , 1K0 615 423 J , 1K0 615 423 A | |
| | | | 01.2005 | | 24.0325-0158.1 | 525158 | POWER-DISC | 1K0 615 301 AA | |
| | 1,9 TDI | ArD | 01.2005 | | 24.3384-1756.7 | 220636 | ETRIER A GRIFFE | 1K0 615 424 D , 1K0 615 424 J , 1K0 615 424 A | |
| | | ArD | 05.2005 | | 24.3384-1756.7 | 220636 | ETRIER A GRIFFE | 1K0 615 424 D , 1K0 615 424 J , 1K0 615 424 A | |
| | | ArD | 05.2005 | | 24.3414-1710.7 | 220632 | ETRIER A GRIFFE | 1K0 615 424 C , 1K0 615 424 H , 1K0 615 424 F , 1K0 615 424 | |
| | | ArD | 01.2005 | | 24.3414-1710.7 | 220632 | ETRIER A GRIFFE | 1K0 615 424 C , 1K0 615 424 H , 1K0 615 424 F , 1K0 615 424 | |
| | | ArG | 05.2005 | | 24.3384-1755.7 | 220635 | ETRIER A GRIFFE | 1K0 615 423 D , 1K0 615 423 J , 1K0 615 423 A | |
| | | ArG | 01.2005 | | 24.3414-1709.7 | 220631 | ETRIER A GRIFFE | 1K0 615 423 C , 1K0 615 423 H , 1K0 615 423 F , 1K0 615 423 | |



| | | | | | | | |
|---|---|---|---|---|-------------|----------------------------------|--|
|  |  |  |  |  | description | Références OE par référence ATE. |  Références remplacées / divers |
|---|---|---|---|---|-------------|----------------------------------|--|

VOLKSWAGEN

| GOLF V Plus (05-) | 1,9 TDI | ArG | 05.2005 | | 24.3414-1709.7 | 220631 | ETRIER A GRIFFE | 1K0 615 423 C , 1K0 615 423 H , 1K0 615 423 F , 1K0 615 423 | |
|-------------------|---------|-----|---------|--|----------------|--------|-----------------|---|--|
| | | ArG | 01.2005 | | 24.3384-1755.7 | 220635 | ETRIER A GRIFFE | 1K0 615 423 D , 1K0 615 423 J , 1K0 615 423 A | |
| | | | 05.2005 | | 24.0325-0158.1 | 525158 | POWER-DISC | 1K0 615 301 AA | |
| | | | 01.2005 | | 24.0325-0158.1 | 525158 | POWER-DISC | 1K0 615 301 AA | |
| | 2,0 FSI | ArG | 05.2005 | | 24.3384-1755.7 | 220635 | ETRIER A GRIFFE | 1K0 615 423 D , 1K0 615 423 J , 1K0 615 423 A | |
| | | ArG | 05.2005 | | 24.3414-1709.7 | 220631 | ETRIER A GRIFFE | 1K0 615 423 C , 1K0 615 423 H , 1K0 615 423 F , 1K0 615 423 | |
| | | ArD | 05.2005 | | 24.3384-1756.7 | 220636 | ETRIER A GRIFFE | 1K0 615 424 D , 1K0 615 424 J , 1K0 615 424 A | |
| | | ArD | 05.2005 | | 24.3414-1710.7 | 220632 | ETRIER A GRIFFE | 1K0 615 424 C , 1K0 615 424 H , 1K0 615 424 F , 1K0 615 424 | |
| | | | 05.2005 | | 24.0325-0158.1 | 525158 | POWER-DISC | 1K0 615 301 AA | |
| | 2,0 TDI | ArG | 01.2005 | | 24.3414-1709.7 | 220631 | ETRIER A GRIFFE | 1K0 615 423 C , 1K0 615 423 H , 1K0 615 423 F , 1K0 615 423 | |
| | | ArD | 01.2005 | | 24.3414-1710.7 | 220632 | ETRIER A GRIFFE | 1K0 615 424 C , 1K0 615 424 H , 1K0 615 424 F , 1K0 615 424 | |
| | | ArD | 05.2005 | | 24.3414-1710.7 | 220632 | ETRIER A GRIFFE | 1K0 615 424 C , 1K0 615 424 H , 1K0 615 424 F , 1K0 615 424 | |



| | | | | | | | | |
|--|--|--|--|--|-------------|----------------------------------|--|--------------------------------|
| | | | | | description | Références OE par référence ATE. | | Références remplacées / divers |
|--|--|--|--|--|-------------|----------------------------------|--|--------------------------------|

VOLKSWAGEN

| | | | | | | | | | |
|----------------------|-----------------|-----|---------|--|----------------|--------|-----------------|---|--|
| GOLF V Plus (05-) | 2,0 TDI | ArG | 05.2005 | | 24.3384-1755.7 | 220635 | ETRIER A GRIFFE | 1K0 615 423 D , 1K0 615 423 J , 1K0 615 423 A | |
| | | ArG | 01.2005 | | 24.3384-1755.7 | 220635 | ETRIER A GRIFFE | 1K0 615 423 D , 1K0 615 423 J , 1K0 615 423 A | |
| | | ArD | 01.2005 | | 24.3384-1756.7 | 220636 | ETRIER A GRIFFE | 1K0 615 424 D , 1K0 615 424 J , 1K0 615 424 A | |
| | | ArD | 05.2005 | | 24.3384-1756.7 | 220636 | ETRIER A GRIFFE | 1K0 615 424 D , 1K0 615 424 J , 1K0 615 424 A | |
| | | ArG | 05.2005 | | 24.3414-1709.7 | 220631 | ETRIER A GRIFFE | 1K0 615 423 C , 1K0 615 423 H , 1K0 615 423 F , 1K0 615 423 | |
| | | | 01.2005 | | 24.0325-0158.1 | 525158 | POWER-DISC | 1K0 615 301 AA | |
| | | | 05.2005 | | 24.0325-0158.1 | 525158 | POWER-DISC | 1K0 615 301 AA | |
| GOLF V Variant (07-) | 1,4 | | 06.2007 | | 24.0325-0158.1 | 525158 | POWER-DISC | 1K0 615 301 AA | |
| | 1,4 TSI | | 07.2008 | | 24.0325-0158.1 | 525158 | POWER-DISC | 1K0 615 301 AA | |
| | | | 06.2007 | | 24.0325-0158.1 | 525158 | POWER-DISC | 1K0 615 301 AA | |
| | | | 05.2007 | | 24.0325-0158.1 | 525158 | POWER-DISC | 1K0 615 301 AA | |
| | 1,6 | | 05.2007 | | 24.0325-0158.1 | 525158 | POWER-DISC | 1K0 615 301 AA | |
| | 1,9 TDI | | 05.2007 | | 24.0325-0158.1 | 525158 | POWER-DISC | 1K0 615 301 AA | |
| | 1,9 TDI 4motion | | 12.2007 | | 24.0325-0158.1 | 525158 | POWER-DISC | 1K0 615 301 AA | |
| | 2 | | 06.2007 | | 24.0325-0158.1 | 525158 | POWER-DISC | 1K0 615 301 AA | |
| | 2,0 TDI | | 05.2007 | | 24.0325-0158.1 | 525158 | POWER-DISC | 1K0 615 301 AA | |



| | | | | | | | | |
|--|--|--|--|--|-------------|----------------------------------|--|--------------------------------|
| | | | | | description | Références OE par référence ATE. | | Références remplacées / divers |
|--|--|--|--|--|-------------|----------------------------------|--|--------------------------------|

VOLKSWAGEN

| | | | | | | | | | |
|-----------------|-----------|-----|---------|--|----------------|--------|-----------------|---|--|
| JETTA III (05-) | 1,4 TSI | ArG | 06.2006 | | 24.3414-1709.7 | 220631 | ETRIER A GRIFFE | 1K0 615 423 C , 1K0 615 423 H , 1K0 615 423 F , 1K0 615 423 | |
| | | ArD | 06.2006 | | 24.3414-1710.7 | 220632 | ETRIER A GRIFFE | 1K0 615 424 C , 1K0 615 424 H , 1K0 615 424 F , 1K0 615 424 | |
| | | ArG | 05.2007 | | 24.3414-1709.7 | 220631 | ETRIER A GRIFFE | 1K0 615 423 C , 1K0 615 423 H , 1K0 615 423 F , 1K0 615 423 | |
| | | ArD | 05.2007 | | 24.3414-1710.7 | 220632 | ETRIER A GRIFFE | 1K0 615 424 C , 1K0 615 424 H , 1K0 615 424 F , 1K0 615 424 | |
| | | | 06.2006 | | 24.0325-0158.1 | 525158 | POWER-DISC | 1K0 615 301 AA | |
| | | | 05.2007 | | 24.0325-0158.1 | 525158 | POWER-DISC | 1K0 615 301 AA | |
| | 1,6 FSI | ArD | 08.2005 | | 24.3414-1710.7 | 220632 | ETRIER A GRIFFE | 1K0 615 424 C , 1K0 615 424 H , 1K0 615 424 F , 1K0 615 424 | |
| | | ArG | 08.2005 | | 24.3414-1709.7 | 220631 | ETRIER A GRIFFE | 1K0 615 423 C , 1K0 615 423 H , 1K0 615 423 F , 1K0 615 423 | |
| | | | 08.2005 | | 24.0325-0158.1 | 525158 | POWER-DISC | 1K0 615 301 AA | |
| | 1,6 i 16V | ArD | 08.2005 | | 24.3414-1710.7 | 220632 | ETRIER A GRIFFE | 1K0 615 424 C , 1K0 615 424 H , 1K0 615 424 F , 1K0 615 424 | |
| | | ArG | 08.2005 | | 24.3414-1709.7 | 220631 | ETRIER A GRIFFE | 1K0 615 423 C , 1K0 615 423 H , 1K0 615 423 F , 1K0 615 423 | |
| | | | 08.2005 | | 24.0325-0158.1 | 525158 | POWER-DISC | 1K0 615 301 AA | |



| | | | | | | | | |
|--|--|--|--|--|-------------|----------------------------------|--|--------------------------------|
| | | | | | description | Références OE par référence ATE. | | Références remplacées / divers |
|--|--|--|--|--|-------------|----------------------------------|--|--------------------------------|

VOLKSWAGEN

| | | | | | | | | | |
|-----------------|---------|-----|---------|--|----------------|--------|-----------------|---|--|
| JETTA III (05-) | 1,9 TDI | ArD | 08.2005 | | 24.3414-1710.7 | 220632 | ETRIER A GRIFFE | 1K0 615 424 C , 1K0 615 424 H , 1K0 615 424 F , 1K0 615 424 | |
| | | ArG | 08.2005 | | 24.3414-1709.7 | 220631 | ETRIER A GRIFFE | 1K0 615 423 C , 1K0 615 423 H , 1K0 615 423 F , 1K0 615 423 | |
| | | | 08.2005 | | 24.0325-0158.1 | 525158 | POWER-DISC | 1K0 615 301 AA | |
| | 2,0 FSI | ArD | 08.2005 | | 24.3414-1710.7 | 220632 | ETRIER A GRIFFE | 1K0 615 424 C , 1K0 615 424 H , 1K0 615 424 F , 1K0 615 424 | |
| | | ArG | 08.2005 | | 24.3414-1709.7 | 220631 | ETRIER A GRIFFE | 1K0 615 423 C , 1K0 615 423 H , 1K0 615 423 F , 1K0 615 423 | |
| | | | 08.2005 | | 24.0325-0158.1 | 525158 | POWER-DISC | 1K0 615 301 AA | |
| | 2,0 TDI | ArG | 09.2005 | | 24.3414-1709.7 | 220631 | ETRIER A GRIFFE | 1K0 615 423 C , 1K0 615 423 H , 1K0 615 423 F , 1K0 615 423 | |
| | | ArG | 08.2005 | | 24.3414-1709.7 | 220631 | ETRIER A GRIFFE | 1K0 615 423 C , 1K0 615 423 H , 1K0 615 423 F , 1K0 615 423 | |
| | | ArG | 06.2006 | | 24.3414-1709.7 | 220631 | ETRIER A GRIFFE | 1K0 615 423 C , 1K0 615 423 H , 1K0 615 423 F , 1K0 615 423 | |
| | | ArD | 09.2005 | | 24.3414-1710.7 | 220632 | ETRIER A GRIFFE | 1K0 615 424 C , 1K0 615 424 H , 1K0 615 424 F , 1K0 615 424 | |
| | | ArD | 08.2005 | | 24.3414-1710.7 | 220632 | ETRIER A GRIFFE | 1K0 615 424 C , 1K0 615 424 H , 1K0 615 424 F , 1K0 615 424 | |



| | | | | | | | | |
|--|--|--|--|--|-------------|----------------------------------|--|--------------------------------|
| | | | | | description | Références OE par référence ATE. | | Références remplacées / divers |
|--|--|--|--|--|-------------|----------------------------------|--|--------------------------------|

VOLKSWAGEN

| | | | | | | | | | |
|-----------------|----------|-----|---------|---------|----------------|--------|-----------------|---|----------------|
| JETTA III (05-) | 2,0 TDI | ArD | 06.2006 | | 24.3414-1710.7 | 220632 | ETRIER A GRIFFE | 1K0 615 424 C , 1K0 615 424 H , 1K0 615 424 F , 1K0 615 424 | |
| | | | 06.2006 | | 24.0325-0158.1 | 525158 | POWER-DISC | 1K0 615 301 AA | |
| | | | 08.2005 | | 24.0325-0158.1 | 525158 | POWER-DISC | 1K0 615 301 AA | |
| | | | 09.2005 | | 24.0325-0158.1 | 525158 | POWER-DISC | 1K0 615 301 AA | |
| | 2,0 TFSI | ArG | 10.2005 | | 24.3414-1709.7 | 220631 | ETRIER A GRIFFE | 1K0 615 423 C , 1K0 615 423 H , 1K0 615 423 F , 1K0 615 423 | |
| | | ArD | 10.2005 | | 24.3414-1710.7 | 220632 | ETRIER A GRIFFE | 1K0 615 424 C , 1K0 615 424 H , 1K0 615 424 F , 1K0 615 424 | |
| | | | 10.2005 | | 24.0325-0158.1 | 525158 | POWER-DISC | 1K0 615 301 AA | |
| PASSAT (97-05) | 1,6 | | 10.1996 | 06.2005 | 83.7812-0180.3 | 330854 | FLEXIBLE FREIN | 8D0 611 775 E , 4E0 611 775 F , 8E0 611 775 | 83.6212-0180.3 |
| | 1,8 | | 01.1997 | 09.2000 | 83.7812-0180.3 | 330854 | FLEXIBLE FREIN | 8D0 611 775 E , 4E0 611 775 F , 8E0 611 775 | 83.6212-0180.3 |
| | | | 10.1996 | 09.2000 | 83.7812-0180.3 | 330854 | FLEXIBLE FREIN | 8D0 611 775 E , 4E0 611 775 F , 8E0 611 775 | 83.6212-0180.3 |
| | 1,8 T | | 10.1996 | 06.2005 | 83.7812-0180.3 | 330854 | FLEXIBLE FREIN | 8D0 611 775 E , 4E0 611 775 F , 8E0 611 775 | 83.6212-0180.3 |
| | 1,9 TDI | | 10.2000 | 06.2005 | 83.7812-0180.3 | 330854 | FLEXIBLE FREIN | 8D0 611 775 E , 4E0 611 775 F , 8E0 611 775 | 83.6212-0180.3 |
| | | | 10.1996 | 09.2000 | 83.7812-0180.3 | 330854 | FLEXIBLE FREIN | 8D0 611 775 E , 4E0 611 775 F , 8E0 611 775 | 83.6212-0180.3 |
| | | | 08.1998 | 06.2005 | 83.7812-0180.3 | 330854 | FLEXIBLE FREIN | 8D0 611 775 E , 4E0 611 775 F , 8E0 611 775 | 83.6212-0180.3 |



| | | | | | | | | |
|--|--|--|--|--|-------------|----------------------------------|--|--------------------------------|
| | | | | | description | Références OE par référence ATE. | | Références remplacées / divers |
|--|--|--|--|--|-------------|----------------------------------|--|--------------------------------|

VOLKSWAGEN

| | | | | | | | | | |
|----------------------|-----------------|--|---------|---------|----------------|--------|----------------|---|----------------|
| PASSAT (97-05) | 1,9 TDI | | 10.1996 | 06.2005 | 83.7812-0180.3 | 330854 | FLEXIBLE FREIN | 8D0 611 775 E , 4E0 611 775 F , 8E0 611 775 | 83.6212-0180.3 |
| | 2 | | 05.2002 | 06.2005 | 83.7812-0180.3 | 330854 | FLEXIBLE FREIN | 8D0 611 775 E , 4E0 611 775 F , 8E0 611 775 | 83.6212-0180.3 |
| | | | 10.2000 | 06.2005 | 83.7812-0180.3 | 330854 | FLEXIBLE FREIN | 8D0 611 775 E , 4E0 611 775 F , 8E0 611 775 | 83.6212-0180.3 |
| | 2,0 TDI | | 12.2003 | 06.2005 | 83.7812-0180.3 | 330854 | FLEXIBLE FREIN | 8D0 611 775 E , 4E0 611 775 F , 8E0 611 775 | 83.6212-0180.3 |
| | 2,3 | | 10.1996 | 06.2005 | 83.7812-0180.3 | 330854 | FLEXIBLE FREIN | 8D0 611 775 E , 4E0 611 775 F , 8E0 611 775 | 83.6212-0180.3 |
| | 2,5 TDI | | 08.1998 | 06.2005 | 83.7812-0180.3 | 330854 | FLEXIBLE FREIN | 8D0 611 775 E , 4E0 611 775 F , 8E0 611 775 | 83.6212-0180.3 |
| | 2,8 | | 08.1996 | 06.2005 | 83.7812-0180.3 | 330854 | FLEXIBLE FREIN | 8D0 611 775 E , 4E0 611 775 F , 8E0 611 775 | 83.6212-0180.3 |
| | | | 01.1997 | 06.2005 | 83.7812-0180.3 | 330854 | FLEXIBLE FREIN | 8D0 611 775 E , 4E0 611 775 F , 8E0 611 775 | 83.6212-0180.3 |
| PASSAT Berline (05-) | 1,4 TSI | | 10.2007 | | 24.0325-0158.1 | 525158 | POWER-DISC | 1K0 615 301 AA | |
| | 1,6 | | 03.2005 | | 24.0325-0158.1 | 525158 | POWER-DISC | 1K0 615 301 AA | |
| | 1,6 FSI | | 03.2005 | | 24.0325-0158.1 | 525158 | POWER-DISC | 1K0 615 301 AA | |
| | 1,8 TSI | | 10.2007 | | 24.0325-0158.1 | 525158 | POWER-DISC | 1K0 615 301 AA | |
| | 1,9 TDI | | 03.2005 | | 24.0325-0158.1 | 525158 | POWER-DISC | 1K0 615 301 AA | |
| | 2,0 FSI | | 03.2005 | | 24.0325-0158.1 | 525158 | POWER-DISC | 1K0 615 301 AA | |
| | 2,0 FSI 4motion | | 03.2005 | | 24.0325-0158.1 | 525158 | POWER-DISC | 1K0 615 301 AA | |
| | 2,0 TDI | | 08.2005 | | 24.0325-0158.1 | 525158 | POWER-DISC | 1K0 615 301 AA | |

Nouvelles références disponibles - par applications

09/2008



| | | | | | | | |
|--|--|--|--|-------------|----------------------------------|--|--------------------------------|
| | | | | description | Références OE par référence ATE. | | Références remplacées / divers |
|--|--|--|--|-------------|----------------------------------|--|--------------------------------|

VOLKSWAGEN

| | | | | | | | | | |
|----------------------|--------------------|--|---------|--|----------------|--------|------------|----------------|--|
| PASSAT Berline (05-) | 2,0 TDI | | 03.2005 | | 24.0325-0158.1 | 525158 | POWER-DISC | 1K0 615 301 AA | |
| | 2,0 TDI 4motion | | 03.2005 | | 24.0325-0158.1 | 525158 | POWER-DISC | 1K0 615 301 AA | |
| | 2,0 TFSI | | 03.2005 | | 24.0325-0158.1 | 525158 | POWER-DISC | 1K0 615 301 AA | |
| | 3,2 V6 FSI | | 11.2005 | | 24.0325-0158.1 | 525158 | POWER-DISC | 1K0 615 301 AA | |
| | 3,2 V6 FSI 4motion | | 09.2005 | | 24.0325-0158.1 | 525158 | POWER-DISC | 1K0 615 301 AA | |
| | 3,6 R36 | | 04.2007 | | 24.0325-0158.1 | 525158 | POWER-DISC | 1K0 615 301 AA | |
| PASSAT Variant (05-) | 1,4 TSI | | 10.2007 | | 24.0325-0158.1 | 525158 | POWER-DISC | 1K0 615 301 AA | |
| | 1,6 | | 07.2005 | | 24.0325-0158.1 | 525158 | POWER-DISC | 1K0 615 301 AA | |
| | 1,6 FSI | | 07.2005 | | 24.0325-0158.1 | 525158 | POWER-DISC | 1K0 615 301 AA | |
| | 1,8 TSI | | 10.2007 | | 24.0325-0158.1 | 525158 | POWER-DISC | 1K0 615 301 AA | |
| | 1,9 TDI | | 07.2005 | | 24.0325-0158.1 | 525158 | POWER-DISC | 1K0 615 301 AA | |
| | 2,0 FSI | | 07.2005 | | 24.0325-0158.1 | 525158 | POWER-DISC | 1K0 615 301 AA | |
| | 2,0 FSI 4motion | | 09.2005 | | 24.0325-0158.1 | 525158 | POWER-DISC | 1K0 615 301 AA | |
| | 2,0 TDI | | 07.2005 | | 24.0325-0158.1 | 525158 | POWER-DISC | 1K0 615 301 AA | |
| | 2,0 TDI 4motion | | 09.2005 | | 24.0325-0158.1 | 525158 | POWER-DISC | 1K0 615 301 AA | |
| | 2,0 TFSI | | 07.2005 | | 24.0325-0158.1 | 525158 | POWER-DISC | 1K0 615 301 AA | |
| | 3,2 V6 FSI | | 11.2005 | | 24.0325-0158.1 | 525158 | POWER-DISC | 1K0 615 301 AA | |
| | 3,2 V6 FSI 4motion | | 11.2005 | | 24.0325-0158.1 | 525158 | POWER-DISC | 1K0 615 301 AA | |
| | 3,6 R36 | | 04.2007 | | 24.0325-0158.1 | 525158 | POWER-DISC | 1K0 615 301 AA | |

Nouvelles références disponibles - par applications

09/2008



| | | | | | | | | |
|--|--|--|--|--|-------------|----------------------------------|--|--------------------------------|
| | | | | | description | Références OE par référence ATE. | | Références remplacées / divers |
|--|--|--|--|--|-------------|----------------------------------|--|--------------------------------|

VOLKSWAGEN

| | | | | | | | | | |
|----------------|---------|-----|---------|--|----------------|--------|-----------------|---|--|
| SCIROCCO (08-) | 1,4 TSI | ArD | 08.2008 | | 24.3384-1756.7 | 220636 | ETRIER A GRIFFE | 1K0 615 424 D , 1K0 615 424 J , 1K0 615 424 A | |
| | | ArG | 08.2008 | | 24.3384-1755.7 | 220635 | ETRIER A GRIFFE | 1K0 615 423 D , 1K0 615 423 J , 1K0 615 423 A | |
| | 2,0 TDI | ArD | 10.2008 | | 24.3384-1756.7 | 220636 | ETRIER A GRIFFE | 1K0 615 424 D , 1K0 615 424 J , 1K0 615 424 A | |
| | | ArG | 10.2008 | | 24.3384-1755.7 | 220635 | ETRIER A GRIFFE | 1K0 615 423 D , 1K0 615 423 J , 1K0 615 423 A | |
| | 2,0 TSI | ArG | 08.2008 | | 24.3384-1755.7 | 220635 | ETRIER A GRIFFE | 1K0 615 423 D , 1K0 615 423 J , 1K0 615 423 A | |
| | | ArD | 08.2008 | | 24.3384-1756.7 | 220636 | ETRIER A GRIFFE | 1K0 615 424 D , 1K0 615 424 J , 1K0 615 424 A | |
| TOURAN (03-) | 1,4 FSI | ArG | 01.2006 | | 24.3414-1709.7 | 220631 | ETRIER A GRIFFE | 1K0 615 423 C , 1K0 615 423 H , 1K0 615 423 F , 1K0 615 423 | |
| | | ArD | 01.2006 | | 24.3414-1710.7 | 220632 | ETRIER A GRIFFE | 1K0 615 424 C , 1K0 615 424 H , 1K0 615 424 F , 1K0 615 424 | |
| | | | 01.2006 | | 24.0325-0158.1 | 525158 | POWER-DISC | 1K0 615 301 AA | |
| | 1,4 TSI | ArG | 09.2006 | | 24.3414-1709.7 | 220631 | ETRIER A GRIFFE | 1K0 615 423 C , 1K0 615 423 H , 1K0 615 423 F , 1K0 615 423 | |
| | | ArD | 09.2006 | | 24.3414-1710.7 | 220632 | ETRIER A GRIFFE | 1K0 615 424 C , 1K0 615 424 H , 1K0 615 424 F , 1K0 615 424 | |
| | | ArG | 11.2006 | | 24.3414-1709.7 | 220631 | ETRIER A GRIFFE | 1K0 615 423 C , 1K0 615 423 H , 1K0 615 423 F , 1K0 615 423 | |



| | | | | | | | | |
|--|--|--|--|--|-------------|----------------------------------|--|--------------------------------|
| | | | | | description | Références OE par référence ATE. | | Références remplacées / divers |
|--|--|--|--|--|-------------|----------------------------------|--|--------------------------------|

VOLKSWAGEN

| | | | | | | | | | |
|--------------|---------|-----|---------|--|----------------|--------|-----------------|---|--|
| TOURAN (03-) | 1,4 TSI | ArD | 11.2006 | | 24.3414-1710.7 | 220632 | ETRIER A GRIFFE | 1K0 615 424 C , 1K0 615 424 H , 1K0 615 424 F , 1K0 615 424 | |
| | | | 09.2006 | | 24.0325-0158.1 | 525158 | POWER-DISC | 1K0 615 301 AA | |
| | | | 11.2006 | | 24.0325-0158.1 | 525158 | POWER-DISC | 1K0 615 301 AA | |
| | 1,6 | ArD | 07.2003 | | 24.3414-1710.7 | 220632 | ETRIER A GRIFFE | 1K0 615 424 C , 1K0 615 424 H , 1K0 615 424 F , 1K0 615 424 | |
| | | ArG | 07.2003 | | 24.3414-1709.7 | 220631 | ETRIER A GRIFFE | 1K0 615 423 C , 1K0 615 423 H , 1K0 615 423 F , 1K0 615 423 | |
| | | | 07.2003 | | 24.0325-0158.1 | 525158 | POWER-DISC | 1K0 615 301 AA | |
| | 1,6 FSI | ArD | 02.2003 | | 24.3414-1710.7 | 220632 | ETRIER A GRIFFE | 1K0 615 424 C , 1K0 615 424 H , 1K0 615 424 F , 1K0 615 424 | |
| | | ArG | 02.2003 | | 24.3414-1709.7 | 220631 | ETRIER A GRIFFE | 1K0 615 423 C , 1K0 615 423 H , 1K0 615 423 F , 1K0 615 423 | |
| | | | 02.2003 | | 24.0325-0158.1 | 525158 | POWER-DISC | 1K0 615 301 AA | |
| | 1,9 TDI | ArD | 08.2003 | | 24.3414-1710.7 | 220632 | ETRIER A GRIFFE | 1K0 615 424 C , 1K0 615 424 H , 1K0 615 424 F , 1K0 615 424 | |
| | | ArG | 02.2003 | | 24.3414-1709.7 | 220631 | ETRIER A GRIFFE | 1K0 615 423 C , 1K0 615 423 H , 1K0 615 423 F , 1K0 615 423 | |
| | | ArG | 08.2003 | | 24.3414-1709.7 | 220631 | ETRIER A GRIFFE | 1K0 615 423 C , 1K0 615 423 H , 1K0 615 423 F , 1K0 615 423 | |









| | | | | | | | | |
|--|--|--|--|--|-------------|----------------------------------|--|--------------------------------|
| | | | | | description | Références OE par référence ATE. | | Références remplacées / divers |
|--|--|--|--|--|-------------|----------------------------------|--|--------------------------------|

VOLKSWAGEN

| | | | | | | | | | |
|--------------|--------------|-----|---------|--|----------------|--------|-----------------|---|--|
| TOURAN (03-) | 1,9 TDI | ArG | 11.2004 | | 24.3414-1709.7 | 220631 | ETRIER A GRIFFE | 1K0 615 423 C , 1K0 615 423 H , 1K0 615 423 F , 1K0 615 423 | |
| | | ArD | 11.2004 | | 24.3414-1710.7 | 220632 | ETRIER A GRIFFE | 1K0 615 424 C , 1K0 615 424 H , 1K0 615 424 F , 1K0 615 424 | |
| | | ArD | 02.2003 | | 24.3414-1710.7 | 220632 | ETRIER A GRIFFE | 1K0 615 424 C , 1K0 615 424 H , 1K0 615 424 F , 1K0 615 424 | |
| | | | 02.2003 | | 24.0325-0158.1 | 525158 | POWER-DISC | 1K0 615 301 AA | |
| | | | 08.2003 | | 24.0325-0158.1 | 525158 | POWER-DISC | 1K0 615 301 AA | |
| | | | 11.2004 | | 24.0325-0158.1 | 525158 | POWER-DISC | 1K0 615 301 AA | |
| | 2,0 Eco Fuel | ArG | 02.2006 | | 24.3414-1709.7 | 220631 | ETRIER A GRIFFE | 1K0 615 423 C , 1K0 615 423 H , 1K0 615 423 F , 1K0 615 423 | |
| | | ArD | 02.2006 | | 24.3414-1710.7 | 220632 | ETRIER A GRIFFE | 1K0 615 424 C , 1K0 615 424 H , 1K0 615 424 F , 1K0 615 424 | |
| | | | 02.2006 | | 24.0325-0158.1 | 525158 | POWER-DISC | 1K0 615 301 AA | |
| | 2,0 FSI | ArD | 10.2003 | | 24.3414-1710.7 | 220632 | ETRIER A GRIFFE | 1K0 615 424 C , 1K0 615 424 H , 1K0 615 424 F , 1K0 615 424 | |
| | | ArG | 10.2003 | | 24.3414-1709.7 | 220631 | ETRIER A GRIFFE | 1K0 615 423 C , 1K0 615 423 H , 1K0 615 423 F , 1K0 615 423 | |
| | | | 10.2003 | | 24.0325-0158.1 | 525158 | POWER-DISC | 1K0 615 301 AA | |



| | | | | | | | | |
|---|---|---|---|---|-------------|----------------------------------|---|--------------------------------|
|  |  |  |  |  | description | Références OE par référence ATE. |  | Références remplacées / divers |
|---|---|---|---|---|-------------|----------------------------------|---|--------------------------------|

VOLKSWAGEN

| Modèle | Version | Code | Date | Code | Code | Description | Références OE par référence ATE. | Références remplacées / divers |
|--------------|---------|------|---------|------|----------------|-------------|----------------------------------|---|
| TOURAN (03-) | 2,0 TDI | ArG | 02.2003 | | 24.3414-1709.7 | 220631 | ETRIER A GRIFFE | 1K0 615 423 C , 1K0 615 423 H , 1K0 615 423 F , 1K0 615 423 |
| | | ArD | 02.2006 | | 24.3414-1710.7 | 220632 | ETRIER A GRIFFE | 1K0 615 424 C , 1K0 615 424 H , 1K0 615 424 F , 1K0 615 424 |
| | | ArD | 02.2003 | | 24.3414-1710.7 | 220632 | ETRIER A GRIFFE | 1K0 615 424 C , 1K0 615 424 H , 1K0 615 424 F , 1K0 615 424 |
| | | ArG | 02.2006 | | 24.3414-1709.7 | 220631 | ETRIER A GRIFFE | 1K0 615 423 C , 1K0 615 423 H , 1K0 615 423 F , 1K0 615 423 |
| | | ArG | 08.2003 | | 24.3414-1709.7 | 220631 | ETRIER A GRIFFE | 1K0 615 423 C , 1K0 615 423 H , 1K0 615 423 F , 1K0 615 423 |
| | | ArD | 08.2003 | | 24.3414-1710.7 | 220632 | ETRIER A GRIFFE | 1K0 615 424 C , 1K0 615 424 H , 1K0 615 424 F , 1K0 615 424 |
| | | | 02.2006 | | 24.0325-0158.1 | 525158 | POWER-DISC | 1K0 615 301 AA |
| | | | 08.2003 | | 24.0325-0158.1 | 525158 | POWER-DISC | 1K0 615 301 AA |
| | | | 02.2003 | | 24.0325-0158.1 | 525158 | POWER-DISC | 1K0 615 301 AA |



13.0460-3849.2 603849

Applications:

FIAT ALBEA (02-)

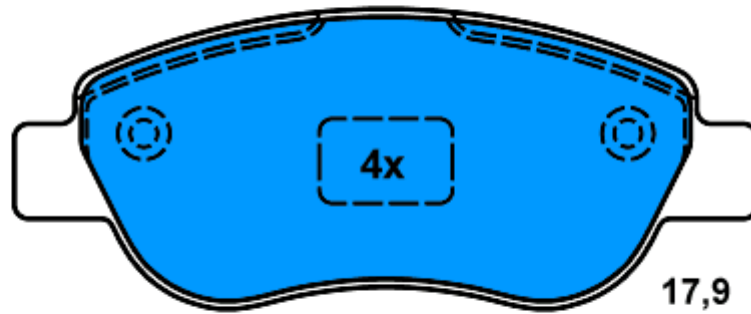
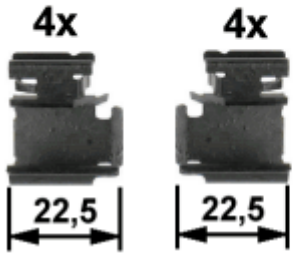

122,8 x 49,3

17,9



13.0460-5753.2 605753

Applications:
HONDA CR-V III (07-)

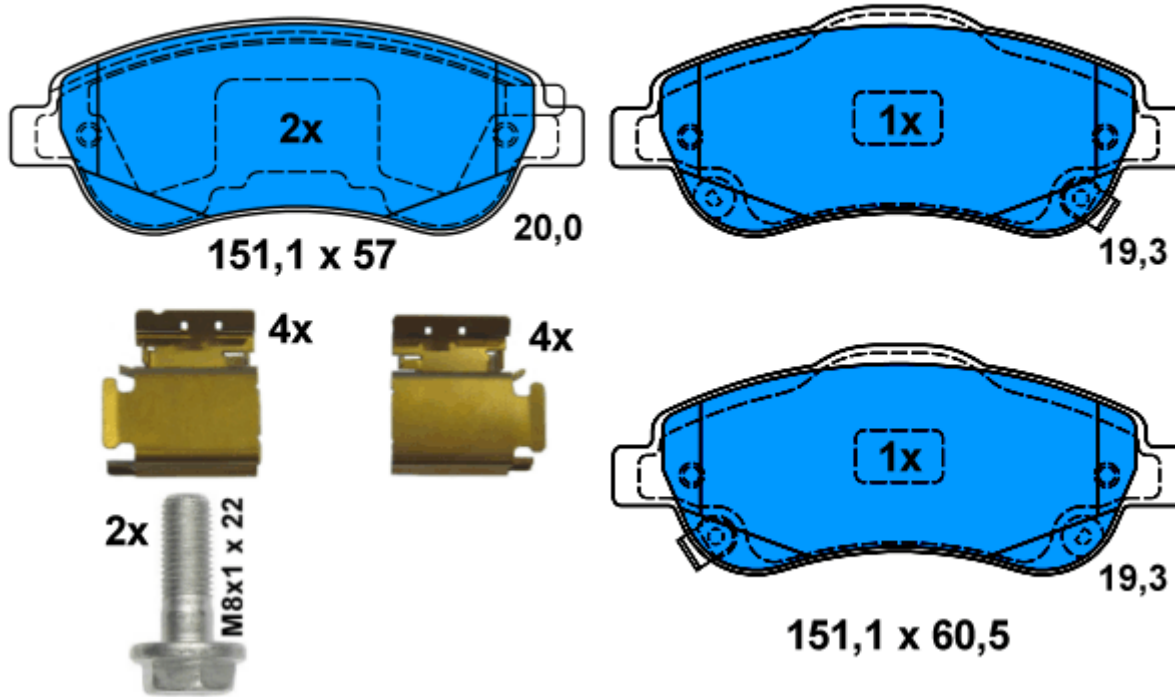

Ate

13.0460-5754.2 605754

Applications:
HONDA CR-V III (07-)

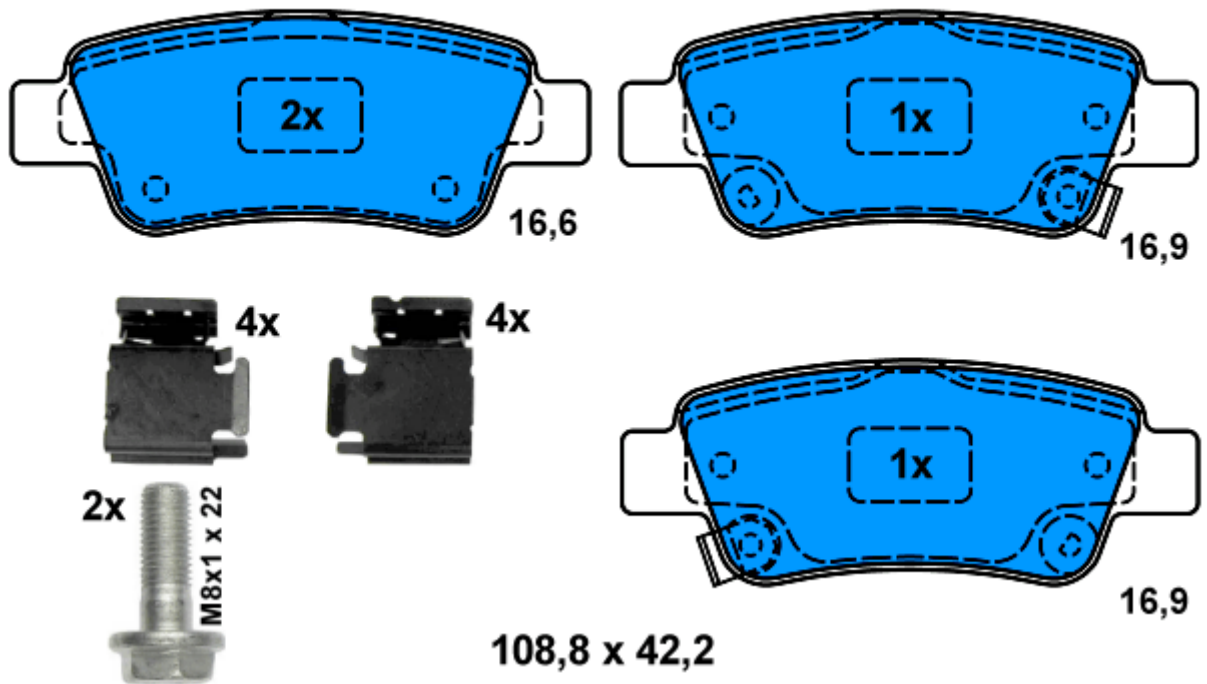

Ate

13.0460-7239.2 607239

Applications:

BMW X5 (07-)
BMW X6 (08-)

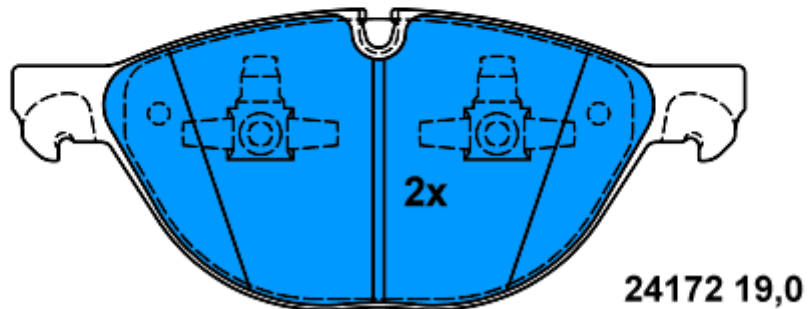
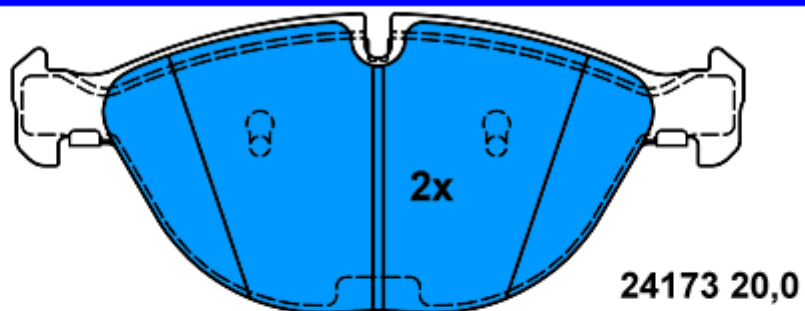

193 x 79



13.0460-3837.2 603837

Applications:

MERCEDES BENZ Transporter (BM 906) SPRINTER (06-)

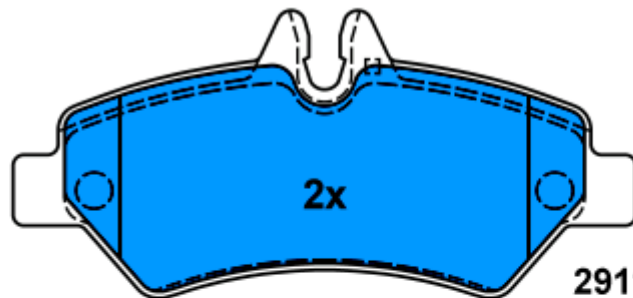

29190 20,2

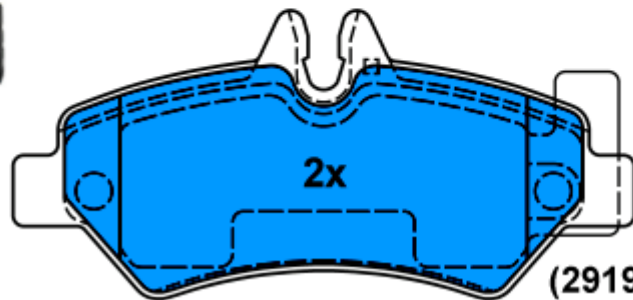
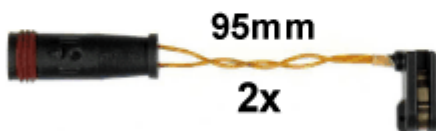

(29190) 20,2



M10x31

136,8 x 63



13.0460-2714.2 602714

Applications:

MINI R55 Clubman (07-)
MINI R56 (06-)

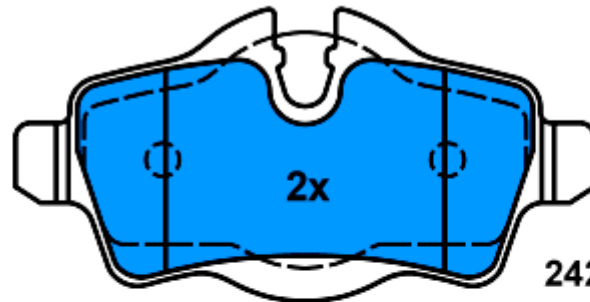
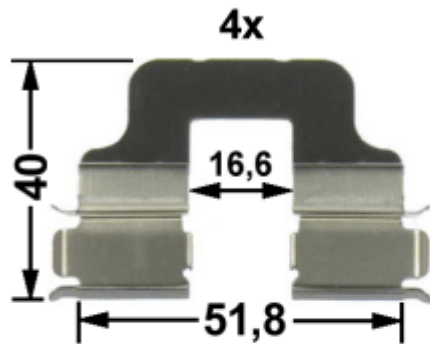

24289 16,9

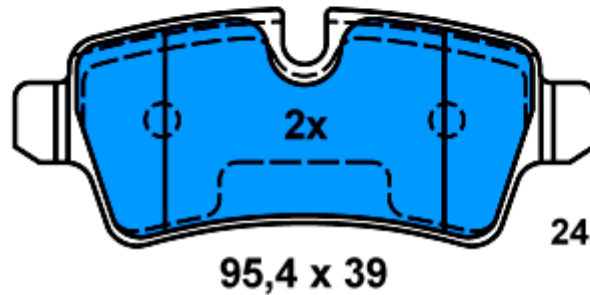

24290 16,9