

Nouvelles références disponibles
par applications









05/2008



www.ate.de



					<p>description</p>	<p>Références OE par référence ATE.</p>	 <p>Références remplacées / divers</p>
---	---	---	---	---	--------------------	---	---







AUDI

TT Coupe (06-)	3,2 Quattro		07.2006		24.0122-0242.1	422242	DISQUE DE FREIN	8J0 615 601 A	
TT Roadster (07-)			02.2007		24.0122-0242.1	422242	DISQUE DE FREIN	8J0 615 601 A	

Nouvelles références disponibles - par applications

05/2008



					description	Références OE par référence ATE.	 Références remplacées / divers
---	---	---	---	---	-------------	----------------------------------	--







BMW

Série 3/E90 Berline (05-)	320 d		09.2007		13.0460-7225.2	607225	PLAQUETTES DE FREIN	34 21 6 769 105 , 34 21 6 775 678	cf. Photo
	325 d		09.2006		13.0460-7225.2	607225	PLAQUETTES DE FREIN	34 21 6 769 105 , 34 21 6 775 678	cf. Photo
	325 i		12.2004		13.0460-7225.2	607225	PLAQUETTES DE FREIN	34 21 6 769 105 , 34 21 6 775 678	cf. Photo
	325 xi		01.2005		13.0460-7225.2	607225	PLAQUETTES DE FREIN	34 21 6 769 105 , 34 21 6 775 678	cf. Photo
	330 d		09.2005		13.0460-7225.2	607225	PLAQUETTES DE FREIN	34 21 6 769 105 , 34 21 6 775 678	cf. Photo
	330 i		09.2007		13.0460-7225.2	607225	PLAQUETTES DE FREIN	34 21 6 769 105 , 34 21 6 775 678	cf. Photo
			12.2004	08.2007	13.0460-7225.2	607225	PLAQUETTES DE FREIN	34 21 6 769 105 , 34 21 6 775 678	cf. Photo
	330 xd		09.2005		13.0460-7225.2	607225	PLAQUETTES DE FREIN	34 21 6 769 105 , 34 21 6 775 678	cf. Photo
	330 xi		09.2007		13.0460-7225.2	607225	PLAQUETTES DE FREIN	34 21 6 769 105 , 34 21 6 775 678	cf. Photo
			01.2005	08.2007	13.0460-7225.2	607225	PLAQUETTES DE FREIN	34 21 6 769 105 , 34 21 6 775 678	cf. Photo
	335 d		09.2006		13.0460-7225.2	607225	PLAQUETTES DE FREIN	34 21 6 769 105 , 34 21 6 775 678	cf. Photo
	335 i		09.2006		13.0460-7225.2	607225	PLAQUETTES DE FREIN	34 21 6 769 105 , 34 21 6 775 678	cf. Photo
	335 xi		03.2007		13.0460-7225.2	607225	PLAQUETTES DE FREIN	34 21 6 769 105 , 34 21 6 775 678	cf. Photo

Nouvelles références disponibles - par applications

05/2008



					description	Références OE par référence ATE.		Références remplacées / divers
---	---	---	---	---	-------------	----------------------------------	---	--------------------------------







BMW

Série 3/E91 Touring (05-)	320 d		06.2005	08.2007	13.0460-7225.2	607225	PLAQUETTES DE FREIN	34 21 6 769 105 , 34 21 6 775 678	cf. Photo
			09.2007		13.0460-7225.2	607225	PLAQUETTES DE FREIN	34 21 6 769 105 , 34 21 6 775 678	cf. Photo
	325 d		09.2006		13.0460-7225.2	607225	PLAQUETTES DE FREIN	34 21 6 769 105 , 34 21 6 775 678	cf. Photo
	325 i		06.2005		13.0460-7225.2	607225	PLAQUETTES DE FREIN	34 21 6 769 105 , 34 21 6 775 678	cf. Photo
	325 xi		06.2005		13.0460-7225.2	607225	PLAQUETTES DE FREIN	34 21 6 769 105 , 34 21 6 775 678	cf. Photo
			03.2007	08.2007	13.0460-7225.2	607225	PLAQUETTES DE FREIN	34 21 6 769 105 , 34 21 6 775 678	cf. Photo
	330 d		06.2005		13.0460-7225.2	607225	PLAQUETTES DE FREIN	34 21 6 769 105 , 34 21 6 775 678	cf. Photo
	330 i		09.2007		13.0460-7225.2	607225	PLAQUETTES DE FREIN	34 21 6 769 105 , 34 21 6 775 678	cf. Photo
			06.2005	08.2007	13.0460-7225.2	607225	PLAQUETTES DE FREIN	34 21 6 769 105 , 34 21 6 775 678	cf. Photo
	330 xd		06.2005		13.0460-7225.2	607225	PLAQUETTES DE FREIN	34 21 6 769 105 , 34 21 6 775 678	cf. Photo
	330 xi		09.2007		13.0460-7225.2	607225	PLAQUETTES DE FREIN	34 21 6 769 105 , 34 21 6 775 678	cf. Photo
			06.2005	08.2007	13.0460-7225.2	607225	PLAQUETTES DE FREIN	34 21 6 769 105 , 34 21 6 775 678	cf. Photo
	335 d		09.2006		13.0460-7225.2	607225	PLAQUETTES DE FREIN	34 21 6 769 105 , 34 21 6 775 678	cf. Photo

Nouvelles références disponibles - par applications

05/2008



					description	Références OE par référence ATE.		Références remplacées / divers
---	---	---	---	---	-------------	----------------------------------	---	--------------------------------

BMW

Série 3/E91 Touring (05-)	335 i		09.2006		13.0460-7225.2	607225	PLAQUETTES DE FREIN	34 21 6 769 105 , 34 21 6 775 678	cf. Photo
	335 xi		03.2007		13.0460-7225.2	607225	PLAQUETTES DE FREIN	34 21 6 769 105 , 34 21 6 775 678	cf. Photo
Série 3/E92 Coupé (06-)	325 d		03.2007		13.0460-7225.2	607225	PLAQUETTES DE FREIN	34 21 6 769 105 , 34 21 6 775 678	cf. Photo
	330 d		09.2006		13.0460-7225.2	607225	PLAQUETTES DE FREIN	34 21 6 769 105 , 34 21 6 775 678	cf. Photo
	330 i		09.2006		13.0460-7225.2	607225	PLAQUETTES DE FREIN	34 21 6 769 105 , 34 21 6 775 678	cf. Photo
	330 xd		09.2006		13.0460-7225.2	607225	PLAQUETTES DE FREIN	34 21 6 769 105 , 34 21 6 775 678	cf. Photo
	330 xi		09.2006		13.0460-7225.2	607225	PLAQUETTES DE FREIN	34 21 6 769 105 , 34 21 6 775 678	cf. Photo
	335 d		09.2006		13.0460-7225.2	607225	PLAQUETTES DE FREIN	34 21 6 769 105 , 34 21 6 775 678	cf. Photo
	335 i		09.2006		13.0460-7225.2	607225	PLAQUETTES DE FREIN	34 21 6 769 105 , 34 21 6 775 678	cf. Photo
	335 xi		09.2007		13.0460-7225.2	607225	PLAQUETTES DE FREIN	34 21 6 769 105 , 34 21 6 775 678	cf. Photo
Série 3/E93 Décapotable (07-)	325 d		09.2007		13.0460-7225.2	607225	PLAQUETTES DE FREIN	34 21 6 769 105 , 34 21 6 775 678	cf. Photo
	330 d		03.2007		13.0460-7225.2	607225	PLAQUETTES DE FREIN	34 21 6 769 105 , 34 21 6 775 678	cf. Photo
	330 i		03.2007		13.0460-7225.2	607225	PLAQUETTES DE FREIN	34 21 6 769 105 , 34 21 6 775 678	cf. Photo

Nouvelles références disponibles - par applications

05/2008



					description	Références OE par référence ATE.		Références remplacées / divers
--	--	--	--	--	-------------	----------------------------------	--	--------------------------------

BMW

Série 3/E93 Décapotable (07-)	335 i		03.2007		13.0460-7225.2	607225	PLAQUETTES DE FREIN	34 21 6 769 105 , 34 21 6 775 678	cf. Photo
X5 (07-)	3,0 d		01.2007		13.0460-7231.2	607231	PLAQUETTES DE FREIN	34 11 6 779 293 , 34 11 6 778 403	cf. Photo
	3,0 si		01.2007		13.0460-7231.2	607231	PLAQUETTES DE FREIN	34 11 6 779 293 , 34 11 6 778 403	cf. Photo
	4,8 i		01.2007		13.0460-7231.2	607231	PLAQUETTES DE FREIN	34 11 6 779 293 , 34 11 6 778 403	cf. Photo
X6 (08-)	30 d		05.2008		13.0460-7231.2	607231	PLAQUETTES DE FREIN	34 11 6 779 293 , 34 11 6 778 403	cf. Photo

CHEVROLET

KALOS (05-)	1,2 i		03.2005		03.0520-6619.3	696619	ATE TOPKIT		
			03.2005		24.3219-1751.3	020504	CYLINDRE DE ROUE	96574718	
	1,4 i		03.2005		03.0520-6619.3	696619	ATE TOPKIT		
			03.2005		24.3219-1751.3	020504	CYLINDRE DE ROUE	96574718	
	1,4 i 16V		03.2005		03.0520-6619.3	696619	ATE TOPKIT		
			03.2005		24.3219-1751.3	020504	CYLINDRE DE ROUE	96574718	



					description	Références OE par référence ATE.		Références remplacées / divers
--	--	--	--	--	-------------	----------------------------------	--	--------------------------------

CITROEN

C2 (03-)	1,1 i		09.2003		24.3727-0843.2	580843	CABLE FREIN A MAIN	4745 W3 , 4746 15	
			09.2003		24.2120-1741.3	010775	MAITRE CYL. TANDEM	4601 L7	
	1,4 16V		06.2006		24.3727-0843.2	580843	CABLE FREIN A MAIN	4745 W3 , 4746 15	
			06.2006		24.2120-1741.3	010775	MAITRE CYL. TANDEM	4601 L7	
	1,4 HDi		09.2003		24.3727-0843.2	580843	CABLE FREIN A MAIN	4745 W3 , 4746 15	
			09.2003		24.2120-1741.3	010775	MAITRE CYL. TANDEM	4601 L7	
	1,4 i		09.2003		24.3727-0843.2	580843	CABLE FREIN A MAIN	4745 W3 , 4746 15	
			09.2003		24.2120-1741.3	010775	MAITRE CYL. TANDEM	4601 L7	
	1,6 16V		09.2003		24.2120-1741.3	010775	MAITRE CYL. TANDEM	4601 L7	
	1,6 VTS		01.2005		24.2120-1741.3	010775	MAITRE CYL. TANDEM	4601 L7	
C3 (02-)	1,1 i		02.2002		24.2120-1741.3	010775	MAITRE CYL. TANDEM	4601 L7	
	1,4 16V		12.2003		24.2120-1741.3	010775	MAITRE CYL. TANDEM	4601 L7	
	1,4 16V HDi 90		02.2002		24.2120-1741.3	010775	MAITRE CYL. TANDEM	4601 L7	
	1,4 HDi		02.2002		24.2120-1741.3	010775	MAITRE CYL. TANDEM	4601 L7	
	1,4 i		02.2002		24.2120-1741.3	010775	MAITRE CYL. TANDEM	4601 L7	
	1,6 16V		02.2002		24.2120-1741.3	010775	MAITRE CYL. TANDEM	4601 L7	
C3 Pluriel (03-)	1,4 HDi		04.2004		24.2120-1741.3	010775	MAITRE CYL. TANDEM	4601 L7	
	1,4 i		05.2003		24.2120-1741.3	010775	MAITRE CYL. TANDEM	4601 L7	
	1,6 16V		05.2003		24.2120-1741.3	010775	MAITRE CYL. TANDEM	4601 L7	



					description	Références OE par référence ATE.		Références remplacées / divers
--	--	--	--	--	-------------	----------------------------------	--	--------------------------------

DACIA

LOGAN Berline (04-)	1,4		09.2004		24.0220-3036.1	480301	TAMBOUR DE FREIN	82 00 243 735	
	1,5 dCi		01.2006		24.0220-3036.1	480301	TAMBOUR DE FREIN	82 00 243 735	
			09.2005		24.0220-3036.1	480301	TAMBOUR DE FREIN	82 00 243 735	
	1,6		09.2004		24.0220-3036.1	480301	TAMBOUR DE FREIN	82 00 243 735	
	1,6 16V		02.2006		24.0220-3036.1	480301	TAMBOUR DE FREIN	82 00 243 735	

DAEWOO

KALOS (02-05)	1,2 i		04.2003	02.2005	03.0520-6619.3	696619	ATE TOPKIT		
			04.2003	02.2005	24.3219-1751.3	020504	CYLINDRE DE ROUE	96574718	
	1,4 i		09.2002	02.2005	03.0520-6619.3	696619	ATE TOPKIT		
			09.2002	02.2005	24.3219-1751.3	020504	CYLINDRE DE ROUE	96574718	
	1,4 i 16V		04.2003	02.2005	03.0520-6619.3	696619	ATE TOPKIT		
			04.2003	02.2005	24.3219-1751.3	020504	CYLINDRE DE ROUE	96574718	
	1,6 i 16V		11.2002	02.2005	03.0520-6619.3	696619	ATE TOPKIT		
			11.2002	02.2005	24.3219-1751.3	020504	CYLINDRE DE ROUE	96574718	



	i				description	Références OE par référence ATE.	i Références remplacées / divers
--	----------	--	--	--	-------------	----------------------------------	--

DAIHATSU

COPEN (03-)	0,7 i 16V		09.2003		24.0117-0107.1	417107	DISQUE DE FREIN	43512-97402-000	
	1,3 i 16V		03.2006		24.0117-0107.1	417107	DISQUE DE FREIN	43512-97402-000	
SIRION (05-)	1,0 DVVT		01.2005	12.2006	24.0117-0107.1	417107	DISQUE DE FREIN	43512-97402-000	
	1,0 DVVT 4x4		04.2005	12.2006	24.0117-0107.1	417107	DISQUE DE FREIN	43512-97402-000	
	1,3 DVVT		01.2005	12.2006	24.0117-0107.1	417107	DISQUE DE FREIN	43512-97402-000	
	1,3 DVVT 4x4		04.2005	12.2006	24.0117-0107.1	417107	DISQUE DE FREIN	43512-97402-000	
YRV (01-)	1,3 i 16V Turbo(M202)		04.2002		24.0117-0107.1	417107	DISQUE DE FREIN	43512-97402-000	

FIAT

500 (07-)	1,2 i		07.2007		13.0460-3838.2	603838	PLAQUETTES DE FREIN	77364635	cf. Photo
GRANDE PUNTO (06-)			10.2005	06.2007	03.0520-9220.3	699220	ATE TOPKIT		
PUNTO (03-06)			07.2003	11.2005	24.2120-1742.3	010776	MAITRE CYL. TANDEM	9949542	
	1,2 i 16V		07.2003	11.2005	24.2120-1742.3	010776	MAITRE CYL. TANDEM	9949542	



				description	Références OE par référence ATE.	 Références remplacées / divers
--	--	--	--	-------------	--	---------------------------------------







FORD

MAVERICK (01-)	2,0 i 16V		02.2001		24.0124-0735.1	424735	DISQUE DE FREIN	4360107 , 4454777 , 4564296 , 4668068 , EF9Y-33- 25X , E100-33-25XA , EF91- 33-25X , EC02-33-25X , EF91- 33-25XA , 4096352	
	2,3 i 16V		03.2004		24.0124-0735.1	424735	DISQUE DE FREIN	4360107 , 4454777 , 4564296 , 4668068 , EF9Y-33- 25X , E100-33-25XA , EF91- 33-25X , EC02-33-25X , EF91- 33-25XA , 4096352	
	3,0 i 24V		03.2004		24.0124-0735.1	424735	DISQUE DE FREIN	4360107 , 4454777 , 4564296 , 4668068 , EF9Y-33- 25X , E100-33-25XA , EF91- 33-25X , EC02-33-25X , EF91- 33-25XA , 4096352	
	3,0 i V6		02.2001		24.0124-0735.1	424735	DISQUE DE FREIN	4360107 , 4454777 , 4564296 , 4668068 , EF9Y-33- 25X , E100-33-25XA , EF91- 33-25X , EC02-33-25X , EF91- 33-25XA , 4096352	

Nouvelles références disponibles - par applications

05/2008



					description	Références OE par référence ATE.		Références remplacées / divers
---	---	---	---	---	-------------	--	---	-----------------------------------

HYUNDAI

ACCENT (00-05)	1,3 i 12V		08.2002	09.2005	24.3217-1723.3	020502	CYLINDRE DE ROUE	58330-02000 , 58380-02000 , 58330-25200 , 58380-25200	
	1,5 CRDi		08.2002	09.2005	24.3217-1723.3	020502	CYLINDRE DE ROUE	58330-02000 , 58380-02000 , 58330-25200 , 58380-25200	
	1,5 i 12V		08.2002	10.2002	24.3217-1723.3	020502	CYLINDRE DE ROUE	58330-02000 , 58380-02000 , 58330-25200 , 58380-25200	
	1,5 i 16V		08.2002	09.2005	24.3217-1723.3	020502	CYLINDRE DE ROUE	58330-02000 , 58380-02000 , 58330-25200 , 58380-25200	
	1,6 i 16V		10.2002	09.2005	24.3217-1723.3	020502	CYLINDRE DE ROUE	58330-02000 , 58380-02000 , 58330-25200 , 58380-25200	
ATOS / AMICA (GB) (98-)	1,0 i 12V	ArD	01.1998	08.2000	24.3727-3100.2	583100	CABLE FREIN A MAIN	59770-02010 , 59770-02020	
		ArD	09.2000		24.3727-3100.2	583100	CABLE FREIN A MAIN	59770-02010 , 59770-02020	
			01.1998	08.2000	24.3217-1723.3	020502	CYLINDRE DE ROUE	58330-02000 , 58380-02000 , 58330-25200 , 58380-25200	
			09.2000	04.2002	24.3217-1723.3	020502	CYLINDRE DE ROUE	58330-02000 , 58380-02000 , 58330-25200 , 58380-25200	
	1,0 i 12V Prime	ArD	09.2000		24.3727-3100.2	583100	CABLE FREIN A MAIN	59770-02010 , 59770-02020	
		ArD	09.1999		24.3727-3100.2	583100	CABLE FREIN A MAIN	59770-02010 , 59770-02020	
			09.1999		24.3217-1723.3	020502	CYLINDRE DE ROUE	58330-02000 , 58380-02000 , 58330-25200 , 58380-25200	
			09.2000	04.2002	24.3217-1723.3	020502	CYLINDRE DE ROUE	58330-02000 , 58380-02000 , 58330-25200 , 58380-25200	
	1,1 i 12V	ArD	03.2004		24.3727-3100.2	583100	CABLE FREIN A MAIN	59770-02010 , 59770-02020	
	1,1 i 12V Prime	ArD	08.2003		24.3727-3100.2	583100	CABLE FREIN A MAIN	59770-02010 , 59770-02020	

Nouvelles références disponibles - par applications

05/2008



					description	Références OE par référence ATE.		Références remplacées / divers
--	--	--	--	--	-------------	----------------------------------	--	--------------------------------





HYUNDAI

GETZ (02-)	1,1 i 12V		09.2005		24.3217-1723.3	020502	CYLINDRE DE ROUE	58330-02000 , 58380-02000 , 58330-25200 , 58380-25200	
			09.2002	08.2005	24.3217-1723.3	020502	CYLINDRE DE ROUE	58330-02000 , 58380-02000 , 58330-25200 , 58380-25200	
	1,3 i 12V		09.2003	04.2005	24.3217-1723.3	020502	CYLINDRE DE ROUE	58330-02000 , 58380-02000 , 58330-25200 , 58380-25200	
			09.2002	04.2005	24.3217-1723.3	020502	CYLINDRE DE ROUE	58330-02000 , 58380-02000 , 58330-25200 , 58380-25200	
	1,4 i 16V		08.2005		24.3217-1723.3	020502	CYLINDRE DE ROUE	58330-02000 , 58380-02000 , 58330-25200 , 58380-25200	
	1,5 CRDi		08.2005		24.3217-1723.3	020502	CYLINDRE DE ROUE	58330-02000 , 58380-02000 , 58330-25200 , 58380-25200	
			03.2003	04.2005	24.3217-1723.3	020502	CYLINDRE DE ROUE	58330-02000 , 58380-02000 , 58330-25200 , 58380-25200	
	1,5 i GL		08.2002	07.2005	24.3217-1723.3	020502	CYLINDRE DE ROUE	58330-02000 , 58380-02000 , 58330-25200 , 58380-25200	
	1,6 i 16V		09.2002	07.2005	24.3217-1723.3	020502	CYLINDRE DE ROUE	58330-02000 , 58380-02000 , 58330-25200 , 58380-25200	

KIA

CLARUS (96-99)	1,8 i 16V		05.1996	12.1999	13.0460-5712.2	605712	PLAQUETTES DE FREIN	OK9A0-33-28Z , OK9Y6-33-28Z	cf. Photo
	2,0 i 16V		05.1996	12.1999	13.0460-5712.2	605712	PLAQUETTES DE FREIN	OK9A0-33-28Z , OK9Y6-33-28Z	cf. Photo



				description	Références OE par référence ATE.	 Références remplacées / divers
---	---	--	---	-------------	--	---







MAZDA

TRIBUTE (00-04)	2,0 i 16V		03.2000	03.2004	24.0124-0735.1	424735	DISQUE DE FREIN	4360107 , 4454777 , 4564296 , 4668068 , EF9Y-33- 25X , E100-33-25XA , EF91- 33-25X , EC02-33-25X , EF91- 33-25XA , 4096352	
	2,0 i 16V 4WD		03.2000	03.2004	24.0124-0735.1	424735	DISQUE DE FREIN	4360107 , 4454777 , 4564296 , 4668068 , EF9Y-33- 25X , E100-33-25XA , EF91- 33-25X , EC02-33-25X , EF91- 33-25XA , 4096352	
	3,0 i V6 4WD		03.2000	03.2004	24.0124-0735.1	424735	DISQUE DE FREIN	4360107 , 4454777 , 4564296 , 4668068 , EF9Y-33- 25X , E100-33-25XA , EF91- 33-25X , EC02-33-25X , EF91- 33-25XA , 4096352	
TRIBUTE (04-)	2,3 i 16V AWD		04.2004		24.0124-0735.1	424735	DISQUE DE FREIN	4360107 , 4454777 , 4564296 , 4668068 , EF9Y-33- 25X , E100-33-25XA , EF91- 33-25X , EC02-33-25X , EF91- 33-25XA , 4096352	
	3,0 i V6 AWD		04.2004		24.0124-0735.1	424735	DISQUE DE FREIN	4360107 , 4454777 , 4564296 , 4668068 , EF9Y-33- 25X , E100-33-25XA , EF91- 33-25X , EC02-33-25X , EF91- 33-25XA , 4096352	

Nouvelles références disponibles - par applications

05/2008



					description	Références OE par référence ATE.		Références remplacées / divers
---	---	---	---	---	-------------	----------------------------------	---	--------------------------------

MITSUBISHI

COLT/LANCER Berline (88-92)	1,2 (C65A)		06.1990	05.1992	24.3219-1752.3	020505	CYLINDRE DE ROUE	MB618981	
	1,3 (C51A/V)		06.1990	05.1992	24.3219-1752.3	020505	CYLINDRE DE ROUE	MB618981	
	1,3 (C61A)		06.1990	10.1992	24.3219-1752.3	020505	CYLINDRE DE ROUE	MB618981	
	1,5 (C52A) KAT		06.1990	05.1992	24.3219-1752.3	020505	CYLINDRE DE ROUE	MB618981	
	1,5 (C62A)		06.1990	10.1992	24.3219-1752.3	020505	CYLINDRE DE ROUE	MB618981	
	1,6 16V (C66A)		06.1992	10.1992	24.3219-1752.3	020505	CYLINDRE DE ROUE	MB618981	
	1,6 4x4 (C76A)		06.1992	10.1992	24.3219-1752.3	020505	CYLINDRE DE ROUE	MB618981	
	1,8 4x4 (C77A)		05.1989	05.1992	24.3219-1752.3	020505	CYLINDRE DE ROUE	MB618981	
	1,8 D (C54A)		06.1990	05.1992	24.3219-1752.3	020505	CYLINDRE DE ROUE	MB618981	
	1,8 D (C64A)		06.1990	05.1992	24.3219-1752.3	020505	CYLINDRE DE ROUE	MB618981	
	2,0 D (C67A)		06.1992	10.1992	24.3219-1752.3	020505	CYLINDRE DE ROUE	MB618981	
COLT/LANCER Berline (92-96)	1,3 (CA1A)		12.1991	04.1996	24.3219-1752.3	020505	CYLINDRE DE ROUE	MB618981	
	1,3 (CB1A)		05.1992	04.1996	24.3219-1752.3	020505	CYLINDRE DE ROUE	MB618981	
COLT/LANCER Berline (96-01)	1,3 i 12V (CJ1A)		05.1996	08.2000	24.3219-1752.3	020505	CYLINDRE DE ROUE	MB618981	
	1,3 i 12V (CK1A)		05.1996	07.2001	24.3219-1752.3	020505	CYLINDRE DE ROUE	MB618981	
	1,3 i 16V (CJ1A)		09.2000	07.2001	24.3219-1752.3	020505	CYLINDRE DE ROUE	MB618981	
	1,6 i 16V (CJ4A)		09.2000	07.2001	24.3219-1752.3	020505	CYLINDRE DE ROUE	MB618981	
			05.1996	08.2000	24.3219-1752.3	020505	CYLINDRE DE ROUE	MB618981	
	1,6 i 16V (CK4A)		05.1996	07.2001	24.3219-1752.3	020505	CYLINDRE DE ROUE	MB618981	

Nouvelles références disponibles - par applications

05/2008



					description	Références OE par référence ATE.		Références remplacées / divers
--	--	--	--	--	-------------	----------------------------------	--	--------------------------------

MITSUBISHI

LANCER Break (92-96)	1,6 16V (CB4W)		06.1992	09.1996	24.3219-1752.3	020505	CYLINDRE DE ROUE	MB618981	
	2,0 D (CB8W)		06.1992	09.1996	24.3219-1752.3	020505	CYLINDRE DE ROUE	MB618981	
SPACE RUNNER (91-99)	1,8 (N11W)		06.1991	08.1999	24.3219-1752.3	020505	CYLINDRE DE ROUE	MB618981	
	2,0 TD (N18W)		06.1992	08.1999	24.3219-1752.3	020505	CYLINDRE DE ROUE	MB618981	

PEUGEOT

1007 (05-)	1,4		04.2005		24.3727-0843.2	580843	CABLE FREIN A MAIN	4745 W3 , 4746 15	
	1,4 16V		10.2005		24.3727-0843.2	580843	CABLE FREIN A MAIN	4745 W3 , 4746 15	
	1,4 HDi		04.2005		24.3727-0843.2	580843	CABLE FREIN A MAIN	4745 W3 , 4746 15	

PROTON

PERSONA 400 (94-00)	1,5 GLi		01.1994	07.2000	24.3219-1752.3	020505	CYLINDRE DE ROUE	MB618981	
	2,0 TD		09.1996	07.2000	24.3219-1752.3	020505	CYLINDRE DE ROUE	MB618981	

RENAULT

THALIA (LB_) (00-)	1,4		12.2002		24.0220-3036.1	480301	TAMBOUR DE FREIN	82 00 243 735	
	1,4 16V		12.2002		24.0220-3036.1	480301	TAMBOUR DE FREIN	82 00 243 735	
	1,5 dCi		12.2002		24.0220-3036.1	480301	TAMBOUR DE FREIN	82 00 243 735	
	1,6 16V		12.2002		24.0220-3036.1	480301	TAMBOUR DE FREIN	82 00 243 735	
TWINGO I Limousine (C06_) (93-06)	1,2 (G)		08.2004		24.0220-3036.1	480301	TAMBOUR DE FREIN	82 00 243 735	

Nouvelles références disponibles - par applications

05/2008



					description	Références OE par référence ATE.		Références remplacées / divers
--	--	--	--	--	-------------	----------------------------------	--	--------------------------------

TOYOTA

AVENSIS (03-)	1,6 i 16V		04.2003		24.3727-1919.2	581919	CABLE FREIN A MAIN	46410-12270	
	1,8 i 16V		04.2003		24.3727-1919.2	581919	CABLE FREIN A MAIN	46410-12270	
	2,0 D-4D		03.2006		24.3727-1919.2	581919	CABLE FREIN A MAIN	46410-12270	
			04.2003		24.3727-1919.2	581919	CABLE FREIN A MAIN	46410-12270	
	2,0 i 16V		04.2003		24.3727-1919.2	581919	CABLE FREIN A MAIN	46410-12270	
	2,2 D-4D		10.2005		24.3727-1919.2	581919	CABLE FREIN A MAIN	46410-12270	
	2,2 D-CAT		07.2005		24.3727-1919.2	581919	CABLE FREIN A MAIN	46410-12270	
	2,4 i 16V		09.2003		24.3727-1919.2	581919	CABLE FREIN A MAIN	46410-12270	
			10.2003		24.3727-1919.2	581919	CABLE FREIN A MAIN	46410-12270	
COROLLA (02-04)	1,4 VVTi (ZZE120)		08.2002	05.2004	24.3727-1919.2	581919	CABLE FREIN A MAIN	46410-12270	
			01.2002	05.2004	24.3727-1919.2	581919	CABLE FREIN A MAIN	46410-12270	
	1,6 VVTi (ZZE121)		01.2002	05.2004	24.3727-1919.2	581919	CABLE FREIN A MAIN	46410-12270	
			08.2002	05.2004	24.3727-1919.2	581919	CABLE FREIN A MAIN	46410-12270	
	1,8 VVTi TS (ZZE123)		01.2002	05.2004	24.3727-1919.2	581919	CABLE FREIN A MAIN	46410-12270	
	2,0 D-4D (CDE120)		05.2003	05.2004	24.3727-1919.2	581919	CABLE FREIN A MAIN	46410-12270	
			08.2002	05.2004	24.3727-1919.2	581919	CABLE FREIN A MAIN	46410-12270	
			01.2002	05.2004	24.3727-1919.2	581919	CABLE FREIN A MAIN	46410-12270	
COROLLA (04-06)	1,4 D-4D (NDE120)		06.2004	10.2006	24.3727-1919.2	581919	CABLE FREIN A MAIN	46410-12270	
	1,4 VVTi (ZZE120)		06.2004	10.2006	24.3727-1919.2	581919	CABLE FREIN A MAIN	46410-12270	

Nouvelles références disponibles - par applications

05/2008



					description	Références OE par référence ATE.		Références remplacées / divers
--	--	--	--	--	-------------	----------------------------------	--	--------------------------------

TOYOTA

COROLLA (04-06)	1,6 VVTi (ZZE121)		06.2004	10.2006	24.3727-1919.2	581919	CABLE FREIN A MAIN	46410-12270	
	1,8 VVTi (ZZE123)		06.2004	10.2006	24.3727-1919.2	581919	CABLE FREIN A MAIN	46410-12270	
	2,0 D-4D (CDE120)		06.2004	10.2006	24.3727-1919.2	581919	CABLE FREIN A MAIN	46410-12270	
COROLLA VERSO (02-04)	1,4 VVTi (ZZE120)		01.2002	05.2004	24.3727-1917.2	581917	CABLE FREIN A MAIN	46410-42040	
	1,6 VVTi (ZZE121)		01.2002	05.2004	24.3727-1917.2	581917	CABLE FREIN A MAIN	46410-42040	
	1,8 VVTi (ZZE122)		01.2002	05.2004	24.3727-1917.2	581917	CABLE FREIN A MAIN	46410-42040	
	2,0 D-4D (CDE120)		01.2002	05.2004	24.3727-1917.2	581917	CABLE FREIN A MAIN	46410-42040	
RAV4 II (00-05)	1,8 VVTi		08.2002	10.2005	24.0222-8008.1	480304	TAMBOUR DE FREIN	42431-42050 , 42431-28100	
			02.2001	10.2005	24.3727-1917.2	581917	CABLE FREIN A MAIN	46410-42040	
	2,0 D-4D 4WD		09.2001	10.2005	24.0222-8008.1	480304	TAMBOUR DE FREIN	42431-42050 , 42431-28100	
			09.2001	10.2005	24.3727-1917.2	581917	CABLE FREIN A MAIN	46410-42040	
	2,0 VVTi 4WD		08.2002	10.2005	24.0222-8008.1	480304	TAMBOUR DE FREIN	42431-42050 , 42431-28100	
			06.2000	10.2005	24.3727-1917.2	581917	CABLE FREIN A MAIN	46410-42040	
	2,0 VVTi 4WD (Nato)		08.2002	07.2003	24.0222-8008.1	480304	TAMBOUR DE FREIN	42431-42050 , 42431-28100	
			06.2000	07.2003	24.3727-1917.2	581917	CABLE FREIN A MAIN	46410-42040	
	2,4 VVTi 4x4		08.2003	10.2005	24.0222-8008.1	480304	TAMBOUR DE FREIN	42431-42050 , 42431-28100	
			08.2003	10.2005	24.3727-1917.2	581917	CABLE FREIN A MAIN	46410-42040	
YARIS (99-)	1,0 i 16V		01.2001	03.2003	24.0220-0047.1	480199	TAMBOUR DE FREIN	42431-0D010	
			04.2003		24.0220-0047.1	480199	TAMBOUR DE FREIN	42431-0D010	



	i				description	Références OE par référence ATE.	i Références remplacées / divers
--	----------	--	--	--	-------------	----------------------------------	--

TOYOTA

YARIS (99-)	1,3 i 16V		04.2002		24.0220-0047.1	480199	TAMBOUR DE FREIN	42431-0D010	
	1,4 D-4D		12.2001	03.2003	24.0220-0047.1	480199	TAMBOUR DE FREIN	42431-0D010	
YARIS VERSO (99-)	1,3 i 16V	ArG	11.1999		24.3219-1749.3	020500	CYLINDRE DE ROUE	47570-20101	
	1,4 D-4D	ArG	12.2001		24.3219-1749.3	020500	CYLINDRE DE ROUE	47570-20101	

Nouvelles références disponibles - par applications

05/2008









					description	Références OE par référence ATE.		Références remplacées / divers
--	--	--	--	--	-------------	----------------------------------	--	--------------------------------

VOLVO

240 Berline (74-93)	2		08.1974	07.1976	24.3727-1313.2	581313	CABLE FREIN A MAIN	1205743	
			08.1976	07.1979	24.3727-1313.2	581313	CABLE FREIN A MAIN	1205743	
			08.1984	07.1985	24.3727-1313.2	581313	CABLE FREIN A MAIN	1205743	
			09.1978	08.1983	24.3727-1313.2	581313	CABLE FREIN A MAIN	1205743	
			10.1982	08.1984	24.3727-1313.2	581313	CABLE FREIN A MAIN	1205743	
	2,1		08.1974	07.1975	24.3727-1313.2	581313	CABLE FREIN A MAIN	1205743	
			08.1980	07.1984	24.3727-1313.2	581313	CABLE FREIN A MAIN	1205743	
			08.1974	07.1980	24.3727-1313.2	581313	CABLE FREIN A MAIN	1205743	
			08.1975	07.1980	24.3727-1313.2	581313	CABLE FREIN A MAIN	1205743	
	2,1 T		08.1980	07.1984	24.3727-1313.2	581313	CABLE FREIN A MAIN	1205743	
	2,3		08.1984	07.1986	24.3727-1313.2	581313	CABLE FREIN A MAIN	1205743	
			08.1986	12.1988	24.3727-1313.2	581313	CABLE FREIN A MAIN	1205743	
			08.1984	12.1989	24.3727-1313.2	581313	CABLE FREIN A MAIN	1205743	
			08.1986	07.1987	24.3727-1313.2	581313	CABLE FREIN A MAIN	1205743	
			08.1983	07.1985	24.3727-1313.2	581313	CABLE FREIN A MAIN	1205743	
			08.1980	07.1984	24.3727-1313.2	581313	CABLE FREIN A MAIN	1205743	
			08.1978	07.1980	24.3727-1313.2	581313	CABLE FREIN A MAIN	1205743	
			08.1980	07.1983	24.3727-1313.2	581313	CABLE FREIN A MAIN	1205743	
	2,3 i Katalysator		08.1986	07.1993	24.3727-1313.2	581313	CABLE FREIN A MAIN	1205743	



					<p>description</p>	<p>Références OE par référence ATE.</p>	 <p>Références remplacées / divers</p>
---	---	---	---	---	--------------------	---	---

VOLVO

240 Berline (74-93)	2,4 D		08.1978	07.1985	24.3727-1313.2	581313	CABLE FREIN A MAIN	1205743	
			08.1987	08.1993	24.3727-1313.2	581313	CABLE FREIN A MAIN	1205743	
	2,7		08.1979	07.1980	24.3727-1313.2	581313	CABLE FREIN A MAIN	1205743	



13.0460-7225.2 607225

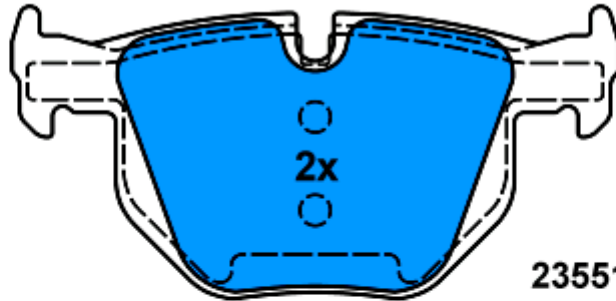

23551 17,0

123 x 59,2

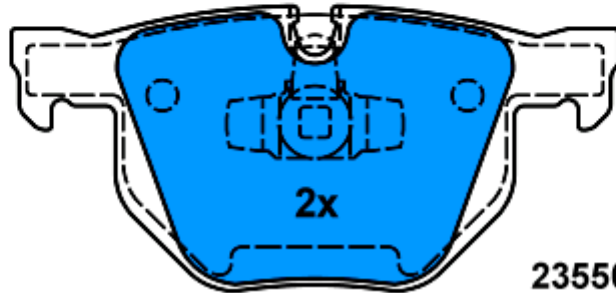

23550 17,0

123 x 58

Applications:

- BMW 3er Reihe/E90 Limousine (05-)
- BMW 3er Reihe/E91 Touring (05-)
- BMW 3er Reihe/E92 Coupe (06-)
- BMW 3er Reihe/E93 Cabrio (07-)



13.0460-5712.2 605712

Applications:
KIA CLARUS (96-99)

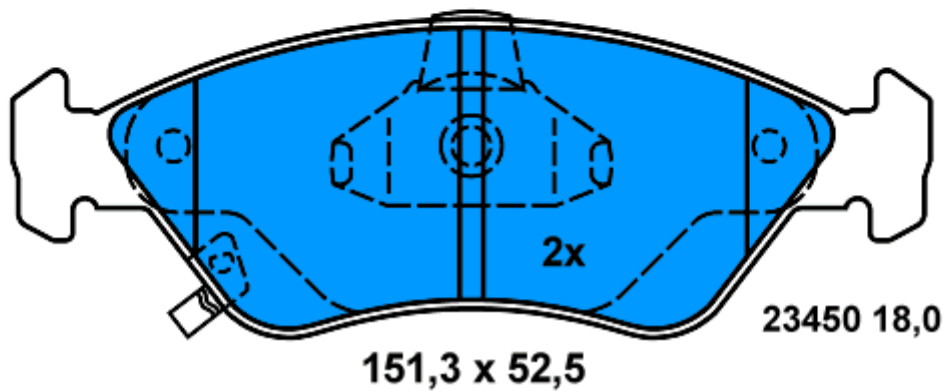
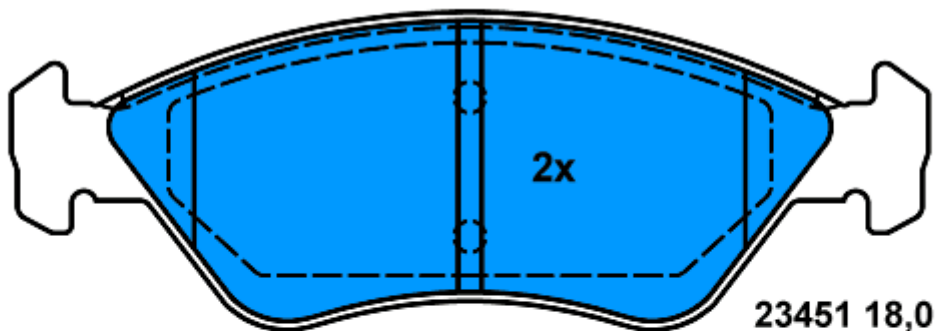

Ate

13.0460-3838.2 603838

Applications:

FIAT 500 (07-)

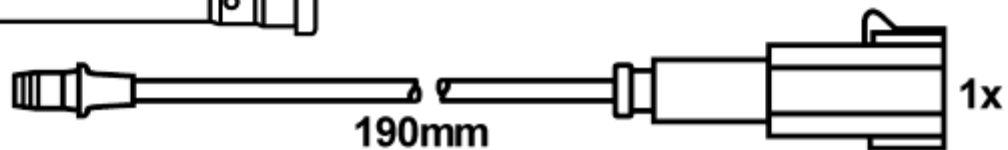
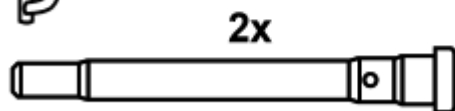
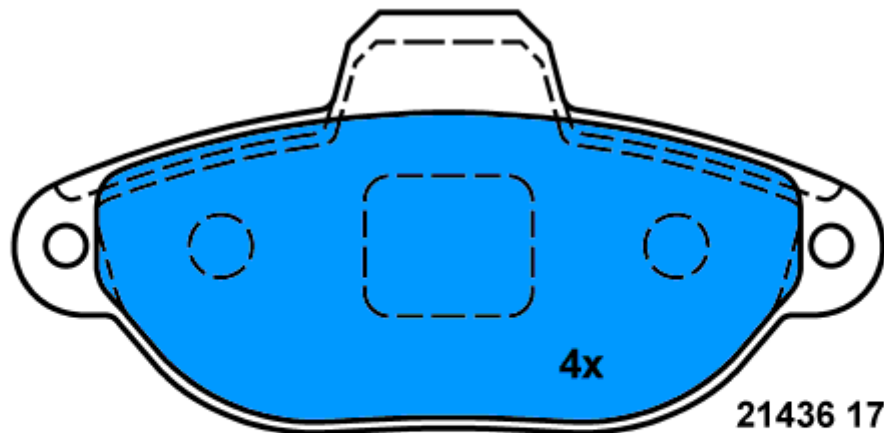



13.0460-7231.2 607231

Applications:

BMW X5 (07-)
BMW X6 (08-)

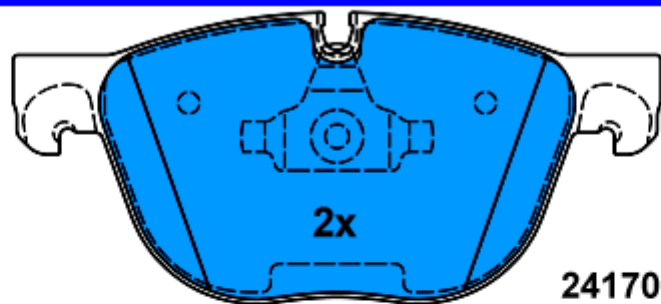

24170 19,8

171,1 x 76,8

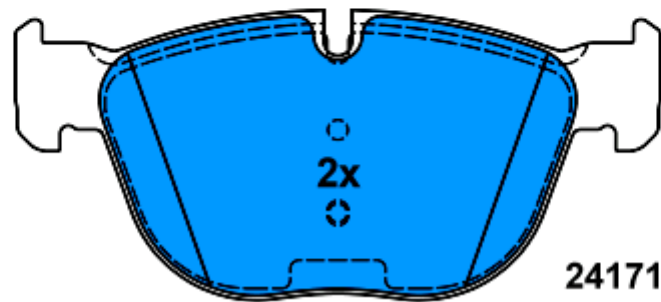

24171 20,3

170,2 x 76,8