

Nouvelles références disponibles
par applications



04/2008









www.ate.de

Nouvelles références disponibles - par applications

04/2008



					description	Références OE par référence ATE.		Références remplacées / divers
---	---	---	---	---	-------------	----------------------------------	---	--------------------------------

AUDI

A3 / A3 Sportback (03-)	3,2 Quattro		07.2003		13.0460-0035.2	610035	ACCES. JEUX PLAQ.	8P0 615 231	
	S3		11.2006		13.0460-0035.2	610035	ACCES. JEUX PLAQ.	8P0 615 231	
A4 (B6/B7) (01-)	1,6		12.2000		24.5138-0263.3	330885	FLEXIBLE FREIN	8E0 611 775 N , 8E0 611 775 H	24.5243-0260.3
	1,8 T		07.2001		24.5138-0263.3	330885	FLEXIBLE FREIN	8E0 611 775 N , 8E0 611 775 H	24.5243-0260.3
			07.2002		24.5138-0263.3	330885	FLEXIBLE FREIN	8E0 611 775 N , 8E0 611 775 H	24.5243-0260.3
			11.2002		24.5138-0263.3	330885	FLEXIBLE FREIN	8E0 611 775 N , 8E0 611 775 H	24.5243-0260.3
			12.2000		24.5138-0263.3	330885	FLEXIBLE FREIN	8E0 611 775 N , 8E0 611 775 H	24.5243-0260.3
	1,8 T Quattro		07.2001		24.5138-0263.3	330885	FLEXIBLE FREIN	8E0 611 775 N , 8E0 611 775 H	24.5243-0260.3
			12.2000		24.5138-0263.3	330885	FLEXIBLE FREIN	8E0 611 775 N , 8E0 611 775 H	24.5243-0260.3
			07.2002		24.5138-0263.3	330885	FLEXIBLE FREIN	8E0 611 775 N , 8E0 611 775 H	24.5243-0260.3
			11.2002		24.5138-0263.3	330885	FLEXIBLE FREIN	8E0 611 775 N , 8E0 611 775 H	24.5243-0260.3
	1,9 TDI		04.2001		24.5138-0263.3	330885	FLEXIBLE FREIN	8E0 611 775 N , 8E0 611 775 H	24.5243-0260.3
			06.2004		24.5138-0263.3	330885	FLEXIBLE FREIN	8E0 611 775 N , 8E0 611 775 H	24.5243-0260.3
			12.2000		24.5138-0263.3	330885	FLEXIBLE FREIN	8E0 611 775 N , 8E0 611 775 H	24.5243-0260.3



					description	Références OE par référence ATE.		Références remplacées / divers
--	--	--	--	--	-------------	----------------------------------	--	--------------------------------

AUDI

A4 (B6/B7) (01-)	1,9 TDI Quattro		12.2000		24.5138-0263.3	330885	FLEXIBLE FREIN	8E0 611 775 N , 8E0 611 775 H	24.5243-0260.3
	2		12.2000		24.5138-0263.3	330885	FLEXIBLE FREIN	8E0 611 775 N , 8E0 611 775 H	24.5243-0260.3
	2,0 FSI		07.2002		24.5138-0263.3	330885	FLEXIBLE FREIN	8E0 611 775 N , 8E0 611 775 H	24.5243-0260.3
	2,0 TDI		06.2006		24.5138-0263.3	330885	FLEXIBLE FREIN	8E0 611 775 N , 8E0 611 775 H	24.5243-0260.3
			11.2004		24.5138-0263.3	330885	FLEXIBLE FREIN	8E0 611 775 N , 8E0 611 775 H	24.5243-0260.3
	2,0 TDI Quattro		01.2006		24.5138-0263.3	330885	FLEXIBLE FREIN	8E0 611 775 N , 8E0 611 775 H	24.5243-0260.3
			06.2006		24.5138-0263.3	330885	FLEXIBLE FREIN	8E0 611 775 N , 8E0 611 775 H	24.5243-0260.3
	2,0 TFSI		06.2005		24.5138-0263.3	330885	FLEXIBLE FREIN	8E0 611 775 N , 8E0 611 775 H	24.5243-0260.3
			11.2004		24.5138-0263.3	330885	FLEXIBLE FREIN	8E0 611 775 N , 8E0 611 775 H	24.5243-0260.3
	2,0 TFSI Quattro		06.2005		24.5138-0263.3	330885	FLEXIBLE FREIN	8E0 611 775 N , 8E0 611 775 H	24.5243-0260.3
			11.2004		24.5138-0263.3	330885	FLEXIBLE FREIN	8E0 611 775 N , 8E0 611 775 H	24.5243-0260.3
	2,4		09.2001		24.5138-0263.3	330885	FLEXIBLE FREIN	8E0 611 775 N , 8E0 611 775 H	24.5243-0260.3
	2,5 TDI		12.2000		24.5138-0263.3	330885	FLEXIBLE FREIN	8E0 611 775 N , 8E0 611 775 H	24.5243-0260.3



					description	Références OE par référence ATE.		Références remplacées / divers
--	--	--	--	--	-------------	----------------------------------	--	--------------------------------

AUDI

A4 (B6/B7) (01-)	2,5 TDI Quattro		12.2000		24.5138-0263.3	330885	FLEXIBLE FREIN	8E0 611 775 N , 8E0 611 775 H	24.5243-0260.3
	2,7 TDI		01.2006		24.5138-0263.3	330885	FLEXIBLE FREIN	8E0 611 775 N , 8E0 611 775 H	24.5243-0260.3
	3		12.2000		24.5138-0263.3	330885	FLEXIBLE FREIN	8E0 611 775 N , 8E0 611 775 H	24.5243-0260.3
	3,0 Quattro		12.2000		24.5138-0263.3	330885	FLEXIBLE FREIN	8E0 611 775 N , 8E0 611 775 H	24.5243-0260.3
	3,0 TDI Quattro		01.2006		24.5138-0263.3	330885	FLEXIBLE FREIN	8E0 611 775 N , 8E0 611 775 H	24.5243-0260.3
			11.2004		24.5138-0263.3	330885	FLEXIBLE FREIN	8E0 611 775 N , 8E0 611 775 H	24.5243-0260.3
	3,2 FSI		01.2005		24.5138-0263.3	330885	FLEXIBLE FREIN	8E0 611 775 N , 8E0 611 775 H	24.5243-0260.3
	3,2 FSI Quattro		01.2005		24.5138-0263.3	330885	FLEXIBLE FREIN	8E0 611 775 N , 8E0 611 775 H	24.5243-0260.3
	RS4 4,2		11.2005		13.0460-0023.2	610023	ACCES. JEUX PLAQ.	3D0 615 231	
	S4 4,2		03.2003		24.5138-0263.3	330885	FLEXIBLE FREIN	8E0 611 775 N , 8E0 611 775 H	24.5243-0260.3
			01.2005		13.0460-0023.2	610023	ACCES. JEUX PLAQ.	3D0 615 231	
A4 DECAPOTABLE (02-)	1,8 T		04.2002		24.5138-0263.3	330885	FLEXIBLE FREIN	8E0 611 775 N , 8E0 611 775 H	24.5243-0260.3
	1,8 T Quattro		05.2003		24.5138-0263.3	330885	FLEXIBLE FREIN	8E0 611 775 N , 8E0 611 775 H	24.5243-0260.3
	2		05.2004		24.5138-0263.3	330885	FLEXIBLE FREIN	8E0 611 775 N , 8E0 611 775 H	24.5243-0260.3



					description	Références OE par référence ATE.		Références remplacées / divers
--	--	--	--	--	-------------	----------------------------------	--	--------------------------------

AUDI

A4 DECAPOTABLE (02-)	2,0 TDI		10.2005		24.5138-0263.3	330885	FLEXIBLE FREIN	8E0 611 775 N , 8E0 611 775 H	24.5243-0260.3
	2,0 TFSI		10.2005		24.5138-0263.3	330885	FLEXIBLE FREIN	8E0 611 775 N , 8E0 611 775 H	24.5243-0260.3
			01.2006		24.5138-0263.3	330885	FLEXIBLE FREIN	8E0 611 775 N , 8E0 611 775 H	24.5243-0260.3
	2,4		04.2002		24.5138-0263.3	330885	FLEXIBLE FREIN	8E0 611 775 N , 8E0 611 775 H	24.5243-0260.3
	2,5 TDI		08.2002		24.5138-0263.3	330885	FLEXIBLE FREIN	8E0 611 775 N , 8E0 611 775 H	24.5243-0260.3
	2,7 TDI		06.2006		24.5138-0263.3	330885	FLEXIBLE FREIN	8E0 611 775 N , 8E0 611 775 H	24.5243-0260.3
	3		04.2002		24.5138-0263.3	330885	FLEXIBLE FREIN	8E0 611 775 N , 8E0 611 775 H	24.5243-0260.3
	3,0 Quattro		05.2003		24.5138-0263.3	330885	FLEXIBLE FREIN	8E0 611 775 N , 8E0 611 775 H	24.5243-0260.3
	3,0 TDI Quattro		10.2005		24.5138-0263.3	330885	FLEXIBLE FREIN	8E0 611 775 N , 8E0 611 775 H	24.5243-0260.3
			01.2006		24.5138-0263.3	330885	FLEXIBLE FREIN	8E0 611 775 N , 8E0 611 775 H	24.5243-0260.3
	3,2 FSI		10.2005		24.5138-0263.3	330885	FLEXIBLE FREIN	8E0 611 775 N , 8E0 611 775 H	24.5243-0260.3
	3,2 FSI Quattro		10.2005		24.5138-0263.3	330885	FLEXIBLE FREIN	8E0 611 775 N , 8E0 611 775 H	24.5243-0260.3
	RS4 4,2		05.2006		13.0460-0023.2	610023	ACCES. JEUX PLAQ.	3D0 615 231	
	S4 4,2 Quattro		02.2004		24.5138-0263.3	330885	FLEXIBLE FREIN	8E0 611 775 N , 8E0 611 775 H	24.5243-0260.3

Nouvelles références disponibles - par applications

04/2008



					description	Références OE par référence ATE.		Références remplacées / divers
--	--	--	--	--	-------------	----------------------------------	--	--------------------------------

AUDI

A4 DECAPOTABLE (02-)	S4 4,2 Quattro		02.2004		13.0460-0023.2	610023	ACCES. JEUX PLAQ.	3D0 615 231	
A6 (C6) Avant (05-)	2,0 TDI		03.2005		13.0460-0023.2	610023	ACCES. JEUX PLAQ.	3D0 615 231	
			06.2005		13.0460-0023.2	610023	ACCES. JEUX PLAQ.	3D0 615 231	
	2,0 TFSI		06.2005		13.0460-0023.2	610023	ACCES. JEUX PLAQ.	3D0 615 231	
	2,4		03.2005		13.0460-0023.2	610023	ACCES. JEUX PLAQ.	3D0 615 231	
	2,4 Quattro		03.2005		13.0460-0023.2	610023	ACCES. JEUX PLAQ.	3D0 615 231	
	2,7 TDI		03.2005		13.0460-0023.2	610023	ACCES. JEUX PLAQ.	3D0 615 231	
	2,7 TDI Quattro		03.2005		13.0460-0023.2	610023	ACCES. JEUX PLAQ.	3D0 615 231	
			06.2005		13.0460-0023.2	610023	ACCES. JEUX PLAQ.	3D0 615 231	
	2,8 FSI		11.2006		13.0460-0023.2	610023	ACCES. JEUX PLAQ.	3D0 615 231	
	2,8 FSI Quattro		04.2007		13.0460-0023.2	610023	ACCES. JEUX PLAQ.	3D0 615 231	
	3		03.2005		13.0460-0023.2	610023	ACCES. JEUX PLAQ.	3D0 615 231	
	3,0 Quattro		03.2005		13.0460-0023.2	610023	ACCES. JEUX PLAQ.	3D0 615 231	
	3,0 TDI Quattro		06.2006		13.0460-0023.2	610023	ACCES. JEUX PLAQ.	3D0 615 231	
			03.2005		13.0460-0023.2	610023	ACCES. JEUX PLAQ.	3D0 615 231	
	3,2		03.2005		13.0460-0023.2	610023	ACCES. JEUX PLAQ.	3D0 615 231	
	3,2 Quattro		03.2005		13.0460-0023.2	610023	ACCES. JEUX PLAQ.	3D0 615 231	
	4,2 FSI Quattro		06.2006		13.0460-0023.2	610023	ACCES. JEUX PLAQ.	3D0 615 231	
	4,2 Quattro		03.2005		13.0460-0023.2	610023	ACCES. JEUX PLAQ.	3D0 615 231	



					description	Références OE par référence ATE.		Références remplacées / divers
--	--	--	--	--	-------------	----------------------------------	--	--------------------------------

AUDI

A6 (C6) Avant (05-)	S6		03.2006		13.0460-0023.2	610023	ACCES. JEUX PLAQ.	3D0 615 231	
A6 (C6) Berline (04-)	2,0 TDI		06.2005		13.0460-0023.2	610023	ACCES. JEUX PLAQ.	3D0 615 231	
			07.2004		13.0460-0023.2	610023	ACCES. JEUX PLAQ.	3D0 615 231	
	2,0 TFSI		06.2005		13.0460-0023.2	610023	ACCES. JEUX PLAQ.	3D0 615 231	
	2,4		04.2004		13.0460-0023.2	610023	ACCES. JEUX PLAQ.	3D0 615 231	
	2,4 Quattro		01.2005		13.0460-0023.2	610023	ACCES. JEUX PLAQ.	3D0 615 231	
	2,7 TDI		11.2004		13.0460-0023.2	610023	ACCES. JEUX PLAQ.	3D0 615 231	
	2,7 TDI Quattro		06.2005		13.0460-0023.2	610023	ACCES. JEUX PLAQ.	3D0 615 231	
			11.2004		13.0460-0023.2	610023	ACCES. JEUX PLAQ.	3D0 615 231	
	2,8 FSI		11.2006		13.0460-0023.2	610023	ACCES. JEUX PLAQ.	3D0 615 231	
	2,8 FSI Quattro		04.2007		13.0460-0023.2	610023	ACCES. JEUX PLAQ.	3D0 615 231	
	3		04.2004		13.0460-0023.2	610023	ACCES. JEUX PLAQ.	3D0 615 231	
	3,0 Quattro		04.2004		13.0460-0023.2	610023	ACCES. JEUX PLAQ.	3D0 615 231	
	3,0 TDI Quattro		06.2006		13.0460-0023.2	610023	ACCES. JEUX PLAQ.	3D0 615 231	
			04.2004		13.0460-0023.2	610023	ACCES. JEUX PLAQ.	3D0 615 231	
	3,2 FSI		04.2004		13.0460-0023.2	610023	ACCES. JEUX PLAQ.	3D0 615 231	
	3,2 FSI Quattro		04.2004		13.0460-0023.2	610023	ACCES. JEUX PLAQ.	3D0 615 231	
	4,2 FSI Quattro		06.2006		13.0460-0023.2	610023	ACCES. JEUX PLAQ.	3D0 615 231	
	4,2 Quattro		04.2004		13.0460-0023.2	610023	ACCES. JEUX PLAQ.	3D0 615 231	

Nouvelles références disponibles - par applications

04/2008



				description	Références OE par référence ATE.		Références remplacées / divers
--	--	--	--	-------------	----------------------------------	--	--------------------------------

AUDI

A6 (C6) Berline (04-)	S6		03.2006		13.0460-0023.2	610023	ACCES. JEUX PLAQ.	3D0 615 231	
A6 Allroad (06-)	2,7 TDI		05.2006		13.0460-0023.2	610023	ACCES. JEUX PLAQ.	3D0 615 231	
	3,0 TDI		05.2006		13.0460-0023.2	610023	ACCES. JEUX PLAQ.	3D0 615 231	
	3,2 FSI		05.2006		13.0460-0023.2	610023	ACCES. JEUX PLAQ.	3D0 615 231	
	4,2 FSI		05.2006		13.0460-0023.2	610023	ACCES. JEUX PLAQ.	3D0 615 231	
A8 (03-)	2,8 FSI		08.2007		13.0460-0023.2	610023	ACCES. JEUX PLAQ.	3D0 615 231	
	3		07.2003		13.0460-0023.2	610023	ACCES. JEUX PLAQ.	3D0 615 231	
	3,0 TDI Quattro		11.2003		13.0460-0023.2	610023	ACCES. JEUX PLAQ.	3D0 615 231	
	3,2 FSI		06.2005		13.0460-0023.2	610023	ACCES. JEUX PLAQ.	3D0 615 231	
	3,2 FSI Quattro		06.2005		13.0460-0023.2	610023	ACCES. JEUX PLAQ.	3D0 615 231	
	3,7 Quattro		11.2002		13.0460-0023.2	610023	ACCES. JEUX PLAQ.	3D0 615 231	
	4,0 TDI Quattro		03.2003		13.0460-0023.2	610023	ACCES. JEUX PLAQ.	3D0 615 231	
	4,2 FSI Quattro		06.2006		13.0460-0023.2	610023	ACCES. JEUX PLAQ.	3D0 615 231	
	4,2 Quattro		11.2002		13.0460-0023.2	610023	ACCES. JEUX PLAQ.	3D0 615 231	
	4,2 TDI Quattro		07.2005		13.0460-0023.2	610023	ACCES. JEUX PLAQ.	3D0 615 231	
	6,0 W12 Quattro		02.2004		13.0460-0023.2	610023	ACCES. JEUX PLAQ.	3D0 615 231	
	S8		06.2006		13.0460-0023.2	610023	ACCES. JEUX PLAQ.	3D0 615 231	
TT Coupe (06-)	3,2 Quattro		07.2006		13.0460-0035.2	610035	ACCES. JEUX PLAQ.	8P0 615 231	
TT Roadster (07-)			02.2007		13.0460-0035.2	610035	ACCES. JEUX PLAQ.	8P0 615 231	

Nouvelles références disponibles - par applications

04/2008



					description	Références OE par référence ATE.		Références remplacées / divers
--	--	--	--	--	-------------	----------------------------------	--	--------------------------------







BMW

Série 3/E36 (91-00)	M3 3,0	AvG	06.1994	08.1995	24.0128-0198.1	428198	DISQUE DE FREIN GAUCHE	34 11 2 227 171	
		AvD	06.1994	08.1995	24.0128-0199.1	428199	DISQUE DE FREIN DROIT	34 11 2 227 172	
	M3 Cabrio 3,0	AvG	11.1993	08.1995	24.0128-0198.1	428198	DISQUE DE FREIN GAUCHE	34 11 2 227 171	
		AvD	11.1993	08.1995	24.0128-0199.1	428199	DISQUE DE FREIN DROIT	34 11 2 227 172	
	M3 Coupe 3,0	AvG	03.1992	08.1995	24.0128-0198.1	428198	DISQUE DE FREIN GAUCHE	34 11 2 227 171	
		AvD	03.1992	08.1995	24.0128-0199.1	428199	DISQUE DE FREIN DROIT	34 11 2 227 172	
Série 3/E90 Berline (05-)	320 d		09.2007		24.8190-0251.2	620251	TEMOIN D'USURE	34 35 6 779 619	
			12.2004	08.2007	24.8190-0251.2	620251	TEMOIN D'USURE	34 35 6 779 619	
	320 i		03.2007	08.2007	24.8190-0251.2	620251	TEMOIN D'USURE	34 35 6 779 619	
			09.2007		24.8190-0251.2	620251	TEMOIN D'USURE	34 35 6 779 619	
	325 i		12.2004		24.8190-0251.2	620251	TEMOIN D'USURE	34 35 6 779 619	
			12.2004	08.2007	24.8190-0251.2	620251	TEMOIN D'USURE	34 35 6 779 619	
			09.2007		24.8190-0251.2	620251	TEMOIN D'USURE	34 35 6 779 619	
	330 d		09.2005	08.2007	24.8190-0251.2	620251	TEMOIN D'USURE	34 35 6 779 619	
	330 i		12.2004	08.2007	24.8190-0251.2	620251	TEMOIN D'USURE	34 35 6 779 619	
Série 3/E91 Touring (05-)	318 d		09.2007		24.8190-0251.2	620251	TEMOIN D'USURE	34 35 6 779 619	
	318 i		09.2007		24.8190-0251.2	620251	TEMOIN D'USURE	34 35 6 779 619	
			03.2007	08.2007	24.8190-0251.2	620251	TEMOIN D'USURE	34 35 6 779 619	
	320 d		09.2007		24.8190-0251.2	620251	TEMOIN D'USURE	34 35 6 779 619	

Nouvelles références disponibles - par applications

04/2008



					description	Références OE par référence ATE.		Références remplacées / divers
---	---	---	---	---	-------------	----------------------------------	---	--------------------------------







BMW

Série 3/E91 Touring (05-)	320 i		09.2007		24.8190-0251.2	620251	TEMOIN D'USURE	34 35 6 779 619	
			06.2005	08.2007	24.8190-0251.2	620251	TEMOIN D'USURE	34 35 6 779 619	
	325 d		09.2006		24.8190-0251.2	620251	TEMOIN D'USURE	34 35 6 779 619	
	325 i		03.2007		24.8190-0251.2	620251	TEMOIN D'USURE	34 35 6 779 619	
			09.2007		24.8190-0251.2	620251	TEMOIN D'USURE	34 35 6 779 619	
	330 d		09.2007		24.8190-0251.2	620251	TEMOIN D'USURE	34 35 6 779 619	
	330 i		09.2007		24.8190-0251.2	620251	TEMOIN D'USURE	34 35 6 779 619	
	335 xi		03.2007		24.8190-0251.2	620251	TEMOIN D'USURE	34 35 6 779 619	
Série 3/E92 Coupé (06-)	320 d		03.2007		24.8190-0251.2	620251	TEMOIN D'USURE	34 35 6 779 619	
	325 i		09.2007		24.8190-0251.2	620251	TEMOIN D'USURE	34 35 6 779 619	
	325 xi		09.2007		24.8190-0251.2	620251	TEMOIN D'USURE	34 35 6 779 619	
Série 3/E93 Décapotable (07-)	320 d		03.2008		24.8190-0251.2	620251	TEMOIN D'USURE	34 35 6 779 619	
	320 i		03.2007	02.2008	24.8190-0251.2	620251	TEMOIN D'USURE	34 35 6 779 619	
	325 i		03.2007		24.8190-0251.2	620251	TEMOIN D'USURE	34 35 6 779 619	
Série 5/E61 Touring (04-)	M5	AvD	02.2007		24.8190-0248.2	620248	TEMOIN D'USURE	34 35 2 282 935	
Série 6/E63 Coupé (04-)	M6	AvD	06.2005		24.8190-0248.2	620248	TEMOIN D'USURE	34 35 2 282 935	
Série 6/E64 Décapotable (04-)		AvD	07.2006		24.8190-0248.2	620248	TEMOIN D'USURE	34 35 2 282 935	
X3 (03-)	3,0 sd		09.2006		24.8190-0254.2	620254	TEMOIN D'USURE	34 35 3 414 662	
X5 (00-06)	3,0 d		10.2003	03.2007	24.3727-0231.2	580231	CABLE FREIN A MAIN	34 41 1 165 699	

Nouvelles références disponibles - par applications

04/2008



					description	Références OE par référence ATE.		Références remplacées / divers
---	---	---	---	---	-------------	----------------------------------	---	--------------------------------

BMW

X5 (00-06)	3,0 d		05.2001	09.2003	24.3727-0231.2	580231	CABLE FREIN A MAIN	34 41 1 165 699	
	3,0 i		04.2000	03.2007	24.3727-0231.2	580231	CABLE FREIN A MAIN	34 41 1 165 699	
	4,4 i		04.2000	09.2003	24.3727-0231.2	580231	CABLE FREIN A MAIN	34 41 1 165 699	
			10.2003	03.2007	24.3727-0231.2	580231	CABLE FREIN A MAIN	34 41 1 165 699	
	4,6 iS		12.2001	09.2003	24.3727-0231.2	580231	CABLE FREIN A MAIN	34 41 1 165 699	
	4,8 iS		03.2004	03.2007	24.3727-0231.2	580231	CABLE FREIN A MAIN	34 41 1 165 699	

CHEVROLET

EPICA (06-)	2,0 i V6		06.2006		24.0124-0199.1	424199	DISQUE DE FREIN	96549782 , 96264591 , 96328338	
	2,5 i V6		06.2006		24.0124-0199.1	424199	DISQUE DE FREIN	96549782 , 96264591 , 96328338	
EVANDA (05-)	2,0 i 16V		03.2005		24.0124-0199.1	424199	DISQUE DE FREIN	96549782 , 96264591 , 96328338	
LACETTI (05-)	1,4 i 16V		03.2005		24.0124-0199.1	424199	DISQUE DE FREIN	96549782 , 96264591 , 96328338	
	1,6 i 16V		03.2005		24.0124-0199.1	424199	DISQUE DE FREIN	96549782 , 96264591 , 96328338	
	1,8 i 16V		03.2005		24.0124-0199.1	424199	DISQUE DE FREIN	96549782 , 96264591 , 96328338	
REZZO (05-)	1,6 i		03.2005		24.0124-0199.1	424199	DISQUE DE FREIN	96549782 , 96264591 , 96328338	
	2,0 i 16V		03.2005		24.0124-0199.1	424199	DISQUE DE FREIN	96549782 , 96264591 , 96328338	









					description	Références OE par référence ATE.		Références remplacées / divers
--	--	--	--	--	-------------	----------------------------------	--	--------------------------------

CITROEN

C2 (03-)	1,1 i	AvD	09.2003		24.3481-1762.5	240394	ETRIER A GRIFFE	4401 E1	
		AvG	09.2003		24.3481-1761.5	240393	ETRIER A GRIFFE	4401 E0	
	1,4 HDi	AvG	09.2003		24.3481-1761.5	240393	ETRIER A GRIFFE	4401 E0	
		AvD	09.2003		24.3481-1762.5	240394	ETRIER A GRIFFE	4401 E1	
	1,4 i	AvG	09.2003		24.3481-1761.5	240393	ETRIER A GRIFFE	4401 E0	
		AvD	09.2003		24.3481-1762.5	240394	ETRIER A GRIFFE	4401 E1	
C3 (02-)	1,1 i	AvD	02.2002		24.3481-1762.5	240394	ETRIER A GRIFFE	4401 E1	
		AvG	02.2002		24.3481-1761.5	240393	ETRIER A GRIFFE	4401 E0	
	1,4 HDi	AvD	02.2002		24.3481-1762.5	240394	ETRIER A GRIFFE	4401 E1	
		AvG	02.2002		24.3481-1761.5	240393	ETRIER A GRIFFE	4401 E0	
	1,4 i	AvG	02.2002		24.3481-1761.5	240393	ETRIER A GRIFFE	4401 E0	
		AvD	02.2002		24.3481-1762.5	240394	ETRIER A GRIFFE	4401 E1	



					description	Références OE par référence ATE.		Références remplacées / divers
---	---	---	---	---	-------------	----------------------------------	---	--------------------------------

DAEWOO

Modèle	Motorisation	Année	Année	Code ATE	Code ATE	Description	Références OE par référence ATE.	Références remplacées / divers
EVANDA (02-05)	2,0 i 16V	08.2002	02.2005	24.0124-0199.1	424199	DISQUE DE FREIN	96549782 , 96264591 , 96328338	
LACETTI (04-05)	1,4 i 16V	02.2004	02.2005	24.0124-0199.1	424199	DISQUE DE FREIN	96549782 , 96264591 , 96328338	
	1,6 i 16V	02.2004	02.2005	24.0124-0199.1	424199	DISQUE DE FREIN	96549782 , 96264591 , 96328338	
	1,8 i 16V	02.2004	02.2005	24.0124-0199.1	424199	DISQUE DE FREIN	96549782 , 96264591 , 96328338	
MAGNUS (99-)	2	07.1999		24.0124-0199.1	424199	DISQUE DE FREIN	96549782 , 96264591 , 96328338	
REZZO (00-05)	1,6 i 16V	09.2000	02.2005	24.0124-0199.1	424199	DISQUE DE FREIN	96549782 , 96264591 , 96328338	
	1,8 i	09.2000	02.2005	24.0124-0199.1	424199	DISQUE DE FREIN	96549782 , 96264591 , 96328338	
	2,0 i 16V	09.2000	02.2005	24.0124-0199.1	424199	DISQUE DE FREIN	96549782 , 96264591 , 96328338	
TACUMA (00-05)	1,6 i 16V	09.2000	02.2005	24.0124-0199.1	424199	DISQUE DE FREIN	96549782 , 96264591 , 96328338	
	1,8 i	09.2000	02.2005	24.0124-0199.1	424199	DISQUE DE FREIN	96549782 , 96264591 , 96328338	
	2,0 i 16V	09.2000	02.2005	24.0124-0199.1	424199	DISQUE DE FREIN	96549782 , 96264591 , 96328338	

Nouvelles références disponibles - par applications

04/2008



					description	Références OE par référence ATE.		Références remplacées / divers
--	--	--	--	--	-------------	----------------------------------	--	--------------------------------

FIAT

DOBLO (01-)	1,3 JTD		10.2005		24.3220-1728.3	020509	CYLINDRE DE ROUE	77363849 , 47550-09100	
	1,4 i		10.2005		24.3220-1728.3	020509	CYLINDRE DE ROUE	77363849 , 47550-09100	
	1,6 i 16V		10.2005		24.3220-1728.3	020509	CYLINDRE DE ROUE	77363849 , 47550-09100	
	1,9 JTD		10.2005		24.3220-1728.3	020509	CYLINDRE DE ROUE	77363849 , 47550-09100	
FIORINO (08-)	1,3 JTD		02.2008		24.3220-1728.3	020509	CYLINDRE DE ROUE	77363849 , 47550-09100	
	1,4 i		02.2008		24.3220-1728.3	020509	CYLINDRE DE ROUE	77363849 , 47550-09100	
GRANDE PUNTO (06-)	1,2 i		10.2005	06.2007	24.0220-3035.1	480300	TAMBOUR DE FREIN	55703042 , 55701379 , 5 68 269	
			10.2005		24.3220-1728.3	020509	CYLINDRE DE ROUE	77363849 , 47550-09100	
	1,3 JTD		10.2005		03.0520-9020.3	699020	ATE TOPKIT		
			10.2005		24.0222-8037.1	480302	TAMBOUR DE FREIN	55703043 , 55701380 , 5 68 270	
			10.2005		24.3220-1728.3	020509	CYLINDRE DE ROUE	77363849 , 47550-09100	
	1,4 i		10.2005		03.0520-9020.3	699020	ATE TOPKIT		
			10.2005		24.0222-8037.1	480302	TAMBOUR DE FREIN	55703043 , 55701380 , 5 68 270	
			10.2005		24.3220-1728.3	020509	CYLINDRE DE ROUE	77363849 , 47550-09100	
	1,4 i 16V		02.2006		03.0520-9020.3	699020	ATE TOPKIT		
			02.2006		24.0222-8037.1	480302	TAMBOUR DE FREIN	55703043 , 55701380 , 5 68 270	
			02.2006		24.3220-1728.3	020509	CYLINDRE DE ROUE	77363849 , 47550-09100	
IDEA (04-)	1,2 i 16V		07.2005		24.3222-1725.3	020510	CYLINDRE DE ROUE	77364028	

Nouvelles références disponibles - par applications

04/2008



					description	Références OE par référence ATE.		Références remplacées / divers
--	--	--	--	--	-------------	----------------------------------	--	--------------------------------

FIAT

IDEA (04-)	1,3 JTD		11.2005		03.0520-9120.3	699120	ATE TOPKIT	
			07.2005		24.3222-1725.3	020510	CYLINDRE DE ROUE	77364028
			11.2005		24.3220-1728.3	020509	CYLINDRE DE ROUE	77363849 , 47550-09100
	1,4 i		11.2005		24.3222-1725.3	020510	CYLINDRE DE ROUE	77364028
	1,4 i 16V		07.2005		24.3222-1725.3	020510	CYLINDRE DE ROUE	77364028
	1,9 JTD		07.2005		03.0520-9120.3	699120	ATE TOPKIT	
			07.2005		24.3220-1728.3	020509	CYLINDRE DE ROUE	77363849 , 47550-09100
LINEA (07-)	1,3 JTD		07.2007		24.3220-1728.3	020509	CYLINDRE DE ROUE	77363849 , 47550-09100
	1,4 i		07.2007		24.3220-1728.3	020509	CYLINDRE DE ROUE	77363849 , 47550-09100
PANDA (03-)	1,1 i	ArD	09.2003		24.3727-0557.2	580557	CABLE FREIN A MAIN	51708685
		ArG	09.2003		24.3727-0556.2	580556	CABLE FREIN A MAIN	51708686
	1,2 i	ArD	09.2003		24.3727-0557.2	580557	CABLE FREIN A MAIN	51708685
		ArG	09.2003		24.3727-0556.2	580556	CABLE FREIN A MAIN	51708686
	1,3 JTD	ArD	09.2003		24.3727-0557.2	580557	CABLE FREIN A MAIN	51708685
		ArG	09.2003		24.3727-0556.2	580556	CABLE FREIN A MAIN	51708686



					description	Références OE par référence ATE.		Références remplacées / divers
--	--	--	--	--	-------------	----------------------------------	--	--------------------------------

FORD

FIESTA V (02-)	1,25 i 16V		03.2003		24.3727-0658.2	580658	CABLE FREIN A MAIN	1205735	
			05.2002		24.3727-0658.2	580658	CABLE FREIN A MAIN	1205735	
	1,3 i		04.2002		24.3727-0658.2	580658	CABLE FREIN A MAIN	1205735	
	1,4 i 16V		04.2002		24.3727-0658.2	580658	CABLE FREIN A MAIN	1205735	
	1,4 TDCi		04.2002		24.3727-0658.2	580658	CABLE FREIN A MAIN	1205735	
	1,6 i 16V		04.2002		24.3727-0658.2	580658	CABLE FREIN A MAIN	1205735	
	1,6 TDCi		10.2004		24.3727-0658.2	580658	CABLE FREIN A MAIN	1205735	
FUSION (02-)	1,25 i 16V		08.2004		24.3727-0658.2	580658	CABLE FREIN A MAIN	1205735	
	1,4 i 16V		07.2002		24.3727-0658.2	580658	CABLE FREIN A MAIN	1205735	
	1,4 TDCi		07.2002		24.3727-0658.2	580658	CABLE FREIN A MAIN	1205735	
	1,6 i 16V		07.2002		24.3727-0658.2	580658	CABLE FREIN A MAIN	1205735	
	1,6 TDCi		10.2004		24.3727-0658.2	580658	CABLE FREIN A MAIN	1205735	
MONDEO III (01-06)	1,8 i 16V		09.2004	03.2007	13.0460-3831.2	603831	PLAQUETTES DE FREIN	1356392	cf. Photo
		AvG	10.2000	03.2007	24.3571-1735.5	240385	ETRIER A GRIFFE	1123895	
		AvD	10.2000	03.2007	24.3571-1736.5	240386	ETRIER A GRIFFE	1123892	
	1,8 SCi		09.2004	03.2007	13.0460-3831.2	603831	PLAQUETTES DE FREIN	1356392	cf. Photo
		AvD	06.2003	03.2007	24.3571-1736.5	240386	ETRIER A GRIFFE	1123892	
		AvG	06.2003	03.2007	24.3571-1735.5	240385	ETRIER A GRIFFE	1123895	
	2,0 DI		09.2004	03.2007	13.0460-3831.2	603831	PLAQUETTES DE FREIN	1356392	cf. Photo

Nouvelles références disponibles - par applications

04/2008



					description	Références OE par référence ATE.		Références remplacées / divers
--	--	--	--	--	-------------	----------------------------------	--	--------------------------------

FORD

MONDEO III (01-06)	2,0 DI	AvD	10.2000	03.2007	24.3571-1736.5	240386	ETRIER A GRIFFE	1123892	
		AvG	10.2000	03.2007	24.3571-1735.5	240385	ETRIER A GRIFFE	1123895	
	2,0 i 16V		09.2004	03.2007	13.0460-3831.2	603831	PLAQUETTES DE FREIN	1356392	cf. Photo
		AvG	10.2000	03.2007	24.3571-1735.5	240385	ETRIER A GRIFFE	1123895	
		AvD	10.2000	03.2007	24.3571-1736.5	240386	ETRIER A GRIFFE	1123892	
	2,0 TDCi		09.2004	03.2007	13.0460-3831.2	603831	PLAQUETTES DE FREIN	1356392	cf. Photo
		AvD	10.2001	03.2007	24.3571-1736.5	240386	ETRIER A GRIFFE	1123892	
		AvG	10.2001	03.2007	24.3571-1735.5	240385	ETRIER A GRIFFE	1123895	
	2,2 TDCi		09.2004	03.2007	13.0460-3831.2	603831	PLAQUETTES DE FREIN	1356392	cf. Photo
		AvD	09.2004	03.2007	24.3571-1736.5	240386	ETRIER A GRIFFE	1123892	
		AvG	09.2004	03.2007	24.3571-1735.5	240385	ETRIER A GRIFFE	1123895	
	2,5 i V6		09.2004	03.2007	13.0460-3831.2	603831	PLAQUETTES DE FREIN	1356392	cf. Photo
		AvD	10.2000	03.2007	24.3571-1736.5	240386	ETRIER A GRIFFE	1123892	
		AvG	10.2000	03.2007	24.3571-1735.5	240385	ETRIER A GRIFFE	1123895	
	3,0 i V6		09.2004	03.2007	13.0460-3831.2	603831	PLAQUETTES DE FREIN	1356392	cf. Photo
		AvD	09.2004	03.2007	24.3571-1736.5	240386	ETRIER A GRIFFE	1123892	
		AvG	09.2004	03.2007	24.3571-1735.5	240385	ETRIER A GRIFFE	1123895	
	ST 220		09.2004	03.2007	13.0460-3831.2	603831	PLAQUETTES DE FREIN	1356392	cf. Photo
		AvG	04.2002	03.2007	24.3571-1735.5	240385	ETRIER A GRIFFE	1123895	



	i			description	Références OE par référence ATE.	i Références remplacées / divers
--	----------	--	--	-------------	----------------------------------	--







FORD

MONDEO III (01-06)	ST 220	AvD	04.2002	03.2007	24.3571-1736.5	240386	ETRIER A GRIFFE	1123892	
--------------------	--------	-----	---------	---------	----------------	--------	-----------------	---------	--

HONDA

ACCORD (98-02)	1,6 i 16V (CG7)		10.1998	12.2002	24.3220-1731.3	020503	CYLINDRE DE ROUE	43301-S1A-E61 , 43300-S1A-E61	
	1,6 i 16V (CH5)		10.1998	12.2002	24.3220-1731.3	020503	CYLINDRE DE ROUE	43301-S1A-E61 , 43300-S1A-E61	
CR-V II (02-06)	2,0 i 16V		07.2002	09.2006	24.0109-0151.1	409151	DISQUE DE FREIN	42510-SCA-E50	24.0110-0322.1
	2,2 CTDi		02.2005	09.2006	24.0109-0151.1	409151	DISQUE DE FREIN	42510-SCA-E50	24.0110-0322.1
	2,4 VTEC		03.2002	09.2006	24.0109-0151.1	409151	DISQUE DE FREIN	42510-SCA-E50	24.0110-0322.1



					description	Références OE par référence ATE.		Références remplacées / divers
---	---	---	---	---	-------------	----------------------------------	---	--------------------------------

HYUNDAI

ACCENT (94-99)	1,3 i	ArD	10.1994	12.1999	24.3219-1748.3	020499	CYLINDRE DE ROUE	58380-22000	
		ArG	10.1994	12.1999	24.3219-1747.3	020498	CYLINDRE DE ROUE	58330-22000	
	1,3 i 12V	ArD	10.1994	12.1999	24.3219-1748.3	020499	CYLINDRE DE ROUE	58380-22000	
		ArG	10.1994	12.1999	24.3219-1747.3	020498	CYLINDRE DE ROUE	58330-22000	
	1,5 i 12V	ArD	10.1994	12.1999	24.3219-1748.3	020499	CYLINDRE DE ROUE	58380-22000	
		ArG	10.1994	12.1999	24.3219-1747.3	020498	CYLINDRE DE ROUE	58330-22000	
	1,5 i 16V	ArD	10.1995	12.1999	24.3219-1748.3	020499	CYLINDRE DE ROUE	58380-22000	
		ArG	10.1995	12.1999	24.3219-1747.3	020498	CYLINDRE DE ROUE	58330-22000	
ATOS / AMICA (GB) (98-)	1,0 i 12V	ArG	09.2000		24.3727-3101.2	583101	CABLE FREIN A MAIN	59760-02010 , 59760-02020	
		ArG	01.1998	08.2000	24.3727-3101.2	583101	CABLE FREIN A MAIN	59760-02010 , 59760-02020	
	1,0 i 12V Prime	ArG	09.1999		24.3727-3101.2	583101	CABLE FREIN A MAIN	59760-02010 , 59760-02020	
		ArG	09.2000		24.3727-3101.2	583101	CABLE FREIN A MAIN	59760-02010 , 59760-02020	
	1,1 i 12V	ArG	03.2004		24.3727-3101.2	583101	CABLE FREIN A MAIN	59760-02010 , 59760-02020	
	1,1 i 12V Prime	ArG	08.2003		24.3727-3101.2	583101	CABLE FREIN A MAIN	59760-02010 , 59760-02020	
H-1 Fourgonnette (00-)	2,4		11.2001		03.0137-0488.2	650488	JEU DE MACHOIRE	58305-4AA00	
			03.2000		03.0137-0488.2	650488	JEU DE MACHOIRE	58305-4AA00	
	2,4 4x4		03.2000		03.0137-0488.2	650488	JEU DE MACHOIRE	58305-4AA00	
	2,5 CRDi		08.2003		03.0137-0488.2	650488	JEU DE MACHOIRE	58305-4AA00	
	2,5 TDiC		03.2000	09.2000	03.0137-0488.2	650488	JEU DE MACHOIRE	58305-4AA00	



					description	Références OE par référence ATE.		Références remplacées / divers
--	--	--	--	--	-------------	----------------------------------	--	--------------------------------

HYUNDAI

Modèle	Motorisation	Année	Année	ATE	ATE	Description	Références OE	Références ATE
H-1 Fourgonnette (00-)	2,5 TDiC	03.2000		03.0137-0488.2	650488	JEU DE MACHOIRE	58305-4AA00	
STAREX (H1) (97-)	2,4	06.1997	09.2003	03.0137-0488.2	650488	JEU DE MACHOIRE	58305-4AA00	
	2,4 4x4	02.1998	09.2003	03.0137-0488.2	650488	JEU DE MACHOIRE	58305-4AA00	
	2,5 CRDi	12.2002		03.0137-0488.2	650488	JEU DE MACHOIRE	58305-4AA00	
	2,5 CRDi 4x4	12.2002		03.0137-0488.2	650488	JEU DE MACHOIRE	58305-4AA00	
	2,5 TCI	06.2000		03.0137-0488.2	650488	JEU DE MACHOIRE	58305-4AA00	
	2,5 TDiC	06.1997	10.2002	03.0137-0488.2	650488	JEU DE MACHOIRE	58305-4AA00	
	2,5 TDiC 4x4	02.1998	10.2002	03.0137-0488.2	650488	JEU DE MACHOIRE	58305-4AA00	



	i				description	Références OE par référence ATE.	i Références remplacées / divers
--	----------	--	--	--	-------------	----------------------------------	--

LANCIA

MUSA (04-)	1,3 JTD		09.2006		03.0520-9120.3	699120	ATE TOPKIT	
			09.2006		24.3220-1728.3	020509	CYLINDRE DE ROUE	77363849 , 47550-09100
			07.2005		24.3222-1725.3	020510	CYLINDRE DE ROUE	77364028
	1,4 i		07.2005		24.3222-1725.3	020510	CYLINDRE DE ROUE	77364028
	1,4 i 16V		07.2005		24.3222-1725.3	020510	CYLINDRE DE ROUE	77364028
	1,9 JTD		07.2005		03.0520-9120.3	699120	ATE TOPKIT	
			07.2005		24.3220-1728.3	020509	CYLINDRE DE ROUE	77363849 , 47550-09100
YPSILON (03-)	1,2 i		06.2003		24.3727-3000.2	583000	CABLE FREIN A MAIN	46813948 , 51776180
	1,2 i 16V		06.2003		24.3727-3000.2	583000	CABLE FREIN A MAIN	46813948 , 51776180
	1,3 JTD		06.2003		24.3727-3000.2	583000	CABLE FREIN A MAIN	46813948 , 51776180
	1,4 i		02.2006		24.3727-3000.2	583000	CABLE FREIN A MAIN	46813948 , 51776180
	1,4 i 16V		06.2003		24.3727-3000.2	583000	CABLE FREIN A MAIN	46813948 , 51776180



					description	Références OE par référence ATE.		Références remplacées / divers
--	--	--	--	--	-------------	----------------------------------	--	--------------------------------

LAND ROVER

FREELANDER (LN) (98-07)	1,8i 16V			03.2007	03.0137-9282.2	669282	ACC. MACHOIRE	SMN100250 , SMN000020	
			02.1998		03.0137-9282.2	669282	ACC. MACHOIRE	SMN100250 , SMN000020	
				03.2007	24.3219-1746.3	020497	CYLINDRE DE ROUE	SML000010	
	2,0 DI		02.1998		03.0137-9282.2	669282	ACC. MACHOIRE	SMN100250 , SMN000020	
				03.2007	03.0137-9282.2	669282	ACC. MACHOIRE	SMN100250 , SMN000020	
				03.2007	24.3219-1746.3	020497	CYLINDRE DE ROUE	SML000010	
	2,0 TD4		11.2000		03.0137-9282.2	669282	ACC. MACHOIRE	SMN100250 , SMN000020	
				03.2007	03.0137-9282.2	669282	ACC. MACHOIRE	SMN100250 , SMN000020	
				03.2007	24.3219-1746.3	020497	CYLINDRE DE ROUE	SML000010	
	2,5 V6		11.2000		03.0137-9282.2	669282	ACC. MACHOIRE	SMN100250 , SMN000020	
				03.2007	03.0137-9282.2	669282	ACC. MACHOIRE	SMN100250 , SMN000020	
				03.2007	24.3219-1746.3	020497	CYLINDRE DE ROUE	SML000010	

LEXUS

RX 300 (00-06)	3,0 i V6 4WD (MCU15)		10.2000	04.2003	24.0110-0712.1	410712	DISQUE DE FREIN	42431-48010 , 42431-48020 , 42431-33080 , 42431-33140	
----------------	----------------------	--	---------	---------	----------------	--------	-----------------	---	--



						description	Références OE par référence ATE.		Références remplacées / divers
--	--	--	--	--	--	-------------	----------------------------------	--	--------------------------------

MAZDA

323 Berline/323 C/323 F/323 S (94-98)	1,3 i 16V (BA1)	ArG	05.1994	08.1998	24.3727-1817.2	581817	CABLE FREIN A MAIN	BC1D-44-420A , BC1D-44-420B , BC1D-44-420C	
		ArG	05.1994	08.1998	24.3727-1819.2	581819	CABLE FREIN A MAIN	BC1B-44-420 , BC1B-44-420A	
		ArD	05.1994	08.1998	24.3727-1816.2	581816	CABLE FREIN A MAIN	BC1D-44-410A , BC1D-44-410B	
		ArD	05.1994	08.1998	24.3727-1818.2	581818	CABLE FREIN A MAIN	BC1B-44-410 , BC1B-44-410A	
	1,5 i 16V (BA1)	ArD	05.1994	08.1998	24.3727-1816.2	581816	CABLE FREIN A MAIN	BC1D-44-410A , BC1D-44-410B	
		ArG	05.1994	08.1998	24.3727-1819.2	581819	CABLE FREIN A MAIN	BC1B-44-420 , BC1B-44-420A	
		ArG	05.1994	08.1998	24.3727-1817.2	581817	CABLE FREIN A MAIN	BC1D-44-420A , BC1D-44-420B , BC1D-44-420C	
		ArD	05.1994	08.1998	24.3727-1818.2	581818	CABLE FREIN A MAIN	BC1B-44-410 , BC1B-44-410A	
	1,7 D (BA1)	ArG	05.1994	08.1998	24.3727-1817.2	581817	CABLE FREIN A MAIN	BC1D-44-420A , BC1D-44-420B , BC1D-44-420C	
		ArD	05.1994	08.1998	24.3727-1816.2	581816	CABLE FREIN A MAIN	BC1D-44-410A , BC1D-44-410B	
	1,8 i (BA1)	ArG	05.1994	08.1998	24.3727-1817.2	581817	CABLE FREIN A MAIN	BC1D-44-420A , BC1D-44-420B , BC1D-44-420C	
		ArD	05.1994	08.1998	24.3727-1816.2	581816	CABLE FREIN A MAIN	BC1D-44-410A , BC1D-44-410B	
		ArD	05.1994	08.1998	24.3727-1818.2	581818	CABLE FREIN A MAIN	BC1B-44-410 , BC1B-44-410A	
		ArG	05.1994	08.1998	24.3727-1819.2	581819	CABLE FREIN A MAIN	BC1B-44-420 , BC1B-44-420A	
	2,0 D	ArD	10.1996	08.1998	24.3727-1816.2	581816	CABLE FREIN A MAIN	BC1D-44-410A , BC1D-44-410B	



					description	Références OE par référence ATE.		Références remplacées / divers
--	--	--	--	--	-------------	----------------------------------	--	--------------------------------

MAZDA

323 Berline/323 C/323 F/323 S (94-98)	2,0 D	ArG	10.1996	08.1998	24.3727-1817.2	581817	CABLE FREIN A MAIN	BC1D-44-420A , BC1D-44-420B , BC1D-44-420C
626 Break (98-02)	1,8 i 16V (GW)	ArG	02.1998	12.1999	24.3354-1701.5	240347	ETRIER A GRIFFE	GEZC-26-99Z , GE7C-26-990B , GE7C-26-990C , GEZC-26-99ZA , GFYP-26-99Z , GFYP-26-99ZA
		ArD	02.1998	12.1999	24.3354-1702.5	240348	ETRIER A GRIFFE	GEZC-26-98Z , GE7C-26-980B , GE7C-26-980C , GEZC-26-98ZA , GFYP-26-98Z , GFYP-26-98ZA
	2,0 i 16V (GW)	ArD	02.1998	09.1999	24.3354-1702.5	240348	ETRIER A GRIFFE	GEZC-26-98Z , GE7C-26-980B , GE7C-26-980C , GEZC-26-98ZA , GFYP-26-98Z , GFYP-26-98ZA
		ArG	02.1998	09.1999	24.3354-1701.5	240347	ETRIER A GRIFFE	GEZC-26-99Z , GE7C-26-990B , GE7C-26-990C , GEZC-26-99ZA , GFYP-26-99Z , GFYP-26-99ZA
PREMACY (99-05)	1,8 i 16V	ArD	08.2001	02.2005	24.3354-1702.5	240348	ETRIER A GRIFFE	GEZC-26-98Z , GE7C-26-980B , GE7C-26-980C , GEZC-26-98ZA , GFYP-26-98Z , GFYP-26-98ZA
		ArG	08.2001	02.2005	24.3354-1701.5	240347	ETRIER A GRIFFE	GEZC-26-99Z , GE7C-26-990B , GE7C-26-990C , GEZC-26-99ZA , GFYP-26-99Z , GFYP-26-99ZA
	2,0 DITD	ArD	08.2001	02.2005	24.3354-1702.5	240348	ETRIER A GRIFFE	GEZC-26-98Z , GE7C-26-980B , GE7C-26-980C , GEZC-26-98ZA , GFYP-26-98Z , GFYP-26-98ZA



				description	Références OE par référence ATE.	Références remplacées / divers
--	--	--	--	-------------	--	-----------------------------------







MAZDA

PREMACY (99-05)	2,0 DiTD	ArG	08.2001	02.2005	24.3354-1701.5	240347	ETRIER A GRIFFE	GEZC-26-99Z , GE7C-26-990B , GE7C-26-990C , GEZC-26-99ZA , GFYP-26-99Z , GFYP-26-99ZA	
	2,0 i 16V	ArG	11.2001	02.2005	24.3354-1701.5	240347	ETRIER A GRIFFE	GEZC-26-99Z , GE7C-26-990B , GE7C-26-990C , GEZC-26-99ZA , GFYP-26-99Z , GFYP-26-99ZA	
		ArD	11.2001	02.2005	24.3354-1702.5	240348	ETRIER A GRIFFE	GEZC-26-98Z , GE7C-26-980B , GE7C-26-980C , GEZC-26-98ZA , GFYP-26-98Z , GFYP-26-98ZA	

Nouvelles références disponibles - par applications

04/2008



					description	Références OE par référence ATE.		Références remplacées / divers
---	---	---	---	---	-------------	----------------------------------	---	--------------------------------

MERCEDES BENZ

Classe CLS (C219) Coupé (04-)	CLS 280	ArD	10.2007		24.3727-0448.2	580448	CABLE FREIN A MAIN	211 420 03 85	
			10.2007		24.3727-0447.2	580447	CABLE FREIN A MAIN	211 420 01 85	
	CLS 320 CDI	ArD	05.2005		24.3727-0448.2	580448	CABLE FREIN A MAIN	211 420 03 85	
			05.2005		24.3727-0447.2	580447	CABLE FREIN A MAIN	211 420 01 85	
	CLS 350	ArD	08.2004		24.3727-0448.2	580448	CABLE FREIN A MAIN	211 420 03 85	
			08.2004		24.3727-0447.2	580447	CABLE FREIN A MAIN	211 420 01 85	
	CLS 350 CGI	ArD	04.2006		24.3727-0448.2	580448	CABLE FREIN A MAIN	211 420 03 85	
			04.2006		24.3727-0447.2	580447	CABLE FREIN A MAIN	211 420 01 85	
	CLS 500	ArD	08.2004		24.3727-0448.2	580448	CABLE FREIN A MAIN	211 420 03 85	
		ArD	04.2006		24.3727-0448.2	580448	CABLE FREIN A MAIN	211 420 03 85	
			04.2006		24.3727-0447.2	580447	CABLE FREIN A MAIN	211 420 01 85	
			08.2004		24.3727-0447.2	580447	CABLE FREIN A MAIN	211 420 01 85	
	CLS 55 AMG	ArD	01.2005		24.3727-0448.2	580448	CABLE FREIN A MAIN	211 420 03 85	
			01.2005		24.3727-0447.2	580447	CABLE FREIN A MAIN	211 420 01 85	
	CLS 63 AMG		04.2006		24.3727-0447.2	580447	CABLE FREIN A MAIN	211 420 01 85	
		ArD	04.2006		24.3727-0448.2	580448	CABLE FREIN A MAIN	211 420 03 85	
Classe E (S211) Break (03-)	E 200 Kompressor	ArD	03.2003		24.3727-0448.2	580448	CABLE FREIN A MAIN	211 420 03 85	
	E 220 CDI	ArD	03.2003		24.3727-0448.2	580448	CABLE FREIN A MAIN	211 420 03 85	
	E 240	ArD	03.2003		24.3727-0448.2	580448	CABLE FREIN A MAIN	211 420 03 85	

Nouvelles références disponibles - par applications

04/2008



					description	Références OE par référence ATE.		Références remplacées / divers
--	--	--	--	--	-------------	----------------------------------	--	--------------------------------







MERCEDES BENZ

Classe E (S211) Break (03-)	E 240 4-Matic		07.2003		24.3727-0447.2	580447	CABLE FREIN A MAIN	211 420 01 85	
		ArD	07.2003		24.3727-0448.2	580448	CABLE FREIN A MAIN	211 420 03 85	
	E 270 CDI	ArD	03.2003		24.3727-0448.2	580448	CABLE FREIN A MAIN	211 420 03 85	
	E 280		05.2005		24.3727-0447.2	580447	CABLE FREIN A MAIN	211 420 01 85	
		ArD	05.2005		24.3727-0448.2	580448	CABLE FREIN A MAIN	211 420 03 85	
	E 280 4-Matic		05.2005		24.3727-0447.2	580447	CABLE FREIN A MAIN	211 420 01 85	
		ArD	05.2005		24.3727-0448.2	580448	CABLE FREIN A MAIN	211 420 03 85	
	E 280 CDI	ArD	05.2004		24.3727-0448.2	580448	CABLE FREIN A MAIN	211 420 03 85	
			05.2004		24.3727-0447.2	580447	CABLE FREIN A MAIN	211 420 01 85	
	E 280 CDI 4-Matic	ArD	05.2005		24.3727-0448.2	580448	CABLE FREIN A MAIN	211 420 03 85	
			05.2005		24.3727-0447.2	580447	CABLE FREIN A MAIN	211 420 01 85	
	E 320	ArD	03.2003		24.3727-0448.2	580448	CABLE FREIN A MAIN	211 420 03 85	
	E 320 4-Matic		07.2003		24.3727-0447.2	580447	CABLE FREIN A MAIN	211 420 01 85	
		ArD	07.2003		24.3727-0448.2	580448	CABLE FREIN A MAIN	211 420 03 85	
	E 320 CDI	ArD	03.2003		24.3727-0448.2	580448	CABLE FREIN A MAIN	211 420 03 85	
	E 320 CDI 4-Matic		05.2005		24.3727-0447.2	580447	CABLE FREIN A MAIN	211 420 01 85	
		ArD	05.2005		24.3727-0448.2	580448	CABLE FREIN A MAIN	211 420 03 85	
	E 350	ArD	12.2004		24.3727-0448.2	580448	CABLE FREIN A MAIN	211 420 03 85	
			12.2004		24.3727-0447.2	580447	CABLE FREIN A MAIN	211 420 01 85	

Nouvelles références disponibles - par applications

04/2008



					description	Références OE par référence ATE.		Références remplacées / divers
---	---	---	---	---	-------------	----------------------------------	---	--------------------------------

MERCEDES BENZ

Classe E (S211) Break (03-)	E 350 4-Matic		12.2004		24.3727-0447.2	580447	CABLE FREIN A MAIN	211 420 01 85	
		ArD	12.2004		24.3727-0448.2	580448	CABLE FREIN A MAIN	211 420 03 85	
	E 500		10.2003		24.3727-0447.2	580447	CABLE FREIN A MAIN	211 420 01 85	
		ArD	10.2003		24.3727-0448.2	580448	CABLE FREIN A MAIN	211 420 03 85	
	E 500 4-Matic	ArD	10.2003		24.3727-0448.2	580448	CABLE FREIN A MAIN	211 420 03 85	
			10.2003		24.3727-0447.2	580447	CABLE FREIN A MAIN	211 420 01 85	
	E 55 Kompressor AMG	ArD	07.2003		24.3727-0448.2	580448	CABLE FREIN A MAIN	211 420 03 85	
			07.2003		24.3727-0447.2	580447	CABLE FREIN A MAIN	211 420 01 85	
	E 63 AMG		03.2006		24.3727-0447.2	580447	CABLE FREIN A MAIN	211 420 01 85	
		ArD	03.2006		24.3727-0448.2	580448	CABLE FREIN A MAIN	211 420 03 85	
Classe E (W211) Berline (02-)	E 200 CDI	ArD	05.2002		24.3727-0448.2	580448	CABLE FREIN A MAIN	211 420 03 85	
	E 200 Kompressor	ArD	05.2002		24.3727-0448.2	580448	CABLE FREIN A MAIN	211 420 03 85	
	E 220 CDI	ArD	03.2002		24.3727-0448.2	580448	CABLE FREIN A MAIN	211 420 03 85	
	E 230		04.2006		24.3727-0447.2	580447	CABLE FREIN A MAIN	211 420 01 85	
		ArD	04.2006		24.3727-0448.2	580448	CABLE FREIN A MAIN	211 420 03 85	
	E 240	ArD	03.2002		24.3727-0448.2	580448	CABLE FREIN A MAIN	211 420 03 85	
	E 240 4-Matic	ArD	03.2003		24.3727-0448.2	580448	CABLE FREIN A MAIN	211 420 03 85	
			03.2003		24.3727-0447.2	580447	CABLE FREIN A MAIN	211 420 01 85	
	E 270 CDI	ArD	03.2002		24.3727-0448.2	580448	CABLE FREIN A MAIN	211 420 03 85	

Nouvelles références disponibles - par applications

04/2008



					description	Références OE par référence ATE.		Références remplacées / divers
--	--	--	--	--	-------------	----------------------------------	--	--------------------------------

MERCEDES BENZ

Classe E (W211) Berline (02-)	E 280		05.2005		24.3727-0447.2	580447	CABLE FREIN A MAIN	211 420 01 85	
		ArD	05.2005		24.3727-0448.2	580448	CABLE FREIN A MAIN	211 420 03 85	
	E 280 4-Matic	ArD	05.2005		24.3727-0448.2	580448	CABLE FREIN A MAIN	211 420 03 85	
			05.2005		24.3727-0447.2	580447	CABLE FREIN A MAIN	211 420 01 85	
	E 280 CDI	ArD	05.2004		24.3727-0448.2	580448	CABLE FREIN A MAIN	211 420 03 85	
			05.2004		24.3727-0447.2	580447	CABLE FREIN A MAIN	211 420 01 85	
	E 280 CDI 4-Matic		05.2005		24.3727-0447.2	580447	CABLE FREIN A MAIN	211 420 01 85	
		ArD	05.2005		24.3727-0448.2	580448	CABLE FREIN A MAIN	211 420 03 85	
	E 300 Bluetec	ArD	09.2007		24.3727-0448.2	580448	CABLE FREIN A MAIN	211 420 03 85	
	E 320	ArD	03.2002		24.3727-0448.2	580448	CABLE FREIN A MAIN	211 420 03 85	
	E 320 4-Matic		03.2003		24.3727-0447.2	580447	CABLE FREIN A MAIN	211 420 01 85	
		ArD	03.2003		24.3727-0448.2	580448	CABLE FREIN A MAIN	211 420 03 85	
	E 320 CDI	ArD	11.2002		24.3727-0448.2	580448	CABLE FREIN A MAIN	211 420 03 85	
	E 320 CDI 4-Matic		05.2005		24.3727-0447.2	580447	CABLE FREIN A MAIN	211 420 01 85	
		ArD	05.2005		24.3727-0448.2	580448	CABLE FREIN A MAIN	211 420 03 85	
	E 350		12.2004		24.3727-0447.2	580447	CABLE FREIN A MAIN	211 420 01 85	
		ArD	12.2004		24.3727-0448.2	580448	CABLE FREIN A MAIN	211 420 03 85	
	E 350 4-Matic		12.2004		24.3727-0447.2	580447	CABLE FREIN A MAIN	211 420 01 85	
		ArD	12.2004		24.3727-0448.2	580448	CABLE FREIN A MAIN	211 420 03 85	









					description	Références OE par référence ATE.		Références remplacées / divers
--	--	--	--	--	-------------	----------------------------------	--	--------------------------------

MERCEDES BENZ

Classe E (W211) Berline (02-)	E 350 CGI	ArD	09.2007		24.3727-0448.2	580448	CABLE FREIN A MAIN	211 420 03 85	
	E 400 CDI	ArD	03.2003		24.3727-0448.2	580448	CABLE FREIN A MAIN	211 420 03 85	
	E 500	ArD	03.2002		24.3727-0448.2	580448	CABLE FREIN A MAIN	211 420 03 85	
	E 500 4-Matic		10.2003		24.3727-0447.2	580447	CABLE FREIN A MAIN	211 420 01 85	
		ArD	10.2003		24.3727-0448.2	580448	CABLE FREIN A MAIN	211 420 03 85	
	E 55 Kompressor AMG		10.2002		24.3727-0447.2	580447	CABLE FREIN A MAIN	211 420 01 85	
		ArD	10.2002		24.3727-0448.2	580448	CABLE FREIN A MAIN	211 420 03 85	
	E 63 AMG		03.2006		24.3727-0447.2	580447	CABLE FREIN A MAIN	211 420 01 85	
		ArD	03.2006		24.3727-0448.2	580448	CABLE FREIN A MAIN	211 420 03 85	
Transporter (BM 631) MB 100 D (87-96)	MB 100 D		09.1987	02.1996	24.3481-1759.5	240339	ETRIER A GRIFFE	631 420 10 83 , 631 420 11 83 , 631 420 32 83 , 631 420 33 83 , 631 420 04 83 , 631 420 05 83	24.3481-1727.7



					description	Références OE par référence ATE.	 Références remplacées / divers
---	---	---	---	---	-------------	----------------------------------	--







MITSUBISHI

Modèle	Version	Code	07.1995	09.1998	24.3219-1753.3	020506	description	MR129595	
CARISMA (95-06)	1,6 i (DA1A)						CYLINDRE DE ROUE	MR129595	
			10.1998	05.1999	24.3219-1745.3	020496	CYLINDRE DE ROUE	MR307779	
	1,6 i 16V (DA1A)		05.1997	09.1998	24.3219-1753.3	020506	CYLINDRE DE ROUE	MR129595	
			10.1998	05.1999	24.3219-1745.3	020496	CYLINDRE DE ROUE	MR307779	
			06.1999	08.2000	24.3219-1745.3	020496	CYLINDRE DE ROUE	MR307779	
	1,8 i (DA2A)		07.1995	10.2005	24.3219-1753.3	020506	CYLINDRE DE ROUE	MR129595	
	1,8 i 16V (DA2A)		07.1995	10.2005	24.3219-1753.3	020506	CYLINDRE DE ROUE	MR129595	
	1,8 i 16V GDI (DA2A)		10.2000	10.2005	24.3219-1745.3	020496	CYLINDRE DE ROUE	MR307779	
			09.1997	09.1998	24.3219-1753.3	020506	CYLINDRE DE ROUE	MR129595	
			10.1998	10.2005	24.3219-1745.3	020496	CYLINDRE DE ROUE	MR307779	
	1,9 TD (DA4A)		10.1998	08.2000	24.3219-1745.3	020496	CYLINDRE DE ROUE	MR307779	
			10.1996	09.1998	24.3219-1753.3	020506	CYLINDRE DE ROUE	MR129595	
GALANT (4-portes) (87-92)	1,8 (E32A)	AvD	06.1990	10.1992	24.3541-1816.5	240384	ETRIER A GRIFFE	MB699173	
		AvG	06.1990	10.1992	24.3541-1815.5	240383	ETRIER A GRIFFE	MB699172	
	1,8 TD (E34A)	AvD	06.1990	10.1992	24.3541-1816.5	240384	ETRIER A GRIFFE	MB699173	
		AvG	06.1990	10.1992	24.3541-1815.5	240383	ETRIER A GRIFFE	MB699172	
GALANT (5-portes) (88-92)	1,8 (E32A)	AvD	06.1990	10.1992	24.3541-1816.5	240384	ETRIER A GRIFFE	MB699173	
		AvG	06.1990	10.1992	24.3541-1815.5	240383	ETRIER A GRIFFE	MB699172	
	1,8 TD (E34A)	AvG	06.1990	10.1992	24.3541-1815.5	240383	ETRIER A GRIFFE	MB699172	

Nouvelles références disponibles - par applications

04/2008









					description	Références OE par référence ATE.		Références remplacées / divers
---	---	---	---	---	-------------	----------------------------------	---	--------------------------------

MITSUBISHI

GALANT (5-portes) (88-92)	1,8 TD (E34A)	AvD	06.1990	10.1992	24.3541-1816.5	240384	ETRIER A GRIFFE	MB699173	
SPACE RUNNER (91-99)	1,8 (N11W)	AvG	06.1991	08.1999	24.3541-1815.5	240383	ETRIER A GRIFFE	MB699172	
		AvD	06.1991	08.1999	24.3541-1816.5	240384	ETRIER A GRIFFE	MB699173	
	1,8 4x4 (N21W)	AvG	06.1991	08.1999	24.3541-1815.5	240383	ETRIER A GRIFFE	MB699172	
		AvD	06.1991	08.1999	24.3541-1816.5	240384	ETRIER A GRIFFE	MB699173	
	2,0 TD (N18W)	AvG	06.1992	08.1999	24.3541-1815.5	240383	ETRIER A GRIFFE	MB699172	
		AvD	06.1992	08.1999	24.3541-1816.5	240384	ETRIER A GRIFFE	MB699173	
SPACE STAR (98-06)	1,3 i (DG1A)		12.1998	03.2006	24.3219-1753.3	020506	CYLINDRE DE ROUE	MR129595	
			08.2000	03.2006	24.3219-1753.3	020506	CYLINDRE DE ROUE	MR129595	
			06.1998	07.2000	24.3219-1753.3	020506	CYLINDRE DE ROUE	MR129595	
	1,8 GDI (DG5A)		06.1998	03.2006	24.3219-1745.3	020496	CYLINDRE DE ROUE	MR307779	
			10.2002	03.2006	24.3219-1745.3	020496	CYLINDRE DE ROUE	MR307779	
SPACE WAGON (91-98)	1,8 (N31W)	AvD	05.1991	05.1992	24.3541-1816.5	240384	ETRIER A GRIFFE	MB699173	
		AvG	05.1991	05.1992	24.3541-1815.5	240383	ETRIER A GRIFFE	MB699172	
	1,8 4x4 (N41W)	AvD	05.1991	05.1992	24.3541-1816.5	240384	ETRIER A GRIFFE	MB699173	
		AvG	05.1991	05.1992	24.3541-1815.5	240383	ETRIER A GRIFFE	MB699172	
	1,8 TD (N35W)	AvG	05.1991	05.1992	24.3541-1815.5	240383	ETRIER A GRIFFE	MB699172	
		AvD	05.1991	05.1992	24.3541-1816.5	240384	ETRIER A GRIFFE	MB699173	
	2,0 (N33W)	AvG	06.1992	10.1998	24.3541-1815.5	240383	ETRIER A GRIFFE	MB699172	



		 		<p>description</p>	<p>Références OE par référence ATE.</p>	 <p>Références remplacées / divers</p>
---	---	---	---	--------------------	---	---

MITSUBISHI

Modèle	Version	AvD	06.1992	10.1998	24.3541-1816.5	240384	description	Références OE par référence ATE.	Références remplacées / divers
SPACE WAGON (91-98)	2,0 (N33W)	AvD	06.1992	10.1998	24.3541-1816.5	240384	ETRIER A GRIFFE	MB699173	
	2,0 4x4 (N43W)	AvG	06.1992	10.1998	24.3541-1815.5	240383	ETRIER A GRIFFE	MB699172	
		AvD	06.1992	10.1998	24.3541-1816.5	240384	ETRIER A GRIFFE	MB699173	
	2,0 TD (N38W)	AvG	06.1992	10.1998	24.3541-1815.5	240383	ETRIER A GRIFFE	MB699172	
		AvD	06.1992	10.1998	24.3541-1816.5	240384	ETRIER A GRIFFE	MB699173	
	2,4 (N34W)	AvG	06.1992	05.1996	24.3541-1815.5	240383	ETRIER A GRIFFE	MB699172	
		AvD	06.1992	05.1996	24.3541-1816.5	240384	ETRIER A GRIFFE	MB699173	

Nouvelles références disponibles - par applications

04/2008



					description	Références OE par référence ATE.		Références remplacées / divers
--	--	--	--	--	-------------	----------------------------------	--	--------------------------------

NISSAN

100 NX (B13) (90-94)	1,6	AvD	10.1990	10.1994	24.3481-1726.5	240188	ETRIER A GRIFFE	41001-60Y02 , 41001-60Y00 , 41001-60Y01	
		AvG	10.1990	10.1994	24.3481-1725.5	240187	ETRIER A GRIFFE	41011-60Y00 , 41011-60Y01 , 41011-60Y02	
ALMERA (N15) (95-00)	1,4 i	ArG	07.1997	04.2000	24.3344-1719.5	240343	ETRIER A GRIFFE	44011-0N600	
			01.1998	04.2000	24.2123-1761.3	010780	MAITRE CYL. TANDEM	46010-2N320	
	1,6 i	ArG	01.1998	04.2000	24.3344-1719.5	240343	ETRIER A GRIFFE	44011-0N600	
			01.1998	04.2000	24.2123-1761.3	010780	MAITRE CYL. TANDEM	46010-2N320	
	2,0 D	ArG	01.1998	04.2000	24.3344-1719.5	240343	ETRIER A GRIFFE	44011-0N600	
			01.1998	04.2000	24.2123-1761.3	010780	MAITRE CYL. TANDEM	46010-2N320	
	2,0 i	ArG	04.1996	04.2000	24.3344-1719.5	240343	ETRIER A GRIFFE	44011-0N600	
			01.1998	04.2000	24.2123-1761.3	010780	MAITRE CYL. TANDEM	46010-2N320	
ALMERA (N16) (00-)	1,5 dCi		01.2003		24.3217-1720.3	020495	CYLINDRE DE ROUE	44100-7E611	
	1,5 i	ArG	03.2000	03.2001	24.3344-1719.5	240343	ETRIER A GRIFFE	44011-0N600	
			03.2000	03.2001	24.2123-1761.3	010780	MAITRE CYL. TANDEM	46010-2N320	
			02.2000		24.3217-1720.3	020495	CYLINDRE DE ROUE	44100-7E611	
			10.2002		24.3217-1720.3	020495	CYLINDRE DE ROUE	44100-7E611	
			03.2000	03.2001	24.3217-1720.3	020495	CYLINDRE DE ROUE	44100-7E611	
	1,8 i	ArG	03.2000	03.2001	24.3344-1719.5	240343	ETRIER A GRIFFE	44011-0N600	
			03.2000	03.2001	24.2123-1761.3	010780	MAITRE CYL. TANDEM	46010-2N320	

Nouvelles références disponibles - par applications

04/2008



					description	Références OE par référence ATE.		Références remplacées / divers
--	--	--	--	--	-------------	----------------------------------	--	--------------------------------

NISSAN

ALMERA (N16) (00-)	2,2 Di	ArG	03.2000	03.2001	24.3344-1719.5	240343	ETRIER A GRIFFE	44011-0N600	
			03.2000	03.2001	24.2123-1761.3	010780	MAITRE CYL. TANDEM	46010-2N320	
MICRA (K11E) (92-02)	1,0 i 16V	AvG	09.2000	12.2002	24.3481-1763.5	240367	ETRIER A GRIFFE	41011-99B00	
		AvD	09.2000	12.2002	24.3481-1764.5	240368	ETRIER A GRIFFE	41001-99B00	
		AvD	08.1992	08.2000	24.3481-1764.5	240368	ETRIER A GRIFFE	41001-99B00	
		AvG	08.1992	08.2000	24.3481-1763.5	240367	ETRIER A GRIFFE	41011-99B00	
	1,3 i 16V	AvD	09.2000	12.2002	24.3481-1764.5	240368	ETRIER A GRIFFE	41001-99B00	
		AvD	08.1992	08.2000	24.3481-1764.5	240368	ETRIER A GRIFFE	41001-99B00	
		AvG	09.2000	12.2002	24.3481-1763.5	240367	ETRIER A GRIFFE	41011-99B00	
		AvG	08.1992	08.2000	24.3481-1763.5	240367	ETRIER A GRIFFE	41011-99B00	
	1,5 D	AvG	02.1998	12.2002	24.3481-1763.5	240367	ETRIER A GRIFFE	41011-99B00	
		AvD	02.1998	12.2002	24.3481-1764.5	240368	ETRIER A GRIFFE	41001-99B00	
SUNNY (N14) Berline (90-95)	1,4	AvD	10.1990	05.1995	24.3481-1726.5	240188	ETRIER A GRIFFE	41001-60Y02 , 41001-60Y00 , 41001-60Y01	
		AvG	10.1990	05.1995	24.3481-1725.5	240187	ETRIER A GRIFFE	41011-60Y00 , 41011-60Y01 , 41011-60Y02	
	1,6 16V	AvG	10.1990	05.1995	24.3481-1725.5	240187	ETRIER A GRIFFE	41011-60Y00 , 41011-60Y01 , 41011-60Y02	
		AvD	10.1990	05.1995	24.3481-1726.5	240188	ETRIER A GRIFFE	41001-60Y02 , 41001-60Y00 , 41001-60Y01	
	1,6 16V 4x4	AvD	10.1990	05.1995	24.3481-1726.5	240188	ETRIER A GRIFFE	41001-60Y02 , 41001-60Y00 , 41001-60Y01	



	i				description	Références OE par référence ATE.	i Références remplacées / divers
--	----------	--	--	--	-------------	----------------------------------	--

NISSAN

Modèle	Motorisation	AvG	10.1990	05.1995	24.3481-1725.5	240187	description	Références OE par référence ATE.	Références remplacées / divers
SUNNY (N14) Berline (90-95)	1,6 16V 4x4	AvG	10.1990	05.1995	24.3481-1725.5	240187	ETRIER A GRIFFE	41011-60Y00 , 41011-60Y01 , 41011-60Y02	
	2,0 D	AvG	10.1990	05.1995	24.3481-1725.5	240187	ETRIER A GRIFFE	41011-60Y00 , 41011-60Y01 , 41011-60Y02	
		AvD	10.1990	05.1995	24.3481-1726.5	240188	ETRIER A GRIFFE	41001-60Y02 , 41001-60Y00 , 41001-60Y01	



					description	Références OE par référence ATE.		Références remplacées / divers
--	--	--	--	--	-------------	----------------------------------	--	--------------------------------

OPEL

AGILA (00-07)	1	ArD	08.2003	07.2007	24.3727-0778.2	580778	CABLE FREIN A MAIN	47 06 688 , 9211155	
		ArG	08.2003	07.2007	24.3727-0777.2	580777	CABLE FREIN A MAIN	47 06 689 , 9211156	
			08.2003	07.2007	24.3215-1701.3	020493	CYLINDRE DE ROUE	47 05 130 , 9209092	
	1,0 12V	ArD		07.2007	24.3727-0778.2	580778	CABLE FREIN A MAIN	47 06 688 , 9211155	
		ArG		07.2007	24.3727-0777.2	580777	CABLE FREIN A MAIN	47 06 689 , 9211156	
			09.2000	07.2007	24.3215-1701.3	020493	CYLINDRE DE ROUE	47 05 130 , 9209092	
	1,2 16V			07.2007	24.3728-0725.2	590725	CABLE D'EMBAYAGE	47 05 607 , 9210082 , 47 07 843 , 9216431	
		ArG		07.2007	24.3727-0777.2	580777	CABLE FREIN A MAIN	47 06 689 , 9211156	
		ArD		07.2007	24.3727-0778.2	580778	CABLE FREIN A MAIN	47 06 688 , 9211155	
			09.2000	07.2007	24.3215-1701.3	020493	CYLINDRE DE ROUE	47 05 130 , 9209092	
	1,3 CDTI		08.2003	07.2007	24.3728-0725.2	590725	CABLE D'EMBAYAGE	47 05 607 , 9210082 , 47 07 843 , 9216431	
		ArD	08.2003	07.2007	24.3727-0778.2	580778	CABLE FREIN A MAIN	47 06 688 , 9211155	
		ArG	08.2003	07.2007	24.3727-0777.2	580777	CABLE FREIN A MAIN	47 06 689 , 9211156	
			08.2003	07.2007	24.3215-1701.3	020493	CYLINDRE DE ROUE	47 05 130 , 9209092	
ASTRA H / GTC / Vauxhall Astra MKV (04-)			08.2005		24.3727-0775.2	580775	CABLE FREIN A MAIN	5 22 033 , 13237271 , 5 22 456 , 13157062	
	1,4		01.2004		24.3727-0775.2	580775	CABLE FREIN A MAIN	5 22 033 , 13237271 , 5 22 456 , 13157062	
			01.2004		24.3727-0770.2	580770	CABLE FREIN A MAIN	5 22 455 , 13157061	



					description	Références OE par référence ATE.		Références remplacées / divers
--	--	--	--	--	-------------	----------------------------------	--	--------------------------------

OPEL

ASTRA H / GTC / Vauxhall Astra MKV (04-)	1,6		01.2007		24.3727-0775.2	580775	CABLE FREIN A MAIN	5 22 033 , 13237271 , 5 22 456 , 13157062	
			01.2004		24.3727-0775.2	580775	CABLE FREIN A MAIN	5 22 033 , 13237271 , 5 22 456 , 13157062	
			01.2004		24.3727-0770.2	580770	CABLE FREIN A MAIN	5 22 455 , 13157061	
	1,6 Turbo		01.2007		24.3727-0775.2	580775	CABLE FREIN A MAIN	5 22 033 , 13237271 , 5 22 456 , 13157062	
	1,7 CDTI		01.2004		24.3727-0770.2	580770	CABLE FREIN A MAIN	5 22 455 , 13157061	
			04.2007		24.3727-0775.2	580775	CABLE FREIN A MAIN	5 22 033 , 13237271 , 5 22 456 , 13157062	
			01.2004		24.3727-0775.2	580775	CABLE FREIN A MAIN	5 22 033 , 13237271 , 5 22 456 , 13157062	
	1,8		01.2006		24.3727-0775.2	580775	CABLE FREIN A MAIN	5 22 033 , 13237271 , 5 22 456 , 13157062	
			01.2004		24.3727-0775.2	580775	CABLE FREIN A MAIN	5 22 033 , 13237271 , 5 22 456 , 13157062	
	1,9 CDTI		09.2004		24.3727-0775.2	580775	CABLE FREIN A MAIN	5 22 033 , 13237271 , 5 22 456 , 13157062	
			09.2005		24.3727-0775.2	580775	CABLE FREIN A MAIN	5 22 033 , 13237271 , 5 22 456 , 13157062	
	2,0 Turbo		01.2004		24.3727-0775.2	580775	CABLE FREIN A MAIN	5 22 033 , 13237271 , 5 22 456 , 13157062	
			09.2004		24.3727-0775.2	580775	CABLE FREIN A MAIN	5 22 033 , 13237271 , 5 22 456 , 13157062	
	2,0 Turbo OPC		03.2005		24.3727-0775.2	580775	CABLE FREIN A MAIN	5 22 033 , 13237271 , 5 22 456 , 13157062	



					description	Références OE par référence ATE.		Références remplacées / divers
--	--	--	--	--	-------------	----------------------------------	--	--------------------------------

OPEL

ASTRA H Caravan/Vau. Astra MKV Estate (04-)	1,4		08.2004		24.3727-0770.2	580770	CABLE FREIN A MAIN	5 22 455 , 13157061	
	1,6		08.2004		24.3727-0770.2	580770	CABLE FREIN A MAIN	5 22 455 , 13157061	
	1,7 CDTI		08.2004		24.3727-0770.2	580770	CABLE FREIN A MAIN	5 22 455 , 13157061	
ASTRA TWIN TOP (06-)	1,6				24.3727-0775.2	580775	CABLE FREIN A MAIN	5 22 033 , 13237271 , 5 22 456 , 13157062	
	1,6 Turbo				24.3727-0775.2	580775	CABLE FREIN A MAIN	5 22 033 , 13237271 , 5 22 456 , 13157062	
	1,6 Twinport				24.3727-0775.2	580775	CABLE FREIN A MAIN	5 22 033 , 13237271 , 5 22 456 , 13157062	
	1,8				24.3727-0775.2	580775	CABLE FREIN A MAIN	5 22 033 , 13237271 , 5 22 456 , 13157062	
	1,9 CDTI				24.3727-0775.2	580775	CABLE FREIN A MAIN	5 22 033 , 13237271 , 5 22 456 , 13157062	
	2,0 Turbo				24.3727-0775.2	580775	CABLE FREIN A MAIN	5 22 033 , 13237271 , 5 22 456 , 13157062	
CORSA D / Vauxhall Corsa MK III (06-)	1,0 i		10.2006		03.0520-6719.3	696719	ATE TOPKIT		
			10.2006		24.0220-3035.1	480300	TAMBOUR DE FREIN	55703042 , 55701379 , 5 68 269	
			10.2006		24.0222-8037.1	480302	TAMBOUR DE FREIN	55703043 , 55701380 , 5 68 270	
			10.2006		24.3219-1755.3	020508	CYLINDRE DE ROUE	5 50 248 , 93189986	
	1,2 i 16V		10.2006		03.0520-6719.3	696719	ATE TOPKIT		
			10.2006		24.0220-3035.1	480300	TAMBOUR DE FREIN	55703042 , 55701379 , 5 68 269	



					description	Références OE par référence ATE.		Références remplacées / divers
--	--	--	--	--	-------------	----------------------------------	--	--------------------------------

OPEL

CORSA D / Vauxhall Corsa MK III (06-)	1,2 i 16V		10.2006		24.0222-8037.1	480302	TAMBOUR DE FREIN	55703043 , 55701380 , 5 68 270	
			10.2006		24.3219-1755.3	020508	CYLINDRE DE ROUE	5 50 248 , 93189986	
	1,3 CDTI		10.2006		24.0222-8037.1	480302	TAMBOUR DE FREIN	55703043 , 55701380 , 5 68 270	
			10.2006		24.3219-1755.3	020508	CYLINDRE DE ROUE	5 50 248 , 93189986	
	1,4 i 16V		10.2006		24.0222-8037.1	480302	TAMBOUR DE FREIN	55703043 , 55701380 , 5 68 270	
			10.2006		24.3219-1755.3	020508	CYLINDRE DE ROUE	5 50 248 , 93189986	
	1,7 CDTI		10.2006		13.0460-3841.2	603841	PLAQUETTES DE FREIN	16 05 355 , 93189822	cf. Photo
FRONTERA A (92-98)	2	AvD	10.1998		24.3601-1718.5	240392	ETRIER A GRIFFE	5 42 248 , 97035248 , 97144476 , 5 42 107	
		AvG	10.1998		24.3601-1717.5	240391	ETRIER A GRIFFE	97035249 , 5 42 247 , 97144477 , 5 42 116	
	2,2 16V	AvD	10.1998		24.3601-1718.5	240392	ETRIER A GRIFFE	5 42 248 , 97035248 , 97144476 , 5 42 107	
		AvG	10.1998		24.3601-1717.5	240391	ETRIER A GRIFFE	97035249 , 5 42 247 , 97144477 , 5 42 116	
	2,3 TD	AvD	10.1998		24.3601-1718.5	240392	ETRIER A GRIFFE	5 42 248 , 97035248 , 97144476 , 5 42 107	
		AvG	10.1998		24.3601-1717.5	240391	ETRIER A GRIFFE	97035249 , 5 42 247 , 97144477 , 5 42 116	
	2,4	AvD	10.1998		24.3601-1718.5	240392	ETRIER A GRIFFE	5 42 248 , 97035248 , 97144476 , 5 42 107	









					description	Références OE par référence ATE.		Références remplacées / divers
--	--	--	--	--	-------------	----------------------------------	--	--------------------------------

OPEL

FRONTERA A (92-98)	2,4	AvG		10.1998	24.3601-1717.5	240391	ETRIER A GRIFFE	97035249 , 5 42 247 , 97144477 , 5 42 116	
	2,5 TDS	AvD		10.1998	24.3601-1718.5	240392	ETRIER A GRIFFE	5 42 248 , 97035248 , 97144476 , 5 42 107	
		AvG		10.1998	24.3601-1717.5	240391	ETRIER A GRIFFE	97035249 , 5 42 247 , 97144477 , 5 42 116	
	2,8 TD	AvG		10.1998	24.3601-1717.5	240391	ETRIER A GRIFFE	97035249 , 5 42 247 , 97144477 , 5 42 116	
		AvD		10.1998	24.3601-1718.5	240392	ETRIER A GRIFFE	5 42 248 , 97035248 , 97144476 , 5 42 107	
FRONTERA B (98-04)	2,2 DTI	AvD	10.1998	02.2004	24.3601-1718.5	240392	ETRIER A GRIFFE	5 42 248 , 97035248 , 97144476 , 5 42 107	
		AvG	10.1998	02.2004	24.3601-1717.5	240391	ETRIER A GRIFFE	97035249 , 5 42 247 , 97144477 , 5 42 116	
	2,2 i	AvD	10.1998	02.2004	24.3601-1718.5	240392	ETRIER A GRIFFE	5 42 248 , 97035248 , 97144476 , 5 42 107	
		AvG	10.1998	02.2004	24.3601-1717.5	240391	ETRIER A GRIFFE	97035249 , 5 42 247 , 97144477 , 5 42 116	
	3,2 i	AvD	10.1998	02.2004	24.3601-1718.5	240392	ETRIER A GRIFFE	5 42 248 , 97035248 , 97144476 , 5 42 107	
		AvG	10.1998	02.2004	24.3601-1717.5	240391	ETRIER A GRIFFE	97035249 , 5 42 247 , 97144477 , 5 42 116	
MERIVA / Vauxhall Meriva (02-)	1,3 CDTI				24.3727-0779.2	580779	CABLE FREIN A MAIN	5 22 016 , 13159021	
			09.2003		24.3727-0780.2	580780	CABLE FREIN A MAIN	5 22 012 , 93 318 894	
	1,4 16V		07.2004		24.3727-0780.2	580780	CABLE FREIN A MAIN	5 22 012 , 93 318 894	









					description	Références OE par référence ATE.	 Références remplacées / divers
---	---	---	---	---	-------------	----------------------------------	--

OPEL

MERIVA / Vauxhall Meriva (02-)	1,4 16V				24.3727-0779.2	580779	CABLE FREIN A MAIN	5 22 016 , 13159021	
	1,6				24.3727-0779.2	580779	CABLE FREIN A MAIN	5 22 016 , 13159021	
			01.2006		24.3727-0780.2	580780	CABLE FREIN A MAIN	5 22 012 , 93 318 894	
			05.2003		24.3727-0780.2	580780	CABLE FREIN A MAIN	5 22 012 , 93 318 894	
	1,6 16V		05.2003		24.3727-0780.2	580780	CABLE FREIN A MAIN	5 22 012 , 93 318 894	
					24.3727-0779.2	580779	CABLE FREIN A MAIN	5 22 016 , 13159021	
	1,6 Turbo OPC		09.2005		24.3727-0780.2	580780	CABLE FREIN A MAIN	5 22 012 , 93 318 894	
					24.3727-0779.2	580779	CABLE FREIN A MAIN	5 22 016 , 13159021	
	1,7 CDTI				24.3727-0779.2	580779	CABLE FREIN A MAIN	5 22 016 , 13159021	
			09.2003		24.3727-0780.2	580780	CABLE FREIN A MAIN	5 22 012 , 93 318 894	
			09.2006		24.3727-0780.2	580780	CABLE FREIN A MAIN	5 22 012 , 93 318 894	
	1,7 DTI 16V		09.2002		24.3727-0780.2	580780	CABLE FREIN A MAIN	5 22 012 , 93 318 894	
					24.3727-0779.2	580779	CABLE FREIN A MAIN	5 22 016 , 13159021	
	1,8 16V		09.2002		24.3727-0780.2	580780	CABLE FREIN A MAIN	5 22 012 , 93 318 894	
					24.3727-0779.2	580779	CABLE FREIN A MAIN	5 22 016 , 13159021	
MONTEREY (92-98)	3,1 TD	AvG	09.1991	07.1998	24.3601-1717.5	240391	ETRIER A GRIFFE	97035249 , 5 42 247 , 97144477 , 5 42 116	
		AvD	09.1991	07.1998	24.3601-1718.5	240392	ETRIER A GRIFFE	5 42 248 , 97035248 , 97144476 , 5 42 107	
	3,2	AvG	05.1992	07.1998	24.3601-1717.5	240391	ETRIER A GRIFFE	97035249 , 5 42 247 , 97144477 , 5 42 116	



		 		description	Références OE par référence ATE.	 Références remplacées / divers
---	---	---	---	-------------	--	---

OPEL

MONTEREY (92-98)	3,2	AvD	05.1992	07.1998	24.3601-1718.5	240392	ETRIER A GRIFFE	5 42 248 , 97035248 , 97144476 , 5 42 107	
MONTEREY (98-99)	3,0 DTI	AvG	07.1998	08.1999	24.3601-1717.5	240391	ETRIER A GRIFFE	97035249 , 5 42 247 , 97144477 , 5 42 116	
		AvD	07.1998	08.1999	24.3601-1718.5	240392	ETRIER A GRIFFE	5 42 248 , 97035248 , 97144476 , 5 42 107	
	3,5 V6	AvD	07.1998	08.1999	24.3601-1718.5	240392	ETRIER A GRIFFE	5 42 248 , 97035248 , 97144476 , 5 42 107	
		AvG	07.1998	08.1999	24.3601-1717.5	240391	ETRIER A GRIFFE	97035249 , 5 42 247 , 97144477 , 5 42 116	

Nouvelles références disponibles - par applications

04/2008







					description	Références OE par référence ATE.		Références remplacées / divers
--	--	--	--	--	-------------	----------------------------------	--	--------------------------------

PEUGEOT

206 Berline (98-)	1,1	AvG			24.3481-1769.5	240373	ETRIER A GRIFFE	4400 P0	
	1,4	AvG			24.3481-1769.5	240373	ETRIER A GRIFFE	4400 P0	
	1,4 HDi	AvG	09.2001		24.3481-1769.5	240373	ETRIER A GRIFFE	4400 P0	
	1,4 Roland Garros	AvG			24.3481-1769.5	240373	ETRIER A GRIFFE	4400 P0	
	1,6	AvG			24.3481-1769.5	240373	ETRIER A GRIFFE	4400 P0	
	1,9 D	AvG			24.3481-1769.5	240373	ETRIER A GRIFFE	4400 P0	
206 SW (02-)	1,4 HDi	AvG	07.2002		24.3481-1769.5	240373	ETRIER A GRIFFE	4400 P0	
407 Coupé (05-)	2,2 16V		10.2005		24.3727-0844.2	580844	CABLE FREIN A MAIN	4745 X4	
	2,7 HDi		10.2005		24.3727-0844.2	580844	CABLE FREIN A MAIN	4745 X4	
	3,0 V6		10.2005		24.3727-0844.2	580844	CABLE FREIN A MAIN	4745 X4	
407 Berline (04-)	1,6 HDi 110		05.2004		24.3727-0844.2	580844	CABLE FREIN A MAIN	4745 X4	
	1,8 16V		05.2004		24.3727-0844.2	580844	CABLE FREIN A MAIN	4745 X4	
			09.2005		24.3727-0844.2	580844	CABLE FREIN A MAIN	4745 X4	
	2,0 16V		09.2005		24.3727-0844.2	580844	CABLE FREIN A MAIN	4745 X4	
			05.2004		24.3727-0844.2	580844	CABLE FREIN A MAIN	4745 X4	
	2,0 HDi 135		05.2004		24.3727-0844.2	580844	CABLE FREIN A MAIN	4745 X4	
	2,2 16V		09.2005		24.3727-0844.2	580844	CABLE FREIN A MAIN	4745 X4	
			05.2004		24.3727-0844.2	580844	CABLE FREIN A MAIN	4745 X4	
	2,2 HDi 170		05.2006		24.3727-0844.2	580844	CABLE FREIN A MAIN	4745 X4	









				<p>description</p>	<p>Références OE par référence ATE.</p>	 <p>Références remplacées / divers</p>
---	---	--	---	--------------------	---	---

PEUGEOT

Modèle	Motorisation	Date	Code	ATE	Description	Références OE	Références remplacées / divers
407 Berline (04-)	2,7 HDi	10.2005	24.3727-0844.2	580844	CABLE FREIN A MAIN	4745 X4	
	3,0 V6	05.2004	24.3727-0844.2	580844	CABLE FREIN A MAIN	4745 X4	
407 SW (04-)	1,6 HDi 110	05.2004	24.3727-0844.2	580844	CABLE FREIN A MAIN	4745 X4	
	1,8 16V	05.2004	24.3727-0844.2	580844	CABLE FREIN A MAIN	4745 X4	
		09.2005	24.3727-0844.2	580844	CABLE FREIN A MAIN	4745 X4	
	2,0 16V	05.2004	24.3727-0844.2	580844	CABLE FREIN A MAIN	4745 X4	
		09.2005	24.3727-0844.2	580844	CABLE FREIN A MAIN	4745 X4	
	2,0 HDi 135	05.2004	24.3727-0844.2	580844	CABLE FREIN A MAIN	4745 X4	
	2,2 16V	05.2004	24.3727-0844.2	580844	CABLE FREIN A MAIN	4745 X4	
		09.2005	24.3727-0844.2	580844	CABLE FREIN A MAIN	4745 X4	
	2,2 HDi 170	05.2006	24.3727-0844.2	580844	CABLE FREIN A MAIN	4745 X4	
	2,7 HDi	10.2005	24.3727-0844.2	580844	CABLE FREIN A MAIN	4745 X4	
	3,0 V6	05.2004	24.3727-0844.2	580844	CABLE FREIN A MAIN	4745 X4	









		 		<p>description</p>	<p>Références OE par référence ATE.</p>	 <p>Références remplacées / divers</p>
---	---	---	---	--------------------	---	---

SMART

FORTWO DECAPOTABLE (BM451) (07-)	0,8 CDI		04.2007		03.0137-0487.2	650487	JEU DE MACHOIRE	451 423 00 08	
	1		04.2007		03.0137-0487.2	650487	JEU DE MACHOIRE	451 423 00 08	
	1,0 BRABUS		07.2007		03.0137-0487.2	650487	JEU DE MACHOIRE	451 423 00 08	
	1,0 Turbo		04.2007		03.0137-0487.2	650487	JEU DE MACHOIRE	451 423 00 08	
FORTWO COUPE (BM451) (07-)	0,8 CDI		04.2007		03.0137-0487.2	650487	JEU DE MACHOIRE	451 423 00 08	
	1		04.2007		03.0137-0487.2	650487	JEU DE MACHOIRE	451 423 00 08	
	1,0 BRABUS		07.2007		03.0137-0487.2	650487	JEU DE MACHOIRE	451 423 00 08	
	1,0 Turbo		04.2007		03.0137-0487.2	650487	JEU DE MACHOIRE	451 423 00 08	



						description	Références OE par référence ATE.		Références remplacées / divers
---	---	---	---	---	--	-------------	--	---	-----------------------------------

SUBARU

FORESTER (02-05)	2,0 S Turbo		09.2002	08.2005	03.0137-3010.2	653010	JEU DE MACHOIRE	26298AA020 , 26298AC000 , 26698AC000	
FORESTER (97-02)			07.1998	04.2001	03.0137-3010.2	653010	JEU DE MACHOIRE	26298AA020 , 26298AC000 , 26698AC000	
IMPREZA Kombi (00-05)	2,0 WRX Turbo (GG)		10.2002	09.2005	03.0137-3010.2	653010	JEU DE MACHOIRE	26298AA020 , 26298AC000 , 26698AC000	
IMPREZA Kombi (05-)	2,0 R		10.2005		03.0137-3010.2	653010	JEU DE MACHOIRE	26298AA020 , 26298AC000 , 26698AC000	
IMPREZA Break (93-00)	1,6 (GF3)		01.1993	12.2000	03.0137-3010.2	653010	JEU DE MACHOIRE	26298AA020 , 26298AC000 , 26698AC000	
	1,6 4WD (GF4)		01.1993	12.2000	03.0137-3010.2	653010	JEU DE MACHOIRE	26298AA020 , 26298AC000 , 26698AC000	
	1,8 (GF5)		01.1993	12.2000	03.0137-3010.2	653010	JEU DE MACHOIRE	26298AA020 , 26298AC000 , 26698AC000	
	1,8 4WD (GF6)		01.1993	12.2000	03.0137-3010.2	653010	JEU DE MACHOIRE	26298AA020 , 26298AC000 , 26698AC000	
	2,0 4WD (GF8)		08.1995	12.2000	03.0137-3010.2	653010	JEU DE MACHOIRE	26298AA020 , 26298AC000 , 26698AC000	
	2,0 Turbo 4WD (GF8)		12.1993	12.2000	03.0137-3010.2	653010	JEU DE MACHOIRE	26298AA020 , 26298AC000 , 26698AC000	
IMPREZA Limousine (00-05)	2,0 GX (GD)		12.2000	09.2005	03.0137-3010.2	653010	JEU DE MACHOIRE	26298AA020 , 26298AC000 , 26698AC000	
	2,0 WRX STi (GD)		11.2001	09.2005	03.0137-3010.2	653010	JEU DE MACHOIRE	26298AA020 , 26298AC000 , 26698AC000	
	2,0 WRX Turbo (GD)		12.2000	09.2005	03.0137-3010.2	653010	JEU DE MACHOIRE	26298AA020 , 26298AC000 , 26698AC000	



					description	Références OE par référence ATE.		Références remplacées / divers
--	--	--	--	--	-------------	----------------------------------	--	--------------------------------

SUBARU

IMPREZA Limousine (00-05)	2,0 WRX Turbo (GD)		12.2002	09.2005	03.0137-3010.2	653010	JEU DE MACHOIRE	26298AA020 , 26298AC000 , 26698AC000	
	2,5 RSi (GD)		03.2001	09.2005	03.0137-3010.2	653010	JEU DE MACHOIRE	26298AA020 , 26298AC000 , 26698AC000	
IMPREZA Limousine (05-)	2,0 R		10.2005		03.0137-3010.2	653010	JEU DE MACHOIRE	26298AA020 , 26298AC000 , 26698AC000	
IMPREZA Berline (93-00)	1,6 (GC3)		01.1993	12.2000	03.0137-3010.2	653010	JEU DE MACHOIRE	26298AA020 , 26298AC000 , 26698AC000	
	1,6 4WD (GC4)		01.1993	12.2000	03.0137-3010.2	653010	JEU DE MACHOIRE	26298AA020 , 26298AC000 , 26698AC000	
	1,8 (GC5)		01.1993	12.2000	03.0137-3010.2	653010	JEU DE MACHOIRE	26298AA020 , 26298AC000 , 26698AC000	
	1,8 4WD (GC6)		01.1993	12.2000	03.0137-3010.2	653010	JEU DE MACHOIRE	26298AA020 , 26298AC000 , 26698AC000	
	2,0 (GC7)		08.1996	12.2000	03.0137-3010.2	653010	JEU DE MACHOIRE	26298AA020 , 26298AC000 , 26698AC000	
	2,0 4WD (GC8)		09.1994	12.2000	03.0137-3010.2	653010	JEU DE MACHOIRE	26298AA020 , 26298AC000 , 26698AC000	
	2,0 Turbo 4WD (GC8)		12.1993	12.2000	03.0137-3010.2	653010	JEU DE MACHOIRE	26298AA020 , 26298AC000 , 26698AC000	
LEGACY (03-)	2,0 i 16V		09.2003	10.2005	03.0137-3010.2	653010	JEU DE MACHOIRE	26298AA020 , 26298AC000 , 26698AC000	
	2,5 i 16V		09.2003		03.0137-3010.2	653010	JEU DE MACHOIRE	26298AA020 , 26298AC000 , 26698AC000	
	3,0 V6		09.2003		03.0137-3010.2	653010	JEU DE MACHOIRE	26298AA020 , 26298AC000 , 26698AC000	



					description	Références OE par référence ATE.		Références remplacées / divers
--	--	--	--	--	-------------	----------------------------------	--	--------------------------------

SUBARU

LEGACY (99-03)	2,0 i 16V (BE/BH5A)		08.2000	08.2003	03.0137-3010.2	653010	JEU DE MACHOIRE	26298AA020 , 26298AC000 , 26698AC000	
	2,5 i 16V (BE/BH9A)		08.2000	08.2003	03.0137-3010.2	653010	JEU DE MACHOIRE	26298AA020 , 26298AC000 , 26698AC000	
LEGACY Break (94-98)	2,0 (BG4)		01.1994	11.1998	03.0137-3010.2	653010	JEU DE MACHOIRE	26298AA020 , 26298AC000 , 26698AC000	
	2,0 4WD (BG5)		01.1994	11.1998	03.0137-3010.2	653010	JEU DE MACHOIRE	26298AA020 , 26298AC000 , 26698AC000	
	2,2 (BG6)		01.1994	11.1998	03.0137-3010.2	653010	JEU DE MACHOIRE	26298AA020 , 26298AC000 , 26698AC000	
	2,2 4WD (BG7)		01.1994	11.1998	03.0137-3010.2	653010	JEU DE MACHOIRE	26298AA020 , 26298AC000 , 26698AC000	
	2,5 4WD (BG9)		06.1996	11.1998	03.0137-3010.2	653010	JEU DE MACHOIRE	26298AA020 , 26298AC000 , 26698AC000	
LEGACY Berline (94-99)	1,8 (BD2)		01.1996	03.1999	03.0137-3010.2	653010	JEU DE MACHOIRE	26298AA020 , 26298AC000 , 26698AC000	
	2,0 (BD4)		01.1994	03.1999	03.0137-3010.2	653010	JEU DE MACHOIRE	26298AA020 , 26298AC000 , 26698AC000	
	2,0 4WD (BD5)		01.1994	03.1999	03.0137-3010.2	653010	JEU DE MACHOIRE	26298AA020 , 26298AC000 , 26698AC000	
	2,2 (BD6)		01.1994	03.1999	03.0137-3010.2	653010	JEU DE MACHOIRE	26298AA020 , 26298AC000 , 26698AC000	
	2,2 4WD (BD7)		01.1994	03.1999	03.0137-3010.2	653010	JEU DE MACHOIRE	26298AA020 , 26298AC000 , 26698AC000	
	2,5 4WD (BD9)		06.1996	03.1999	03.0137-3010.2	653010	JEU DE MACHOIRE	26298AA020 , 26298AC000 , 26698AC000	



	i				description	Références OE par référence ATE.	i Références remplacées / divers
--	----------	--	--	--	-------------	----------------------------------	--

SUZUKI

Modèle	Motorisation	Année 1	Année 2	Ref. ATE	Ref. OE	Description	Références OE par référence ATE.
IGNIS I (00-03)	1,3 i 16V	10.2000	08.2003	24.3215-1702.3	020494	CYLINDRE DE ROUE	53401-76G00 , 53401-76G01
	1,3 i 16V 4x4	10.2000	08.2003	24.3215-1702.3	020494	CYLINDRE DE ROUE	53401-76G00 , 53401-76G01
IGNIS II (03-)	1,3 i 16V	09.2003		24.3215-1702.3	020494	CYLINDRE DE ROUE	53401-76G00 , 53401-76G01
	1,5 i 16V	09.2003		24.3215-1702.3	020494	CYLINDRE DE ROUE	53401-76G00 , 53401-76G01
	1,5 i 16V 4x4	09.2003		24.3215-1702.3	020494	CYLINDRE DE ROUE	53401-76G00 , 53401-76G01
WAGON R+ (00-)	1,3 i 16V	05.2000	08.2003	24.3215-1702.3	020494	CYLINDRE DE ROUE	53401-76G00 , 53401-76G01
		09.2003		24.3215-1702.3	020494	CYLINDRE DE ROUE	53401-76G00 , 53401-76G01
	1,3 i 16V 4WD	09.2003		24.3215-1702.3	020494	CYLINDRE DE ROUE	53401-76G00 , 53401-76G01
		10.2001	08.2003	24.3215-1702.3	020494	CYLINDRE DE ROUE	53401-76G00 , 53401-76G01
	1,3 VVTi 4WD	09.2003		24.3215-1702.3	020494	CYLINDRE DE ROUE	53401-76G00 , 53401-76G01



					description	Références OE par référence ATE.		Références remplacées / divers
--	--	--	--	--	-------------	----------------------------------	--	--------------------------------

TOYOTA

COROLLA (97-02)	1,4 i (EE111)		08.1998	01.2000	24.3727-1918.2	581918	CABLE FREIN A MAIN	46410-12250	
			05.1997	07.1998	24.3727-1918.2	581918	CABLE FREIN A MAIN	46410-12250	
	1,4 i 16V (ZZE111)		02.2000	12.2001	24.3727-1918.2	581918	CABLE FREIN A MAIN	46410-12250	
	1,6 i (AE111)		05.1997	07.1998	24.3727-1918.2	581918	CABLE FREIN A MAIN	46410-12250	
			08.1998	01.2000	24.3727-1918.2	581918	CABLE FREIN A MAIN	46410-12250	
	1,6 i 16V (ZZE112)		02.2000	12.2001	24.3727-1918.2	581918	CABLE FREIN A MAIN	46410-12250	
	1,8 i 16V AWD (AE115)		05.1997	12.2001	24.3727-1918.2	581918	CABLE FREIN A MAIN	46410-12250	
	1,9 D (WZE110)		02.2000	12.2001	24.3727-1918.2	581918	CABLE FREIN A MAIN	46410-12250	
	2,0 D (CE110)		08.1998	01.2000	24.3727-1918.2	581918	CABLE FREIN A MAIN	46410-12250	
			05.1997	07.1998	24.3727-1918.2	581918	CABLE FREIN A MAIN	46410-12250	
	2,0 D-4D (CDE110)		09.2000	12.2001	24.3727-1918.2	581918	CABLE FREIN A MAIN	46410-12250	
HIACE (95-)	2,4 D (LXH12/18)		05.1998	08.2001	24.0227-0004.1	480303	TAMBOUR DE FREIN	42431-26180 , 42431-26181	
	2,4 TD (LXH12/22)		05.1998	08.2001	24.0227-0004.1	480303	TAMBOUR DE FREIN	42431-26180 , 42431-26181	
	2,7 (RCH13/23)		04.1998		24.0227-0004.1	480303	TAMBOUR DE FREIN	42431-26180 , 42431-26181	
	3,0 D (RCH13)		08.2001	10.2003	24.0227-0004.1	480303	TAMBOUR DE FREIN	42431-26180 , 42431-26181	
RAV4 II (00-05)	1,8 VVTi		02.2001	10.2005	24.3219-1754.3	020507	CYLINDRE DE ROUE	47550-42020	
	2,0 D-4D 4WD		09.2001	10.2005	24.3219-1754.3	020507	CYLINDRE DE ROUE	47550-42020	
	2,0 VVTi 4WD		06.2000	10.2005	24.3219-1754.3	020507	CYLINDRE DE ROUE	47550-42020	
	2,0 VVTi 4WD (Nato)		06.2000	07.2003	24.3219-1754.3	020507	CYLINDRE DE ROUE	47550-42020	

Nouvelles références disponibles - par applications

04/2008



	i				description	Références OE par référence ATE.	i Références remplacées / divers
--	----------	--	--	--	-------------	----------------------------------	--

TOYOTA

Modèle	Motorisation	ArD	08.2003	10.2005	24.3219-1754.3	020507	description	Références OE par référence ATE.	Références remplacées / divers
RAV4 II (00-05)	2,4 VVTi 4x4		08.2003	10.2005	24.3219-1754.3	020507	CYLINDRE DE ROUE	47550-42020	
YARIS (06-)	1,0 VVT-i		01.2006		03.0520-8920.3	698920	ATE TOPKIT	04907-0D010	
					24.3220-1728.3	020509	CYLINDRE DE ROUE	77363849 , 47550-09100	
	1,3 VVT-i		01.2006		03.0520-8920.3	698920	ATE TOPKIT	04907-0D010	
					24.3220-1728.3	020509	CYLINDRE DE ROUE	77363849 , 47550-09100	
	1,4 D-4D		01.2006		03.0520-8920.3	698920	ATE TOPKIT	04907-0D010	
					24.3220-1728.3	020509	CYLINDRE DE ROUE	77363849 , 47550-09100	
	1,5 VVT-i		01.2006		03.0520-8920.3	698920	ATE TOPKIT	04907-0D010	
					24.3220-1728.3	020509	CYLINDRE DE ROUE	77363849 , 47550-09100	
YARIS VERSO (99-)	1,3 i 16V	ArD	11.1999		24.3219-1750.3	020501	CYLINDRE DE ROUE	47550-20211	
					24.3219-1750.3	020501	CYLINDRE DE ROUE	47550-20211	

Nouvelles références disponibles - par applications

04/2008



					description	Références OE par référence ATE.		Références remplacées / divers
--	--	--	--	--	-------------	----------------------------------	--	--------------------------------

VOLKSWAGEN

EOS (06-)	1,6 FSI		05.2006		13.0460-0035.2	610035	ACCES. JEUX PLAQ.	8P0 615 231	
	2,0 FSI		05.2006		13.0460-0035.2	610035	ACCES. JEUX PLAQ.	8P0 615 231	
	2,0 TDI		05.2006		13.0460-0035.2	610035	ACCES. JEUX PLAQ.	8P0 615 231	
	2,0 TFSI		05.2006		13.0460-0035.2	610035	ACCES. JEUX PLAQ.	8P0 615 231	
	3,2 FSI		05.2006		13.0460-0035.2	610035	ACCES. JEUX PLAQ.	8P0 615 231	
GOLF V (03-)	1,4 16V		10.2003		13.0460-0035.2	610035	ACCES. JEUX PLAQ.	8P0 615 231	
	1,4 FSI		10.2003		13.0460-0035.2	610035	ACCES. JEUX PLAQ.	8P0 615 231	
	1,4 TSI		11.2005		13.0460-0035.2	610035	ACCES. JEUX PLAQ.	8P0 615 231	
			05.2007		13.0460-0035.2	610035	ACCES. JEUX PLAQ.	8P0 615 231	
			05.2006		13.0460-0035.2	610035	ACCES. JEUX PLAQ.	8P0 615 231	
	1,6 16V		01.2004		13.0460-0035.2	610035	ACCES. JEUX PLAQ.	8P0 615 231	
	1,6 FSI		10.2003		13.0460-0035.2	610035	ACCES. JEUX PLAQ.	8P0 615 231	
	1,9 TDI		05.2004		13.0460-0035.2	610035	ACCES. JEUX PLAQ.	8P0 615 231	
			10.2003		13.0460-0035.2	610035	ACCES. JEUX PLAQ.	8P0 615 231	
	1,9 TDI 4motion		08.2004		13.0460-0035.2	610035	ACCES. JEUX PLAQ.	8P0 615 231	
	2,0 FSI		10.2003		13.0460-0035.2	610035	ACCES. JEUX PLAQ.	8P0 615 231	
	2,0 FSI 4motion		08.2004		13.0460-0035.2	610035	ACCES. JEUX PLAQ.	8P0 615 231	
	2,0 GTI		09.2006		13.0460-0035.2	610035	ACCES. JEUX PLAQ.	8P0 615 231	
			09.2004		13.0460-0035.2	610035	ACCES. JEUX PLAQ.	8P0 615 231	

Nouvelles références disponibles - par applications

04/2008



					description	Références OE par référence ATE.		Références remplacées / divers
--	--	--	--	--	-------------	----------------------------------	--	--------------------------------

VOLKSWAGEN

GOLF V (03-)	2,0 SDI		01.2004		13.0460-0035.2	610035	ACCES. JEUX PLAQ.	8P0 615 231	
	2,0 TDI		10.2003		13.0460-0035.2	610035	ACCES. JEUX PLAQ.	8P0 615 231	
	2,0 TDI 4motion		08.2004		13.0460-0035.2	610035	ACCES. JEUX PLAQ.	8P0 615 231	
	3,2 R32		11.2005		13.0460-0035.2	610035	ACCES. JEUX PLAQ.	8P0 615 231	
PASSAT Berline (05-)	1,6		03.2005		13.0460-0035.2	610035	ACCES. JEUX PLAQ.	8P0 615 231	
	1,6 FSI		03.2005		13.0460-0035.2	610035	ACCES. JEUX PLAQ.	8P0 615 231	
	1,8 TSI		10.2007		13.0460-0035.2	610035	ACCES. JEUX PLAQ.	8P0 615 231	
	1,9 TDI		03.2005		13.0460-0035.2	610035	ACCES. JEUX PLAQ.	8P0 615 231	
	2,0 FSI		03.2005		13.0460-0035.2	610035	ACCES. JEUX PLAQ.	8P0 615 231	
	2,0 FSI 4motion		03.2005		13.0460-0035.2	610035	ACCES. JEUX PLAQ.	8P0 615 231	
	2,0 TDI		08.2005		13.0460-0035.2	610035	ACCES. JEUX PLAQ.	8P0 615 231	
			03.2005		13.0460-0035.2	610035	ACCES. JEUX PLAQ.	8P0 615 231	
	2,0 TDI 4motion		03.2005		13.0460-0035.2	610035	ACCES. JEUX PLAQ.	8P0 615 231	
	2,0 TFSI		03.2005		13.0460-0035.2	610035	ACCES. JEUX PLAQ.	8P0 615 231	
	3,2 V6 FSI		11.2005		13.0460-0035.2	610035	ACCES. JEUX PLAQ.	8P0 615 231	
	3,2 V6 FSI 4motion		09.2005		13.0460-0035.2	610035	ACCES. JEUX PLAQ.	8P0 615 231	
	3,6 R36		04.2007		13.0460-0035.2	610035	ACCES. JEUX PLAQ.	8P0 615 231	
PASSAT Variant (05-)	1,6 FSI		07.2005		13.0460-0035.2	610035	ACCES. JEUX PLAQ.	8P0 615 231	
	1,6 i 16V		07.2005		13.0460-0035.2	610035	ACCES. JEUX PLAQ.	8P0 615 231	



					description	Références OE par référence ATE.		Références remplacées / divers
--	--	--	--	--	-------------	----------------------------------	--	--------------------------------

VOLKSWAGEN

PASSAT Variant (05-)	1,9 TDI		07.2005		13.0460-0035.2	610035	ACCES. JEUX PLAQ.	8P0 615 231	
	2,0 FSI		07.2005		13.0460-0035.2	610035	ACCES. JEUX PLAQ.	8P0 615 231	
	2,0 FSI 4motion		09.2005		13.0460-0035.2	610035	ACCES. JEUX PLAQ.	8P0 615 231	
	2,0 TDI		07.2005		13.0460-0035.2	610035	ACCES. JEUX PLAQ.	8P0 615 231	
	2,0 TDI 4motion		09.2005		13.0460-0035.2	610035	ACCES. JEUX PLAQ.	8P0 615 231	
	2,0 TFSI		07.2005		13.0460-0035.2	610035	ACCES. JEUX PLAQ.	8P0 615 231	
	3,2 V6 FSI		11.2005		13.0460-0035.2	610035	ACCES. JEUX PLAQ.	8P0 615 231	
	3,2 V6 FSI 4motion		11.2005		13.0460-0035.2	610035	ACCES. JEUX PLAQ.	8P0 615 231	
	3,6 R36		04.2007		13.0460-0035.2	610035	ACCES. JEUX PLAQ.	8P0 615 231	
PHAETON (02-)	3,0 TDI		09.2004		13.0460-0023.2	610023	ACCES. JEUX PLAQ.	3D0 615 231	
	3,2 V6		04.2002		13.0460-0023.2	610023	ACCES. JEUX PLAQ.	3D0 615 231	
	4,2 V8		05.2003		13.0460-0023.2	610023	ACCES. JEUX PLAQ.	3D0 615 231	
	5,0 V10 TDI		11.2002		13.0460-0023.2	610023	ACCES. JEUX PLAQ.	3D0 615 231	
	6,0 W12		04.2002		13.0460-0023.2	610023	ACCES. JEUX PLAQ.	3D0 615 231	
TRANSPORTER (T5) (03-)	1,9 TDI		06.2006		13.0460-0023.2	610023	ACCES. JEUX PLAQ.	3D0 615 231	
			04.2003		13.0460-0023.2	610023	ACCES. JEUX PLAQ.	3D0 615 231	
	2		06.2003		13.0460-0023.2	610023	ACCES. JEUX PLAQ.	3D0 615 231	
	2,5 TDI		02.2003		13.0460-0023.2	610023	ACCES. JEUX PLAQ.	3D0 615 231	
	2,5 TDI 4motion		07.2004		13.0460-0023.2	610023	ACCES. JEUX PLAQ.	3D0 615 231	



				<p>description</p>	<p>Références OE par référence ATE.</p>	<p>Références remplacées / divers</p>
--	--	--	--	--------------------	---	---

VOLKSWAGEN

TRANSPORTER (T5) (03-)	3,2 V6		02.2003	13.0460-0023.2	610023	ACCES. JEUX PLAQ.	3D0 615 231	
	3,2 V6 4motion		07.2004	13.0460-0023.2	610023	ACCES. JEUX PLAQ.	3D0 615 231	



13.0460-3831.2 603831

Applications:
FORD MONDEO III (01-06)

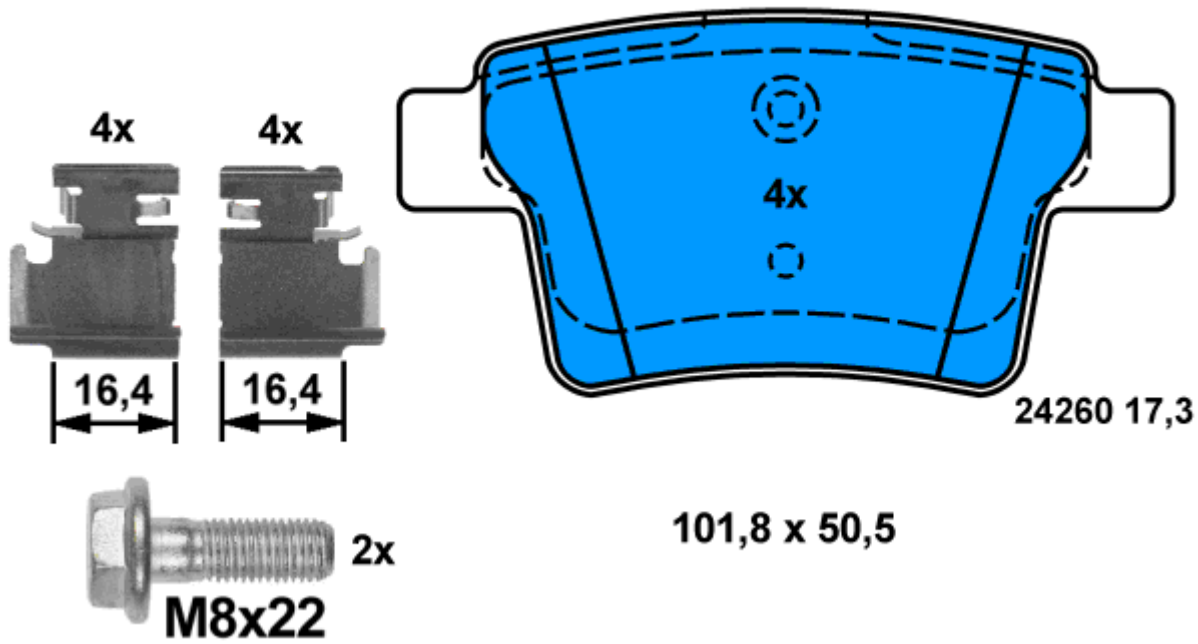



13.0460-3841.2 603841

Applications:

OPEL CORSA D / Vauxhall Corsa MK III (06-)

