

Nouvelles références disponibles
par applications



11/2007



www.ate.de









					description	Références OE par référence ATE.		Références remplacées / divers
--	--	--	--	--	-------------	----------------------------------	--	--------------------------------

ALFA ROMEO

159 (05-)	2,4 JTDM 20V		05.2007		24.0128-0191.1	428191	DISQUE DE FREIN	51767384 , 51731346 , 51760622	
			06.2005	02.2006	24.0128-0191.1	428191	DISQUE DE FREIN	51767384 , 51731346 , 51760622	
			03.2006		24.0128-0191.1	428191	DISQUE DE FREIN	51767384 , 51731346 , 51760622	
	2,4 JTDM 20V Q4		05.2007		24.0128-0191.1	428191	DISQUE DE FREIN	51767384 , 51731346 , 51760622	
	3,2 JTS Q4		03.2006		24.0128-0191.1	428191	DISQUE DE FREIN	51767384 , 51731346 , 51760622	
			12.2005	02.2006	24.0128-0191.1	428191	DISQUE DE FREIN	51767384 , 51731346 , 51760622	
BRERA (06-)	2,4 JTDM 20V		02.2007		24.0128-0191.1	428191	DISQUE DE FREIN	51767384 , 51731346 , 51760622	
			04.2006		24.0128-0191.1	428191	DISQUE DE FREIN	51767384 , 51731346 , 51760622	
			12.2005	03.2006	24.0128-0191.1	428191	DISQUE DE FREIN	51767384 , 51731346 , 51760622	
	3,2 JTS Q4		04.2006		24.0128-0191.1	428191	DISQUE DE FREIN	51767384 , 51731346 , 51760622	
			12.2005	03.2006	24.0128-0191.1	428191	DISQUE DE FREIN	51767384 , 51731346 , 51760622	
SPIDER (06-)	2,4 JTDM 20V		02.2007		24.0128-0191.1	428191	DISQUE DE FREIN	51767384 , 51731346 , 51760622	
	3,2 JTS Q4		06.2006		24.0128-0191.1	428191	DISQUE DE FREIN	51767384 , 51731346 , 51760622	



					<p>description</p>	<p>Références OE par référence ATE.</p>	 <p>Références remplacées / divers</p>
---	---	---	---	---	--------------------	---	---

ALFA ROMEO

SPIDER (06-)	3,2 JTS Q4		04.2006	05.2006	24.0128-0191.1	428191	DISQUE DE FREIN	51767384 , 51731346 , 51760622	
--------------	------------	--	---------	---------	----------------	--------	-----------------	-----------------------------------	--

Nouvelles références disponibles - par applications

11/2007



					description	Références OE par référence ATE.		Références remplacées / divers
--	--	--	--	--	-------------	----------------------------------	--	--------------------------------

AUDI

80 (91-95)	1,6		08.1991		83.7724-0202.3	330852	FLEXIBLE FREIN	8A0 611 775 D	83.6124-0202.3
				12.1995	83.7724-0202.3	330852	FLEXIBLE FREIN	8A0 611 775 D	83.6124-0202.3
	1,9 TD			12.1995	83.7724-0202.3	330852	FLEXIBLE FREIN	8A0 611 775 D	83.6124-0202.3
			09.1991		83.7724-0202.3	330852	FLEXIBLE FREIN	8A0 611 775 D	83.6124-0202.3
	1,9 TDI			12.1995	83.7724-0202.3	330852	FLEXIBLE FREIN	8A0 611 775 D	83.6124-0202.3
			09.1991		83.7724-0202.3	330852	FLEXIBLE FREIN	8A0 611 775 D	83.6124-0202.3
	2		08.1991		83.7724-0202.3	330852	FLEXIBLE FREIN	8A0 611 775 D	83.6124-0202.3
			08.1991	07.1992	83.7724-0202.3	330852	FLEXIBLE FREIN	8A0 611 775 D	83.6124-0202.3
			08.1991	12.1995	83.7724-0202.3	330852	FLEXIBLE FREIN	8A0 611 775 D	83.6124-0202.3
				12.1995	83.7724-0202.3	330852	FLEXIBLE FREIN	8A0 611 775 D	83.6124-0202.3
	2,3		09.1991	12.1995	83.7724-0202.3	330852	FLEXIBLE FREIN	8A0 611 775 D	83.6124-0202.3
	2,6		08.1992	12.1995	83.7724-0202.3	330852	FLEXIBLE FREIN	8A0 611 775 D	83.6124-0202.3
	2,8		09.1991	12.1995	83.7724-0202.3	330852	FLEXIBLE FREIN	8A0 611 775 D	83.6124-0202.3
A3 / A3 Sportback (03-)	1,4 TFSI		07.2007		03.2122-1963.3	010772	MAITRE CYL. TANDEM	1K1 614 019	
	1,6		05.2003		03.2122-1963.3	010772	MAITRE CYL. TANDEM	1K1 614 019	
	1,6 FSI		08.2003		03.2122-1963.3	010772	MAITRE CYL. TANDEM	1K1 614 019	
	1,8 TFSI		01.2007		03.2122-1963.3	010772	MAITRE CYL. TANDEM	1K1 614 019	
	1,9 TDI		06.2003		03.2122-1963.3	010772	MAITRE CYL. TANDEM	1K1 614 019	
	2,0 FSI		05.2003		03.2122-1963.3	010772	MAITRE CYL. TANDEM	1K1 614 019	

Nouvelles références disponibles - par applications

11/2007



					description	Références OE par référence ATE.		Références remplacées / divers
--	--	--	--	--	-------------	----------------------------------	--	--------------------------------

AUDI

A3 / A3 Sportback (03-)	2,0 TDI		05.2003		03.2122-1963.3	010772	MAITRE CYL. TANDEM	1K1 614 019	
			03.2006		03.2122-1963.3	010772	MAITRE CYL. TANDEM	1K1 614 019	
	2,0 TDI Quattro		08.2004		03.2122-1963.3	010772	MAITRE CYL. TANDEM	1K1 614 019	
			05.2003		03.2122-1963.3	010772	MAITRE CYL. TANDEM	1K1 614 019	
			03.2006		03.2122-1963.3	010772	MAITRE CYL. TANDEM	1K1 614 019	
	2,0 TFSI		06.2004		03.2122-1963.3	010772	MAITRE CYL. TANDEM	1K1 614 019	
	2,0 TFSI Quattro		06.2004		03.2122-1963.3	010772	MAITRE CYL. TANDEM	1K1 614 019	
	3,2 Quattro		07.2003		03.2122-1963.3	010772	MAITRE CYL. TANDEM	1K1 614 019	
A8 (03-)	3		07.2003		24.0122-0214.1	422214	DISQUE DE FREIN	3D0 615 601 , 3D0 615 601 C , 4E0 615 601 L	
	3,0 TDI Quattro		11.2003		24.0122-0214.1	422214	DISQUE DE FREIN	3D0 615 601 , 3D0 615 601 C , 4E0 615 601 L	
	3,2 FSI		06.2005		24.0122-0214.1	422214	DISQUE DE FREIN	3D0 615 601 , 3D0 615 601 C , 4E0 615 601 L	
	3,2 FSI Quattro		06.2005		24.0122-0214.1	422214	DISQUE DE FREIN	3D0 615 601 , 3D0 615 601 C , 4E0 615 601 L	
	3,7 Quattro		11.2002		24.0122-0214.1	422214	DISQUE DE FREIN	3D0 615 601 , 3D0 615 601 C , 4E0 615 601 L	
	4,0 TDI Quattro		03.2003		24.0122-0214.1	422214	DISQUE DE FREIN	3D0 615 601 , 3D0 615 601 C , 4E0 615 601 L	
	4,2 FSI Quattro		06.2006		24.0122-0214.1	422214	DISQUE DE FREIN	3D0 615 601 , 3D0 615 601 C , 4E0 615 601 L	
	4,2 Quattro		11.2002		24.0122-0214.1	422214	DISQUE DE FREIN	3D0 615 601 , 3D0 615 601 C , 4E0 615 601 L	



					description	Références OE par référence ATE.		Références remplacées / divers
--	--	--	--	--	-------------	----------------------------------	--	--------------------------------

AUDI

A8 (03-)	4,2 TDI Quattro		07.2005		24.0122-0214.1	422214	DISQUE DE FREIN	3D0 615 601 , 3D0 615 601 C , 4E0 615 601 L	
	6,0 W12 Quattro		02.2004		24.0122-0214.1	422214	DISQUE DE FREIN	3D0 615 601 , 3D0 615 601 C , 4E0 615 601 L	
	S8		06.2006		24.0122-0214.1	422214	DISQUE DE FREIN	3D0 615 601 , 3D0 615 601 C , 4E0 615 601 L	

CITROEN

C4 Grand Picasso (06-)	1,6 HDi 110		10.2006		13.0460-7229.2	607229	PLAQUETTES DE FREIN	4253 61	cf. Photo
	1,8 16V		10.2006		13.0460-7229.2	607229	PLAQUETTES DE FREIN	4253 61	cf. Photo
	2,0 16V		10.2006		13.0460-7230.2	607230	PLAQUETTES DE FREIN	4253 62	cf. Photo
	2,0 HDi 135		10.2006		13.0460-7230.2	607230	PLAQUETTES DE FREIN	4253 62	cf. Photo









					description	Références OE par référence ATE.		Références remplacées / divers
--	--	--	--	--	-------------	----------------------------------	--	--------------------------------

FORD

GALAXY II (06-)	1,8 TDCi		04.2006		13.0460-2722.2	602722	PLAQUETTES DE FREIN	1439866 , 1459450 , 1426144	cf. Photo
			04.2006		13.0460-7228.2	607228	PLAQUETTES DE FREIN	1458247 , 1436498 , 1379971 , 1437761 , 30793107 , 30793540 , 30793941	cf. Photo
	2,0 i 16V		04.2006		13.0460-2722.2	602722	PLAQUETTES DE FREIN	1439866 , 1459450 , 1426144	cf. Photo
			04.2006		13.0460-7228.2	607228	PLAQUETTES DE FREIN	1458247 , 1436498 , 1379971 , 1437761 , 30793107 , 30793540 , 30793941	cf. Photo
	2,0 TDCi		04.2006		13.0460-2722.2	602722	PLAQUETTES DE FREIN	1439866 , 1459450 , 1426144	cf. Photo
			04.2006		13.0460-7228.2	607228	PLAQUETTES DE FREIN	1458247 , 1436498 , 1379971 , 1437761 , 30793107 , 30793540 , 30793941	cf. Photo
	2,3 i 16V		07.2007		13.0460-7228.2	607228	PLAQUETTES DE FREIN	1458247 , 1436498 , 1379971 , 1437761 , 30793107 , 30793540 , 30793941	cf. Photo
			07.2007		13.0460-2722.2	602722	PLAQUETTES DE FREIN	1439866 , 1459450 , 1426144	cf. Photo
MONDEO IV (07-)	1,6 Ti VCT		04.2007		13.0460-7228.2	607228	PLAQUETTES DE FREIN	1458247 , 1436498 , 1379971 , 1437761 , 30793107 , 30793540 , 30793941	cf. Photo
	1,8 TDCi		04.2007		13.0460-7228.2	607228	PLAQUETTES DE FREIN	1458247 , 1436498 , 1379971 , 1437761 , 30793107 , 30793540 , 30793941	cf. Photo



		 		description	Références OE par référence ATE.	 Références remplacées / divers
---	---	---	---	-------------	--	---

FORD

MONDEO IV (07-)	2,0 i 16V		04.2007		13.0460-7228.2	607228	PLAQUETTES DE FREIN	1458247 , 1436498 , 1379971 , 1437761 , 30793107 , 30793540 , 30793941	cf. Photo
	2,0 TDCi		04.2007		13.0460-7228.2	607228	PLAQUETTES DE FREIN	1458247 , 1436498 , 1379971 , 1437761 , 30793107 , 30793540 , 30793941	cf. Photo
	2,3 i 16V		07.2007		13.0460-7228.2	607228	PLAQUETTES DE FREIN	1458247 , 1436498 , 1379971 , 1437761 , 30793107 , 30793540 , 30793941	cf. Photo
	2,5 i 20V		04.2007		13.0460-7228.2	607228	PLAQUETTES DE FREIN	1458247 , 1436498 , 1379971 , 1437761 , 30793107 , 30793540 , 30793941	cf. Photo
S-MAX (06-)	1,8 TDCi		04.2006		13.0460-2722.2	602722	PLAQUETTES DE FREIN	1439866 , 1459450 , 1426144	cf. Photo
			04.2006		13.0460-7228.2	607228	PLAQUETTES DE FREIN	1458247 , 1436498 , 1379971 , 1437761 , 30793107 , 30793540 , 30793941	cf. Photo
	2,0 i 16V		04.2006		13.0460-2722.2	602722	PLAQUETTES DE FREIN	1439866 , 1459450 , 1426144	cf. Photo
			04.2006		13.0460-7228.2	607228	PLAQUETTES DE FREIN	1458247 , 1436498 , 1379971 , 1437761 , 30793107 , 30793540 , 30793941	cf. Photo
	2,0 TDCi		04.2006		13.0460-2722.2	602722	PLAQUETTES DE FREIN	1439866 , 1459450 , 1426144	cf. Photo
			04.2006		13.0460-7228.2	607228	PLAQUETTES DE FREIN	1458247 , 1436498 , 1379971 , 1437761 , 30793107 , 30793540 , 30793941	cf. Photo

Nouvelles références disponibles - par applications

11/2007



					description	Références OE par référence ATE.		Références remplacées / divers
--	--	--	--	--	-------------	----------------------------------	--	--------------------------------

FORD

S-MAX (06-)	2,3 i 16V		07.2007		13.0460-7228.2	607228	PLAQUETTES DE FREIN	1458247 , 1436498 , 1379971 , 1437761 , 30793107 , 30793540 , 30793941	cf. Photo
			07.2007		13.0460-2722.2	602722	PLAQUETTES DE FREIN	1439866 , 1459450 , 1426144	cf. Photo
	2,5 i 20V		04.2006		13.0460-2722.2	602722	PLAQUETTES DE FREIN	1439866 , 1459450 , 1426144	cf. Photo

HONDA

ACCORD Break (03-)	2,0 i 16V (CM1)		04.2003		24.0125-0174.1	425174	DISQUE DE FREIN	45251-SEA-E30	
	2,2 CTDi (CN2)		01.2004		24.0125-0174.1	425174	DISQUE DE FREIN	45251-SEA-E30	
	2,4 i 16V (CM2)		04.2003		24.0125-0174.1	425174	DISQUE DE FREIN	45251-SEA-E30	
ACCORD Berline (03-)	2,0 i 16V (CL7)		02.2003		24.0125-0174.1	425174	DISQUE DE FREIN	45251-SEA-E30	
	2,2 CTDi (CN1)		01.2004		24.0125-0174.1	425174	DISQUE DE FREIN	45251-SEA-E30	
	2,4 i 16V (CL9)		02.2003		24.0125-0174.1	425174	DISQUE DE FREIN	45251-SEA-E30	
CR-V II (02-06)	2,0 i 16V		07.2002	09.2006	24.0109-0144.1	409144	DISQUE DE FREIN	42510-SCA-E00 , 42510-S9A-N00	
	2,2 CTDi		02.2005	09.2006	24.0109-0144.1	409144	DISQUE DE FREIN	42510-SCA-E00 , 42510-S9A-N00	
	2,4 VTEC		03.2002	09.2006	24.0109-0144.1	409144	DISQUE DE FREIN	42510-SCA-E00 , 42510-S9A-N00	



						description	Références OE par référence ATE.		Références remplacées / divers
--	--	--	--	--	--	-------------	----------------------------------	--	--------------------------------

HYUNDAI

ATOS / AMICA (GB) (98-)	1,0 i 12V		09.2000	07.2003	24.0118-0138.1	418138	DISQUE DE FREIN	51712-02550 , 51712-02551	
			01.1998	08.2000	24.0118-0138.1	418138	DISQUE DE FREIN	51712-02550 , 51712-02551	
	1,0 i 12V Prime		09.1999	07.2003	24.0118-0138.1	418138	DISQUE DE FREIN	51712-02550 , 51712-02551	
			09.2000		24.0118-0138.1	418138	DISQUE DE FREIN	51712-02550 , 51712-02551	
	1,1 i 12V		03.2004		24.0118-0138.1	418138	DISQUE DE FREIN	51712-02550 , 51712-02551	
	1,1 i 12V Prime		08.2003		24.0118-0138.1	418138	DISQUE DE FREIN	51712-02550 , 51712-02551	
TERRACAN (01-)	2,5 TDiC		11.2001	10.2003	13.0460-5886.2	605886	PLAQUETTES DE FREIN	58101-H1A00 , 58101-H1A10 , 58101-H1A01	cf. Photo
	2,9 CRDi		11.2001	10.2003	13.0460-5886.2	605886	PLAQUETTES DE FREIN	58101-H1A00 , 58101-H1A10 , 58101-H1A01	cf. Photo
	3,5 i V6 4WD		11.2001	10.2003	13.0460-5886.2	605886	PLAQUETTES DE FREIN	58101-H1A00 , 58101-H1A10 , 58101-H1A01	cf. Photo

LANCIA

YPSILON (03-)	1,2 i		08.2006		13.0460-2724.2	602724	PLAQUETTES DE FREIN	77364332 , 77364331	cf. Photo
	1,2 i 16V		08.2006		13.0460-2724.2	602724	PLAQUETTES DE FREIN	77364332 , 77364331	cf. Photo
	1,3 JTD		08.2006		13.0460-2724.2	602724	PLAQUETTES DE FREIN	77364332 , 77364331	cf. Photo
	1,4 i		08.2006		13.0460-2724.2	602724	PLAQUETTES DE FREIN	77364332 , 77364331	cf. Photo
	1,4 i 16V		08.2006		13.0460-2724.2	602724	PLAQUETTES DE FREIN	77364332 , 77364331	cf. Photo

Nouvelles références disponibles - par applications

11/2007



					description	Références OE par référence ATE.		Références remplacées / divers
--	--	--	--	--	-------------	----------------------------------	--	--------------------------------

MERCEDES BENZ

Classe C (CL203) Sportcoupé (01-)	C 30 CDI AMG		09.2002		24.0130-0180.1	430180	DISQUE DE FREIN	203 421 09 12	
C-Klasse (S203) Kombi (01-07)			01.2003	09.2007	24.0130-0180.1	430180	DISQUE DE FREIN	203 421 09 12	
	C 55 AMG		02.2004	09.2007	24.0130-0180.1	430180	DISQUE DE FREIN	203 421 09 12	
Classe C (W203) Berline (00-07)	C 30 CDI AMG		01.2003	04.2007	24.0130-0180.1	430180	DISQUE DE FREIN	203 421 09 12	
	C 55 AMG		02.2004	04.2007	24.0130-0180.1	430180	DISQUE DE FREIN	203 421 09 12	
Classe CLK (A209) Décapotable (03-)	CLK 55 AMG		05.2003		24.0130-0180.1	430180	DISQUE DE FREIN	203 421 09 12	
Classe CLK (C209) Coupé (02-)			09.2002		24.0130-0180.1	430180	DISQUE DE FREIN	203 421 09 12	
Classe CL (C215) Coupé (99-06)	CL 55 Kompressor AMG		06.2002	08.2006	24.0136-0105.1	436105	DISQUE DE FREIN	220 421 19 12	
Classe CLS (C219) Coupé (04-)	CLS 55 AMG		01.2005		24.0136-0102.1	436102	DISQUE DE FREIN	230 421 07 12	
Classe E (S211) Break (03-)	E 55 Kompressor AMG		07.2003		24.0136-0102.1	436102	DISQUE DE FREIN	230 421 07 12	
Classe E (W211) Berline (02-)			10.2002		24.0136-0102.1	436102	DISQUE DE FREIN	230 421 07 12	
Classe G (W460) (79-93)	200 GE		05.1986		83.7701-0450.3	330841	FLEXIBLE FREIN	300 12 535 , 460 428 51 35 , 113 611 701	83.6101-0450.3
	230 G		02.1979	08.1985	83.7701-0450.3	330841	FLEXIBLE FREIN	300 12 535 , 460 428 51 35 , 113 611 701	83.6101-0450.3
	230 GE		04.1982		83.7701-0450.3	330841	FLEXIBLE FREIN	300 12 535 , 460 428 51 35 , 113 611 701	83.6101-0450.3
	240 GD		02.1979		83.7701-0450.3	330841	FLEXIBLE FREIN	300 12 535 , 460 428 51 35 , 113 611 701	83.6101-0450.3
	250 GD		08.1987		83.7701-0450.3	330841	FLEXIBLE FREIN	300 12 535 , 460 428 51 35 , 113 611 701	83.6101-0450.3
	280 GE		02.1979		83.7701-0450.3	330841	FLEXIBLE FREIN	300 12 535 , 460 428 51 35 , 113 611 701	83.6101-0450.3



					description	Références OE par référence ATE.		Références remplacées / divers
--	--	--	--	--	-------------	----------------------------------	--	--------------------------------

MERCEDES BENZ

Classe G (W460) (79-93)	300 GD		02.1979		83.7701-0450.3	330841	FLEXIBLE FREIN	300 12 535 , 460 428 51 35 , 113 611 701	83.6101-0450.3
Classe G (W461) (90-05)	230 GE		02.1993		83.7701-0450.3	330841	FLEXIBLE FREIN	300 12 535 , 460 428 51 35 , 113 611 701	83.6101-0450.3
	250 GD		02.1990		83.7701-0450.3	330841	FLEXIBLE FREIN	300 12 535 , 460 428 51 35 , 113 611 701	83.6101-0450.3
	290 GD		04.1992		83.7701-0450.3	330841	FLEXIBLE FREIN	300 12 535 , 460 428 51 35 , 113 611 701	83.6101-0450.3
	G 290 TD		07.1997		83.7701-0450.3	330841	FLEXIBLE FREIN	300 12 535 , 460 428 51 35 , 113 611 701	83.6101-0450.3
Classe G (W463) (90-05)	230 GE		06.1990		83.7701-0450.3	330841	FLEXIBLE FREIN	300 12 535 , 460 428 51 35 , 113 611 701	83.6101-0450.3
	250 GD		06.1990		83.7701-0450.3	330841	FLEXIBLE FREIN	300 12 535 , 460 428 51 35 , 113 611 701	83.6101-0450.3
	300 GD		09.1989		83.7701-0450.3	330841	FLEXIBLE FREIN	300 12 535 , 460 428 51 35 , 113 611 701	83.6101-0450.3
	300 GE		06.1990		83.7701-0450.3	330841	FLEXIBLE FREIN	300 12 535 , 460 428 51 35 , 113 611 701	83.6101-0450.3
	350 G Turbo		09.1991		83.7701-0450.3	330841	FLEXIBLE FREIN	300 12 535 , 460 428 51 35 , 113 611 701	83.6101-0450.3
	G 270 CDI		10.2001		83.7701-0450.3	330841	FLEXIBLE FREIN	300 12 535 , 460 428 51 35 , 113 611 701	83.6101-0450.3
	G 300 TD		08.1996		83.7701-0450.3	330841	FLEXIBLE FREIN	300 12 535 , 460 428 51 35 , 113 611 701	83.6101-0450.3
	G 320		09.1994		83.7701-0450.3	330841	FLEXIBLE FREIN	300 12 535 , 460 428 51 35 , 113 611 701	83.6101-0450.3

Nouvelles références disponibles - par applications

11/2007



					description	Références OE par référence ATE.		Références remplacées / divers
--	--	--	--	--	-------------	----------------------------------	--	--------------------------------

MERCEDES BENZ

Classe G (W463) (90-05)	G 36 AMG		01.1995		83.7701-0450.3	330841	FLEXIBLE FREIN	300 12 535 , 460 428 51 35 , 113 611 701	83.6101-0450.3
	G 400 CDI		12.2000		83.7701-0450.3	330841	FLEXIBLE FREIN	300 12 535 , 460 428 51 35 , 113 611 701	83.6101-0450.3
	G 500		04.1998		83.7701-0450.3	330841	FLEXIBLE FREIN	300 12 535 , 460 428 51 35 , 113 611 701	83.6101-0450.3
	G 500 E		09.1993		83.7701-0450.3	330841	FLEXIBLE FREIN	300 12 535 , 460 428 51 35 , 113 611 701	83.6101-0450.3
	G 55 AMG		04.1999		83.7701-0450.3	330841	FLEXIBLE FREIN	300 12 535 , 460 428 51 35 , 113 611 701	83.6101-0450.3
Classe G (W463) Décapotable (90-05)	230 GE		06.1990		83.7701-0450.3	330841	FLEXIBLE FREIN	300 12 535 , 460 428 51 35 , 113 611 701	83.6101-0450.3
	300 GD		12.1990		83.7701-0450.3	330841	FLEXIBLE FREIN	300 12 535 , 460 428 51 35 , 113 611 701	83.6101-0450.3
	300 GE		09.1989		83.7701-0450.3	330841	FLEXIBLE FREIN	300 12 535 , 460 428 51 35 , 113 611 701	83.6101-0450.3
	320 GE		09.1994		83.7701-0450.3	330841	FLEXIBLE FREIN	300 12 535 , 460 428 51 35 , 113 611 701	83.6101-0450.3
	350 G Turbo		09.1991		83.7701-0450.3	330841	FLEXIBLE FREIN	300 12 535 , 460 428 51 35 , 113 611 701	83.6101-0450.3
	G 300 TD		09.1996		83.7701-0450.3	330841	FLEXIBLE FREIN	300 12 535 , 460 428 51 35 , 113 611 701	83.6101-0450.3
	G 320		11.1997		83.7701-0450.3	330841	FLEXIBLE FREIN	300 12 535 , 460 428 51 35 , 113 611 701	83.6101-0450.3
	G 400 CDI		12.2000		83.7701-0450.3	330841	FLEXIBLE FREIN	300 12 535 , 460 428 51 35 , 113 611 701	83.6101-0450.3









					description	Références OE par référence ATE.		Références remplacées / divers
--	--	--	--	--	-------------	----------------------------------	--	--------------------------------

MERCEDES BENZ

Classe G (W463) Décapotable (90-05)	G 500		04.1998		83.7701-0450.3	330841	FLEXIBLE FREIN	300 12 535 , 460 428 51 35 , 113 611 701	83.6101-0450.3
Classe M (W164) (05-)	ML 280 CDI		07.2005		24.0114-0114.1	414114	DISQUE DE FREIN	164 423 05 12	
	ML 320 CDI		07.2005		24.0114-0114.1	414114	DISQUE DE FREIN	164 423 05 12	
	ML 350		07.2005		24.0114-0114.1	414114	DISQUE DE FREIN	164 423 05 12	
Classe R (R251) (06-)	R 280		01.2007		24.0114-0114.1	414114	DISQUE DE FREIN	164 423 05 12	
	R 280 CDI		11.2005		24.0114-0114.1	414114	DISQUE DE FREIN	164 423 05 12	
	R 300		01.2007		24.0114-0114.1	414114	DISQUE DE FREIN	164 423 05 12	
	R 320 CDI		11.2005		24.0114-0114.1	414114	DISQUE DE FREIN	164 423 05 12	
	R 350		11.2005		24.0114-0114.1	414114	DISQUE DE FREIN	164 423 05 12	
Classe S (W220) (98-06)	S 55 AMG Kompressor		06.2002	03.2006	24.0136-0105.1	436105	DISQUE DE FREIN	220 421 19 12	
Classe SL (R230) (01-)	SL 600		04.2003		24.0136-0102.1	436102	DISQUE DE FREIN	230 421 07 12	



					description	Références OE par référence ATE.	 Références remplacées / divers
---	---	---	---	---	-------------	--	--

MITSUBISHI

Modèle	Moteur		09.2000	10.2003	24.0126-0131.1	426131	DISQUE DE FREIN	MR510741 , MR510742	
GALANT (96-03)	2,0 i 16V (EA2)		10.1996	08.2000	24.0126-0131.1	426131	DISQUE DE FREIN	MR510741 , MR510742	
	2,5 i V6 (EA5)		10.1996	08.2000	24.0126-0131.1	426131	DISQUE DE FREIN	MR510741 , MR510742	
			09.2000	10.2003	24.0126-0131.1	426131	DISQUE DE FREIN	MR510741 , MR510742	
LANCER Break (03-)	1,6 i 16V (CS3W)		09.2003		24.0126-0131.1	426131	DISQUE DE FREIN	MR510741 , MR510742	
LANCER Berline (03-)	1,3 i 16V (CS1A)		09.2003		24.0126-0131.1	426131	DISQUE DE FREIN	MR510741 , MR510742	
	1,6 i 16V (CS3A)		09.2003		24.0126-0131.1	426131	DISQUE DE FREIN	MR510741 , MR510742	



					description	Références OE par référence ATE.		Références remplacées / divers
--	--	--	--	--	-------------	----------------------------------	--	--------------------------------

NISSAN

MAXIMA (CA33) (00-)	2,0 i V6		03.2000		13.0460-5880.2	605880	PLAQUETTES DE FREIN	41060-3Y690 , D1060-3Y690	cf. Photo
	2,5 i V6		03.2000		13.0460-5880.2	605880	PLAQUETTES DE FREIN	41060-3Y690 , D1060-3Y690	cf. Photo
	3,0 i V6		03.2000		13.0460-5880.2	605880	PLAQUETTES DE FREIN	41060-3Y690 , D1060-3Y690	cf. Photo
QASHQAI (J10E) (07-)	1,5 dCi		02.2007		13.0460-5752.2	605752	PLAQUETTES DE FREIN	D1060-JD00A	cf. Photo
	1,6		02.2007		13.0460-5752.2	605752	PLAQUETTES DE FREIN	D1060-JD00A	cf. Photo
	2		02.2007		13.0460-5752.2	605752	PLAQUETTES DE FREIN	D1060-JD00A	cf. Photo
	2,0 Allrad		02.2007		13.0460-5752.2	605752	PLAQUETTES DE FREIN	D1060-JD00A	cf. Photo
	2,0 dCi		02.2007		13.0460-5752.2	605752	PLAQUETTES DE FREIN	D1060-JD00A	cf. Photo
	2,0 dCi Allrad		02.2007		13.0460-5752.2	605752	PLAQUETTES DE FREIN	D1060-JD00A	cf. Photo
X-TRAIL (T31) (07-)	2		03.2007		13.0460-5752.2	605752	PLAQUETTES DE FREIN	D1060-JD00A	cf. Photo
	2,0 4WD		03.2007		13.0460-5752.2	605752	PLAQUETTES DE FREIN	D1060-JD00A	cf. Photo
	2,0 Turbo 4WD		03.2007		13.0460-5752.2	605752	PLAQUETTES DE FREIN	D1060-JD00A	cf. Photo
	2,2 dCi		03.2007		13.0460-5752.2	605752	PLAQUETTES DE FREIN	D1060-JD00A	cf. Photo
	2,2 dCi 4WD		03.2007		13.0460-5752.2	605752	PLAQUETTES DE FREIN	D1060-JD00A	cf. Photo
	2,5 4WD		03.2007		13.0460-5752.2	605752	PLAQUETTES DE FREIN	D1060-JD00A	cf. Photo

Nouvelles références disponibles - par applications

11/2007









					description	Références OE par référence ATE.		Références remplacées / divers
--	--	--	--	--	-------------	----------------------------------	--	--------------------------------

PEUGEOT

206 CC (00-)	CC 110				24.3728-0848.2	590848	CABLE D'EMBAYAGE	2150 CK	
	CC 135				24.3728-0849.2	590849	CABLE D'EMBAYAGE	2150 CH	
206 Berline (98-)	1,1				24.3728-0848.2	590848	CABLE D'EMBAYAGE	2150 CK	
	1,4				24.3728-0848.2	590848	CABLE D'EMBAYAGE	2150 CK	
	1,4 16V				24.3728-0848.2	590848	CABLE D'EMBAYAGE	2150 CK	
	1,4 HDi				24.3728-0849.2	590849	CABLE D'EMBAYAGE	2150 CH	
	1,6 16V				24.3728-0848.2	590848	CABLE D'EMBAYAGE	2150 CK	
	2,0 HDi				24.3728-0849.2	590849	CABLE D'EMBAYAGE	2150 CH	
	2,0 RC		07.2003		24.3728-0849.2	590849	CABLE D'EMBAYAGE	2150 CH	
	2,0 S16				24.3728-0849.2	590849	CABLE D'EMBAYAGE	2150 CH	
206 SW (02-)	1,1				24.3728-0848.2	590848	CABLE D'EMBAYAGE	2150 CK	
	1,4				24.3728-0848.2	590848	CABLE D'EMBAYAGE	2150 CK	
	1,4 16V				24.3728-0848.2	590848	CABLE D'EMBAYAGE	2150 CK	
	1,4 HDi				24.3728-0849.2	590849	CABLE D'EMBAYAGE	2150 CH	
	1,6 16V				24.3728-0848.2	590848	CABLE D'EMBAYAGE	2150 CK	
	2,0 HDi				24.3728-0849.2	590849	CABLE D'EMBAYAGE	2150 CH	
	2,0 S16				24.3728-0849.2	590849	CABLE D'EMBAYAGE	2150 CH	
405 (93-95)	1,6		09.1992	10.1995	24.3728-0843.2	590843	CABLE D'EMBAYAGE	2150 G2	24.3728-0830.2
	1,8 i		09.1992	10.1995	24.3728-0843.2	590843	CABLE D'EMBAYAGE	2150 G2	24.3728-0830.2



					<p>description</p>	<p>Références OE par référence ATE.</p>	 <p>Références remplacées / divers</p>
---	---	---	---	---	--------------------	---	---

PEUGEOT

405 (93-95)	1,9		09.1992	12.1993	24.3728-0843.2	590843	CABLE D'EMBAYAGE	2150 G2	24.3728-0830.2
	1,9 D		09.1992	10.1995	24.3728-0843.2	590843	CABLE D'EMBAYAGE	2150 G2	24.3728-0830.2
	2,0 i		09.1992	10.1995	24.3728-0843.2	590843	CABLE D'EMBAYAGE	2150 G2	24.3728-0830.2

Nouvelles références disponibles - par applications

11/2007



					description	Références OE par référence ATE.		Références remplacées / divers
--	--	--	--	--	-------------	----------------------------------	--	--------------------------------

PORSCHE

911 (996) (97-)	3,4 CARRERA	ArG	01.2002		24.0128-0196.1	428196	DISQUE DE FREIN GAUCHE	996 352 405 00	
		AvD	01.2002		24.0134-0102.1	434102	DISQUE DE FREIN DROIT	996 351 410 02	
		ArD	01.2002		24.0128-0197.1	428197	DISQUE DE FREIN DROIT	996 352 406 00	
	3,4 CARRERA 4	ArG	01.2002		24.0128-0196.1	428196	DISQUE DE FREIN GAUCHE	996 352 405 00	
		AvD	01.2002		24.0134-0102.1	434102	DISQUE DE FREIN DROIT	996 351 410 02	
		ArD	01.2002		24.0128-0197.1	428197	DISQUE DE FREIN DROIT	996 352 406 00	
	3,6 CARRERA	ArG	01.2002		24.0128-0196.1	428196	DISQUE DE FREIN GAUCHE	996 352 405 00	
		ArD	01.2002		24.0128-0197.1	428197	DISQUE DE FREIN DROIT	996 352 406 00	
		AvD	01.2002		24.0134-0102.1	434102	DISQUE DE FREIN DROIT	996 351 410 02	
	3,6 CARRERA 4	ArG	01.2002		24.0128-0196.1	428196	DISQUE DE FREIN GAUCHE	996 352 405 00	
		ArD	01.2002		24.0128-0197.1	428197	DISQUE DE FREIN DROIT	996 352 406 00	
		AvD	01.2002		24.0134-0102.1	434102	DISQUE DE FREIN DROIT	996 351 410 02	
	3,6 GT2	ArG	04.2001		24.0128-0196.1	428196	DISQUE DE FREIN GAUCHE	996 352 405 00	
		ArD	04.2001		24.0128-0197.1	428197	DISQUE DE FREIN DROIT	996 352 406 00	
	3,6 GT3	ArG	03.1999		24.0128-0196.1	428196	DISQUE DE FREIN GAUCHE	996 352 405 00	
		ArD	03.1999		24.0128-0197.1	428197	DISQUE DE FREIN DROIT	996 352 406 00	
	3,6 TURBO 4	ArG	06.2000		24.0128-0196.1	428196	DISQUE DE FREIN GAUCHE	996 352 405 00	
		ArD	06.2000		24.0128-0197.1	428197	DISQUE DE FREIN DROIT	996 352 406 00	
		AvD	06.2000		24.0134-0102.1	434102	DISQUE DE FREIN DROIT	996 351 410 02	

Nouvelles références disponibles - par applications

11/2007









					description	Références OE par référence ATE.		Références remplacées / divers
--	--	--	--	--	-------------	----------------------------------	--	--------------------------------

PORSCHE

911 DECAPOTABLE (996) (98-)	3,4 CARRERA	ArG	01.2002		24.0128-0196.1	428196	DISQUE DE FREIN GAUCHE	996 352 405 00	
		AvD	01.2002		24.0134-0102.1	434102	DISQUE DE FREIN DROIT	996 351 410 02	
		ArD	01.2002		24.0128-0197.1	428197	DISQUE DE FREIN DROIT	996 352 406 00	
	3,4 CARRERA 4	ArG	01.2002		24.0128-0196.1	428196	DISQUE DE FREIN GAUCHE	996 352 405 00	
		ArD	01.2002		24.0128-0197.1	428197	DISQUE DE FREIN DROIT	996 352 406 00	
		AvD	01.2002		24.0134-0102.1	434102	DISQUE DE FREIN DROIT	996 351 410 02	
	3,6 CARRERA	ArG	01.2002		24.0128-0196.1	428196	DISQUE DE FREIN GAUCHE	996 352 405 00	
		ArD	01.2002		24.0128-0197.1	428197	DISQUE DE FREIN DROIT	996 352 406 00	
		AvD	01.2002		24.0134-0102.1	434102	DISQUE DE FREIN DROIT	996 351 410 02	
	3,6 CARRERA 4	ArG	01.2002		24.0128-0196.1	428196	DISQUE DE FREIN GAUCHE	996 352 405 00	
		AvD	01.2002		24.0134-0102.1	434102	DISQUE DE FREIN DROIT	996 351 410 02	
		ArD	01.2002		24.0128-0197.1	428197	DISQUE DE FREIN DROIT	996 352 406 00	
	3,6 TURBO 4	ArG	10.2003		24.0128-0196.1	428196	DISQUE DE FREIN GAUCHE	996 352 405 00	
		AvD	10.2003		24.0134-0102.1	434102	DISQUE DE FREIN DROIT	996 351 410 02	
		ArD	10.2003		24.0128-0197.1	428197	DISQUE DE FREIN DROIT	996 352 406 00	
911 DECAPOTABLE (997) (05-)	3,8 CARRERA 4S	ArG	04.2005		24.0128-0196.1	428196	DISQUE DE FREIN GAUCHE	996 352 405 00	
		AvD	04.2005		24.0134-0102.1	434102	DISQUE DE FREIN DROIT	996 351 410 02	
		ArD	04.2005		24.0128-0197.1	428197	DISQUE DE FREIN DROIT	996 352 406 00	
	3,8 CARRERA S	ArG	04.2005		24.0128-0196.1	428196	DISQUE DE FREIN GAUCHE	996 352 405 00	



					<p>description</p>	<p>Références OE par référence ATE.</p>	 <p>Références remplacées / divers</p>
---	---	---	---	---	--------------------	---	---

PORSCHE

911 DECAPOTABLE (997) (05-)	3,8 CARRERA S	AvD	04.2005		24.0134-0102.1	434102	DISQUE DE FREIN DROIT	996 351 410 02	
		ArD	04.2005		24.0128-0197.1	428197	DISQUE DE FREIN DROIT	996 352 406 00	
911 COUPE (997) (04-)	3,8 CARRERA 4S	ArG	07.2004		24.0128-0196.1	428196	DISQUE DE FREIN GAUCHE	996 352 405 00	
		ArD	07.2004		24.0128-0197.1	428197	DISQUE DE FREIN DROIT	996 352 406 00	
		AvD	07.2004		24.0134-0102.1	434102	DISQUE DE FREIN DROIT	996 351 410 02	
	3,8 CARRERA S	ArG	07.2004		24.0128-0196.1	428196	DISQUE DE FREIN GAUCHE	996 352 405 00	
		ArD	07.2004		24.0128-0197.1	428197	DISQUE DE FREIN DROIT	996 352 406 00	
		AvD	07.2004		24.0134-0102.1	434102	DISQUE DE FREIN DROIT	996 351 410 02	

Nouvelles références disponibles - par applications

11/2007



					description	Références OE par référence ATE.		Références remplacées / divers
--	--	--	--	--	-------------	----------------------------------	--	--------------------------------

RENAULT

LAGUNA II Grandtour (KG_) (01-07)	1,6 16V		04.2005		03.4153-0063.3	010773	MAITRE CYL. TANDEM	77 01 208 713	
	1,8 16V (O4/O6/OV)		04.2005		03.4153-0063.3	010773	MAITRE CYL. TANDEM	77 01 208 713	
	1,8 16V (OB/OC/OM)		04.2005		03.4153-0063.3	010773	MAITRE CYL. TANDEM	77 01 208 713	
	1,8 16V (OJ)		04.2005		03.4153-0063.3	010773	MAITRE CYL. TANDEM	77 01 208 713	
	1,9 dCi		04.2005		03.4153-0063.3	010773	MAITRE CYL. TANDEM	77 01 208 713	
			05.2005		03.4153-0063.3	010773	MAITRE CYL. TANDEM	77 01 208 713	
			01.2005		03.4153-0063.3	010773	MAITRE CYL. TANDEM	77 01 208 713	
	1,9 dCi (O8/10)		04.2005		03.4153-0063.3	010773	MAITRE CYL. TANDEM	77 01 208 713	
	1,9 dCi (OE)		04.2005		03.4153-0063.3	010773	MAITRE CYL. TANDEM	77 01 208 713	
	1,9 dCi (OG)		04.2005		03.4153-0063.3	010773	MAITRE CYL. TANDEM	77 01 208 713	
	1,9 dCi (OR)		04.2005		03.4153-0063.3	010773	MAITRE CYL. TANDEM	77 01 208 713	
	2,0 16V		01.2005		03.4153-0063.3	010773	MAITRE CYL. TANDEM	77 01 208 713	
	2,0 16V (OO/OK/OW)		04.2005		03.4153-0063.3	010773	MAITRE CYL. TANDEM	77 01 208 713	
	2,0 16V IDE (ON/OP)		04.2005		03.4153-0063.3	010773	MAITRE CYL. TANDEM	77 01 208 713	
	2,0 16V Sport		01.2005		03.4153-0063.3	010773	MAITRE CYL. TANDEM	77 01 208 713	
	2,0 16V Turbo		01.2003		03.4153-0063.3	010773	MAITRE CYL. TANDEM	77 01 208 713	
	2,0 dCi		08.2005		03.4153-0063.3	010773	MAITRE CYL. TANDEM	77 01 208 713	
	2,0 dCi 130		01.2006		03.4153-0063.3	010773	MAITRE CYL. TANDEM	77 01 208 713	
	2,2 dCi		04.2005		03.4153-0063.3	010773	MAITRE CYL. TANDEM	77 01 208 713	

Nouvelles références disponibles - par applications

11/2007









					description	Références OE par référence ATE.		Références remplacées / divers
--	--	--	--	--	-------------	----------------------------------	--	--------------------------------

RENAULT

LAGUNA II Grandtour (KG_) (01-07)	2,2 dCi		05.2005		03.4153-0063.3	010773	MAITRE CYL. TANDEM	77 01 208 713	
	3,0 V6		04.2005		03.4153-0063.3	010773	MAITRE CYL. TANDEM	77 01 208 713	
LAGUNA II Limousine (BG_) (01-07)	1,6 16V		04.2005		03.4153-0063.3	010773	MAITRE CYL. TANDEM	77 01 208 713	
	1,8 16V (O4/O6/OV)		04.2005		03.4153-0063.3	010773	MAITRE CYL. TANDEM	77 01 208 713	
	1,8 16V (OB/OC/OM)		04.2005		03.4153-0063.3	010773	MAITRE CYL. TANDEM	77 01 208 713	
	1,8 16V (OJ)		04.2005		03.4153-0063.3	010773	MAITRE CYL. TANDEM	77 01 208 713	
	1,9 dCi		04.2005		03.4153-0063.3	010773	MAITRE CYL. TANDEM	77 01 208 713	
			05.2005		03.4153-0063.3	010773	MAITRE CYL. TANDEM	77 01 208 713	
	1,9 dCi (O8/10)		04.2005		03.4153-0063.3	010773	MAITRE CYL. TANDEM	77 01 208 713	
	1,9 dCi (OE)		04.2005		03.4153-0063.3	010773	MAITRE CYL. TANDEM	77 01 208 713	
	1,9 dCi (OG)		04.2005		03.4153-0063.3	010773	MAITRE CYL. TANDEM	77 01 208 713	
	1,9 dCi (OR)		04.2005		03.4153-0063.3	010773	MAITRE CYL. TANDEM	77 01 208 713	
	2,0 16V		04.2005		03.4153-0063.3	010773	MAITRE CYL. TANDEM	77 01 208 713	
	2,0 16V (OO/OK/OW)		04.2005		03.4153-0063.3	010773	MAITRE CYL. TANDEM	77 01 208 713	
	2,0 16V IDE (ON/OP)		04.2005		03.4153-0063.3	010773	MAITRE CYL. TANDEM	77 01 208 713	
	2,0 16V Sport		04.2005		03.4153-0063.3	010773	MAITRE CYL. TANDEM	77 01 208 713	
	2,0 16V Turbo		01.2003		03.4153-0063.3	010773	MAITRE CYL. TANDEM	77 01 208 713	
	2,0 dCi		08.2005		03.4153-0063.3	010773	MAITRE CYL. TANDEM	77 01 208 713	
	2,0 dCi 130		01.2006		03.4153-0063.3	010773	MAITRE CYL. TANDEM	77 01 208 713	



		 		<p>description</p>	<p>Références OE par référence ATE.</p>	 <p>Références remplacées / divers</p>
---	---	---	---	--------------------	---	---

RENAULT

Modèle	Moteur		Date		Réf. ATE	Réf. OE	Description	Réf. OE	
LAGUNA II Limousine (BG_) (01-07)	2,2 dCi		04.2005		03.4153-0063.3	010773	MAITRE CYL. TANDEM	77 01 208 713	
			05.2005		03.4153-0063.3	010773	MAITRE CYL. TANDEM	77 01 208 713	
	3,0 V6		04.2005		03.4153-0063.3	010773	MAITRE CYL. TANDEM	77 01 208 713	

Nouvelles références disponibles - par applications

11/2007



				description	Références OE par référence ATE.		Références remplacées / divers
--	--	--	--	-------------	----------------------------------	--	--------------------------------

SEAT

ALTEA (5P1) (04-)	1,6 i 16V		03.2004		03.2122-1963.3	010772	MAITRE CYL. TANDEM	1K1 614 019	
	1,8 TFSI		01.2007		03.2122-1963.3	010772	MAITRE CYL. TANDEM	1K1 614 019	
	1,9 TDI		03.2004		03.2122-1963.3	010772	MAITRE CYL. TANDEM	1K1 614 019	
	2,0 FSI		03.2004		03.2122-1963.3	010772	MAITRE CYL. TANDEM	1K1 614 019	
	2,0 i 16V		03.2004		03.2122-1963.3	010772	MAITRE CYL. TANDEM	1K1 614 019	
	2,0 TDI		03.2004		03.2122-1963.3	010772	MAITRE CYL. TANDEM	1K1 614 019	
			03.2006		03.2122-1963.3	010772	MAITRE CYL. TANDEM	1K1 614 019	
	2,0 TFSI		03.2006		03.2122-1963.3	010772	MAITRE CYL. TANDEM	1K1 614 019	
ALTEA XL (5P5) (06-)	1,6 i 16V		10.2006		03.2122-1963.3	010772	MAITRE CYL. TANDEM	1K1 614 019	
	1,8 TFSI		10.2006		03.2122-1963.3	010772	MAITRE CYL. TANDEM	1K1 614 019	
	1,9 TDI		10.2006		03.2122-1963.3	010772	MAITRE CYL. TANDEM	1K1 614 019	
	2,0 FSI		10.2006		03.2122-1963.3	010772	MAITRE CYL. TANDEM	1K1 614 019	
	2,0 TDI		10.2006		03.2122-1963.3	010772	MAITRE CYL. TANDEM	1K1 614 019	
LEON II (1P1) (05-)	1,4 i 16V		08.2005		03.2122-1963.3	010772	MAITRE CYL. TANDEM	1K1 614 019	
	1,6 i		08.2005		03.2122-1963.3	010772	MAITRE CYL. TANDEM	1K1 614 019	
	1,6 i 16V		08.2005		03.2122-1963.3	010772	MAITRE CYL. TANDEM	1K1 614 019	
	1,8 T 20V		08.2005		03.2122-1963.3	010772	MAITRE CYL. TANDEM	1K1 614 019	
	1,8 TFSI		06.2007		03.2122-1963.3	010772	MAITRE CYL. TANDEM	1K1 614 019	
	1,9 TDI		08.2005		03.2122-1963.3	010772	MAITRE CYL. TANDEM	1K1 614 019	

Nouvelles références disponibles - par applications

11/2007



					description	Références OE par référence ATE.		Références remplacées / divers
--	--	--	--	--	-------------	----------------------------------	--	--------------------------------







SEAT

LEON II (1P1) (05-)	2,0 FSI		08.2005		03.2122-1963.3	010772	MAITRE CYL. TANDEM	1K1 614 019	
	2,0 i 16V		08.2005		03.2122-1963.3	010772	MAITRE CYL. TANDEM	1K1 614 019	
	2,0 TDI		02.2006		03.2122-1963.3	010772	MAITRE CYL. TANDEM	1K1 614 019	
			08.2005		03.2122-1963.3	010772	MAITRE CYL. TANDEM	1K1 614 019	
	2,0 TFSI		08.2005		03.2122-1963.3	010772	MAITRE CYL. TANDEM	1K1 614 019	
TOLEDO III (5P2) (05-)	1,6 i 16V		10.2004		03.2122-1963.3	010772	MAITRE CYL. TANDEM	1K1 614 019	
	1,8 TFSI		01.2007		03.2122-1963.3	010772	MAITRE CYL. TANDEM	1K1 614 019	
	1,9 TDI		10.2004		03.2122-1963.3	010772	MAITRE CYL. TANDEM	1K1 614 019	
	2,0 FSI		10.2004		03.2122-1963.3	010772	MAITRE CYL. TANDEM	1K1 614 019	
	2,0 i 16V		10.2004		03.2122-1963.3	010772	MAITRE CYL. TANDEM	1K1 614 019	
	2,0 TDI		10.2004		03.2122-1963.3	010772	MAITRE CYL. TANDEM	1K1 614 019	

SKODA

OCTAVIA II (1Z) (04-)	1,4 i 16V		06.2004		03.2122-1963.3	010772	MAITRE CYL. TANDEM	1K1 614 019	
	1,6 FSI		06.2004		03.2122-1963.3	010772	MAITRE CYL. TANDEM	1K1 614 019	
	1,6 i 16V		06.2004		03.2122-1963.3	010772	MAITRE CYL. TANDEM	1K1 614 019	
	1,9 TDI		06.2004		03.2122-1963.3	010772	MAITRE CYL. TANDEM	1K1 614 019	
	2,0 FSI		11.2004		03.2122-1963.3	010772	MAITRE CYL. TANDEM	1K1 614 019	
	2,0 TDI		06.2004		03.2122-1963.3	010772	MAITRE CYL. TANDEM	1K1 614 019	



					description	Références OE par référence ATE.		Références remplacées / divers
---	---	---	---	---	-------------	----------------------------------	---	--------------------------------

SUBARU

IMPREZA Break (93-00)	1,6 (GF3)		01.1993	12.2000	13.0460-5850.2	605850	PLAQUETTES DE FREIN	26296AA061 , 26296AA062 , 26296AA082	cf. Photo
	1,6 4WD (GF4)		01.1993	12.2000	13.0460-5850.2	605850	PLAQUETTES DE FREIN	26296AA061 , 26296AA062 , 26296AA082	cf. Photo
	1,8 (GF5)		01.1993	12.2000	13.0460-5850.2	605850	PLAQUETTES DE FREIN	26296AA061 , 26296AA062 , 26296AA082	cf. Photo
	1,8 4WD (GF6)		01.1993	12.2000	13.0460-5850.2	605850	PLAQUETTES DE FREIN	26296AA061 , 26296AA062 , 26296AA082	cf. Photo
	2,0 4WD (GF8)		08.1995	12.2000	13.0460-5850.2	605850	PLAQUETTES DE FREIN	26296AA061 , 26296AA062 , 26296AA082	cf. Photo
	2,0 Turbo 4WD (GF8)		12.1993	12.2000	13.0460-5850.2	605850	PLAQUETTES DE FREIN	26296AA061 , 26296AA062 , 26296AA082	cf. Photo
IMPREZA Berline (93-00)	1,6 (GC3)		01.1993	12.2000	13.0460-5850.2	605850	PLAQUETTES DE FREIN	26296AA061 , 26296AA062 , 26296AA082	cf. Photo
	1,6 4WD (GC4)		01.1993	12.2000	13.0460-5850.2	605850	PLAQUETTES DE FREIN	26296AA061 , 26296AA062 , 26296AA082	cf. Photo
	1,8 (GC5)		01.1993	12.2000	13.0460-5850.2	605850	PLAQUETTES DE FREIN	26296AA061 , 26296AA062 , 26296AA082	cf. Photo
	1,8 4WD (GC6)		01.1993	12.2000	13.0460-5850.2	605850	PLAQUETTES DE FREIN	26296AA061 , 26296AA062 , 26296AA082	cf. Photo
	2,0 (GC7)		08.1996	12.2000	13.0460-5850.2	605850	PLAQUETTES DE FREIN	26296AA061 , 26296AA062 , 26296AA082	cf. Photo
	2,0 4WD (GC8)		09.1994	12.2000	13.0460-5850.2	605850	PLAQUETTES DE FREIN	26296AA061 , 26296AA062 , 26296AA082	cf. Photo
	2,0 Turbo 4WD (GC8)		12.1993	12.2000	13.0460-5850.2	605850	PLAQUETTES DE FREIN	26296AA061 , 26296AA062 , 26296AA082	cf. Photo









					description	Références OE par référence ATE.		Références remplacées / divers
--	--	--	--	--	-------------	----------------------------------	--	--------------------------------

SUBARU

LEGACY Break (94-98)	2,0 (BG4)		01.1994	11.1998	13.0460-5850.2	605850	PLAQUETTES DE FREIN	26296AA061 , 26296AA062 , 26296AA082	cf. Photo
	2,0 4WD (BG5)		01.1994	11.1998	13.0460-5850.2	605850	PLAQUETTES DE FREIN	26296AA061 , 26296AA062 , 26296AA082	cf. Photo
	2,2 (BG6)		01.1994	11.1998	13.0460-5850.2	605850	PLAQUETTES DE FREIN	26296AA061 , 26296AA062 , 26296AA082	cf. Photo
	2,2 4WD (BG7)		01.1994	11.1998	13.0460-5850.2	605850	PLAQUETTES DE FREIN	26296AA061 , 26296AA062 , 26296AA082	cf. Photo
	2,5 4WD (BG9)		06.1996	11.1998	13.0460-5850.2	605850	PLAQUETTES DE FREIN	26296AA061 , 26296AA062 , 26296AA082	cf. Photo
LEGACY Berline (94-99)	1,8 (BD2)		01.1996	03.1999	13.0460-5850.2	605850	PLAQUETTES DE FREIN	26296AA061 , 26296AA062 , 26296AA082	cf. Photo
	2,0 (BD4)		01.1994	03.1999	13.0460-5850.2	605850	PLAQUETTES DE FREIN	26296AA061 , 26296AA062 , 26296AA082	cf. Photo
	2,0 4WD (BD5)		01.1994	03.1999	13.0460-5850.2	605850	PLAQUETTES DE FREIN	26296AA061 , 26296AA062 , 26296AA082	cf. Photo
	2,2 (BD6)		01.1994	03.1999	13.0460-5850.2	605850	PLAQUETTES DE FREIN	26296AA061 , 26296AA062 , 26296AA082	cf. Photo
	2,2 4WD (BD7)		01.1994	03.1999	13.0460-5850.2	605850	PLAQUETTES DE FREIN	26296AA061 , 26296AA062 , 26296AA082	cf. Photo
	2,5 4WD (BD9)		06.1996	03.1999	13.0460-5850.2	605850	PLAQUETTES DE FREIN	26296AA061 , 26296AA062 , 26296AA082	cf. Photo



					<p>description</p>	<p>Références OE par référence ATE.</p>	 <p>Références remplacées / divers</p>
---	---	---	---	---	--------------------	---	---

TOYOTA

Modèle	Motorisation	Date	Code	ATE	Description	Références OE par référence ATE.	Références remplacées / divers
AVENSIS (03-)	2,0 D-4D	04.2003	24.0126-0141.1	426141	DISQUE DE FREIN	43512-05050 , 43512-05070	
	2,4 i 16V	10.2003	24.0126-0141.1	426141	DISQUE DE FREIN	43512-05050 , 43512-05070	
		09.2003	24.0126-0141.1	426141	DISQUE DE FREIN	43512-05050 , 43512-05070	
COROLLA VERSO (04-)	1,6 VVTi (ZNR10)	05.2004	24.0126-0138.1	426138	DISQUE DE FREIN	43512-0F010	
	1,8 VVTi (ZNR11)	05.2004	24.0126-0138.1	426138	DISQUE DE FREIN	43512-0F010	
	2,0 D-4D (CUR10)	05.2004	24.0126-0138.1	426138	DISQUE DE FREIN	43512-0F010	

Nouvelles références disponibles - par applications

11/2007



					description	Références OE par référence ATE.		Références remplacées / divers
--	--	--	--	--	-------------	----------------------------------	--	--------------------------------

VOLKSWAGEN

CADDY III (04-)	1,4		02.2004		03.2122-1963.3	010772	MAITRE CYL. TANDEM	1K1 614 019	
	1,4 16V		05.2006		03.2122-1963.3	010772	MAITRE CYL. TANDEM	1K1 614 019	
	1,6		04.2004		03.2122-1963.3	010772	MAITRE CYL. TANDEM	1K1 614 019	
	1,9 TDI		02.2004		03.2122-1963.3	010772	MAITRE CYL. TANDEM	1K1 614 019	
			09.2005		03.2122-1963.3	010772	MAITRE CYL. TANDEM	1K1 614 019	
	2,0 Eco Fuel		04.2006		03.2122-1963.3	010772	MAITRE CYL. TANDEM	1K1 614 019	
	2,0 SDI		02.2004		03.2122-1963.3	010772	MAITRE CYL. TANDEM	1K1 614 019	
GOLF V (03-)	1,4 16V		10.2003		03.2122-1963.3	010772	MAITRE CYL. TANDEM	1K1 614 019	
	1,4 FSI		10.2003		03.2122-1963.3	010772	MAITRE CYL. TANDEM	1K1 614 019	
	1,4 TSI		05.2006		03.2122-1963.3	010772	MAITRE CYL. TANDEM	1K1 614 019	
			11.2005		03.2122-1963.3	010772	MAITRE CYL. TANDEM	1K1 614 019	
	1,6 16V		01.2004		03.2122-1963.3	010772	MAITRE CYL. TANDEM	1K1 614 019	
	1,6 FSI		10.2003		03.2122-1963.3	010772	MAITRE CYL. TANDEM	1K1 614 019	
	1,9 TDI		05.2004		03.2122-1963.3	010772	MAITRE CYL. TANDEM	1K1 614 019	
			10.2003		03.2122-1963.3	010772	MAITRE CYL. TANDEM	1K1 614 019	
	1,9 TDI 4motion		08.2004		03.2122-1963.3	010772	MAITRE CYL. TANDEM	1K1 614 019	
	2,0 FSI		10.2003		03.2122-1963.3	010772	MAITRE CYL. TANDEM	1K1 614 019	
	2,0 FSI 4motion		08.2004		03.2122-1963.3	010772	MAITRE CYL. TANDEM	1K1 614 019	
	2,0 SDI		01.2004		03.2122-1963.3	010772	MAITRE CYL. TANDEM	1K1 614 019	

Nouvelles références disponibles - par applications

11/2007



					description	Références OE par référence ATE.		Références remplacées / divers
--	--	--	--	--	-------------	----------------------------------	--	--------------------------------

VOLKSWAGEN

GOLF V (03-)	2,0 TDI		10.2003		03.2122-1963.3	010772	MAITRE CYL. TANDEM	1K1 614 019	
			11.2005		03.2122-1963.3	010772	MAITRE CYL. TANDEM	1K1 614 019	
	2,0 TDI 4motion		08.2004		03.2122-1963.3	010772	MAITRE CYL. TANDEM	1K1 614 019	
GOLF V Plus (05-)	1,4 16V		01.2005		03.2122-1963.3	010772	MAITRE CYL. TANDEM	1K1 614 019	
	1,4 TSI		05.2006		03.2122-1963.3	010772	MAITRE CYL. TANDEM	1K1 614 019	
	1,6		05.2005		03.2122-1963.3	010772	MAITRE CYL. TANDEM	1K1 614 019	
	1,6 FSI		01.2005		03.2122-1963.3	010772	MAITRE CYL. TANDEM	1K1 614 019	
	1,9 TDI		01.2005		03.2122-1963.3	010772	MAITRE CYL. TANDEM	1K1 614 019	
			05.2005		03.2122-1963.3	010772	MAITRE CYL. TANDEM	1K1 614 019	
	2,0 FSI		05.2005		03.2122-1963.3	010772	MAITRE CYL. TANDEM	1K1 614 019	
	2,0 TDI		01.2005		03.2122-1963.3	010772	MAITRE CYL. TANDEM	1K1 614 019	
			05.2005		03.2122-1963.3	010772	MAITRE CYL. TANDEM	1K1 614 019	
JETTA III (05-)	1,4 TSI		06.2006		03.2122-1963.3	010772	MAITRE CYL. TANDEM	1K1 614 019	
	1,6 FSI		08.2005		03.2122-1963.3	010772	MAITRE CYL. TANDEM	1K1 614 019	
	1,6 i 16V		08.2005		03.2122-1963.3	010772	MAITRE CYL. TANDEM	1K1 614 019	
	1,9 TDI		08.2005		03.2122-1963.3	010772	MAITRE CYL. TANDEM	1K1 614 019	
	2,0 FSI		08.2005		03.2122-1963.3	010772	MAITRE CYL. TANDEM	1K1 614 019	
	2,0 TDI		09.2005		03.2122-1963.3	010772	MAITRE CYL. TANDEM	1K1 614 019	
			08.2005		03.2122-1963.3	010772	MAITRE CYL. TANDEM	1K1 614 019	



					description	Références OE par référence ATE.		Références remplacées / divers
--	--	--	--	--	-------------	----------------------------------	--	--------------------------------

VOLKSWAGEN

JETTA III (05-)	2,0 TDI		06.2006		03.2122-1963.3	010772	MAITRE CYL. TANDEM	1K1 614 019	
	2,0 TFSI		10.2005		03.2122-1963.3	010772	MAITRE CYL. TANDEM	1K1 614 019	
COCCINELLE (TYPE 1) (49-03)	1200		08.1964	12.1966	83.7701-0410.3	330850	FLEXIBLE FREIN	550 42 332 , 906 355 632 00 , 910 355 634 00 , 211 611 701	83.6101-0410.3
			01.1954	12.1957	83.7701-0450.3	330841	FLEXIBLE FREIN	300 12 535 , 460 428 51 35 , 113 611 701	83.6101-0450.3
	1300		08.1965	07.1966	83.7701-0410.3	330850	FLEXIBLE FREIN	550 42 332 , 906 355 632 00 , 910 355 634 00 , 211 611 701	83.6101-0410.3
PHAETON (02-)	3,0 TDI		09.2004		24.0122-0214.1	422214	DISQUE DE FREIN	3D0 615 601 , 3D0 615 601 C , 4E0 615 601 L	
	3,2 V6		04.2002		24.0122-0214.1	422214	DISQUE DE FREIN	3D0 615 601 , 3D0 615 601 C , 4E0 615 601 L	
					24.0122-0214.1	422214	DISQUE DE FREIN	3D0 615 601 , 3D0 615 601 C , 4E0 615 601 L	
	4,2 V8				24.0122-0214.1	422214	DISQUE DE FREIN	3D0 615 601 , 3D0 615 601 C , 4E0 615 601 L	
			05.2003		24.0122-0214.1	422214	DISQUE DE FREIN	3D0 615 601 , 3D0 615 601 C , 4E0 615 601 L	
	5,0 V10 TDI				24.0122-0214.1	422214	DISQUE DE FREIN	3D0 615 601 , 3D0 615 601 C , 4E0 615 601 L	
			11.2002		24.0122-0214.1	422214	DISQUE DE FREIN	3D0 615 601 , 3D0 615 601 C , 4E0 615 601 L	
	6,0 W12		04.2002		24.0122-0214.1	422214	DISQUE DE FREIN	3D0 615 601 , 3D0 615 601 C , 4E0 615 601 L	







					description	Références OE par référence ATE.		Références remplacées / divers
--	--	--	--	--	-------------	----------------------------------	--	--------------------------------

VOLKSWAGEN

PHAETON (02-)	6,0 W12				24.0122-0214.1	422214	DISQUE DE FREIN	3D0 615 601 , 3D0 615 601 C , 4E0 615 601 L	
TOURAN (03-)	1,4 FSI		01.2006		03.2122-1963.3	010772	MAITRE CYL. TANDEM	1K1 614 019	
	1,4 TSI		09.2006		03.2122-1963.3	010772	MAITRE CYL. TANDEM	1K1 614 019	
	1,6		07.2003		03.2122-1963.3	010772	MAITRE CYL. TANDEM	1K1 614 019	
	1,6 FSI		02.2003		03.2122-1963.3	010772	MAITRE CYL. TANDEM	1K1 614 019	
	1,9 TDI		11.2004		03.2122-1963.3	010772	MAITRE CYL. TANDEM	1K1 614 019	
			02.2003		03.2122-1963.3	010772	MAITRE CYL. TANDEM	1K1 614 019	
			08.2003		03.2122-1963.3	010772	MAITRE CYL. TANDEM	1K1 614 019	
	2,0 Eco Fuel		02.2006		03.2122-1963.3	010772	MAITRE CYL. TANDEM	1K1 614 019	
	2,0 FSI		10.2003		03.2122-1963.3	010772	MAITRE CYL. TANDEM	1K1 614 019	
	2,0 TDI		08.2003		03.2122-1963.3	010772	MAITRE CYL. TANDEM	1K1 614 019	
			02.2006		03.2122-1963.3	010772	MAITRE CYL. TANDEM	1K1 614 019	
			02.2003		03.2122-1963.3	010772	MAITRE CYL. TANDEM	1K1 614 019	



				<p>description</p>	<p>Références OE par référence ATE.</p>	 <p>Références remplacées / divers</p>
---	---	--	---	--------------------	---	---

VOLVO

S80 II (06-)	2,4 D		03.2006		13.0460-7228.2	607228	PLAQUETTES DE FREIN	1458247 , 1436498 , 1379971 , 1437761 , 30793107 , 30793540 , 30793941	cf. Photo
	2,4 D5		03.2006		13.0460-7228.2	607228	PLAQUETTES DE FREIN	1458247 , 1436498 , 1379971 , 1437761 , 30793107 , 30793540 , 30793941	cf. Photo
	2,5 T		03.2006		13.0460-7228.2	607228	PLAQUETTES DE FREIN	1458247 , 1436498 , 1379971 , 1437761 , 30793107 , 30793540 , 30793941	cf. Photo
	3,2		03.2006		13.0460-7228.2	607228	PLAQUETTES DE FREIN	1458247 , 1436498 , 1379971 , 1437761 , 30793107 , 30793540 , 30793941	cf. Photo
	4,4 V8		03.2006		13.0460-7228.2	607228	PLAQUETTES DE FREIN	1458247 , 1436498 , 1379971 , 1437761 , 30793107 , 30793540 , 30793941	cf. Photo



13.0460-2724.2 602724

Applications:
LANCIA YPSILON (03-)

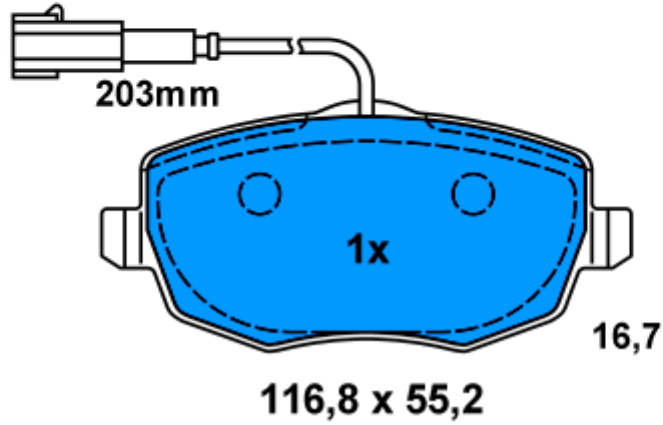
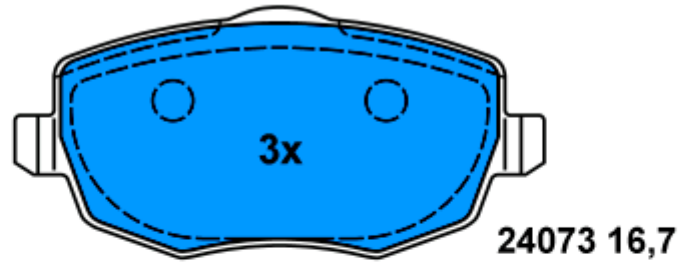



13.0460-2722.2 602722

Applications:

FORD GALAXY II (06-)
FORD S-MAX (06-)

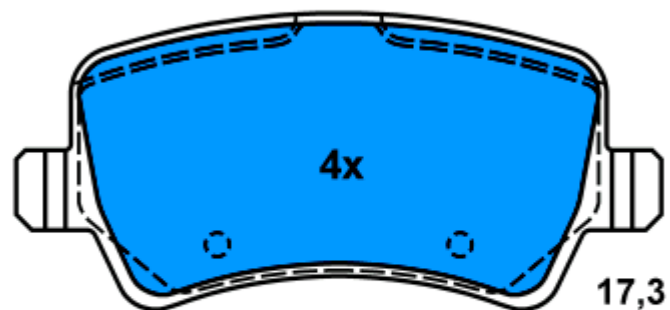
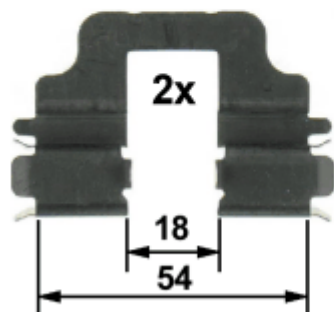
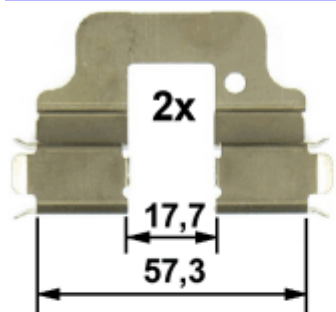



13.0460-5752.2 605752

Applications:

NISSAN QASHQAI (J10E) (07-)
NISSAN X-TRAIL (T31) (07-)

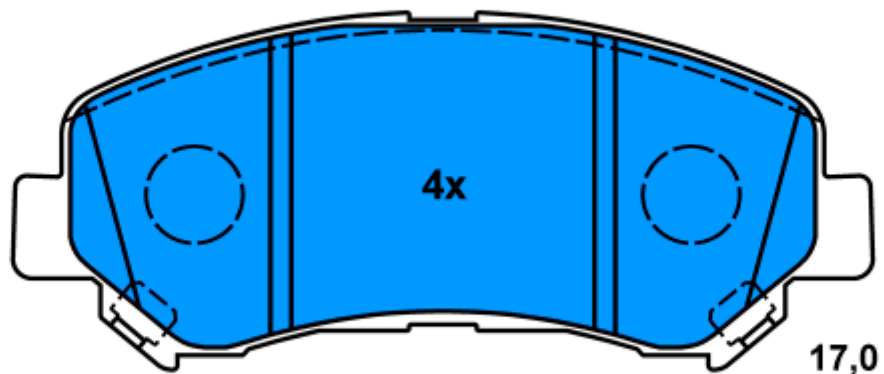

142 x 59



13.0460-7228.2 607228

Applications:

- FORD GALAXY II (06-)
- FORD MONDEO IV (07-)
- VOLVO S80 II (06-)
- FORD S-MAX (06-)

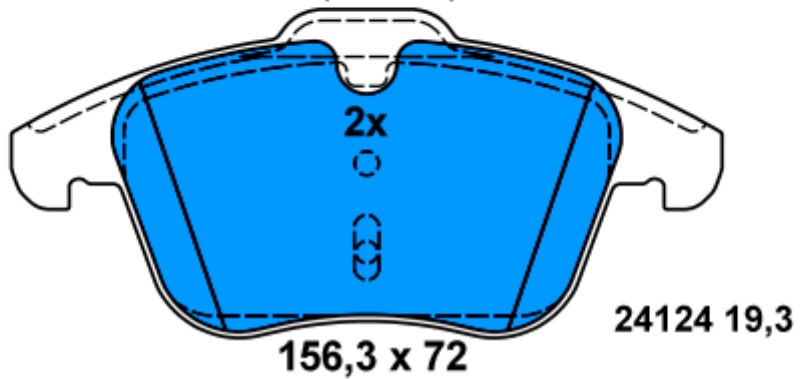
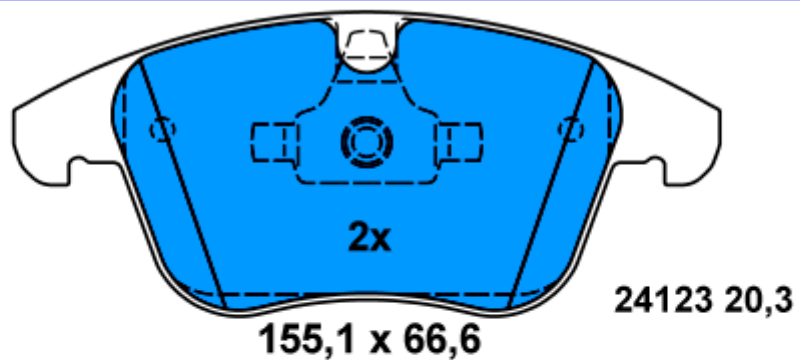



13.0460-5850.2 605850

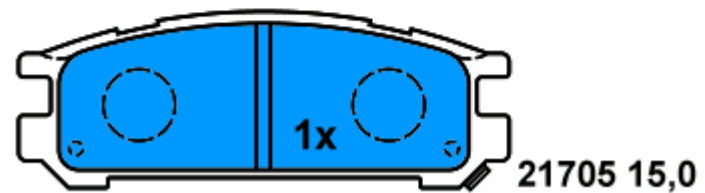
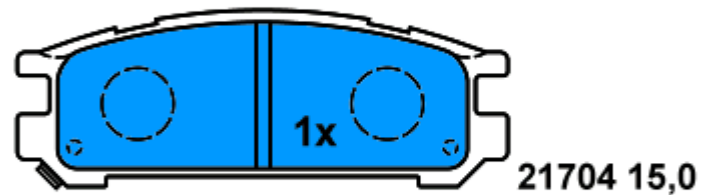
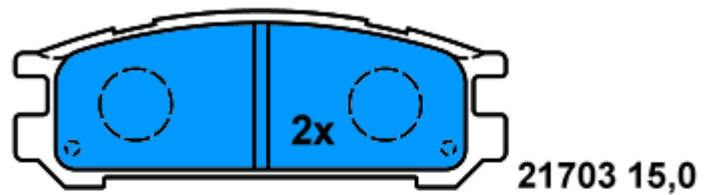
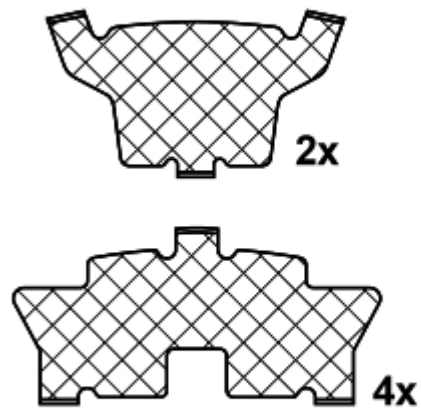

108 x 38,8

Applications:

- SUBARU IMPREZA Kombi (93-00)
- SUBARU IMPREZA Limousine (93-00)
- SUBARU LEGACY Kombi (94-98)
- SUBARU LEGACY Limousine (94-99)



13.0460-5880.2 605880

Applications:

NISSAN MAXIMA (CA33) (00-)

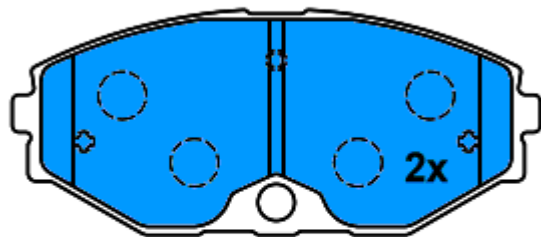

23184 14,8

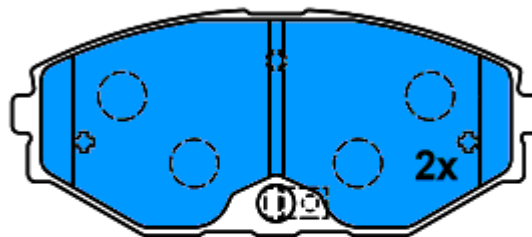

23672 14,8

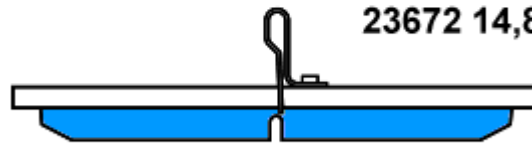

139 x 59,1



13.0460-5886.2 605886

Applications:

HYUNDAI TERRACAN (01-)

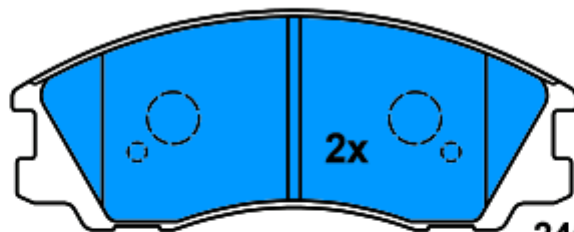
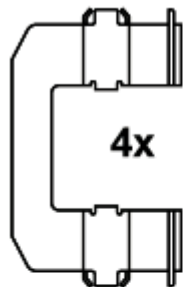

24059 16,7

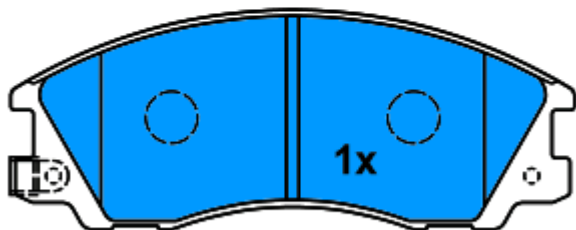

24060 16,7

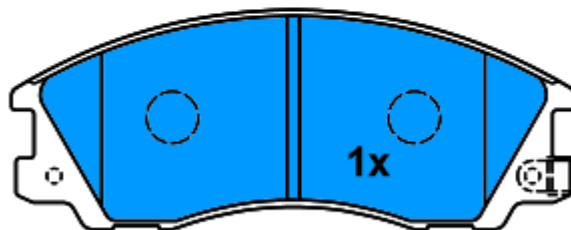

24061 16,7

148,9 x 58



13.0460-7229.2 607229

Applications:

CITROEN C4 Grand Picasso (06-)

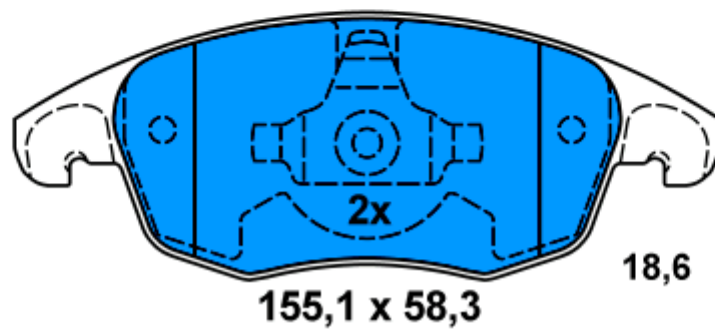
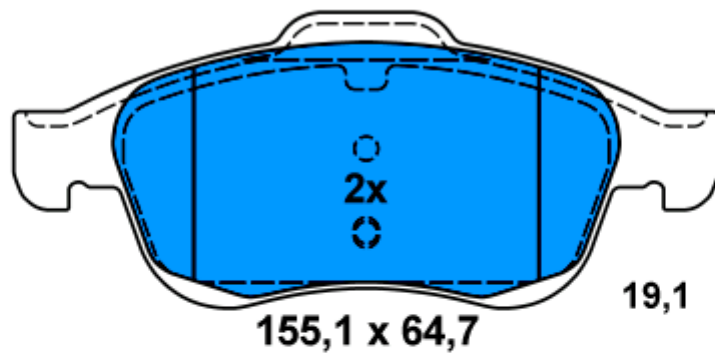



13.0460-7230.2 607230

Applications:

CITROEN C4 Grand Picasso (06-)

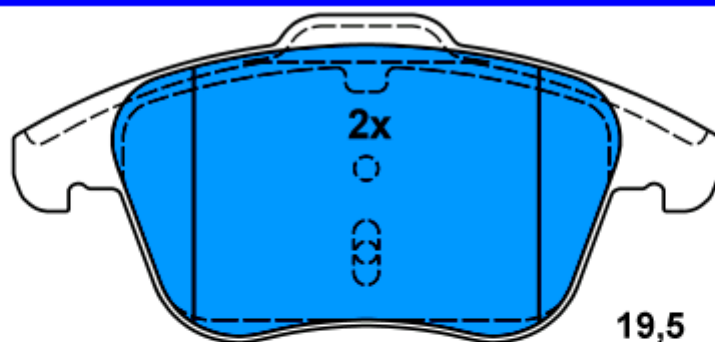

155,1 x 72

19,5

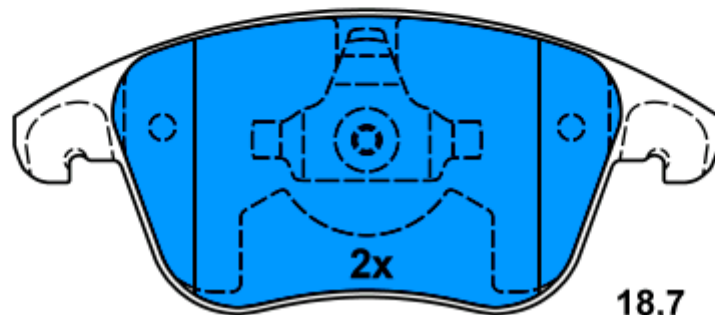

155,1 x 66,6

18,7