



Nuevas referencias en almacén

Por aplicación

09/2007



www.ate.de

Nuevas referencias en almacén - Por aplicación

09/2007



				Denominación	Ref. OE correspondientes a las referencias ATE		Referencia anterior / varios
--	--	--	--	--------------	--	--	------------------------------

AUDI

100 (76-79)	1,6	TI	08.1976	07.1979	83.7824-0180.3	330812	LATIGUILLO	321 611 775 , 431 611 775 A , 433 611 775 A	83.6224-0180.3
	2	TI	06.1976	07.1979	83.7824-0180.3	330812	LATIGUILLO	321 611 775 , 431 611 775 A , 433 611 775 A	83.6224-0180.3
	2,0 D	TI	10.1978	07.1979	83.7824-0180.3	330812	LATIGUILLO	321 611 775 , 431 611 775 A , 433 611 775 A	83.6224-0180.3
	2,2	TI	06.1976	07.1979	83.7824-0180.3	330812	LATIGUILLO	321 611 775 , 431 611 775 A , 433 611 775 A	83.6224-0180.3
100 (80-81)	1,6	TI	08.1979	07.1981	83.7824-0180.3	330812	LATIGUILLO	321 611 775 , 431 611 775 A , 433 611 775 A	83.6224-0180.3
	1,9	TI	08.1980	07.1981	83.7824-0180.3	330812	LATIGUILLO	321 611 775 , 431 611 775 A , 433 611 775 A	83.6224-0180.3
	2,0 D	TI	08.1979	07.1981	83.7824-0180.3	330812	LATIGUILLO	321 611 775 , 431 611 775 A , 433 611 775 A	83.6224-0180.3
	2,2	TI	08.1979	07.1981	83.7824-0180.3	330812	LATIGUILLO	321 611 775 , 431 611 775 A , 433 611 775 A	83.6224-0180.3
100 (82)	1,6	TI	08.1981	07.1982	83.7824-0180.3	330812	LATIGUILLO	321 611 775 , 431 611 775 A , 433 611 775 A	83.6224-0180.3
	1,9	TI	08.1981	07.1982	83.7824-0180.3	330812	LATIGUILLO	321 611 775 , 431 611 775 A , 433 611 775 A	83.6224-0180.3
	2,0 D	TI	08.1981	07.1982	83.7824-0180.3	330812	LATIGUILLO	321 611 775 , 431 611 775 A , 433 611 775 A	83.6224-0180.3
	2,0 TD	TI	11.1981	07.1982	83.7824-0180.3	330812	LATIGUILLO	321 611 775 , 431 611 775 A , 433 611 775 A	83.6224-0180.3
	2,2	TI	08.1981	07.1982	83.7824-0180.3	330812	LATIGUILLO	321 611 775 , 431 611 775 A , 433 611 775 A	83.6224-0180.3



					Denominación	Ref. OE correspondientes a las referencias ATE		Referencia anterior / varios
--	--	--	--	--	--------------	--	--	------------------------------

AUDI

100 (83-90)	1,8	TI	08.1984		83.7824-0180.3	330812	LATIGUILLO	321 611 775 , 431 611 775 A , 433 611 775 A	83.6224-0180.3
		TI	08.1989	12.1990	83.7824-0180.3	330812	LATIGUILLO	321 611 775 , 431 611 775 A , 433 611 775 A	83.6224-0180.3
	2	TI	08.1984		83.7824-0180.3	330812	LATIGUILLO	321 611 775 , 431 611 775 A , 433 611 775 A	83.6224-0180.3
		TI	08.1989	12.1990	83.7824-0180.3	330812	LATIGUILLO	321 611 775 , 431 611 775 A , 433 611 775 A	83.6224-0180.3
	2,0 D	TI	08.1982		83.7824-0180.3	330812	LATIGUILLO	321 611 775 , 431 611 775 A , 433 611 775 A	83.6224-0180.3
	2,0 TD	TI	08.1989	12.1990	83.7824-0180.3	330812	LATIGUILLO	321 611 775 , 431 611 775 A , 433 611 775 A	83.6224-0180.3
		TI	08.1982		83.7824-0180.3	330812	LATIGUILLO	321 611 775 , 431 611 775 A , 433 611 775 A	83.6224-0180.3
	2,2	TI	08.1989	12.1990	83.7824-0180.3	330812	LATIGUILLO	321 611 775 , 431 611 775 A , 433 611 775 A	83.6224-0180.3
		TI	08.1984		83.7824-0180.3	330812	LATIGUILLO	321 611 775 , 431 611 775 A , 433 611 775 A	83.6224-0180.3
	2,2 Turbo	TI	08.1989	12.1990	83.7824-0180.3	330812	LATIGUILLO	321 611 775 , 431 611 775 A , 433 611 775 A	83.6224-0180.3
	2,3	TI	08.1989	12.1990	83.7824-0180.3	330812	LATIGUILLO	321 611 775 , 431 611 775 A , 433 611 775 A	83.6224-0180.3
	2,4 D	TI	08.1989	12.1990	83.7824-0180.3	330812	LATIGUILLO	321 611 775 , 431 611 775 A , 433 611 775 A	83.6224-0180.3
	2,5 TDI	TI	01.1990	12.1990	83.7824-0180.3	330812	LATIGUILLO	321 611 775 , 431 611 775 A , 433 611 775 A	83.6224-0180.3
100 (91-94)	1,6		03.1992	07.1993	83.7813-0270.3	330797	LATIGUILLO	4A0 611 707	83.6213-0270.3

Nuevas referencias en almacén - Por aplicación

09/2007







					Denominación	Ref. OE correspondientes a las referencias ATE		Referencia anterior / varios
--	--	--	--	--	--------------	--	--	------------------------------

AUDI

100 (91-94)	1,6	TI	03.1992	07.1993	83.7824-0180.3	330812	LATIGUILLO	321 611 775 , 431 611 775 A , 433 611 775 A	83.6224-0180.3
	2		12.1990	07.1994	83.7813-0270.3	330797	LATIGUILLO	4A0 611 707	83.6213-0270.3
		TI	07.1993	07.1994	83.7824-0180.3	330812	LATIGUILLO	321 611 775 , 431 611 775 A , 433 611 775 A	83.6224-0180.3
		TI	12.1990	06.1993	83.7824-0180.3	330812	LATIGUILLO	321 611 775 , 431 611 775 A , 433 611 775 A	83.6224-0180.3
	2,0 16V	TI	01.1992	07.1994	83.7824-0180.3	330812	LATIGUILLO	321 611 775 , 431 611 775 A , 433 611 775 A	83.6224-0180.3
			01.1992	07.1994	83.7813-0270.3	330797	LATIGUILLO	4A0 611 707	83.6213-0270.3
	2,3	TI	12.1990	07.1994	83.7824-0180.3	330812	LATIGUILLO	321 611 775 , 431 611 775 A , 433 611 775 A	83.6224-0180.3
			12.1990	07.1994	83.7813-0270.3	330797	LATIGUILLO	4A0 611 707	83.6213-0270.3
	2,4 D		05.1991	07.1994	83.7813-0270.3	330797	LATIGUILLO	4A0 611 707	83.6213-0270.3
		TI	07.1993	07.1994	83.7824-0180.3	330812	LATIGUILLO	321 611 775 , 431 611 775 A , 433 611 775 A	83.6224-0180.3
		TI	05.1991	06.1993	83.7824-0180.3	330812	LATIGUILLO	321 611 775 , 431 611 775 A , 433 611 775 A	83.6224-0180.3
	2,5 TDI		06.1991	07.1994	83.7813-0270.3	330797	LATIGUILLO	4A0 611 707	83.6213-0270.3
		TI	06.1991	07.1994	83.7824-0180.3	330812	LATIGUILLO	321 611 775 , 431 611 775 A , 433 611 775 A	83.6224-0180.3
	2,6	TI	04.1992	07.1994	83.7824-0180.3	330812	LATIGUILLO	321 611 775 , 431 611 775 A , 433 611 775 A	83.6224-0180.3
			04.1992	07.1994	83.7813-0270.3	330797	LATIGUILLO	4A0 611 707	83.6213-0270.3



					Denominación	Ref. OE correspondientes a las referencias ATE	Referencia anterior / varios
---	---	---	---	---	---------------------	---	-------------------------------------

AUDI

100 (91-94)	2,8	TI	12.1990	07.1994	83.7824-0180.3	330812	LATIGUILLO	321 611 775 , 431 611 775 A , 433 611 775 A	83.6224-0180.3
			12.1990	07.1994	83.7813-0270.3	330797	LATIGUILLO	4A0 611 707	83.6213-0270.3
100 Quattro (91-94)	2		12.1990	07.1994	83.7813-0270.3	330797	LATIGUILLO	4A0 611 707	83.6213-0270.3
	2,3		12.1990	07.1994	83.7813-0270.3	330797	LATIGUILLO	4A0 611 707	83.6213-0270.3
	2,6		03.1992	07.1994	83.7813-0270.3	330797	LATIGUILLO	4A0 611 707	83.6213-0270.3
	2,8		12.1990	07.1994	83.7813-0270.3	330797	LATIGUILLO	4A0 611 707	83.6213-0270.3
	S4 2,2		08.1991	07.1994	83.7813-0270.3	330797	LATIGUILLO	4A0 611 707	83.6213-0270.3
	S4 4,2		10.1992	07.1994	83.7813-0270.3	330797	LATIGUILLO	4A0 611 707	83.6213-0270.3
200 (80-83)	2,2	TI	10.1979	08.1983	83.7824-0180.3	330812	LATIGUILLO	321 611 775 , 431 611 775 A , 433 611 775 A	83.6224-0180.3
200 (84-91)	2,1	TI		01.1988	83.7824-0180.3	330812	LATIGUILLO	321 611 775 , 431 611 775 A , 433 611 775 A	83.6224-0180.3
	2,2	TI		12.1990	83.7824-0180.3	330812	LATIGUILLO	321 611 775 , 431 611 775 A , 433 611 775 A	83.6224-0180.3
80 (79-81)	1,3	TD	09.1978		83.7804-0160.3	330811	LATIGUILLO	481 611 776 , 171 611 775	83.6204-0160.3
		TD		07.1981	83.7804-0160.3	330811	LATIGUILLO	481 611 776 , 171 611 775	83.6204-0160.3
	1,6	TD	09.1978		83.7804-0160.3	330811	LATIGUILLO	481 611 776 , 171 611 775	83.6204-0160.3
		TD		07.1981	83.7804-0160.3	330811	LATIGUILLO	481 611 776 , 171 611 775	83.6204-0160.3
	1,6 D	TD		07.1981	83.7804-0160.3	330811	LATIGUILLO	481 611 776 , 171 611 775	83.6204-0160.3
		TD	08.1980		83.7804-0160.3	330811	LATIGUILLO	481 611 776 , 171 611 775	83.6204-0160.3
	1,7	TD		07.1981	83.7804-0160.3	330811	LATIGUILLO	481 611 776 , 171 611 775	83.6204-0160.3

Nuevas referencias en almacén - Por aplicación

09/2007



					Denominación	Ref. OE correspondientes a las referencias ATE		Referencia anterior / varios
--	--	--	--	--	--------------	--	--	------------------------------







AUDI

80 (79-81)	1,7	TD	08.1980		83.7804-0160.3	330811	LATIGUILLO	481 611 776 , 171 611 775	83.6204-0160.3
	2,2	TD	10.1980		83.7804-0160.3	330811	LATIGUILLO	481 611 776 , 171 611 775	83.6204-0160.3
		TD		07.1981	83.7804-0160.3	330811	LATIGUILLO	481 611 776 , 171 611 775	83.6204-0160.3
80 (82-84)	1,3	TI	08.1981	07.1984	83.7824-0180.3	330812	LATIGUILLO	321 611 775 , 431 611 775 A , 433 611 775 A	83.6224-0180.3
	1,6	TI	08.1981	07.1984	83.7824-0180.3	330812	LATIGUILLO	321 611 775 , 431 611 775 A , 433 611 775 A	83.6224-0180.3
	1,6 D	TI	08.1981	07.1984	83.7824-0180.3	330812	LATIGUILLO	321 611 775 , 431 611 775 A , 433 611 775 A	83.6224-0180.3
	1,6 TD	TI	02.1982	07.1984	83.7824-0180.3	330812	LATIGUILLO	321 611 775 , 431 611 775 A , 433 611 775 A	83.6224-0180.3
	1,7	TI	08.1981	07.1983	83.7824-0180.3	330812	LATIGUILLO	321 611 775 , 431 611 775 A , 433 611 775 A	83.6224-0180.3
	1,8	TI	08.1981	07.1984	83.7824-0180.3	330812	LATIGUILLO	321 611 775 , 431 611 775 A , 433 611 775 A	83.6224-0180.3
	1,9	TI	08.1981	07.1983	83.7824-0180.3	330812	LATIGUILLO	321 611 775 , 431 611 775 A , 433 611 775 A	83.6224-0180.3
	2	TI	08.1983	07.1984	83.7824-0180.3	330812	LATIGUILLO	321 611 775 , 431 611 775 A , 433 611 775 A	83.6224-0180.3
	2,2	TI	08.1981	08.1983	83.7824-0180.3	330812	LATIGUILLO	321 611 775 , 431 611 775 A , 433 611 775 A	83.6224-0180.3
80 (87-91)	1,6			07.1991	83.7813-0285.3	330798	LATIGUILLO	893 611 707	83.6213-0285.3
	1,6 TD			07.1991	83.7813-0285.3	330798	LATIGUILLO	893 611 707	83.6213-0285.3
	1,8			07.1991	83.7813-0285.3	330798	LATIGUILLO	893 611 707	83.6213-0285.3

Nuevas referencias en almacén - Por aplicación

09/2007



					Denominación	Ref. OE correspondientes a las referencias ATE		Referencia anterior / varios
---	---	---	---	---	--------------	--	---	------------------------------

AUDI

Modelo	Motor	Fecha inicio	Fecha fin	Ref. ATE	Ref. OE	Denominación	Ref. OE correspondientes a las referencias ATE	Referencia anterior / varios
80 (87-91)	1,9 D		07.1991	83.7813-0285.3	330798	LATIGUILLO	893 611 707	83.6213-0285.3
	2		07.1991	83.7813-0285.3	330798	LATIGUILLO	893 611 707	83.6213-0285.3
80 (91-95)	1,6	08.1991		83.7812-0200.3	330846	LATIGUILLO	8A0 611 775	83.6212-0200.3
			12.1995	83.7812-0200.3	330846	LATIGUILLO	8A0 611 775	83.6212-0200.3
		08.1991	12.1995	83.7813-0285.3	330798	LATIGUILLO	893 611 707	83.6213-0285.3
	1,9 TD		12.1995	83.7812-0200.3	330846	LATIGUILLO	8A0 611 775	83.6212-0200.3
		09.1991	12.1995	83.7813-0285.3	330798	LATIGUILLO	893 611 707	83.6213-0285.3
		09.1991		83.7812-0200.3	330846	LATIGUILLO	8A0 611 775	83.6212-0200.3
	1,9 TDI	09.1991	12.1995	83.7813-0285.3	330798	LATIGUILLO	893 611 707	83.6213-0285.3
		09.1991		83.7812-0200.3	330846	LATIGUILLO	8A0 611 775	83.6212-0200.3
			12.1995	83.7812-0200.3	330846	LATIGUILLO	8A0 611 775	83.6212-0200.3
	2	08.1991		83.7812-0200.3	330846	LATIGUILLO	8A0 611 775	83.6212-0200.3
		08.1991	12.1995	83.7813-0285.3	330798	LATIGUILLO	893 611 707	83.6213-0285.3
		09.1991		83.7812-0200.3	330846	LATIGUILLO	8A0 611 775	83.6212-0200.3
		08.1991	07.1992	83.7812-0200.3	330846	LATIGUILLO	8A0 611 775	83.6212-0200.3
			12.1995	83.7812-0200.3	330846	LATIGUILLO	8A0 611 775	83.6212-0200.3
		08.1991	12.1995	83.7812-0200.3	330846	LATIGUILLO	8A0 611 775	83.6212-0200.3
	2,3	09.1991	12.1995	83.7812-0200.3	330846	LATIGUILLO	8A0 611 775	83.6212-0200.3
		09.1991	12.1995	83.7813-0285.3	330798	LATIGUILLO	893 611 707	83.6213-0285.3

Nuevas referencias en almacén - Por aplicación

09/2007









					Denominación	Ref. OE correspondientes a las referencias ATE		Referencia anterior / varios
--	--	--	--	--	--------------	--	--	------------------------------

AUDI

80 (91-95)	2,6		08.1992	12.1995	83.7812-0200.3	330846	LATIGUILLO	8A0 611 775	83.6212-0200.3
			07.1992	12.1995	83.7813-0285.3	330798	LATIGUILLO	893 611 707	83.6213-0285.3
	2,8		09.1991	12.1995	83.7812-0200.3	330846	LATIGUILLO	8A0 611 775	83.6212-0200.3
			09.1991	12.1995	83.7813-0285.3	330798	LATIGUILLO	893 611 707	83.6213-0285.3
80 Quattro (87-91)	1,8			09.1991	83.7813-0285.3	330798	LATIGUILLO	893 611 707	83.6213-0285.3
	2			09.1991	83.7813-0285.3	330798	LATIGUILLO	893 611 707	83.6213-0285.3
80 Quattro (92-95)			09.1991	12.1995	83.7813-0285.3	330798	LATIGUILLO	893 611 707	83.6213-0285.3
	2,3		09.1991	12.1995	83.7813-0285.3	330798	LATIGUILLO	893 611 707	83.6213-0285.3
	2,6		08.1992	12.1995	83.7813-0285.3	330798	LATIGUILLO	893 611 707	83.6213-0285.3
	2,8		09.1991	12.1995	83.7813-0285.3	330798	LATIGUILLO	893 611 707	83.6213-0285.3
	RS2 2,2		03.1994	07.1995	83.7813-0285.3	330798	LATIGUILLO	893 611 707	83.6213-0285.3
	S2 2,2		02.1993	12.1995	83.7813-0285.3	330798	LATIGUILLO	893 611 707	83.6213-0285.3
90 (87-91)	1,6 TD			07.1991	83.7813-0285.3	330798	LATIGUILLO	893 611 707	83.6213-0285.3
	1,8			07.1991	83.7813-0285.3	330798	LATIGUILLO	893 611 707	83.6213-0285.3
	2			07.1991	83.7813-0285.3	330798	LATIGUILLO	893 611 707	83.6213-0285.3
	2,2			07.1991	83.7813-0285.3	330798	LATIGUILLO	893 611 707	83.6213-0285.3
	2,3			07.1991	83.7813-0285.3	330798	LATIGUILLO	893 611 707	83.6213-0285.3
90 Quattro (87-91)	2		01.1988	09.1991	83.7813-0285.3	330798	LATIGUILLO	893 611 707	83.6213-0285.3
	2,2			09.1991	83.7813-0285.3	330798	LATIGUILLO	893 611 707	83.6213-0285.3



					Denominación	Ref. OE correspondientes a las referencias ATE		Referencia anterior / varios
---	---	---	---	---	--------------	--	---	------------------------------

AUDI

90 Quattro (87-91)	2,3			09.1991	83.7813-0285.3	330798	LATIGUILLO	893 611 707	83.6213-0285.3
A6 (C4) (94-97)	1,8	TI	10.1995	12.1997	83.7824-0180.3	330812	LATIGUILLO	321 611 775 , 431 611 775 A , 433 611 775 A	83.6224-0180.3
			10.1995	12.1997	83.7813-0270.3	330797	LATIGUILLO	4A0 611 707	83.6213-0270.3
	1,8 Quattro		10.1995	12.1997	83.7813-0270.3	330797	LATIGUILLO	4A0 611 707	83.6213-0270.3
	1,9 TDI		06.1994	12.1997	83.7813-0270.3	330797	LATIGUILLO	4A0 611 707	83.6213-0270.3
		TI	06.1994	12.1997	83.7824-0180.3	330812	LATIGUILLO	321 611 775 , 431 611 775 A , 433 611 775 A	83.6224-0180.3
	2		06.1994	12.1997	83.7813-0270.3	330797	LATIGUILLO	4A0 611 707	83.6213-0270.3
		TI	06.1994	12.1997	83.7824-0180.3	330812	LATIGUILLO	321 611 775 , 431 611 775 A , 433 611 775 A	83.6224-0180.3
	2,0 16V	TI	06.1994	12.1997	83.7824-0180.3	330812	LATIGUILLO	321 611 775 , 431 611 775 A , 433 611 775 A	83.6224-0180.3
			06.1994	12.1997	83.7813-0270.3	330797	LATIGUILLO	4A0 611 707	83.6213-0270.3
	2,0 Quattro		06.1994	12.1997	83.7813-0270.3	330797	LATIGUILLO	4A0 611 707	83.6213-0270.3
	2,3	TI	06.1994	12.1995	83.7824-0180.3	330812	LATIGUILLO	321 611 775 , 431 611 775 A , 433 611 775 A	83.6224-0180.3
			06.1994	12.1995	83.7813-0270.3	330797	LATIGUILLO	4A0 611 707	83.6213-0270.3
	2,3 Quattro		08.1994	12.1995	83.7813-0270.3	330797	LATIGUILLO	4A0 611 707	83.6213-0270.3
	2,5 TDI		06.1994	12.1997	83.7813-0270.3	330797	LATIGUILLO	4A0 611 707	83.6213-0270.3
		TI	06.1994	12.1997	83.7824-0180.3	330812	LATIGUILLO	321 611 775 , 431 611 775 A , 433 611 775 A	83.6224-0180.3
	2,5 TDI Quattro		07.1995	12.1997	83.7813-0270.3	330797	LATIGUILLO	4A0 611 707	83.6213-0270.3

Nuevas referencias en almacén - Por aplicación

09/2007



					Denominación	Ref. OE correspondientes a las referencias ATE	Referencia anterior / varios
--	--	--	--	--	--------------	--	------------------------------

AUDI

A6 (C4) (94-97)	2,6		06.1994	12.1997	83.7813-0270.3	330797	LATIGUILLO	4A0 611 707	83.6213-0270.3
		TI	06.1994	12.1997	83.7824-0180.3	330812	LATIGUILLO	321 611 775 , 431 611 775 A , 433 611 775 A	83.6224-0180.3
	2,6 Quattro		06.1994	12.1997	83.7813-0270.3	330797	LATIGUILLO	4A0 611 707	83.6213-0270.3
	2,8		06.1994	12.1997	83.7813-0270.3	330797	LATIGUILLO	4A0 611 707	83.6213-0270.3
		TI	06.1994	12.1997	83.7824-0180.3	330812	LATIGUILLO	321 611 775 , 431 611 775 A , 433 611 775 A	83.6224-0180.3
		TI	10.1995	12.1997	83.7824-0180.3	330812	LATIGUILLO	321 611 775 , 431 611 775 A , 433 611 775 A	83.6224-0180.3
			10.1995	12.1997	83.7813-0270.3	330797	LATIGUILLO	4A0 611 707	83.6213-0270.3
	2,8 Quattro		06.1994	12.1997	83.7813-0270.3	330797	LATIGUILLO	4A0 611 707	83.6213-0270.3
	S6 2,2		06.1994	12.1997	83.7813-0270.3	330797	LATIGUILLO	4A0 611 707	83.6213-0270.3
	S6 4,2		09.1994	12.1997	83.7813-0270.3	330797	LATIGUILLO	4A0 611 707	83.6213-0270.3
	S6 4,2 plus		06.1996	12.1997	83.7813-0270.3	330797	LATIGUILLO	4A0 611 707	83.6213-0270.3
CABRIOLE (91-00)	1,8		04.1997	08.2000	83.7813-0285.3	330798	LATIGUILLO	893 611 707	83.6213-0285.3
	1,9 TDI		07.1995	08.2000	83.7813-0285.3	330798	LATIGUILLO	893 611 707	83.6213-0285.3
	2		01.1993	07.1998	83.7813-0285.3	330798	LATIGUILLO	893 611 707	83.6213-0285.3
			05.1995	07.1996	83.7813-0285.3	330798	LATIGUILLO	893 611 707	83.6213-0285.3
	2,3		07.1991	06.1994	83.7813-0285.3	330798	LATIGUILLO	893 611 707	83.6213-0285.3
	2,6		01.1994	08.2000	83.7813-0285.3	330798	LATIGUILLO	893 611 707	83.6213-0285.3
	2,8		11.1992	08.2000	83.7813-0285.3	330798	LATIGUILLO	893 611 707	83.6213-0285.3

Nuevas referencias en almacén - Por aplicación

09/2007



				Denominación	Ref. OE correspondientes a las referencias ATE		Referencia anterior / varios
--	--	--	--	--------------	--	--	------------------------------

AUDI

COUPE (81-88)	1,6	TI	02.1981	08.1981	83.7824-0180.3	330812	LATIGUILLO	321 611 775 , 431 611 775 A , 433 611 775 A	83.6224-0180.3
	1,8	TI	08.1981	07.1988	83.7824-0180.3	330812	LATIGUILLO	321 611 775 , 431 611 775 A , 433 611 775 A	83.6224-0180.3
	1,9	TI	10.1980	08.1983	83.7824-0180.3	330812	LATIGUILLO	321 611 775 , 431 611 775 A , 433 611 775 A	83.6224-0180.3
	2	TI	09.1983	07.1988	83.7824-0180.3	330812	LATIGUILLO	321 611 775 , 431 611 775 A , 433 611 775 A	83.6224-0180.3
	2,2	TI	09.1984	07.1988	83.7824-0180.3	330812	LATIGUILLO	321 611 775 , 431 611 775 A , 433 611 775 A	83.6224-0180.3
COUPE (89-96)	1,8	TI	08.1988	10.1988	83.7824-0180.3	330812	LATIGUILLO	321 611 775 , 431 611 775 A , 433 611 775 A	83.6224-0180.3
				07.1991	83.7813-0285.3	330798	LATIGUILLO	893 611 707	83.6213-0285.3
	2			12.1996	83.7813-0285.3	330798	LATIGUILLO	893 611 707	83.6213-0285.3
		TI	08.1988	10.1988	83.7824-0180.3	330812	LATIGUILLO	321 611 775 , 431 611 775 A , 433 611 775 A	83.6224-0180.3
	2,2			07.1991	83.7813-0285.3	330798	LATIGUILLO	893 611 707	83.6213-0285.3
	2,3			07.1994	83.7813-0285.3	330798	LATIGUILLO	893 611 707	83.6213-0285.3
	2,6		08.1992	12.1996	83.7813-0285.3	330798	LATIGUILLO	893 611 707	83.6213-0285.3
	2,8		09.1991	12.1996	83.7813-0285.3	330798	LATIGUILLO	893 611 707	83.6213-0285.3
COUPE Quattro (87-96)	2			07.1991	83.7813-0285.3	330798	LATIGUILLO	893 611 707	83.6213-0285.3
	2,2			07.1991	83.7813-0285.3	330798	LATIGUILLO	893 611 707	83.6213-0285.3
	2,3			12.1996	83.7813-0285.3	330798	LATIGUILLO	893 611 707	83.6213-0285.3



	i				Denominación	Ref. OE correspondientes a las referencias ATE	i Referencia anterior / varios
--	----------	--	--	--	--------------	--	--

AUDI

Modelo	Motor	Fecha inicio	Fecha fin	Ref. ATE	Ref. OE	Denominación	Ref. OE correspondientes a las referencias ATE	Referencia anterior / varios
COUPE Quattro (87-96)	2,3		07.1994	83.7813-0285.3	330798	LATIGUILLO	893 611 707	83.6213-0285.3
	2,3 20V		12.1996	83.7813-0285.3	330798	LATIGUILLO	893 611 707	83.6213-0285.3
			07.1991	83.7813-0285.3	330798	LATIGUILLO	893 611 707	83.6213-0285.3
	2,6	08.1992	12.1996	83.7813-0285.3	330798	LATIGUILLO	893 611 707	83.6213-0285.3
	2,8	08.1991	12.1996	83.7813-0285.3	330798	LATIGUILLO	893 611 707	83.6213-0285.3
	S2 2,2	10.1992	12.1996	83.7813-0285.3	330798	LATIGUILLO	893 611 707	83.6213-0285.3
		09.1990	09.1992	83.7813-0285.3	330798	LATIGUILLO	893 611 707	83.6213-0285.3

Nuevas referencias en almacén - Por aplicación

09/2007



					Denominación	Ref. OE correspondientes a las referencias ATE		Referencia anterior / varios
--	--	--	--	--	--------------	--	--	------------------------------







BMW

1er Reihe/E81/E87 (04-)	118 d		03.2007		24.0120-0195.1	420195	DISCO DE FRENO	34 21 6 764 651	
	120 d		03.2007		24.0120-0195.1	420195	DISCO DE FRENO	34 21 6 764 651	
			09.2004	03.2007	24.0120-0195.1	420195	DISCO DE FRENO	34 21 6 764 651	
Serie 3/E90 Berlina (05-)	318 d		09.2005		24.0120-0195.1	420195	DISCO DE FRENO	34 21 6 764 651	
	318 i		09.2005		24.0120-0195.1	420195	DISCO DE FRENO	34 21 6 764 651	
	320 d		12.2004		24.0120-0195.1	420195	DISCO DE FRENO	34 21 6 764 651	
	320 i		12.2004		24.0120-0195.1	420195	DISCO DE FRENO	34 21 6 764 651	
	325 i		12.2004		24.0120-0195.1	420195	DISCO DE FRENO	34 21 6 764 651	
Serie 3/E92 Coupé (06-)	320 d		03.2007		24.0120-0195.1	420195	DISCO DE FRENO	34 21 6 764 651	
	320 i		03.2007		24.0120-0195.1	420195	DISCO DE FRENO	34 21 6 764 651	
	323 i		09.2006		24.0120-0195.1	420195	DISCO DE FRENO	34 21 6 764 651	
	325 i		09.2006		24.0120-0195.1	420195	DISCO DE FRENO	34 21 6 764 651	

CHEVROLET

NUBIRA (05-)	1,6 i 16V		03.2005		24.0110-0714.1	410714	DISCO DE FRENO	96312560	
	1,8 i 16V		03.2005		24.0110-0714.1	410714	DISCO DE FRENO	96312560	



					Denominación	Ref. OE correspondientes a las referencias ATE	 Referencia anterior / varios
---	---	---	---	---	---------------------	---	---

CHRYSLER

VOYAGER (RG) (00-)	2,4		02.2000		13.0460-8008.2	608008	PASTILLAS DE FRENO	5019 805AA , 5071 948AA	ver figura
	2,5 CRD		02.2000		13.0460-8008.2	608008	PASTILLAS DE FRENO	5019 805AA , 5071 948AA	ver figura
	2,8 CRD		06.2004		13.0460-8008.2	608008	PASTILLAS DE FRENO	5019 805AA , 5071 948AA	ver figura
	3,3		02.2000		13.0460-8008.2	608008	PASTILLAS DE FRENO	5019 805AA , 5071 948AA	ver figura
	3,3 AWD		02.2000		13.0460-8008.2	608008	PASTILLAS DE FRENO	5019 805AA , 5071 948AA	ver figura
	3,8		02.2000		13.0460-8008.2	608008	PASTILLAS DE FRENO	5019 805AA , 5071 948AA	ver figura
	3,8 AWD		02.2000		13.0460-8008.2	608008	PASTILLAS DE FRENO	5019 805AA , 5071 948AA	ver figura



					Denominación	Ref. OE correspondientes a las referencias ATE		Referencia anterior / varios
--	--	--	--	--	--------------	--	--	------------------------------

CITROEN

BERLINGO (MF) Kombi (96-)	1,6 16V		10.2000		24.2123-1757.3	010765	CIL. MAESTRO TANDEM	4601 P8	
	2,0 HDi		12.1999		24.2123-1757.3	010765	CIL. MAESTRO TANDEM	4601 P8	
EVASION (94-02)	1,8 i		02.1996	07.2002	24.3728-0341.2	590341	CABLE DE EMBRAGUE	2150 H9 , 2150 S4 , 1476637080 , 1479128080	24.3728-0327.2
	2,0 i		06.1994	07.2002	24.3728-0341.2	590341	CABLE DE EMBRAGUE	2150 H9 , 2150 S4 , 1476637080 , 1479128080	24.3728-0327.2
JUMPER (06-)	2,2 HDi (12/14)		04.2006		13.0460-4812.2	604812	PASTILLAS DE FRENO	4253 59 , 4253 60 , 77364016	ver figura
	2,2 HDi (16H)		04.2006		13.0460-4812.2	604812	PASTILLAS DE FRENO	4253 59 , 4253 60 , 77364016	ver figura
	2,2 HDi (16L)		04.2006		13.0460-4812.2	604812	PASTILLAS DE FRENO	4253 59 , 4253 60 , 77364016	ver figura
	2,2 HDi (20)		04.2006		13.0460-4812.2	604812	PASTILLAS DE FRENO	4253 59 , 4253 60 , 77364016	ver figura
	3,0 HDi (12/14)		09.2006		13.0460-4812.2	604812	PASTILLAS DE FRENO	4253 59 , 4253 60 , 77364016	ver figura
	3,0 HDi (16H)		09.2006		13.0460-4812.2	604812	PASTILLAS DE FRENO	4253 59 , 4253 60 , 77364016	ver figura
	3,0 HDi (16L)		09.2006		13.0460-4812.2	604812	PASTILLAS DE FRENO	4253 59 , 4253 60 , 77364016	ver figura
	3,0 HDi (20)		09.2006		13.0460-4812.2	604812	PASTILLAS DE FRENO	4253 59 , 4253 60 , 77364016	ver figura
JUMPY I Furgón (95-06)	1,6		10.1995	12.2006	24.3728-0341.2	590341	CABLE DE EMBRAGUE	2150 H9 , 2150 S4 , 1476637080 , 1479128080	24.3728-0327.2
	2,0 16V		03.2000	12.2006	24.3728-0341.2	590341	CABLE DE EMBRAGUE	2150 H9 , 2150 S4 , 1476637080 , 1479128080	24.3728-0327.2
JUMPY I Break (95-06)	1,6		10.1995	12.2006	24.3728-0341.2	590341	CABLE DE EMBRAGUE	2150 H9 , 2150 S4 , 1476637080 , 1479128080	24.3728-0327.2
	2,0 16V		04.2000	12.2006	24.3728-0341.2	590341	CABLE DE EMBRAGUE	2150 H9 , 2150 S4 , 1476637080 , 1479128080	24.3728-0327.2



	i				Denominación	Ref. OE correspondientes a las referencias ATE	i Referencia anterior / varios
--	----------	--	--	--	--------------	--	--

CITROEN

JUMPY I Break (95-06)	2,0 16V		03.2000	12.2006	24.3728-0341.2	590341	CABLE DE EMBRAGUE	2150 H9 , 2150 S4 , 1476637080 , 1479128080	24.3728-0327.2
-----------------------	---------	--	---------	---------	----------------	--------	-------------------	---	----------------







DAEWOO

NUBIRA (97-99)	2,0 i 16V		06.1997	05.1999	24.0110-0714.1	410714	DISCO DE FRENO	96312560	
NUBIRA (99-05)	1,6 i 16V		08.2003	02.2005	24.0110-0714.1	410714	DISCO DE FRENO	96312560	
	1,8 i 16V		08.2003	02.2005	24.0110-0714.1	410714	DISCO DE FRENO	96312560	
	2,0 i 16V		06.1999	02.2005	24.0110-0714.1	410714	DISCO DE FRENO	96312560	

Nuevas referencias en almacén - Por aplicación

09/2007









					Denominación	Ref. OE correspondientes a las referencias ATE	 Referencia anterior / varios
---	---	---	---	---	--------------	--	--

DAIHATSU

SIRION (98-04)	1,0 i 4WD (M110)		04.1998	09.2000	03.0137-0476.2	650476	JUEGO DE ZAPATAS	04495-97215-000 , 04495-97202-000	
			10.2000	12.2004	03.0137-0476.2	650476	JUEGO DE ZAPATAS	04495-97215-000 , 04495-97202-000	
	1,3 i 16V 4WD (M111)		08.2000	12.2004	03.0137-0476.2	650476	JUEGO DE ZAPATAS	04495-97215-000 , 04495-97202-000	
TERIOS (05-)	1,3 DVVT		11.2005		24.0222-8036.1	480196	TAMBORES DE FRENO	42431-87401-000	
	1,5 16V 4WD		05.2006		24.0222-8036.1	480196	TAMBORES DE FRENO	42431-87401-000	
	1,5 DVVT		11.2005		24.0222-8036.1	480196	TAMBORES DE FRENO	42431-87401-000	
TERIOS (97-05)	1,3 i 16V (J102)		09.2001	10.2005	24.0222-8034.1	480187	TAMBORES DE FRENO	42431-87402-000	
			09.2001	10.2005	24.0222-8036.1	480196	TAMBORES DE FRENO	42431-87401-000	
	1,3 i 16V 4WD (J100)		10.1997	09.2000	24.0222-8034.1	480187	TAMBORES DE FRENO	42431-87402-000	
			10.1997	09.2000	24.0222-8036.1	480196	TAMBORES DE FRENO	42431-87401-000	
	1,3 i 16V 4WD (J122)		10.2000	10.2005	24.0222-8034.1	480187	TAMBORES DE FRENO	42431-87402-000	
			10.2000	10.2005	24.0222-8036.1	480196	TAMBORES DE FRENO	42431-87401-000	
YRV (01-)	1,3 i 16V 4WD (M211)		01.2001		03.0137-0476.2	650476	JUEGO DE ZAPATAS	04495-97215-000 , 04495-97202-000	



					Denominación	Ref. OE correspondientes a las referencias ATE	 Referencia anterior / varios
---	---	---	---	---	--------------	--	--

FIAT

Modelo	Motor	DD	03.2007		24.3541-1812.7	220624	PINZA DE GARRA	9949342	
BRAVO (07-)	1,4 i 16V	DD	03.2007		24.3541-1811.7	220623	PINZA DE GARRA	9949336	
		DI	03.2007		13.0460-4812.2	604812	PASTILLAS DE FRENO	4253 59 , 4253 60 , 77364016	ver figura
DUCATO (06-)	2,2 JTD (Q11)		07.2006		13.0460-4812.2	604812	PASTILLAS DE FRENO	4253 59 , 4253 60 , 77364016	ver figura
	2,2 JTD (Q15)		07.2006		13.0460-4812.2	604812	PASTILLAS DE FRENO	4253 59 , 4253 60 , 77364016	ver figura
	2,2 JTD (Q17H)		07.2006		13.0460-4812.2	604812	PASTILLAS DE FRENO	4253 59 , 4253 60 , 77364016	ver figura
	2,2 JTD (Q17L)		07.2006		13.0460-4812.2	604812	PASTILLAS DE FRENO	4253 59 , 4253 60 , 77364016	ver figura
	2,2 JTD (Q20)		07.2006		13.0460-4812.2	604812	PASTILLAS DE FRENO	4253 59 , 4253 60 , 77364016	ver figura
	2,3 JTD (Q11)		07.2006		13.0460-4812.2	604812	PASTILLAS DE FRENO	4253 59 , 4253 60 , 77364016	ver figura
	2,3 JTD (Q15)		07.2006		13.0460-4812.2	604812	PASTILLAS DE FRENO	4253 59 , 4253 60 , 77364016	ver figura
	2,3 JTD (Q17H)		07.2006		13.0460-4812.2	604812	PASTILLAS DE FRENO	4253 59 , 4253 60 , 77364016	ver figura
	2,3 JTD (Q17L)		07.2006		13.0460-4812.2	604812	PASTILLAS DE FRENO	4253 59 , 4253 60 , 77364016	ver figura
	2,3 JTD (Q20)		07.2006		13.0460-4812.2	604812	PASTILLAS DE FRENO	4253 59 , 4253 60 , 77364016	ver figura
	3,0 JTD (Q11)		07.2006		13.0460-4812.2	604812	PASTILLAS DE FRENO	4253 59 , 4253 60 , 77364016	ver figura
	3,0 JTD (Q15)		07.2006		13.0460-4812.2	604812	PASTILLAS DE FRENO	4253 59 , 4253 60 , 77364016	ver figura
	3,0 JTD (Q17H)		07.2006		13.0460-4812.2	604812	PASTILLAS DE FRENO	4253 59 , 4253 60 , 77364016	ver figura
	3,0 JTD (Q17L)		07.2006		13.0460-4812.2	604812	PASTILLAS DE FRENO	4253 59 , 4253 60 , 77364016	ver figura
	3,0 JTD (Q20)		07.2006		13.0460-4812.2	604812	PASTILLAS DE FRENO	4253 59 , 4253 60 , 77364016	ver figura
FIORINO (93-01)	1,3		09.1993	03.2001	03.0520-8820.3	698820	ATE TOPKIT		
	1,4		09.1993	03.2001	03.0520-8820.3	698820	ATE TOPKIT		
	1,6		09.1993	03.2001	03.0520-8820.3	698820	ATE TOPKIT		

Nuevas referencias en almacén - Por aplicación

09/2007









				Denominación	Ref. OE correspondientes a las referencias ATE		Referencia anterior / varios
--	--	--	--	--------------	--	--	------------------------------

FIAT

Modelo	Motor	DI	09.1993	03.2001	03.0520-8820.3	698820	ATE TOPKIT		
FIORINO (93-01)	1,7 D								
IDEA (04-)	1,2 i 16V	DI	01.2004		24.3541-1811.7	220623	PINZA DE GARRA	9949336	
		DD	01.2004		24.3541-1812.7	220624	PINZA DE GARRA	9949342	
	1,3 JTD	DD	01.2004		24.3541-1812.7	220624	PINZA DE GARRA	9949342	
		DI	01.2004		24.3541-1811.7	220623	PINZA DE GARRA	9949336	
	1,4 i	DD	11.2005		24.3541-1812.7	220624	PINZA DE GARRA	9949342	
		DI	11.2005		24.3541-1811.7	220623	PINZA DE GARRA	9949336	
	1,4 i 16V	DI	01.2004		24.3541-1811.7	220623	PINZA DE GARRA	9949336	
		DD	01.2004		24.3541-1812.7	220624	PINZA DE GARRA	9949342	
STILO (01-)	1,2 i 16V	DI	10.2001		24.3541-1811.7	220623	PINZA DE GARRA	9949336	
		DD	10.2001		24.3541-1812.7	220624	PINZA DE GARRA	9949342	
	1,4 i 16V	DD	01.2004		24.3541-1812.7	220624	PINZA DE GARRA	9949342	
		DI	01.2004		24.3541-1811.7	220623	PINZA DE GARRA	9949336	
	1,6 i 16V	DI	10.2001		24.3541-1811.7	220623	PINZA DE GARRA	9949336	
		DD	10.2001		24.3541-1812.7	220624	PINZA DE GARRA	9949342	



						Denominación	Ref. OE correspondientes a las referencias ATE	 Referencia anterior / varios
---	---	---	---	---	--	--------------	--	--

FORD

GALAXY I (95-06)	1,9 TDI		05.2005	04.2006	83.7717-0450.3	330807	LATIGUILLO	7335771 , 1001348 , 95VW 2078-AE , 7M0 611 701 D	83.6117-0450.3
			02.2003	04.2006	83.7717-0450.3	330807	LATIGUILLO	7335771 , 1001348 , 95VW 2078-AE , 7M0 611 701 D	83.6117-0450.3
			01.1996	04.2006	83.7717-0450.3	330807	LATIGUILLO	7335771 , 1001348 , 95VW 2078-AE , 7M0 611 701 D	83.6117-0450.3
			10.1997	03.2000	83.7717-0450.3	330807	LATIGUILLO	7335771 , 1001348 , 95VW 2078-AE , 7M0 611 701 D	83.6117-0450.3
	2,0 i		09.1995	04.2006	83.7717-0450.3	330807	LATIGUILLO	7335771 , 1001348 , 95VW 2078-AE , 7M0 611 701 D	83.6117-0450.3
	2,3 i 16V		01.1997	04.2006	83.7717-0450.3	330807	LATIGUILLO	7335771 , 1001348 , 95VW 2078-AE , 7M0 611 701 D	83.6117-0450.3
	2,8 i V6		09.1995	03.2000	83.7717-0450.3	330807	LATIGUILLO	7335771 , 1001348 , 95VW 2078-AE , 7M0 611 701 D	83.6117-0450.3
TRANSIT (06-)	2,2 TDCi		05.2006		13.0460-3835.2	603835	PASTILLAS DE FRENO	1371454 , 1433958	ver figura
	2,3 i 16V		05.2006		13.0460-3835.2	603835	PASTILLAS DE FRENO	1371454 , 1433958	ver figura
	2,4 DI		05.2006		13.0460-3835.2	603835	PASTILLAS DE FRENO	1371454 , 1433958	ver figura
	2,4 TDCi		05.2006		13.0460-3835.2	603835	PASTILLAS DE FRENO	1371454 , 1433958	ver figura

Nuevas referencias en almacén - Por aplicación

09/2007



					Denominación	Ref. OE correspondientes a las referencias ATE		Referencia anterior / varios
--	--	--	--	--	--------------	--	--	------------------------------

HONDA

CIVIC (3/4-puertas) (96-01)	1,4 i (EJ9)	DI	01.1998	01.2001	24.3541-1805.5	240323	PINZA DE GARRA	45019-S04-V01 , 45019-SR3-V00	
		DD	01.1998	01.2001	24.3541-1806.5	240324	PINZA DE GARRA	45018-S04-V01 , 45018-SR3-V00	
		DD	11.1995	12.1997	24.3511-1710.5	240334	PINZA DE GARRA	45018-S04-003 , 45018-S04-G01	
	1,5 VTEC (EK3)	DD	11.1995	01.2001	24.3541-1806.5	240324	PINZA DE GARRA	45018-S04-V01 , 45018-SR3-V00	
		DI	11.1995	01.2001	24.3541-1805.5	240323	PINZA DE GARRA	45019-S04-V01 , 45019-SR3-V00	
	1,6 VTEC (EK1)	DD	11.1995	01.2001	24.3541-1806.5	240324	PINZA DE GARRA	45018-S04-V01 , 45018-SR3-V00	
		DI	11.1995	01.2001	24.3541-1805.5	240323	PINZA DE GARRA	45019-S04-V01 , 45019-SR3-V00	
	1,6 VTEC (EK4)	DI	11.1995	01.2001	24.3541-1805.5	240323	PINZA DE GARRA	45019-S04-V01 , 45019-SR3-V00	
		DD	11.1995	01.2001	24.3541-1806.5	240324	PINZA DE GARRA	45018-S04-V01 , 45018-SR3-V00	
CIVIC (5-puertas) (95-96)	1,4 i (MA8)		01.1996	12.1996	24.3219-1743.3	020485	CILINDRO DE RUEDA	43301-ST3-E01 , 43300-ST3-E01 , 58330-25000 , 58380-25000 , SML100090 , SML100080 , GWC901634 , GWC901635	24.3219-1737.3
	1,5 VTEC E (MA9)		01.1996	12.1996	24.3219-1743.3	020485	CILINDRO DE RUEDA	43301-ST3-E01 , 43300-ST3-E01 , 58330-25000 , 58380-25000 , SML100090 , SML100080 , GWC901634 , GWC901635	24.3219-1737.3



					Denominación	Ref. OE correspondientes a las referencias ATE		Referencia anterior / varios
--	--	--	--	--	--------------	--	--	------------------------------

HONDA

CIVIC AERODECK (98-01)	1,4 i 16V (MB8)		02.1998	02.2001	24.3219-1743.3	020485	CILINDRO DE RUEDA	43301-ST3-E01 , 43300-ST3-E01 , 58330-25000 , 58380-25000 , SML100090 , SML100080 , GWC901634 , GWC901635	24.3219-1737.3
	1,5 VTEC (MB9)		02.1998	02.2001	24.3219-1743.3	020485	CILINDRO DE RUEDA	43301-ST3-E01 , 43300-ST3-E01 , 58330-25000 , 58380-25000 , SML100090 , SML100080 , GWC901634 , GWC901635	24.3219-1737.3
CIVIC COUPE (96-01)	1,6 i (EJ6)	DD	01.1996	01.2001	24.3511-1710.5	240334	PINZA DE GARRA	45018-S04-003 , 45018-S04-G01	
	1,6 VTEC (EJ8)	DD	01.1996	01.2001	24.3541-1806.5	240324	PINZA DE GARRA	45018-S04-V01 , 45018-SR3-V00	
		DI	01.1996	01.2001	24.3541-1805.5	240323	PINZA DE GARRA	45019-S04-V01 , 45019-SR3-V00	
CRX (92-98)	1,6 i 16V VTEC (EG2)	DI	01.1992	12.1998	24.3541-1805.5	240323	PINZA DE GARRA	45019-S04-V01 , 45019-SR3-V00	
		DD	01.1992	12.1998	24.3541-1806.5	240324	PINZA DE GARRA	45018-S04-V01 , 45018-SR3-V00	
	1,6 i 16V VTEC (EH6)	DD	01.1992	12.1998	24.3541-1806.5	240324	PINZA DE GARRA	45018-S04-V01 , 45018-SR3-V00	
		DI	01.1992	12.1998	24.3541-1805.5	240323	PINZA DE GARRA	45019-S04-V01 , 45019-SR3-V00	
LOGO (99-02)	1,3 i	DD	02.1999	03.2002	24.3511-1710.5	240334	PINZA DE GARRA	45018-S04-003 , 45018-S04-G01	
PRELUDE (96-00)	2,0 i 16V (BB9)		10.1996	10.2000	24.0109-0141.1	409141	DISCO DE FRENO	42510-S30-900 , 42510-S30-000	

Nuevas referencias en almacén - Por aplicación

09/2007



					Denominación	Ref. OE correspondientes a las referencias ATE		Referencia anterior / varios
--	--	--	--	--	--------------	--	--	------------------------------

HYUNDAI

ACCENT (00-05)	1,3 i 12V	DI	01.2000	09.2005	24.3541-1807.5	240335	PINZA DE GARRA	58180-23A00 , 58180-24A00 , 58180-28A00 , 58180-25A00	
		DI	01.2000	07.2002	24.3541-1807.5	240335	PINZA DE GARRA	58180-23A00 , 58180-24A00 , 58180-28A00 , 58180-25A00	
		DI	08.2002	09.2005	24.3541-1807.5	240335	PINZA DE GARRA	58180-23A00 , 58180-24A00 , 58180-28A00 , 58180-25A00	
			01.2000	07.2002	24.3219-1743.3	020485	CILINDRO DE RUEDA	43301-ST3-E01 , 43300-ST3-E01 , 58330-25000 , 58380-25000 , SML100090 , SML100080 , GWC901634 , GWC901635	24.3219-1737.3
	1,5 CRDi	DI	04.2002	09.2005	24.3541-1807.5	240335	PINZA DE GARRA	58180-23A00 , 58180-24A00 , 58180-28A00 , 58180-25A00	
			04.2002	07.2002	24.3219-1743.3	020485	CILINDRO DE RUEDA	43301-ST3-E01 , 43300-ST3-E01 , 58330-25000 , 58380-25000 , SML100090 , SML100080 , GWC901634 , GWC901635	24.3219-1737.3
	1,5 i 12V	DI	01.2000	10.2002	24.3541-1807.5	240335	PINZA DE GARRA	58180-23A00 , 58180-24A00 , 58180-28A00 , 58180-25A00	
			01.2000	07.2002	24.3219-1743.3	020485	CILINDRO DE RUEDA	43301-ST3-E01 , 43300-ST3-E01 , 58330-25000 , 58380-25000 , SML100090 , SML100080 , GWC901634 , GWC901635	24.3219-1737.3
	1,5 i 16V	DI	09.2000	09.2005	24.3541-1807.5	240335	PINZA DE GARRA	58180-23A00 , 58180-24A00 , 58180-28A00 , 58180-25A00	
			09.2000	07.2002	24.3219-1743.3	020485	CILINDRO DE RUEDA	43301-ST3-E01 , 43300-ST3-E01 , 58330-25000 , 58380-25000 , SML100090 , SML100080 , GWC901634 , GWC901635	24.3219-1737.3



					Denominación	Ref. OE correspondientes a las referencias ATE		Referencia anterior / varios
--	--	--	--	--	--------------	--	--	------------------------------

HYUNDAI

ACCENT (00-05)	1,6 i 16V	DI	10.2002	09.2005	24.3541-1807.5	240335	PINZA DE GARRA	58180-23A00 , 58180-24A00 , 58180-28A00 , 58180-25A00	
ACCENT (05-)	1,4 i 16V		10.2005		24.0110-0312.1	410312	DISCO DE FRENO	58411-1C800	
	1,5 CRDi		10.2005		24.0110-0312.1	410312	DISCO DE FRENO	58411-1C800	
	1,6 i 16V		10.2005		24.0110-0312.1	410312	DISCO DE FRENO	58411-1C800	
ELANTRA (00-03)			11.2001	07.2003	24.3219-1743.3	020485	CILINDRO DE RUEDA	43301-ST3-E01 , 43300-ST3-E01 , 58330-25000 , 58380-25000 , SML100090 , SML100080 , GWC901634 , GWC901635	24.3219-1737.3
	1,8 i 16V		11.2001	07.2003	24.3219-1743.3	020485	CILINDRO DE RUEDA	43301-ST3-E01 , 43300-ST3-E01 , 58330-25000 , 58380-25000 , SML100090 , SML100080 , GWC901634 , GWC901635	24.3219-1737.3
	2,0 CRDi		11.2001	07.2003	24.3219-1743.3	020485	CILINDRO DE RUEDA	43301-ST3-E01 , 43300-ST3-E01 , 58330-25000 , 58380-25000 , SML100090 , SML100080 , GWC901634 , GWC901635	24.3219-1737.3
	2,0 i 16V		11.2001	07.2003	24.3219-1743.3	020485	CILINDRO DE RUEDA	43301-ST3-E01 , 43300-ST3-E01 , 58330-25000 , 58380-25000 , SML100090 , SML100080 , GWC901634 , GWC901635	24.3219-1737.3
GETZ (02-)	1,1 i 12V	DI	09.2005		24.3541-1807.5	240335	PINZA DE GARRA	58180-23A00 , 58180-24A00 , 58180-28A00 , 58180-25A00	
		DI	09.2002	08.2005	24.3541-1807.5	240335	PINZA DE GARRA	58180-23A00 , 58180-24A00 , 58180-28A00 , 58180-25A00	
	1,3 i 12V	DI	09.2003	04.2005	24.3541-1807.5	240335	PINZA DE GARRA	58180-23A00 , 58180-24A00 , 58180-28A00 , 58180-25A00	



					Denominación	Ref. OE correspondientes a las referencias ATE		Referencia anterior / varios
--	--	--	--	--	--------------	--	--	------------------------------

HYUNDAI

GETZ (02-)	1,3 i 12V	DI	09.2002	04.2005	24.3541-1807.5	240335	PINZA DE GARRA	58180-23A00 , 58180-24A00 , 58180-28A00 , 58180-25A00	
	1,4 i 16V	DI	08.2005		24.3541-1807.5	240335	PINZA DE GARRA	58180-23A00 , 58180-24A00 , 58180-28A00 , 58180-25A00	
	1,5 CRDi		07.2003	04.2005	24.0110-0312.1	410312	DISCO DE FRENO	58411-1C800	
			08.2005		24.0110-0312.1	410312	DISCO DE FRENO	58411-1C800	
		DI	08.2005		24.3541-1807.5	240335	PINZA DE GARRA	58180-23A00 , 58180-24A00 , 58180-28A00 , 58180-25A00	
		DI	03.2003	04.2005	24.3541-1807.5	240335	PINZA DE GARRA	58180-23A00 , 58180-24A00 , 58180-28A00 , 58180-25A00	
	1,5 CRDi GLS		07.2004	08.2005	24.0110-0312.1	410312	DISCO DE FRENO	58411-1C800	
			08.2005		24.0110-0312.1	410312	DISCO DE FRENO	58411-1C800	
		DI	08.2005		24.3541-1807.5	240335	PINZA DE GARRA	58180-23A00 , 58180-24A00 , 58180-28A00 , 58180-25A00	
		DI	07.2004	08.2005	24.3541-1807.5	240335	PINZA DE GARRA	58180-23A00 , 58180-24A00 , 58180-28A00 , 58180-25A00	
	1,5 i GL	DI	08.2002	07.2005	24.3541-1807.5	240335	PINZA DE GARRA	58180-23A00 , 58180-24A00 , 58180-28A00 , 58180-25A00	
	1,6 i 16V		07.2003	07.2005	24.0110-0312.1	410312	DISCO DE FRENO	58411-1C800	
		DI	09.2002	07.2005	24.3541-1807.5	240335	PINZA DE GARRA	58180-23A00 , 58180-24A00 , 58180-28A00 , 58180-25A00	
LANTRA (00-03)			11.2001	07.2003	24.3219-1743.3	020485	CILINDRO DE RUEDA	43301-ST3-E01 , 43300-ST3-E01 , 58330-25000 , 58380-25000 , SML100090 , SML100080 , GWC901634 , GWC901635	24.3219-1737.3

Nuevas referencias en almacén - Por aplicación

09/2007



					Denominación	Ref. OE correspondientes a las referencias ATE		Referencia anterior / varios
--	--	--	--	--	--------------	--	--	------------------------------

HYUNDAI

LANTRA (00-03)	1,8 i 16V		11.2001	07.2003	24.3219-1743.3	020485	CILINDRO DE RUEDA	43301-ST3-E01 , 43300-ST3-E01 , 58330-25000 , 58380-25000 , SML100090 , SML100080 , GWC901634 , GWC901635	24.3219-1737.3
	2,0 CRDi		11.2001	07.2003	24.3219-1743.3	020485	CILINDRO DE RUEDA	43301-ST3-E01 , 43300-ST3-E01 , 58330-25000 , 58380-25000 , SML100090 , SML100080 , GWC901634 , GWC901635	24.3219-1737.3
	2,0 i 16V		11.2001	07.2003	24.3219-1743.3	020485	CILINDRO DE RUEDA	43301-ST3-E01 , 43300-ST3-E01 , 58330-25000 , 58380-25000 , SML100090 , SML100080 , GWC901634 , GWC901635	24.3219-1737.3
LANTRA/ELANTRA (90-95)	1,5	DI	12.1990	04.1995	24.3541-1807.5	240335	PINZA DE GARRA	58180-23A00 , 58180-24A00 , 58180-28A00 , 58180-25A00	
MATRIX (01-)	1,5 CRDi		12.2004		24.3219-1743.3	020485	CILINDRO DE RUEDA	43301-ST3-E01 , 43300-ST3-E01 , 58330-25000 , 58380-25000 , SML100090 , SML100080 , GWC901634 , GWC901635	24.3219-1737.3
			10.2001		24.3219-1743.3	020485	CILINDRO DE RUEDA	43301-ST3-E01 , 43300-ST3-E01 , 58330-25000 , 58380-25000 , SML100090 , SML100080 , GWC901634 , GWC901635	24.3219-1737.3
	1,5 CRDi VGT		08.2005		24.3219-1743.3	020485	CILINDRO DE RUEDA	43301-ST3-E01 , 43300-ST3-E01 , 58330-25000 , 58380-25000 , SML100090 , SML100080 , GWC901634 , GWC901635	24.3219-1737.3

Nuevas referencias en almacén - Por aplicación

09/2007



					Denominación	Ref. OE correspondientes a las referencias ATE		Referencia anterior / varios
--	--	--	--	--	--------------	--	--	------------------------------

HYUNDAI

MATRIX (01-)	1,6 i 16V		06.2001		24.3219-1743.3	020485	CILINDRO DE RUEDA	43301-ST3-E01 , 43300-ST3-E01 , 58330-25000 , 58380-25000 , SML100090 , SML100080 , GWC901634 , GWC901635	24.3219-1737.3
PONY/EXCEL (89-94)	1,3	DI	08.1989	06.1994	24.3541-1807.5	240335	PINZA DE GARRA	58180-23A00 , 58180-24A00 , 58180-28A00 , 58180-25A00	
	1,5	DI	08.1989	06.1994	24.3541-1807.5	240335	PINZA DE GARRA	58180-23A00 , 58180-24A00 , 58180-28A00 , 58180-25A00	
S-COUPE (90-96)	1,5 (G4DJ)	DI	03.1990	05.1992	24.3541-1807.5	240335	PINZA DE GARRA	58180-23A00 , 58180-24A00 , 58180-28A00 , 58180-25A00	
	1,5 (G4EK)	DI	06.1992	04.1996	24.3541-1807.5	240335	PINZA DE GARRA	58180-23A00 , 58180-24A00 , 58180-28A00 , 58180-25A00	

JEEP

CHEROKEE (KJ) (01-)	2,4		09.2001		13.0460-8008.2	608008	PASTILLAS DE FRENO	5019 805AA , 5071 948AA	ver figura
	2,5 CRD		09.2001		13.0460-8008.2	608008	PASTILLAS DE FRENO	5019 805AA , 5071 948AA	ver figura
	2,8 CRD		11.2002		13.0460-8008.2	608008	PASTILLAS DE FRENO	5019 805AA , 5071 948AA	ver figura
	3,7 V6		09.2001		13.0460-8008.2	608008	PASTILLAS DE FRENO	5019 805AA , 5071 948AA	ver figura

Nuevas referencias en almacén - Por aplicación

09/2007



					Denominación	Ref. OE correspondientes a las referencias ATE		Referencia anterior / varios
--	--	--	--	--	--------------	--	--	------------------------------

KIA

PRIDE (05-)	1,4 i 16V		03.2005		24.0110-0312.1	410312	DISCO DE FRENO	58411-1C800	
	1,5 CRDi		03.2005		24.0110-0312.1	410312	DISCO DE FRENO	58411-1C800	
	1,6 i 16V		03.2005		24.0110-0312.1	410312	DISCO DE FRENO	58411-1C800	
PRIDE Break (98-01)	1,3		08.1999	05.2001	24.0217-0001.1	480198	TAMBORES DE FRENO	MDA01-26-251A	
PRIDE Berlina (94-00)	1,3 i 16V		10.1996	10.2000	24.0217-0001.1	480198	TAMBORES DE FRENO	MDA01-26-251A	
RIO II (05-)	1,4 i 16V		03.2005		24.0110-0312.1	410312	DISCO DE FRENO	58411-1C800	
	1,5 CRDi		03.2005		24.0110-0312.1	410312	DISCO DE FRENO	58411-1C800	
	1,6 i 16V		03.2005		24.0110-0312.1	410312	DISCO DE FRENO	58411-1C800	
SEPHIA I (93-98)	1,5 16V		02.1996	12.1998	24.0110-0300.1	410300	DISCO DE FRENO	0K20H-26-251	
	1,6 i		10.1993	06.1996	24.0110-0300.1	410300	DISCO DE FRENO	0K20H-26-251	
	1,8 16V		01.1995	12.1998	24.0110-0300.1	410300	DISCO DE FRENO	0K20H-26-251	

LANCIA

MUSA (04-)	1,3 JTD	DI	10.2004		24.3541-1811.7	220623	PINZA DE GARRA	9949336	
		DD	10.2004		24.3541-1812.7	220624	PINZA DE GARRA	9949342	
	1,4 i	DI	07.2005		24.3541-1811.7	220623	PINZA DE GARRA	9949336	
		DD	07.2005		24.3541-1812.7	220624	PINZA DE GARRA	9949342	
	1,4 i 16V	DD	10.2004		24.3541-1812.7	220624	PINZA DE GARRA	9949342	
		DI	10.2004		24.3541-1811.7	220623	PINZA DE GARRA	9949336	



					Denominación	Ref. OE correspondientes a las referencias ATE		Referencia anterior / varios
--	--	--	--	--	--------------	--	--	------------------------------

LAND ROVER

DISCOVERY I (89-98)	2,0 16V		09.1993	06.1994	13.0460-6917.2	606917	PASTILLAS DE FRENO	STC8570 , STC9189	ver figura
	2,5 TDI		09.1989	12.1998	13.0460-6917.2	606917	PASTILLAS DE FRENO	STC8570 , STC9189	ver figura
	3,5 V8		09.1989	03.1994	13.0460-6917.2	606917	PASTILLAS DE FRENO	STC8570 , STC9189	ver figura
	3,9/4,0 V8		09.1993	12.1998	13.0460-6917.2	606917	PASTILLAS DE FRENO	STC8570 , STC9189	ver figura
DISCOVERY II (94-04)	2,0 16V		07.1994	07.2004	13.0460-6917.2	606917	PASTILLAS DE FRENO	STC8570 , STC9189	ver figura
	2,5 TDI		10.1995	07.2004	13.0460-6917.2	606917	PASTILLAS DE FRENO	STC8570 , STC9189	ver figura
RANGE ROVER I (70-94)	2,4 D		04.1986	12.1990	13.0460-6917.2	606917	PASTILLAS DE FRENO	STC8570 , STC9189	ver figura
	3,5		07.1987	09.1990	13.0460-6917.2	606917	PASTILLAS DE FRENO	STC8570 , STC9189	ver figura
	3,5 VOGUE		10.1985	09.1990	13.0460-6917.2	606917	PASTILLAS DE FRENO	STC8570 , STC9189	ver figura
	3,9 KAT		11.1988	07.1994	13.0460-6917.2	606917	PASTILLAS DE FRENO	STC8570 , STC9189	ver figura
	3,9 VOGUE		11.1988	07.1994	13.0460-6917.2	606917	PASTILLAS DE FRENO	STC8570 , STC9189	ver figura
	4,3 VOGUE LSE		09.1992	07.1994	13.0460-6917.2	606917	PASTILLAS DE FRENO	STC8570 , STC9189	ver figura

LEXUS

LX 470 (02-)	4,7 i V8 4WD (UZJ100)		08.2002		24.0132-0148.1	432148	DISCO DE FRENO	43512-60130 , 43512-60170	
--------------	-----------------------	--	---------	--	----------------	--------	----------------	---------------------------	--



	i				Denominación	Ref. OE correspondientes a las referencias ATE	i Referencia anterior / varios
--	----------	--	--	--	--------------	--	--

MAZDA

MX-5 (98-05)	1,9 i 16V (NB18)		08.2000	02.2005	24.0110-0307.1	410307	DISCO DE FRENO	N06Y-26-251 , NOYY-26-251 , N06Y-26-251A , NOYY-26-251A , N06Y-26-251B , NOYY-26-251B	
RX-8 (03-)	2,6 i		10.2003		13.0460-5877.2	605877	PASTILLAS DE FRENO	F1Y9-33-23Z , F1YA-33-23ZB	ver figura



					Denominación	Ref. OE correspondientes a las referencias ATE		Referencia anterior / varios
--	--	--	--	--	--------------	--	--	------------------------------

MERCEDES BENZ

Clase A (W168) (97-04)	A 140		09.1997	08.2004	13.0460-0163.2	610163	ACCESORIO PASTILLAS	
	A 160 CDI		02.2001	08.2004	13.0460-0163.2	610163	ACCESORIO PASTILLAS	
			08.1998	01.2001	13.0460-0163.2	610163	ACCESORIO PASTILLAS	
Clase A (W169) (04-)	A 170		08.2004		24.0122-0232.1	422232	DISCO DE FRENO	169 421 01 12
	A 180 CDI		08.2004		24.0122-0232.1	422232	DISCO DE FRENO	169 421 01 12
	A 200		08.2004		24.0122-0232.1	422232	DISCO DE FRENO	169 421 01 12
Clase B (W245) (05-)	B 150		04.2005		24.0122-0232.1	422232	DISCO DE FRENO	169 421 01 12
	B 170		04.2005		24.0122-0232.1	422232	DISCO DE FRENO	169 421 01 12
Transporter (BM 901/902) SPRINTER (95-06)	208 CDI	TD	04.2000	05.2006	24.3441-1702.5	240332	PINZA DE GARRA	2D0 615 106 B , 902 420 12 01 , 904 420 09 01
	208 D	TD	02.1995	05.2006	24.3441-1702.5	240332	PINZA DE GARRA	2D0 615 106 B , 902 420 12 01 , 904 420 09 01
	210 D	TD	01.1997	05.2006	24.3441-1702.5	240332	PINZA DE GARRA	2D0 615 106 B , 902 420 12 01 , 904 420 09 01
	211 CDI	TD	04.2000	05.2006	24.3441-1702.5	240332	PINZA DE GARRA	2D0 615 106 B , 902 420 12 01 , 904 420 09 01
	212 D	TD	02.1995	05.2006	24.3441-1702.5	240332	PINZA DE GARRA	2D0 615 106 B , 902 420 12 01 , 904 420 09 01
	213 CDI	TD	04.2000	05.2006	24.3441-1702.5	240332	PINZA DE GARRA	2D0 615 106 B , 902 420 12 01 , 904 420 09 01
	214	TD	04.2000	05.2006	24.3441-1702.5	240332	PINZA DE GARRA	2D0 615 106 B , 902 420 12 01 , 904 420 09 01
		TD	02.1995	05.2006	24.3441-1702.5	240332	PINZA DE GARRA	2D0 615 106 B , 902 420 12 01 , 904 420 09 01

Nuevas referencias en almacén - Por aplicación

09/2007



				Denominación	Ref. OE correspondientes a las referencias ATE		Referencia anterior / varios
--	--	--	--	--------------	--	--	------------------------------

MERCEDES BENZ

Transporter (BM 901/902) SPRINTER (95-06)	216 CDI	TD	04.2000	05.2006	24.3441-1702.5	240332	PINZA DE GARRA	2D0 615 106 B , 902 420 12 01 , 904 420 09 01	
Transporter (BM 903/904) SPRINTER (95-06)	308 CDI	TD	04.2000	05.2006	24.3441-1702.5	240332	PINZA DE GARRA	2D0 615 106 B , 902 420 12 01 , 904 420 09 01	
	308 D	TD	02.1995	05.2006	24.3441-1702.5	240332	PINZA DE GARRA	2D0 615 106 B , 902 420 12 01 , 904 420 09 01	
	310 D	TD	02.1995	05.2006	24.3441-1702.5	240332	PINZA DE GARRA	2D0 615 106 B , 902 420 12 01 , 904 420 09 01	
	311 CDI	TD	04.2000	05.2006	24.3441-1702.5	240332	PINZA DE GARRA	2D0 615 106 B , 902 420 12 01 , 904 420 09 01	
	312 D	TD	02.1995	05.2006	24.3441-1702.5	240332	PINZA DE GARRA	2D0 615 106 B , 902 420 12 01 , 904 420 09 01	
	313 CDI	TD	04.2000	05.2006	24.3441-1702.5	240332	PINZA DE GARRA	2D0 615 106 B , 902 420 12 01 , 904 420 09 01	
	314	TD	04.2000	05.2006	24.3441-1702.5	240332	PINZA DE GARRA	2D0 615 106 B , 902 420 12 01 , 904 420 09 01	
		TD	02.1995	05.2006	24.3441-1702.5	240332	PINZA DE GARRA	2D0 615 106 B , 902 420 12 01 , 904 420 09 01	
	316 CDI	TD	04.2000	05.2006	24.3441-1702.5	240332	PINZA DE GARRA	2D0 615 106 B , 902 420 12 01 , 904 420 09 01	
	408 CDI	TD	04.2000	05.2006	24.3441-1702.5	240332	PINZA DE GARRA	2D0 615 106 B , 902 420 12 01 , 904 420 09 01	
		TD	04.2000	05.2006	24.3441-1702.5	240332	PINZA DE GARRA	2D0 615 106 B , 902 420 12 01 , 904 420 09 01	
	408 D	TD		05.2006	24.3441-1702.5	240332	PINZA DE GARRA	2D0 615 106 B , 902 420 12 01 , 904 420 09 01	



					Denominación	Ref. OE correspondientes a las referencias ATE		Referencia anterior / varios
--	--	--	--	--	--------------	--	--	------------------------------

MERCEDES BENZ

Transporter (BM 903/904) SPRINTER (95-06)	416 CDI	TD	04.2000	05.2006	24.3441-1702.5	240332	PINZA DE GARRA	2D0 615 106 B , 902 420 12 01 , 904 420 09 01	
		TD	04.2000	05.2006	24.3441-1702.5	240332	PINZA DE GARRA	2D0 615 106 B , 902 420 12 01 , 904 420 09 01	
Transporter (BM 905) SPRINTER (01-06)	616 CDI	TD	04.2001	05.2006	24.3441-1702.5	240332	PINZA DE GARRA	2D0 615 106 B , 902 420 12 01 , 904 420 09 01	
VITO (BM638) (96-03)	108 CDI	TI	03.1999	08.2003	24.3331-1701.7	220611	PINZA DE GARRA	001 420 64 83	
			03.1999	08.2003	13.0460-0288.2	610288	ACCESORIO PASTILLAS	000 420 04 02	13.0460-0249.2
	108 D	TI	03.1996	08.2003	24.3331-1701.7	220611	PINZA DE GARRA	001 420 64 83	
			03.1996	08.2003	13.0460-0288.2	610288	ACCESORIO PASTILLAS	000 420 04 02	13.0460-0249.2
	110 CDI	TI	03.1999	08.2003	24.3331-1701.7	220611	PINZA DE GARRA	001 420 64 83	
			03.1999	08.2003	13.0460-0288.2	610288	ACCESORIO PASTILLAS	000 420 04 02	13.0460-0249.2
	110 D	TI	03.1996	08.2003	24.3331-1701.7	220611	PINZA DE GARRA	001 420 64 83	
			03.1996	08.2003	13.0460-0288.2	610288	ACCESORIO PASTILLAS	000 420 04 02	13.0460-0249.2
	112 CDI	TI	03.1999	08.2003	24.3331-1701.7	220611	PINZA DE GARRA	001 420 64 83	
			03.1999	08.2003	13.0460-0288.2	610288	ACCESORIO PASTILLAS	000 420 04 02	13.0460-0249.2
	113	TI	03.1996	08.2003	24.3331-1701.7	220611	PINZA DE GARRA	001 420 64 83	
			03.1996	08.2003	13.0460-0288.2	610288	ACCESORIO PASTILLAS	000 420 04 02	13.0460-0249.2
	114	TI	12.1996	08.2003	24.3331-1701.7	220611	PINZA DE GARRA	001 420 64 83	
			12.1996	08.2003	13.0460-0288.2	610288	ACCESORIO PASTILLAS	000 420 04 02	13.0460-0249.2
Clase V (BM638) (96-03)	V 200	TI	09.1996	08.2003	24.3331-1701.7	220611	PINZA DE GARRA	001 420 64 83	

Nuevas referencias en almacén - Por aplicación

09/2007



					Denominación	Ref. OE correspondientes a las referencias ATE		Referencia anterior / varios
--	--	--	--	--	--------------	--	--	------------------------------

MERCEDES BENZ

Clase V (BM638) (96-03)	V 200		09.1996	08.2003	13.0460-0288.2	610288	ACCESORIO PASTILLAS	000 420 04 02	13.0460-0249.2
	V 200 CDI	TI	03.1999	08.2003	24.3331-1701.7	220611	PINZA DE GARRA	001 420 64 83	
			03.1999	08.2003	13.0460-0288.2	610288	ACCESORIO PASTILLAS	000 420 04 02	13.0460-0249.2
	V 220 CDI	TI	03.1999	08.2003	24.3331-1701.7	220611	PINZA DE GARRA	001 420 64 83	
			03.1999	08.2003	13.0460-0288.2	610288	ACCESORIO PASTILLAS	000 420 04 02	13.0460-0249.2
	V 230	TI	09.1996	08.2003	24.3331-1701.7	220611	PINZA DE GARRA	001 420 64 83	
			09.1996	08.2003	13.0460-0288.2	610288	ACCESORIO PASTILLAS	000 420 04 02	13.0460-0249.2
	V 230 TD	TI	09.1996	08.2003	24.3331-1701.7	220611	PINZA DE GARRA	001 420 64 83	
			09.1996	08.2003	13.0460-0288.2	610288	ACCESORIO PASTILLAS	000 420 04 02	13.0460-0249.2
	V 280	TI	09.1997	08.2003	24.3331-1701.7	220611	PINZA DE GARRA	001 420 64 83	
			09.1997	08.2003	13.0460-0288.2	610288	ACCESORIO PASTILLAS	000 420 04 02	13.0460-0249.2

MITSUBISHI

PAJERO (00-)	2,5 TDIC (V64W)		04.2000	10.2003	24.0122-0724.1	422724	DISCO DE FRENO	MR418067	
	3,2 DiD (V68W)		10.2001		24.0122-0724.1	422724	DISCO DE FRENO	MR418067	
			04.2000	09.2001	24.0122-0724.1	422724	DISCO DE FRENO	MR418067	
	3,5 i V6 GDI (V65W)		04.2000		24.0122-0724.1	422724	DISCO DE FRENO	MR418067	
PAJERO (05-)	3,2 DiD (V88W)		05.2005		24.0122-0724.1	422724	DISCO DE FRENO	MR418067	
	3,8 i V6 (V87W)		05.2005		24.0122-0724.1	422724	DISCO DE FRENO	MR418067	



	i			Denominación	Ref. OE correspondientes a las referencias ATE	i Referencia anterior / varios
--	----------	--	--	---------------------	---	--

NISSAN

INTERSTAR (X70) (02-)	1,9 CDi		01.2003		24.2123-1759.3	010768	CIL. MAESTRO TANDEM	44 05 404 , 9121237 , 46010-00QAP , 77 01 207 979	
	2,2 CDi		01.2003		24.2123-1759.3	010768	CIL. MAESTRO TANDEM	44 05 404 , 9121237 , 46010-00QAP , 77 01 207 979	
	2,5 CDi		01.2003		24.2123-1759.3	010768	CIL. MAESTRO TANDEM	44 05 404 , 9121237 , 46010-00QAP , 77 01 207 979	
	3,0 CDi		11.2003		24.2123-1759.3	010768	CIL. MAESTRO TANDEM	44 05 404 , 9121237 , 46010-00QAP , 77 01 207 979	
SERENA/VANETTE CARGO (C23M/963) (92-01)	1,6 i 16V		07.1992	11.2001	13.0460-5881.2	605881	PASTILLAS DE FRENO	41060-9C025 , 41060-9C026	ver figura
	2,0 D		07.1992	08.1994	13.0460-5881.2	605881	PASTILLAS DE FRENO	41060-9C025 , 41060-9C026	ver figura
	2,3 D		09.1994	11.2001	13.0460-5881.2	605881	PASTILLAS DE FRENO	41060-9C025 , 41060-9C026	ver figura

Nuevas referencias en almacén - Por aplicación

09/2007









					Denominación	Ref. OE correspondientes a las referencias ATE		Referencia anterior / varios
--	--	--	--	--	--------------	--	--	------------------------------

OPEL

KADETT E / Vau. Astra E/Belmont (84-93)	1,2	DI		09.1991	83.7894-0316.3	330814	LATIGUILLO	5 62 344 , 90236355	83.6294-0316.3
		DI	08.1984		83.6294-0315.3	330738	LATIGUILLO	5 62 336 , 90216275	83.5294-0315.3-
	1,3	DI		09.1991	83.7894-0316.3	330814	LATIGUILLO	5 62 344 , 90236355	83.6294-0316.3
		DI	08.1984		83.6294-0315.3	330738	LATIGUILLO	5 62 336 , 90216275	83.5294-0315.3-
	1,4	DI	08.1989	09.1991	83.7894-0316.3	330814	LATIGUILLO	5 62 344 , 90236355	83.6294-0316.3
	1,5 TD	DI	07.1988	09.1991	83.7894-0316.3	330814	LATIGUILLO	5 62 344 , 90236355	83.6294-0316.3
	1,6	DI	08.1984		83.6294-0315.3	330738	LATIGUILLO	5 62 336 , 90216275	83.5294-0315.3-
		DI		09.1991	83.7894-0316.3	330814	LATIGUILLO	5 62 344 , 90236355	83.6294-0316.3
	1,6 D	DI		09.1991	83.7894-0316.3	330814	LATIGUILLO	5 62 344 , 90236355	83.6294-0316.3
		DI	08.1984		83.6294-0315.3	330738	LATIGUILLO	5 62 336 , 90216275	83.5294-0315.3-
	1,7 D	DI	08.1988	09.1991	83.7894-0316.3	330814	LATIGUILLO	5 62 344 , 90236355	83.6294-0316.3
	1,8	DI		09.1991	83.7894-0316.3	330814	LATIGUILLO	5 62 344 , 90236355	83.6294-0316.3
		DI	08.1984		83.6294-0315.3	330738	LATIGUILLO	5 62 336 , 90216275	83.5294-0315.3-
	2	DI		09.1991	83.7894-0316.3	330814	LATIGUILLO	5 62 344 , 90236355	83.6294-0316.3
		DI	08.1984		83.6294-0315.3	330738	LATIGUILLO	5 62 336 , 90216275	83.5294-0315.3-
MOVANO (98-)	1,9 DTI		09.2003		24.2123-1759.3	010768	CIL. MAESTRO TANDEM	44 05 404 , 9121237 , 46010-00QAP , 77 01 207 979	
	2,2 DTI 16V		09.2003		24.2123-1759.3	010768	CIL. MAESTRO TANDEM	44 05 404 , 9121237 , 46010-00QAP , 77 01 207 979	
	2,5 DTI		10.2003		24.2123-1759.3	010768	CIL. MAESTRO TANDEM	44 05 404 , 9121237 , 46010-00QAP , 77 01 207 979	



					Denominación	Ref. OE correspondientes a las referencias ATE	 Referencia anterior / varios
---	---	---	---	---	---------------------	---	---

OPEL

MOVANO (98-)	2,5 DTI		09.2003		24.2123-1759.3	010768	CIL. MAESTRO TANDEM	44 05 404 , 9121237 , 46010-00QAP , 77 01 207 979	
	3,0 DTI		10.2003		24.2123-1759.3	010768	CIL. MAESTRO TANDEM	44 05 404 , 9121237 , 46010-00QAP , 77 01 207 979	



					Denominación	Ref. OE correspondientes a las referencias ATE		Referencia anterior / varios
--	--	--	--	--	--------------	--	--	------------------------------

PEUGEOT

106 (96-04)	1,1		05.1996		24.3728-0844.2	590844	CABLE DE EMBRAGUE	2150 Q6	24.3728-0821.2
	1,4		05.1996		24.3728-0844.2	590844	CABLE DE EMBRAGUE	2150 Q6	24.3728-0821.2
	1,5 D		05.1996		24.3728-0844.2	590844	CABLE DE EMBRAGUE	2150 Q6	24.3728-0821.2
	1,6		05.1996		24.3728-0844.2	590844	CABLE DE EMBRAGUE	2150 Q6	24.3728-0821.2
	1,6 16V		05.1996		24.3728-0844.2	590844	CABLE DE EMBRAGUE	2150 Q6	24.3728-0821.2
406 Break (96-)	1,8		05.1997		24.3728-0846.2	590846	CABLE DE EMBRAGUE	2150 W3 , 2150 N1	24.3728-0828.2
	1,8 16V		10.1995	10.2000	24.3728-0846.2	590846	CABLE DE EMBRAGUE	2150 W3 , 2150 N1	24.3728-0828.2
			10.2000		24.3728-0846.2	590846	CABLE DE EMBRAGUE	2150 W3 , 2150 N1	24.3728-0828.2
406 Berlina (95-04)	1,6 i		10.1995	05.2004	24.3728-0846.2	590846	CABLE DE EMBRAGUE	2150 W3 , 2150 N1	24.3728-0828.2
	1,8 16V		10.1995	10.2000	24.3728-0846.2	590846	CABLE DE EMBRAGUE	2150 W3 , 2150 N1	24.3728-0828.2
			10.2000	05.2004	24.3728-0846.2	590846	CABLE DE EMBRAGUE	2150 W3 , 2150 N1	24.3728-0828.2
	1,8 i		05.1997	05.2004	24.3728-0846.2	590846	CABLE DE EMBRAGUE	2150 W3 , 2150 N1	24.3728-0828.2
806 (94-02)			10.1996	06.2002	24.3728-0341.2	590341	CABLE DE EMBRAGUE	2150 H9 , 2150 S4 , 1476637080 , 1479128080	24.3728-0327.2
	2,0 i		08.1994	06.2002	24.3728-0341.2	590341	CABLE DE EMBRAGUE	2150 H9 , 2150 S4 , 1476637080 , 1479128080	24.3728-0327.2
BOXER (06-)	2,2 HDi (12/14)		04.2006		13.0460-4812.2	604812	PASTILLAS DE FRENO	4253 59 , 4253 60 , 77364016	ver figura
	2,2 HDi (16H)		04.2006		13.0460-4812.2	604812	PASTILLAS DE FRENO	4253 59 , 4253 60 , 77364016	ver figura
	2,2 HDi (16L)		04.2006		13.0460-4812.2	604812	PASTILLAS DE FRENO	4253 59 , 4253 60 , 77364016	ver figura
	2,2 HDi (20)		04.2006		13.0460-4812.2	604812	PASTILLAS DE FRENO	4253 59 , 4253 60 , 77364016	ver figura



					Denominación	Ref. OE correspondientes a las referencias ATE		Referencia anterior / varios
--	--	--	--	--	--------------	--	--	------------------------------







PEUGEOT

BOXER (06-)	3,0 HDi (12/14)		04.2006		13.0460-4812.2	604812	PASTILLAS DE FRENO	4253 59 , 4253 60 , 77364016	ver figura
	3,0 HDi (16H)		04.2006		13.0460-4812.2	604812	PASTILLAS DE FRENO	4253 59 , 4253 60 , 77364016	ver figura
	3,0 HDi (16L)		04.2006		13.0460-4812.2	604812	PASTILLAS DE FRENO	4253 59 , 4253 60 , 77364016	ver figura
	3,0 HDi (20)		04.2006		13.0460-4812.2	604812	PASTILLAS DE FRENO	4253 59 , 4253 60 , 77364016	ver figura
EXPERT Furgón (95-)	1,6		10.1995		24.3728-0341.2	590341	CABLE DE EMBRAGUE	2150 H9 , 2150 S4 , 1476637080 , 1479128080	24.3728-0327.2
	1,8		10.1996		24.3728-0341.2	590341	CABLE DE EMBRAGUE	2150 H9 , 2150 S4 , 1476637080 , 1479128080	24.3728-0327.2
	1,9 D		10.1995		24.3728-0341.2	590341	CABLE DE EMBRAGUE	2150 H9 , 2150 S4 , 1476637080 , 1479128080	24.3728-0327.2
EXPERT Break (95-)	1,6		10.1995		24.3728-0341.2	590341	CABLE DE EMBRAGUE	2150 H9 , 2150 S4 , 1476637080 , 1479128080	24.3728-0327.2
	1,8		10.1996		24.3728-0341.2	590341	CABLE DE EMBRAGUE	2150 H9 , 2150 S4 , 1476637080 , 1479128080	24.3728-0327.2
PARTNER Break (96-)	1,6 16V		07.2001		24.2123-1757.3	010765	CIL. MAESTRO TANDEM	4601 P8	
	2,0 HDi 90		02.2000		24.2123-1757.3	010765	CIL. MAESTRO TANDEM	4601 P8	

Nuevas referencias en almacén - Por aplicación

09/2007



					Denominación	Ref. OE correspondientes a las referencias ATE	 Referencia anterior / varios
---	---	---	---	---	---------------------	---	--

RENAULT

MASTER II Bus (JD/ND_) (98-06)	1,9 dCi 80		11.2003		24.2123-1759.3	010768	CIL. MAESTRO TANDEM	44 05 404 , 9121237 , 46010-00QAP , 77 01 207 979	
	1,9 dTi		11.2003		24.2123-1759.3	010768	CIL. MAESTRO TANDEM	44 05 404 , 9121237 , 46010-00QAP , 77 01 207 979	
	2,2 dCi 90		11.2003		24.2123-1759.3	010768	CIL. MAESTRO TANDEM	44 05 404 , 9121237 , 46010-00QAP , 77 01 207 979	
	2,5 dCi 100		10.2003		24.2123-1759.3	010768	CIL. MAESTRO TANDEM	44 05 404 , 9121237 , 46010-00QAP , 77 01 207 979	
	2,5 dCi 120		11.2003		24.2123-1759.3	010768	CIL. MAESTRO TANDEM	44 05 404 , 9121237 , 46010-00QAP , 77 01 207 979	
	3,0 dCi 140		10.2003		24.2123-1759.3	010768	CIL. MAESTRO TANDEM	44 05 404 , 9121237 , 46010-00QAP , 77 01 207 979	
MASTER II Kasten (FD_) (98-06)	1,9 dCi 80		11.2003		24.2123-1759.3	010768	CIL. MAESTRO TANDEM	44 05 404 , 9121237 , 46010-00QAP , 77 01 207 979	
	1,9 dTi		11.2003		24.2123-1759.3	010768	CIL. MAESTRO TANDEM	44 05 404 , 9121237 , 46010-00QAP , 77 01 207 979	
	2,2 dCi 90		11.2003		24.2123-1759.3	010768	CIL. MAESTRO TANDEM	44 05 404 , 9121237 , 46010-00QAP , 77 01 207 979	
	2,5 dCi 100		10.2003		24.2123-1759.3	010768	CIL. MAESTRO TANDEM	44 05 404 , 9121237 , 46010-00QAP , 77 01 207 979	
	2,5 dCi 120		11.2003		24.2123-1759.3	010768	CIL. MAESTRO TANDEM	44 05 404 , 9121237 , 46010-00QAP , 77 01 207 979	
	3,0 dCi 120		06.2005		24.2123-1759.3	010768	CIL. MAESTRO TANDEM	44 05 404 , 9121237 , 46010-00QAP , 77 01 207 979	
	3,0 dCi 140		10.2003		24.2123-1759.3	010768	CIL. MAESTRO TANDEM	44 05 404 , 9121237 , 46010-00QAP , 77 01 207 979	



					Denominación	Ref. OE correspondientes a las referencias ATE		Referencia anterior / varios
--	--	--	--	--	--------------	--	--	------------------------------

RENAULT

MASTER II Kasten (FD_) (98-06)	3,0 dCi 160		06.2005		24.2123-1759.3	010768	CIL. MAESTRO TANDEM	44 05 404 , 9121237 , 46010-00QAP , 77 01 207 979	
MASTER II Pritsche/Fahrgestell (ED/HD/UD_) (98-06)	2,2 dCi 90		11.2003		24.2123-1759.3	010768	CIL. MAESTRO TANDEM	44 05 404 , 9121237 , 46010-00QAP , 77 01 207 979	
	2,5 dCi 100		10.2003		24.2123-1759.3	010768	CIL. MAESTRO TANDEM	44 05 404 , 9121237 , 46010-00QAP , 77 01 207 979	
	2,5 dCi 120		11.2003		24.2123-1759.3	010768	CIL. MAESTRO TANDEM	44 05 404 , 9121237 , 46010-00QAP , 77 01 207 979	
	3,0 dCi 120		06.2005		24.2123-1759.3	010768	CIL. MAESTRO TANDEM	44 05 404 , 9121237 , 46010-00QAP , 77 01 207 979	
	3,0 dCi 140		10.2003		24.2123-1759.3	010768	CIL. MAESTRO TANDEM	44 05 404 , 9121237 , 46010-00QAP , 77 01 207 979	
	3,0 dCi 160		06.2005		24.2123-1759.3	010768	CIL. MAESTRO TANDEM	44 05 404 , 9121237 , 46010-00QAP , 77 01 207 979	



					Denominación	Ref. OE correspondientes a las referencias ATE		Referencia anterior / varios
--	--	--	--	--	--------------	--	--	------------------------------

ROVER

Serie 200 II (RF) (96-00)	211		01.1998	03.2000	24.3219-1743.3	020485	CILINDRO DE RUEDA	43301-ST3-E01 , 43300-ST3-E01 , 58330-25000 , 58380-25000 , SML100090 , SML100080 , GWC901634 , GWC901635	24.3219-1737.3
	214 i		01.1996	03.2000	24.3219-1743.3	020485	CILINDRO DE RUEDA	43301-ST3-E01 , 43300-ST3-E01 , 58330-25000 , 58380-25000 , SML100090 , SML100080 , GWC901634 , GWC901635	24.3219-1737.3
	214 Si		11.1995	03.2000	24.3219-1743.3	020485	CILINDRO DE RUEDA	43301-ST3-E01 , 43300-ST3-E01 , 58330-25000 , 58380-25000 , SML100090 , SML100080 , GWC901634 , GWC901635	24.3219-1737.3
	216 Si		01.1996	03.2000	24.3219-1743.3	020485	CILINDRO DE RUEDA	43301-ST3-E01 , 43300-ST3-E01 , 58330-25000 , 58380-25000 , SML100090 , SML100080 , GWC901634 , GWC901635	24.3219-1737.3
	218 i 16V Vitesse		01.1997	03.2000	24.3219-1743.3	020485	CILINDRO DE RUEDA	43301-ST3-E01 , 43300-ST3-E01 , 58330-25000 , 58380-25000 , SML100090 , SML100080 , GWC901634 , GWC901635	24.3219-1737.3
	220 D		01.1996	03.2000	24.3219-1743.3	020485	CILINDRO DE RUEDA	43301-ST3-E01 , 43300-ST3-E01 , 58330-25000 , 58380-25000 , SML100090 , SML100080 , GWC901634 , GWC901635	24.3219-1737.3
	220 SDi		01.1996	03.2000	24.3219-1743.3	020485	CILINDRO DE RUEDA	43301-ST3-E01 , 43300-ST3-E01 , 58330-25000 , 58380-25000 , SML100090 , SML100080 , GWC901634 , GWC901635	24.3219-1737.3



					Denominación	Ref. OE correspondientes a las referencias ATE	Referencia anterior / varios
--	--	--	--	--	--------------	--	------------------------------

ROVER

Serie 25 (RF) (99-)	1,1 16V		01.2004		24.3219-1743.3	020485	CILINDRO DE RUEDA	43301-ST3-E01 , 43300-ST3-E01 , 58330-25000 , 58380-25000 , SML100090 , SML100080 , GWC901634 , GWC901635	24.3219-1737.3
	1,4 16V		10.1999		24.3219-1743.3	020485	CILINDRO DE RUEDA	43301-ST3-E01 , 43300-ST3-E01 , 58330-25000 , 58380-25000 , SML100090 , SML100080 , GWC901634 , GWC901635	24.3219-1737.3
	1,6 16V		10.1999		24.3219-1743.3	020485	CILINDRO DE RUEDA	43301-ST3-E01 , 43300-ST3-E01 , 58330-25000 , 58380-25000 , SML100090 , SML100080 , GWC901634 , GWC901635	24.3219-1737.3
	1,8 16V		02.2000		24.3219-1743.3	020485	CILINDRO DE RUEDA	43301-ST3-E01 , 43300-ST3-E01 , 58330-25000 , 58380-25000 , SML100090 , SML100080 , GWC901634 , GWC901635	24.3219-1737.3
			10.1999		24.3219-1743.3	020485	CILINDRO DE RUEDA	43301-ST3-E01 , 43300-ST3-E01 , 58330-25000 , 58380-25000 , SML100090 , SML100080 , GWC901634 , GWC901635	24.3219-1737.3
	2,0 iDT		10.1999		24.3219-1743.3	020485	CILINDRO DE RUEDA	43301-ST3-E01 , 43300-ST3-E01 , 58330-25000 , 58380-25000 , SML100090 , SML100080 , GWC901634 , GWC901635	24.3219-1737.3
Serie 400 (RT) (95-00)	414 Si		05.1995	03.2000	24.3219-1743.3	020485	CILINDRO DE RUEDA	43301-ST3-E01 , 43300-ST3-E01 , 58330-25000 , 58380-25000 , SML100090 , SML100080 , GWC901634 , GWC901635	24.3219-1737.3









					Denominación	Ref. OE correspondientes a las referencias ATE		Referencia anterior / varios
--	--	--	--	--	--------------	--	--	------------------------------

ROVER

Serie 400 (RT) (95-00)	416 Si		06.1995	03.2000	24.3219-1743.3	020485	CILINDRO DE RUEDA	43301-ST3-E01 , 43300-ST3-E01 , 58330-25000 , 58380-25000 , SML100090 , SML100080 , GWC901634 , GWC901635	24.3219-1737.3
	420 D		11.1995	03.2000	24.3219-1743.3	020485	CILINDRO DE RUEDA	43301-ST3-E01 , 43300-ST3-E01 , 58330-25000 , 58380-25000 , SML100090 , SML100080 , GWC901634 , GWC901635	24.3219-1737.3
	420 Di		05.1995	03.2000	24.3219-1743.3	020485	CILINDRO DE RUEDA	43301-ST3-E01 , 43300-ST3-E01 , 58330-25000 , 58380-25000 , SML100090 , SML100080 , GWC901634 , GWC901635	24.3219-1737.3
	420 Si		12.1995	03.2000	24.3219-1743.3	020485	CILINDRO DE RUEDA	43301-ST3-E01 , 43300-ST3-E01 , 58330-25000 , 58380-25000 , SML100090 , SML100080 , GWC901634 , GWC901635	24.3219-1737.3
Serie 45 (RT) (00-)	1,4				24.3219-1743.3	020485	CILINDRO DE RUEDA	43301-ST3-E01 , 43300-ST3-E01 , 58330-25000 , 58380-25000 , SML100090 , SML100080 , GWC901634 , GWC901635	24.3219-1737.3
	1,6				24.3219-1743.3	020485	CILINDRO DE RUEDA	43301-ST3-E01 , 43300-ST3-E01 , 58330-25000 , 58380-25000 , SML100090 , SML100080 , GWC901634 , GWC901635	24.3219-1737.3
	1,8				24.3219-1743.3	020485	CILINDRO DE RUEDA	43301-ST3-E01 , 43300-ST3-E01 , 58330-25000 , 58380-25000 , SML100090 , SML100080 , GWC901634 , GWC901635	24.3219-1737.3



					Denominación	Ref. OE correspondientes a las referencias ATE	 Referencia anterior / varios
---	---	---	---	---	---------------------	---	---







ROVER

Serie 45 (RT) (00-)	2,0 iDT				24.3219-1743.3	020485	CILINDRO DE RUEDA	43301-ST3-E01 , 43300-ST3-E01 , 58330-25000 , 58380-25000 , SML100090 , SML100080 , GWC901634 , GWC901635	24.3219-1737.3
	2,0 V6				24.3219-1743.3	020485	CILINDRO DE RUEDA	43301-ST3-E01 , 43300-ST3-E01 , 58330-25000 , 58380-25000 , SML100090 , SML100080 , GWC901634 , GWC901635	24.3219-1737.3

Nuevas referencias en almacén - Por aplicación

09/2007



					Denominación	Ref. OE correspondientes a las referencias ATE	 Referencia anterior / varios
---	---	---	---	---	--------------	--	--

SAAB

Modelo	Motor	DD	DD	DD	24.3571-1726.5	240314	Denominación	Ref. OE correspondientes a las referencias ATE	Referencia anterior / varios
9-3 Cabrióle (YS3D) (98-03)	2,0 i	DD		07.2003	24.3571-1726.5	240314	PINZA DE GARRA	5055421 , 5084702	
		DD	01.1999	07.2003	24.3571-1726.5	240314	PINZA DE GARRA	5055421 , 5084702	
	2,0 SE Turbo	DD		07.2003	24.3571-1726.5	240314	PINZA DE GARRA	5055421 , 5084702	
		DD	01.1999	07.2003	24.3571-1726.5	240314	PINZA DE GARRA	5055421 , 5084702	
	2,0 T	DD		07.2003	24.3571-1726.5	240314	PINZA DE GARRA	5055421 , 5084702	
		DD	01.1999	07.2003	24.3571-1726.5	240314	PINZA DE GARRA	5055421 , 5084702	
		DD	10.1999	07.2003	24.3571-1726.5	240314	PINZA DE GARRA	5055421 , 5084702	
	2,0 Turbo	DD	01.2001	07.2003	24.3571-1726.5	240314	PINZA DE GARRA	5055421 , 5084702	
	2,3 i	DD	01.1999	07.2003	24.3571-1726.5	240314	PINZA DE GARRA	5055421 , 5084702	
		DD	10.1999	07.2003	24.3571-1726.5	240314	PINZA DE GARRA	5055421 , 5084702	
		DD		07.2003	24.3571-1726.5	240314	PINZA DE GARRA	5055421 , 5084702	
9-3 Coupé (YS3D) (98-02)	2	DD		09.2002	24.3571-1726.5	240314	PINZA DE GARRA	5055421 , 5084702	
		DD	01.1999	09.2002	24.3571-1726.5	240314	PINZA DE GARRA	5055421 , 5084702	
		DD	01.2001	09.2002	24.3571-1726.5	240314	PINZA DE GARRA	5055421 , 5084702	
	2,0 Turbo	DD		09.2002	24.3571-1726.5	240314	PINZA DE GARRA	5055421 , 5084702	
		DD	01.1999	09.2002	24.3571-1726.5	240314	PINZA DE GARRA	5055421 , 5084702	
	2,0 Turbo Sport	DD		09.2002	24.3571-1726.5	240314	PINZA DE GARRA	5055421 , 5084702	
		DD	01.1999	09.2002	24.3571-1726.5	240314	PINZA DE GARRA	5055421 , 5084702	
	2,2 TiD	DD		11.2000	24.3571-1726.5	240314	PINZA DE GARRA	5055421 , 5084702	

Nuevas referencias en almacén - Por aplicación

09/2007



					Denominación	Ref. OE correspondientes a las referencias ATE		Referencia anterior / varios
--	--	--	--	--	--------------	--	--	------------------------------





SAAB

9-3 Coupé (YS3D) (98-02)	2,2 TiD	DD	01.1999	11.2000	24.3571-1726.5	240314	PINZA DE GARRA	5055421 , 5084702	
		DD	11.2000	09.2002	24.3571-1726.5	240314	PINZA DE GARRA	5055421 , 5084702	
	2,3	DD	01.1999	09.2002	24.3571-1726.5	240314	PINZA DE GARRA	5055421 , 5084702	
		DD		09.2002	24.3571-1726.5	240314	PINZA DE GARRA	5055421 , 5084702	
	2,3 Viggen	DD	10.1998	09.2002	24.3571-1726.5	240314	PINZA DE GARRA	5055421 , 5084702	
9-3 Berlina (YS3D) (98-02)	2,0 i	DD		09.2002	24.3571-1726.5	240314	PINZA DE GARRA	5055421 , 5084702	
		DD	01.1999	09.2002	24.3571-1726.5	240314	PINZA DE GARRA	5055421 , 5084702	
	2,0 SE Turbo	DD		09.2002	24.3571-1726.5	240314	PINZA DE GARRA	5055421 , 5084702	
		DD	01.1999	09.2002	24.3571-1726.5	240314	PINZA DE GARRA	5055421 , 5084702	
	2,0 Turbo	DD	01.1999	09.2002	24.3571-1726.5	240314	PINZA DE GARRA	5055421 , 5084702	
		DD	10.1999	09.2002	24.3571-1726.5	240314	PINZA DE GARRA	5055421 , 5084702	
		DD		09.2002	24.3571-1726.5	240314	PINZA DE GARRA	5055421 , 5084702	
	2,2 TiD	DD		09.2002	24.3571-1726.5	240314	PINZA DE GARRA	5055421 , 5084702	
		DD	11.2000	09.2002	24.3571-1726.5	240314	PINZA DE GARRA	5055421 , 5084702	
		DD		11.2000	24.3571-1726.5	240314	PINZA DE GARRA	5055421 , 5084702	
		DD	01.1999	11.2000	24.3571-1726.5	240314	PINZA DE GARRA	5055421 , 5084702	
	2,3 i	DD		09.2002	24.3571-1726.5	240314	PINZA DE GARRA	5055421 , 5084702	
		DD	01.1999	09.2002	24.3571-1726.5	240314	PINZA DE GARRA	5055421 , 5084702	
	2,3 Viggen	DD	10.1998	09.2002	24.3571-1726.5	240314	PINZA DE GARRA	5055421 , 5084702	

Nuevas referencias en almacén - Por aplicación

09/2007



				Denominación	Ref. OE correspondientes a las referencias ATE	 Referencia anterior / varios
---	---	--	---	--------------	--	--

SAAB

9-5 Break (YS3E) (98-)	2,0 t	DD		12.2001	24.3571-1726.5	240314	PINZA DE GARRA	5055421 , 5084702	
		DD	01.1999	12.2001	24.3571-1726.5	240314	PINZA DE GARRA	5055421 , 5084702	
	2,3 t	DD		12.2001	24.3571-1726.5	240314	PINZA DE GARRA	5055421 , 5084702	
		DD	01.1999	12.2001	24.3571-1726.5	240314	PINZA DE GARRA	5055421 , 5084702	
		DD	01.2001	12.2001	24.3571-1726.5	240314	PINZA DE GARRA	5055421 , 5084702	
	3,0 t	DD		12.2001	24.3571-1726.5	240314	PINZA DE GARRA	5055421 , 5084702	
		DD	01.1999	12.2001	24.3571-1726.5	240314	PINZA DE GARRA	5055421 , 5084702	
	3,0 TiD	DD	07.2001	12.2001	24.3571-1726.5	240314	PINZA DE GARRA	5055421 , 5084702	
9-5 Berlina (YS3E) (97-)	2,0 t	DD		12.2001	24.3571-1726.5	240314	PINZA DE GARRA	5055421 , 5084702	
		DD	01.1999	12.2001	24.3571-1726.5	240314	PINZA DE GARRA	5055421 , 5084702	
	2,3 t	DD		12.2001	24.3571-1726.5	240314	PINZA DE GARRA	5055421 , 5084702	
		DD	01.1999	12.2001	24.3571-1726.5	240314	PINZA DE GARRA	5055421 , 5084702	
		DD	01.2001	12.2001	24.3571-1726.5	240314	PINZA DE GARRA	5055421 , 5084702	
	3,0 t	DD		12.2001	24.3571-1726.5	240314	PINZA DE GARRA	5055421 , 5084702	
		DD	01.1999	12.2001	24.3571-1726.5	240314	PINZA DE GARRA	5055421 , 5084702	
	3,0 TiD	DD	07.2001	12.2001	24.3571-1726.5	240314	PINZA DE GARRA	5055421 , 5084702	



					Denominación	Ref. OE correspondientes a las referencias ATE	Referencia anterior / varios
--	--	--	--	--	--------------	--	------------------------------







SEAT

ALHAMBRA (7V) (96-)	1,8 T 20V		05.1998		83.7717-0450.3	330807	LATIGUILLO	7335771 , 1001348 , 95VW 2078-AE , 7M0 611 701 D	83.6117-0450.3
	1,9 TDI		03.1996		83.7717-0450.3	330807	LATIGUILLO	7335771 , 1001348 , 95VW 2078-AE , 7M0 611 701 D	83.6117-0450.3
			06.2000		83.7717-0450.3	330807	LATIGUILLO	7335771 , 1001348 , 95VW 2078-AE , 7M0 611 701 D	83.6117-0450.3
			10.1997	05.2000	83.7717-0450.3	330807	LATIGUILLO	7335771 , 1001348 , 95VW 2078-AE , 7M0 611 701 D	83.6117-0450.3
	2,0 i		03.1996		83.7717-0450.3	330807	LATIGUILLO	7335771 , 1001348 , 95VW 2078-AE , 7M0 611 701 D	83.6117-0450.3
AROSA (6H) (97-05)	1,0 i		05.1997	04.2005	83.7852-0377.3	330835	LATIGUILLO	6N0 611 701 B , 3A0 611 701 , 6N0 611 701 , 6N0 611 701 A	83.6252-0377.3
	1,4 i		05.1997	04.2005	83.7852-0377.3	330835	LATIGUILLO	6N0 611 701 B , 3A0 611 701 , 6N0 611 701 , 6N0 611 701 A	83.6252-0377.3
	1,4 i 16V		10.1999	04.2005	83.7852-0377.3	330835	LATIGUILLO	6N0 611 701 B , 3A0 611 701 , 6N0 611 701 , 6N0 611 701 A	83.6252-0377.3
	1,4 TDI		10.1999	04.2005	83.7852-0377.3	330835	LATIGUILLO	6N0 611 701 B , 3A0 611 701 , 6N0 611 701 , 6N0 611 701 A	83.6252-0377.3
	1,7 SDI		11.1997	04.2005	83.7852-0377.3	330835	LATIGUILLO	6N0 611 701 B , 3A0 611 701 , 6N0 611 701 , 6N0 611 701 A	83.6252-0377.3
CORDOBA I (93-99)	1,4 i		11.1993	05.1999	83.7836-0135.3	330816	LATIGUILLO	1H0 611 775	83.6236-0135.3
			11.1993		83.7713-0435.3	330792	LATIGUILLO	1H0 611 701	83.6113-0435.3
	1,6 i		11.1993	05.1999	83.7836-0135.3	330816	LATIGUILLO	1H0 611 775	83.6236-0135.3

Nuevas referencias en almacén - Por aplicación

09/2007



					Denominación	Ref. OE correspondientes a las referencias ATE		Referencia anterior / varios
---	---	---	---	---	--------------	--	---	------------------------------





SEAT

Modelo	Motor	Fecha 1	Fecha 2	Ref. ATE	Ref. OE	Denominación	Ref. OE correspondientes a las referencias ATE	Referencia anterior / varios
CORDOBA I (93-99)	1,6 i	11.1993		83.7713-0435.3	330792	LATIGUILLO	1H0 611 701	83.6113-0435.3
	1,7 SDI	07.1997		83.7713-0435.3	330792	LATIGUILLO	1H0 611 701	83.6113-0435.3
		07.1997	05.1999	83.7836-0135.3	330816	LATIGUILLO	1H0 611 775	83.6236-0135.3
	1,8 i	11.1993		83.7713-0435.3	330792	LATIGUILLO	1H0 611 701	83.6113-0435.3
		11.1993	05.1999	83.7836-0135.3	330816	LATIGUILLO	1H0 611 775	83.6236-0135.3
	1,8 i 16V	02.1994		83.7713-0435.3	330792	LATIGUILLO	1H0 611 701	83.6113-0435.3
	1,9 D	11.1993		83.7713-0435.3	330792	LATIGUILLO	1H0 611 701	83.6113-0435.3
		11.1993	05.1999	83.7836-0135.3	330816	LATIGUILLO	1H0 611 775	83.6236-0135.3
	1,9 SDI	09.1995	05.1999	83.7836-0135.3	330816	LATIGUILLO	1H0 611 775	83.6236-0135.3
		09.1995		83.7713-0435.3	330792	LATIGUILLO	1H0 611 701	83.6113-0435.3
	1,9 TD	11.1993	05.1999	83.7836-0135.3	330816	LATIGUILLO	1H0 611 775	83.6236-0135.3
		11.1993		83.7713-0435.3	330792	LATIGUILLO	1H0 611 701	83.6113-0435.3
	1,9 TDI	07.1996	05.1999	83.7836-0135.3	330816	LATIGUILLO	1H0 611 775	83.6236-0135.3
		07.1996		83.7713-0435.3	330792	LATIGUILLO	1H0 611 701	83.6113-0435.3
		03.1997		83.7713-0435.3	330792	LATIGUILLO	1H0 611 701	83.6113-0435.3
	2,0 i	11.1993		83.7713-0435.3	330792	LATIGUILLO	1H0 611 701	83.6113-0435.3
IBIZA II (93-99)	1,05 i	02.1993	07.1999	83.7836-0135.3	330816	LATIGUILLO	1H0 611 775	83.6236-0135.3
		02.1993		83.7713-0435.3	330792	LATIGUILLO	1H0 611 701	83.6113-0435.3
	1,3 i	02.1993	07.1999	83.7836-0135.3	330816	LATIGUILLO	1H0 611 775	83.6236-0135.3

Nuevas referencias en almacén - Por aplicación

09/2007



				Denominación	Ref. OE correspondientes a las referencias ATE	 Referencia anterior / varios
---	---	--	---	--------------	--	--

SEAT

Modelo	Motor	Fecha inicio	Fecha fin	Ref. ATE	Ref. OE	Denominación	Ref. OE correspondientes a las referencias ATE	Referencia anterior / varios
IBIZA II (93-99)	1,3 i	02.1993		83.7713-0435.3	330792	LATIGUILLO	1H0 611 701	83.6113-0435.3
	1,4 i	09.1993	07.1999	83.7836-0135.3	330816	LATIGUILLO	1H0 611 775	83.6236-0135.3
		09.1993		83.7713-0435.3	330792	LATIGUILLO	1H0 611 701	83.6113-0435.3
	1,6 i	02.1993	07.1999	83.7836-0135.3	330816	LATIGUILLO	1H0 611 775	83.6236-0135.3
		02.1993		83.7713-0435.3	330792	LATIGUILLO	1H0 611 701	83.6113-0435.3
	1,7 SDI	07.1997	07.1999	83.7836-0135.3	330816	LATIGUILLO	1H0 611 775	83.6236-0135.3
		07.1997		83.7713-0435.3	330792	LATIGUILLO	1H0 611 701	83.6113-0435.3
	1,8 i	02.1993	07.1999	83.7836-0135.3	330816	LATIGUILLO	1H0 611 775	83.6236-0135.3
		02.1993		83.7713-0435.3	330792	LATIGUILLO	1H0 611 701	83.6113-0435.3
	1,8 i 16V	02.1994		83.7713-0435.3	330792	LATIGUILLO	1H0 611 701	83.6113-0435.3
	1,9 D	02.1993		83.7713-0435.3	330792	LATIGUILLO	1H0 611 701	83.6113-0435.3
		02.1993	07.1999	83.7836-0135.3	330816	LATIGUILLO	1H0 611 775	83.6236-0135.3
	1,9 SDI	09.1995		83.7713-0435.3	330792	LATIGUILLO	1H0 611 701	83.6113-0435.3
		09.1995	07.1999	83.7836-0135.3	330816	LATIGUILLO	1H0 611 775	83.6236-0135.3
	1,9 TD	02.1993		83.7713-0435.3	330792	LATIGUILLO	1H0 611 701	83.6113-0435.3
		02.1993	07.1999	83.7836-0135.3	330816	LATIGUILLO	1H0 611 775	83.6236-0135.3
	1,9 TDI	03.1997		83.7713-0435.3	330792	LATIGUILLO	1H0 611 701	83.6113-0435.3
		07.1996		83.7713-0435.3	330792	LATIGUILLO	1H0 611 701	83.6113-0435.3
		07.1996	07.1999	83.7836-0135.3	330816	LATIGUILLO	1H0 611 775	83.6236-0135.3



	i				Denominación	Ref. OE correspondientes a las referencias ATE	i Referencia anterior / varios
--	----------	--	--	--	--------------	--	--

SEAT

IBIZA II (93-99)	2,0 i		02.1993		83.7713-0435.3	330792	LATIGUILLO	1H0 611 701	83.6113-0435.3
TOLEDO I (1L) (91-98)	1,6 i	TD	09.1991	09.1998	83.7804-0160.3	330811	LATIGUILLO	481 611 776 , 171 611 775	83.6204-0160.3
	1,8 i	TD	09.1991	09.1998	83.7804-0160.3	330811	LATIGUILLO	481 611 776 , 171 611 775	83.6204-0160.3
	1,9 D	TD	09.1991	09.1998	83.7804-0160.3	330811	LATIGUILLO	481 611 776 , 171 611 775	83.6204-0160.3
	1,9 TD	TD	09.1991	09.1998	83.7804-0160.3	330811	LATIGUILLO	481 611 776 , 171 611 775	83.6204-0160.3
	1,9 TDI	TD	04.1995	09.1998	83.7804-0160.3	330811	LATIGUILLO	481 611 776 , 171 611 775	83.6204-0160.3

SKODA

SUPERB (3U4) (02-)	1,8 i 20V Turbo				24.0325-0171.1	525171	POWER-DISC	4B0 615 301 B	
	1,9 TDI				24.0325-0171.1	525171	POWER-DISC	4B0 615 301 B	
	2,0 i				24.0325-0171.1	525171	POWER-DISC	4B0 615 301 B	



	i				Denominación	Ref. OE correspondientes a las referencias ATE	i Referencia anterior / varios
--	----------	--	--	--	--------------	--	--







TOYOTA

Modelo	Motor	Fecha inicio	Fecha fin	Ref. ATE	Ref. OE	Denominación	Ref. OE correspondientes a las referencias ATE	Referencia anterior / varios
CAMRY (91-96)	2,2 i (SXV10)	06.1991	08.1996	24.0110-0700.1	410700	DISCO DE FRENO	42431-33010	
CAMRY (96-01)	2,2 i 16V (SXV20)	08.1996	11.2001	24.0110-0700.1	410700	DISCO DE FRENO	42431-33010	
	3,0 i V6 (MCV20)	08.1996	11.2001	24.0110-0700.1	410700	DISCO DE FRENO	42431-33010	
LAND CRUISER 100 (98-)	4,2 TDi (HDJ100)	01.1998		24.0132-0148.1	432148	DISCO DE FRENO	43512-60130 , 43512-60170	
	4,7 V8 (UZJ100)	01.1998		24.0132-0148.1	432148	DISCO DE FRENO	43512-60130 , 43512-60170	
LAND CRUISER 120 (03-)	3,0 D-4D	01.2003		24.0118-0709.1	418709	DISCO DE FRENO	42431-60201 , 42431-60200	24.0118-0142.1
		01.2005		24.0118-0709.1	418709	DISCO DE FRENO	42431-60201 , 42431-60200	24.0118-0142.1
	4,0 VVTi	01.2003		24.0118-0709.1	418709	DISCO DE FRENO	42431-60201 , 42431-60200	24.0118-0142.1
LAND CRUISER 90-95 (96-02)	3,0 D-4D (KDJ90/95)	08.2000	08.2002	24.0118-0709.1	418709	DISCO DE FRENO	42431-60201 , 42431-60200	24.0118-0142.1
	3,0 TD (KZJ90/95)	04.1996	07.2000	24.0118-0709.1	418709	DISCO DE FRENO	42431-60201 , 42431-60200	24.0118-0142.1
	3,4 i 24V (VZJ90/95)	04.1996	08.2002	24.0118-0709.1	418709	DISCO DE FRENO	42431-60201 , 42431-60200	24.0118-0142.1

Nuevas referencias en almacén - Por aplicación

09/2007



					Denominación	Ref. OE correspondientes a las referencias ATE		Referencia anterior / varios
---	---	---	---	---	--------------	--	---	------------------------------

VOLKSWAGEN

CORRADO (88-95)	1,8 16V			07.1992	83.7713-0435.3	330792	LATIGUILLO	1H0 611 701	83.6113-0435.3
			04.1989		83.7813-0330.3	330800	LATIGUILLO	535 611 701	83.6213-0330.3
		TD	04.1989	07.1992	83.7804-0160.3	330811	LATIGUILLO	481 611 776 , 171 611 775	83.6204-0160.3
	1,8 G60		10.1988		83.7813-0330.3	330800	LATIGUILLO	535 611 701	83.6213-0330.3
		TD	10.1988	09.1993	83.7804-0160.3	330811	LATIGUILLO	481 611 776 , 171 611 775	83.6204-0160.3
				09.1993	83.7713-0435.3	330792	LATIGUILLO	1H0 611 701	83.6113-0435.3
	2	TD	04.1993	07.1995	83.7804-0160.3	330811	LATIGUILLO	481 611 776 , 171 611 775	83.6204-0160.3
			04.1993	07.1995	83.7713-0435.3	330792	LATIGUILLO	1H0 611 701	83.6113-0435.3
	2,0 16V	TD	08.1991	07.1995	83.7804-0160.3	330811	LATIGUILLO	481 611 776 , 171 611 775	83.6204-0160.3
			08.1991	07.1995	83.7713-0435.3	330792	LATIGUILLO	1H0 611 701	83.6113-0435.3
	2,9 VR6		08.1991	07.1995	83.7836-0135.3	330816	LATIGUILLO	1H0 611 775	83.6236-0135.3
			08.1991	07.1995	83.7713-0435.3	330792	LATIGUILLO	1H0 611 701	83.6113-0435.3
DERBY/POLO Ranchero (77-88)	0,9		01.1977	09.1981	83.7734-0290.3	330809	LATIGUILLO	861 611 707 A , 861 611 707 B , 861 611 707 C	83.6134-0290.3
		TI	01.1977	09.1981	83.7824-0180.3	330812	LATIGUILLO	321 611 775 , 431 611 775 A , 433 611 775 A	83.6224-0180.3
	1	TI	01.1977	12.1988	83.7824-0180.3	330812	LATIGUILLO	321 611 775 , 431 611 775 A , 433 611 775 A	83.6224-0180.3
			01.1977	12.1988	83.7734-0290.3	330809	LATIGUILLO	861 611 707 A , 861 611 707 B , 861 611 707 C	83.6134-0290.3
	1,1		01.1977	12.1988	83.7734-0290.3	330809	LATIGUILLO	861 611 707 A , 861 611 707 B , 861 611 707 C	83.6134-0290.3



					Denominación	Ref. OE correspondientes a las referencias ATE		Referencia anterior / varios
--	--	--	--	--	--------------	--	--	------------------------------

VOLKSWAGEN

DERBY/POLO Ranchero (77-88)	1,1	TI	01.1977	12.1988	83.7824-0180.3	330812	LATIGUILLO	321 611 775 , 431 611 775 A , 433 611 775 A	83.6224-0180.3
	1,3		01.1977	12.1988	83.7734-0290.3	330809	LATIGUILLO	861 611 707 A , 861 611 707 B , 861 611 707 C	83.6134-0290.3
		TI	01.1977	12.1988	83.7824-0180.3	330812	LATIGUILLO	321 611 775 , 431 611 775 A , 433 611 775 A	83.6224-0180.3
	1,3 D		08.1986	12.1988	83.7734-0290.3	330809	LATIGUILLO	861 611 707 A , 861 611 707 B , 861 611 707 C	83.6134-0290.3
		TI	08.1986	12.1988	83.7824-0180.3	330812	LATIGUILLO	321 611 775 , 431 611 775 A , 433 611 775 A	83.6224-0180.3
GOLF I (74-83)	1,1	TD	04.1974	10.1983	83.7804-0160.3	330811	LATIGUILLO	481 611 776 , 171 611 775	83.6204-0160.3
	1,3	TD	08.1979	10.1983	83.7804-0160.3	330811	LATIGUILLO	481 611 776 , 171 611 775	83.6204-0160.3
	1,5	TD	02.1974	10.1983	83.7804-0160.3	330811	LATIGUILLO	481 611 776 , 171 611 775	83.6204-0160.3
	1,5 D	TD	08.1976	07.1980	83.7804-0160.3	330811	LATIGUILLO	481 611 776 , 171 611 775	83.6204-0160.3
	1,6	TD	04.1974	10.1983	83.7804-0160.3	330811	LATIGUILLO	481 611 776 , 171 611 775	83.6204-0160.3
	1,6 D	TD	08.1980	10.1983	83.7804-0160.3	330811	LATIGUILLO	481 611 776 , 171 611 775	83.6204-0160.3
	1,6 GTI	TD	06.1976	07.1982	83.7804-0160.3	330811	LATIGUILLO	481 611 776 , 171 611 775	83.6204-0160.3
	1,6 TD	TD	03.1982	10.1983	83.7804-0160.3	330811	LATIGUILLO	481 611 776 , 171 611 775	83.6204-0160.3
	1,8 GTI	TD	08.1982	10.1983	83.7804-0160.3	330811	LATIGUILLO	481 611 776 , 171 611 775	83.6204-0160.3
GOLF I Cabriole (79-93)	1,1	TI	01.1979	07.1983	83.7824-0180.3	330812	LATIGUILLO	321 611 775 , 431 611 775 A , 433 611 775 A	83.6224-0180.3
	1,5	TI	01.1979	07.1983	83.7824-0180.3	330812	LATIGUILLO	321 611 775 , 431 611 775 A , 433 611 775 A	83.6224-0180.3



					Denominación	Ref. OE correspondientes a las referencias ATE		Referencia anterior / varios
--	--	--	--	--	--------------	--	--	------------------------------

VOLKSWAGEN

GOLF I Cabriolé (79-93)	1,6	TD	08.1983	07.1993	83.7804-0160.3	330811	LATIGUILLO	481 611 776 , 171 611 775	83.6204-0160.3
	1,6 GLI	TI	07.1979	07.1982	83.7824-0180.3	330812	LATIGUILLO	321 611 775 , 431 611 775 A , 433 611 775 A	83.6224-0180.3
	1,8	TD	08.1983	07.1993	83.7804-0160.3	330811	LATIGUILLO	481 611 776 , 171 611 775	83.6204-0160.3
		TI	08.1982	07.1983	83.7824-0180.3	330812	LATIGUILLO	321 611 775 , 431 611 775 A , 433 611 775 A	83.6224-0180.3
GOLF II (84-93)	1	TI	08.1983	07.1988	83.7824-0180.3	330812	LATIGUILLO	321 611 775 , 431 611 775 A , 433 611 775 A	83.6224-0180.3
		TD	08.1988	10.1991	83.7804-0160.3	330811	LATIGUILLO	481 611 776 , 171 611 775	83.6204-0160.3
	1,3	TI	08.1983	07.1988	83.7824-0180.3	330812	LATIGUILLO	321 611 775 , 431 611 775 A , 433 611 775 A	83.6224-0180.3
		TD	08.1988	12.1993	83.7804-0160.3	330811	LATIGUILLO	481 611 776 , 171 611 775	83.6204-0160.3
	1,6	TI	08.1983	07.1988	83.7824-0180.3	330812	LATIGUILLO	321 611 775 , 431 611 775 A , 433 611 775 A	83.6224-0180.3
		TD	08.1988	12.1993	83.7804-0160.3	330811	LATIGUILLO	481 611 776 , 171 611 775	83.6204-0160.3
	1,6 D	TD	08.1988	07.1992	83.7804-0160.3	330811	LATIGUILLO	481 611 776 , 171 611 775	83.6204-0160.3
		TI	08.1983	07.1988	83.7824-0180.3	330812	LATIGUILLO	321 611 775 , 431 611 775 A , 433 611 775 A	83.6224-0180.3
	1,6 TD	TI	08.1983	07.1988	83.7824-0180.3	330812	LATIGUILLO	321 611 775 , 431 611 775 A , 433 611 775 A	83.6224-0180.3
		TD	08.1988	12.1993	83.7804-0160.3	330811	LATIGUILLO	481 611 776 , 171 611 775	83.6204-0160.3
	1,8	TD	08.1988	07.1992	83.7804-0160.3	330811	LATIGUILLO	481 611 776 , 171 611 775	83.6204-0160.3
		TI	01.1984	07.1988	83.7824-0180.3	330812	LATIGUILLO	321 611 775 , 431 611 775 A , 433 611 775 A	83.6224-0180.3

Nuevas referencias en almacén - Por aplicación

09/2007



					Denominación	Ref. OE correspondientes a las referencias ATE		Referencia anterior / varios
--	--	--	--	--	--------------	--	--	------------------------------

VOLKSWAGEN

GOLF II (84-93)	1,8 G 60		04.1990	07.1992	83.7813-0330.3	330800	LATIGUILLO	535 611 701	83.6213-0330.3
	1,8 Rallye		04.1989	07.1992	83.7813-0330.3	330800	LATIGUILLO	535 611 701	83.6213-0330.3
		TI	04.1989	07.1992	83.7824-0180.3	330812	LATIGUILLO	321 611 775 , 431 611 775 A , 433 611 775 A	83.6224-0180.3
	1,8 Syncro	TD	08.1985	07.1992	83.7804-0160.3	330811	LATIGUILLO	481 611 776 , 171 611 775	83.6204-0160.3
	1,8 Syncro G 60	TI	04.1989	07.1992	83.7824-0180.3	330812	LATIGUILLO	321 611 775 , 431 611 775 A , 433 611 775 A	83.6224-0180.3
			04.1989	07.1992	83.7813-0330.3	330800	LATIGUILLO	535 611 701	83.6213-0330.3
GOLF III (92-97)	1,4		11.1991	08.1997	83.7713-0435.3	330792	LATIGUILLO	1H0 611 701	83.6113-0435.3
			11.1991	08.1997	83.7836-0135.3	330816	LATIGUILLO	1H0 611 775	83.6236-0135.3
	1,6		09.1992	08.1997	83.7713-0435.3	330792	LATIGUILLO	1H0 611 701	83.6113-0435.3
			09.1992	08.1997	83.7836-0135.3	330816	LATIGUILLO	1H0 611 775	83.6236-0135.3
	1,6 GT		07.1994	08.1997	83.7836-0135.3	330816	LATIGUILLO	1H0 611 775	83.6236-0135.3
	1,8		11.1991	08.1997	83.7713-0435.3	330792	LATIGUILLO	1H0 611 701	83.6113-0435.3
			11.1991	08.1997	83.7836-0135.3	330816	LATIGUILLO	1H0 611 775	83.6236-0135.3
	1,8 GT		11.1991	08.1997	83.7836-0135.3	330816	LATIGUILLO	1H0 611 775	83.6236-0135.3
	1,8 Syncro		01.1993	08.1997	83.7713-0435.3	330792	LATIGUILLO	1H0 611 701	83.6113-0435.3
			01.1993	08.1997	83.7836-0135.3	330816	LATIGUILLO	1H0 611 775	83.6236-0135.3
	1,9 D		11.1991	08.1997	83.7836-0135.3	330816	LATIGUILLO	1H0 611 775	83.6236-0135.3
			11.1991	08.1997	83.7713-0435.3	330792	LATIGUILLO	1H0 611 701	83.6113-0435.3

Nuevas referencias en almacén - Por aplicación

09/2007



					Denominación	Ref. OE correspondientes a las referencias ATE		Referencia anterior / varios
--	--	--	--	--	--------------	--	--	------------------------------

VOLKSWAGEN

GOLF III (92-97)	1,9 D Ecomatic		08.1993	07.1995	83.7713-0435.3	330792	LATIGUILLO	1H0 611 701	83.6113-0435.3
			08.1993	07.1995	83.7836-0135.3	330816	LATIGUILLO	1H0 611 775	83.6236-0135.3
	1,9 SDI		07.1995	08.1997	83.7713-0435.3	330792	LATIGUILLO	1H0 611 701	83.6113-0435.3
			07.1995	08.1997	83.7836-0135.3	330816	LATIGUILLO	1H0 611 775	83.6236-0135.3
	1,9 TD		11.1991	08.1997	83.7713-0435.3	330792	LATIGUILLO	1H0 611 701	83.6113-0435.3
			11.1991	08.1997	83.7836-0135.3	330816	LATIGUILLO	1H0 611 775	83.6236-0135.3
	1,9 TDI		10.1993	08.1997	83.7713-0435.3	330792	LATIGUILLO	1H0 611 701	83.6113-0435.3
			02.1996	08.1997	83.7713-0435.3	330792	LATIGUILLO	1H0 611 701	83.6113-0435.3
			02.1996	08.1997	83.7836-0135.3	330816	LATIGUILLO	1H0 611 775	83.6236-0135.3
			10.1993	08.1997	83.7836-0135.3	330816	LATIGUILLO	1H0 611 775	83.6236-0135.3
	1,9 TDI Syncro		03.1995	08.1997	83.7836-0135.3	330816	LATIGUILLO	1H0 611 775	83.6236-0135.3
			03.1995	08.1997	83.7713-0435.3	330792	LATIGUILLO	1H0 611 701	83.6113-0435.3
	2		11.1991	08.1997	83.7713-0435.3	330792	LATIGUILLO	1H0 611 701	83.6113-0435.3
			11.1991	08.1997	83.7836-0135.3	330816	LATIGUILLO	1H0 611 775	83.6236-0135.3
	2,0 GTI		11.1991	08.1997	83.7836-0135.3	330816	LATIGUILLO	1H0 611 775	83.6236-0135.3
	2,0 GTI 16V		08.1992	08.1997	83.7836-0135.3	330816	LATIGUILLO	1H0 611 775	83.6236-0135.3
	2,0 Syncro		07.1995	08.1997	83.7836-0135.3	330816	LATIGUILLO	1H0 611 775	83.6236-0135.3
			07.1995	08.1997	83.7713-0435.3	330792	LATIGUILLO	1H0 611 701	83.6113-0435.3
	2,8 VR6		01.1992	08.1997	83.7836-0135.3	330816	LATIGUILLO	1H0 611 775	83.6236-0135.3

Nuevas referencias en almacén - Por aplicación

09/2007



					Denominación	Ref. OE correspondientes a las referencias ATE		Referencia anterior / varios
--	--	--	--	--	--------------	--	--	------------------------------

VOLKSWAGEN

Modelo	Motor	Desde	Hasta	Ref. ATE	Ref. OE	Denominación	Ref. OE correspondientes a las referencias ATE	Referencia anterior / varios
GOLF III (92-97)	2,8 VR6	01.1992	02.1995	83.7713-0435.3	330792	LATIGUILLO	1H0 611 701	83.6113-0435.3
	2,9 VR6 Syncro	10.1994	08.1997	83.7836-0135.3	330816	LATIGUILLO	1H0 611 775	83.6236-0135.3
GOLF III Cabrióle (94-)	1,6	10.1994	02.2002	83.7836-0135.3	330816	LATIGUILLO	1H0 611 775	83.6236-0135.3
		10.1994	02.2002	83.7713-0435.3	330792	LATIGUILLO	1H0 611 701	83.6113-0435.3
	1,8	09.1993	02.2002	83.7713-0435.3	330792	LATIGUILLO	1H0 611 701	83.6113-0435.3
		09.1993	02.2002	83.7836-0135.3	330816	LATIGUILLO	1H0 611 775	83.6236-0135.3
	1,9 TDI	09.1996		83.7836-0135.3	330816	LATIGUILLO	1H0 611 775	83.6236-0135.3
			02.2002	83.7836-0135.3	330816	LATIGUILLO	1H0 611 775	83.6236-0135.3
		08.1995	02.2002	83.7836-0135.3	330816	LATIGUILLO	1H0 611 775	83.6236-0135.3
		08.1995	02.2002	83.7713-0435.3	330792	LATIGUILLO	1H0 611 701	83.6113-0435.3
		09.1996	02.2002	83.7713-0435.3	330792	LATIGUILLO	1H0 611 701	83.6113-0435.3
	2		02.2002	83.7836-0135.3	330816	LATIGUILLO	1H0 611 775	83.6236-0135.3
		09.1993		83.7836-0135.3	330816	LATIGUILLO	1H0 611 775	83.6236-0135.3
		09.1993	02.2002	83.7713-0435.3	330792	LATIGUILLO	1H0 611 701	83.6113-0435.3
GOLF III Variant (93-99)	1,4	07.1993	04.1999	83.7713-0435.3	330792	LATIGUILLO	1H0 611 701	83.6113-0435.3
		07.1993	04.1999	83.7836-0135.3	330816	LATIGUILLO	1H0 611 775	83.6236-0135.3
	1,6	07.1994	04.1999	83.7713-0435.3	330792	LATIGUILLO	1H0 611 701	83.6113-0435.3
		07.1994	04.1999	83.7836-0135.3	330816	LATIGUILLO	1H0 611 775	83.6236-0135.3
	1,8	07.1993	04.1999	83.7713-0435.3	330792	LATIGUILLO	1H0 611 701	83.6113-0435.3

Nuevas referencias en almacén - Por aplicación

09/2007



					Denominación	Ref. OE correspondientes a las referencias ATE		Referencia anterior / varios
--	--	--	--	--	--------------	--	--	------------------------------

VOLKSWAGEN

GOLF III Variant (93-99)	1,8		07.1993	04.1999	83.7836-0135.3	330816	LATIGUILLO	1H0 611 775	83.6236-0135.3
	1,8 Syncro		07.1994	04.1999	83.7713-0435.3	330792	LATIGUILLO	1H0 611 701	83.6113-0435.3
			07.1994	04.1999	83.7836-0135.3	330816	LATIGUILLO	1H0 611 775	83.6236-0135.3
	1,9 D		07.1993	04.1999	83.7713-0435.3	330792	LATIGUILLO	1H0 611 701	83.6113-0435.3
			07.1993	04.1999	83.7836-0135.3	330816	LATIGUILLO	1H0 611 775	83.6236-0135.3
	1,9 SDI		07.1995	04.1999	83.7713-0435.3	330792	LATIGUILLO	1H0 611 701	83.6113-0435.3
			07.1995	04.1999	83.7836-0135.3	330816	LATIGUILLO	1H0 611 775	83.6236-0135.3
	1,9 TD		07.1993	04.1999	83.7713-0435.3	330792	LATIGUILLO	1H0 611 701	83.6113-0435.3
			07.1993	04.1999	83.7836-0135.3	330816	LATIGUILLO	1H0 611 775	83.6236-0135.3
	1,9 TDI		02.1996	04.1999	83.7713-0435.3	330792	LATIGUILLO	1H0 611 701	83.6113-0435.3
			07.1993	04.1999	83.7713-0435.3	330792	LATIGUILLO	1H0 611 701	83.6113-0435.3
			02.1996	04.1999	83.7836-0135.3	330816	LATIGUILLO	1H0 611 775	83.6236-0135.3
			07.1993	04.1999	83.7836-0135.3	330816	LATIGUILLO	1H0 611 775	83.6236-0135.3
	1,9 TDI Syncro		07.1995	04.1999	83.7836-0135.3	330816	LATIGUILLO	1H0 611 775	83.6236-0135.3
			07.1995	04.1999	83.7713-0435.3	330792	LATIGUILLO	1H0 611 701	83.6113-0435.3
	2		07.1993	04.1999	83.7713-0435.3	330792	LATIGUILLO	1H0 611 701	83.6113-0435.3
			07.1993	04.1999	83.7836-0135.3	330816	LATIGUILLO	1H0 611 775	83.6236-0135.3
	2,0 Syncro		07.1995	04.1999	83.7836-0135.3	330816	LATIGUILLO	1H0 611 775	83.6236-0135.3
			07.1995	04.1999	83.7713-0435.3	330792	LATIGUILLO	1H0 611 701	83.6113-0435.3

Nuevas referencias en almacén - Por aplicación

09/2007



					Denominación	Ref. OE correspondientes a las referencias ATE		Referencia anterior / varios
--	--	--	--	--	--------------	--	--	------------------------------

VOLKSWAGEN

GOLF III Variant (93-99)	2,9 VR6 Syncro		07.1995	04.1999	83.7836-0135.3	330816	LATIGUILLO	1H0 611 775	83.6236-0135.3
JETTA I (79-83)	1,1	TD	08.1979	07.1983	83.7804-0160.3	330811	LATIGUILLO	481 611 776 , 171 611 775	83.6204-0160.3
	1,3	TD	08.1979	07.1983	83.7804-0160.3	330811	LATIGUILLO	481 611 776 , 171 611 775	83.6204-0160.3
	1,5	TD	08.1979	07.1983	83.7804-0160.3	330811	LATIGUILLO	481 611 776 , 171 611 775	83.6204-0160.3
	1,6	TD	08.1980	07.1983	83.7804-0160.3	330811	LATIGUILLO	481 611 776 , 171 611 775	83.6204-0160.3
	1,6 D	TD	08.1980	07.1983	83.7804-0160.3	330811	LATIGUILLO	481 611 776 , 171 611 775	83.6204-0160.3
	1,6 i	TD	08.1979	07.1982	83.7804-0160.3	330811	LATIGUILLO	481 611 776 , 171 611 775	83.6204-0160.3
	1,6 TD	TD	03.1982	07.1983	83.7804-0160.3	330811	LATIGUILLO	481 611 776 , 171 611 775	83.6204-0160.3
	1,7	TD	08.1980	07.1983	83.7804-0160.3	330811	LATIGUILLO	481 611 776 , 171 611 775	83.6204-0160.3
	1,8	TD	08.1982	07.1983	83.7804-0160.3	330811	LATIGUILLO	481 611 776 , 171 611 775	83.6204-0160.3
JETTA II (84-92)	1,3	TD	08.1988	07.1992	83.7804-0160.3	330811	LATIGUILLO	481 611 776 , 171 611 775	83.6204-0160.3
		TD	08.1983	07.1988	83.7804-0160.3	330811	LATIGUILLO	481 611 776 , 171 611 775	83.6204-0160.3
		TI	08.1983	07.1988	83.7824-0180.3	330812	LATIGUILLO	321 611 775 , 431 611 775 A , 433 611 775 A	83.6224-0180.3
	1,6	TD	01.1984	07.1988	83.7804-0160.3	330811	LATIGUILLO	481 611 776 , 171 611 775	83.6204-0160.3
		TD	08.1988	07.1992	83.7804-0160.3	330811	LATIGUILLO	481 611 776 , 171 611 775	83.6204-0160.3
		TI	01.1984	07.1988	83.7824-0180.3	330812	LATIGUILLO	321 611 775 , 431 611 775 A , 433 611 775 A	83.6224-0180.3
	1,6 D	TD	01.1984	07.1988	83.7804-0160.3	330811	LATIGUILLO	481 611 776 , 171 611 775	83.6204-0160.3
		TD	08.1988	07.1992	83.7804-0160.3	330811	LATIGUILLO	481 611 776 , 171 611 775	83.6204-0160.3



					Denominación	Ref. OE correspondientes a las referencias ATE	Referencia anterior / varios
--	--	--	--	--	--------------	--	------------------------------

VOLKSWAGEN

JETTA II (84-92)	1,6 D	TI	01.1984	07.1988	83.7824-0180.3	330812	LATIGUILLO	321 611 775 , 431 611 775 A , 433 611 775 A	83.6224-0180.3
	1,6 TD	TD	01.1984	07.1988	83.7804-0160.3	330811	LATIGUILLO	481 611 776 , 171 611 775	83.6204-0160.3
		TD	08.1988	07.1992	83.7804-0160.3	330811	LATIGUILLO	481 611 776 , 171 611 775	83.6204-0160.3
		TI	01.1984	07.1988	83.7824-0180.3	330812	LATIGUILLO	321 611 775 , 431 611 775 A , 433 611 775 A	83.6224-0180.3
	1,8	TI	08.1986	07.1988	83.7824-0180.3	330812	LATIGUILLO	321 611 775 , 431 611 775 A , 433 611 775 A	83.6224-0180.3
		TI	08.1984	07.1988	83.7824-0180.3	330812	LATIGUILLO	321 611 775 , 431 611 775 A , 433 611 775 A	83.6224-0180.3
		TD	08.1988	07.1992	83.7804-0160.3	330811	LATIGUILLO	481 611 776 , 171 611 775	83.6204-0160.3
		TD	08.1984	07.1988	83.7804-0160.3	330811	LATIGUILLO	481 611 776 , 171 611 775	83.6204-0160.3
		TD	08.1986	07.1988	83.7804-0160.3	330811	LATIGUILLO	481 611 776 , 171 611 775	83.6204-0160.3
	1,8 Syncro	TD	08.1987	07.1992	83.7804-0160.3	330811	LATIGUILLO	481 611 776 , 171 611 775	83.6204-0160.3
ESCARABAJO (TIPO 1) (49-03)	1200		01.1967	12.1985	83.7701-0350.3	330840	LATIGUILLO	113 611 701 D , 644 42 311	83.6101-0350.3
	1300		08.1966	07.1967	83.7701-0350.3	330840	LATIGUILLO	113 611 701 D , 644 42 311	83.6101-0350.3
	1500		08.1967	12.1970	83.7701-0350.3	330840	LATIGUILLO	113 611 701 D , 644 42 311	83.6101-0350.3
LT/- 4x4 (75-96)	LT 40		08.1978	07.1996	83.7834-0440.3	330813	LATIGUILLO	291 611 775 , 251 611 775 B	83.6234-0440.3
	LT 45		08.1978	07.1996	83.7834-0440.3	330813	LATIGUILLO	291 611 775 , 251 611 775 B	83.6234-0440.3
	LT 50		12.1982	07.1996	83.7834-0440.3	330813	LATIGUILLO	291 611 775 , 251 611 775 B	83.6234-0440.3
	LT 55		08.1985	07.1996	83.7834-0440.3	330813	LATIGUILLO	291 611 775 , 251 611 775 B	83.6234-0440.3









					Denominación	Ref. OE correspondientes a las referencias ATE		Referencia anterior / varios
--	--	--	--	--	--------------	--	--	------------------------------

VOLKSWAGEN

LT/- 4x4 (96-)	LT 46	TD	05.1996		24.3441-1702.5	240332	PINZA DE GARRA	2D0 615 106 B , 902 420 12 01 , 904 420 09 01	
		TD	05.1996		24.3441-1702.5	240332	PINZA DE GARRA	2D0 615 106 B , 902 420 12 01 , 904 420 09 01	
LUPO (98-05)	1		04.1998	08.2005	83.7852-0377.3	330835	LATIGUILLO	6N0 611 701 B , 3A0 611 701 , 6N0 611 701 , 6N0 611 701 A	83.6252-0377.3
	1,4		09.2000	08.2005	83.7852-0377.3	330835	LATIGUILLO	6N0 611 701 B , 3A0 611 701 , 6N0 611 701 , 6N0 611 701 A	83.6252-0377.3
	1,4 16V		01.1999	08.2005	83.7852-0377.3	330835	LATIGUILLO	6N0 611 701 B , 3A0 611 701 , 6N0 611 701 , 6N0 611 701 A	83.6252-0377.3
			10.1998	08.2005	83.7852-0377.3	330835	LATIGUILLO	6N0 611 701 B , 3A0 611 701 , 6N0 611 701 , 6N0 611 701 A	83.6252-0377.3
	1,4 TDI		01.1999	08.2005	83.7852-0377.3	330835	LATIGUILLO	6N0 611 701 B , 3A0 611 701 , 6N0 611 701 , 6N0 611 701 A	83.6252-0377.3
	1,7 SDI		04.1998	08.2005	83.7852-0377.3	330835	LATIGUILLO	6N0 611 701 B , 3A0 611 701 , 6N0 611 701 , 6N0 611 701 A	83.6252-0377.3
PASSAT (88-93)	1,6	TI	04.1988	10.1993	83.7824-0180.3	330812	LATIGUILLO	321 611 775 , 431 611 775 A , 433 611 775 A	83.6224-0180.3
			04.1988	10.1993	83.7813-0330.3	330800	LATIGUILLO	535 611 701	83.6213-0330.3
	1,6 TD	TI	08.1988	10.1993	83.7824-0180.3	330812	LATIGUILLO	321 611 775 , 431 611 775 A , 433 611 775 A	83.6224-0180.3
			08.1988	10.1993	83.7813-0330.3	330800	LATIGUILLO	535 611 701	83.6213-0330.3









					Denominación	Ref. OE correspondientes a las referencias ATE	 Referencia anterior / varios
---	---	---	---	---	--------------	--	--

VOLKSWAGEN

PASSAT (88-93)	1,8	TI	04.1988	10.1993	83.7824-0180.3	330812	LATIGUILLO	321 611 775 , 431 611 775 A , 433 611 775 A	83.6224-0180.3
		TI	04.1988	07.1990	83.7824-0180.3	330812	LATIGUILLO	321 611 775 , 431 611 775 A , 433 611 775 A	83.6224-0180.3
			04.1988	10.1993	83.7813-0330.3	330800	LATIGUILLO	535 611 701	83.6213-0330.3
	1,8 16V		04.1988	07.1992	83.7813-0330.3	330800	LATIGUILLO	535 611 701	83.6213-0330.3
	1,8 Syncro G60	TD	08.1988	10.1993	83.7804-0160.3	330811	LATIGUILLO	481 611 776 , 171 611 775	83.6204-0160.3
			08.1988	10.1993	83.7813-0330.3	330800	LATIGUILLO	535 611 701	83.6213-0330.3
	1,9 D	TI	05.1989	10.1993	83.7824-0180.3	330812	LATIGUILLO	321 611 775 , 431 611 775 A , 433 611 775 A	83.6224-0180.3
			05.1989	10.1993	83.7813-0330.3	330800	LATIGUILLO	535 611 701	83.6213-0330.3
	1,9 TD		03.1991	10.1993	83.7813-0330.3	330800	LATIGUILLO	535 611 701	83.6213-0330.3
		TI	03.1991	10.1993	83.7824-0180.3	330812	LATIGUILLO	321 611 775 , 431 611 775 A , 433 611 775 A	83.6224-0180.3
	2	TI	03.1990	10.1993	83.7824-0180.3	330812	LATIGUILLO	321 611 775 , 431 611 775 A , 433 611 775 A	83.6224-0180.3
			03.1990	10.1993	83.7813-0330.3	330800	LATIGUILLO	535 611 701	83.6213-0330.3
	2,0 16V	TI	08.1988	10.1993	83.7824-0180.3	330812	LATIGUILLO	321 611 775 , 431 611 775 A , 433 611 775 A	83.6224-0180.3
			08.1988	10.1993	83.7813-0330.3	330800	LATIGUILLO	535 611 701	83.6213-0330.3
	2,0 Syncro		10.1990	10.1993	83.7813-0330.3	330800	LATIGUILLO	535 611 701	83.6213-0330.3
		TD	10.1990	10.1993	83.7804-0160.3	330811	LATIGUILLO	481 611 776 , 171 611 775	83.6204-0160.3



					Denominación	Ref. OE correspondientes a las referencias ATE		Referencia anterior / varios
---	---	---	---	---	--------------	--	---	------------------------------

VOLKSWAGEN

PASSAT (88-93)	2,8 VR6	TI	06.1991	10.1993	83.7824-0180.3	330812	LATIGUILLO	321 611 775 , 431 611 775 A , 433 611 775 A	83.6224-0180.3
			06.1991	10.1993	83.7813-0330.3	330800	LATIGUILLO	535 611 701	83.6213-0330.3
PASSAT (94-96)	1,6	TD	10.1994	12.1996	83.7804-0160.3	330811	LATIGUILLO	481 611 776 , 171 611 775	83.6204-0160.3
			10.1994	12.1996	83.7813-0330.3	330800	LATIGUILLO	535 611 701	83.6213-0330.3
	1,8	TD	10.1993	12.1996	83.7804-0160.3	330811	LATIGUILLO	481 611 776 , 171 611 775	83.6204-0160.3
			10.1993	12.1996	83.7813-0330.3	330800	LATIGUILLO	535 611 701	83.6213-0330.3
	1,9 TD		10.1993	12.1996	83.7813-0330.3	330800	LATIGUILLO	535 611 701	83.6213-0330.3
		TD	10.1993	12.1996	83.7804-0160.3	330811	LATIGUILLO	481 611 776 , 171 611 775	83.6204-0160.3
	1,9 TDI	TD	10.1993		83.7804-0160.3	330811	LATIGUILLO	481 611 776 , 171 611 775	83.6204-0160.3
		TD		12.1996	83.7804-0160.3	330811	LATIGUILLO	481 611 776 , 171 611 775	83.6204-0160.3
		TD	03.1996	12.1996	83.7804-0160.3	330811	LATIGUILLO	481 611 776 , 171 611 775	83.6204-0160.3
			10.1993	12.1996	83.7813-0330.3	330800	LATIGUILLO	535 611 701	83.6213-0330.3
	2	TD	10.1993	12.1996	83.7804-0160.3	330811	LATIGUILLO	481 611 776 , 171 611 775	83.6204-0160.3
			10.1993	12.1996	83.7813-0330.3	330800	LATIGUILLO	535 611 701	83.6213-0330.3
	2,0 16V	TD	01.1994	12.1996	83.7804-0160.3	330811	LATIGUILLO	481 611 776 , 171 611 775	83.6204-0160.3
			01.1994	12.1996	83.7852-0377.3	330835	LATIGUILLO	6N0 611 701 B , 3A0 611 701 , 6N0 611 701 , 6N0 611 701 A	83.6252-0377.3
	2,0 Syncro	TD	01.1994	12.1996	83.7804-0160.3	330811	LATIGUILLO	481 611 776 , 171 611 775	83.6204-0160.3
			01.1994	12.1996	83.7813-0330.3	330800	LATIGUILLO	535 611 701	83.6213-0330.3



					Denominación	Ref. OE correspondientes a las referencias ATE		Referencia anterior / varios
--	--	--	--	--	--------------	--	--	------------------------------

VOLKSWAGEN

PASSAT (94-96)	2,8 VR6	TD	10.1993	12.1996	83.7804-0160.3	330811	LATIGUILLO	481 611 776 , 171 611 775	83.6204-0160.3
			10.1993	12.1996	83.7852-0377.3	330835	LATIGUILLO	6N0 611 701 B , 3A0 611 701 , 6N0 611 701 , 6N0 611 701 A	83.6252-0377.3
	2,9 VR6 Syncro		10.1994	12.1996	83.7852-0377.3	330835	LATIGUILLO	6N0 611 701 B , 3A0 611 701 , 6N0 611 701 , 6N0 611 701 A	83.6252-0377.3
		TD	10.1994	12.1996	83.7804-0160.3	330811	LATIGUILLO	481 611 776 , 171 611 775	83.6204-0160.3
PASSAT (97-05)	1,6		10.2000	06.2005	24.0325-0171.1	525171	POWER-DISC	4B0 615 301 B	
	1,8 T			06.2005	24.0325-0171.1	525171	POWER-DISC	4B0 615 301 B	
	1,9 TDI		10.2000	06.2005	24.0325-0171.1	525171	POWER-DISC	4B0 615 301 B	
				06.2005	24.0325-0171.1	525171	POWER-DISC	4B0 615 301 B	
	1,9 TDI 4motion		10.2000	06.2005	24.0325-0171.1	525171	POWER-DISC	4B0 615 301 B	
				06.2005	24.0325-0171.1	525171	POWER-DISC	4B0 615 301 B	
	2		05.2002	06.2005	24.0325-0171.1	525171	POWER-DISC	4B0 615 301 B	
			10.2000	06.2005	24.0325-0171.1	525171	POWER-DISC	4B0 615 301 B	
	2,0 4motion		10.2000	06.2005	24.0325-0171.1	525171	POWER-DISC	4B0 615 301 B	
	2,0 TDI		12.2003	06.2005	24.0325-0171.1	525171	POWER-DISC	4B0 615 301 B	
	2,3			09.2000	24.0325-0171.1	525171	POWER-DISC	4B0 615 301 B	
	2,3 4motion			09.2000	24.0325-0171.1	525171	POWER-DISC	4B0 615 301 B	
	2,5 TDI		08.1998	09.2000	24.0325-0171.1	525171	POWER-DISC	4B0 615 301 B	
	2,5 TDI 4motion		08.1998	09.2000	24.0325-0171.1	525171	POWER-DISC	4B0 615 301 B	



				Denominación	Ref. OE correspondientes a las referencias ATE		Referencia anterior / varios
--	--	--	--	--------------	--	--	------------------------------

VOLKSWAGEN

PASSAT (97-05)	2,8			06.2005	24.0325-0171.1	525171	POWER-DISC	4B0 615 301 B	
PASSAT Berlina (85-88)	1,3	TD	08.1984	07.1986	83.7804-0160.3	330811	LATIGUILLO	481 611 776 , 171 611 775	83.6204-0160.3
	1,6	TD	08.1984	03.1988	83.7804-0160.3	330811	LATIGUILLO	481 611 776 , 171 611 775	83.6204-0160.3
		TI	08.1984	03.1988	83.7824-0180.3	330812	LATIGUILLO	321 611 775 , 431 611 775 A , 433 611 775 A	83.6224-0180.3
	1,6 D	TD	08.1984	03.1988	83.7804-0160.3	330811	LATIGUILLO	481 611 776 , 171 611 775	83.6204-0160.3
		TI	08.1984	03.1988	83.7824-0180.3	330812	LATIGUILLO	321 611 775 , 431 611 775 A , 433 611 775 A	83.6224-0180.3
	1,6 TD	TI	08.1984	03.1988	83.7824-0180.3	330812	LATIGUILLO	321 611 775 , 431 611 775 A , 433 611 775 A	83.6224-0180.3
		TD	08.1984	03.1988	83.7804-0160.3	330811	LATIGUILLO	481 611 776 , 171 611 775	83.6204-0160.3
	1,8	TI	08.1984	03.1988	83.7824-0180.3	330812	LATIGUILLO	321 611 775 , 431 611 775 A , 433 611 775 A	83.6224-0180.3
		TD	08.1984	03.1988	83.7804-0160.3	330811	LATIGUILLO	481 611 776 , 171 611 775	83.6204-0160.3
	2	TD	08.1984	03.1988	83.7804-0160.3	330811	LATIGUILLO	481 611 776 , 171 611 775	83.6204-0160.3
		TI	08.1984	03.1988	83.7824-0180.3	330812	LATIGUILLO	321 611 775 , 431 611 775 A , 433 611 775 A	83.6224-0180.3
	2,2	TI	08.1985	03.1988	83.7824-0180.3	330812	LATIGUILLO	321 611 775 , 431 611 775 A , 433 611 775 A	83.6224-0180.3
		TD	08.1985	03.1988	83.7804-0160.3	330811	LATIGUILLO	481 611 776 , 171 611 775	83.6204-0160.3
PASSAT Variant (73-84)	1,3	TI	05.1973	07.1980	83.7824-0180.3	330812	LATIGUILLO	321 611 775 , 431 611 775 A , 433 611 775 A	83.6224-0180.3
		TI	08.1980	07.1984	83.7824-0180.3	330812	LATIGUILLO	321 611 775 , 431 611 775 A , 433 611 775 A	83.6224-0180.3



					Denominación	Ref. OE correspondientes a las referencias ATE		Referencia anterior / varios
--	--	--	--	--	--------------	--	--	------------------------------

VOLKSWAGEN

PASSAT Variant (73-84)	1,3	TD	08.1980	07.1984	83.7804-0160.3	330811	LATIGUILLO	481 611 776 , 171 611 775	83.6204-0160.3
	1,5	TI	05.1973	08.1975	83.7824-0180.3	330812	LATIGUILLO	321 611 775 , 431 611 775 A , 433 611 775 A	83.6224-0180.3
	1,5 D	TI	08.1977	07.1980	83.7824-0180.3	330812	LATIGUILLO	321 611 775 , 431 611 775 A , 433 611 775 A	83.6224-0180.3
	1,6	TI	08.1980	07.1984	83.7824-0180.3	330812	LATIGUILLO	321 611 775 , 431 611 775 A , 433 611 775 A	83.6224-0180.3
		TD	08.1980	07.1984	83.7804-0160.3	330811	LATIGUILLO	481 611 776 , 171 611 775	83.6204-0160.3
		TI	09.1975	07.1980	83.7824-0180.3	330812	LATIGUILLO	321 611 775 , 431 611 775 A , 433 611 775 A	83.6224-0180.3
	1,6 D	TI	02.1979	07.1984	83.7824-0180.3	330812	LATIGUILLO	321 611 775 , 431 611 775 A , 433 611 775 A	83.6224-0180.3
		TD	02.1979	07.1984	83.7804-0160.3	330811	LATIGUILLO	481 611 776 , 171 611 775	83.6204-0160.3
	1,6 i	TI	06.1978	07.1980	83.7824-0180.3	330812	LATIGUILLO	321 611 775 , 431 611 775 A , 433 611 775 A	83.6224-0180.3
	1,6 TD	TI	12.1981	07.1984	83.7824-0180.3	330812	LATIGUILLO	321 611 775 , 431 611 775 A , 433 611 775 A	83.6224-0180.3
		TD	12.1981	07.1984	83.7804-0160.3	330811	LATIGUILLO	481 611 776 , 171 611 775	83.6204-0160.3
	1,9	TD	01.1981	07.1983	83.7804-0160.3	330811	LATIGUILLO	481 611 776 , 171 611 775	83.6204-0160.3
		TI	01.1981	07.1983	83.7824-0180.3	330812	LATIGUILLO	321 611 775 , 431 611 775 A , 433 611 775 A	83.6224-0180.3
	2	TI	08.1983	07.1984	83.7824-0180.3	330812	LATIGUILLO	321 611 775 , 431 611 775 A , 433 611 775 A	83.6224-0180.3
		TD	08.1983	07.1984	83.7804-0160.3	330811	LATIGUILLO	481 611 776 , 171 611 775	83.6204-0160.3



					Denominación	Ref. OE correspondientes a las referencias ATE	Referencia anterior / varios
--	--	--	--	--	--------------	--	------------------------------

VOLKSWAGEN

PASSAT Variant (73-84)	2,2	TI	01.1981	07.1983	83.7824-0180.3	330812	LATIGUILLO	321 611 775 , 431 611 775 A , 433 611 775 A	83.6224-0180.3
		TD	01.1981	07.1983	83.7804-0160.3	330811	LATIGUILLO	481 611 776 , 171 611 775	83.6204-0160.3
PASSAT Variant (85-88)	1,3	TI	08.1984	07.1986	83.7824-0180.3	330812	LATIGUILLO	321 611 775 , 431 611 775 A , 433 611 775 A	83.6224-0180.3
		TD	08.1984	07.1986	83.7804-0160.3	330811	LATIGUILLO	481 611 776 , 171 611 775	83.6204-0160.3
	1,6	TI	08.1984	03.1988	83.7824-0180.3	330812	LATIGUILLO	321 611 775 , 431 611 775 A , 433 611 775 A	83.6224-0180.3
		TD	08.1984	03.1988	83.7804-0160.3	330811	LATIGUILLO	481 611 776 , 171 611 775	83.6204-0160.3
	1,6 D	TI	08.1984	03.1988	83.7824-0180.3	330812	LATIGUILLO	321 611 775 , 431 611 775 A , 433 611 775 A	83.6224-0180.3
		TD	08.1984	03.1988	83.7804-0160.3	330811	LATIGUILLO	481 611 776 , 171 611 775	83.6204-0160.3
	1,6 TD	TI	08.1984	03.1988	83.7824-0180.3	330812	LATIGUILLO	321 611 775 , 431 611 775 A , 433 611 775 A	83.6224-0180.3
		TD	08.1984	03.1988	83.7804-0160.3	330811	LATIGUILLO	481 611 776 , 171 611 775	83.6204-0160.3
	1,8	TI	08.1984	03.1988	83.7824-0180.3	330812	LATIGUILLO	321 611 775 , 431 611 775 A , 433 611 775 A	83.6224-0180.3
		TD	08.1984	03.1988	83.7804-0160.3	330811	LATIGUILLO	481 611 776 , 171 611 775	83.6204-0160.3
	2	TD	08.1984	03.1988	83.7804-0160.3	330811	LATIGUILLO	481 611 776 , 171 611 775	83.6204-0160.3
		TI	08.1984	03.1988	83.7824-0180.3	330812	LATIGUILLO	321 611 775 , 431 611 775 A , 433 611 775 A	83.6224-0180.3
	2,2	TD	08.1985	03.1988	83.7804-0160.3	330811	LATIGUILLO	481 611 776 , 171 611 775	83.6204-0160.3
		TI	08.1985	03.1988	83.7824-0180.3	330812	LATIGUILLO	321 611 775 , 431 611 775 A , 433 611 775 A	83.6224-0180.3



					Denominación	Ref. OE correspondientes a las referencias ATE		Referencia anterior / varios
--	--	--	--	--	--------------	--	--	------------------------------

VOLKSWAGEN

PASSAT/SANTANA Berlina (73-84)	1,3	TI	05.1973	07.1980	83.7824-0180.3	330812	LATIGUILLO	321 611 775 , 431 611 775 A , 433 611 775 A	83.6224-0180.3
		TD	08.1980	07.1984	83.7804-0160.3	330811	LATIGUILLO	481 611 776 , 171 611 775	83.6204-0160.3
	1,5	TI	05.1973	08.1975	83.7824-0180.3	330812	LATIGUILLO	321 611 775 , 431 611 775 A , 433 611 775 A	83.6224-0180.3
	1,5 D	TI	08.1977	07.1980	83.7824-0180.3	330812	LATIGUILLO	321 611 775 , 431 611 775 A , 433 611 775 A	83.6224-0180.3
	1,6	TI	08.1980	07.1984	83.7824-0180.3	330812	LATIGUILLO	321 611 775 , 431 611 775 A , 433 611 775 A	83.6224-0180.3
		TI	09.1975	07.1980	83.7824-0180.3	330812	LATIGUILLO	321 611 775 , 431 611 775 A , 433 611 775 A	83.6224-0180.3
		TD	08.1980	07.1984	83.7804-0160.3	330811	LATIGUILLO	481 611 776 , 171 611 775	83.6204-0160.3
	1,6 D	TI	08.1980	07.1984	83.7824-0180.3	330812	LATIGUILLO	321 611 775 , 431 611 775 A , 433 611 775 A	83.6224-0180.3
		TD	08.1980	07.1984	83.7804-0160.3	330811	LATIGUILLO	481 611 776 , 171 611 775	83.6204-0160.3
	1,6 i	TI	09.1975	07.1980	83.7824-0180.3	330812	LATIGUILLO	321 611 775 , 431 611 775 A , 433 611 775 A	83.6224-0180.3
	1,6 TD	TI	12.1981	07.1984	83.7824-0180.3	330812	LATIGUILLO	321 611 775 , 431 611 775 A , 433 611 775 A	83.6224-0180.3
		TD	12.1981	07.1984	83.7804-0160.3	330811	LATIGUILLO	481 611 776 , 171 611 775	83.6204-0160.3
	1,9	TI	01.1981	07.1983	83.7824-0180.3	330812	LATIGUILLO	321 611 775 , 431 611 775 A , 433 611 775 A	83.6224-0180.3
		TD	01.1981	07.1983	83.7804-0160.3	330811	LATIGUILLO	481 611 776 , 171 611 775	83.6204-0160.3
	2	TD	08.1983	07.1984	83.7804-0160.3	330811	LATIGUILLO	481 611 776 , 171 611 775	83.6204-0160.3

Nuevas referencias en almacén - Por aplicación

09/2007



					Denominación	Ref. OE correspondientes a las referencias ATE		Referencia anterior / varios
--	--	--	--	--	--------------	--	--	------------------------------

VOLKSWAGEN

PASSAT/SANTANA Berlina (73-84)	2	TI	08.1983	07.1984	83.7824-0180.3	330812	LATIGUILLO	321 611 775 , 431 611 775 A , 433 611 775 A	83.6224-0180.3
	2,2	TD	01.1981	07.1983	83.7804-0160.3	330811	LATIGUILLO	481 611 776 , 171 611 775	83.6204-0160.3
		TI	01.1981	07.1983	83.7824-0180.3	330812	LATIGUILLO	321 611 775 , 431 611 775 A , 433 611 775 A	83.6224-0180.3
POLO I (75-81)	0,9		04.1975	09.1981	83.7734-0290.3	330809	LATIGUILLO	861 611 707 A , 861 611 707 B , 861 611 707 C	83.6134-0290.3
		TI	04.1975	09.1981	83.7824-0180.3	330812	LATIGUILLO	321 611 775 , 431 611 775 A , 433 611 775 A	83.6224-0180.3
	1,1	TI	04.1975	09.1981	83.7824-0180.3	330812	LATIGUILLO	321 611 775 , 431 611 775 A , 433 611 775 A	83.6224-0180.3
			04.1975	09.1981	83.7734-0290.3	330809	LATIGUILLO	861 611 707 A , 861 611 707 B , 861 611 707 C	83.6134-0290.3
	1,3	TI	12.1976	09.1981	83.7824-0180.3	330812	LATIGUILLO	321 611 775 , 431 611 775 A , 433 611 775 A	83.6224-0180.3
			12.1976	09.1981	83.7734-0290.3	330809	LATIGUILLO	861 611 707 A , 861 611 707 B , 861 611 707 C	83.6134-0290.3
POLO II (81-94)	1		10.1981	09.1994	83.7734-0290.3	330809	LATIGUILLO	861 611 707 A , 861 611 707 B , 861 611 707 C	83.6134-0290.3
		TI	10.1981	09.1994	83.7824-0180.3	330812	LATIGUILLO	321 611 775 , 431 611 775 A , 433 611 775 A	83.6224-0180.3
	1,1	TI	10.1981	07.1983	83.7824-0180.3	330812	LATIGUILLO	321 611 775 , 431 611 775 A , 433 611 775 A	83.6224-0180.3
			10.1981	07.1983	83.7734-0290.3	330809	LATIGUILLO	861 611 707 A , 861 611 707 B , 861 611 707 C	83.6134-0290.3
	1,3		10.1981	09.1994	83.7734-0290.3	330809	LATIGUILLO	861 611 707 A , 861 611 707 B , 861 611 707 C	83.6134-0290.3



					Denominación	Ref. OE correspondientes a las referencias ATE		Referencia anterior / varios
--	--	--	--	--	--------------	--	--	------------------------------

VOLKSWAGEN

POLO II (81-94)	1,3	TI	10.1981	09.1994	83.7824-0180.3	330812	LATIGUILLO	321 611 775 , 431 611 775 A , 433 611 775 A	83.6224-0180.3
	1,3 D		08.1986	09.1990	83.7734-0290.3	330809	LATIGUILLO	861 611 707 A , 861 611 707 B , 861 611 707 C	83.6134-0290.3
		TI	08.1986	09.1990	83.7824-0180.3	330812	LATIGUILLO	321 611 775 , 431 611 775 A , 433 611 775 A	83.6224-0180.3
	1,3 G40		01.1987	09.1994	83.7734-0290.3	330809	LATIGUILLO	861 611 707 A , 861 611 707 B , 861 611 707 C	83.6134-0290.3
		TI	01.1987	09.1994	83.7824-0180.3	330812	LATIGUILLO	321 611 775 , 431 611 775 A , 433 611 775 A	83.6224-0180.3
	1,4 D		08.1990	09.1994	83.7734-0290.3	330809	LATIGUILLO	861 611 707 A , 861 611 707 B , 861 611 707 C	83.6134-0290.3
		TI	08.1990	09.1994	83.7824-0180.3	330812	LATIGUILLO	321 611 775 , 431 611 775 A , 433 611 775 A	83.6224-0180.3
POLO III (95-01)	1		07.1996	09.2001	83.7852-0377.3	330835	LATIGUILLO	6N0 611 701 B , 3A0 611 701 , 6N0 611 701 , 6N0 611 701 A	83.6252-0377.3
	1,05		10.1994	09.1996	83.7852-0377.3	330835	LATIGUILLO	6N0 611 701 B , 3A0 611 701 , 6N0 611 701 , 6N0 611 701 A	83.6252-0377.3
	1,3		10.1994	04.1997	83.7852-0377.3	330835	LATIGUILLO	6N0 611 701 B , 3A0 611 701 , 6N0 611 701 , 6N0 611 701 A	83.6252-0377.3
	1,4		07.1995	09.2001	83.7852-0377.3	330835	LATIGUILLO	6N0 611 701 B , 3A0 611 701 , 6N0 611 701 , 6N0 611 701 A	83.6252-0377.3
	1,4 16V		01.1999	09.2001	83.7852-0377.3	330835	LATIGUILLO	6N0 611 701 B , 3A0 611 701 , 6N0 611 701 , 6N0 611 701 A	83.6252-0377.3



					Denominación	Ref. OE correspondientes a las referencias ATE		Referencia anterior / varios
--	--	--	--	--	--------------	--	--	------------------------------

VOLKSWAGEN

POLO III (95-01)	1,4 16V		04.1996	09.2001	83.7852-0377.3	330835	LATIGUILLO	6N0 611 701 B , 3A0 611 701 , 6N0 611 701 A	83.6252-0377.3
	1,4 TDI		01.1999	09.2001	83.7852-0377.3	330835	LATIGUILLO	6N0 611 701 B , 3A0 611 701 , 6N0 611 701 A	83.6252-0377.3
	1,6		10.1994	09.1999	83.7852-0377.3	330835	LATIGUILLO	6N0 611 701 B , 3A0 611 701 , 6N0 611 701 A	83.6252-0377.3
	1,6 GTI		04.1998	09.2001	83.7852-0377.3	330835	LATIGUILLO	6N0 611 701 B , 3A0 611 701 , 6N0 611 701 A	83.6252-0377.3
	1,7 SDI		05.1997	09.2001	83.7852-0377.3	330835	LATIGUILLO	6N0 611 701 B , 3A0 611 701 , 6N0 611 701 A	83.6252-0377.3
	1,9 D		10.1994	09.2001	83.7852-0377.3	330835	LATIGUILLO	6N0 611 701 B , 3A0 611 701 , 6N0 611 701 A	83.6252-0377.3
	1,9 SDI		10.1994	09.2001	83.7852-0377.3	330835	LATIGUILLO	6N0 611 701 B , 3A0 611 701 , 6N0 611 701 A	83.6252-0377.3
SCIROCCO (74-83)	1,1	TD	01.1974	07.1980	83.7804-0160.3	330811	LATIGUILLO	481 611 776 , 171 611 775	83.6204-0160.3
	1,3	TD	08.1979	07.1983	83.7804-0160.3	330811	LATIGUILLO	481 611 776 , 171 611 775	83.6204-0160.3
	1,5	TD	01.1974	07.1983	83.7804-0160.3	330811	LATIGUILLO	481 611 776 , 171 611 775	83.6204-0160.3
	1,6	TD	01.1975	07.1983	83.7804-0160.3	330811	LATIGUILLO	481 611 776 , 171 611 775	83.6204-0160.3
	1,7	TD	08.1980	07.1983	83.7804-0160.3	330811	LATIGUILLO	481 611 776 , 171 611 775	83.6204-0160.3
	1,8	TD	08.1982	07.1983	83.7804-0160.3	330811	LATIGUILLO	481 611 776 , 171 611 775	83.6204-0160.3



					Denominación	Ref. OE correspondientes a las referencias ATE		Referencia anterior / varios
--	--	--	--	--	--------------	--	--	------------------------------

VOLKSWAGEN

SCIROCCO II (84-92)	1,3	TI	08.1983	07.1984	83.7824-0180.3	330812	LATIGUILLO	321 611 775 , 431 611 775 A , 433 611 775 A	83.6224-0180.3
	1,6	TI	08.1983	07.1992	83.7824-0180.3	330812	LATIGUILLO	321 611 775 , 431 611 775 A , 433 611 775 A	83.6224-0180.3
	1,8	TI	08.1983	07.1992	83.7824-0180.3	330812	LATIGUILLO	321 611 775 , 431 611 775 A , 433 611 775 A	83.6224-0180.3
SHARAN (95-)	1,8 T		09.1997		83.7717-0450.3	330807	LATIGUILLO	7335771 , 1001348 , 95VW 2078-AE , 7M0 611 701 D	83.6117-0450.3
	1,9 TDI		05.2000		83.7717-0450.3	330807	LATIGUILLO	7335771 , 1001348 , 95VW 2078-AE , 7M0 611 701 D	83.6117-0450.3
			09.1995		83.7717-0450.3	330807	LATIGUILLO	7335771 , 1001348 , 95VW 2078-AE , 7M0 611 701 D	83.6117-0450.3
			09.1996	04.2000	83.7717-0450.3	330807	LATIGUILLO	7335771 , 1001348 , 95VW 2078-AE , 7M0 611 701 D	83.6117-0450.3
	2		09.1995		83.7717-0450.3	330807	LATIGUILLO	7335771 , 1001348 , 95VW 2078-AE , 7M0 611 701 D	83.6117-0450.3
	2,8		09.1995	04.2000	83.7717-0450.3	330807	LATIGUILLO	7335771 , 1001348 , 95VW 2078-AE , 7M0 611 701 D	83.6117-0450.3
	2,8 Syncro		11.1996	04.2000	83.7717-0450.3	330807	LATIGUILLO	7335771 , 1001348 , 95VW 2078-AE , 7M0 611 701 D	83.6117-0450.3
TRANSPORTER (T4) (90-03)	1,8	TD	12.1990	07.1992	83.7804-0160.3	330811	LATIGUILLO	481 611 776 , 171 611 775	83.6204-0160.3
	1,9 D	TD		09.2003	83.7804-0160.3	330811	LATIGUILLO	481 611 776 , 171 611 775	83.6204-0160.3
		TD	07.1990		83.7804-0160.3	330811	LATIGUILLO	481 611 776 , 171 611 775	83.6204-0160.3
	1,9 TD	TD	10.1992		83.7804-0160.3	330811	LATIGUILLO	481 611 776 , 171 611 775	83.6204-0160.3
		TD		09.2003	83.7804-0160.3	330811	LATIGUILLO	481 611 776 , 171 611 775	83.6204-0160.3



					Denominación	Ref. OE correspondientes a las referencias ATE		Referencia anterior / varios
--	--	--	--	--	--------------	--	--	------------------------------

VOLKSWAGEN

TRANSPORTER (T4) (90-03)	2	TD	07.1990		83.7804-0160.3	330811	LATIGUILLO	481 611 776 , 171 611 775	83.6204-0160.3
		TD		09.2003	83.7804-0160.3	330811	LATIGUILLO	481 611 776 , 171 611 775	83.6204-0160.3
	2,4 D	TD		09.2003	83.7804-0160.3	330811	LATIGUILLO	481 611 776 , 171 611 775	83.6204-0160.3
		TD	07.1990		83.7804-0160.3	330811	LATIGUILLO	481 611 776 , 171 611 775	83.6204-0160.3
	2,4 D Syncro	TD		09.2003	83.7804-0160.3	330811	LATIGUILLO	481 611 776 , 171 611 775	83.6204-0160.3
		TD	11.1992		83.7804-0160.3	330811	LATIGUILLO	481 611 776 , 171 611 775	83.6204-0160.3
	2,5	TD		09.2003	83.7804-0160.3	330811	LATIGUILLO	481 611 776 , 171 611 775	83.6204-0160.3
		TD	10.1990		83.7804-0160.3	330811	LATIGUILLO	481 611 776 , 171 611 775	83.6204-0160.3
	2,5 Syncro	TD		09.2003	83.7804-0160.3	330811	LATIGUILLO	481 611 776 , 171 611 775	83.6204-0160.3
		TD	11.1992		83.7804-0160.3	330811	LATIGUILLO	481 611 776 , 171 611 775	83.6204-0160.3
	2,5 TDI	TD		09.2003	83.7804-0160.3	330811	LATIGUILLO	481 611 776 , 171 611 775	83.6204-0160.3
		TD	09.1995		83.7804-0160.3	330811	LATIGUILLO	481 611 776 , 171 611 775	83.6204-0160.3
	2,5 TDI Syncro	TD	09.1995		83.7804-0160.3	330811	LATIGUILLO	481 611 776 , 171 611 775	83.6204-0160.3
		TD		09.2003	83.7804-0160.3	330811	LATIGUILLO	481 611 776 , 171 611 775	83.6204-0160.3
	2,8	TD		09.2003	83.7804-0160.3	330811	LATIGUILLO	481 611 776 , 171 611 775	83.6204-0160.3
FURGONETA (Tipo 2) (79-92)	1,6	TI	07.1979	12.1982	83.7824-0180.3	330812	LATIGUILLO	321 611 775 , 431 611 775 A , 433 611 775 A	83.6224-0180.3
	1,6 D	TI	01.1981	07.1987	83.7824-0180.3	330812	LATIGUILLO	321 611 775 , 431 611 775 A , 433 611 775 A	83.6224-0180.3
			08.1985	07.1987	83.7834-0440.3	330813	LATIGUILLO	291 611 775 , 251 611 775 B	83.6234-0440.3

Nuevas referencias en almacén - Por aplicación

09/2007



					Denominación	Ref. OE correspondientes a las referencias ATE		Referencia anterior / varios
--	--	--	--	--	--------------	--	--	------------------------------

VOLKSWAGEN

FURGONETA (Tipo 2) (79-92)	1,6 TD	TI	08.1984	09.1992	83.7824-0180.3	330812	LATIGUILLO	321 611 775 , 431 611 775 A , 433 611 775 A	83.6224-0180.3
			08.1985	09.1992	83.7834-0440.3	330813	LATIGUILLO	291 611 775 , 251 611 775 B	83.6234-0440.3
	1,6 TD Syncro		03.1986	09.1992	83.7834-0440.3	330813	LATIGUILLO	291 611 775 , 251 611 775 B	83.6234-0440.3
		TI	03.1986	09.1992	83.7824-0180.3	330812	LATIGUILLO	321 611 775 , 431 611 775 A , 433 611 775 A	83.6224-0180.3
	1,7 D	TI	10.1986	09.1992	83.7824-0180.3	330812	LATIGUILLO	321 611 775 , 431 611 775 A , 433 611 775 A	83.6224-0180.3
			08.1985	09.1992	83.7834-0440.3	330813	LATIGUILLO	291 611 775 , 251 611 775 B	83.6234-0440.3
	1,9	TI	08.1982	09.1992	83.7824-0180.3	330812	LATIGUILLO	321 611 775 , 431 611 775 A , 433 611 775 A	83.6224-0180.3
			08.1985	09.1992	83.7834-0440.3	330813	LATIGUILLO	291 611 775 , 251 611 775 B	83.6234-0440.3
	1,9 Syncro	TI	11.1984	09.1992	83.7824-0180.3	330812	LATIGUILLO	321 611 775 , 431 611 775 A , 433 611 775 A	83.6224-0180.3
			11.1984	09.1992	83.7834-0440.3	330813	LATIGUILLO	291 611 775 , 251 611 775 B	83.6234-0440.3
	2	TI	05.1979	04.1986	83.7824-0180.3	330812	LATIGUILLO	321 611 775 , 431 611 775 A , 433 611 775 A	83.6224-0180.3
			08.1985	04.1986	83.7834-0440.3	330813	LATIGUILLO	291 611 775 , 251 611 775 B	83.6234-0440.3
	2,1	TI	08.1985	09.1992	83.7824-0180.3	330812	LATIGUILLO	321 611 775 , 431 611 775 A , 433 611 775 A	83.6224-0180.3
			08.1985	09.1992	83.7834-0440.3	330813	LATIGUILLO	291 611 775 , 251 611 775 B	83.6234-0440.3
	2,1 Syncro	TI	08.1985	09.1992	83.7824-0180.3	330812	LATIGUILLO	321 611 775 , 431 611 775 A , 433 611 775 A	83.6224-0180.3
			08.1985	09.1992	83.7834-0440.3	330813	LATIGUILLO	291 611 775 , 251 611 775 B	83.6234-0440.3

Nuevas referencias en almacén - Por aplicación

09/2007



					Denominación	Ref. OE correspondientes a las referencias ATE		Referencia anterior / varios
--	--	--	--	--	--------------	--	--	------------------------------

VOLKSWAGEN

TIPO	Cilindrada	Desde	Hasta	Ref. ATE	Ref. OE	Denominación	Ref. OE correspondientes a las referencias ATE	Referencia anterior / varios
TIPO 181 (69-79)	1,5	08.1969	07.1970	83.7701-0390.3	330849	LATIGUILLO	181 611 701	83.6101-0390.3
	1,6	08.1970	02.1979	83.7701-0390.3	330849	LATIGUILLO	181 611 701	83.6101-0390.3
VENTO (92-98)	1,4	11.1991	09.1998	83.7836-0135.3	330816	LATIGUILLO	1H0 611 775	83.6236-0135.3
		11.1991	09.1998	83.7713-0435.3	330792	LATIGUILLO	1H0 611 701	83.6113-0435.3
	1,6	09.1992	09.1998	83.7713-0435.3	330792	LATIGUILLO	1H0 611 701	83.6113-0435.3
		09.1992	09.1998	83.7836-0135.3	330816	LATIGUILLO	1H0 611 775	83.6236-0135.3
	1,6 GT	07.1994	09.1998	83.7836-0135.3	330816	LATIGUILLO	1H0 611 775	83.6236-0135.3
	1,8	01.1992	09.1998	83.7713-0435.3	330792	LATIGUILLO	1H0 611 701	83.6113-0435.3
		01.1992	09.1998	83.7836-0135.3	330816	LATIGUILLO	1H0 611 775	83.6236-0135.3
	1,8 GT	01.1992	09.1998	83.7836-0135.3	330816	LATIGUILLO	1H0 611 775	83.6236-0135.3
	1,9 D	11.1991	09.1998	83.7713-0435.3	330792	LATIGUILLO	1H0 611 701	83.6113-0435.3
		11.1991	09.1998	83.7836-0135.3	330816	LATIGUILLO	1H0 611 775	83.6236-0135.3
	1,9 GT TDI	07.1993	09.1998	83.7836-0135.3	330816	LATIGUILLO	1H0 611 775	83.6236-0135.3
	1,9 SDI	04.1997	09.1998	83.7713-0435.3	330792	LATIGUILLO	1H0 611 701	83.6113-0435.3
		04.1997	09.1998	83.7836-0135.3	330816	LATIGUILLO	1H0 611 775	83.6236-0135.3
	1,9 TD	11.1991	09.1998	83.7713-0435.3	330792	LATIGUILLO	1H0 611 701	83.6113-0435.3
		11.1991	09.1998	83.7836-0135.3	330816	LATIGUILLO	1H0 611 775	83.6236-0135.3
	1,9 TDI	02.1996	09.1998	83.7713-0435.3	330792	LATIGUILLO	1H0 611 701	83.6113-0435.3
		07.1993	09.1998	83.7713-0435.3	330792	LATIGUILLO	1H0 611 701	83.6113-0435.3



	i			Denominación	Ref. OE correspondientes a las referencias ATE	i Referencia anterior / varios
--	----------	--	--	---------------------	---	--







VOLKSWAGEN

VENTO (92-98)	1,9 TDI		02.1996	09.1998	83.7836-0135.3	330816	LATIGUILLO	1H0 611 775	83.6236-0135.3
			07.1993	09.1998	83.7836-0135.3	330816	LATIGUILLO	1H0 611 775	83.6236-0135.3
	2		11.1991	09.1998	83.7836-0135.3	330816	LATIGUILLO	1H0 611 775	83.6236-0135.3
			11.1991	09.1998	83.7713-0435.3	330792	LATIGUILLO	1H0 611 701	83.6113-0435.3
	2,8 VR6		01.1992		83.7713-0435.3	330792	LATIGUILLO	1H0 611 701	83.6113-0435.3
			01.1992	09.1998	83.7836-0135.3	330816	LATIGUILLO	1H0 611 775	83.6236-0135.3

Nuevas referencias en almacén - Por aplicación

09/2007



					Denominación	Ref. OE correspondientes a las referencias ATE	 Referencia anterior / varios
---	---	---	---	---	--------------	--	--







VOLVO

240 Break (74-93)	2		08.1976	01.1982	83.6383-0300.3	330371	LATIGUILLO	1229303 , 1205977 , 1229100	83.5294-0315.3-
			08.1974	07.1976	83.6383-0300.3	330371	LATIGUILLO	1229303 , 1205977 , 1229100	83.5294-0315.3-
			08.1984	07.1985	83.6383-0300.3	330371	LATIGUILLO	1229303 , 1205977 , 1229100	83.5294-0315.3-
			10.1982	08.1984	83.6383-0300.3	330371	LATIGUILLO	1229303 , 1205977 , 1229100	83.5294-0315.3-
			08.1980	12.1984	83.6383-0300.3	330371	LATIGUILLO	1229303 , 1205977 , 1229100	83.5294-0315.3-
			08.1983		83.6383-0300.3	330371	LATIGUILLO	1229303 , 1205977 , 1229100	83.5294-0315.3-
	2,1		08.1980	07.1984	83.6383-0300.3	330371	LATIGUILLO	1229303 , 1205977 , 1229100	83.5294-0315.3-
			08.1974	07.1975	83.6383-0300.3	330371	LATIGUILLO	1229303 , 1205977 , 1229100	83.5294-0315.3-
			08.1974	07.1979	83.6383-0300.3	330371	LATIGUILLO	1229303 , 1205977 , 1229100	83.5294-0315.3-
			08.1975	07.1980	83.6383-0300.3	330371	LATIGUILLO	1229303 , 1205977 , 1229100	83.5294-0315.3-
	2,1 T		08.1980	07.1985	83.6383-0300.3	330371	LATIGUILLO	1229303 , 1205977 , 1229100	83.5294-0315.3-
	2,3		08.1984	07.1985	83.6383-0300.3	330371	LATIGUILLO	1229303 , 1205977 , 1229100	83.5294-0315.3-
			08.1984	07.1986	83.6383-0300.3	330371	LATIGUILLO	1229303 , 1205977 , 1229100	83.5294-0315.3-
			08.1986	07.1987	83.6383-0300.3	330371	LATIGUILLO	1229303 , 1205977 , 1229100	83.5294-0315.3-
			01.1983	12.1984	83.6383-0300.3	330371	LATIGUILLO	1229303 , 1205977 , 1229100	83.5294-0315.3-
			08.1984	12.1988	83.6383-0300.3	330371	LATIGUILLO	1229303 , 1205977 , 1229100	83.5294-0315.3-
			08.1986	12.1988	83.6383-0300.3	330371	LATIGUILLO	1229303 , 1205977 , 1229100	83.5294-0315.3-
			08.1980	07.1984	83.6383-0300.3	330371	LATIGUILLO	1229303 , 1205977 , 1229100	83.5294-0315.3-
	2,3 i Katalysator		08.1986		83.6383-0300.3	330371	LATIGUILLO	1229303 , 1205977 , 1229100	83.5294-0315.3-

Nuevas referencias en almacén - Por aplicación

09/2007



					Denominación	Ref. OE correspondientes a las referencias ATE	 Referencia anterior / varios
---	---	---	---	---	--------------	--	--

VOLVO

Modelo	Motor	Fecha 1	Fecha 2	Ref. OE	ATE	Denominación	Ref. OE correspondientes a las referencias ATE	Referencia anterior / varios
240 Break (74-93)	2,3 i Katalysator	08.1991	07.1992	83.6383-0300.3	330371	LATIGUILLO	1229303 , 1205977 , 1229100	83.5294-0315.3-
	2,4 D	04.1979		83.6383-0300.3	330371	LATIGUILLO	1229303 , 1205977 , 1229100	83.5294-0315.3-
		08.1988		83.6383-0300.3	330371	LATIGUILLO	1229303 , 1205977 , 1229100	83.5294-0315.3-
	2,7	08.1979	07.1980	83.6383-0300.3	330371	LATIGUILLO	1229303 , 1205977 , 1229100	83.5294-0315.3-
240 Berlina (74-93)	2	08.1984	07.1985	83.6383-0300.3	330371	LATIGUILLO	1229303 , 1205977 , 1229100	83.5294-0315.3-
		08.1976	07.1979	83.6383-0300.3	330371	LATIGUILLO	1229303 , 1205977 , 1229100	83.5294-0315.3-
		08.1974	07.1976	83.6383-0300.3	330371	LATIGUILLO	1229303 , 1205977 , 1229100	83.5294-0315.3-
		09.1978	08.1983	83.6383-0300.3	330371	LATIGUILLO	1229303 , 1205977 , 1229100	83.5294-0315.3-
		10.1982	08.1984	83.6383-0300.3	330371	LATIGUILLO	1229303 , 1205977 , 1229100	83.5294-0315.3-
	2,1	08.1974	07.1980	83.6383-0300.3	330371	LATIGUILLO	1229303 , 1205977 , 1229100	83.5294-0315.3-
		08.1975	07.1980	83.6383-0300.3	330371	LATIGUILLO	1229303 , 1205977 , 1229100	83.5294-0315.3-
		08.1974	07.1975	83.6383-0300.3	330371	LATIGUILLO	1229303 , 1205977 , 1229100	83.5294-0315.3-
		08.1980	07.1984	83.6383-0300.3	330371	LATIGUILLO	1229303 , 1205977 , 1229100	83.5294-0315.3-
	2,1 T	08.1980	07.1984	83.6383-0300.3	330371	LATIGUILLO	1229303 , 1205977 , 1229100	83.5294-0315.3-
	2,3	08.1980	07.1984	83.6383-0300.3	330371	LATIGUILLO	1229303 , 1205977 , 1229100	83.5294-0315.3-
		08.1978	07.1980	83.6383-0300.3	330371	LATIGUILLO	1229303 , 1205977 , 1229100	83.5294-0315.3-
		08.1983	07.1985	83.6383-0300.3	330371	LATIGUILLO	1229303 , 1205977 , 1229100	83.5294-0315.3-
		08.1984	12.1989	83.6383-0300.3	330371	LATIGUILLO	1229303 , 1205977 , 1229100	83.5294-0315.3-
		08.1980	07.1983	83.6383-0300.3	330371	LATIGUILLO	1229303 , 1205977 , 1229100	83.5294-0315.3-

Nuevas referencias en almacén - Por aplicación

09/2007



					Denominación	Ref. OE correspondientes a las referencias ATE		Referencia anterior / varios
--	--	--	--	--	--------------	--	--	------------------------------

VOLVO

240 Berlina (74-93)	2,3		08.1984	07.1986	83.6383-0300.3	330371	LATIGUILLO	1229303 , 1205977 , 1229100	83.5294-0315.3-
			08.1986	12.1988	83.6383-0300.3	330371	LATIGUILLO	1229303 , 1205977 , 1229100	83.5294-0315.3-
			08.1986	07.1987	83.6383-0300.3	330371	LATIGUILLO	1229303 , 1205977 , 1229100	83.5294-0315.3-
	2,3 i Katalysator		08.1986		83.6383-0300.3	330371	LATIGUILLO	1229303 , 1205977 , 1229100	83.5294-0315.3-
	2,4 D		08.1987		83.6383-0300.3	330371	LATIGUILLO	1229303 , 1205977 , 1229100	83.5294-0315.3-
			08.1978	07.1985	83.6383-0300.3	330371	LATIGUILLO	1229303 , 1205977 , 1229100	83.5294-0315.3-
	2,7		08.1979	07.1980	83.6383-0300.3	330371	LATIGUILLO	1229303 , 1205977 , 1229100	83.5294-0315.3-
260 Break (75-82)			10.1978	07.1982	83.6383-0300.3	330371	LATIGUILLO	1229303 , 1205977 , 1229100	83.5294-0315.3-
			07.1975	07.1982	83.6383-0300.3	330371	LATIGUILLO	1229303 , 1205977 , 1229100	83.5294-0315.3-
			08.1975	07.1977	83.6383-0300.3	330371	LATIGUILLO	1229303 , 1205977 , 1229100	83.5294-0315.3-
	2,8		08.1980	07.1982	83.6383-0300.3	330371	LATIGUILLO	1229303 , 1205977 , 1229100	83.5294-0315.3-
260 Berlina (74-82)	2,7		08.1976	07.1982	83.6383-0300.3	330371	LATIGUILLO	1229303 , 1205977 , 1229100	83.5294-0315.3-
			08.1978	07.1982	83.6383-0300.3	330371	LATIGUILLO	1229303 , 1205977 , 1229100	83.5294-0315.3-
			08.1974	07.1980	83.6383-0300.3	330371	LATIGUILLO	1229303 , 1205977 , 1229100	83.5294-0315.3-
	2,8		08.1980	07.1982	83.6383-0300.3	330371	LATIGUILLO	1229303 , 1205977 , 1229100	83.5294-0315.3-
740 Break (85-92)	2		08.1985	07.1987	24.0122-0217.2	422217	DISCO DE FRENO	1359156 , 270876	
			01.1987	07.1987	24.0122-0217.2	422217	DISCO DE FRENO	1359156 , 270876	
	2,3		09.1985	07.1987	24.0122-0217.2	422217	DISCO DE FRENO	1359156 , 270876	
			08.1985	07.1987	24.0122-0217.2	422217	DISCO DE FRENO	1359156 , 270876	

Nuevas referencias en almacén - Por aplicación

09/2007



					Denominación	Ref. OE correspondientes a las referencias ATE		Referencia anterior / varios
--	--	--	--	--	--------------	--	--	------------------------------







VOLVO

Modelo	Motor	Desde	Hasta	ATE Ref.	ATE Ref.	Denominación	Ref. OE correspondientes a las referencias ATE	Referencia anterior / varios
740 Break (85-92)	2,3	08.1985	07.1986	24.0122-0217.2	422217	DISCO DE FRENO	1359156 , 270876	
	2,3 T	08.1986	07.1987	24.0122-0217.2	422217	DISCO DE FRENO	1359156 , 270876	
		08.1985	07.1987	24.0122-0217.2	422217	DISCO DE FRENO	1359156 , 270876	
	2,4 D	08.1985	07.1987	24.0122-0217.2	422217	DISCO DE FRENO	1359156 , 270876	
	2,4 TD	09.1985	07.1987	24.0122-0217.2	422217	DISCO DE FRENO	1359156 , 270876	
	2,4 TD Intercooler	08.1986	07.1987	24.0122-0217.2	422217	DISCO DE FRENO	1359156 , 270876	
740 Berlina (83-92)	2	01.1987	07.1987	24.0122-0217.2	422217	DISCO DE FRENO	1359156 , 270876	
		08.1985	07.1987	24.0122-0217.2	422217	DISCO DE FRENO	1359156 , 270876	
		01.1986	07.1987	24.0122-0217.2	422217	DISCO DE FRENO	1359156 , 270876	
		12.1983	07.1984	24.0122-0217.2	422217	DISCO DE FRENO	1359156 , 270876	
		01.1985	12.1985	24.0122-0217.2	422217	DISCO DE FRENO	1359156 , 270876	
	2,3	09.1985	07.1987	24.0122-0217.2	422217	DISCO DE FRENO	1359156 , 270876	
		08.1986	07.1987	24.0122-0217.2	422217	DISCO DE FRENO	1359156 , 270876	
		08.1984	07.1987	24.0122-0217.2	422217	DISCO DE FRENO	1359156 , 270876	
		08.1984	07.1986	24.0122-0217.2	422217	DISCO DE FRENO	1359156 , 270876	
		08.1983	07.1984	24.0122-0217.2	422217	DISCO DE FRENO	1359156 , 270876	
	2,3 T	08.1985	07.1987	24.0122-0217.2	422217	DISCO DE FRENO	1359156 , 270876	
		08.1986	07.1987	24.0122-0217.2	422217	DISCO DE FRENO	1359156 , 270876	
	2,4 D	08.1984	07.1987	24.0122-0217.2	422217	DISCO DE FRENO	1359156 , 270876	

Nuevas referencias en almacén - Por aplicación

09/2007



					Denominación	Ref. OE correspondientes a las referencias ATE	 Referencia anterior / varios
---	---	---	---	---	--------------	--	--

VOLVO

Modelo	Motor								
740 Berlina (83-92)	2,4 TD		08.1984	07.1987	24.0122-0217.2	422217	DISCO DE FRENO	1359156 , 270876	
			08.1985	07.1987	24.0122-0217.2	422217	DISCO DE FRENO	1359156 , 270876	
			08.1986	07.1987	24.0122-0217.2	422217	DISCO DE FRENO	1359156 , 270876	
760 Break (82-92)	2,3 T		08.1984	08.1987	24.0122-0217.2	422217	DISCO DE FRENO	1359156 , 270876	
	2,4 D		09.1984	08.1987	24.0122-0217.2	422217	DISCO DE FRENO	1359156 , 270876	
	2,8		08.1986	08.1987	24.0122-0217.2	422217	DISCO DE FRENO	1359156 , 270876	
			05.1986	08.1987	24.0122-0217.2	422217	DISCO DE FRENO	1359156 , 270876	
760 Berlina (82-92)	2,3 T		09.1984	08.1987	24.0122-0217.2	422217	DISCO DE FRENO	1359156 , 270876	
	2,4 D		09.1984	08.1987	24.0122-0217.2	422217	DISCO DE FRENO	1359156 , 270876	
	2,4 TD		09.1984	07.1987	24.0122-0217.2	422217	DISCO DE FRENO	1359156 , 270876	
			04.1987	08.1987	24.0122-0217.2	422217	DISCO DE FRENO	1359156 , 270876	
	2,8		09.1984	08.1987	24.0122-0217.2	422217	DISCO DE FRENO	1359156 , 270876	
			05.1986	08.1987	24.0122-0217.2	422217	DISCO DE FRENO	1359156 , 270876	
			08.1986	08.1987	24.0122-0217.2	422217	DISCO DE FRENO	1359156 , 270876	



13.0460-8008.2 608008

Aplicación:

JEEP CHEROKEE (KJ) (01-)
CHRYSLER VOYAGER (RG) (00-)

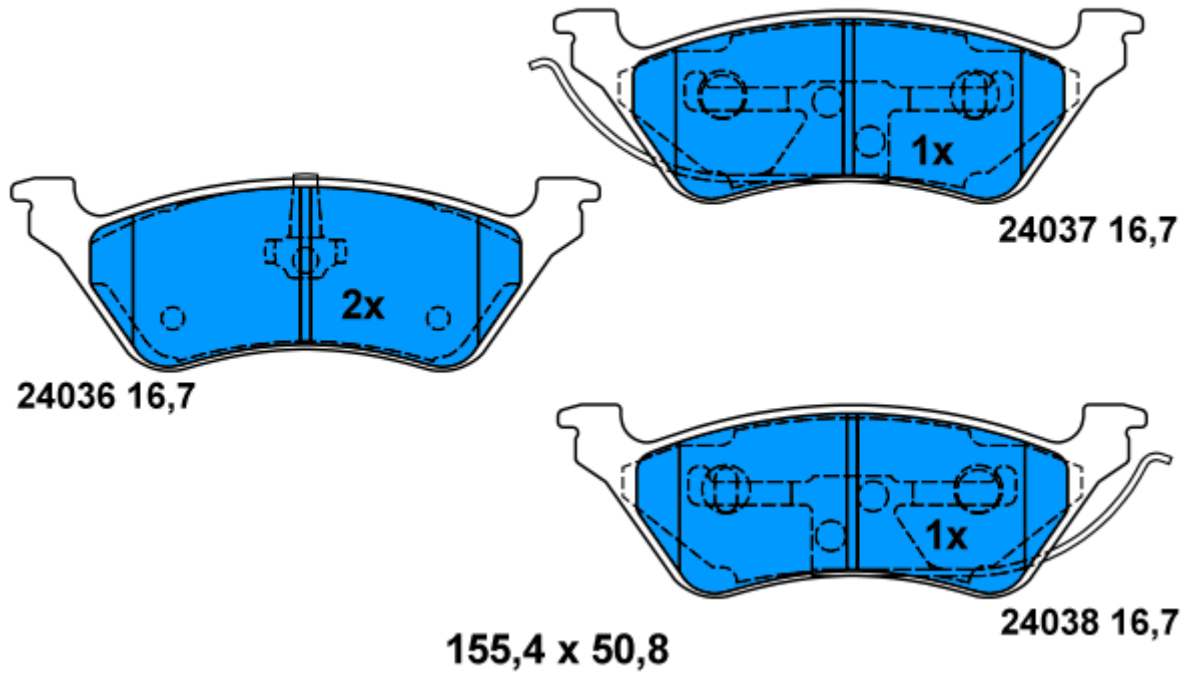



13.0460-4812.2 604812

Aplicación:

PEUGEOT BOXER (06-)
FIAT DUCATO (06-)
CITROEN JUMPER (06-)

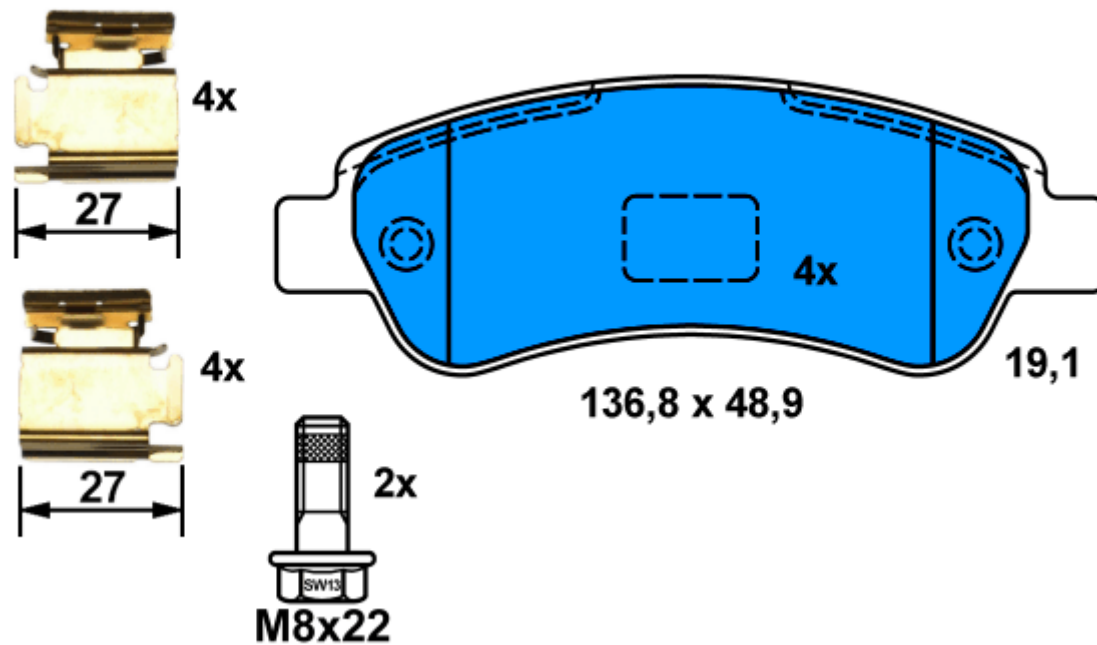

Ate

13.0460-3835.2 603835

Aplicación:

FORD TRANSIT (06-)

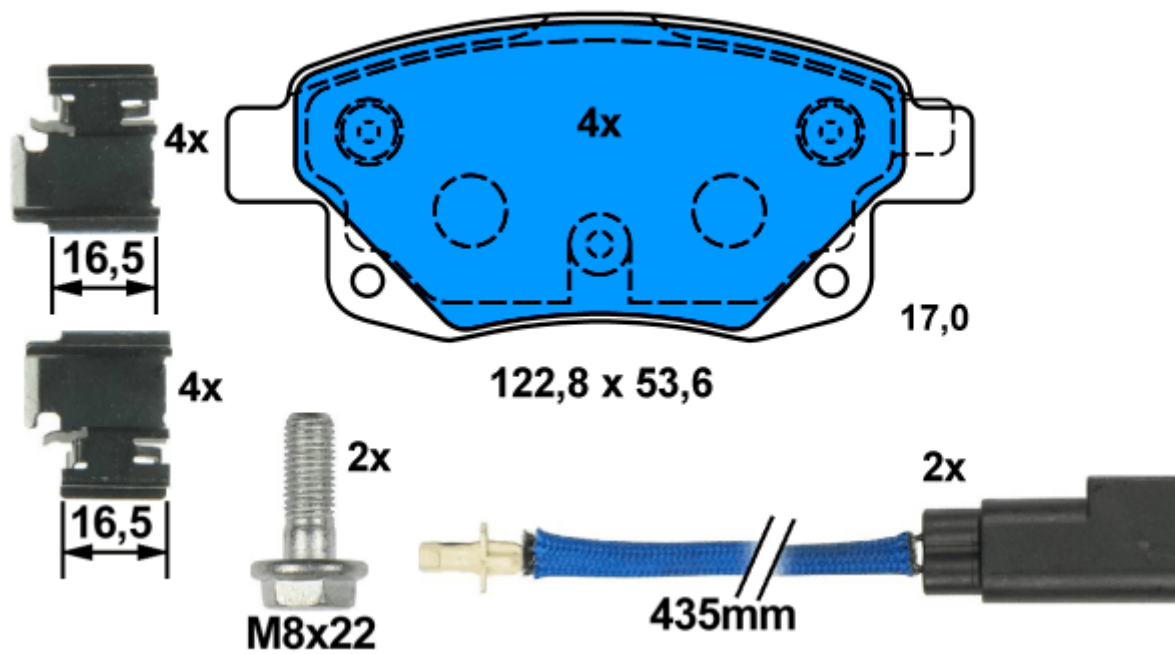

Ate

13.0460-6917.2 606917

Aplicación:

LAND ROVER DISCOVERY I (89-98)
LAND ROVER DISCOVERY II (94-04)
LAND ROVER RANGE ROVER I (70-94)

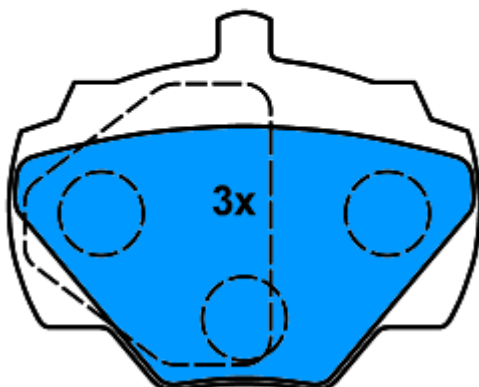
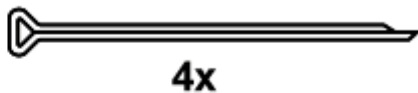
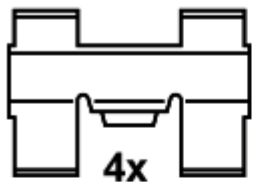

**21237 15,5
(21238)**

88,6 x 71,3

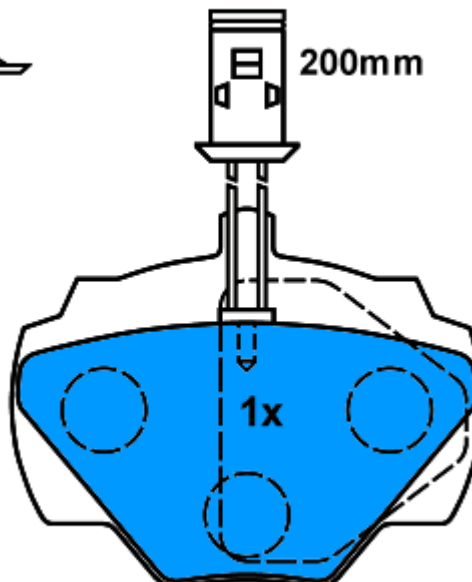

21514 15,5



13.0460-5881.2 605881

Aplicación:

NISSAN SERENA/VANETTE CARGO (C23M/963) (92-01)

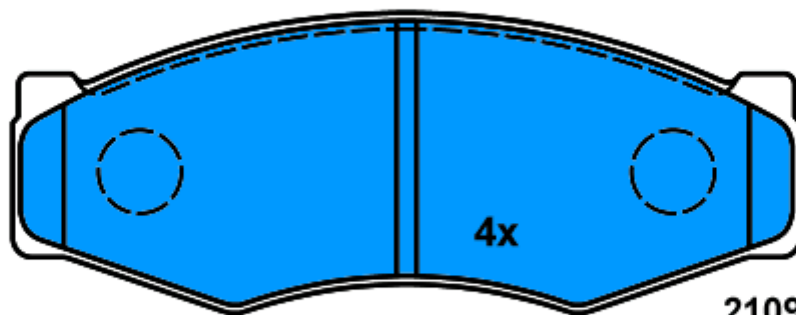

21099 17,0

128 x 49,5



13.0460-5877.2 605877

Aplicación:

MAZDA RX-8 (03-)

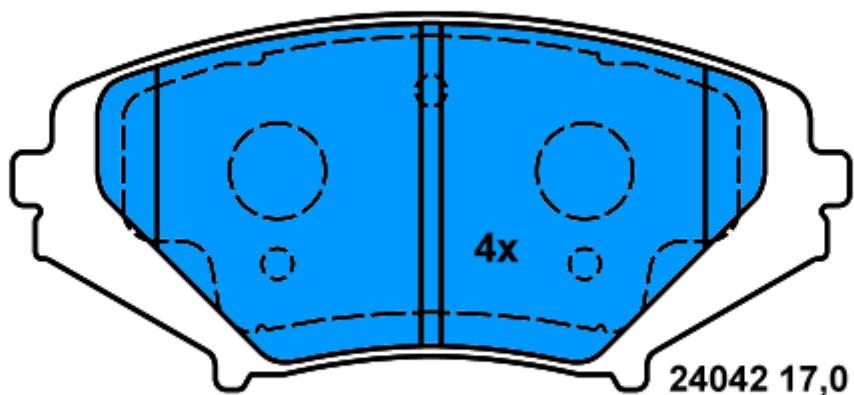

137,9 x 62