

Nouvelles références disponibles
par applications



07/2007



www.ate.de

Nouvelles références disponibles - par applications

07/2007



					description	Références OE par référence ATE.		Références remplacées / divers
--	--	--	--	--	-------------	----------------------------------	--	--------------------------------





AUDI

A8 (03-)	3		07.2003		24.0134-0100.1	434100	DISQUE DE FREIN	4E0 615 301 A , 4E0 615 301 P , 3D0 615 301 M , 4E0 615 301 G , 3D0 615 301 F , 4E0 615 301 J	
	3,0 TDI Quattro		11.2003		24.0134-0100.1	434100	DISQUE DE FREIN	4E0 615 301 A , 4E0 615 301 P , 3D0 615 301 M , 4E0 615 301 G , 3D0 615 301 F , 4E0 615 301 J	
	3,2 FSI		06.2005		24.0134-0100.1	434100	DISQUE DE FREIN	4E0 615 301 A , 4E0 615 301 P , 3D0 615 301 M , 4E0 615 301 G , 3D0 615 301 F , 4E0 615 301 J	
	3,2 FSI Quattro		06.2005		24.0134-0100.1	434100	DISQUE DE FREIN	4E0 615 301 A , 4E0 615 301 P , 3D0 615 301 M , 4E0 615 301 G , 3D0 615 301 F , 4E0 615 301 J	
	3,7 Quattro		11.2002		24.0134-0100.1	434100	DISQUE DE FREIN	4E0 615 301 A , 4E0 615 301 P , 3D0 615 301 M , 4E0 615 301 G , 3D0 615 301 F , 4E0 615 301 J	
	4,0 TDI Quattro		03.2003		24.0134-0100.1	434100	DISQUE DE FREIN	4E0 615 301 A , 4E0 615 301 P , 3D0 615 301 M , 4E0 615 301 G , 3D0 615 301 F , 4E0 615 301 J	
	4,2 FSI Quattro		06.2006		24.0134-0100.1	434100	DISQUE DE FREIN	4E0 615 301 A , 4E0 615 301 P , 3D0 615 301 M , 4E0 615 301 G , 3D0 615 301 F , 4E0 615 301 J	
	4,2 Quattro		11.2002		24.0134-0100.1	434100	DISQUE DE FREIN	4E0 615 301 A , 4E0 615 301 P , 3D0 615 301 M , 4E0 615 301 G , 3D0 615 301 F , 4E0 615 301 J	

Nouvelles références disponibles - par applications

07/2007



				description	Références OE par référence ATE.	 Références remplacées / divers
---	---	--	---	-------------	--	---







AUDI

A8 (03-)	4,2 TDI Quattro		07.2005		24.0134-0100.1	434100	DISQUE DE FREIN	4E0 615 301 A , 4E0 615 301 P , 3D0 615 301 M , 4E0 615 301 G , 3D0 615 301 F , 4E0 615 301 J	
	6,0 W12 Quattro		02.2004		24.0134-0100.1	434100	DISQUE DE FREIN	4E0 615 301 A , 4E0 615 301 P , 3D0 615 301 M , 4E0 615 301 G , 3D0 615 301 F , 4E0 615 301 J	
Q7 (06-)	3,0 TDI		03.2006		24.0128-0169.1	428169	DISQUE DE FREIN	955 352 401 50 , 7L8 615 601 D , 7L8 615 601 A	
	3,6 FSI		08.2006		24.0128-0169.1	428169	DISQUE DE FREIN	955 352 401 50 , 7L8 615 601 D , 7L8 615 601 A	
	4,2 FSI		03.2006		24.0128-0169.1	428169	DISQUE DE FREIN	955 352 401 50 , 7L8 615 601 D , 7L8 615 601 A	
	4,2 TDI		03.2007		24.0128-0169.1	428169	DISQUE DE FREIN	955 352 401 50 , 7L8 615 601 D , 7L8 615 601 A	

Nouvelles références disponibles - par applications

07/2007



					description	Références OE par référence ATE.		Références remplacées / divers
---	---	---	---	---	-------------	--	---	-----------------------------------







BMW

Série 5/E60 Berline (03-)	525 d		03.2007		11.0230-0176.2	260088	JEU SUPPORTS	34 21 6 753 681	
	525 i		03.2007		11.0230-0176.2	260088	JEU SUPPORTS	34 21 6 753 681	
	530 d		07.2003	08.2005	11.0230-0176.2	260088	JEU SUPPORTS	34 21 6 753 681	
			03.2007		11.0230-0176.2	260088	JEU SUPPORTS	34 21 6 753 681	
			07.2003	03.2007	11.0230-0176.2	260088	JEU SUPPORTS	34 21 6 753 681	
	530 i		03.2007		11.0230-0176.2	260088	JEU SUPPORTS	34 21 6 753 681	
			07.2005	03.2007	11.0230-0176.2	260088	JEU SUPPORTS	34 21 6 753 681	
	535 d		03.2007		11.0230-0176.2	260088	JEU SUPPORTS	34 21 6 753 681	
			09.2004	03.2007	11.0230-0176.2	260088	JEU SUPPORTS	34 21 6 753 681	
	540 i		03.2007		11.0230-0176.2	260088	JEU SUPPORTS	34 21 6 753 681	
	545 i		07.2003	08.2005	11.0230-0176.2	260088	JEU SUPPORTS	34 21 6 753 681	
	550 i		07.2005		11.0230-0176.2	260088	JEU SUPPORTS	34 21 6 753 681	
Série 6/E63 Coupé (04-)	645 Ci		12.2003		11.0230-0176.2	260088	JEU SUPPORTS	34 21 6 753 681	
	650 i		07.2005		11.0230-0176.2	260088	JEU SUPPORTS	34 21 6 753 681	
Série 6/E64 Décapotable (04-)	645 Ci		04.2004		11.0230-0176.2	260088	JEU SUPPORTS	34 21 6 753 681	
	650 i		07.2005		11.0230-0176.2	260088	JEU SUPPORTS	34 21 6 753 681	
Série 7/E65-66 (02-)	730 Ld		03.2005		11.0230-0176.2	260088	JEU SUPPORTS	34 21 6 753 681	
	740 d		09.2002		11.0230-0176.2	260088	JEU SUPPORTS	34 21 6 753 681	
	740 i,Li		03.2005		11.0230-0176.2	260088	JEU SUPPORTS	34 21 6 753 681	

Nouvelles références disponibles - par applications

07/2007



					description	Références OE par référence ATE.		Références remplacées / divers
---	---	---	---	---	-------------	----------------------------------	---	--------------------------------

BMW

Série 7/E65-66 (02-)	745 i		11.2001		11.0230-0176.2	260088	JEU SUPPORTS	34 21 6 753 681	
	745 Li		04.2002		11.0230-0176.2	260088	JEU SUPPORTS	34 21 6 753 681	
	750 i		03.2005		11.0230-0176.2	260088	JEU SUPPORTS	34 21 6 753 681	
	750 Li		03.2005		11.0230-0176.2	260088	JEU SUPPORTS	34 21 6 753 681	
	760 i		03.2003		11.0230-0176.2	260088	JEU SUPPORTS	34 21 6 753 681	
	760 Li		03.2003		11.0230-0176.2	260088	JEU SUPPORTS	34 21 6 753 681	
X5 (00-06)	3,0 d		10.2003	03.2007	11.0230-0119.2	260089	JEU SUPPORTS	34 21 6 768 438	
			05.2001	09.2003	11.0230-0119.2	260089	JEU SUPPORTS	34 21 6 768 438	
	3,0 i		04.2000	03.2007	11.0230-0119.2	260089	JEU SUPPORTS	34 21 6 768 438	
	4,4 i		04.2000	09.2003	11.0230-0119.2	260089	JEU SUPPORTS	34 21 6 768 438	

CHRYSLER

VOYAGER (ES) (91-95)	2,0 i		01.1995	12.1995	13.0460-8009.2	608009	PLAQUETTES DE FREIN	4423 812	cf. Photo
	2,5 i		01.1991	12.1995	13.0460-8009.2	608009	PLAQUETTES DE FREIN	4423 812	cf. Photo
	2,5 TD		01.1992	12.1995	13.0460-8009.2	608009	PLAQUETTES DE FREIN	4423 812	cf. Photo
	3,0 i		01.1991	12.1995	13.0460-8009.2	608009	PLAQUETTES DE FREIN	4423 812	cf. Photo
	3,3 i		01.1991	12.1995	13.0460-8009.2	608009	PLAQUETTES DE FREIN	4423 812	cf. Photo
	3,8 i		01.1994	12.1995	13.0460-8009.2	608009	PLAQUETTES DE FREIN	4423 812	cf. Photo



					description	Références OE par référence ATE.		Références remplacées / divers
--	--	--	--	--	-------------	----------------------------------	--	--------------------------------

CITROEN

JUMPER (06-)	2,2 HDi (12/14)		04.2006		13.0460-4807.2	604807	PLAQUETTES DE FREIN	77364014 , 4253 55 , 4253 56	cf. Photo
	2,2 HDi (16H)		04.2006		13.0460-4810.2	604810	PLAQUETTES DE FREIN	77364318 , 77364015 , 4253 73 , 4253 74	cf. Photo
	2,2 HDi (16L)		04.2006		13.0460-4809.2	604809	PLAQUETTES DE FREIN	77364160 , 4253 57 , 4253 58	cf. Photo
	2,2 HDi (20)		04.2006		13.0460-4811.2	604811	PLAQUETTES DE FREIN	77364319 , 77364161 , 4253 75 , 4253 76	cf. Photo
	3,0 HDi (12/14)		09.2006		13.0460-4807.2	604807	PLAQUETTES DE FREIN	77364014 , 4253 55 , 4253 56	cf. Photo
	3,0 HDi (16H)		09.2006		13.0460-4810.2	604810	PLAQUETTES DE FREIN	77364318 , 77364015 , 4253 73 , 4253 74	cf. Photo
	3,0 HDi (16L)		09.2006		13.0460-4809.2	604809	PLAQUETTES DE FREIN	77364160 , 4253 57 , 4253 58	cf. Photo
	3,0 HDi (20)		09.2006		13.0460-4811.2	604811	PLAQUETTES DE FREIN	77364319 , 77364161 , 4253 75 , 4253 76	cf. Photo
JUMPER Autobus/car (94-02)	1,9 D (10)			03.2002	24.3727-0350.2	580350	CABLE FREIN A MAIN	4745 V3	
	1,9 TD (10/14)			03.2002	24.3727-0350.2	580350	CABLE FREIN A MAIN	4745 V3	
	2,0 i (10/14/18)			03.2002	24.3727-0350.2	580350	CABLE FREIN A MAIN	4745 V3	
	2,5 D (14/18)			03.2002	24.3727-0350.2	580350	CABLE FREIN A MAIN	4745 V3	
	2,5 TD (14/18)			03.2002	24.3727-0350.2	580350	CABLE FREIN A MAIN	4745 V3	
	2,5 TDi (14/18)			11.2000	24.3727-0350.2	580350	CABLE FREIN A MAIN	4745 V3	
	2,8 HDi (14/18) 2WD			03.2002	24.3727-0350.2	580350	CABLE FREIN A MAIN	4745 V3	
XM (Y4) Break (94-00)	2,5 TD			10.2000	24.0128-0178.1	428178	DISQUE DE FREIN	4246 T2	
	3,0 V6		04.1997	10.2000	24.0128-0178.1	428178	DISQUE DE FREIN	4246 T2	
XM (Y4) Berline (94-00)	2,5 TD			10.2000	24.0128-0178.1	428178	DISQUE DE FREIN	4246 T2	

Nouvelles références disponibles - par applications

07/2007



					description	Références OE par référence ATE.		Références remplacées / divers
--	--	--	--	--	-------------	----------------------------------	--	--------------------------------

CITROEN

XM (Y4) Berline (94-00)	3,0 V6		04.1997	10.2000	24.0128-0178.1	428178	DISQUE DE FREIN	4246 T2	
-------------------------	--------	--	---------	---------	----------------	--------	-----------------	---------	--

DACIA

LOGAN Berline (04-)	1,4		09.2004		24.0112-0171.1	412171	DISQUE DE FREIN	77 01 208 252 , 60 01 547 683 , 60 01 549 211	
	1,5 dCi		01.2006		24.0112-0171.1	412171	DISQUE DE FREIN	77 01 208 252 , 60 01 547 683 , 60 01 549 211	
			09.2005		24.0112-0171.1	412171	DISQUE DE FREIN	77 01 208 252 , 60 01 547 683 , 60 01 549 211	
	1,6		09.2004		24.0112-0171.1	412171	DISQUE DE FREIN	77 01 208 252 , 60 01 547 683 , 60 01 549 211	

DAIHATSU

CHARADE (GB) (03-)	1,0 i (L251)		09.2003		03.0137-0475.2	650475	JEU DE MACHOIRE	04495-97220-000	
CUORE (03-)			09.2003		03.0137-0475.2	650475	JEU DE MACHOIRE	04495-97220-000	

Nouvelles références disponibles - par applications

07/2007



					description	Références OE par référence ATE.		Références remplacées / divers
--	--	--	--	--	-------------	----------------------------------	--	--------------------------------

FIAT

BRAVO (07-)	1,9 JTD	AvG	03.2007		24.3541-1809.7	220613	ETRIER A GRIFFE	9949344	
DUCATO (06-)	2,2 JTD (Q11)		07.2006		13.0460-4807.2	604807	PLAQUETTES DE FREIN	77364014 , 4253 55 , 4253 56	cf. Photo
	2,2 JTD (Q15)		07.2006		13.0460-4807.2	604807	PLAQUETTES DE FREIN	77364014 , 4253 55 , 4253 56	cf. Photo
	2,2 JTD (Q17H)		07.2006		13.0460-4810.2	604810	PLAQUETTES DE FREIN	77364318 , 77364015 , 4253 73 , 4253 74	cf. Photo
	2,2 JTD (Q17L)		07.2006		13.0460-4809.2	604809	PLAQUETTES DE FREIN	77364160 , 4253 57 , 4253 58	cf. Photo
	2,2 JTD (Q20)		07.2006		13.0460-4811.2	604811	PLAQUETTES DE FREIN	77364319 , 77364161 , 4253 75 , 4253 76	cf. Photo
	2,3 JTD (Q11)		07.2006		13.0460-4807.2	604807	PLAQUETTES DE FREIN	77364014 , 4253 55 , 4253 56	cf. Photo
	2,3 JTD (Q15)		07.2006		13.0460-4807.2	604807	PLAQUETTES DE FREIN	77364014 , 4253 55 , 4253 56	cf. Photo
	2,3 JTD (Q17H)		07.2006		13.0460-4810.2	604810	PLAQUETTES DE FREIN	77364318 , 77364015 , 4253 73 , 4253 74	cf. Photo
	2,3 JTD (Q17L)		07.2006		13.0460-4809.2	604809	PLAQUETTES DE FREIN	77364160 , 4253 57 , 4253 58	cf. Photo
	2,3 JTD (Q20)		07.2006		13.0460-4811.2	604811	PLAQUETTES DE FREIN	77364319 , 77364161 , 4253 75 , 4253 76	cf. Photo
	3,0 JTD (Q11)		07.2006		13.0460-4807.2	604807	PLAQUETTES DE FREIN	77364014 , 4253 55 , 4253 56	cf. Photo
	3,0 JTD (Q15)		07.2006		13.0460-4807.2	604807	PLAQUETTES DE FREIN	77364014 , 4253 55 , 4253 56	cf. Photo
	3,0 JTD (Q17H)		07.2006		13.0460-4810.2	604810	PLAQUETTES DE FREIN	77364318 , 77364015 , 4253 73 , 4253 74	cf. Photo
	3,0 JTD (Q17L)		07.2006		13.0460-4809.2	604809	PLAQUETTES DE FREIN	77364160 , 4253 57 , 4253 58	cf. Photo
	3,0 JTD (Q20)		07.2006		13.0460-4811.2	604811	PLAQUETTES DE FREIN	77364319 , 77364161 , 4253 75 , 4253 76	cf. Photo
STILO (01-)	1,8 i 16V	AvG	10.2001		24.3541-1809.7	220613	ETRIER A GRIFFE	9949344	

Nouvelles références disponibles - par applications

07/2007



					description	Références OE par référence ATE.		Références remplacées / divers
--	--	--	--	--	-------------	----------------------------------	--	--------------------------------

FIAT

STILO (01-)	1,9 JTD	AvG	01.2004		24.3541-1809.7	220613	ETRIER A GRIFFE	9949344	
		AvG	09.2004		24.3541-1809.7	220613	ETRIER A GRIFFE	9949344	
		AvG	10.2001		24.3541-1809.7	220613	ETRIER A GRIFFE	9949344	

FORD

FOCUS I (98-04)	ST 170		03.2002	09.2004	24.0124-0198.1	424198	DISQUE DE FREIN	4328921 , 4410264	
GALAXY II (06-)	1,8 TDCi		04.2006		13.0460-2723.2	602723	PLAQUETTES DE FREIN	1439867 , 1459408 , 1477803	cf. Photo
	2,0 i 16V		04.2006		13.0460-2723.2	602723	PLAQUETTES DE FREIN	1439867 , 1459408 , 1477803	cf. Photo
	2,0 TDCi		04.2006		13.0460-2723.2	602723	PLAQUETTES DE FREIN	1439867 , 1459408 , 1477803	cf. Photo
MONDEO IV (07-)	1,6 Ti VCT		04.2007		13.0460-2723.2	602723	PLAQUETTES DE FREIN	1439867 , 1459408 , 1477803	cf. Photo
	1,8 TDCi		04.2007		13.0460-2723.2	602723	PLAQUETTES DE FREIN	1439867 , 1459408 , 1477803	cf. Photo
	2,0 i 16V		04.2007		13.0460-2723.2	602723	PLAQUETTES DE FREIN	1439867 , 1459408 , 1477803	cf. Photo
	2,0 TDCi		04.2007		13.0460-2723.2	602723	PLAQUETTES DE FREIN	1439867 , 1459408 , 1477803	cf. Photo
	2,3 i 16V		07.2007		13.0460-2723.2	602723	PLAQUETTES DE FREIN	1439867 , 1459408 , 1477803	cf. Photo
	2,5 i 20V		04.2007		13.0460-2723.2	602723	PLAQUETTES DE FREIN	1439867 , 1459408 , 1477803	cf. Photo
S-MAX (06-)	1,8 TDCi		04.2006		13.0460-2723.2	602723	PLAQUETTES DE FREIN	1439867 , 1459408 , 1477803	cf. Photo
	2,0 i 16V		04.2006		13.0460-2723.2	602723	PLAQUETTES DE FREIN	1439867 , 1459408 , 1477803	cf. Photo
	2,0 TDCi		04.2006		13.0460-2723.2	602723	PLAQUETTES DE FREIN	1439867 , 1459408 , 1477803	cf. Photo
	2,5 i 20V		04.2006		13.0460-2723.2	602723	PLAQUETTES DE FREIN	1439867 , 1459408 , 1477803	cf. Photo

Nouvelles références disponibles - par applications

07/2007



					description	Références OE par référence ATE.		Références remplacées / divers
--	--	--	--	--	-------------	----------------------------------	--	--------------------------------

HONDA

CIVIC (3/4-portes) (95-01)	1,4 i (EJ9)	AvG	11.1995	12.1997	24.3511-1709.5	240333	ETRIER A GRIFFE	45019-S04-003 , 45019-S04-G01	
CIVIC (3-portes) (01-05)	2,0 Type R		09.2001	12.2005	24.0125-0173.1	425173	DISQUE DE FREIN	45251-S6M-A10	
CIVIC (4-portes) (01-05)	1,4 i 16V	ArG	02.2001	12.2005	24.3219-1741.3	020486	CYLINDRE DE ROUE	43301-S5A-003	
		ArD	02.2001	12.2005	24.3219-1742.3	020487	CYLINDRE DE ROUE	43300-S5A-003	
	1,6 i 16V	ArG	02.2001	12.2005	24.3219-1741.3	020486	CYLINDRE DE ROUE	43301-S5A-003	
		ArD	02.2001	12.2005	24.3219-1742.3	020487	CYLINDRE DE ROUE	43300-S5A-003	
CIVIC COUPE (96-01)	1,6 i (EJ6)	AvG	01.1996	01.2001	24.3511-1709.5	240333	ETRIER A GRIFFE	45019-S04-003 , 45019-S04-G01	
LEGEND (91-96)	3,2 i 24V (KA7)		01.1991	01.1996	24.0128-0722.1	428722	DISQUE DE FREIN	45251-SP0-E00	
	3,2 i 24V Coupe (KA8)		01.1991	01.1996	24.0128-0722.1	428722	DISQUE DE FREIN	45251-SP0-E00	
LOGO (99-02)	1,3 i	AvG	02.1999	03.2002	24.3511-1709.5	240333	ETRIER A GRIFFE	45019-S04-003 , 45019-S04-G01	

Nouvelles références disponibles - par applications

07/2007



					description	Références OE par référence ATE.		Références remplacées / divers
--	--	--	--	--	-------------	----------------------------------	--	--------------------------------







HYUNDAI

HIGHWAY VAN (00-04)	2,0 CRDi		04.2001	03.2004	03.0137-3004.2	653004	JEU DE MACHOIRE	58350-26A00 , 58350-3AA00 , 58350-26A10	
	2,0 CVVT		11.2003	03.2004	03.0137-3004.2	653004	JEU DE MACHOIRE	58350-26A00 , 58350-3AA00 , 58350-26A10	
	2,0 i 16V		03.2000	03.2004	03.0137-3004.2	653004	JEU DE MACHOIRE	58350-26A00 , 58350-3AA00 , 58350-26A10	
	2,7 i V6		03.2000	03.2004	03.0137-3004.2	653004	JEU DE MACHOIRE	58350-26A00 , 58350-3AA00 , 58350-26A10	
MATRIX (01-)	1,5 CRDi		08.2003		24.0110-0317.1	410317	DISQUE DE FREIN	58411-38310 , 58411-3C000	
	1,6 i 16V		08.2003		24.0110-0317.1	410317	DISQUE DE FREIN	58411-38310 , 58411-3C000	
	1,8 i 16V		08.2003		24.0110-0317.1	410317	DISQUE DE FREIN	58411-38310 , 58411-3C000	
SANTA FE (01-)	2,0 CRDi		08.2003		03.0137-3004.2	653004	JEU DE MACHOIRE	58350-26A00 , 58350-3AA00 , 58350-26A10	
			11.2003		03.0137-3004.2	653004	JEU DE MACHOIRE	58350-26A00 , 58350-3AA00 , 58350-26A10	
			08.2001	07.2003	03.0137-3004.2	653004	JEU DE MACHOIRE	58350-26A00 , 58350-3AA00 , 58350-26A10	
	2,0 CRDi 4x4		11.2003		03.0137-3004.2	653004	JEU DE MACHOIRE	58350-26A00 , 58350-3AA00 , 58350-26A10	
			04.2001	07.2003	03.0137-3004.2	653004	JEU DE MACHOIRE	58350-26A00 , 58350-3AA00 , 58350-26A10	
			08.2003		03.0137-3004.2	653004	JEU DE MACHOIRE	58350-26A00 , 58350-3AA00 , 58350-26A10	
	2,0 i 16V		10.2003		03.0137-3004.2	653004	JEU DE MACHOIRE	58350-26A00 , 58350-3AA00 , 58350-26A10	

Nouvelles références disponibles - par applications

07/2007



					description	Références OE par référence ATE.		Références remplacées / divers
---	---	---	---	---	-------------	----------------------------------	---	--------------------------------

HYUNDAI

SANTA FE (01-)	2,0 i 16V		02.2001	09.2003	03.0137-3004.2	653004	JEU DE MACHOIRE	58350-26A00 , 58350-3AA00 , 58350-26A10	
	2,4 i 16V		10.2003		03.0137-3004.2	653004	JEU DE MACHOIRE	58350-26A00 , 58350-3AA00 , 58350-26A10	
			02.2001	09.2003	03.0137-3004.2	653004	JEU DE MACHOIRE	58350-26A00 , 58350-3AA00 , 58350-26A10	
	2,4 i 16V 4x4		10.2003		03.0137-3004.2	653004	JEU DE MACHOIRE	58350-26A00 , 58350-3AA00 , 58350-26A10	
			02.2001	09.2003	03.0137-3004.2	653004	JEU DE MACHOIRE	58350-26A00 , 58350-3AA00 , 58350-26A10	
	2,7 i V6 4x4		10.2003		03.0137-3004.2	653004	JEU DE MACHOIRE	58350-26A00 , 58350-3AA00 , 58350-26A10	
			02.2001	09.2003	03.0137-3004.2	653004	JEU DE MACHOIRE	58350-26A00 , 58350-3AA00 , 58350-26A10	
SONATA (05-)	2,0 VVTi		01.2005		24.0110-0318.1	410318	DISQUE DE FREIN	58411-39600 , 58411-39300	
	2,4 VVTi		01.2005		24.0110-0318.1	410318	DISQUE DE FREIN	58411-39600 , 58411-39300	
SONATA (98-04)	2,0 i 16V		06.1998	09.2001	24.0110-0317.1	410317	DISQUE DE FREIN	58411-38310 , 58411-3C000	
			10.2001	12.2004	24.0110-0317.1	410317	DISQUE DE FREIN	58411-38310 , 58411-3C000	
	2,4 i 16V		03.1998	09.2001	24.0110-0317.1	410317	DISQUE DE FREIN	58411-38310 , 58411-3C000	
	2,5 i V6		06.1998	09.2001	24.0110-0317.1	410317	DISQUE DE FREIN	58411-38310 , 58411-3C000	
	2,7 i V6		10.2001	12.2004	24.0110-0317.1	410317	DISQUE DE FREIN	58411-38310 , 58411-3C000	
TRAJET (00-)	2,0 CRDi		04.2001	01.2004	03.0137-3004.2	653004	JEU DE MACHOIRE	58350-26A00 , 58350-3AA00 , 58350-26A10	

Nouvelles références disponibles - par applications

07/2007



					description	Références OE par référence ATE.		Références remplacées / divers
--	--	--	--	--	-------------	----------------------------------	--	--------------------------------

HYUNDAI

TRAJET (00-)	2,0 CVT		11.2003	01.2004	03.0137-3004.2	653004	JEU DE MACHOIRE	58350-26A00 , 58350-3AA00 , 58350-26A10	
	2,0 i 16V		03.2000	10.2003	03.0137-3004.2	653004	JEU DE MACHOIRE	58350-26A00 , 58350-3AA00 , 58350-26A10	
	2,7 i V6		09.2000	01.2004	03.0137-3004.2	653004	JEU DE MACHOIRE	58350-26A00 , 58350-3AA00 , 58350-26A10	
TUCSON (04-)	2,0 CRDi		08.2004		24.0110-0318.1	410318	DISQUE DE FREIN	58411-39600 , 58411-39300	
	2,0 CRDi 4WD		08.2004		24.0110-0318.1	410318	DISQUE DE FREIN	58411-39600 , 58411-39300	
	2,0 i 16V		08.2004		24.0110-0318.1	410318	DISQUE DE FREIN	58411-39600 , 58411-39300	
	2,0 i 16V 4WD		08.2004		24.0110-0318.1	410318	DISQUE DE FREIN	58411-39600 , 58411-39300	
	2,7 i 24V 4WD		08.2004		03.0137-3004.2	653004	JEU DE MACHOIRE	58350-26A00 , 58350-3AA00 , 58350-26A10	
XG (98-)	2,5 i V6 (XG25)		12.1998		24.0110-0318.1	410318	DISQUE DE FREIN	58411-39600 , 58411-39300	
	3,0 i V6 (XG30)		12.1998		24.0110-0318.1	410318	DISQUE DE FREIN	58411-39600 , 58411-39300	
	3,5 i V6 (XG35)		10.2002		24.0110-0318.1	410318	DISQUE DE FREIN	58411-39600 , 58411-39300	

JAGUAR

S-TYPE (CCX) (99-)	2,5 V6		04.2002		24.0120-0708.1	420708	DISQUE DE FREIN	JLM 20802 , XR8 27087	
	2,7 D		06.2004		24.0120-0708.1	420708	DISQUE DE FREIN	JLM 20802 , XR8 27087	
	3,0 V6		01.1999		24.0120-0708.1	420708	DISQUE DE FREIN	JLM 20802 , XR8 27087	
	4,0 V8		01.1999	04.2002	24.0120-0708.1	420708	DISQUE DE FREIN	JLM 20802 , XR8 27087	

Nouvelles références disponibles - par applications

07/2007



					description	Références OE par référence ATE.		Références remplacées / divers
--	--	--	--	--	-------------	----------------------------------	--	--------------------------------

KIA

MAGENTIS (01-)	2,0 i 16V		05.2001		24.0110-0317.1	410317	DISQUE DE FREIN	58411-38310 , 58411-3C000	
	2,5 i V6		05.2001		24.0110-0317.1	410317	DISQUE DE FREIN	58411-38310 , 58411-3C000	
MAGENTIS (05-)	2,0 CRDi		04.2006		24.0110-0318.1	410318	DISQUE DE FREIN	58411-39600 , 58411-39300	
	2,0 i 16V		11.2005		24.0110-0318.1	410318	DISQUE DE FREIN	58411-39600 , 58411-39300	
	2,7 i V6		11.2005		24.0110-0318.1	410318	DISQUE DE FREIN	58411-39600 , 58411-39300	
RIO I (00-05)	1,3 i		08.2000	06.2002	24.0122-0227.1	422227	DISQUE DE FREIN	KDX74-33-251 , MDX74-33-251	
			07.2002	02.2005	24.0124-0187.1	424187	DISQUE DE FREIN	51712-FD300	
	1,5 i 16V		09.2002	02.2005	24.0124-0187.1	424187	DISQUE DE FREIN	51712-FD300	
			08.2000	06.2002	24.0122-0227.1	422227	DISQUE DE FREIN	KDX74-33-251 , MDX74-33-251	
			07.2002	02.2005	24.0124-0187.1	424187	DISQUE DE FREIN	51712-FD300	
SPORTAGE (04-)	2,0 CRDi		01.2006		24.0110-0318.1	410318	DISQUE DE FREIN	58411-39600 , 58411-39300	
	2,0 i 16V		09.2004		24.0110-0318.1	410318	DISQUE DE FREIN	58411-39600 , 58411-39300	

LAND ROVER

RANGE ROVER III (LM) (02-)	3,0 Td 6				24.0130-0184.1	430184	DISQUE DE FREIN	SDB000201	
	4,2				24.0130-0184.1	430184	DISQUE DE FREIN	SDB000201	
	4,4				24.0130-0184.1	430184	DISQUE DE FREIN	SDB000201	



					description	Références OE par référence ATE.		Références remplacées / divers
--	--	--	--	--	-------------	----------------------------------	--	--------------------------------

MAZDA

3 (03-)	1,4 i 16V		10.2003		24.3727-1813.2	581813	CABLE FREIN A MAIN	BP4K-44-150B , BP4K-44-150C , BP4K-44-150D	
	1,6 CITD		06.2004		24.3727-1813.2	581813	CABLE FREIN A MAIN	BP4K-44-150B , BP4K-44-150C , BP4K-44-150D	
	1,6 i 16V		10.2003		24.3727-1813.2	581813	CABLE FREIN A MAIN	BP4K-44-150B , BP4K-44-150C , BP4K-44-150D	
	2,0 i 16V		10.2003		24.3727-1813.2	581813	CABLE FREIN A MAIN	BP4K-44-150B , BP4K-44-150C , BP4K-44-150D	
	2,3 i 16V		10.2003	09.2004	24.3727-1813.2	581813	CABLE FREIN A MAIN	BP4K-44-150B , BP4K-44-150C , BP4K-44-150D	
	2,3 i 16V Sport		10.2003		24.3727-1813.2	581813	CABLE FREIN A MAIN	BP4K-44-150B , BP4K-44-150C , BP4K-44-150D	
MPV II (99-)	2,0 i 16V (LW19)		08.2000	06.2002	24.0128-0175.1	428175	DISQUE DE FREIN	TY01-33-25X , T002-33-25XA	
			09.1999	07.2000	24.0128-0175.1	428175	DISQUE DE FREIN	TY01-33-25X , T002-33-25XA	
	2,3 i 16V (LW19)		07.2002		24.0128-0175.1	428175	DISQUE DE FREIN	TY01-33-25X , T002-33-25XA	
	2,5 i V6 (LW19)		09.1999	03.2002	24.0128-0175.1	428175	DISQUE DE FREIN	TY01-33-25X , T002-33-25XA	
XEDOS 9 (93-)	2,0 i V6 (TA1)		07.1993	01.2000	24.0128-0175.1	428175	DISQUE DE FREIN	TY01-33-25X , T002-33-25XA	
	2,3 i V6 (TA2)		02.1995	01.2000	24.0128-0175.1	428175	DISQUE DE FREIN	TY01-33-25X , T002-33-25XA	
	2,5 i V6 (TA1)		07.1993	06.2000	24.0128-0175.1	428175	DISQUE DE FREIN	TY01-33-25X , T002-33-25XA	
	2,5 i V6 4WS (TA7)		07.1993	06.2000	24.0128-0175.1	428175	DISQUE DE FREIN	TY01-33-25X , T002-33-25XA	

Nouvelles références disponibles - par applications

07/2007









					description	Références OE par référence ATE.		Références remplacées / divers
--	--	--	--	--	-------------	----------------------------------	--	--------------------------------

MERCEDES BENZ

Classe C (CL203) Sportcoupé (01-)	C 350		06.2005		24.0128-0188.1	428188	DISQUE DE FREIN	203 421 04 12	
Classe C (S203) Break (01-)	C 320 CDI		02.2005		24.0128-0188.1	428188	DISQUE DE FREIN	203 421 04 12	
	C 350		06.2005		24.0128-0188.1	428188	DISQUE DE FREIN	203 421 04 12	
	C 350 4-Matic		06.2005		24.0128-0188.1	428188	DISQUE DE FREIN	203 421 04 12	
Classe C (W203) Berline (00-07)	C 320 CDI		02.2005	03.2007	24.0128-0188.1	428188	DISQUE DE FREIN	203 421 04 12	
	C 350		06.2005	03.2007	24.0128-0188.1	428188	DISQUE DE FREIN	203 421 04 12	
	C 350 4-Matic		06.2005	03.2007	24.0128-0188.1	428188	DISQUE DE FREIN	203 421 04 12	
Classe CLK (A209) Décapotable (03-)	CLK 320 CDI		05.2005		24.0128-0188.1	428188	DISQUE DE FREIN	203 421 04 12	
	CLK 350		05.2005		24.0128-0188.1	428188	DISQUE DE FREIN	203 421 04 12	
Classe CLK (C209) Coupé (02-)	CLK 320 CDI		05.2005		24.0128-0188.1	428188	DISQUE DE FREIN	203 421 04 12	
	CLK 350		05.2005		24.0128-0188.1	428188	DISQUE DE FREIN	203 421 04 12	
Classe E (W124) (85-93)	280 E		10.1992	06.1993	24.0120-0199.1	420199	DISQUE DE FREIN	124 423 06 12 , 124 423 10 12	
	280 E Kombi		10.1992	06.1993	24.0120-0199.1	420199	DISQUE DE FREIN	124 423 06 12 , 124 423 10 12	
	300 TE 24		09.1989	09.1992	24.0120-0199.1	420199	DISQUE DE FREIN	124 423 06 12 , 124 423 10 12	
	320 TE		10.1992	06.1993	24.0120-0199.1	420199	DISQUE DE FREIN	124 423 06 12 , 124 423 10 12	
Classe E (W124) (93-97)	E 280		07.1993	02.1995	24.0120-0199.1	420199	DISQUE DE FREIN	124 423 06 12 , 124 423 10 12	
	E 280 Kombi		07.1993	02.1995	24.0120-0199.1	420199	DISQUE DE FREIN	124 423 06 12 , 124 423 10 12	









		 		<p>description</p>	<p>Références OE par référence ATE.</p>	 <p>Références remplacées / divers</p>
---	---	---	---	--------------------	---	---

MERCEDES BENZ

Classe E (W124) (93-97)	E 320 Kombi		07.1993	02.1995	24.0120-0199.1	420199	DISQUE DE FREIN	124 423 06 12 , 124 423 10 12	
	E 36 AMG Kombi		05.1994	02.1995	24.0120-0199.1	420199	DISQUE DE FREIN	124 423 06 12 , 124 423 10 12	









					description	Références OE par référence ATE.		Références remplacées / divers
---	---	---	---	---	-------------	----------------------------------	---	--------------------------------

MITSUBISHI

GRANDIS (04-)	2,0 DI-D (NA6W)		09.2005		13.0460-5855.2	605855	PLAQUETTES DE FREIN	4605A447 , 4605A448 , MR510544 , X3516006 , MN102628	cf. Photo
	2,4 i 16V (NA4W)		04.2004		13.0460-5855.2	605855	PLAQUETTES DE FREIN	4605A447 , 4605A448 , MR510544 , X3516006 , MN102628	cf. Photo
PAJERO (00-)	2,5 TDIC (V64W)		04.2000	10.2003	13.0460-5855.2	605855	PLAQUETTES DE FREIN	4605A447 , 4605A448 , MR510544 , X3516006 , MN102628	cf. Photo
			04.2000	10.2003	03.0137-3003.2	653003	JEU DE MACHOIRE	MN150861 , MR535718	
	3,2 DiD (V68W)		10.2001		13.0460-5855.2	605855	PLAQUETTES DE FREIN	4605A447 , 4605A448 , MR510544 , X3516006 , MN102628	cf. Photo
			04.2000	09.2001	13.0460-5855.2	605855	PLAQUETTES DE FREIN	4605A447 , 4605A448 , MR510544 , X3516006 , MN102628	cf. Photo
			04.2000	09.2001	03.0137-3003.2	653003	JEU DE MACHOIRE	MN150861 , MR535718	
			10.2001		03.0137-3003.2	653003	JEU DE MACHOIRE	MN150861 , MR535718	
	3,5 i V6 GDI (V65W)		04.2000		13.0460-5855.2	605855	PLAQUETTES DE FREIN	4605A447 , 4605A448 , MR510544 , X3516006 , MN102628	cf. Photo
			04.2000		03.0137-3003.2	653003	JEU DE MACHOIRE	MN150861 , MR535718	
PAJERO (05-)	3,2 DiD (V88W)		05.2005		13.0460-5855.2	605855	PLAQUETTES DE FREIN	4605A447 , 4605A448 , MR510544 , X3516006 , MN102628	cf. Photo
	3,8 i V6 (V87W)		05.2005		13.0460-5855.2	605855	PLAQUETTES DE FREIN	4605A447 , 4605A448 , MR510544 , X3516006 , MN102628	cf. Photo



					<p>description</p>	<p>Références OE par référence ATE.</p>	 <p>Références remplacées / divers</p>
---	---	---	---	---	--------------------	---	---

MITSUBISHI

PAJERO SPORT / MONTERO (USA) (98-)	3,0 i V6 (K96W)		06.2000		24.0124-0724.1	424724	DISQUE DE FREIN	MB699716	
			11.1998		24.0124-0724.1	424724	DISQUE DE FREIN	MB699716	

Nouvelles références disponibles - par applications

07/2007



					description	Références OE par référence ATE.		Références remplacées / divers
--	--	--	--	--	-------------	----------------------------------	--	--------------------------------

NISSAN

INTERSTAR (X70) (02-)	1,9 CDi	AvD	11.2003		24.3451-1716.7	220616	ETRIER A GRIFFE	77 01 208 013 , 41001-00QAE , 44 05 526 , 9121359	
	2,2 CDi	AvD	11.2003		24.3451-1716.7	220616	ETRIER A GRIFFE	77 01 208 013 , 41001-00QAE , 44 05 526 , 9121359	
	2,5 CDi	AvD	11.2003		24.3451-1716.7	220616	ETRIER A GRIFFE	77 01 208 013 , 41001-00QAE , 44 05 526 , 9121359	
	3,0 CDi	AvD	11.2003		24.3451-1716.7	220616	ETRIER A GRIFFE	77 01 208 013 , 41001-00QAE , 44 05 526 , 9121359	
MICRA (K12E) (03-)	1,0 i 16V		01.2003		24.3727-1722.2	581722	CABLE FREIN A MAIN	36402-AX000	
	1,2 i 16V		01.2003		24.3727-1722.2	581722	CABLE FREIN A MAIN	36402-AX000	
	1,4 i 16V		01.2003		24.3727-1722.2	581722	CABLE FREIN A MAIN	36402-AX000	
	1,5 dCi		01.2003		24.3727-1722.2	581722	CABLE FREIN A MAIN	36402-AX000	
			09.2003		24.3727-1722.2	581722	CABLE FREIN A MAIN	36402-AX000	
	1,6 i 16V		05.2005		24.3727-1722.2	581722	CABLE FREIN A MAIN	36402-AX000	
MICRA C+C (CK12E) (05-)	1,4 i 16V		08.2005		24.3727-1722.2	581722	CABLE FREIN A MAIN	36402-AX000	
	1,6 i 16V		08.2005		24.3727-1722.2	581722	CABLE FREIN A MAIN	36402-AX000	
NOTE (E11E) (06-)	1,4		03.2006		24.3727-1722.2	581722	CABLE FREIN A MAIN	36402-AX000	
	1,5 dCi		03.2006		24.3727-1722.2	581722	CABLE FREIN A MAIN	36402-AX000	
	1,6		03.2006		24.3727-1722.2	581722	CABLE FREIN A MAIN	36402-AX000	
PRIMASTAR (X83) Bus (01-)	1,9 dCi (100)		03.2001		24.3727-0765.2	580765	CABLE FREIN A MAIN	44 08 726 , 91166639 , 36402-00QAB	
	1,9 dCi (80)		03.2001		24.3727-0765.2	580765	CABLE FREIN A MAIN	44 08 726 , 91166639 , 36402-00QAB	







					description	Références OE par référence ATE.		Références remplacées / divers
--	--	--	--	--	-------------	----------------------------------	--	--------------------------------

NISSAN

PRIMASTAR (X83) Bus (01-)	2,0 i 16V		03.2001		24.3727-0765.2	580765	CABLE FREIN A MAIN	44 08 726 , 91166639 , 36402-00QAB	
	2,5 dCi (140)		09.2003		24.3727-0765.2	580765	CABLE FREIN A MAIN	44 08 726 , 91166639 , 36402-00QAB	
PRIMASTAR (X83) Van (02-)	1,9 dCi (100)		07.2002		24.3727-0765.2	580765	CABLE FREIN A MAIN	44 08 726 , 91166639 , 36402-00QAB	
	1,9 dCi (80)		07.2002		24.3727-0765.2	580765	CABLE FREIN A MAIN	44 08 726 , 91166639 , 36402-00QAB	
	2,0 i 16V		07.2002		24.3727-0765.2	580765	CABLE FREIN A MAIN	44 08 726 , 91166639 , 36402-00QAB	
	2,5 dCi (140)		09.2003		24.3727-0765.2	580765	CABLE FREIN A MAIN	44 08 726 , 91166639 , 36402-00QAB	
PRIMERA (P12E) Berline (02-)	1,6		11.2002		24.3727-1723.2	581723	CABLE FREIN A MAIN	36402-AV910	
			03.2002	10.2002	24.3727-1723.2	581723	CABLE FREIN A MAIN	36402-AV910	
	1,8		03.2002	10.2002	24.3727-1723.2	581723	CABLE FREIN A MAIN	36402-AV910	
			11.2002		24.3727-1723.2	581723	CABLE FREIN A MAIN	36402-AV910	
	1,9 dCi		04.2003		24.3727-1723.2	581723	CABLE FREIN A MAIN	36402-AV910	
	2		11.2002		24.3727-1723.2	581723	CABLE FREIN A MAIN	36402-AV910	
			03.2002	10.2002	24.3727-1723.2	581723	CABLE FREIN A MAIN	36402-AV910	
	2,2 dCi		04.2003		24.3727-1723.2	581723	CABLE FREIN A MAIN	36402-AV910	
	2,2 Di		11.2002		24.3727-1723.2	581723	CABLE FREIN A MAIN	36402-AV910	
			03.2002	10.2002	24.3727-1723.2	581723	CABLE FREIN A MAIN	36402-AV910	
PRIMERA (W12) Break (02-)	1,6		03.2002	10.2002	24.3727-1723.2	581723	CABLE FREIN A MAIN	36402-AV910	



				<p>description</p>	<p>Références OE par référence ATE.</p>	 <p>Références remplacées / divers</p>
---	---	--	---	--------------------	---	---

NISSAN

Modèle	Cylindres	Date 1	Date 2	ATE 1	ATE 2	Description	Références OE	Références ATE
PRIMERA (W12) Break (02-)	1,6	11.2002		24.3727-1723.2	581723	CABLE FREIN A MAIN	36402-AV910	
	1,8	11.2002		24.3727-1723.2	581723	CABLE FREIN A MAIN	36402-AV910	
		03.2002	10.2002	24.3727-1723.2	581723	CABLE FREIN A MAIN	36402-AV910	
	1,9 dCi	04.2003		24.3727-1723.2	581723	CABLE FREIN A MAIN	36402-AV910	
	2	11.2002		24.3727-1723.2	581723	CABLE FREIN A MAIN	36402-AV910	
		03.2002	10.2002	24.3727-1723.2	581723	CABLE FREIN A MAIN	36402-AV910	
	2,2 dCi	04.2003		24.3727-1723.2	581723	CABLE FREIN A MAIN	36402-AV910	
	2,2 Di	03.2002	10.2002	24.3727-1723.2	581723	CABLE FREIN A MAIN	36402-AV910	
		11.2002		24.3727-1723.2	581723	CABLE FREIN A MAIN	36402-AV910	

Nouvelles références disponibles - par applications

07/2007



					description	Références OE par référence ATE.		Références remplacées / divers
--	--	--	--	--	-------------	----------------------------------	--	--------------------------------

OPEL

COMBO / Vauxhall Combo (01-)	1,3 CDTI		06.2003		24.3727-0767.2	580767	CABLE FREIN A MAIN	5 22 013 , 9225545	
	1,4 16V		10.2001		24.3727-0767.2	580767	CABLE FREIN A MAIN	5 22 013 , 9225545	
	1,6		10.2001		24.3727-0767.2	580767	CABLE FREIN A MAIN	5 22 013 , 9225545	
	1,7 CDTI		06.2003		24.3727-0767.2	580767	CABLE FREIN A MAIN	5 22 013 , 9225545	
	1,7 DI 16V		10.2001		24.3727-0767.2	580767	CABLE FREIN A MAIN	5 22 013 , 9225545	
	1,7 DTI 16V		10.2001		24.3727-0767.2	580767	CABLE FREIN A MAIN	5 22 013 , 9225545	
CORSA C / Vauxhall Corsa MK II (00-06)	1,3 CDTI	ArG	06.2003	09.2006	24.3727-0769.2	580769	CABLE FREIN A MAIN	5 22 655 , 24443834	
	1,4 16V	ArD	09.2000	09.2006	24.3727-0766.2	580766	CABLE FREIN A MAIN	5 22 446 , 9191574 , 5 22 014 , 13138930	
		ArG	09.2000	09.2006	24.3727-0768.2	580768	CABLE FREIN A MAIN	5 22 447 , 9191578 , 5 22 015 , 13138929	
	1,7 CDTI	ArG	06.2003	09.2006	24.3727-0769.2	580769	CABLE FREIN A MAIN	5 22 655 , 24443834	
	1,7 DTI 16V	ArG	09.2000	09.2006	24.3727-0769.2	580769	CABLE FREIN A MAIN	5 22 655 , 24443834	
	1,8 16V	ArD	09.2000	09.2006	24.3727-0766.2	580766	CABLE FREIN A MAIN	5 22 446 , 9191574 , 5 22 014 , 13138930	
		ArG	09.2000	09.2006	24.3727-0768.2	580768	CABLE FREIN A MAIN	5 22 447 , 9191578 , 5 22 015 , 13138929	
MOVANO (98-)	1,9 DTI	AvD	09.2003		24.3451-1716.7	220616	ETRIER A GRIFFE	77 01 208 013 , 41001-00QAE , 44 05 526 , 9121359	
	2,2 DTI 16V	AvD	09.2003		24.3451-1716.7	220616	ETRIER A GRIFFE	77 01 208 013 , 41001-00QAE , 44 05 526 , 9121359	
	2,5 DTI	AvD	10.2003		24.3451-1716.7	220616	ETRIER A GRIFFE	77 01 208 013 , 41001-00QAE , 44 05 526 , 9121359	



					description	Références OE par référence ATE.		Références remplacées / divers
--	--	--	--	--	-------------	----------------------------------	--	--------------------------------

OPEL

MOVANO (98-)	2,5 DTI	AvD	09.2003		24.3451-1716.7	220616	ETRIER A GRIFFE	77 01 208 013 , 41001-00QAE , 44 05 526 , 9121359
	3,0 DTI	AvD	10.2003		24.3451-1716.7	220616	ETRIER A GRIFFE	77 01 208 013 , 41001-00QAE , 44 05 526 , 9121359
TIGRA TWIN TOP / Vauxhall Tigra Twin Top (04-)	1,3 CDTI	ArG	06.2004		24.3727-0768.2	580768	CABLE FREIN A MAIN	5 22 447 , 9191578 , 5 22 015 , 13138929
		ArD	06.2004		24.3727-0766.2	580766	CABLE FREIN A MAIN	5 22 446 , 9191574 , 5 22 014 , 13138930
	1,4	ArG	06.2004		24.3727-0768.2	580768	CABLE FREIN A MAIN	5 22 447 , 9191578 , 5 22 015 , 13138929
		ArD	06.2004		24.3727-0766.2	580766	CABLE FREIN A MAIN	5 22 446 , 9191574 , 5 22 014 , 13138930
	1,8	ArG	06.2004		24.3727-0768.2	580768	CABLE FREIN A MAIN	5 22 447 , 9191578 , 5 22 015 , 13138929
		ArD	06.2004		24.3727-0766.2	580766	CABLE FREIN A MAIN	5 22 446 , 9191574 , 5 22 014 , 13138930
VIVARO (01-)	1,9 DI		08.2001		24.3727-0765.2	580765	CABLE FREIN A MAIN	44 08 726 , 91166639 , 36402-00QAB
	1,9 DTI		08.2001		24.3727-0765.2	580765	CABLE FREIN A MAIN	44 08 726 , 91166639 , 36402-00QAB
	2,0 16V		08.2001		24.3727-0765.2	580765	CABLE FREIN A MAIN	44 08 726 , 91166639 , 36402-00QAB
	2,5 DTI		05.2003		24.3727-0765.2	580765	CABLE FREIN A MAIN	44 08 726 , 91166639 , 36402-00QAB







					description	Références OE par référence ATE.		Références remplacées / divers
--	--	--	--	--	-------------	----------------------------------	--	--------------------------------

PEUGEOT

BOXER (06-)	2,2 HDi (12/14)		04.2006		13.0460-4807.2	604807	PLAQUETTES DE FREIN	77364014 , 4253 55 , 4253 56	cf. Photo
	2,2 HDi (16H)		04.2006		13.0460-4810.2	604810	PLAQUETTES DE FREIN	77364318 , 77364015 , 4253 73 , 4253 74	cf. Photo
	2,2 HDi (16L)		04.2006		13.0460-4809.2	604809	PLAQUETTES DE FREIN	77364160 , 4253 57 , 4253 58	cf. Photo
	2,2 HDi (20)		04.2006		13.0460-4811.2	604811	PLAQUETTES DE FREIN	77364319 , 77364161 , 4253 75 , 4253 76	cf. Photo
	3,0 HDi (12/14)		04.2006		13.0460-4807.2	604807	PLAQUETTES DE FREIN	77364014 , 4253 55 , 4253 56	cf. Photo
	3,0 HDi (16H)		04.2006		13.0460-4810.2	604810	PLAQUETTES DE FREIN	77364318 , 77364015 , 4253 73 , 4253 74	cf. Photo
	3,0 HDi (16L)		04.2006		13.0460-4809.2	604809	PLAQUETTES DE FREIN	77364160 , 4253 57 , 4253 58	cf. Photo
	3,0 HDi (20)		04.2006		13.0460-4811.2	604811	PLAQUETTES DE FREIN	77364319 , 77364161 , 4253 75 , 4253 76	cf. Photo
BOXER Autobus/car (94-02)	1,9 D (10)			03.2002	24.3727-0350.2	580350	CABLE FREIN A MAIN	4745 V3	
	1,9 TD (10/14)			03.2002	24.3727-0350.2	580350	CABLE FREIN A MAIN	4745 V3	
	2,0 i (10/14/18)			03.2002	24.3727-0350.2	580350	CABLE FREIN A MAIN	4745 V3	
	2,5 D (14/18)			03.2002	24.3727-0350.2	580350	CABLE FREIN A MAIN	4745 V3	
	2,5 TD (14/18)			03.2002	24.3727-0350.2	580350	CABLE FREIN A MAIN	4745 V3	
	2,5 TDi (14/18)			03.2002	24.3727-0350.2	580350	CABLE FREIN A MAIN	4745 V3	
	2,8 HDi (14/18)			03.2002	24.3727-0350.2	580350	CABLE FREIN A MAIN	4745 V3	



				<p>description</p>	<p>Références OE par référence ATE.</p>	 <p>Références remplacées / divers</p>
---	---	--	---	--------------------	---	---

PORSCHE

CAYENNE (03-)	3,2		01.2005		24.0128-0169.1	428169	DISQUE DE FREIN	955 352 401 50 , 7L8 615 601 D , 7L8 615 601 A	
	4,5 S		01.2005		24.0128-0169.1	428169	DISQUE DE FREIN	955 352 401 50 , 7L8 615 601 D , 7L8 615 601 A	
	4,5 Turbo		01.2005		24.0128-0169.1	428169	DISQUE DE FREIN	955 352 401 50 , 7L8 615 601 D , 7L8 615 601 A	

Nouvelles références disponibles - par applications

07/2007



					description	Références OE par référence ATE.		Références remplacées / divers
--	--	--	--	--	-------------	----------------------------------	--	--------------------------------

RENAULT

CLIO III (BR_/CR_) (05-)	1,2 16V		06.2005		24.0220-3033.1	480195	TAMBOUR DE FREIN	82 00 276 843	
	1,4 16V		06.2005		24.0220-3033.1	480195	TAMBOUR DE FREIN	82 00 276 843	
	1,5 dCi		06.2005		24.0220-3033.1	480195	TAMBOUR DE FREIN	82 00 276 843	
KANGOO Express/Rapid Fourgonnette (FC_) (98-)	1,6 16V 4x4		10.2001		24.0112-0160.1	412160	DISQUE DE FREIN	77 01 207 227	
	1,9 dCi 4x4 (FC0V)		10.2001		24.0112-0160.1	412160	DISQUE DE FREIN	77 01 207 227	
KANGOO Berline (KC_) (98-)	1,6 16V 4x4		10.2001		24.0112-0160.1	412160	DISQUE DE FREIN	77 01 207 227	
	1,9 dCi 4x4 (KC0V)		10.2001		24.0112-0160.1	412160	DISQUE DE FREIN	77 01 207 227	
LOGAN (05-)	1,4		07.2005		24.0112-0171.1	412171	DISQUE DE FREIN	77 01 208 252 , 60 01 547 683 , 60 01 549 211	
	1,5 dCi		09.2005		24.0112-0171.1	412171	DISQUE DE FREIN	77 01 208 252 , 60 01 547 683 , 60 01 549 211	
	1,6		07.2005		24.0112-0171.1	412171	DISQUE DE FREIN	77 01 208 252 , 60 01 547 683 , 60 01 549 211	
MASTER II Autobus/car (JD/ND) (98-)	1,9 dCi 80	AvD	11.2003		24.3451-1716.7	220616	ETRIER A GRIFFE	77 01 208 013 , 41001-00QAE , 44 05 526 , 9121359	
	1,9 dTi	AvD	11.2003		24.3451-1716.7	220616	ETRIER A GRIFFE	77 01 208 013 , 41001-00QAE , 44 05 526 , 9121359	
	2,2 dCi 90	AvD	11.2003		24.3451-1716.7	220616	ETRIER A GRIFFE	77 01 208 013 , 41001-00QAE , 44 05 526 , 9121359	
	2,5 dCi 100	AvD	10.2003		24.3451-1716.7	220616	ETRIER A GRIFFE	77 01 208 013 , 41001-00QAE , 44 05 526 , 9121359	
	2,5 dCi 120	AvD	11.2003		24.3451-1716.7	220616	ETRIER A GRIFFE	77 01 208 013 , 41001-00QAE , 44 05 526 , 9121359	

Nouvelles références disponibles - par applications

07/2007









					description	Références OE par référence ATE.		Références remplacées / divers
--	--	--	--	--	-------------	----------------------------------	--	--------------------------------

RENAULT

MASTER II Autobus/car (JD/ND) (98-)	3,0 dCi 140	AvD	10.2003		24.3451-1716.7	220616	ETRIER A GRIFFE	77 01 208 013 , 41001-00QAE , 44 05 526 , 9121359	
MASTER II Fourgonnette (FD_) (98-)	1,9 dCi 80	AvD	11.2003		24.3451-1716.7	220616	ETRIER A GRIFFE	77 01 208 013 , 41001-00QAE , 44 05 526 , 9121359	
	1,9 dTi	AvD	11.2003		24.3451-1716.7	220616	ETRIER A GRIFFE	77 01 208 013 , 41001-00QAE , 44 05 526 , 9121359	
	2,2 dCi 90	AvD	11.2003		24.3451-1716.7	220616	ETRIER A GRIFFE	77 01 208 013 , 41001-00QAE , 44 05 526 , 9121359	
	2,5 dCi 100	AvD	10.2003		24.3451-1716.7	220616	ETRIER A GRIFFE	77 01 208 013 , 41001-00QAE , 44 05 526 , 9121359	
	2,5 dCi 120	AvD	11.2003		24.3451-1716.7	220616	ETRIER A GRIFFE	77 01 208 013 , 41001-00QAE , 44 05 526 , 9121359	
	3,0 dCi 120	AvD	06.2005		24.3451-1716.7	220616	ETRIER A GRIFFE	77 01 208 013 , 41001-00QAE , 44 05 526 , 9121359	
	3,0 dCi 140	AvD	10.2003		24.3451-1716.7	220616	ETRIER A GRIFFE	77 01 208 013 , 41001-00QAE , 44 05 526 , 9121359	
	3,0 dCi 160	AvD	06.2005		24.3451-1716.7	220616	ETRIER A GRIFFE	77 01 208 013 , 41001-00QAE , 44 05 526 , 9121359	
MASTER II Camion-plateau/Châssis (ED/HD/UD) (98-)	2,2 dCi 90	AvD	11.2003		24.3451-1716.7	220616	ETRIER A GRIFFE	77 01 208 013 , 41001-00QAE , 44 05 526 , 9121359	
	2,5 dCi 100	AvD	10.2003		24.3451-1716.7	220616	ETRIER A GRIFFE	77 01 208 013 , 41001-00QAE , 44 05 526 , 9121359	
	2,5 dCi 120	AvD	11.2003		24.3451-1716.7	220616	ETRIER A GRIFFE	77 01 208 013 , 41001-00QAE , 44 05 526 , 9121359	
	3,0 dCi 120	AvD	06.2005		24.3451-1716.7	220616	ETRIER A GRIFFE	77 01 208 013 , 41001-00QAE , 44 05 526 , 9121359	



					description	Références OE par référence ATE.	 Références remplacées / divers
---	---	---	---	---	-------------	----------------------------------	--

RENAULT

MASTER II Camion-plateau/Châssis (ED/HD/UD) (98-)	3,0 dCi 140	AvD	10.2003		24.3451-1716.7	220616	ETRIER A GRIFFE	77 01 208 013 , 41001-00QAE , 44 05 526 , 9121359	
	3,0 dCi 160	AvD	06.2005		24.3451-1716.7	220616	ETRIER A GRIFFE	77 01 208 013 , 41001-00QAE , 44 05 526 , 9121359	
MEGANE II COUPE/DECAPOTABLE (EM_) (03-)	1,5 dCi	AvG	10.2005		11.9541-9545.2	220625	ETRIER A GRIFFE	77 01 065 266	
		AvD	10.2005		11.9541-9546.2	220626	ETRIER A GRIFFE	77 01 065 267	
	1,6 16V	AvG	10.2005		11.9541-9545.2	220625	ETRIER A GRIFFE	77 01 065 266	
		AvD	10.2005		11.9541-9546.2	220626	ETRIER A GRIFFE	77 01 065 267	
	1,9 dCi	AvG	10.2005		11.9541-9545.2	220625	ETRIER A GRIFFE	77 01 065 266	
		AvD	10.2005		11.9541-9546.2	220626	ETRIER A GRIFFE	77 01 065 267	
	2,0 16V	AvD	10.2005		11.9541-9546.2	220626	ETRIER A GRIFFE	77 01 065 267	
		AvG	10.2005		11.9541-9545.2	220625	ETRIER A GRIFFE	77 01 065 266	
	2,0 dCi	AvD	09.2005		11.9541-9546.2	220626	ETRIER A GRIFFE	77 01 065 267	
		AvG	09.2005		11.9541-9545.2	220625	ETRIER A GRIFFE	77 01 065 266	
MEGANE II GRANDTOUR (KM_) (03-)	1,4 16V	AvG	10.2005		11.9541-9545.2	220625	ETRIER A GRIFFE	77 01 065 266	
		AvD	10.2005		11.9541-9546.2	220626	ETRIER A GRIFFE	77 01 065 267	
	1,5 dCi	AvG	10.2005		11.9541-9545.2	220625	ETRIER A GRIFFE	77 01 065 266	
		AvD	10.2005		11.9541-9546.2	220626	ETRIER A GRIFFE	77 01 065 267	
	1,6 16V	AvG	10.2005		11.9541-9545.2	220625	ETRIER A GRIFFE	77 01 065 266	
		AvD	10.2005		11.9541-9546.2	220626	ETRIER A GRIFFE	77 01 065 267	

Nouvelles références disponibles - par applications

07/2007



					description	Références OE par référence ATE.		Références remplacées / divers
--	--	--	--	--	-------------	----------------------------------	--	--------------------------------







RENAULT

MEGANE II GRANDTOUR (KM_) (03-)	1,9 dCi	AvG	10.2005		11.9541-9545.2	220625	ETRIER A GRIFFE	77 01 065 266	
		AvD	10.2005		11.9541-9546.2	220626	ETRIER A GRIFFE	77 01 065 267	
	2,0 16V	AvD	10.2005		11.9541-9546.2	220626	ETRIER A GRIFFE	77 01 065 267	
		AvG	10.2005		11.9541-9545.2	220625	ETRIER A GRIFFE	77 01 065 266	
	2,0 dCi	AvG	09.2005		11.9541-9545.2	220625	ETRIER A GRIFFE	77 01 065 266	
		AvD	09.2005		11.9541-9546.2	220626	ETRIER A GRIFFE	77 01 065 267	
MEGANE II Berline 3/5-portes (BM_/CM_) (02-)	1,4 16V	AvG	10.2005		11.9541-9545.2	220625	ETRIER A GRIFFE	77 01 065 266	
		AvD	10.2005		11.9541-9546.2	220626	ETRIER A GRIFFE	77 01 065 267	
	1,5 dCi	AvG	10.2005		11.9541-9545.2	220625	ETRIER A GRIFFE	77 01 065 266	
		AvD	10.2005		11.9541-9546.2	220626	ETRIER A GRIFFE	77 01 065 267	
	1,6 16V	AvG	10.2005		11.9541-9545.2	220625	ETRIER A GRIFFE	77 01 065 266	
		AvD	10.2005		11.9541-9546.2	220626	ETRIER A GRIFFE	77 01 065 267	
	1,9 dCi	AvG	10.2005		11.9541-9545.2	220625	ETRIER A GRIFFE	77 01 065 266	
		AvD	10.2005		11.9541-9546.2	220626	ETRIER A GRIFFE	77 01 065 267	
	2,0 16V	AvG	10.2005		11.9541-9545.2	220625	ETRIER A GRIFFE	77 01 065 266	
		AvD	10.2005		11.9541-9546.2	220626	ETRIER A GRIFFE	77 01 065 267	
	2,0 dCi	AvD	09.2005		11.9541-9546.2	220626	ETRIER A GRIFFE	77 01 065 267	
		AvG	09.2005		11.9541-9545.2	220625	ETRIER A GRIFFE	77 01 065 266	
MEGANE II Berline 4-portes (LM_) (03-)	1,5 dCi	AvD	10.2005		11.9541-9546.2	220626	ETRIER A GRIFFE	77 01 065 267	

Nouvelles références disponibles - par applications

07/2007









					description	Références OE par référence ATE.		Références remplacées / divers
---	---	---	---	---	-------------	----------------------------------	---	--------------------------------

RENAULT

MEGANE II Berline 4-portes (LM_) (03-)	1,5 dCi	AvG	10.2005		11.9541-9545.2	220625	ETRIER A GRIFFE	77 01 065 266	
	1,6 16V	AvG	10.2005		11.9541-9545.2	220625	ETRIER A GRIFFE	77 01 065 266	
		AvD	10.2005		11.9541-9546.2	220626	ETRIER A GRIFFE	77 01 065 267	
	1,9 dCi	AvD	10.2005		11.9541-9546.2	220626	ETRIER A GRIFFE	77 01 065 267	
		AvG	10.2005		11.9541-9545.2	220625	ETRIER A GRIFFE	77 01 065 266	
	2,0 16V	AvG	10.2005		11.9541-9545.2	220625	ETRIER A GRIFFE	77 01 065 266	
		AvD	10.2005		11.9541-9546.2	220626	ETRIER A GRIFFE	77 01 065 267	
MODUS (04-)	1,2 16V		05.2005		24.0220-3033.1	480195	TAMBOUR DE FREIN	82 00 276 843	
			08.2004		24.0220-3033.1	480195	TAMBOUR DE FREIN	82 00 276 843	
	1,5 dCi		08.2004		24.0220-3033.1	480195	TAMBOUR DE FREIN	82 00 276 843	
SCENIC II (JM_) (03-)	1,4 16V	AvD	10.2005		11.9541-9546.2	220626	ETRIER A GRIFFE	77 01 065 267	
		AvG	10.2005		11.9541-9545.2	220625	ETRIER A GRIFFE	77 01 065 266	
	1,5 dCi	AvG	10.2005		11.9541-9545.2	220625	ETRIER A GRIFFE	77 01 065 266	
		AvD	10.2005		11.9541-9546.2	220626	ETRIER A GRIFFE	77 01 065 267	
	1,6 16V	AvG	10.2005		11.9541-9545.2	220625	ETRIER A GRIFFE	77 01 065 266	
		AvD	10.2005		11.9541-9546.2	220626	ETRIER A GRIFFE	77 01 065 267	
TWINGO I Kasten (S06_) (93-)	1,2 (8)		11.2003		24.0112-0171.1	412171	DISQUE DE FREIN	77 01 208 252 , 60 01 547 683 , 60 01 549 211	
TWINGO I Limousine (C06_) (93-)			09.2000		24.0112-0171.1	412171	DISQUE DE FREIN	77 01 208 252 , 60 01 547 683 , 60 01 549 211	



		 		<p>description</p>	<p>Références OE par référence ATE.</p>	 <p>Références remplacées / divers</p>
---	---	---	---	--------------------	---	---

RENAULT

Modèle	Version	Date	ATE Ref. 1	ATE Ref. 2	Description	Références OE par référence ATE.	Références remplacées / divers
TWINGO I Limousine (C06_) (93-)	1,2 (G)	11.2003	24.0112-0171.1	412171	DISQUE DE FREIN	77 01 208 252 , 60 01 547 683 , 60 01 549 211	
	1,2 16V	11.2003	24.0112-0171.1	412171	DISQUE DE FREIN	77 01 208 252 , 60 01 547 683 , 60 01 549 211	
		08.2004	24.0112-0171.1	412171	DISQUE DE FREIN	77 01 208 252 , 60 01 547 683 , 60 01 549 211	

Nouvelles références disponibles - par applications

07/2007



					description	Références OE par référence ATE.		Références remplacées / divers
--	--	--	--	--	-------------	----------------------------------	--	--------------------------------







SAAB

9000 (85-93)	2,0 16V	ArG	09.1986	08.1989	24.3727-1105.2	581105	CABLE FREIN A MAIN	8967481 , 8967630	
		ArG	09.1989	08.1993	24.3727-1105.2	581105	CABLE FREIN A MAIN	8967481 , 8967630	
	2,0 16V Turbo	ArG	09.1986	08.1989	24.3727-1105.2	581105	CABLE FREIN A MAIN	8967481 , 8967630	
		ArG	09.1989	08.1993	24.3727-1105.2	581105	CABLE FREIN A MAIN	8967481 , 8967630	
	2,3 16V	ArG	09.1989	08.1993	24.3727-1105.2	581105	CABLE FREIN A MAIN	8967481 , 8967630	
	2,3 16V Turbo	ArG	09.1989	08.1993	24.3727-1105.2	581105	CABLE FREIN A MAIN	8967481 , 8967630	
9000 (94-98)	2,0 16V	ArG	09.1993	08.1996	24.3727-1105.2	581105	CABLE FREIN A MAIN	8967481 , 8967630	
	2,0 16V Turbo	ArG	09.1993	08.1996	24.3727-1105.2	581105	CABLE FREIN A MAIN	8967481 , 8967630	
	2,3 16V	ArG	09.1993	08.1996	24.3727-1105.2	581105	CABLE FREIN A MAIN	8967481 , 8967630	
	2,3 16V Turbo	ArG	09.1993	08.1996	24.3727-1105.2	581105	CABLE FREIN A MAIN	8967481 , 8967630	
	3,0 V6	ArG	09.1994	08.1996	24.3727-1105.2	581105	CABLE FREIN A MAIN	8967481 , 8967630	
9-3 Décapotable (YS3D) (98-03)	2,0 i	AvG		07.2003	24.3571-1725.5	240313	ETRIER A GRIFFE	5055413 , 5084710	
		AvG	01.1999	07.2003	24.3571-1725.5	240313	ETRIER A GRIFFE	5055413 , 5084710	
	2,0 SE Turbo	AvG		07.2003	24.3571-1725.5	240313	ETRIER A GRIFFE	5055413 , 5084710	
		AvG	01.1999	07.2003	24.3571-1725.5	240313	ETRIER A GRIFFE	5055413 , 5084710	
	2,0 T	AvG	10.1999	07.2003	24.3571-1725.5	240313	ETRIER A GRIFFE	5055413 , 5084710	
		AvG	01.1999	07.2003	24.3571-1725.5	240313	ETRIER A GRIFFE	5055413 , 5084710	
		AvG		07.2003	24.3571-1725.5	240313	ETRIER A GRIFFE	5055413 , 5084710	
	2,0 Turbo	AvG	01.2001	07.2003	24.3571-1725.5	240313	ETRIER A GRIFFE	5055413 , 5084710	

Nouvelles références disponibles - par applications

07/2007



					description	Références OE par référence ATE.	 Références remplacées / divers
---	---	---	---	---	-------------	----------------------------------	--







SAAB

9-3 Décapotable (YS3D) (98-03)	2,3 i	AvG	10.1999	07.2003	24.3571-1725.5	240313	ETRIER A GRIFFE	5055413 , 5084710	
		AvG	01.1999	07.2003	24.3571-1725.5	240313	ETRIER A GRIFFE	5055413 , 5084710	
		AvG		07.2003	24.3571-1725.5	240313	ETRIER A GRIFFE	5055413 , 5084710	
9-3 Coupé (YS3D) (98-02)	2	AvG	01.1999	09.2002	24.3571-1725.5	240313	ETRIER A GRIFFE	5055413 , 5084710	
		AvG	01.2001	09.2002	24.3571-1725.5	240313	ETRIER A GRIFFE	5055413 , 5084710	
		AvG		09.2002	24.3571-1725.5	240313	ETRIER A GRIFFE	5055413 , 5084710	
	2,0 Turbo	AvG		09.2002	24.3571-1725.5	240313	ETRIER A GRIFFE	5055413 , 5084710	
		AvG	01.1999	09.2002	24.3571-1725.5	240313	ETRIER A GRIFFE	5055413 , 5084710	
	2,0 Turbo Sport	AvG	01.1999	09.2002	24.3571-1725.5	240313	ETRIER A GRIFFE	5055413 , 5084710	
		AvG		09.2002	24.3571-1725.5	240313	ETRIER A GRIFFE	5055413 , 5084710	
	2,2 TiD	AvG	01.1999	11.2000	24.3571-1725.5	240313	ETRIER A GRIFFE	5055413 , 5084710	
		AvG	11.2000	09.2002	24.3571-1725.5	240313	ETRIER A GRIFFE	5055413 , 5084710	
		AvG		11.2000	24.3571-1725.5	240313	ETRIER A GRIFFE	5055413 , 5084710	
	2,3	AvG		09.2002	24.3571-1725.5	240313	ETRIER A GRIFFE	5055413 , 5084710	
		AvG	01.1999	09.2002	24.3571-1725.5	240313	ETRIER A GRIFFE	5055413 , 5084710	
	2,3 Viggen	AvG	10.1998	09.2002	24.3571-1725.5	240313	ETRIER A GRIFFE	5055413 , 5084710	
9-3 Berline (YS3D) (98-02)	2,0 i	AvG	01.1999	09.2002	24.3571-1725.5	240313	ETRIER A GRIFFE	5055413 , 5084710	
		AvG		09.2002	24.3571-1725.5	240313	ETRIER A GRIFFE	5055413 , 5084710	
	2,0 SE Turbo	AvG	01.1999	09.2002	24.3571-1725.5	240313	ETRIER A GRIFFE	5055413 , 5084710	

Nouvelles références disponibles - par applications

07/2007



					description	Références OE par référence ATE.		Références remplacées / divers
---	---	---	---	---	-------------	----------------------------------	---	--------------------------------

SAAB

9-3 Berline (YS3D) (98-02)	2,0 SE Turbo	AvG		09.2002	24.3571-1725.5	240313	ETRIER A GRIFFE	5055413 , 5084710	
	2,0 Turbo	AvG	10.1999	09.2002	24.3571-1725.5	240313	ETRIER A GRIFFE	5055413 , 5084710	
		AvG	01.1999	09.2002	24.3571-1725.5	240313	ETRIER A GRIFFE	5055413 , 5084710	
		AvG		09.2002	24.3571-1725.5	240313	ETRIER A GRIFFE	5055413 , 5084710	
	2,2 TiD	AvG		09.2002	24.3571-1725.5	240313	ETRIER A GRIFFE	5055413 , 5084710	
		AvG		11.2000	24.3571-1725.5	240313	ETRIER A GRIFFE	5055413 , 5084710	
		AvG	11.2000	08.2002	24.3571-1725.5	240313	ETRIER A GRIFFE	5055413 , 5084710	
		AvG	01.1999	11.2000	24.3571-1725.5	240313	ETRIER A GRIFFE	5055413 , 5084710	
	2,3 i	AvG		09.2002	24.3571-1725.5	240313	ETRIER A GRIFFE	5055413 , 5084710	
		AvG	01.1999	09.2002	24.3571-1725.5	240313	ETRIER A GRIFFE	5055413 , 5084710	
	2,3 Viggen	AvG	10.1998	09.2002	24.3571-1725.5	240313	ETRIER A GRIFFE	5055413 , 5084710	
9-5 Break (YS3E) (98-)	1,9 TiD		01.2006		24.3727-1108.2	581108	CABLE FREIN A MAIN	5059829	
	2,0 t	AvG	01.1999	12.2001	24.3571-1725.5	240313	ETRIER A GRIFFE	5055413 , 5084710	
		AvG		12.2001	24.3571-1725.5	240313	ETRIER A GRIFFE	5055413 , 5084710	
			10.1998		24.3727-1108.2	581108	CABLE FREIN A MAIN	5059829	
	2,2 TiD		03.2002		24.3727-1108.2	581108	CABLE FREIN A MAIN	5059829	
	2,3 t	AvG		12.2001	24.3571-1725.5	240313	ETRIER A GRIFFE	5055413 , 5084710	
		AvG	01.1999	12.2001	24.3571-1725.5	240313	ETRIER A GRIFFE	5055413 , 5084710	
		AvG	01.2001	12.2001	24.3571-1725.5	240313	ETRIER A GRIFFE	5055413 , 5084710	

Nouvelles références disponibles - par applications

07/2007



					description	Références OE par référence ATE.		Références remplacées / divers
--	--	--	--	--	-------------	----------------------------------	--	--------------------------------

SAAB

9-5 Break (YS3E) (98-)	2,3 T		01.2006		24.3727-1108.2	581108	CABLE FREIN A MAIN	5059829	
			07.2003		24.3727-1108.2	581108	CABLE FREIN A MAIN	5059829	
			10.1998		24.3727-1108.2	581108	CABLE FREIN A MAIN	5059829	
			01.2001		24.3727-1108.2	581108	CABLE FREIN A MAIN	5059829	
	2,3 T Aero		10.1999	09.2001	24.3727-1108.2	581108	CABLE FREIN A MAIN	5059829	
			09.2001		24.3727-1108.2	581108	CABLE FREIN A MAIN	5059829	
	3,0 t	AvG		12.2001	24.3571-1725.5	240313	ETRIER A GRIFFE	5055413 , 5084710	
		AvG	01.1999	12.2001	24.3571-1725.5	240313	ETRIER A GRIFFE	5055413 , 5084710	
			10.1998		24.3727-1108.2	581108	CABLE FREIN A MAIN	5059829	
	3,0 TiD	AvG	07.2001	12.2001	24.3571-1725.5	240313	ETRIER A GRIFFE	5055413 , 5084710	
			07.2001		24.3727-1108.2	581108	CABLE FREIN A MAIN	5059829	
9-5 Berline (YS3E) (97-)	1,9 TiD		01.2006		24.3727-1108.2	581108	CABLE FREIN A MAIN	5059829	
	2,0 t	AvG		12.2001	24.3571-1725.5	240313	ETRIER A GRIFFE	5055413 , 5084710	
		AvG	01.1999	12.2001	24.3571-1725.5	240313	ETRIER A GRIFFE	5055413 , 5084710	
					24.3727-1108.2	581108	CABLE FREIN A MAIN	5059829	
	2,2 TiD		03.2002		24.3727-1108.2	581108	CABLE FREIN A MAIN	5059829	
	2,3 t	AvG	01.2001	12.2001	24.3571-1725.5	240313	ETRIER A GRIFFE	5055413 , 5084710	
		AvG	01.1999	12.2001	24.3571-1725.5	240313	ETRIER A GRIFFE	5055413 , 5084710	
		AvG		12.2001	24.3571-1725.5	240313	ETRIER A GRIFFE	5055413 , 5084710	

Nouvelles références disponibles - par applications

07/2007



					description	Références OE par référence ATE.		Références remplacées / divers
--	--	--	--	--	-------------	----------------------------------	--	--------------------------------

SAAB

9-5 Berline (YS3E) (97-)	2,3 T		07.2003		24.3727-1108.2	581108	CABLE FREIN A MAIN	5059829	
			11.2005		24.3727-1108.2	581108	CABLE FREIN A MAIN	5059829	
					24.3727-1108.2	581108	CABLE FREIN A MAIN	5059829	
	2,3 T Aero		10.1999	09.2001	24.3727-1108.2	581108	CABLE FREIN A MAIN	5059829	
			09.2001		24.3727-1108.2	581108	CABLE FREIN A MAIN	5059829	
	3,0 t	AvG		12.2001	24.3571-1725.5	240313	ETRIER A GRIFFE	5055413 , 5084710	
		AvG	01.1999	12.2001	24.3571-1725.5	240313	ETRIER A GRIFFE	5055413 , 5084710	
					24.3727-1108.2	581108	CABLE FREIN A MAIN	5059829	
	3,0 TiD	AvG	07.2001	12.2001	24.3571-1725.5	240313	ETRIER A GRIFFE	5055413 , 5084710	
			07.2001		24.3727-1108.2	581108	CABLE FREIN A MAIN	5059829	

Nouvelles références disponibles - par applications

07/2007



					description	Références OE par référence ATE.		Références remplacées / divers
--	--	--	--	--	-------------	----------------------------------	--	--------------------------------

TOYOTA

AVENSIS (03-)	1,6 i 16V		04.2003		24.0126-0139.1	426139	DISQUE DE FREIN	43512-05040	
	1,8 i 16V		04.2003		24.0126-0139.1	426139	DISQUE DE FREIN	43512-05040	
	2,0 i 16V		04.2003		24.0126-0139.1	426139	DISQUE DE FREIN	43512-05040	
AVENSIS (97-03)	1,6 i 16V (AT220)	ArD	09.1997	09.2000	24.3220-1726.3	020484	CYLINDRE DE ROUE	47550-05030 , 47550-05040	
		ArG	09.1997	09.2000	24.3220-1725.3	020483	CYLINDRE DE ROUE	47570-05030 , 47570-05040	
	1,8 i 16V (AT221)	ArD	09.1997	09.2000	24.3220-1726.3	020484	CYLINDRE DE ROUE	47550-05030 , 47550-05040	
		ArG	09.1997	09.2000	24.3220-1725.3	020483	CYLINDRE DE ROUE	47570-05030 , 47570-05040	
	2,0 D4-D (CDT221)	ArG	10.1999	02.2003	24.3220-1725.3	020483	CYLINDRE DE ROUE	47570-05030 , 47570-05040	
		ArD	10.1999	02.2003	24.3220-1726.3	020484	CYLINDRE DE ROUE	47550-05030 , 47550-05040	
	2,0 i 16V (ST220)	ArG	09.1997	09.2000	24.3220-1725.3	020483	CYLINDRE DE ROUE	47570-05030 , 47570-05040	
		ArD	09.1997	09.2000	24.3220-1726.3	020484	CYLINDRE DE ROUE	47550-05030 , 47550-05040	
	2,0 TD (CT220)	ArD	09.1997	02.2003	24.3220-1726.3	020484	CYLINDRE DE ROUE	47550-05030 , 47550-05040	
		ArG	09.1997	02.2003	24.3220-1725.3	020483	CYLINDRE DE ROUE	47570-05030 , 47570-05040	
AVENSIS VERSO (01-)	2,0 D4-D (CLM20)		08.2001		24.3727-1914.2	581914	CABLE FREIN A MAIN	46410-44050	
	2,0 VVTi (ACM20)		08.2001		24.3727-1914.2	581914	CABLE FREIN A MAIN	46410-44050	
CAMRY (01-05)	2,0 VVTi (ACV31)		12.2001	12.2005	24.0128-0190.1	428190	DISQUE DE FREIN	43512-33100 , 43512-28180 , 43512-28181	
	2,4 VVTi (ACV30)		12.2001	12.2005	24.0128-0190.1	428190	DISQUE DE FREIN	43512-33100 , 43512-28180 , 43512-28181	
	3,0 i V6 (MCV30)		12.2001	12.2005	24.0128-0190.1	428190	DISQUE DE FREIN	43512-33100 , 43512-28180 , 43512-28181	

Nouvelles références disponibles - par applications

07/2007



					description	Références OE par référence ATE.		Références remplacées / divers
--	--	--	--	--	-------------	----------------------------------	--	--------------------------------

TOYOTA

CELICA (99-)	1,8 VVTi (ZZT230)		08.2002		24.0125-0700.1	425700	DISQUE DE FREIN	43512-63010 , 43512-20710 , 43512-20711
	1,8 VVTi TS (ZZT231)		11.1999		24.0125-0700.1	425700	DISQUE DE FREIN	43512-63010 , 43512-20710 , 43512-20711
COROLLA VERSO (04-)	1,6 VVTi (ZNR10)		05.2004		24.0110-0320.1	410320	DISQUE DE FREIN	42431-0F010
	1,8 VVTi (ZNR11)		05.2004		24.0110-0320.1	410320	DISQUE DE FREIN	42431-0F010
	2,0 D-4D (CUR10)		05.2004		24.0110-0320.1	410320	DISQUE DE FREIN	42431-0F010
HIACE (95-)	2,0 (KLH12)		08.1995	04.1998	24.0128-0189.1	428189	DISQUE DE FREIN	43512-26140
	2,4 (RCH12/22)		08.1995	04.1998	24.0128-0189.1	428189	DISQUE DE FREIN	43512-26140
	2,4 D (LXH12/18)		08.1995	08.2001	24.0128-0189.1	428189	DISQUE DE FREIN	43512-26140
	2,4 TD (LXH12/22)		08.1995	08.2001	24.0128-0189.1	428189	DISQUE DE FREIN	43512-26140
	2,7 (RCH13/23)		04.1998		24.0128-0189.1	428189	DISQUE DE FREIN	43512-26140
HILUX (97-05)	2,4 D		08.1999	01.2002	24.0225-4018.1	480197	TAMBOUR DE FREIN	42431-35151
	2,5 D-4D		11.2001	07.2005	24.0225-4018.1	480197	TAMBOUR DE FREIN	42431-35151
PREVIA (00-)	2,0 D-4D (CLR30)		04.2003		24.0128-0190.1	428190	DISQUE DE FREIN	43512-33100 , 43512-28180 , 43512-28181
	2,4 VVTi (ACR30)		04.2003		24.0128-0190.1	428190	DISQUE DE FREIN	43512-33100 , 43512-28180 , 43512-28181
RAV4 I (94-00)	2,0 i 16V (SXA10)		12.1997	06.2000	24.3727-1913.2	581913	CABLE FREIN A MAIN	46410-42010
	2,0 i 16V (SXA10/11)		04.1994	06.2000	24.3727-1913.2	581913	CABLE FREIN A MAIN	46410-42010
RAV4 II (00-05)	1,8 VVTi		02.2001	10.2005	24.0109-0152.1	409152	DISQUE DE FREIN	42431-42041 , 42431-42040
	2,0 D-4D 4WD		09.2001	10.2005	24.0109-0152.1	409152	DISQUE DE FREIN	42431-42041 , 42431-42040

Nouvelles références disponibles - par applications

07/2007









					description	Références OE par référence ATE.		Références remplacées / divers
--	--	--	--	--	-------------	----------------------------------	--	--------------------------------

TOYOTA

RAV4 II (00-05)	2,0 VVTi 4WD		06.2000	10.2005	24.0109-0152.1	409152	DISQUE DE FREIN	42431-42041 , 42431-42040	
	2,0 VVTi 4WD (Nato)		06.2000	07.2003	24.0109-0152.1	409152	DISQUE DE FREIN	42431-42041 , 42431-42040	
	2,4 VVTi 4x4		08.2003	10.2005	24.0109-0152.1	409152	DISQUE DE FREIN	42431-42041 , 42431-42040	
STARLET (96-99)	1,3 i 16V (EP91)		01.1996	07.1999	24.3727-1913.2	581913	CABLE FREIN A MAIN	46410-42010	
YARIS (99-)	1,0 i 16V	ArD	08.1999	03.2003	24.3217-1722.3	020490	CYLINDRE DE ROUE	47550-52011	
		ArG	08.1999	03.2003	24.3217-1721.3	020489	CYLINDRE DE ROUE	47570-52011	
	1,3 i 16V	ArG	09.1999	10.2004	24.3217-1721.3	020489	CYLINDRE DE ROUE	47570-52011	
		ArD	09.1999	10.2004	24.3217-1722.3	020490	CYLINDRE DE ROUE	47550-52011	
	1,4 D-4D	ArD	12.2001	03.2003	24.3217-1722.3	020490	CYLINDRE DE ROUE	47550-52011	
		ArG	12.2001	03.2003	24.3217-1721.3	020489	CYLINDRE DE ROUE	47570-52011	
YARIS VERSO (99-)	1,3 i 16V	ArG	08.2000		24.3217-1721.3	020489	CYLINDRE DE ROUE	47570-52011	
		ArD	08.2000		24.3217-1722.3	020490	CYLINDRE DE ROUE	47550-52011	



		 		description	Références OE par référence ATE.	 Références remplacées / divers
---	---	---	---	-------------	--	---

VOLKSWAGEN

PHAETON (02-)	3,0 TDI		09.2004		24.0134-0100.1	434100	DISQUE DE FREIN	4E0 615 301 A , 4E0 615 301 P , 3D0 615 301 M , 4E0 615 301 G , 3D0 615 301 F , 4E0 615 301 J	
	3,2 V6		04.2002		24.0134-0100.1	434100	DISQUE DE FREIN	4E0 615 301 A , 4E0 615 301 P , 3D0 615 301 M , 4E0 615 301 G , 3D0 615 301 F , 4E0 615 301 J	
	4,2 V8		05.2003		24.0134-0100.1	434100	DISQUE DE FREIN	4E0 615 301 A , 4E0 615 301 P , 3D0 615 301 M , 4E0 615 301 G , 3D0 615 301 F , 4E0 615 301 J	
	5,0 V10 TDI		11.2002		24.0134-0100.1	434100	DISQUE DE FREIN	4E0 615 301 A , 4E0 615 301 P , 3D0 615 301 M , 4E0 615 301 G , 3D0 615 301 F , 4E0 615 301 J	
	6,0 W12		04.2002		24.0134-0100.1	434100	DISQUE DE FREIN	4E0 615 301 A , 4E0 615 301 P , 3D0 615 301 M , 4E0 615 301 G , 3D0 615 301 F , 4E0 615 301 J	

Nouvelles références disponibles - par applications

07/2007



					description	Références OE par référence ATE.		Références remplacées / divers
--	--	--	--	--	-------------	----------------------------------	--	--------------------------------

VOLVO

S40 I (95-03)	1,6	ArD		08.1999	24.3384-1744.5	240320	ETRIER A GRIFFE	8601978	
		ArG		12.2003	24.3384-1743.5	240319	ETRIER A GRIFFE	8601977	
		ArD		12.2003	24.3384-1744.5	240320	ETRIER A GRIFFE	8601978	
		ArG		08.1999	24.3384-1743.5	240319	ETRIER A GRIFFE	8601977	
	1,8 (1731)	ArG		08.1999	24.3384-1743.5	240319	ETRIER A GRIFFE	8601977	
		ArD		08.1999	24.3384-1744.5	240320	ETRIER A GRIFFE	8601978	
	1,8 (1783)	ArD		12.2003	24.3384-1744.5	240320	ETRIER A GRIFFE	8601978	
		ArG		12.2003	24.3384-1743.5	240319	ETRIER A GRIFFE	8601977	
	1,8 i (1834)	ArD	06.2001	12.2003	24.3384-1744.5	240320	ETRIER A GRIFFE	8601978	
		ArG		12.2003	24.3384-1743.5	240319	ETRIER A GRIFFE	8601977	
		ArD		12.2003	24.3384-1744.5	240320	ETRIER A GRIFFE	8601978	
		ArG	06.2001	12.2003	24.3384-1743.5	240319	ETRIER A GRIFFE	8601977	
	1,9 DI	ArD		07.2000	24.3384-1744.5	240320	ETRIER A GRIFFE	8601978	
		ArD	07.2000	12.2003	24.3384-1744.5	240320	ETRIER A GRIFFE	8601978	
		ArG	07.2000	12.2003	24.3384-1743.5	240319	ETRIER A GRIFFE	8601977	
		ArG		07.2000	24.3384-1743.5	240319	ETRIER A GRIFFE	8601977	
	1,9 T4	ArD		07.2000	24.3384-1744.5	240320	ETRIER A GRIFFE	8601978	
		ArG		07.2000	24.3384-1743.5	240319	ETRIER A GRIFFE	8601977	
	1,9 TD	ArD		08.1999	24.3384-1744.5	240320	ETRIER A GRIFFE	8601978	

Nouvelles références disponibles - par applications

07/2007



					description	Références OE par référence ATE.		Références remplacées / divers
--	--	--	--	--	-------------	----------------------------------	--	--------------------------------

VOLVO

S40 I (95-03)	1,9 TD	ArG		08.1999	24.3384-1743.5	240319	ETRIER A GRIFFE	8601977	
	2	ArD		08.1999	24.3384-1744.5	240320	ETRIER A GRIFFE	8601978	
		ArD		12.2003	24.3384-1744.5	240320	ETRIER A GRIFFE	8601978	
		ArG		08.1999	24.3384-1743.5	240319	ETRIER A GRIFFE	8601977	
		ArG		12.2003	24.3384-1743.5	240319	ETRIER A GRIFFE	8601977	
	2,0 T	ArD	07.2000	06.2001	24.3384-1744.5	240320	ETRIER A GRIFFE	8601978	
		ArD	06.2001	12.2003	24.3384-1744.5	240320	ETRIER A GRIFFE	8601978	
		ArD		07.2000	24.3384-1744.5	240320	ETRIER A GRIFFE	8601978	
		ArG		07.2000	24.3384-1743.5	240319	ETRIER A GRIFFE	8601977	
		ArG	07.2000	06.2001	24.3384-1743.5	240319	ETRIER A GRIFFE	8601977	
		ArG	06.2001	12.2003	24.3384-1743.5	240319	ETRIER A GRIFFE	8601977	
	2,0 T4	ArD	07.2000	12.2003	24.3384-1744.5	240320	ETRIER A GRIFFE	8601978	
		ArG	07.2000	12.2003	24.3384-1743.5	240319	ETRIER A GRIFFE	8601977	
V40 (95-04)	1,6	ArD		08.1999	24.3384-1744.5	240320	ETRIER A GRIFFE	8601978	
		ArD	03.1999	07.2003	24.3384-1744.5	240320	ETRIER A GRIFFE	8601978	
		ArG		08.1999	24.3384-1743.5	240319	ETRIER A GRIFFE	8601977	
		ArG	03.1999	07.2003	24.3384-1743.5	240319	ETRIER A GRIFFE	8601977	
	1,8 (1731)	ArD		08.1999	24.3384-1744.5	240320	ETRIER A GRIFFE	8601978	
		ArG		08.1999	24.3384-1743.5	240319	ETRIER A GRIFFE	8601977	

Nouvelles références disponibles - par applications

07/2007



					description	Références OE par référence ATE.		Références remplacées / divers
--	--	--	--	--	-------------	----------------------------------	--	--------------------------------

VOLVO

V40 (95-04)	1,8 (1783)	ArD	03.1999	07.2003	24.3384-1744.5	240320	ETRIER A GRIFFE	8601978	
		ArG	03.1999	07.2003	24.3384-1743.5	240319	ETRIER A GRIFFE	8601977	
	1,8 i (1834)	ArD	03.1998	07.2003	24.3384-1744.5	240320	ETRIER A GRIFFE	8601978	
		ArD	06.2001	07.2003	24.3384-1744.5	240320	ETRIER A GRIFFE	8601978	
		ArG	03.1998	07.2003	24.3384-1743.5	240319	ETRIER A GRIFFE	8601977	
		ArG	06.2001	07.2003	24.3384-1743.5	240319	ETRIER A GRIFFE	8601977	
	1,9 DI	ArD	07.2000	07.2003	24.3384-1744.5	240320	ETRIER A GRIFFE	8601978	
		ArD	03.1999	07.2000	24.3384-1744.5	240320	ETRIER A GRIFFE	8601978	
		ArG	03.1999	07.2000	24.3384-1743.5	240319	ETRIER A GRIFFE	8601977	
		ArG	07.2000	07.2003	24.3384-1743.5	240319	ETRIER A GRIFFE	8601977	
	1,9 T4	ArG		07.2000	24.3384-1743.5	240319	ETRIER A GRIFFE	8601977	
		ArD		07.2000	24.3384-1744.5	240320	ETRIER A GRIFFE	8601978	
	1,9 TD	ArD		08.1999	24.3384-1744.5	240320	ETRIER A GRIFFE	8601978	
		ArG		08.1999	24.3384-1743.5	240319	ETRIER A GRIFFE	8601977	
	2	ArG		07.2003	24.3384-1743.5	240319	ETRIER A GRIFFE	8601977	
		ArG		08.1999	24.3384-1743.5	240319	ETRIER A GRIFFE	8601977	
		ArD		07.2003	24.3384-1744.5	240320	ETRIER A GRIFFE	8601978	
		ArD		08.1999	24.3384-1744.5	240320	ETRIER A GRIFFE	8601978	
	2,0 T	ArG	07.2000	06.2001	24.3384-1743.5	240319	ETRIER A GRIFFE	8601977	

Nouvelles références disponibles - par applications

07/2007



					description	Références OE par référence ATE.		Références remplacées / divers
--	--	--	--	--	-------------	----------------------------------	--	--------------------------------

VOLVO

V40 (95-04)	2,0 T	ArG	06.2001	07.2003	24.3384-1743.5	240319	ETRIER A GRIFFE	8601977	
		ArG		07.2000	24.3384-1743.5	240319	ETRIER A GRIFFE	8601977	
		ArD	07.2000	06.2001	24.3384-1744.5	240320	ETRIER A GRIFFE	8601978	
		ArD		07.2000	24.3384-1744.5	240320	ETRIER A GRIFFE	8601978	
		ArD	06.2001	07.2003	24.3384-1744.5	240320	ETRIER A GRIFFE	8601978	
	2,0 T4	ArD	07.2000	04.2004	24.3384-1744.5	240320	ETRIER A GRIFFE	8601978	
		ArG	07.2000	04.2004	24.3384-1743.5	240319	ETRIER A GRIFFE	8601977	



13.0460-2723.2 602723

Applications:

- FORD GALAXY II (06-)
- FORD MONDEO IV (07-)
- FORD S-MAX (06-)

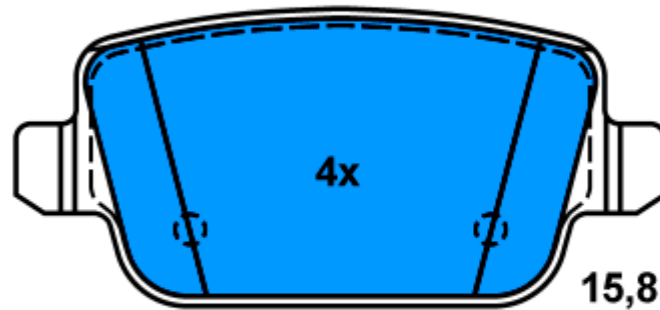
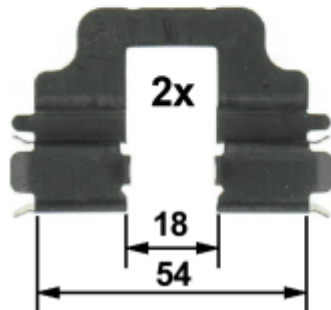
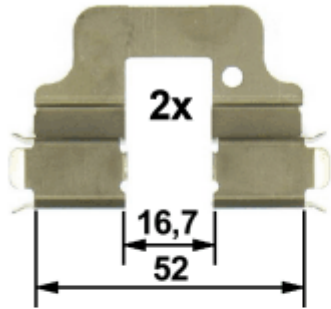

95,1 x 43,2



13.0460-4807.2 604807

Applications:

PEUGEOT BOXER (06-)
FIAT DUCATO (06-)
CITROEN JUMPER (06-)

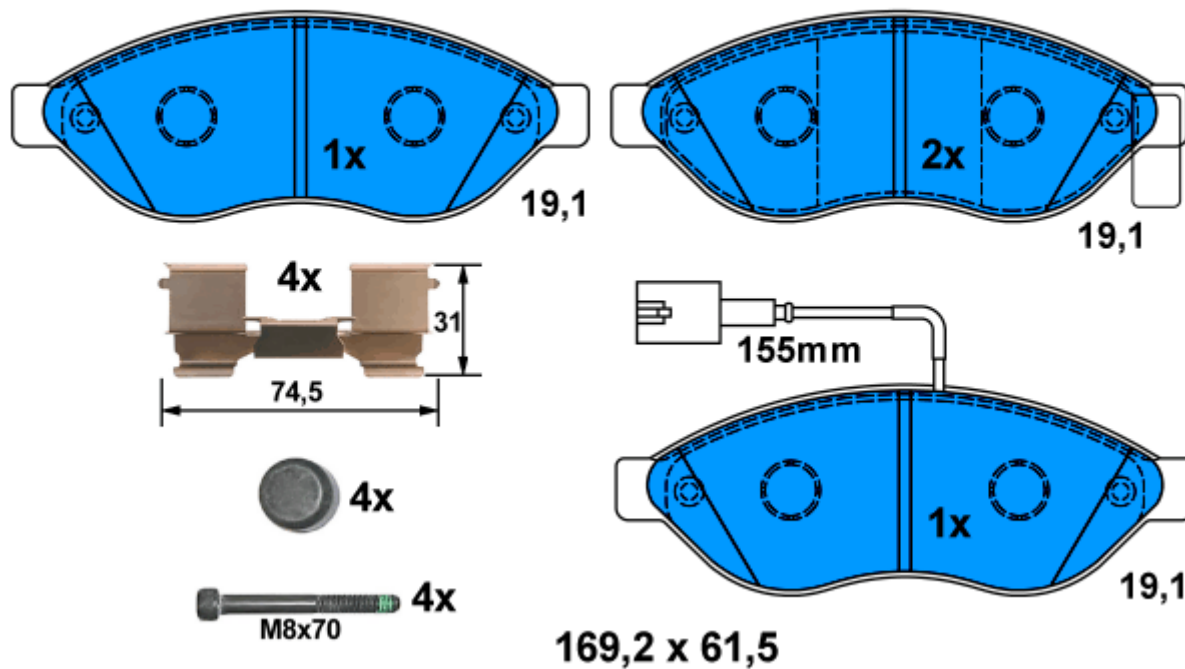



13.0460-4810.2 604810

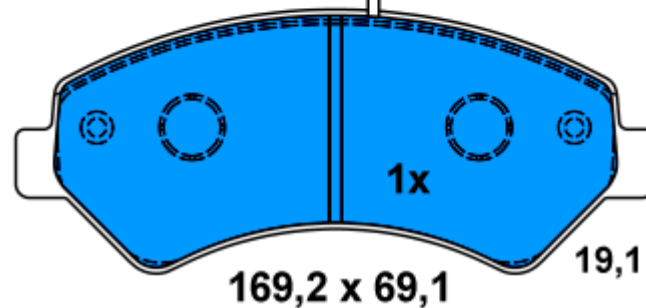
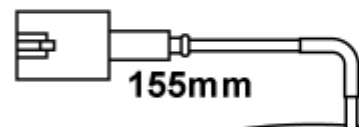
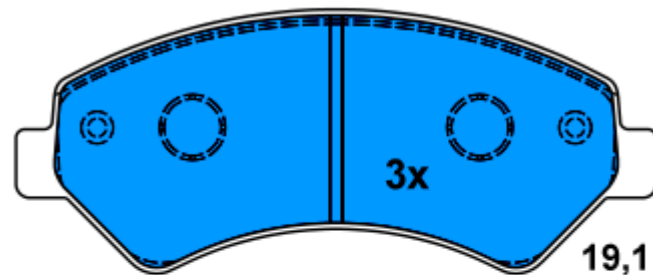
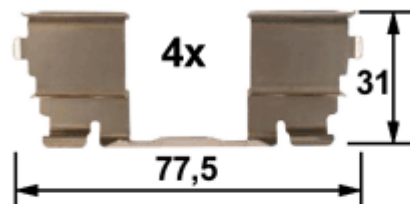

Applications:

PEUGEOT BOXER (06-)
FIAT DUCATO (06-)
CITROEN JUMPER (06-)



13.0460-4809.2 604809

Applications:

PEUGEOT BOXER (06-)
FIAT DUCATO (06-)
CITROEN JUMPER (06-)

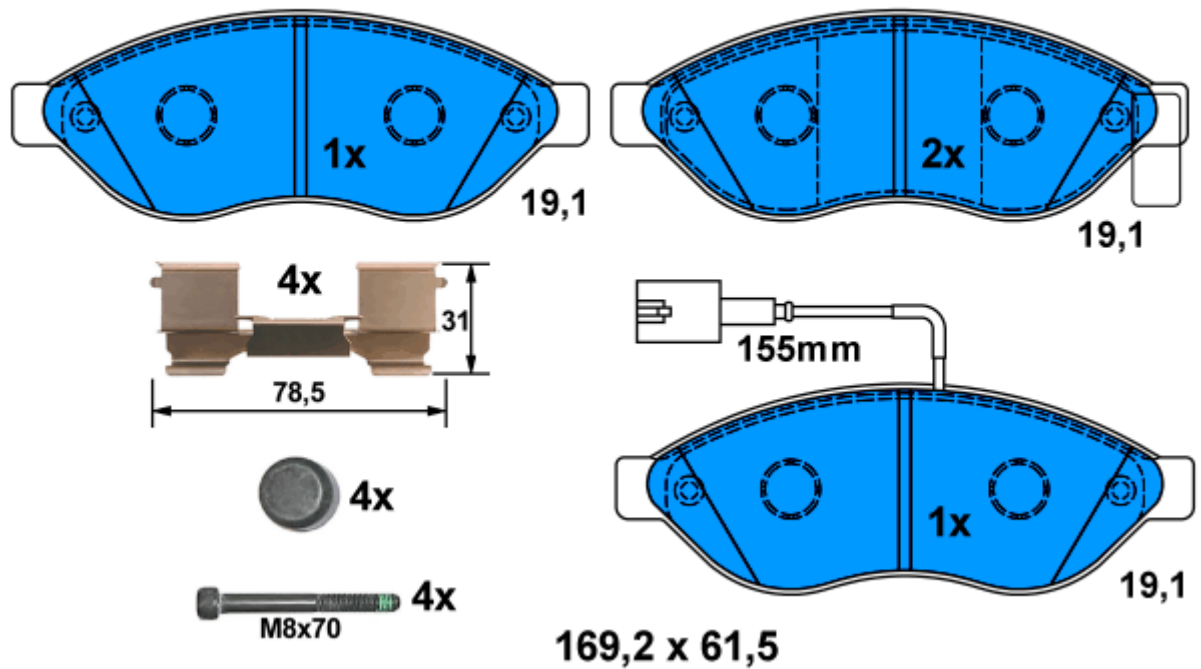



13.0460-4811.2 604811

Applications:

PEUGEOT BOXER (06-)
FIAT DUCATO (06-)
CITROEN JUMPER (06-)

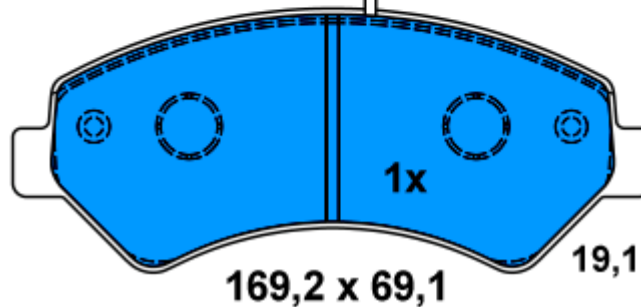
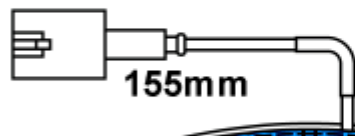
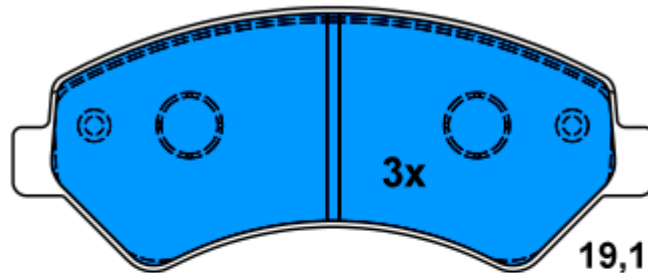
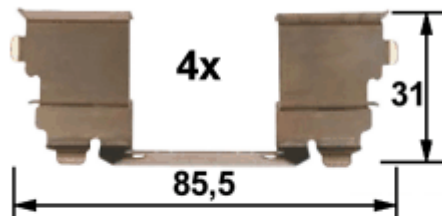



13.0460-5855.2 605855

Applications:

MITSUBISHI GRANDIS (04-)
MITSUBISHI PAJERO (00-)
MITSUBISHI PAJERO (05-)

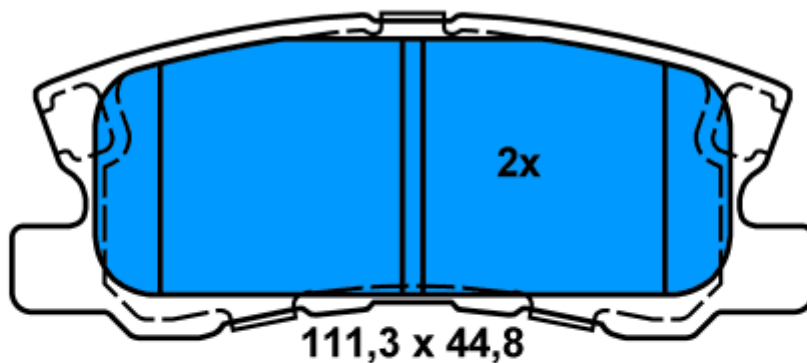

23582 16,0

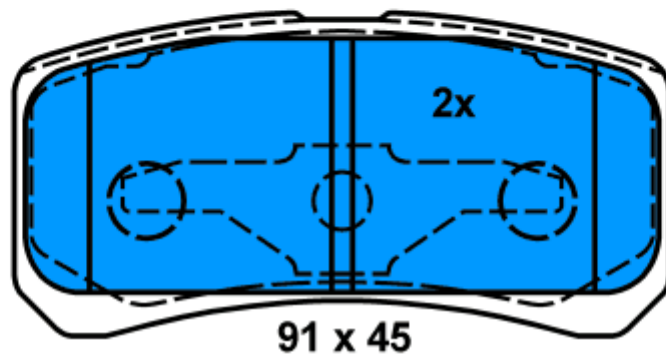

23583 16,1



13.0460-8009.2 608009

Applications:

CHRYSLER VOYAGER (ES) (91-95)

