

Nouvelles références disponibles
par applications



04/2007



www.ate.de

Nouvelles références disponibles - par applications

04/2007



					description	Références OE par référence ATE.		Références remplacées / divers
--	--	--	--	--	-------------	----------------------------------	--	--------------------------------

AUDI

A3 (96-03)	1,6		09.1996	06.2003	83.7838-0435.3	330834	FLEXIBLE FREIN	1J0 611 701	83.6238-0435.3
	1,8		09.1996	06.2003	83.7838-0435.3	330834	FLEXIBLE FREIN	1J0 611 701	83.6238-0435.3
	1,8 T		12.1996	06.2003	83.7838-0435.3	330834	FLEXIBLE FREIN	1J0 611 701	83.6238-0435.3
			12.1998	06.2003	83.7838-0435.3	330834	FLEXIBLE FREIN	1J0 611 701	83.6238-0435.3
	1,9 TDI		09.2000	06.2003	83.7838-0435.3	330834	FLEXIBLE FREIN	1J0 611 701	83.6238-0435.3
			09.1996	06.2001	83.7838-0435.3	330834	FLEXIBLE FREIN	1J0 611 701	83.6238-0435.3
			03.1997	06.2001	83.7838-0435.3	330834	FLEXIBLE FREIN	1J0 611 701	83.6238-0435.3
A4 (B6) (01-)	1,6				24.0112-0166.1	412166	DISQUE DE FREIN	8E0 615 601 M	
	1,8 T				24.0112-0166.1	412166	DISQUE DE FREIN	8E0 615 601 M	
	1,8 T Quattro				24.0112-0166.1	412166	DISQUE DE FREIN	8E0 615 601 M	
	1,9 TDI				24.0112-0166.1	412166	DISQUE DE FREIN	8E0 615 601 M	
	1,9 TDI Quattro				24.0112-0166.1	412166	DISQUE DE FREIN	8E0 615 601 M	
	2				24.0112-0166.1	412166	DISQUE DE FREIN	8E0 615 601 M	
	2,0 FSI				24.0112-0166.1	412166	DISQUE DE FREIN	8E0 615 601 M	
	2,0 TDI		06.2006		24.0112-0166.1	412166	DISQUE DE FREIN	8E0 615 601 M	
					24.0112-0166.1	412166	DISQUE DE FREIN	8E0 615 601 M	
	2,0 TDI Quattro		01.2006		24.0112-0166.1	412166	DISQUE DE FREIN	8E0 615 601 M	
			06.2006		24.0112-0166.1	412166	DISQUE DE FREIN	8E0 615 601 M	
	2,0 TFSI				24.0112-0166.1	412166	DISQUE DE FREIN	8E0 615 601 M	

Nouvelles références disponibles - par applications

04/2007



					description	Références OE par référence ATE.		Références remplacées / divers
--	--	--	--	--	-------------	----------------------------------	--	--------------------------------







AUDI

A4 (B6) (01-)	2,0 TFSI Quattro				24.0112-0166.1	412166	DISQUE DE FREIN	8E0 615 601 M	
	2,4				24.0112-0166.1	412166	DISQUE DE FREIN	8E0 615 601 M	
	2,5 TDI				24.0112-0166.1	412166	DISQUE DE FREIN	8E0 615 601 M	
	2,5 TDI Quattro				24.0112-0166.1	412166	DISQUE DE FREIN	8E0 615 601 M	
	2,7 TDI		01.2006		24.0112-0166.1	412166	DISQUE DE FREIN	8E0 615 601 M	
	3				24.0112-0166.1	412166	DISQUE DE FREIN	8E0 615 601 M	
	3,0 Quattro				24.0112-0166.1	412166	DISQUE DE FREIN	8E0 615 601 M	
	3,0 TDI Quattro				24.0112-0166.1	412166	DISQUE DE FREIN	8E0 615 601 M	
			01.2006		24.0112-0166.1	412166	DISQUE DE FREIN	8E0 615 601 M	
	3,2 FSI				24.0112-0166.1	412166	DISQUE DE FREIN	8E0 615 601 M	
	3,2 FSI Quattro				24.0112-0166.1	412166	DISQUE DE FREIN	8E0 615 601 M	
A4 DECAPOTABLE (02-)	1,8 T				24.0112-0166.1	412166	DISQUE DE FREIN	8E0 615 601 M	
	1,8 T Quattro				24.0112-0166.1	412166	DISQUE DE FREIN	8E0 615 601 M	
	2				24.0112-0166.1	412166	DISQUE DE FREIN	8E0 615 601 M	
	2,0 TDI				24.0112-0166.1	412166	DISQUE DE FREIN	8E0 615 601 M	
	2,0 TFSI				24.0112-0166.1	412166	DISQUE DE FREIN	8E0 615 601 M	
	2,4				24.0112-0166.1	412166	DISQUE DE FREIN	8E0 615 601 M	
	2,5 TDI				24.0112-0166.1	412166	DISQUE DE FREIN	8E0 615 601 M	
	2,7 TDI				24.0112-0166.1	412166	DISQUE DE FREIN	8E0 615 601 M	

Nouvelles références disponibles - par applications

04/2007



					<p>description</p>	<p>Références OE par référence ATE.</p>	 <p>Références remplacées / divers</p>
---	---	---	---	---	--------------------	---	---







AUDI

A4 DECAPOTABLE (02-)	3				24.0112-0166.1	412166	DISQUE DE FREIN	8E0 615 601 M	
	3,0 Quattro				24.0112-0166.1	412166	DISQUE DE FREIN	8E0 615 601 M	
	3,0 TDI Quattro		01.2006		24.0112-0166.1	412166	DISQUE DE FREIN	8E0 615 601 M	
					24.0112-0166.1	412166	DISQUE DE FREIN	8E0 615 601 M	
	3,2 FSI				24.0112-0166.1	412166	DISQUE DE FREIN	8E0 615 601 M	
	3,2 FSI Quattro				24.0112-0166.1	412166	DISQUE DE FREIN	8E0 615 601 M	

Nouvelles références disponibles - par applications

04/2007



						description	Références OE par référence ATE.		Références remplacées / divers
---	---	---	---	---	--	-------------	--	---	-----------------------------------

BMW

1502 - 2002 (65-77)	1600 2		01.1966	12.1968	83.7704-0290.3	330826	FLEXIBLE FREIN	34 32 1 108 133 , 34 32 1 116 515 , 34 32 1 189 882 , 34 32 4 650 315	83.6104-0290.3
	1600 2 ti		01.1967	12.1968	83.7704-0290.3	330826	FLEXIBLE FREIN	34 32 1 108 133 , 34 32 1 116 515 , 34 32 1 189 882 , 34 32 4 650 315	83.6104-0290.3
	2000		01.1966	12.1969	83.7704-0290.3	330826	FLEXIBLE FREIN	34 32 1 108 133 , 34 32 1 116 515 , 34 32 1 189 882 , 34 32 4 650 315	83.6104-0290.3
	2002		01.1968	12.1969	83.7704-0290.3	330826	FLEXIBLE FREIN	34 32 1 108 133 , 34 32 1 116 515 , 34 32 1 189 882 , 34 32 4 650 315	83.6104-0290.3
1er Reihe/E87 5-T?rer/E81 3-T?rer (04-)	116 i		09.2004		24.0110-0314.1	410314	DISQUE DE FREIN	34 21 6 764 647	
			09.2004		13.0460-2713.2	602713	PLAQUETTES DE FREIN	34 21 6 767 145 , 34 21 6 767 146	cf. Photo
	118 d		09.2004	03.2007	24.0110-0314.1	410314	DISQUE DE FREIN	34 21 6 764 647	
			03.2007		24.0122-0238.1	422238	DISQUE DE FREIN	34 11 6 764 641	
			09.2004	03.2007	13.0460-2713.2	602713	PLAQUETTES DE FREIN	34 21 6 767 145 , 34 21 6 767 146	cf. Photo
	118 i		09.2004	03.2007	24.0110-0314.1	410314	DISQUE DE FREIN	34 21 6 764 647	
			03.2007		24.0122-0238.1	422238	DISQUE DE FREIN	34 11 6 764 641	
			03.2007		13.0460-2713.2	602713	PLAQUETTES DE FREIN	34 21 6 767 145 , 34 21 6 767 146	cf. Photo
			09.2004	03.2007	13.0460-2713.2	602713	PLAQUETTES DE FREIN	34 21 6 767 145 , 34 21 6 767 146	cf. Photo
	120 d		09.2004	03.2007	24.0122-0238.1	422238	DISQUE DE FREIN	34 11 6 764 641	

Nouvelles références disponibles - par applications

04/2007



					description	Références OE par référence ATE.		Références remplacées / divers
--	--	--	--	--	-------------	----------------------------------	--	--------------------------------







BMW

1er Reihe/E87 5-T?rer/E81 3-T?rer (04-)	120 i		09.2004	03.2007	24.0122-0238.1	422238	DISQUE DE FREIN	34 11 6 764 641	
			03.2007		13.0460-2713.2	602713	PLAQUETTES DE FREIN	34 21 6 767 145 , 34 21 6 767 146	cf. Photo
			09.2004	03.2007	13.0460-2713.2	602713	PLAQUETTES DE FREIN	34 21 6 767 145 , 34 21 6 767 146	cf. Photo
Série 3/E90 Berline (05-)	316 i		01.2005		24.0122-0238.1	422238	DISQUE DE FREIN	34 11 6 764 641	
			01.2005		13.0460-2713.2	602713	PLAQUETTES DE FREIN	34 21 6 767 145 , 34 21 6 767 146	cf. Photo
	318 d		09.2005		24.0122-0238.1	422238	DISQUE DE FREIN	34 11 6 764 641	
			09.2005		13.0460-2713.2	602713	PLAQUETTES DE FREIN	34 21 6 767 145 , 34 21 6 767 146	cf. Photo
	318 i		09.2005		24.0122-0238.1	422238	DISQUE DE FREIN	34 11 6 764 641	
			09.2005		13.0460-2713.2	602713	PLAQUETTES DE FREIN	34 21 6 767 145 , 34 21 6 767 146	cf. Photo
	320 i		12.2004		24.0122-0238.1	422238	DISQUE DE FREIN	34 11 6 764 641	
			12.2004		13.0460-2713.2	602713	PLAQUETTES DE FREIN	34 21 6 767 145 , 34 21 6 767 146	cf. Photo

CHEVROLET

KALOS (05-)	1,2 i		03.2005		13.0460-5899.2	605899	PLAQUETTES DE FREIN	96534653	cf. Photo
	1,4 i		03.2005		13.0460-5899.2	605899	PLAQUETTES DE FREIN	96534653	cf. Photo
	1,4 i 16V		03.2005		13.0460-5899.2	605899	PLAQUETTES DE FREIN	96534653	cf. Photo



		 		<p>description</p>	<p>Références OE par référence ATE.</p>	 <p>Références remplacées / divers</p>
---	---	---	---	--------------------	---	---

CHRYSLER

Modèle	Version	Date	Code	Code	Description	Références OE	Références ATE	Notes
VOYAGER (RG) (00-)	2,4	02.2000	13.0460-2899.2	602899	PLAQUETTES DE FREIN	5066 427AA		cf. Photo
	2,5 CRD	02.2000	13.0460-2899.2	602899	PLAQUETTES DE FREIN	5066 427AA		cf. Photo
	2,8 CRD	06.2004	13.0460-2899.2	602899	PLAQUETTES DE FREIN	5066 427AA		cf. Photo
	3,3	02.2000	13.0460-2899.2	602899	PLAQUETTES DE FREIN	5066 427AA		cf. Photo
	3,3 AWD	02.2000	13.0460-2899.2	602899	PLAQUETTES DE FREIN	5066 427AA		cf. Photo
	3,8	02.2000	13.0460-2899.2	602899	PLAQUETTES DE FREIN	5066 427AA		cf. Photo
	3,8 AWD	02.2000	13.0460-2899.2	602899	PLAQUETTES DE FREIN	5066 427AA		cf. Photo

Nouvelles références disponibles - par applications

04/2007



					description	Références OE par référence ATE.		Références remplacées / divers
--	--	--	--	--	-------------	----------------------------------	--	--------------------------------

CITROEN

BERLINGO Break (96-)	1,6 16V	ArG	10.2000		24.3727-0349.2	580349	CABLE FREIN A MAIN	4745 Y0 , 4745 X2	
		ArD	10.2000		24.3727-0347.2	580347	CABLE FREIN A MAIN	4745 Y1 , 4745 X3	
	1,6 HDi 75	ArG	07.2005		24.3727-0349.2	580349	CABLE FREIN A MAIN	4745 Y0 , 4745 X2	
		ArD	07.2005		24.3727-0347.2	580347	CABLE FREIN A MAIN	4745 Y1 , 4745 X3	
	1,6 HDi 90	ArG	07.2005		24.3727-0349.2	580349	CABLE FREIN A MAIN	4745 Y0 , 4745 X2	
		ArD	07.2005		24.3727-0347.2	580347	CABLE FREIN A MAIN	4745 Y1 , 4745 X3	
	2,0 HDi	ArG	12.2000		24.3727-0349.2	580349	CABLE FREIN A MAIN	4745 Y0 , 4745 X2	
		ArD	12.2000		24.3727-0347.2	580347	CABLE FREIN A MAIN	4745 Y1 , 4745 X3	
C5 Break (01-)	1,8 16V	AvD	06.2001		24.3572-1708.7	220620	ETRIER A GRIFFE	4400 L7	
		AvG	06.2001		24.3572-1707.7	220619	ETRIER A GRIFFE	4400 L6	
	2,0 16V	AvG	06.2001		24.3572-1707.7	220619	ETRIER A GRIFFE	4400 L6	
		AvD	06.2001		24.3572-1708.7	220620	ETRIER A GRIFFE	4400 L7	
	2,0 HDi 110	AvG	06.2001		24.3572-1707.7	220619	ETRIER A GRIFFE	4400 L6	
		AvD	06.2001		24.3572-1708.7	220620	ETRIER A GRIFFE	4400 L7	
	2,0 HDi 90	AvG	06.2001		24.3572-1707.7	220619	ETRIER A GRIFFE	4400 L6	
		AvD	06.2001		24.3572-1708.7	220620	ETRIER A GRIFFE	4400 L7	
C5 Berline (01-)	2,0 16V	AvD	03.2001		24.3572-1708.7	220620	ETRIER A GRIFFE	4400 L7	
		AvG	03.2001		24.3572-1707.7	220619	ETRIER A GRIFFE	4400 L6	
	2,0 HDi 110	AvD	03.2001		24.3572-1708.7	220620	ETRIER A GRIFFE	4400 L7	

Nouvelles références disponibles - par applications

04/2007



					description	Références OE par référence ATE.		Références remplacées / divers
--	--	--	--	--	-------------	----------------------------------	--	--------------------------------

CITROEN

C5 Berline (01-)	2,0 HDi 110	AvG	03.2001		24.3572-1707.7	220619	ETRIER A GRIFFE	4400 L6	
	2,0 HDi 90	AvD	03.2001		24.3572-1708.7	220620	ETRIER A GRIFFE	4400 L7	
		AvG	03.2001		24.3572-1707.7	220619	ETRIER A GRIFFE	4400 L6	
C5 II Break (04-)	1,6 HDi	AvG	09.2004		24.3572-1707.7	220619	ETRIER A GRIFFE	4400 L6	
		AvD	09.2004		24.3572-1708.7	220620	ETRIER A GRIFFE	4400 L7	
	1,8 16V	AvG	09.2005		24.3572-1707.7	220619	ETRIER A GRIFFE	4400 L6	
		AvG	09.2004		24.3572-1707.7	220619	ETRIER A GRIFFE	4400 L6	
		AvD	09.2005		24.3572-1708.7	220620	ETRIER A GRIFFE	4400 L7	
		AvD	09.2004		24.3572-1708.7	220620	ETRIER A GRIFFE	4400 L7	
	2,0 16V	AvG	09.2004		24.3572-1707.7	220619	ETRIER A GRIFFE	4400 L6	
		AvD	09.2004		24.3572-1708.7	220620	ETRIER A GRIFFE	4400 L7	
C5 II Berline (04-)	1,6 HDi	AvD	09.2004		24.3572-1708.7	220620	ETRIER A GRIFFE	4400 L7	
		AvG	09.2004		24.3572-1707.7	220619	ETRIER A GRIFFE	4400 L6	
	2,0 16V	AvD	09.2004		24.3572-1708.7	220620	ETRIER A GRIFFE	4400 L7	
		AvG	09.2004		24.3572-1707.7	220619	ETRIER A GRIFFE	4400 L6	
JUMPER (02-06)	2,0 HDi (10/14/18)		04.2002		03.0137-4002.2	654002	JEU DE MACHOIRE	77362699 , 77363478 , 4241 NO , 77362696 , 77363479 , 4241 L9	
				03.2006	03.0137-4002.2	654002	JEU DE MACHOIRE	77362699 , 77363478 , 4241 NO , 77362696 , 77363479 , 4241 L9	
			04.2002		24.3727-0348.2	580348	CABLE FREIN A MAIN	4745 V4	

Nouvelles références disponibles - par applications

04/2007



					description	Références OE par référence ATE.		Références remplacées / divers
--	--	--	--	--	-------------	----------------------------------	--	--------------------------------

CITROEN

JUMPER (02-06)	2,0 i (10/14/18)			03.2006	03.0137-4002.2	654002	JEU DE MACHOIRE	77362699 , 77363478 , 4241 NO , 77362696 , 77363479 , 4241 L9	
			04.2002		03.0137-4002.2	654002	JEU DE MACHOIRE	77362699 , 77363478 , 4241 NO , 77362696 , 77363479 , 4241 L9	
			04.2002		24.3727-0348.2	580348	CABLE FREIN A MAIN	4745 V4	
	2,2 HDi (10/14/18)			03.2006	03.0137-4002.2	654002	JEU DE MACHOIRE	77362699 , 77363478 , 4241 NO , 77362696 , 77363479 , 4241 L9	
			04.2002		03.0137-4002.2	654002	JEU DE MACHOIRE	77362699 , 77363478 , 4241 NO , 77362696 , 77363479 , 4241 L9	
			04.2002		24.3727-0348.2	580348	CABLE FREIN A MAIN	4745 V4	
	2,8 HDi (10/14/18)			03.2006	03.0137-4002.2	654002	JEU DE MACHOIRE	77362699 , 77363478 , 4241 NO , 77362696 , 77363479 , 4241 L9	
			04.2002		03.0137-4002.2	654002	JEU DE MACHOIRE	77362699 , 77363478 , 4241 NO , 77362696 , 77363479 , 4241 L9	
			04.2002		24.3727-0348.2	580348	CABLE FREIN A MAIN	4745 V4	
	2,8 HDi 4x4(10/14/18)		04.2002		24.3727-0348.2	580348	CABLE FREIN A MAIN	4745 V4	
JUMPER Autobus/car (94-02)	1,9 TD 4x4 (10/14)	08.1996	03.2002		24.3727-0842.2	580842	CABLE FREIN A MAIN	4745 J2	
	2,0 i 4x4 (10/14/18)	08.1996	03.2002		24.3727-0842.2	580842	CABLE FREIN A MAIN	4745 J2	
	2,5 D 4x4 (14/18)	08.1996	03.2002		24.3727-0842.2	580842	CABLE FREIN A MAIN	4745 J2	
	2,5 TD 4x4 (14/18)	08.1996	03.2002		24.3727-0842.2	580842	CABLE FREIN A MAIN	4745 J2	

Nouvelles références disponibles - par applications

04/2007



					description	Références OE par référence ATE.		Références remplacées / divers
--	--	--	--	--	-------------	----------------------------------	--	--------------------------------







CITROEN

JUMPER Autobus/car (94-02)	2,5 TDi 4x4 (14/18)		12.1996	11.2000	24.3727-0842.2	580842	CABLE FREIN A MAIN	4745 J2	
	2,8 HDi 4x4 (14/18)		09.2000	03.2002	24.3727-0842.2	580842	CABLE FREIN A MAIN	4745 J2	
JUMPER Fourgonnette (94-02)	1,9 D (10)			03.2002	24.3727-0348.2	580348	CABLE FREIN A MAIN	4745 V4	
	1,9 TD (10/14)			03.2002	24.3727-0348.2	580348	CABLE FREIN A MAIN	4745 V4	
	2,0 HDi (10/14/18)		11.2001	03.2002	24.3727-0348.2	580348	CABLE FREIN A MAIN	4745 V4	
	2,0 i (10/14/18)			03.2002	24.3727-0348.2	580348	CABLE FREIN A MAIN	4745 V4	
	2,5 D (14/18)			03.2002	24.3727-0348.2	580348	CABLE FREIN A MAIN	4745 V4	
	2,5 D 4x4 (14/18)		03.2000	03.2002	24.3727-0842.2	580842	CABLE FREIN A MAIN	4745 J2	
	2,5 TD (14/18)			03.2002	24.3727-0348.2	580348	CABLE FREIN A MAIN	4745 V4	
	2,5 TDi (14/18)			11.2000	24.3727-0348.2	580348	CABLE FREIN A MAIN	4745 V4	
	2,5 TDi 4x4 (14/18)		03.2000	11.2000	24.3727-0842.2	580842	CABLE FREIN A MAIN	4745 J2	
	2,8 HDi (14/18)			03.2002	24.3727-0348.2	580348	CABLE FREIN A MAIN	4745 V4	
	2,8 HDi 4x4 (14/18)		09.2000	03.2002	24.3727-0842.2	580842	CABLE FREIN A MAIN	4745 J2	
JUMPER Camion-plateau/Châssis (94-02)	1,9 TD (10/14)			03.2002	24.3727-0348.2	580348	CABLE FREIN A MAIN	4745 V4	
	2,0 i (10/14/18)			03.2002	24.3727-0348.2	580348	CABLE FREIN A MAIN	4745 V4	
	2,5 D (14/18)			03.2002	24.3727-0348.2	580348	CABLE FREIN A MAIN	4745 V4	
	2,5 D 4x4 (14/18)		03.1994	03.2002	24.3727-0842.2	580842	CABLE FREIN A MAIN	4745 J2	
	2,5 TD (14/18)			03.2002	24.3727-0348.2	580348	CABLE FREIN A MAIN	4745 V4	
	2,5 TDi (14/18)			03.2002	24.3727-0348.2	580348	CABLE FREIN A MAIN	4745 V4	

Nouvelles références disponibles - par applications

04/2007



					description	Références OE par référence ATE.		Références remplacées / divers
---	---	---	---	---	-------------	----------------------------------	---	--------------------------------

CITROEN

JUMPER Camion-plateau/Châssis (94-02)	2,5 TDi 4x4 (14/18)		12.1996	03.2002	24.3727-0842.2	580842	CABLE FREIN A MAIN	4745 J2	
	2,8 HDi (14/18)			03.2002	24.3727-0348.2	580348	CABLE FREIN A MAIN	4745 V4	

DAEWOO

KALOS (02-05)	1,2 i		04.2003	02.2005	13.0460-5899.2	605899	PLAQUETTES DE FREIN	96534653	cf. Photo
	1,4 i		09.2002	02.2005	13.0460-5899.2	605899	PLAQUETTES DE FREIN	96534653	cf. Photo
	1,4 i 16V		04.2003	02.2005	13.0460-5899.2	605899	PLAQUETTES DE FREIN	96534653	cf. Photo
	1,6 i 16V		11.2002	02.2005	13.0460-5899.2	605899	PLAQUETTES DE FREIN	96534653	cf. Photo
LEGANZA (97-02)	2,0 i 16V		06.1997	12.2002	24.0110-0282.1	410282	DISQUE DE FREIN	96219485	
	2,2 i 16V		04.1999	12.2002	24.0110-0282.1	410282	DISQUE DE FREIN	96219485	

Nouvelles références disponibles - par applications

04/2007



					description	Références OE par référence ATE.		Références remplacées / divers
--	--	--	--	--	-------------	----------------------------------	--	--------------------------------







FIAT

DUCATO (02-06)	2,0 i (11/15/18)		04.2002	09.2004	03.0137-4002.2	654002	JEU DE MACHOIRE	77362699 , 77363478 , 4241 NO , 77362696 , 77363479 , 4241 L9	
			10.2004	07.2006	03.0137-4002.2	654002	JEU DE MACHOIRE	77362699 , 77363478 , 4241 NO , 77362696 , 77363479 , 4241 L9	
	2,0 JTD (11/15/18)		10.2004	07.2006	03.0137-4002.2	654002	JEU DE MACHOIRE	77362699 , 77363478 , 4241 NO , 77362696 , 77363479 , 4241 L9	
			04.2002	09.2004	03.0137-4002.2	654002	JEU DE MACHOIRE	77362699 , 77363478 , 4241 NO , 77362696 , 77363479 , 4241 L9	
	2,3 JTD (11/15/18)		10.2004	07.2006	03.0137-4002.2	654002	JEU DE MACHOIRE	77362699 , 77363478 , 4241 NO , 77362696 , 77363479 , 4241 L9	
			04.2002	09.2004	03.0137-4002.2	654002	JEU DE MACHOIRE	77362699 , 77363478 , 4241 NO , 77362696 , 77363479 , 4241 L9	
	2,8 JTD (11/15/18)		10.2004	07.2006	03.0137-4002.2	654002	JEU DE MACHOIRE	77362699 , 77363478 , 4241 NO , 77362696 , 77363479 , 4241 L9	
			04.2002	09.2004	03.0137-4002.2	654002	JEU DE MACHOIRE	77362699 , 77363478 , 4241 NO , 77362696 , 77363479 , 4241 L9	
	2,8 JTD 4x4(11/15/18)		10.2004	07.2006	03.0137-4002.2	654002	JEU DE MACHOIRE	77362699 , 77363478 , 4241 NO , 77362696 , 77363479 , 4241 L9	
			07.2002	09.2004	03.0137-4002.2	654002	JEU DE MACHOIRE	77362699 , 77363478 , 4241 NO , 77362696 , 77363479 , 4241 L9	
GRANDE PUNTO (06-)	1,3 JTD		10.2005		24.0122-0241.1	422241	DISQUE DE FREIN	55700922 , 55700923	

Nouvelles références disponibles - par applications

04/2007



					description	Références OE par référence ATE.		Références remplacées / divers
---	---	---	---	---	-------------	----------------------------------	---	--------------------------------

FIAT

GRANDE PUNTO (06-)	1,9 JTD		02.2006		24.0122-0241.1	422241	DISQUE DE FREIN	55700922 , 55700923	
			10.2005		24.0122-0241.1	422241	DISQUE DE FREIN	55700922 , 55700923	
MULTIPLA (98-)	1,6 i 16V	ArG	04.2002	11.2005	24.3384-1747.7	220617	ETRIER A GRIFFE	9949353	
	1,9 JTD	ArG	04.2002	11.2005	24.3384-1747.7	220617	ETRIER A GRIFFE	9949353	
STILO (01-)	1,2 i 16V	ArG	10.2001	05.2005	24.3384-1747.7	220617	ETRIER A GRIFFE	9949353	
	1,4 i 16V	ArG	01.2004	05.2005	24.3384-1747.7	220617	ETRIER A GRIFFE	9949353	
	1,6 i 16V	ArG	10.2001	05.2005	24.3384-1747.7	220617	ETRIER A GRIFFE	9949353	
	1,8 i 16V	ArG	10.2001	05.2005	24.3384-1747.7	220617	ETRIER A GRIFFE	9949353	
	1,9 JTD	ArG	09.2004	05.2005	24.3384-1747.7	220617	ETRIER A GRIFFE	9949353	
		ArG	10.2001	05.2005	24.3384-1747.7	220617	ETRIER A GRIFFE	9949353	
		ArG	01.2004	05.2005	24.3384-1747.7	220617	ETRIER A GRIFFE	9949353	
	2,4 i 20V	ArG	10.2001	05.2005	24.3384-1747.7	220617	ETRIER A GRIFFE	9949353	



					description	Références OE par référence ATE.		Références remplacées / divers
--	--	--	--	--	-------------	----------------------------------	--	--------------------------------

FORD

FOCUS I (98-04)	1,4 i 16V		10.1998	08.2001	24.3727-0656.2	580656	CABLE FREIN A MAIN	1101841	
	1,6 i 16V		10.1998	08.2001	24.3727-0656.2	580656	CABLE FREIN A MAIN	1101841	
	1,8 i 16V		10.1998	08.2001	24.3727-0656.2	580656	CABLE FREIN A MAIN	1101841	
	1,8 TDCi		03.2001	08.2001	24.3727-0656.2	580656	CABLE FREIN A MAIN	1101841	
	1,8 Turbo DI		10.1998	08.2001	24.3727-0656.2	580656	CABLE FREIN A MAIN	1101841	
	2,0 i 16V		10.1998	08.2001	24.3727-0656.2	580656	CABLE FREIN A MAIN	1101841	
	ST 170		03.2002	09.2004	24.0110-0313.1	410313	DISQUE DE FREIN	4324591 , 4411312	

HYUNDAI

TERRACAN (01-)	2,5 TDiC		11.2001	10.2003	24.0127-0100.1	427100	DISQUE DE FREIN	51712-H1000	
	2,9 CRDi		11.2003		24.0127-0100.1	427100	DISQUE DE FREIN	51712-H1000	
			11.2001		24.0127-0100.1	427100	DISQUE DE FREIN	51712-H1000	
	3,5 i V6 4WD		11.2001		24.0127-0100.1	427100	DISQUE DE FREIN	51712-H1000	







JEEP

CHEROKEE (KJ) (01-)	2,4		09.2001		13.0460-2899.2	602899	PLAQUETTES DE FREIN	5066 427AA	cf. Photo
	2,5 CRD		09.2001		13.0460-2899.2	602899	PLAQUETTES DE FREIN	5066 427AA	cf. Photo
	2,8 CRD		11.2002		13.0460-2899.2	602899	PLAQUETTES DE FREIN	5066 427AA	cf. Photo
	3,7 V6		09.2001		13.0460-2899.2	602899	PLAQUETTES DE FREIN	5066 427AA	cf. Photo

Nouvelles références disponibles - par applications

04/2007









					description	Références OE par référence ATE.		Références remplacées / divers
---	---	---	---	---	-------------	----------------------------------	---	--------------------------------

MAZDA

3 (03-)	1,4 i 16V	AvG	10.2003		11.9571-9785.2	220595	ETRIER A GRIFFE	BPYK-33-71XA	
		AvD	10.2003		11.9571-9786.2	220596	ETRIER A GRIFFE	BPYK-33-61XA	
	1,6 CITD	AvD	06.2004		11.9571-9786.2	220596	ETRIER A GRIFFE	BPYK-33-61XA	
		AvG	06.2004		11.9571-9785.2	220595	ETRIER A GRIFFE	BPYK-33-71XA	
	1,6 i 16V	AvD	10.2003		11.9571-9786.2	220596	ETRIER A GRIFFE	BPYK-33-61XA	
		AvG	10.2003		11.9571-9785.2	220595	ETRIER A GRIFFE	BPYK-33-71XA	
	2,0 i 16V	AvG	10.2003		11.9571-9785.2	220595	ETRIER A GRIFFE	BPYK-33-71XA	
		AvD	10.2003		11.9571-9786.2	220596	ETRIER A GRIFFE	BPYK-33-61XA	
	2,3 i 16V	AvD	10.2003		11.9571-9786.2	220596	ETRIER A GRIFFE	BPYK-33-61XA	
		AvG	10.2003		11.9571-9785.2	220595	ETRIER A GRIFFE	BPYK-33-71XA	
5 (05-)	1,8 i 16V	AvD	03.2005		11.9571-9786.2	220596	ETRIER A GRIFFE	BPYK-33-61XA	
		AvG	03.2005		11.9571-9785.2	220595	ETRIER A GRIFFE	BPYK-33-71XA	
	2,0 CITD	AvD	03.2005		11.9571-9786.2	220596	ETRIER A GRIFFE	BPYK-33-61XA	
		AvG	03.2005		11.9571-9785.2	220595	ETRIER A GRIFFE	BPYK-33-71XA	
		AvD	06.2005		11.9571-9786.2	220596	ETRIER A GRIFFE	BPYK-33-61XA	
		AvG	06.2005		11.9571-9785.2	220595	ETRIER A GRIFFE	BPYK-33-71XA	
	2,0 i 16V	AvD	03.2005		11.9571-9786.2	220596	ETRIER A GRIFFE	BPYK-33-61XA	
		AvG	03.2005		11.9571-9785.2	220595	ETRIER A GRIFFE	BPYK-33-71XA	
PREMACY (05-)	1,8 i 16V	AvD	03.2005		11.9571-9786.2	220596	ETRIER A GRIFFE	BPYK-33-61XA	



		 		description	Références OE par référence ATE.	 Références remplacées / divers
---	---	---	---	-------------	--	---

MAZDA

PREMACY (05-)	1,8 i 16V	AvG	03.2005		11.9571-9785.2	220595	ETRIER A GRIFFE	BPYK-33-71XA	
	2,0 CITD	AvD	03.2005		11.9571-9786.2	220596	ETRIER A GRIFFE	BPYK-33-61XA	
		AvD	06.2005		11.9571-9786.2	220596	ETRIER A GRIFFE	BPYK-33-61XA	
		AvG	06.2005		11.9571-9785.2	220595	ETRIER A GRIFFE	BPYK-33-71XA	
		AvG	03.2005		11.9571-9785.2	220595	ETRIER A GRIFFE	BPYK-33-71XA	
	2,0 i 16V	AvD	03.2005		11.9571-9786.2	220596	ETRIER A GRIFFE	BPYK-33-61XA	
		AvG	03.2005		11.9571-9785.2	220595	ETRIER A GRIFFE	BPYK-33-71XA	

Nouvelles références disponibles - par applications

04/2007









					description	Références OE par référence ATE.		Références remplacées / divers
--	--	--	--	--	-------------	----------------------------------	--	--------------------------------

MERCEDES BENZ

MERCEDES-BENZ Classe A (W169) (04-)	A 150		08.2004		24.0108-0113.1	408113	DISQUE DE FREIN	169 423 03 12	
			08.2004		24.0112-0167.1	412167	DISQUE DE FREIN	169 421 00 12	
	A 160 CDI		08.2004		24.0108-0113.1	408113	DISQUE DE FREIN	169 423 03 12	
			08.2004		24.0112-0167.1	412167	DISQUE DE FREIN	169 421 00 12	
	A 170		08.2004		24.0108-0113.1	408113	DISQUE DE FREIN	169 423 03 12	
	A 180 CDI		08.2004		24.0108-0113.1	408113	DISQUE DE FREIN	169 423 03 12	
	A 200		08.2004		24.0108-0113.1	408113	DISQUE DE FREIN	169 423 03 12	
	A 200 CDI		08.2004		24.0108-0113.1	408113	DISQUE DE FREIN	169 423 03 12	
	A 200 Turbo		03.2005		24.0108-0113.1	408113	DISQUE DE FREIN	169 423 03 12	
MERCEDES-BENZ Classe B (W245) (05-)	B 150		04.2005		24.0108-0113.1	408113	DISQUE DE FREIN	169 423 03 12	
	B 170		04.2005		24.0108-0113.1	408113	DISQUE DE FREIN	169 423 03 12	
	B 180 CDI		04.2005		24.0108-0113.1	408113	DISQUE DE FREIN	169 423 03 12	
	B 200		04.2005		24.0108-0113.1	408113	DISQUE DE FREIN	169 423 03 12	
	B 200 CDI		04.2005		24.0108-0113.1	408113	DISQUE DE FREIN	169 423 03 12	
	B 200 Turbo		04.2005		24.0108-0113.1	408113	DISQUE DE FREIN	169 423 03 12	
MERCEDES-BENZ Classe M (W164) (05-)	ML 280 CDI		07.2005		24.0132-0158.1	432158	DISQUE DE FREIN	164 421 04 12	
	ML 320 CDI		07.2005		24.0132-0158.1	432158	DISQUE DE FREIN	164 421 04 12	
	ML 350		07.2005		24.0132-0158.1	432158	DISQUE DE FREIN	164 421 04 12	
MERCEDES-BENZ Classe R (R251) (06-)	R 280		01.2007		24.0132-0158.1	432158	DISQUE DE FREIN	164 421 04 12	



		 		<p>description</p>	<p>Références OE par référence ATE.</p>	 <p>Références remplacées / divers</p>
---	---	---	---	--------------------	---	---

MERCEDES BENZ

MERCEDES-BENZ Classe R (R251) (06-)	R 280 CDI		11.2005		24.0132-0158.1	432158	DISQUE DE FREIN	164 421 04 12	
	R 300		01.2007		24.0132-0158.1	432158	DISQUE DE FREIN	164 421 04 12	
	R 320 CDI		11.2005		24.0132-0158.1	432158	DISQUE DE FREIN	164 421 04 12	
	R 350		11.2005		24.0132-0158.1	432158	DISQUE DE FREIN	164 421 04 12	

Nouvelles références disponibles - par applications

04/2007



					description	Références OE par référence ATE.		Références remplacées / divers
--	--	--	--	--	-------------	----------------------------------	--	--------------------------------

NISSAN

INTERSTAR (X70) (02-)	1,9 CDi		11.2003		24.5111-0510.3	330819	FLEXIBLE FREIN	44 15 698 , 93182621 , 82 00 196 055 , 46201-00QAH	
		ArG	11.2003		24.5258-0450.3	330824	FLEXIBLE FREIN	44 15 858 , 93183554 , 44230-00QAD , 77 01 059 963	
			07.2002		24.3727-0762.2	580762	CABLE FREIN A MAIN	77 00 311 216 , 36402-00QAA , 45 00 250 , 44 03 487 , 9111487 , 9160550	
	2,2 CDi		11.2003		24.5111-0510.3	330819	FLEXIBLE FREIN	44 15 698 , 93182621 , 82 00 196 055 , 46201-00QAH	
		ArG	11.2003		24.5258-0450.3	330824	FLEXIBLE FREIN	44 15 858 , 93183554 , 44230-00QAD , 77 01 059 963	
			07.2002		24.3727-0762.2	580762	CABLE FREIN A MAIN	77 00 311 216 , 36402-00QAA , 45 00 250 , 44 03 487 , 9111487 , 9160550	
	2,5 CDi		11.2003		24.5111-0510.3	330819	FLEXIBLE FREIN	44 15 698 , 93182621 , 82 00 196 055 , 46201-00QAH	
		ArG	11.2003		24.5258-0450.3	330824	FLEXIBLE FREIN	44 15 858 , 93183554 , 44230-00QAD , 77 01 059 963	
			07.2002		24.3727-0762.2	580762	CABLE FREIN A MAIN	77 00 311 216 , 36402-00QAA , 45 00 250 , 44 03 487 , 9111487 , 9160550	
	3,0 CDi	ArG	11.2003		24.5258-0450.3	330824	FLEXIBLE FREIN	44 15 858 , 93183554 , 44230-00QAD , 77 01 059 963	
			11.2003		24.5111-0510.3	330819	FLEXIBLE FREIN	44 15 698 , 93182621 , 82 00 196 055 , 46201-00QAH	
			11.2003		24.3727-0762.2	580762	CABLE FREIN A MAIN	77 00 311 216 , 36402-00QAA , 45 00 250 , 44 03 487 , 9111487 , 9160550	

Nouvelles références disponibles - par applications

04/2007



					description	Références OE par référence ATE.		Références remplacées / divers
--	--	--	--	--	-------------	----------------------------------	--	--------------------------------

NISSAN

MICRA (K12E) (03-)	1,0 i 16V	ArD	01.2003		24.3727-1719.2	581719	CABLE FREIN A MAIN	36530-AX600 , 36530-AX601	
		ArG	01.2003		24.3727-1718.2	581718	CABLE FREIN A MAIN	36531-AX600 , 36531-AX601	
	1,2 i 16V	ArG	01.2003		24.3727-1718.2	581718	CABLE FREIN A MAIN	36531-AX600 , 36531-AX601	
		ArD	01.2003		24.3727-1719.2	581719	CABLE FREIN A MAIN	36530-AX600 , 36530-AX601	
	1,4 i 16V	ArD	01.2003		24.3727-1719.2	581719	CABLE FREIN A MAIN	36530-AX600 , 36530-AX601	
		ArG	01.2003		24.3727-1718.2	581718	CABLE FREIN A MAIN	36531-AX600 , 36531-AX601	
	1,5 dCi	ArG	01.2003		24.3727-1718.2	581718	CABLE FREIN A MAIN	36531-AX600 , 36531-AX601	
		ArG	09.2003		24.3727-1718.2	581718	CABLE FREIN A MAIN	36531-AX600 , 36531-AX601	
		ArD	09.2003		24.3727-1719.2	581719	CABLE FREIN A MAIN	36530-AX600 , 36530-AX601	
		ArD	01.2003		24.3727-1719.2	581719	CABLE FREIN A MAIN	36530-AX600 , 36530-AX601	
	1,6 i 16V	ArG	05.2005		24.3727-1718.2	581718	CABLE FREIN A MAIN	36531-AX600 , 36531-AX601	
		ArD	05.2005		24.3727-1719.2	581719	CABLE FREIN A MAIN	36530-AX600 , 36530-AX601	
MICRA C+C (CK12E) (05-)	1,4 i 16V	ArG	08.2005		24.3727-1718.2	581718	CABLE FREIN A MAIN	36531-AX600 , 36531-AX601	
		ArD	08.2005		24.3727-1719.2	581719	CABLE FREIN A MAIN	36530-AX600 , 36530-AX601	
	1,6 i 16V	ArG	08.2005		24.3727-1718.2	581718	CABLE FREIN A MAIN	36531-AX600 , 36531-AX601	
		ArD	08.2005		24.3727-1719.2	581719	CABLE FREIN A MAIN	36530-AX600 , 36530-AX601	
PRIMASTAR (X83) Bus (01-)	1,9 dCi (100)		03.2001		24.3727-0763.2	580763	CABLE FREIN A MAIN	36518-00QAA , 77 00 313 058 , 44 08 735 , 91165521	
	1,9 dCi (80)		03.2001		24.3727-0763.2	580763	CABLE FREIN A MAIN	36518-00QAA , 77 00 313 058 , 44 08 735 , 91165521	



					description	Références OE par référence ATE.		Références remplacées / divers
--	--	--	--	--	-------------	----------------------------------	--	--------------------------------







NISSAN

PRIMASTAR (X83) Bus (01-)	2,0 i 16V		03.2001		24.3727-0763.2	580763	CABLE FREIN A MAIN	36518-00QAA , 77 00 313 058 , 44 08 735 , 91165521	
	2,5 dCi (140)		09.2003		24.3727-0763.2	580763	CABLE FREIN A MAIN	36518-00QAA , 77 00 313 058 , 44 08 735 , 91165521	
PRIMASTAR (X83) Van (02-)	1,9 dCi (100)		07.2002		24.3727-0763.2	580763	CABLE FREIN A MAIN	36518-00QAA , 77 00 313 058 , 44 08 735 , 91165521	
	1,9 dCi (80)		07.2002		24.3727-0763.2	580763	CABLE FREIN A MAIN	36518-00QAA , 77 00 313 058 , 44 08 735 , 91165521	
	2,0 i 16V		07.2002		24.3727-0763.2	580763	CABLE FREIN A MAIN	36518-00QAA , 77 00 313 058 , 44 08 735 , 91165521	
	2,5 dCi (140)		09.2003		24.3727-0763.2	580763	CABLE FREIN A MAIN	36518-00QAA , 77 00 313 058 , 44 08 735 , 91165521	
PRIMERA (P10E) Berline (90-96)	1,6	ArD	09.1994	01.1996	24.3220-1730.3	020492	CYLINDRE DE ROUE	44100-3F000	
		ArG	09.1994	01.1996	24.3220-1729.3	020491	CYLINDRE DE ROUE	44101-3F000	
	1,6 i	ArD	09.1994	01.1996	24.3220-1730.3	020492	CYLINDRE DE ROUE	44100-3F000	
		ArG	09.1994	01.1996	24.3220-1729.3	020491	CYLINDRE DE ROUE	44101-3F000	
PRIMERA (W11) Break (98-02)	1,6 i 16V		04.1998	03.2001	24.0110-0310.1	410310	DISQUE DE FREIN	43206-99J04	
	1,8 i 16V		08.1999	03.2001	24.0110-0310.1	410310	DISQUE DE FREIN	43206-99J04	
	2,0 i 16V		04.1998	03.2001	24.0110-0310.1	410310	DISQUE DE FREIN	43206-99J04	
			08.1999	03.2001	24.0110-0310.1	410310	DISQUE DE FREIN	43206-99J04	
	2,0 TD		04.1998	03.2001	24.0110-0310.1	410310	DISQUE DE FREIN	43206-99J04	

Nouvelles références disponibles - par applications

04/2007



					description	Références OE par référence ATE.	 Références remplacées / divers
---	---	---	---	---	-------------	----------------------------------	--

OPEL

AGILA (00-)	1	AvG	08.2003		24.3481-1757.5	240325	ETRIER A GRIFFE	9195321 , 55102-83E00 , 47 01 929	
		AvD	08.2003		24.3481-1758.5	240326	ETRIER A GRIFFE	9195322 , 55101-83E00 , 47 01 930	
	1,0 12V	AvG	09.2000		24.3481-1757.5	240325	ETRIER A GRIFFE	9195321 , 55102-83E00 , 47 01 929	
		AvD	09.2000		24.3481-1758.5	240326	ETRIER A GRIFFE	9195322 , 55101-83E00 , 47 01 930	
	1,2 16V	AvD	09.2000		24.3481-1758.5	240326	ETRIER A GRIFFE	9195322 , 55101-83E00 , 47 01 930	
		AvG	09.2000		24.3481-1757.5	240325	ETRIER A GRIFFE	9195321 , 55102-83E00 , 47 01 929	
	1,3 CDTI	AvG	08.2003		24.3481-1757.5	240325	ETRIER A GRIFFE	9195321 , 55102-83E00 , 47 01 929	
		AvD	08.2003		24.3481-1758.5	240326	ETRIER A GRIFFE	9195322 , 55101-83E00 , 47 01 930	
COMBO / Vauxhall Combo (01-)					24.2122-1758.3	010770	MAITRE CYL. TANDEM	93177770 , 5 58 137	
					24.2122-1757.3	010769	MAITRE CYL. TANDEM	93177769 , 5 58 133	
	1,4 16V				24.2122-1757.3	010769	MAITRE CYL. TANDEM	93177769 , 5 58 133	
					24.2122-1758.3	010770	MAITRE CYL. TANDEM	93177770 , 5 58 137	
	1,6				24.2122-1757.3	010769	MAITRE CYL. TANDEM	93177769 , 5 58 133	
					24.2122-1758.3	010770	MAITRE CYL. TANDEM	93177770 , 5 58 137	
	1,7 CDTI		06.2003		24.2122-1757.3	010769	MAITRE CYL. TANDEM	93177769 , 5 58 133	
			06.2003		24.2122-1758.3	010770	MAITRE CYL. TANDEM	93177770 , 5 58 137	

Nouvelles références disponibles - par applications

04/2007



					description	Références OE par référence ATE.		Références remplacées / divers
--	--	--	--	--	-------------	----------------------------------	--	--------------------------------

OPEL

COMBO / Vauxhall Combo (01-)	1,7 DI 16V				24.2122-1758.3	010770	MAITRE CYL. TANDEM	93177770 , 5 58 137	
					24.2122-1757.3	010769	MAITRE CYL. TANDEM	93177769 , 5 58 133	
	1,7 DTI 16V				24.2122-1758.3	010770	MAITRE CYL. TANDEM	93177770 , 5 58 137	
					24.2122-1757.3	010769	MAITRE CYL. TANDEM	93177769 , 5 58 133	
CORSA C / Vauxhall Corsa MK II (00-06)	1,0 12V			09.2006	24.2122-1758.3	010770	MAITRE CYL. TANDEM	93177770 , 5 58 137	
				09.2006	24.2122-1757.3	010769	MAITRE CYL. TANDEM	93177769 , 5 58 133	
	1,2 16V			09.2006	24.2122-1758.3	010770	MAITRE CYL. TANDEM	93177770 , 5 58 137	
				09.2006	24.2122-1757.3	010769	MAITRE CYL. TANDEM	93177769 , 5 58 133	
	1,3 CDTI			09.2006	24.2122-1758.3	010770	MAITRE CYL. TANDEM	93177770 , 5 58 137	
				09.2006	24.2122-1757.3	010769	MAITRE CYL. TANDEM	93177769 , 5 58 133	
	1,6			09.2006	24.2122-1757.3	010769	MAITRE CYL. TANDEM	93177769 , 5 58 133	
				09.2006	24.2122-1758.3	010770	MAITRE CYL. TANDEM	93177770 , 5 58 137	
	1,7 CDTI			09.2006	24.2122-1757.3	010769	MAITRE CYL. TANDEM	93177769 , 5 58 133	
				09.2006	24.2122-1758.3	010770	MAITRE CYL. TANDEM	93177770 , 5 58 137	
	1,7 DI 16V			09.2006	24.2122-1757.3	010769	MAITRE CYL. TANDEM	93177769 , 5 58 133	
				09.2006	24.2122-1758.3	010770	MAITRE CYL. TANDEM	93177770 , 5 58 137	
	1,7 DTI 16V			09.2006	24.2122-1758.3	010770	MAITRE CYL. TANDEM	93177770 , 5 58 137	
				09.2006	24.2122-1757.3	010769	MAITRE CYL. TANDEM	93177769 , 5 58 133	
MOVANO (98-)	1,9 DTI		09.2003		24.5111-0510.3	330819	FLEXIBLE FREIN	44 15 698 , 93182621 , 82 00 196 055 , 46201-00QAH	



					description	Références OE par référence ATE.		Références remplacées / divers
--	--	--	--	--	-------------	----------------------------------	--	--------------------------------

OPEL

MOVANO (98-)	1,9 DTI		09.2000		24.3727-0762.2	580762	CABLE FREIN A MAIN	77 00 311 216 , 36402-00QAA , 45 00 250 , 44 03 487 , 9111487 , 9160550	
	2,2 DTI 16V		09.2003		24.5111-0510.3	330819	FLEXIBLE FREIN	44 15 698 , 93182621 , 82 00 196 055 , 46201-00QAH	
		ArG	09.2003		24.5258-0450.3	330824	FLEXIBLE FREIN	44 15 858 , 93183554 , 44230-00QAD , 77 01 059 963	
			09.2000		24.3727-0762.2	580762	CABLE FREIN A MAIN	77 00 311 216 , 36402-00QAA , 45 00 250 , 44 03 487 , 9111487 , 9160550	
	2,5 D		07.1998	09.2000	24.3727-0762.2	580762	CABLE FREIN A MAIN	77 00 311 216 , 36402-00QAA , 45 00 250 , 44 03 487 , 9111487 , 9160550	
	2,5 DTI	ArG	10.2003		24.5258-0450.3	330824	FLEXIBLE FREIN	44 15 858 , 93183554 , 44230-00QAD , 77 01 059 963	
			10.2003		24.5111-0510.3	330819	FLEXIBLE FREIN	44 15 698 , 93182621 , 82 00 196 055 , 46201-00QAH	
			09.2003		24.5111-0510.3	330819	FLEXIBLE FREIN	44 15 698 , 93182621 , 82 00 196 055 , 46201-00QAH	
			10.2003		24.3727-0762.2	580762	CABLE FREIN A MAIN	77 00 311 216 , 36402-00QAA , 45 00 250 , 44 03 487 , 9111487 , 9160550	
			10.2001		24.3727-0762.2	580762	CABLE FREIN A MAIN	77 00 311 216 , 36402-00QAA , 45 00 250 , 44 03 487 , 9111487 , 9160550	
	2,8 DTI		07.1998	10.2001	24.3727-0762.2	580762	CABLE FREIN A MAIN	77 00 311 216 , 36402-00QAA , 45 00 250 , 44 03 487 , 9111487 , 9160550	

Nouvelles références disponibles - par applications

04/2007



					description	Références OE par référence ATE.		Références remplacées / divers
--	--	--	--	--	-------------	----------------------------------	--	--------------------------------

OPEL

MOVANO (98-)	3,0 DTI		10.2003		24.5111-0510.3	330819	FLEXIBLE FREIN	44 15 698 , 93182621 , 82 00 196 055 , 46201-00QAH	
		ArG	10.2003		24.5258-0450.3	330824	FLEXIBLE FREIN	44 15 858 , 93183554 , 44230-00QAD , 77 01 059 963	
			10.2003		24.3727-0762.2	580762	CABLE FREIN A MAIN	77 00 311 216 , 36402-00QAA , 45 00 250 , 44 03 487 , 9111487 , 9160550	
VIVARO (01-)	1,9 DI		08.2001		24.3727-0764.2	580764	CABLE FREIN A MAIN	82 00 008 473 , 44 08 730 , 91165522	
			08.2001		24.3727-0763.2	580763	CABLE FREIN A MAIN	36518-00QAA , 77 00 313 058 , 44 08 735 , 91165521	
	1,9 DTI		08.2001		24.3727-0763.2	580763	CABLE FREIN A MAIN	36518-00QAA , 77 00 313 058 , 44 08 735 , 91165521	
			08.2001		24.3727-0764.2	580764	CABLE FREIN A MAIN	82 00 008 473 , 44 08 730 , 91165522	
	2,0 16V		08.2001		24.3727-0764.2	580764	CABLE FREIN A MAIN	82 00 008 473 , 44 08 730 , 91165522	
			08.2001		24.3727-0763.2	580763	CABLE FREIN A MAIN	36518-00QAA , 77 00 313 058 , 44 08 735 , 91165521	
	2,5 DTI		05.2003		24.3727-0764.2	580764	CABLE FREIN A MAIN	82 00 008 473 , 44 08 730 , 91165522	
			05.2003		24.3727-0763.2	580763	CABLE FREIN A MAIN	36518-00QAA , 77 00 313 058 , 44 08 735 , 91165521	

Nouvelles références disponibles - par applications

04/2007



					description	Références OE par référence ATE.		Références remplacées / divers
--	--	--	--	--	-------------	----------------------------------	--	--------------------------------

PEUGEOT

206 CC (00-)	CC 110		09.2000		24.3728-0845.2	590845	CABLE D'EMBRAYAGE	2150 X3	24.3728-0829.2
206 Berline (98-)	1,1		09.1998		24.3728-0845.2	590845	CABLE D'EMBRAYAGE	2150 X3	24.3728-0829.2
	1,4		09.1998		24.3728-0845.2	590845	CABLE D'EMBRAYAGE	2150 X3	24.3728-0829.2
	1,6		09.1998	12.2000	24.3728-0845.2	590845	CABLE D'EMBRAYAGE	2150 X3	24.3728-0829.2
	1,6 16V		12.2000		24.3728-0845.2	590845	CABLE D'EMBRAYAGE	2150 X3	24.3728-0829.2
206 SW (02-)	1,1		07.2002		24.3728-0845.2	590845	CABLE D'EMBRAYAGE	2150 X3	24.3728-0829.2
	1,4		07.2002		24.3728-0845.2	590845	CABLE D'EMBRAYAGE	2150 X3	24.3728-0829.2
	1,6 16V		07.2002		24.3728-0845.2	590845	CABLE D'EMBRAYAGE	2150 X3	24.3728-0829.2
607 (00-)	2,0 16V				24.5257-0480.3	330823	FLEXIBLE FREIN	4806 F5	
		ArD	02.2000		24.3727-0841.2	580841	CABLE FREIN A MAIN	4745 X7	
		ArG	02.2000		24.3727-0840.2	580840	CABLE FREIN A MAIN	4745 X6	
	2,0 HDi		09.2005		24.5257-0480.3	330823	FLEXIBLE FREIN	4806 F5	
					24.5257-0480.3	330823	FLEXIBLE FREIN	4806 F5	
		ArD	09.2005		24.3727-0841.2	580841	CABLE FREIN A MAIN	4745 X7	
		ArG	02.2000		24.3727-0840.2	580840	CABLE FREIN A MAIN	4745 X6	
		ArG	09.2005		24.3727-0840.2	580840	CABLE FREIN A MAIN	4745 X6	
		ArD	02.2000		24.3727-0841.2	580841	CABLE FREIN A MAIN	4745 X7	
	2,2 16V				24.5257-0480.3	330823	FLEXIBLE FREIN	4806 F5	
			09.2005		24.5257-0480.3	330823	FLEXIBLE FREIN	4806 F5	

Nouvelles références disponibles - par applications

04/2007



					description	Références OE par référence ATE.		Références remplacées / divers
--	--	--	--	--	-------------	----------------------------------	--	--------------------------------

PEUGEOT

607 (00-)	2,2 16V	ArD	09.2005		24.3727-0841.2	580841	CABLE FREIN A MAIN	4745 X7	
		ArD	02.2000		24.3727-0841.2	580841	CABLE FREIN A MAIN	4745 X7	
		ArG	09.2005		24.3727-0840.2	580840	CABLE FREIN A MAIN	4745 X6	
		ArG	02.2000		24.3727-0840.2	580840	CABLE FREIN A MAIN	4745 X6	
	2,2 HDi				24.5257-0480.3	330823	FLEXIBLE FREIN	4806 F5	
		ArG	02.2000		24.3727-0840.2	580840	CABLE FREIN A MAIN	4745 X6	
		ArD	02.2000		24.3727-0841.2	580841	CABLE FREIN A MAIN	4745 X7	
	2,2 HDi 170		05.2006		24.5257-0480.3	330823	FLEXIBLE FREIN	4806 F5	
		ArD	05.2006		24.3727-0841.2	580841	CABLE FREIN A MAIN	4745 X7	
		ArG	05.2006		24.3727-0840.2	580840	CABLE FREIN A MAIN	4745 X6	
	2,7 HDi		12.2004		24.5257-0480.3	330823	FLEXIBLE FREIN	4806 F5	
		ArG	12.2004		24.3727-0840.2	580840	CABLE FREIN A MAIN	4745 X6	
		ArD	12.2004		24.3727-0841.2	580841	CABLE FREIN A MAIN	4745 X7	
	3,0 24V		03.2004		24.5257-0480.3	330823	FLEXIBLE FREIN	4806 F5	
		ArD	03.2004		24.3727-0841.2	580841	CABLE FREIN A MAIN	4745 X7	
		ArG	03.2004		24.3727-0840.2	580840	CABLE FREIN A MAIN	4745 X6	
	3,0 V6				24.5257-0480.3	330823	FLEXIBLE FREIN	4806 F5	
		ArD	02.2000		24.3727-0841.2	580841	CABLE FREIN A MAIN	4745 X7	
		ArG	02.2000		24.3727-0840.2	580840	CABLE FREIN A MAIN	4745 X6	

Nouvelles références disponibles - par applications

04/2007



					description	Références OE par référence ATE.	Références remplacées / divers
--	--	--	--	--	-------------	----------------------------------	--------------------------------

PEUGEOT

BOXER (02-06)	2,0 HDi (10/14/18)				03.0137-4002.2	654002	JEU DE MACHOIRE	77362699 , 77363478 , 4241 NO , 77362696 , 77363479 , 4241 L9	
			04.2002		03.0137-4002.2	654002	JEU DE MACHOIRE	77362699 , 77363478 , 4241 NO , 77362696 , 77363479 , 4241 L9	
			04.2002		24.3727-0348.2	580348	CABLE FREIN A MAIN	4745 V4	
	2,0 i (10/14/18)				03.0137-4002.2	654002	JEU DE MACHOIRE	77362699 , 77363478 , 4241 NO , 77362696 , 77363479 , 4241 L9	
			04.2002		03.0137-4002.2	654002	JEU DE MACHOIRE	77362699 , 77363478 , 4241 NO , 77362696 , 77363479 , 4241 L9	
			04.2002		24.3727-0348.2	580348	CABLE FREIN A MAIN	4745 V4	
	2,2 HDi (10/14/18)		04.2002		03.0137-4002.2	654002	JEU DE MACHOIRE	77362699 , 77363478 , 4241 NO , 77362696 , 77363479 , 4241 L9	
					03.0137-4002.2	654002	JEU DE MACHOIRE	77362699 , 77363478 , 4241 NO , 77362696 , 77363479 , 4241 L9	
			04.2002		24.3727-0348.2	580348	CABLE FREIN A MAIN	4745 V4	
	2,8 HDi (10/14/18)				03.0137-4002.2	654002	JEU DE MACHOIRE	77362699 , 77363478 , 4241 NO , 77362696 , 77363479 , 4241 L9	
			04.2002		03.0137-4002.2	654002	JEU DE MACHOIRE	77362699 , 77363478 , 4241 NO , 77362696 , 77363479 , 4241 L9	
			04.2002		24.3727-0348.2	580348	CABLE FREIN A MAIN	4745 V4	

Nouvelles références disponibles - par applications

04/2007



					description	Références OE par référence ATE.		Références remplacées / divers
--	--	--	--	--	-------------	----------------------------------	--	--------------------------------

PEUGEOT

BOXER (02-06)	2,8 HDi 4x4(10/14/18)		04.2002		24.3727-0348.2	580348	CABLE FREIN A MAIN	4745 V4	
BOXER Autobus/car (94-02)	1,9 TD 4x4 (10/14)		07.1996	03.2002	24.3727-0842.2	580842	CABLE FREIN A MAIN	4745 J2	
	2,0 i 4x4 (10/14/18)		07.1996	03.2002	24.3727-0842.2	580842	CABLE FREIN A MAIN	4745 J2	
	2,5 D 4x4 (14/18)		07.1996	03.2002	24.3727-0842.2	580842	CABLE FREIN A MAIN	4745 J2	
	2,5 TD 4x4 (14/18)		07.1996	03.2002	24.3727-0842.2	580842	CABLE FREIN A MAIN	4745 J2	
	2,5 TDi 4x4 (14/18)		01.1997	03.2002	24.3727-0842.2	580842	CABLE FREIN A MAIN	4745 J2	
BOXER Fourgonnette (94-02)	1,9 D (10)			03.2002	24.3727-0348.2	580348	CABLE FREIN A MAIN	4745 V4	
	1,9 TD (10/14)			03.2002	24.3727-0348.2	580348	CABLE FREIN A MAIN	4745 V4	
	2,0 HDi (10/14/18)		08.2001	03.2002	24.3727-0348.2	580348	CABLE FREIN A MAIN	4745 V4	
	2,0 i (10/14/18)			03.2002	24.3727-0348.2	580348	CABLE FREIN A MAIN	4745 V4	
	2,5 D (14/18)			03.2002	24.3727-0348.2	580348	CABLE FREIN A MAIN	4745 V4	
	2,5 D 4x4 (14/18)		07.1999	03.2002	24.3727-0842.2	580842	CABLE FREIN A MAIN	4745 J2	
	2,5 TD (14/18)			03.2002	24.3727-0348.2	580348	CABLE FREIN A MAIN	4745 V4	
	2,5 TDi (14/18)			03.2002	24.3727-0348.2	580348	CABLE FREIN A MAIN	4745 V4	
	2,5 TDi 4x4 (14/18)		07.1999	03.2002	24.3727-0842.2	580842	CABLE FREIN A MAIN	4745 J2	
	2,8 HDi (14/18)			03.2002	24.3727-0348.2	580348	CABLE FREIN A MAIN	4745 V4	
BOXER Camion-plateau/Châssis (94-02)	1,9 TD (10/14)			03.2002	24.3727-0348.2	580348	CABLE FREIN A MAIN	4745 V4	
	2,0 i (10/14/18)			03.2002	24.3727-0348.2	580348	CABLE FREIN A MAIN	4745 V4	
	2,5 D (14/18)			03.2002	24.3727-0348.2	580348	CABLE FREIN A MAIN	4745 V4	

Nouvelles références disponibles - par applications

04/2007









						description	Références OE par référence ATE.		Références remplacées / divers
--	--	--	--	--	--	-------------	----------------------------------	--	--------------------------------

PEUGEOT

BOXER Camion-plateau/Châssis (94-02)	2,5 D 4x4 (14/18)		07.1999	03.2002	24.3727-0842.2	580842	CABLE FREIN A MAIN	4745 J2	
	2,5 TD (14/18)			03.2002	24.3727-0348.2	580348	CABLE FREIN A MAIN	4745 V4	
	2,5 TDi (14/18)			03.2002	24.3727-0348.2	580348	CABLE FREIN A MAIN	4745 V4	
	2,5 TDi 4x4 (14/18)		07.1999	03.2002	24.3727-0842.2	580842	CABLE FREIN A MAIN	4745 J2	
	2,8 HDi (14/18)			03.2002	24.3727-0348.2	580348	CABLE FREIN A MAIN	4745 V4	
PARTNER Break (96-)	1,6 16V	ArD	07.2001		24.3727-0347.2	580347	CABLE FREIN A MAIN	4745 Y1 , 4745 X3	
		ArG	07.2001		24.3727-0349.2	580349	CABLE FREIN A MAIN	4745 Y0 , 4745 X2	
	1,6 HDi 75	ArD	02.2006		24.3727-0347.2	580347	CABLE FREIN A MAIN	4745 Y1 , 4745 X3	
		ArG	02.2006		24.3727-0349.2	580349	CABLE FREIN A MAIN	4745 Y0 , 4745 X2	
	1,6 HDi 90	ArD	02.2006		24.3727-0347.2	580347	CABLE FREIN A MAIN	4745 Y1 , 4745 X3	
		ArG	02.2006		24.3727-0349.2	580349	CABLE FREIN A MAIN	4745 Y0 , 4745 X2	
	2,0 HDi 90	ArD	02.2000		24.3727-0347.2	580347	CABLE FREIN A MAIN	4745 Y1 , 4745 X3	
		ArG	02.2000		24.3727-0349.2	580349	CABLE FREIN A MAIN	4745 Y0 , 4745 X2	



					description	Références OE par référence ATE.	 Références remplacées / divers
---	---	---	---	---	-------------	----------------------------------	--

RENAULT

MASTER II Bus (JD/ND_) (98-)	1,9 dCi 80	ArG	12.2003		24.5258-0450.3	330824	FLEXIBLE FREIN	44 15 858 , 93183554 , 44230-00QAD , 77 01 059 963	
			11.2003		24.5111-0510.3	330819	FLEXIBLE FREIN	44 15 698 , 93182621 , 82 00 196 055 , 46201-00QAH	
			11.2001		24.3727-0762.2	580762	CABLE FREIN A MAIN	77 00 311 216 , 36402-00QAA , 45 00 250 , 44 03 487 , 9111487 , 9160550	
	1,9 dTi		11.2003		24.5111-0510.3	330819	FLEXIBLE FREIN	44 15 698 , 93182621 , 82 00 196 055 , 46201-00QAH	
		ArG	12.2003		24.5258-0450.3	330824	FLEXIBLE FREIN	44 15 858 , 93183554 , 44230-00QAD , 77 01 059 963	
			09.2000		24.3727-0762.2	580762	CABLE FREIN A MAIN	77 00 311 216 , 36402-00QAA , 45 00 250 , 44 03 487 , 9111487 , 9160550	
	2,2 dCi 90	ArG	12.2003		24.5258-0450.3	330824	FLEXIBLE FREIN	44 15 858 , 93183554 , 44230-00QAD , 77 01 059 963	
			11.2003		24.5111-0510.3	330819	FLEXIBLE FREIN	44 15 698 , 93182621 , 82 00 196 055 , 46201-00QAH	
			09.2000		24.3727-0762.2	580762	CABLE FREIN A MAIN	77 00 311 216 , 36402-00QAA , 45 00 250 , 44 03 487 , 9111487 , 9160550	
	2,5 D		07.1998	01.2001	24.3727-0762.2	580762	CABLE FREIN A MAIN	77 00 311 216 , 36402-00QAA , 45 00 250 , 44 03 487 , 9111487 , 9160550	
	2,5 dCi 100		10.2003		24.5111-0510.3	330819	FLEXIBLE FREIN	44 15 698 , 93182621 , 82 00 196 055 , 46201-00QAH	
		ArG	12.2003		24.5258-0450.3	330824	FLEXIBLE FREIN	44 15 858 , 93183554 , 44230-00QAD , 77 01 059 963	



					description	Références OE par référence ATE.		Références remplacées / divers
--	--	--	--	--	-------------	----------------------------------	--	--------------------------------

RENAULT

MASTER II Bus (JD/ND_) (98-)	2,5 dCi 100		10.2003		24.3727-0762.2	580762	CABLE FREIN A MAIN	77 00 311 216 , 36402-00QAA , 45 00 250 , 44 03 487 , 9111487 , 9160550	
	2,5 dCi 120	ArG	12.2003		24.5258-0450.3	330824	FLEXIBLE FREIN	44 15 858 , 93183554 , 44230-00QAD , 77 01 059 963	
			11.2003		24.5111-0510.3	330819	FLEXIBLE FREIN	44 15 698 , 93182621 , 82 00 196 055 , 46201-00QAH	
			10.2001		24.3727-0762.2	580762	CABLE FREIN A MAIN	77 00 311 216 , 36402-00QAA , 45 00 250 , 44 03 487 , 9111487 , 9160550	
	2,8 dTi		07.1998	10.2001	24.3727-0762.2	580762	CABLE FREIN A MAIN	77 00 311 216 , 36402-00QAA , 45 00 250 , 44 03 487 , 9111487 , 9160550	
	3,0 dCi 140	ArG	12.2003		24.5258-0450.3	330824	FLEXIBLE FREIN	44 15 858 , 93183554 , 44230-00QAD , 77 01 059 963	
			10.2003		24.5111-0510.3	330819	FLEXIBLE FREIN	44 15 698 , 93182621 , 82 00 196 055 , 46201-00QAH	
			10.2003		24.3727-0762.2	580762	CABLE FREIN A MAIN	77 00 311 216 , 36402-00QAA , 45 00 250 , 44 03 487 , 9111487 , 9160550	
MASTER II Kasten (FD_) (98-)	1,9 dCi 80		11.2003		24.5111-0510.3	330819	FLEXIBLE FREIN	44 15 698 , 93182621 , 82 00 196 055 , 46201-00QAH	
		ArG	12.2003		24.5258-0450.3	330824	FLEXIBLE FREIN	44 15 858 , 93183554 , 44230-00QAD , 77 01 059 963	
			11.2001		24.3727-0762.2	580762	CABLE FREIN A MAIN	77 00 311 216 , 36402-00QAA , 45 00 250 , 44 03 487 , 9111487 , 9160550	
	1,9 dTi	ArG	12.2003		24.5258-0450.3	330824	FLEXIBLE FREIN	44 15 858 , 93183554 , 44230-00QAD , 77 01 059 963	



					description	Références OE par référence ATE.		Références remplacées / divers
--	--	--	--	--	-------------	----------------------------------	--	--------------------------------

RENAULT

MASTER II Kasten (FD_) (98-)	1,9 dTi		11.2003		24.5111-0510.3	330819	FLEXIBLE FREIN	44 15 698 , 93182621 , 82 00 196 055 , 46201-00QAH	
			09.2000		24.3727-0762.2	580762	CABLE FREIN A MAIN	77 00 311 216 , 36402-00QAA , 45 00 250 , 44 03 487 , 9111487 , 9160550	
	2,2 dCi 90	ArG	12.2003		24.5258-0450.3	330824	FLEXIBLE FREIN	44 15 858 , 93183554 , 44230-00QAD , 77 01 059 963	
			11.2003		24.5111-0510.3	330819	FLEXIBLE FREIN	44 15 698 , 93182621 , 82 00 196 055 , 46201-00QAH	
			09.2000		24.3727-0762.2	580762	CABLE FREIN A MAIN	77 00 311 216 , 36402-00QAA , 45 00 250 , 44 03 487 , 9111487 , 9160550	
	2,5 D		08.2000	01.2001	24.3727-0762.2	580762	CABLE FREIN A MAIN	77 00 311 216 , 36402-00QAA , 45 00 250 , 44 03 487 , 9111487 , 9160550	
	2,5 dCi 100	ArG	12.2003		24.5258-0450.3	330824	FLEXIBLE FREIN	44 15 858 , 93183554 , 44230-00QAD , 77 01 059 963	
			10.2003		24.5111-0510.3	330819	FLEXIBLE FREIN	44 15 698 , 93182621 , 82 00 196 055 , 46201-00QAH	
			10.2003		24.3727-0762.2	580762	CABLE FREIN A MAIN	77 00 311 216 , 36402-00QAA , 45 00 250 , 44 03 487 , 9111487 , 9160550	
	2,5 dCi 120		11.2003		24.5111-0510.3	330819	FLEXIBLE FREIN	44 15 698 , 93182621 , 82 00 196 055 , 46201-00QAH	
		ArG	12.2003		24.5258-0450.3	330824	FLEXIBLE FREIN	44 15 858 , 93183554 , 44230-00QAD , 77 01 059 963	
			10.2001		24.3727-0762.2	580762	CABLE FREIN A MAIN	77 00 311 216 , 36402-00QAA , 45 00 250 , 44 03 487 , 9111487 , 9160550	







					description	Références OE par référence ATE.		Références remplacées / divers
--	--	--	--	--	-------------	----------------------------------	--	--------------------------------

RENAULT

MASTER II Kasten (FD_) (98-)	2,8 dTi		08.2000	10.2001	24.3727-0762.2	580762	CABLE FREIN A MAIN	77 00 311 216 , 36402-00QAA , 45 00 250 , 44 03 487 , 9111487 , 9160550	
	3,0 dCi 120		06.2005		24.5111-0510.3	330819	FLEXIBLE FREIN	44 15 698 , 93182621 , 82 00 196 055 , 46201-00QAH	
		ArG	06.2005		24.5258-0450.3	330824	FLEXIBLE FREIN	44 15 858 , 93183554 , 44230-00QAD , 77 01 059 963	
			06.2005		24.3727-0762.2	580762	CABLE FREIN A MAIN	77 00 311 216 , 36402-00QAA , 45 00 250 , 44 03 487 , 9111487 , 9160550	
	3,0 dCi 140		10.2003		24.5111-0510.3	330819	FLEXIBLE FREIN	44 15 698 , 93182621 , 82 00 196 055 , 46201-00QAH	
		ArG	12.2003		24.5258-0450.3	330824	FLEXIBLE FREIN	44 15 858 , 93183554 , 44230-00QAD , 77 01 059 963	
			10.2003		24.3727-0762.2	580762	CABLE FREIN A MAIN	77 00 311 216 , 36402-00QAA , 45 00 250 , 44 03 487 , 9111487 , 9160550	
	3,0 dCi 160		06.2005		24.5111-0510.3	330819	FLEXIBLE FREIN	44 15 698 , 93182621 , 82 00 196 055 , 46201-00QAH	
		ArG	06.2005		24.5258-0450.3	330824	FLEXIBLE FREIN	44 15 858 , 93183554 , 44230-00QAD , 77 01 059 963	
			06.2005		24.3727-0762.2	580762	CABLE FREIN A MAIN	77 00 311 216 , 36402-00QAA , 45 00 250 , 44 03 487 , 9111487 , 9160550	
MASTER II Pritsche/Fahrgestell (ED/HD/UD_) (98-)	2,2 dCi 90		11.2003		24.5111-0510.3	330819	FLEXIBLE FREIN	44 15 698 , 93182621 , 82 00 196 055 , 46201-00QAH	
		ArG	12.2003		24.5258-0450.3	330824	FLEXIBLE FREIN	44 15 858 , 93183554 , 44230-00QAD , 77 01 059 963	









				description	Références OE par référence ATE.	 Références remplacées / divers
---	---	--	---	-------------	--	--

RENAULT

MASTER II Pritsche/Fahrgestell (ED/HD/UD_) (98-)	2,2 dCi 90		09.2000		24.3727-0762.2	580762	CABLE FREIN A MAIN	77 00 311 216 , 36402-00QAA , 45 00 250 , 44 03 487 , 9111487 , 9160550	
	2,5 D		07.1998	01.2001	24.3727-0762.2	580762	CABLE FREIN A MAIN	77 00 311 216 , 36402-00QAA , 45 00 250 , 44 03 487 , 9111487 , 9160550	
	2,5 dCi 100	ArG	12.2003		24.5258-0450.3	330824	FLEXIBLE FREIN	44 15 858 , 93183554 , 44230-00QAD , 77 01 059 963	
			10.2003		24.5111-0510.3	330819	FLEXIBLE FREIN	44 15 698 , 93182621 , 82 00 196 055 , 46201-00QAH	
			10.2003		24.3727-0762.2	580762	CABLE FREIN A MAIN	77 00 311 216 , 36402-00QAA , 45 00 250 , 44 03 487 , 9111487 , 9160550	
	2,5 dCi 120	ArG	12.2003		24.5258-0450.3	330824	FLEXIBLE FREIN	44 15 858 , 93183554 , 44230-00QAD , 77 01 059 963	
			11.2003		24.5111-0510.3	330819	FLEXIBLE FREIN	44 15 698 , 93182621 , 82 00 196 055 , 46201-00QAH	
			10.2001		24.3727-0762.2	580762	CABLE FREIN A MAIN	77 00 311 216 , 36402-00QAA , 45 00 250 , 44 03 487 , 9111487 , 9160550	
	2,8 dTi		07.1998	10.2001	24.3727-0762.2	580762	CABLE FREIN A MAIN	77 00 311 216 , 36402-00QAA , 45 00 250 , 44 03 487 , 9111487 , 9160550	
	3,0 dCi 120		06.2005		24.5111-0510.3	330819	FLEXIBLE FREIN	44 15 698 , 93182621 , 82 00 196 055 , 46201-00QAH	
		ArG	06.2005		24.5258-0450.3	330824	FLEXIBLE FREIN	44 15 858 , 93183554 , 44230-00QAD , 77 01 059 963	







					description	Références OE par référence ATE.	 Références remplacées / divers
---	---	---	---	---	-------------	----------------------------------	--

RENAULT

MASTER II Pritsche/Fahrgestell (ED/HD/UD_) (98-)	3,0 dCi 120		06.2005		24.3727-0762.2	580762	CABLE FREIN A MAIN	77 00 311 216 , 36402-00QAA , 45 00 250 , 44 03 487 , 9111487 , 9160550	
	3,0 dCi 140		10.2003		24.5111-0510.3	330819	FLEXIBLE FREIN	44 15 698 , 93182621 , 82 00 196 055 , 46201-00QAH	
		ArG	11.2003		24.5258-0450.3	330824	FLEXIBLE FREIN	44 15 858 , 93183554 , 44230-00QAD , 77 01 059 963	
			10.2003		24.3727-0762.2	580762	CABLE FREIN A MAIN	77 00 311 216 , 36402-00QAA , 45 00 250 , 44 03 487 , 9111487 , 9160550	
	3,0 dCi 160	ArG	06.2005		24.5258-0450.3	330824	FLEXIBLE FREIN	44 15 858 , 93183554 , 44230-00QAD , 77 01 059 963	
			06.2005		24.5111-0510.3	330819	FLEXIBLE FREIN	44 15 698 , 93182621 , 82 00 196 055 , 46201-00QAH	
			06.2005		24.3727-0762.2	580762	CABLE FREIN A MAIN	77 00 311 216 , 36402-00QAA , 45 00 250 , 44 03 487 , 9111487 , 9160550	
TRAFIC II (JL/FL/EL) (01-)	1,9 dCi 100		03.2001		24.3727-0763.2	580763	CABLE FREIN A MAIN	36518-00QAA , 77 00 313 058 , 44 08 735 , 91165521	
			03.2001		24.3727-0764.2	580764	CABLE FREIN A MAIN	82 00 008 473 , 44 08 730 , 91165522	
	1,9 dCi 80		03.2001		24.3727-0764.2	580764	CABLE FREIN A MAIN	82 00 008 473 , 44 08 730 , 91165522	
			03.2001		24.3727-0763.2	580763	CABLE FREIN A MAIN	36518-00QAA , 77 00 313 058 , 44 08 735 , 91165521	
	2,0 16V		03.2001		24.3727-0763.2	580763	CABLE FREIN A MAIN	36518-00QAA , 77 00 313 058 , 44 08 735 , 91165521	



				<p>description</p>	<p>Références OE par référence ATE.</p>	 <p>Références remplacées / divers</p>
---	---	--	---	--------------------	---	---

RENAULT

Modèle	Motorisation	Date	ATE Ref. 1	ATE Ref. 2	Description	Références OE	Références remplacées / divers
TRAFIC II (JL/FL/EL) (01-)	2,0 16V	03.2001	24.3727-0764.2	580764	CABLE FREIN A MAIN	82 00 008 473 , 44 08 730 , 91165522	
	2,0 dCi	10.2006	24.3727-0764.2	580764	CABLE FREIN A MAIN	82 00 008 473 , 44 08 730 , 91165522	
		10.2006	24.3727-0763.2	580763	CABLE FREIN A MAIN	36518-00QAA , 77 00 313 058 , 44 08 735 , 91165521	
	2,5 dCi	10.2006	24.3727-0764.2	580764	CABLE FREIN A MAIN	82 00 008 473 , 44 08 730 , 91165522	
		10.2006	24.3727-0763.2	580763	CABLE FREIN A MAIN	36518-00QAA , 77 00 313 058 , 44 08 735 , 91165521	
		05.2003	24.3727-0763.2	580763	CABLE FREIN A MAIN	36518-00QAA , 77 00 313 058 , 44 08 735 , 91165521	
		05.2003	24.3727-0764.2	580764	CABLE FREIN A MAIN	82 00 008 473 , 44 08 730 , 91165522	

Nouvelles références disponibles - par applications

04/2007



	i				description	Références OE par référence ATE.	i Références remplacées / divers
--	----------	--	--	--	-------------	----------------------------------	--

SEAT

LEON I (1M1) (99-05)	1,4 i 16V		11.1999	07.2005	83.7838-0435.3	330834	FLEXIBLE FREIN	1J0 611 701	83.6238-0435.3
	1,6 i 16V		11.1999	07.2005	83.7838-0435.3	330834	FLEXIBLE FREIN	1J0 611 701	83.6238-0435.3
	1,8 i 20V		11.1999	07.2005	83.7838-0435.3	330834	FLEXIBLE FREIN	1J0 611 701	83.6238-0435.3
	1,8 T 20V		11.1999	07.2005	83.7838-0435.3	330834	FLEXIBLE FREIN	1J0 611 701	83.6238-0435.3
	1,9 SDI		11.1999	07.2005	83.7838-0435.3	330834	FLEXIBLE FREIN	1J0 611 701	83.6238-0435.3
	1,9 TDI		02.2001	07.2005	83.7838-0435.3	330834	FLEXIBLE FREIN	1J0 611 701	83.6238-0435.3
			11.1999	07.2005	83.7838-0435.3	330834	FLEXIBLE FREIN	1J0 611 701	83.6238-0435.3
TOLEDO II (1M2) (99-04)	1,6 i		10.1998	09.2004	83.7838-0435.3	330834	FLEXIBLE FREIN	1J0 611 701	83.6238-0435.3
	1,8 i 20V		10.1998	09.2004	83.7838-0435.3	330834	FLEXIBLE FREIN	1J0 611 701	83.6238-0435.3
	1,9 TDI		10.1998	09.2004	83.7838-0435.3	330834	FLEXIBLE FREIN	1J0 611 701	83.6238-0435.3
	2,3 i V5		10.1998	09.2004	83.7838-0435.3	330834	FLEXIBLE FREIN	1J0 611 701	83.6238-0435.3

Nouvelles références disponibles - par applications

04/2007



					description	Références OE par référence ATE.		Références remplacées / divers
--	--	--	--	--	-------------	----------------------------------	--	--------------------------------





SKODA

OCTAVIA I (97-06)	1,4 i		04.1999		83.7838-0435.3	330834	FLEXIBLE FREIN	1J0 611 701	83.6238-0435.3
	1,6 i		10.1996		83.7838-0435.3	330834	FLEXIBLE FREIN	1J0 611 701	83.6238-0435.3
	1,8 i 20V		10.1996		83.7838-0435.3	330834	FLEXIBLE FREIN	1J0 611 701	83.6238-0435.3
	1,8 i 20V Turbo		03.1998		83.7838-0435.3	330834	FLEXIBLE FREIN	1J0 611 701	83.6238-0435.3
	1,9 SDI		05.1997		83.7838-0435.3	330834	FLEXIBLE FREIN	1J0 611 701	83.6238-0435.3
	1,9 TDI		01.2003		83.7838-0435.3	330834	FLEXIBLE FREIN	1J0 611 701	83.6238-0435.3
			08.1997		83.7838-0435.3	330834	FLEXIBLE FREIN	1J0 611 701	83.6238-0435.3
			10.1996		83.7838-0435.3	330834	FLEXIBLE FREIN	1J0 611 701	83.6238-0435.3
	1,9 TDI 4x4		09.2000		83.7838-0435.3	330834	FLEXIBLE FREIN	1J0 611 701	83.6238-0435.3
	2,0 i		04.1999		83.7838-0435.3	330834	FLEXIBLE FREIN	1J0 611 701	83.6238-0435.3
	RS 1,8 T 20V		01.2003		83.7838-0435.3	330834	FLEXIBLE FREIN	1J0 611 701	83.6238-0435.3

SUZUKI

WAGON R+ (00-)	1,3 i 16V	AvD	05.2000		24.3481-1758.5	240326	ETRIER A GRIFFE	9195322 , 55101-83E00 , 47 01 930	
		AvG	05.2000		24.3481-1757.5	240325	ETRIER A GRIFFE	9195321 , 55102-83E00 , 47 01 929	
	1,3 i 16V 4WD	AvG	10.2001		24.3481-1757.5	240325	ETRIER A GRIFFE	9195321 , 55102-83E00 , 47 01 929	
		AvD	10.2001		24.3481-1758.5	240326	ETRIER A GRIFFE	9195322 , 55101-83E00 , 47 01 930	



				<p>description</p>	<p>Références OE par référence ATE.</p>	 <p>Références remplacées / divers</p>
---	---	--	---	--------------------	---	---

TOYOTA

Modèle	Version	04.2003	01.2001 - 03.2003	24.3219-1744.3	020488	Description	Références OE	
YARIS (99-)	1,0 i 16V			24.3219-1744.3	020488	CYLINDRE DE ROUE	47550-0D010	
		01.2001	03.2003	24.3219-1744.3	020488	CYLINDRE DE ROUE	47550-0D010	
	1,3 i 16V	04.2002		24.3219-1744.3	020488	CYLINDRE DE ROUE	47550-0D010	
	1,4 D-4D	12.2001	03.2003	24.3219-1744.3	020488	CYLINDRE DE ROUE	47550-0D010	

Nouvelles références disponibles - par applications

04/2007



					description	Références OE par référence ATE.		Références remplacées / divers
--	--	--	--	--	-------------	----------------------------------	--	--------------------------------

VOLKSWAGEN

BEETLE (98-)	1,4		08.2001		83.7838-0435.3	330834	FLEXIBLE FREIN	1J0 611 701	83.6238-0435.3
	1,6		11.1999		83.7838-0435.3	330834	FLEXIBLE FREIN	1J0 611 701	83.6238-0435.3
	1,8 T		10.1999		83.7838-0435.3	330834	FLEXIBLE FREIN	1J0 611 701	83.6238-0435.3
	1,9 TDI		01.1998	02.2001	83.7838-0435.3	330834	FLEXIBLE FREIN	1J0 611 701	83.6238-0435.3
			10.2000		83.7838-0435.3	330834	FLEXIBLE FREIN	1J0 611 701	83.6238-0435.3
			07.2005		83.7838-0435.3	330834	FLEXIBLE FREIN	1J0 611 701	83.6238-0435.3
	2		01.1998		83.7838-0435.3	330834	FLEXIBLE FREIN	1J0 611 701	83.6238-0435.3
	2,3 V5		01.1999	12.2005	83.7838-0435.3	330834	FLEXIBLE FREIN	1J0 611 701	83.6238-0435.3
	3,2 RSI		04.2000	03.2003	83.7838-0435.3	330834	FLEXIBLE FREIN	1J0 611 701	83.6238-0435.3
VW BEETLE Décapotable (03-)	1,4		01.2003		83.7838-0435.3	330834	FLEXIBLE FREIN	1J0 611 701	83.6238-0435.3
	1,6		01.2003		83.7838-0435.3	330834	FLEXIBLE FREIN	1J0 611 701	83.6238-0435.3
	1,8 T		12.2003		83.7838-0435.3	330834	FLEXIBLE FREIN	1J0 611 701	83.6238-0435.3
	1,9 TDI		07.2003		83.7838-0435.3	330834	FLEXIBLE FREIN	1J0 611 701	83.6238-0435.3
			07.2005		83.7838-0435.3	330834	FLEXIBLE FREIN	1J0 611 701	83.6238-0435.3
	2		01.2003		83.7838-0435.3	330834	FLEXIBLE FREIN	1J0 611 701	83.6238-0435.3
BORA (98-04)	1,4 16V		09.1998	12.2004	83.7838-0435.3	330834	FLEXIBLE FREIN	1J0 611 701	83.6238-0435.3
	1,6		09.1998	12.2004	83.7838-0435.3	330834	FLEXIBLE FREIN	1J0 611 701	83.6238-0435.3
	1,6 16V		02.2000	12.2004	83.7838-0435.3	330834	FLEXIBLE FREIN	1J0 611 701	83.6238-0435.3
	1,6 FSI		01.2002	12.2004	83.7838-0435.3	330834	FLEXIBLE FREIN	1J0 611 701	83.6238-0435.3

Nouvelles références disponibles - par applications

04/2007



					description	Références OE par référence ATE.		Références remplacées / divers
--	--	--	--	--	-------------	----------------------------------	--	--------------------------------

VOLKSWAGEN

BORA (98-04)	1,8		09.1998	12.2004	83.7838-0435.3	330834	FLEXIBLE FREIN	1J0 611 701	83.6238-0435.3
	1,8 4motion		02.1999	08.2000	83.7838-0435.3	330834	FLEXIBLE FREIN	1J0 611 701	83.6238-0435.3
	1,8 T		05.2002	12.2004	83.7838-0435.3	330834	FLEXIBLE FREIN	1J0 611 701	83.6238-0435.3
			09.2000	12.2004	83.7838-0435.3	330834	FLEXIBLE FREIN	1J0 611 701	83.6238-0435.3
	1,9 SDI		09.1998	12.2004	83.7838-0435.3	330834	FLEXIBLE FREIN	1J0 611 701	83.6238-0435.3
	1,9 TDI		02.1999	06.2001	83.7838-0435.3	330834	FLEXIBLE FREIN	1J0 611 701	83.6238-0435.3
			04.2001	12.2004	83.7838-0435.3	330834	FLEXIBLE FREIN	1J0 611 701	83.6238-0435.3
			09.2000	12.2004	83.7838-0435.3	330834	FLEXIBLE FREIN	1J0 611 701	83.6238-0435.3
			10.2000	12.2004	83.7838-0435.3	330834	FLEXIBLE FREIN	1J0 611 701	83.6238-0435.3
			09.1998	06.2001	83.7838-0435.3	330834	FLEXIBLE FREIN	1J0 611 701	83.6238-0435.3
	1,9 TDI 4motion		02.1999	08.2000	83.7838-0435.3	330834	FLEXIBLE FREIN	1J0 611 701	83.6238-0435.3
	2		09.1998	12.2004	83.7838-0435.3	330834	FLEXIBLE FREIN	1J0 611 701	83.6238-0435.3
	2,0 4motion		04.2000	08.2000	83.7838-0435.3	330834	FLEXIBLE FREIN	1J0 611 701	83.6238-0435.3
	2,3 V5		09.1998	12.2004	83.7838-0435.3	330834	FLEXIBLE FREIN	1J0 611 701	83.6238-0435.3
	2,3 V5 4motion		02.1999	08.2000	83.7838-0435.3	330834	FLEXIBLE FREIN	1J0 611 701	83.6238-0435.3
	2,8 V6 4motion		05.1999	08.2000	83.7838-0435.3	330834	FLEXIBLE FREIN	1J0 611 701	83.6238-0435.3
GOLF IV (98-03)	1,4		10.1997	10.2003	83.7838-0435.3	330834	FLEXIBLE FREIN	1J0 611 701	83.6238-0435.3
	1,6		10.1997	10.2003	83.7838-0435.3	330834	FLEXIBLE FREIN	1J0 611 701	83.6238-0435.3
	1,6 FSI		01.2002	10.2003	83.7838-0435.3	330834	FLEXIBLE FREIN	1J0 611 701	83.6238-0435.3

Nouvelles références disponibles - par applications

04/2007



					description	Références OE par référence ATE.		Références remplacées / divers
--	--	--	--	--	-------------	----------------------------------	--	--------------------------------

VOLKSWAGEN

GOLF IV (98-03)	1,8		10.1997	10.2003	83.7838-0435.3	330834	FLEXIBLE FREIN	1J0 611 701	83.6238-0435.3
	1,8 T GTI		10.1997	10.2003	83.7838-0435.3	330834	FLEXIBLE FREIN	1J0 611 701	83.6238-0435.3
	1,9 SDI		10.1997	10.2003	83.7838-0435.3	330834	FLEXIBLE FREIN	1J0 611 701	83.6238-0435.3
	1,9 TDI		04.2001	10.2003	83.7838-0435.3	330834	FLEXIBLE FREIN	1J0 611 701	83.6238-0435.3
			09.2000	10.2003	83.7838-0435.3	330834	FLEXIBLE FREIN	1J0 611 701	83.6238-0435.3
			10.1997	06.2001	83.7838-0435.3	330834	FLEXIBLE FREIN	1J0 611 701	83.6238-0435.3
			05.1999	06.2001	83.7838-0435.3	330834	FLEXIBLE FREIN	1J0 611 701	83.6238-0435.3
	2		08.1998	10.2003	83.7838-0435.3	330834	FLEXIBLE FREIN	1J0 611 701	83.6238-0435.3
	2,3 V5		10.1997	10.2003	83.7838-0435.3	330834	FLEXIBLE FREIN	1J0 611 701	83.6238-0435.3
GOLF IV Variant (99-)	1,4		05.1999		83.7838-0435.3	330834	FLEXIBLE FREIN	1J0 611 701	83.6238-0435.3
	1,6		05.1999		83.7838-0435.3	330834	FLEXIBLE FREIN	1J0 611 701	83.6238-0435.3
	1,6 FSI		01.2002		83.7838-0435.3	330834	FLEXIBLE FREIN	1J0 611 701	83.6238-0435.3
	1,8 T		05.2000		83.7838-0435.3	330834	FLEXIBLE FREIN	1J0 611 701	83.6238-0435.3
	1,9 SDI		05.1999		83.7838-0435.3	330834	FLEXIBLE FREIN	1J0 611 701	83.6238-0435.3
	1,9 TDI		04.2001		83.7838-0435.3	330834	FLEXIBLE FREIN	1J0 611 701	83.6238-0435.3
			09.2000		83.7838-0435.3	330834	FLEXIBLE FREIN	1J0 611 701	83.6238-0435.3
			05.1999	06.2001	83.7838-0435.3	330834	FLEXIBLE FREIN	1J0 611 701	83.6238-0435.3
	2		05.1999		83.7838-0435.3	330834	FLEXIBLE FREIN	1J0 611 701	83.6238-0435.3
	2,3 V5		05.1999		83.7838-0435.3	330834	FLEXIBLE FREIN	1J0 611 701	83.6238-0435.3



					description	Références OE par référence ATE.		Références remplacées / divers
--	--	--	--	--	-------------	----------------------------------	--	--------------------------------

VOLKSWAGEN

POLO III (95-01)	1,4 16V		04.1996	09.2001	83.7838-0435.3	330834	FLEXIBLE FREIN	1J0 611 701	83.6238-0435.3
TRANSPORTER (T5) (03-)	1,9 TDI		06.2006		13.0460-7218.2	607218	PLAQUETTES DE FREIN	7H8 698 451	cf. Photo
			04.2003		13.0460-7218.2	607218	PLAQUETTES DE FREIN	7H8 698 451	cf. Photo
	2		06.2003		13.0460-7218.2	607218	PLAQUETTES DE FREIN	7H8 698 451	cf. Photo
	2,5 TDI		02.2003		13.0460-7218.2	607218	PLAQUETTES DE FREIN	7H8 698 451	cf. Photo
	2,5 TDI 4motion		07.2004		13.0460-7218.2	607218	PLAQUETTES DE FREIN	7H8 698 451	cf. Photo
	3,2 V6		02.2003		13.0460-7218.2	607218	PLAQUETTES DE FREIN	7H8 698 451	cf. Photo
	3,2 V6 4motion		07.2004		13.0460-7218.2	607218	PLAQUETTES DE FREIN	7H8 698 451	cf. Photo

VOLVO

XC90 (02-)	2,4 D5		05.2006		13.0460-7189.2	607189	PLAQUETTES DE FREIN	274330 , 274528	cf. Photo
			10.2002		13.0460-7189.2	607189	PLAQUETTES DE FREIN	274330 , 274528	cf. Photo
	2,5 T		10.2002		13.0460-7189.2	607189	PLAQUETTES DE FREIN	274330 , 274528	cf. Photo
	3,0 T6		10.2002		13.0460-7189.2	607189	PLAQUETTES DE FREIN	274330 , 274528	cf. Photo
	4,0 V8		01.2005		13.0460-7189.2	607189	PLAQUETTES DE FREIN	274330 , 274528	cf. Photo



13.0460-2713.2 602713

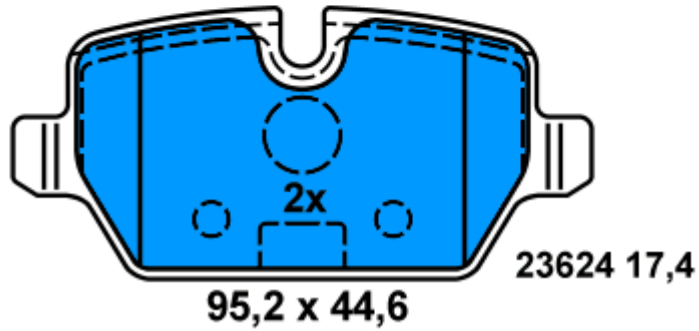
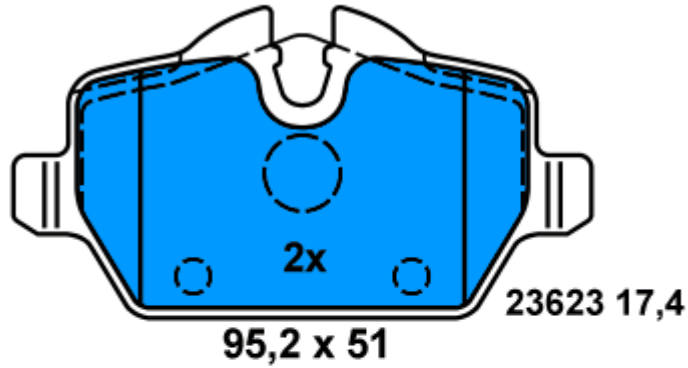
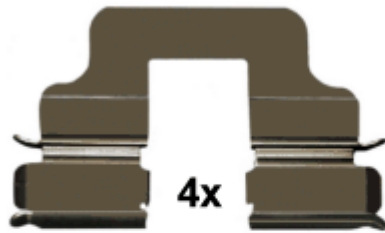

Applications:

BMW 1er Reihe/E87 5-T?rer/E81 3-T?rer (04-)
BMW 3er Reihe/E90 Limousine (05-)



13.0460-2899.2 602899

Applications:

JEEP CHEROKEE (KJ) (01-)
CHRYSLER VOYAGER (RG) (00-)

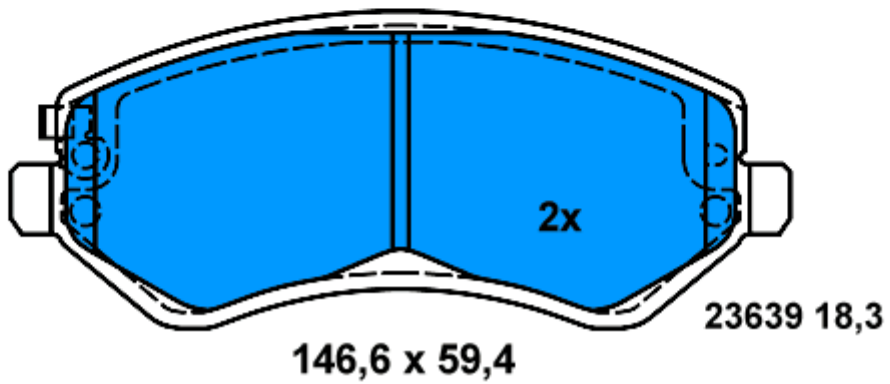
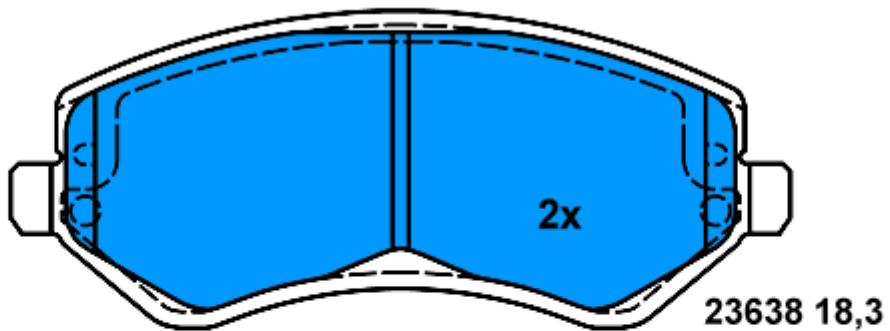



13.0460-5899.2 605899

Applications:

DAEWOO KALOS (02-05)
CHEVROLET KALOS (05-)

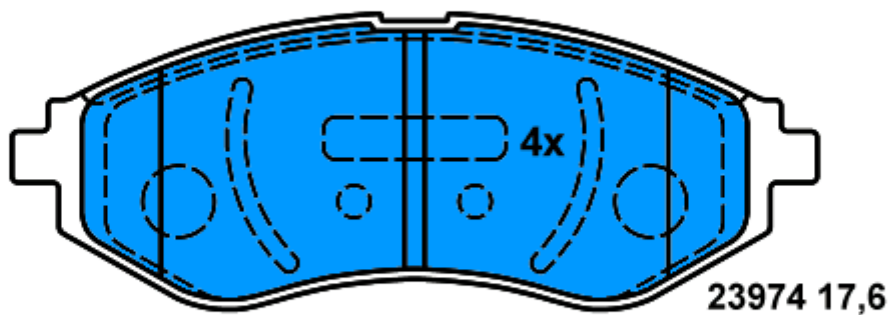

133 x 48,9



13.0460-7189.2 607189

Applications:

VOLVO XC90 (02-)

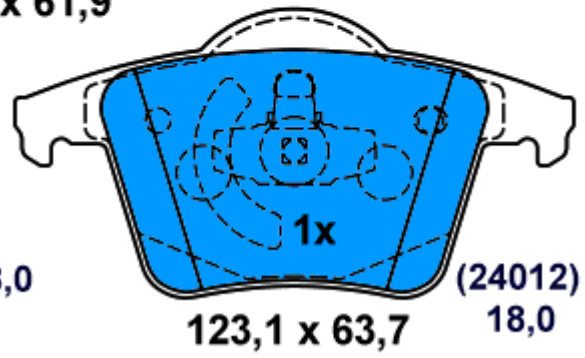
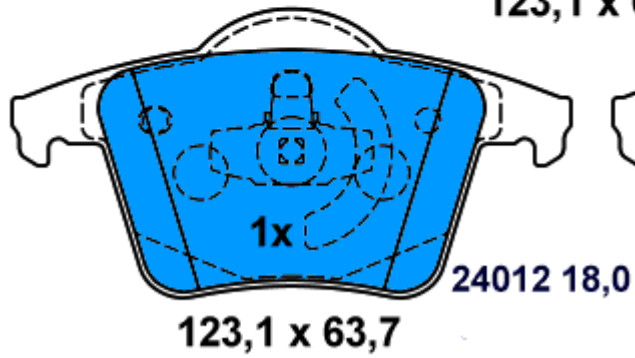
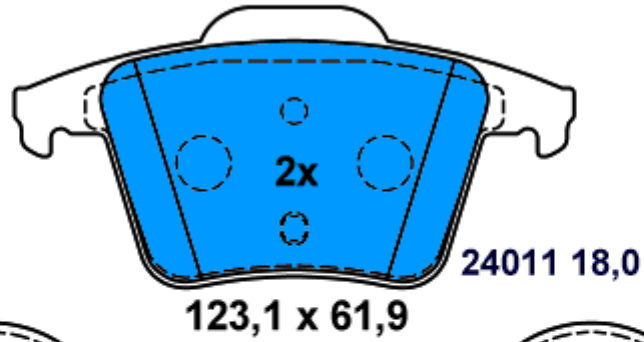



13.0460-7218.2 607218

Applications:

VOLKSWAGEN TRANSPORTER (T5) (03-)

