

Nouvelles références disponibles
par applications









02/2007



www.ate.de



					description	Références OE par référence ATE.	 Références remplacées / divers
---	---	---	---	---	-------------	--	---

ALFA ROMEO

Modèle	Version	Année 1	Année 2	Ref. 1	Ref. 2	Description	Ref. OE	Ref. Divers
145 (94-01)	1,4 i.e, T,Spark	01.1997	02.2001	03.0520-6722.3	696722	ATE TOPKIT		03.0520-5022.3
	1,6 i.e, T,Spark	01.1997	02.2001	03.0520-6722.3	696722	ATE TOPKIT		03.0520-5022.3
	1,9 JTD	02.1999	02.2001	03.0520-6722.3	696722	ATE TOPKIT		03.0520-5022.3
	2,0 TD	01.1997	02.1999	03.0520-6722.3	696722	ATE TOPKIT		03.0520-5022.3
146 (94-01)	1,4 i.e, T,Spark	01.1997	02.2001	03.0520-6722.3	696722	ATE TOPKIT		03.0520-5022.3
	1,6 i.e, T,Spark	01.1997	02.2001	03.0520-6722.3	696722	ATE TOPKIT		03.0520-5022.3
	1,9 JTD	02.1999	02.2001	03.0520-6722.3	696722	ATE TOPKIT		03.0520-5022.3
	2,0 TD	01.1997	02.1999	03.0520-6722.3	696722	ATE TOPKIT		03.0520-5022.3



					description	Références OE par référence ATE.		Références remplacées / divers
--	--	--	--	--	-------------	----------------------------------	--	--------------------------------

AUDI

200 Quattro (85-91)	2,2		03.1989	11.1990	83.7813-0252.3	330796	FLEXIBLE FREIN	441 611 707	83.6213-0252.3
A3 (96-03)	S3 Quattro	ArD	08.1998	06.2003	24.3384-1746.7	220610	ETRIER A GRIFFE	8N0 615 424 C , 8N0 615 424 B	
		ArG	08.1998	06.2003	24.3384-1745.7	220609	ETRIER A GRIFFE	8N0 615 423 C , 8N0 615 423 B	
A6 (C5) (97-04)	1,8 T Quattro			10.2004	24.3727-0178.2	580178	CABLE FREIN A MAIN	4B0 609 721 S , 4B0 609 721 AD	
	2,4 Quattro			10.2004	24.3727-0178.2	580178	CABLE FREIN A MAIN	4B0 609 721 S , 4B0 609 721 AD	
	2,5 TDI Quattro			10.2004	24.3727-0178.2	580178	CABLE FREIN A MAIN	4B0 609 721 S , 4B0 609 721 AD	
	2,7 T Quattro			10.2004	24.3727-0178.2	580178	CABLE FREIN A MAIN	4B0 609 721 S , 4B0 609 721 AD	
	2,8 Quattro			10.2004	24.3727-0178.2	580178	CABLE FREIN A MAIN	4B0 609 721 S , 4B0 609 721 AD	
	3,0 Quattro			10.2004	24.3727-0178.2	580178	CABLE FREIN A MAIN	4B0 609 721 S , 4B0 609 721 AD	
	4,2 Quattro		11.1998	10.2004	24.0122-0222.1	422222	DISQUE DE FREIN	4B3 615 601	
				10.2004	24.3727-0178.2	580178	CABLE FREIN A MAIN	4B0 609 721 S , 4B0 609 721 AD	
	S6 4,2		09.1999	10.2004	24.0122-0222.1	422222	DISQUE DE FREIN	4B3 615 601	
				10.2004	24.3727-0178.2	580178	CABLE FREIN A MAIN	4B0 609 721 S , 4B0 609 721 AD	
A6 Allroad (00-05)	2,5 TDI			07.2005	24.3727-0178.2	580178	CABLE FREIN A MAIN	4B0 609 721 S , 4B0 609 721 AD	



					description	Références OE par référence ATE.		Références remplacées / divers
--	--	--	--	--	-------------	----------------------------------	--	--------------------------------

AUDI

A6 Allroad (00-05)	2,7 T			07.2005	24.3727-0178.2	580178	CABLE FREIN A MAIN	4B0 609 721 S , 4B0 609 721 AD	
	4,2			07.2005	24.3727-0178.2	580178	CABLE FREIN A MAIN	4B0 609 721 S , 4B0 609 721 AD	
A8 (03-)	3			07.2003	24.0136-0103.1	436103	DISQUE DE FREIN	4E0 615 301 K , 4E0 615 301 E	
	3,0 TDI Quattro			11.2003	24.0136-0103.1	436103	DISQUE DE FREIN	4E0 615 301 K , 4E0 615 301 E	
	3,2 FSI			06.2005	24.0136-0103.1	436103	DISQUE DE FREIN	4E0 615 301 K , 4E0 615 301 E	
	3,2 FSI Quattro			06.2005	24.0136-0103.1	436103	DISQUE DE FREIN	4E0 615 301 K , 4E0 615 301 E	
	3,7 Quattro			11.2002	24.0136-0103.1	436103	DISQUE DE FREIN	4E0 615 301 K , 4E0 615 301 E	
	4,0 TDI Quattro			03.2003	24.0136-0103.1	436103	DISQUE DE FREIN	4E0 615 301 K , 4E0 615 301 E	
	4,2 FSI Quattro			06.2006	24.0136-0103.1	436103	DISQUE DE FREIN	4E0 615 301 K , 4E0 615 301 E	
	4,2 Quattro			11.2002	24.0136-0103.1	436103	DISQUE DE FREIN	4E0 615 301 K , 4E0 615 301 E	
	4,2 TDI Quattro			07.2005	24.0136-0103.1	436103	DISQUE DE FREIN	4E0 615 301 K , 4E0 615 301 E	
	6,0 W12 Quattro			02.2004	24.0136-0103.1	436103	DISQUE DE FREIN	4E0 615 301 K , 4E0 615 301 E	
	S8			06.2006	24.0136-0103.1	436103	DISQUE DE FREIN	4E0 615 301 K , 4E0 615 301 E	

Nouvelles références disponibles - par applications

02/2007



					description	Références OE par référence ATE.		Références remplacées / divers
--	--	--	--	--	-------------	----------------------------------	--	--------------------------------

AUDI

TT Coupe (98-06)	1,8 T Quattro	ArD	09.2005		24.3384-1746.7	220610	ETRIER A GRIFFE	8N0 615 424 C , 8N0 615 424 B	
		ArG	09.2005		24.3384-1745.7	220609	ETRIER A GRIFFE	8N0 615 423 C , 8N0 615 423 B	
		ArD	03.2005	06.2006	24.3384-1746.7	220610	ETRIER A GRIFFE	8N0 615 424 C , 8N0 615 424 B	
		ArD	10.1998		24.3384-1746.7	220610	ETRIER A GRIFFE	8N0 615 424 C , 8N0 615 424 B	
		ArG	03.2005	06.2006	24.3384-1745.7	220609	ETRIER A GRIFFE	8N0 615 423 C , 8N0 615 423 B	
		ArG		06.2006	24.3384-1745.7	220609	ETRIER A GRIFFE	8N0 615 423 C , 8N0 615 423 B	
		ArG	10.1998		24.3384-1745.7	220609	ETRIER A GRIFFE	8N0 615 423 C , 8N0 615 423 B	
		ArD		06.2006	24.3384-1746.7	220610	ETRIER A GRIFFE	8N0 615 424 C , 8N0 615 424 B	
	3,2 Quattro	ArD	04.2003	06.2006	24.3384-1746.7	220610	ETRIER A GRIFFE	8N0 615 424 C , 8N0 615 424 B	
		ArG	04.2003	06.2006	24.3384-1745.7	220609	ETRIER A GRIFFE	8N0 615 423 C , 8N0 615 423 B	
TT Roadster (99-06)	1,8 T Quattro	ArD	09.2005	06.2006	24.3384-1746.7	220610	ETRIER A GRIFFE	8N0 615 424 C , 8N0 615 424 B	
		ArD	10.1999		24.3384-1746.7	220610	ETRIER A GRIFFE	8N0 615 424 C , 8N0 615 424 B	
		ArG	09.2005	06.2006	24.3384-1745.7	220609	ETRIER A GRIFFE	8N0 615 423 C , 8N0 615 423 B	



					description	Références OE par référence ATE.		Références remplacées / divers
--	--	--	--	--	-------------	----------------------------------	--	--------------------------------

AUDI

TT Roadster (99-06)	1,8 T Quattro	ArG		06.2006	24.3384-1745.7	220609	ETRIER A GRIFFE	8N0 615 423 C , 8N0 615 423 B	
		ArG	10.1999		24.3384-1745.7	220609	ETRIER A GRIFFE	8N0 615 423 C , 8N0 615 423 B	
		ArD		06.2006	24.3384-1746.7	220610	ETRIER A GRIFFE	8N0 615 424 C , 8N0 615 424 B	
	3,2 Quattro	ArD	04.2003	06.2006	24.3384-1746.7	220610	ETRIER A GRIFFE	8N0 615 424 C , 8N0 615 424 B	
		ArG	04.2003	06.2006	24.3384-1745.7	220609	ETRIER A GRIFFE	8N0 615 423 C , 8N0 615 423 B	
V8 (88-94)	3,6		10.1988	02.1994	83.7813-0252.3	330796	FLEXIBLE FREIN	441 611 707	83.6213-0252.3
	4,2		10.1991	02.1994	83.7813-0252.3	330796	FLEXIBLE FREIN	441 611 707	83.6213-0252.3

Nouvelles références disponibles - par applications

02/2007



					description	Références OE par référence ATE.		Références remplacées / divers
--	--	--	--	--	-------------	----------------------------------	--	--------------------------------

BMW

Série 1/E87 (04-)	120 d		09.2004		13.0460-7217.2	607217	PLAQUETTES DE FREIN	34 21 6 767 150 , 34 21 6 773 161	cf. Photo
	130 i		09.2005		13.0460-7217.2	607217	PLAQUETTES DE FREIN	34 21 6 767 150 , 34 21 6 773 161	cf. Photo
2,5/2,8/3,0/3,3 (68-77)	2,8	ArG	01.1975	12.1977	83.7704-0200.3	330825	FLEXIBLE FREIN	34 32 1 108 134 , 34 32 1 115 697 , 34 32 1 153 107 , 34 32 1 159 881 , 34 32 4 051 524 , 700 1 36 005 2	83.6104-0200.3
	2500	ArG	01.1969	12.1977	83.7704-0200.3	330825	FLEXIBLE FREIN	34 32 1 108 134 , 34 32 1 115 697 , 34 32 1 153 107 , 34 32 1 159 881 , 34 32 4 051 524 , 700 1 36 005 2	83.6104-0200.3
	2800	ArG	01.1969	12.1977	83.7704-0200.3	330825	FLEXIBLE FREIN	34 32 1 108 134 , 34 32 1 115 697 , 34 32 1 153 107 , 34 32 1 159 881 , 34 32 4 051 524 , 700 1 36 005 2	83.6104-0200.3
	3,0 S/LS	ArG	01.1971	12.1977	83.7704-0200.3	330825	FLEXIBLE FREIN	34 32 1 108 134 , 34 32 1 115 697 , 34 32 1 153 107 , 34 32 1 159 881 , 34 32 4 051 524 , 700 1 36 005 2	83.6104-0200.3
	3,3	ArG	01.1974	12.1977	83.7704-0200.3	330825	FLEXIBLE FREIN	34 32 1 108 134 , 34 32 1 115 697 , 34 32 1 153 107 , 34 32 1 159 881 , 34 32 4 051 524 , 700 1 36 005 2	83.6104-0200.3
Série 3/E21 (75-83)	315	ArG	04.1981	12.1983	83.7704-0200.3	330825	FLEXIBLE FREIN	34 32 1 108 134 , 34 32 1 115 697 , 34 32 1 153 107 , 34 32 1 159 881 , 34 32 4 051 524 , 700 1 36 005 2	83.6104-0200.3
	316	ArG	06.1975	07.1983	83.7704-0200.3	330825	FLEXIBLE FREIN	34 32 1 108 134 , 34 32 1 115 697 , 34 32 1 153 107 , 34 32 1 159 881 , 34 32 4 051 524 , 700 1 36 005 2	83.6104-0200.3

Nouvelles références disponibles - par applications

02/2007



					description	Références OE par référence ATE.		Références remplacées / divers
--	--	--	--	--	-------------	----------------------------------	--	--------------------------------







BMW

Série 3/E21 (75-83)	318	ArG	06.1975	08.1980	83.7704-0200.3	330825	FLEXIBLE FREIN	34 32 1 108 134 , 34 32 1 115 697 , 34 32 1 153 107 , 34 32 1 159 881 , 34 32 4 051 524 , 700 1 36 005 2	83.6104-0200.3
	318 i	ArG	09.1979	12.1983	83.7704-0200.3	330825	FLEXIBLE FREIN	34 32 1 108 134 , 34 32 1 115 697 , 34 32 1 153 107 , 34 32 1 159 881 , 34 32 4 051 524 , 700 1 36 005 2	83.6104-0200.3
	320 i	ArG	10.1975	07.1978	83.7704-0200.3	330825	FLEXIBLE FREIN	34 32 1 108 134 , 34 32 1 115 697 , 34 32 1 153 107 , 34 32 1 159 881 , 34 32 4 051 524 , 700 1 36 005 2	83.6104-0200.3
		ArG	09.1978	09.1982	83.7704-0200.3	330825	FLEXIBLE FREIN	34 32 1 108 134 , 34 32 1 115 697 , 34 32 1 153 107 , 34 32 1 159 881 , 34 32 4 051 524 , 700 1 36 005 2	83.6104-0200.3
	320/4	ArG	06.1975	07.1979	83.7704-0200.3	330825	FLEXIBLE FREIN	34 32 1 108 134 , 34 32 1 115 697 , 34 32 1 153 107 , 34 32 1 159 881 , 34 32 4 051 524 , 700 1 36 005 2	83.6104-0200.3
	320/6	ArG	08.1977	10.1982	83.7704-0200.3	330825	FLEXIBLE FREIN	34 32 1 108 134 , 34 32 1 115 697 , 34 32 1 153 107 , 34 32 1 159 881 , 34 32 4 051 524 , 700 1 36 005 2	83.6104-0200.3
	323 i	ArG	01.1978	10.1982	83.7704-0200.3	330825	FLEXIBLE FREIN	34 32 1 108 134 , 34 32 1 115 697 , 34 32 1 153 107 , 34 32 1 159 881 , 34 32 4 051 524 , 700 1 36 005 2	83.6104-0200.3
Série 3/E30 (82-93)	316	ArG	03.1982	07.1988	83.7704-0200.3	330825	FLEXIBLE FREIN	34 32 1 108 134 , 34 32 1 115 697 , 34 32 1 153 107 , 34 32 1 159 881 , 34 32 4 051 524 , 700 1 36 005 2	83.6104-0200.3

Nouvelles références disponibles - par applications

02/2007



						description	Références OE par référence ATE.		Références remplacées / divers
---	---	---	---	---	--	-------------	----------------------------------	---	--------------------------------





BMW

Série 3/E30 (82-93)	316 i	ArG	07.1987	12.1991	83.7704-0200.3	330825	FLEXIBLE FREIN	34 32 1 108 134 , 34 32 1 115 697 , 34 32 1 153 107 , 34 32 1 159 881 , 34 32 4 051 524 , 700 1 36 005 2	83.6104-0200.3
	316 i Touring	ArG	06.1991	06.1994	83.7704-0200.3	330825	FLEXIBLE FREIN	34 32 1 108 134 , 34 32 1 115 697 , 34 32 1 153 107 , 34 32 1 159 881 , 34 32 4 051 524 , 700 1 36 005 2	83.6104-0200.3
	318 i	ArG	03.1982	12.1991	83.7704-0200.3	330825	FLEXIBLE FREIN	34 32 1 108 134 , 34 32 1 115 697 , 34 32 1 153 107 , 34 32 1 159 881 , 34 32 4 051 524 , 700 1 36 005 2	83.6104-0200.3
	318 i Cabrio	ArG	07.1990	05.1993	83.7704-0200.3	330825	FLEXIBLE FREIN	34 32 1 108 134 , 34 32 1 115 697 , 34 32 1 153 107 , 34 32 1 159 881 , 34 32 4 051 524 , 700 1 36 005 2	83.6104-0200.3
	318 i Touring	ArG	09.1987	06.1994	83.7704-0200.3	330825	FLEXIBLE FREIN	34 32 1 108 134 , 34 32 1 115 697 , 34 32 1 153 107 , 34 32 1 159 881 , 34 32 4 051 524 , 700 1 36 005 2	83.6104-0200.3
	318 iS	ArG	02.1989	12.1991	83.7704-0200.3	330825	FLEXIBLE FREIN	34 32 1 108 134 , 34 32 1 115 697 , 34 32 1 153 107 , 34 32 1 159 881 , 34 32 4 051 524 , 700 1 36 005 2	83.6104-0200.3
	320 i	ArG	01.1982	12.1991	83.7704-0200.3	330825	FLEXIBLE FREIN	34 32 1 108 134 , 34 32 1 115 697 , 34 32 1 153 107 , 34 32 1 159 881 , 34 32 4 051 524 , 700 1 36 005 2	83.6104-0200.3
		ArG	09.1987	12.1991	83.7704-0200.3	330825	FLEXIBLE FREIN	34 32 1 108 134 , 34 32 1 115 697 , 34 32 1 153 107 , 34 32 1 159 881 , 34 32 4 051 524 , 700 1 36 005 2	83.6104-0200.3

Nouvelles références disponibles - par applications

02/2007



				description	Références OE par référence ATE.	 Références remplacées / divers
---	---	--	---	-------------	--	---







BMW

Série 3/E30 (82-93)	320 i Cabrio	ArG	04.1986	12.1992	83.7704-0200.3	330825	FLEXIBLE FREIN	34 32 1 108 134 , 34 32 1 115 697 , 34 32 1 153 107 , 34 32 1 159 881 , 34 32 4 051 524 , 700 1 36 005 2	83.6104-0200.3
	320 i Touring	ArG	01.1988	09.1993	83.7704-0200.3	330825	FLEXIBLE FREIN	34 32 1 108 134 , 34 32 1 115 697 , 34 32 1 153 107 , 34 32 1 159 881 , 34 32 4 051 524 , 700 1 36 005 2	83.6104-0200.3
	320 iS	ArG	09.1987	12.1991	83.7704-0200.3	330825	FLEXIBLE FREIN	34 32 1 108 134 , 34 32 1 115 697 , 34 32 1 153 107 , 34 32 1 159 881 , 34 32 4 051 524 , 700 1 36 005 2	83.6104-0200.3
	323 i	ArG	09.1982	09.1986	83.7704-0200.3	330825	FLEXIBLE FREIN	34 32 1 108 134 , 34 32 1 115 697 , 34 32 1 153 107 , 34 32 1 159 881 , 34 32 4 051 524 , 700 1 36 005 2	83.6104-0200.3
	324 d	ArG	04.1985	12.1991	83.7704-0200.3	330825	FLEXIBLE FREIN	34 32 1 108 134 , 34 32 1 115 697 , 34 32 1 153 107 , 34 32 1 159 881 , 34 32 4 051 524 , 700 1 36 005 2	83.6104-0200.3
	324 td	ArG	02.1987	12.1991	83.7704-0200.3	330825	FLEXIBLE FREIN	34 32 1 108 134 , 34 32 1 115 697 , 34 32 1 153 107 , 34 32 1 159 881 , 34 32 4 051 524 , 700 1 36 005 2	83.6104-0200.3
	324 td Touring	ArG	01.1988	09.1993	83.7704-0200.3	330825	FLEXIBLE FREIN	34 32 1 108 134 , 34 32 1 115 697 , 34 32 1 153 107 , 34 32 1 159 881 , 34 32 4 051 524 , 700 1 36 005 2	83.6104-0200.3
	325 e	ArG	10.1983	09.1987	83.7704-0200.3	330825	FLEXIBLE FREIN	34 32 1 108 134 , 34 32 1 115 697 , 34 32 1 153 107 , 34 32 1 159 881 , 34 32 4 051 524 , 700 1 36 005 2	83.6104-0200.3

Nouvelles références disponibles - par applications

02/2007



					description	Références OE par référence ATE.		Références remplacées / divers
---	---	---	---	---	-------------	----------------------------------	---	--------------------------------







BMW

Série 3/E30 (82-93)	325 i	ArG	09.1983	12.1991	83.7704-0200.3	330825	FLEXIBLE FREIN	34 32 1 108 134 , 34 32 1 115 697 , 34 32 1 153 107 , 34 32 1 159 881 , 34 32 4 051 524 , 700 1 36 005 2	83.6104-0200.3
	325 i Cabrio	ArG	07.1985	12.1992	83.7704-0200.3	330825	FLEXIBLE FREIN	34 32 1 108 134 , 34 32 1 115 697 , 34 32 1 153 107 , 34 32 1 159 881 , 34 32 4 051 524 , 700 1 36 005 2	83.6104-0200.3
	325 i Touring	ArG	07.1987	09.1993	83.7704-0200.3	330825	FLEXIBLE FREIN	34 32 1 108 134 , 34 32 1 115 697 , 34 32 1 153 107 , 34 32 1 159 881 , 34 32 4 051 524 , 700 1 36 005 2	83.6104-0200.3
	325 iX	ArG	03.1986	12.1991	83.7704-0200.3	330825	FLEXIBLE FREIN	34 32 1 108 134 , 34 32 1 115 697 , 34 32 1 153 107 , 34 32 1 159 881 , 34 32 4 051 524 , 700 1 36 005 2	83.6104-0200.3
	325 iX Touring	ArG	03.1988	09.1993	83.7704-0200.3	330825	FLEXIBLE FREIN	34 32 1 108 134 , 34 32 1 115 697 , 34 32 1 153 107 , 34 32 1 159 881 , 34 32 4 051 524 , 700 1 36 005 2	83.6104-0200.3
	M3	ArG	07.1986	12.1991	83.7704-0200.3	330825	FLEXIBLE FREIN	34 32 1 108 134 , 34 32 1 115 697 , 34 32 1 153 107 , 34 32 1 159 881 , 34 32 4 051 524 , 700 1 36 005 2	83.6104-0200.3
	M3 Cabrio	ArG	06.1988	09.1992	83.7704-0200.3	330825	FLEXIBLE FREIN	34 32 1 108 134 , 34 32 1 115 697 , 34 32 1 153 107 , 34 32 1 159 881 , 34 32 4 051 524 , 700 1 36 005 2	83.6104-0200.3
Série 3/E36 (91-00)	316 i	ArG	12.1990	11.1991	83.7704-0200.3	330825	FLEXIBLE FREIN	34 32 1 108 134 , 34 32 1 115 697 , 34 32 1 153 107 , 34 32 1 159 881 , 34 32 4 051 524 , 700 1 36 005 2	83.6104-0200.3

Nouvelles références disponibles - par applications

02/2007



					description	Références OE par référence ATE.		Références remplacées / divers
---	---	---	---	---	-------------	----------------------------------	---	--------------------------------







BMW

Série 3/E36 (91-00)	316 i Compact 1,6	ArG	09.1993	08.2000	83.7704-0200.3	330825	FLEXIBLE FREIN	34 32 1 108 134 , 34 32 1 115 697 , 34 32 1 153 107 , 34 32 1 159 881 , 34 32 4 051 524 , 700 1 36 005 2	83.6104-0200.3
	316 i Compact 1,9	ArG	12.1998	08.2000	83.7704-0200.3	330825	FLEXIBLE FREIN	34 32 1 108 134 , 34 32 1 115 697 , 34 32 1 153 107 , 34 32 1 159 881 , 34 32 4 051 524 , 700 1 36 005 2	83.6104-0200.3
	316 i Touring	ArG	05.1997	10.1999	83.7704-0200.3	330825	FLEXIBLE FREIN	34 32 1 108 134 , 34 32 1 115 697 , 34 32 1 153 107 , 34 32 1 159 881 , 34 32 4 051 524 , 700 1 36 005 2	83.6104-0200.3
	318 i	ArG	12.1990	02.1998	83.7704-0200.3	330825	FLEXIBLE FREIN	34 32 1 108 134 , 34 32 1 115 697 , 34 32 1 153 107 , 34 32 1 159 881 , 34 32 4 051 524 , 700 1 36 005 2	83.6104-0200.3
		ArG	12.1990	11.1991	83.7704-0200.3	330825	FLEXIBLE FREIN	34 32 1 108 134 , 34 32 1 115 697 , 34 32 1 153 107 , 34 32 1 159 881 , 34 32 4 051 524 , 700 1 36 005 2	83.6104-0200.3
	318 i Cabrio	ArG	11.1993	04.1999	83.7704-0200.3	330825	FLEXIBLE FREIN	34 32 1 108 134 , 34 32 1 115 697 , 34 32 1 153 107 , 34 32 1 159 881 , 34 32 4 051 524 , 700 1 36 005 2	83.6104-0200.3
	318 i Touring	ArG	02.1995	10.1999	83.7704-0200.3	330825	FLEXIBLE FREIN	34 32 1 108 134 , 34 32 1 115 697 , 34 32 1 153 107 , 34 32 1 159 881 , 34 32 4 051 524 , 700 1 36 005 2	83.6104-0200.3
	318 iS	ArG	01.1992	02.1998	83.7704-0200.3	330825	FLEXIBLE FREIN	34 32 1 108 134 , 34 32 1 115 697 , 34 32 1 153 107 , 34 32 1 159 881 , 34 32 4 051 524 , 700 1 36 005 2	83.6104-0200.3

Nouvelles références disponibles - par applications

02/2007



						description	Références OE par référence ATE.		Références remplacées / divers
---	---	---	---	---	--	-------------	----------------------------------	---	--------------------------------







BMW

Série 3/E36 (91-00)	318 iS Coupe	ArG	01.1992	04.1999	83.7704-0200.3	330825	FLEXIBLE FREIN	34 32 1 108 134 , 34 32 1 115 697 , 34 32 1 153 107 , 34 32 1 159 881 , 34 32 4 051 524 , 700 1 36 005 2	83.6104-0200.3
	318 tds	ArG	01.1994	02.1998	83.7704-0200.3	330825	FLEXIBLE FREIN	34 32 1 108 134 , 34 32 1 115 697 , 34 32 1 153 107 , 34 32 1 159 881 , 34 32 4 051 524 , 700 1 36 005 2	83.6104-0200.3
	318 tds Compact	ArG	04.1994	08.2000	83.7704-0200.3	330825	FLEXIBLE FREIN	34 32 1 108 134 , 34 32 1 115 697 , 34 32 1 153 107 , 34 32 1 159 881 , 34 32 4 051 524 , 700 1 36 005 2	83.6104-0200.3
	318 tds Touring	ArG	10.1994	10.1999	83.7704-0200.3	330825	FLEXIBLE FREIN	34 32 1 108 134 , 34 32 1 115 697 , 34 32 1 153 107 , 34 32 1 159 881 , 34 32 4 051 524 , 700 1 36 005 2	83.6104-0200.3
	318 ti Compact	ArG	04.1994	08.2000	83.7704-0200.3	330825	FLEXIBLE FREIN	34 32 1 108 134 , 34 32 1 115 697 , 34 32 1 153 107 , 34 32 1 159 881 , 34 32 4 051 524 , 700 1 36 005 2	83.6104-0200.3
	320 i	ArG	12.1990	02.1998	83.7704-0200.3	330825	FLEXIBLE FREIN	34 32 1 108 134 , 34 32 1 115 697 , 34 32 1 153 107 , 34 32 1 159 881 , 34 32 4 051 524 , 700 1 36 005 2	83.6104-0200.3
	320 i Cabrio	ArG	11.1993	04.1999	83.7704-0200.3	330825	FLEXIBLE FREIN	34 32 1 108 134 , 34 32 1 115 697 , 34 32 1 153 107 , 34 32 1 159 881 , 34 32 4 051 524 , 700 1 36 005 2	83.6104-0200.3
	320 i Coupe	ArG	01.1992	04.1999	83.7704-0200.3	330825	FLEXIBLE FREIN	34 32 1 108 134 , 34 32 1 115 697 , 34 32 1 153 107 , 34 32 1 159 881 , 34 32 4 051 524 , 700 1 36 005 2	83.6104-0200.3

Nouvelles références disponibles - par applications

02/2007



					description	Références OE par référence ATE.		Références remplacées / divers
---	---	---	---	---	-------------	----------------------------------	---	--------------------------------







BMW

Série 3/E36 (91-00)	320 i Touring	ArG	05.1994	10.1999	83.7704-0200.3	330825	FLEXIBLE FREIN	34 32 1 108 134 , 34 32 1 115 697 , 34 32 1 153 107 , 34 32 1 159 881 , 34 32 4 051 524 , 700 1 36 005 2	83.6104-0200.3
	323 i	ArG	03.1995	02.1998	83.7704-0200.3	330825	FLEXIBLE FREIN	34 32 1 108 134 , 34 32 1 115 697 , 34 32 1 153 107 , 34 32 1 159 881 , 34 32 4 051 524 , 700 1 36 005 2	83.6104-0200.3
	323 i Cabrio	ArG	03.1995	04.1999	83.7704-0200.3	330825	FLEXIBLE FREIN	34 32 1 108 134 , 34 32 1 115 697 , 34 32 1 153 107 , 34 32 1 159 881 , 34 32 4 051 524 , 700 1 36 005 2	83.6104-0200.3
	323 i Coupe	ArG	03.1995	04.1999	83.7704-0200.3	330825	FLEXIBLE FREIN	34 32 1 108 134 , 34 32 1 115 697 , 34 32 1 153 107 , 34 32 1 159 881 , 34 32 4 051 524 , 700 1 36 005 2	83.6104-0200.3
	323 i Touring	ArG	07.1995	10.1999	83.7704-0200.3	330825	FLEXIBLE FREIN	34 32 1 108 134 , 34 32 1 115 697 , 34 32 1 153 107 , 34 32 1 159 881 , 34 32 4 051 524 , 700 1 36 005 2	83.6104-0200.3
	323 ti Compact	ArG	08.1997	08.2000	83.7704-0200.3	330825	FLEXIBLE FREIN	34 32 1 108 134 , 34 32 1 115 697 , 34 32 1 153 107 , 34 32 1 159 881 , 34 32 4 051 524 , 700 1 36 005 2	83.6104-0200.3
	325 i	ArG	12.1990	02.1998	83.7704-0200.3	330825	FLEXIBLE FREIN	34 32 1 108 134 , 34 32 1 115 697 , 34 32 1 153 107 , 34 32 1 159 881 , 34 32 4 051 524 , 700 1 36 005 2	83.6104-0200.3
	325 i Cabrio	ArG	08.1992	03.1995	83.7704-0200.3	330825	FLEXIBLE FREIN	34 32 1 108 134 , 34 32 1 115 697 , 34 32 1 153 107 , 34 32 1 159 881 , 34 32 4 051 524 , 700 1 36 005 2	83.6104-0200.3

Nouvelles références disponibles - par applications

02/2007



					description	Références OE par référence ATE.	 Références remplacées / divers
---	---	---	---	---	-------------	----------------------------------	--







BMW

Série 3/E36 (91-00)	325 i Coupe	ArG	01.1992	04.1999	83.7704-0200.3	330825	FLEXIBLE FREIN	34 32 1 108 134 , 34 32 1 115 697 , 34 32 1 153 107 , 34 32 1 159 881 , 34 32 4 051 524 , 700 1 36 005 2	83.6104-0200.3
	325 td	ArG	09.1991	02.1998	83.7704-0200.3	330825	FLEXIBLE FREIN	34 32 1 108 134 , 34 32 1 115 697 , 34 32 1 153 107 , 34 32 1 159 881 , 34 32 4 051 524 , 700 1 36 005 2	83.6104-0200.3
	325 tds	ArG	03.1993	02.1998	83.7704-0200.3	330825	FLEXIBLE FREIN	34 32 1 108 134 , 34 32 1 115 697 , 34 32 1 153 107 , 34 32 1 159 881 , 34 32 4 051 524 , 700 1 36 005 2	83.6104-0200.3
	325 tds Touring	ArG	10.1994	10.1999	83.7704-0200.3	330825	FLEXIBLE FREIN	34 32 1 108 134 , 34 32 1 115 697 , 34 32 1 153 107 , 34 32 1 159 881 , 34 32 4 051 524 , 700 1 36 005 2	83.6104-0200.3
	328 i	ArG	11.1994	02.1998	83.7704-0200.3	330825	FLEXIBLE FREIN	34 32 1 108 134 , 34 32 1 115 697 , 34 32 1 153 107 , 34 32 1 159 881 , 34 32 4 051 524 , 700 1 36 005 2	83.6104-0200.3
	328 i Cabrio	ArG	11.1994	04.1999	83.7704-0200.3	330825	FLEXIBLE FREIN	34 32 1 108 134 , 34 32 1 115 697 , 34 32 1 153 107 , 34 32 1 159 881 , 34 32 4 051 524 , 700 1 36 005 2	83.6104-0200.3
	328 i Coupe	ArG	11.1994	04.1999	83.7704-0200.3	330825	FLEXIBLE FREIN	34 32 1 108 134 , 34 32 1 115 697 , 34 32 1 153 107 , 34 32 1 159 881 , 34 32 4 051 524 , 700 1 36 005 2	83.6104-0200.3
	328 i Touring	ArG	10.1994	10.1999	83.7704-0200.3	330825	FLEXIBLE FREIN	34 32 1 108 134 , 34 32 1 115 697 , 34 32 1 153 107 , 34 32 1 159 881 , 34 32 4 051 524 , 700 1 36 005 2	83.6104-0200.3

Nouvelles références disponibles - par applications

02/2007



					description	Références OE par référence ATE.	 Références remplacées / divers
---	---	---	---	---	-------------	----------------------------------	--







BMW

Série 3/E90 Berline (05-)	318 d		09.2005		13.0460-7217.2	607217	PLAQUETTES DE FREIN	34 21 6 767 150 , 34 21 6 773 161	cf. Photo
	318 i		09.2005		13.0460-7217.2	607217	PLAQUETTES DE FREIN	34 21 6 767 150 , 34 21 6 773 161	cf. Photo
	320 d		12.2004		13.0460-7217.2	607217	PLAQUETTES DE FREIN	34 21 6 767 150 , 34 21 6 773 161	cf. Photo
			12.2004		13.0460-7216.2	607216	PLAQUETTES DE FREIN	34 11 6 771 868	cf. Photo
	320 si		06.2006		13.0460-7216.2	607216	PLAQUETTES DE FREIN	34 11 6 771 868	cf. Photo
			06.2006		13.0460-7217.2	607217	PLAQUETTES DE FREIN	34 21 6 767 150 , 34 21 6 773 161	cf. Photo
	325 d		09.2006		13.0460-7216.2	607216	PLAQUETTES DE FREIN	34 11 6 771 868	cf. Photo
	325 i		12.2004		13.0460-7216.2	607216	PLAQUETTES DE FREIN	34 11 6 771 868	cf. Photo
			12.2004		13.0460-7217.2	607217	PLAQUETTES DE FREIN	34 21 6 767 150 , 34 21 6 773 161	cf. Photo
	325 xi		01.2005		13.0460-7216.2	607216	PLAQUETTES DE FREIN	34 11 6 771 868	cf. Photo
			01.2005		13.0460-7217.2	607217	PLAQUETTES DE FREIN	34 21 6 767 150 , 34 21 6 773 161	cf. Photo
	330 d		09.2005		13.0460-7216.2	607216	PLAQUETTES DE FREIN	34 11 6 771 868	cf. Photo
	330 i		12.2004		13.0460-7216.2	607216	PLAQUETTES DE FREIN	34 11 6 771 868	cf. Photo
	330 xd		09.2005		13.0460-7216.2	607216	PLAQUETTES DE FREIN	34 11 6 771 868	cf. Photo
	330 xi		01.2005		13.0460-7216.2	607216	PLAQUETTES DE FREIN	34 11 6 771 868	cf. Photo
Série 3/E91 Touring (05-)	318 d		09.2005		13.0460-7216.2	607216	PLAQUETTES DE FREIN	34 11 6 771 868	cf. Photo

Nouvelles références disponibles - par applications

02/2007



					description	Références OE par référence ATE.		Références remplacées / divers
---	---	---	---	---	-------------	----------------------------------	---	--------------------------------

BMW

Série 3/E91 Touring (05-)	318 d		09.2005		13.0460-7217.2	607217	PLAQUETTES DE FREIN	34 21 6 767 150 , 34 21 6 773 161	cf. Photo
	318 i		01.2006		13.0460-7217.2	607217	PLAQUETTES DE FREIN	34 21 6 767 150 , 34 21 6 773 161	cf. Photo
			01.2006		13.0460-7216.2	607216	PLAQUETTES DE FREIN	34 11 6 771 868	cf. Photo
	320 d		06.2005		13.0460-7217.2	607217	PLAQUETTES DE FREIN	34 21 6 767 150 , 34 21 6 773 161	cf. Photo
			06.2005		13.0460-7216.2	607216	PLAQUETTES DE FREIN	34 11 6 771 868	cf. Photo
	320 i		06.2005		13.0460-7217.2	607217	PLAQUETTES DE FREIN	34 21 6 767 150 , 34 21 6 773 161	cf. Photo
			06.2005		13.0460-7216.2	607216	PLAQUETTES DE FREIN	34 11 6 771 868	cf. Photo
	323 i		06.2005		13.0460-7217.2	607217	PLAQUETTES DE FREIN	34 21 6 767 150 , 34 21 6 773 161	cf. Photo
			06.2005		13.0460-7216.2	607216	PLAQUETTES DE FREIN	34 11 6 771 868	cf. Photo
	325 d		09.2006		13.0460-7216.2	607216	PLAQUETTES DE FREIN	34 11 6 771 868	cf. Photo
	325 i		06.2005		13.0460-7216.2	607216	PLAQUETTES DE FREIN	34 11 6 771 868	cf. Photo
			06.2005		13.0460-7217.2	607217	PLAQUETTES DE FREIN	34 21 6 767 150 , 34 21 6 773 161	cf. Photo
	325 xi		06.2005		13.0460-7216.2	607216	PLAQUETTES DE FREIN	34 11 6 771 868	cf. Photo
	330 d		06.2005		13.0460-7216.2	607216	PLAQUETTES DE FREIN	34 11 6 771 868	cf. Photo
	330 i		06.2005		13.0460-7216.2	607216	PLAQUETTES DE FREIN	34 11 6 771 868	cf. Photo
	330 xd		06.2005		13.0460-7216.2	607216	PLAQUETTES DE FREIN	34 11 6 771 868	cf. Photo
	330 xi		06.2005		13.0460-7216.2	607216	PLAQUETTES DE FREIN	34 11 6 771 868	cf. Photo

Nouvelles références disponibles - par applications

02/2007



					description	Références OE par référence ATE.		Références remplacées / divers
--	--	--	--	--	-------------	----------------------------------	--	--------------------------------

BMW

3er Reihe/E92 Coupe (06-)	323 i		09.2006		13.0460-7216.2	607216	PLAQUETTES DE FREIN	34 11 6 771 868	cf. Photo
	325 i		09.2006		13.0460-7216.2	607216	PLAQUETTES DE FREIN	34 11 6 771 868	cf. Photo
	325 xi		09.2006		13.0460-7216.2	607216	PLAQUETTES DE FREIN	34 11 6 771 868	cf. Photo
	330 i		09.2006		13.0460-7216.2	607216	PLAQUETTES DE FREIN	34 11 6 771 868	cf. Photo
	330 xi		09.2006		13.0460-7216.2	607216	PLAQUETTES DE FREIN	34 11 6 771 868	cf. Photo
Série 5/E28 (81-87)	518	ArG	06.1981	09.1984	83.7704-0200.3	330825	FLEXIBLE FREIN	34 32 1 108 134 , 34 32 1 115 697 , 34 32 1 153 107 , 34 32 1 159 881 , 34 32 4 051 524 , 700 1 36 005 2	83.6104-0200.3
	518 i	ArG	11.1983	12.1987	83.7704-0200.3	330825	FLEXIBLE FREIN	34 32 1 108 134 , 34 32 1 115 697 , 34 32 1 153 107 , 34 32 1 159 881 , 34 32 4 051 524 , 700 1 36 005 2	83.6104-0200.3
	520 i	ArG	06.1981	03.1986	83.7704-0200.3	330825	FLEXIBLE FREIN	34 32 1 108 134 , 34 32 1 115 697 , 34 32 1 153 107 , 34 32 1 159 881 , 34 32 4 051 524 , 700 1 36 005 2	83.6104-0200.3
		ArG	04.1986	12.1987	83.7704-0200.3	330825	FLEXIBLE FREIN	34 32 1 108 134 , 34 32 1 115 697 , 34 32 1 153 107 , 34 32 1 159 881 , 34 32 4 051 524 , 700 1 36 005 2	83.6104-0200.3
	524 d	ArG	05.1986	12.1987	83.7704-0200.3	330825	FLEXIBLE FREIN	34 32 1 108 134 , 34 32 1 115 697 , 34 32 1 153 107 , 34 32 1 159 881 , 34 32 4 051 524 , 700 1 36 005 2	83.6104-0200.3
	524 td	ArG	09.1983	03.1986	83.7704-0200.3	330825	FLEXIBLE FREIN	34 32 1 108 134 , 34 32 1 115 697 , 34 32 1 153 107 , 34 32 1 159 881 , 34 32 4 051 524 , 700 1 36 005 2	83.6104-0200.3

Nouvelles références disponibles - par applications

02/2007



					description	Références OE par référence ATE.		Références remplacées / divers
--	--	--	--	--	-------------	----------------------------------	--	--------------------------------

BMW

Série 5/E28 (81-87)	524 td	ArG	04.1986	12.1987	83.7704-0200.3	330825	FLEXIBLE FREIN	34 32 1 108 134 , 34 32 1 115 697 , 34 32 1 153 107 , 34 32 1 159 881 , 34 32 4 051 524 , 700 1 36 005 2	83.6104-0200.3
	525 e	ArG	09.1981	12.1987	83.7704-0200.3	330825	FLEXIBLE FREIN	34 32 1 108 134 , 34 32 1 115 697 , 34 32 1 153 107 , 34 32 1 159 881 , 34 32 4 051 524 , 700 1 36 005 2	83.6104-0200.3
	525 i	ArG	02.1981	12.1987	83.7704-0200.3	330825	FLEXIBLE FREIN	34 32 1 108 134 , 34 32 1 115 697 , 34 32 1 153 107 , 34 32 1 159 881 , 34 32 4 051 524 , 700 1 36 005 2	83.6104-0200.3
	528 i	ArG	06.1981	12.1987	83.7704-0200.3	330825	FLEXIBLE FREIN	34 32 1 108 134 , 34 32 1 115 697 , 34 32 1 153 107 , 34 32 1 159 881 , 34 32 4 051 524 , 700 1 36 005 2	83.6104-0200.3
	535 i	ArG	01.1985	12.1987	83.7704-0200.3	330825	FLEXIBLE FREIN	34 32 1 108 134 , 34 32 1 115 697 , 34 32 1 153 107 , 34 32 1 159 881 , 34 32 4 051 524 , 700 1 36 005 2	83.6104-0200.3
	M 535 i	ArG	01.1985	12.1987	83.7704-0200.3	330825	FLEXIBLE FREIN	34 32 1 108 134 , 34 32 1 115 697 , 34 32 1 153 107 , 34 32 1 159 881 , 34 32 4 051 524 , 700 1 36 005 2	83.6104-0200.3
	M5	ArG	08.1985	12.1987	83.7704-0200.3	330825	FLEXIBLE FREIN	34 32 1 108 134 , 34 32 1 115 697 , 34 32 1 153 107 , 34 32 1 159 881 , 34 32 4 051 524 , 700 1 36 005 2	83.6104-0200.3
Série 5/E34 (88-96)	518 i	ArG	04.1989	09.1995	83.7704-0200.3	330825	FLEXIBLE FREIN	34 32 1 108 134 , 34 32 1 115 697 , 34 32 1 153 107 , 34 32 1 159 881 , 34 32 4 051 524 , 700 1 36 005 2	83.6104-0200.3

Nouvelles références disponibles - par applications

02/2007



					description	Références OE par référence ATE.		Références remplacées / divers
--	--	--	--	--	-------------	----------------------------------	--	--------------------------------







BMW

Série 5/E34 (88-96)	518 i Touring	ArG	03.1993	11.1996	83.7704-0200.3	330825	FLEXIBLE FREIN	34 32 1 108 134 , 34 32 1 115 697 , 34 32 1 153 107 , 34 32 1 159 881 , 34 32 4 051 524 , 700 1 36 005 2	83.6104-0200.3
	520 i	ArG	01.1988	09.1990	83.7704-0200.3	330825	FLEXIBLE FREIN	34 32 1 108 134 , 34 32 1 115 697 , 34 32 1 153 107 , 34 32 1 159 881 , 34 32 4 051 524 , 700 1 36 005 2	83.6104-0200.3
	520 i 24V	ArG	03.1989	09.1995	83.7704-0200.3	330825	FLEXIBLE FREIN	34 32 1 108 134 , 34 32 1 115 697 , 34 32 1 153 107 , 34 32 1 159 881 , 34 32 4 051 524 , 700 1 36 005 2	83.6104-0200.3
	520 i Touring	ArG	11.1991	11.1996	83.7704-0200.3	330825	FLEXIBLE FREIN	34 32 1 108 134 , 34 32 1 115 697 , 34 32 1 153 107 , 34 32 1 159 881 , 34 32 4 051 524 , 700 1 36 005 2	83.6104-0200.3
	524 td	ArG	03.1988	08.1991	83.7704-0200.3	330825	FLEXIBLE FREIN	34 32 1 108 134 , 34 32 1 115 697 , 34 32 1 153 107 , 34 32 1 159 881 , 34 32 4 051 524 , 700 1 36 005 2	83.6104-0200.3
	525 i	ArG	01.1988	09.1990	83.7704-0200.3	330825	FLEXIBLE FREIN	34 32 1 108 134 , 34 32 1 115 697 , 34 32 1 153 107 , 34 32 1 159 881 , 34 32 4 051 524 , 700 1 36 005 2	83.6104-0200.3
	525 i 24V	ArG	09.1989	09.1995	83.7704-0200.3	330825	FLEXIBLE FREIN	34 32 1 108 134 , 34 32 1 115 697 , 34 32 1 153 107 , 34 32 1 159 881 , 34 32 4 051 524 , 700 1 36 005 2	83.6104-0200.3
	525 i Touring	ArG	11.1991	11.1996	83.7704-0200.3	330825	FLEXIBLE FREIN	34 32 1 108 134 , 34 32 1 115 697 , 34 32 1 153 107 , 34 32 1 159 881 , 34 32 4 051 524 , 700 1 36 005 2	83.6104-0200.3

Nouvelles références disponibles - par applications

02/2007



						description	Références OE par référence ATE.		Références remplacées / divers
---	---	---	---	---	--	-------------	--	---	-----------------------------------







BMW

Série 5/E34 (88-96)	525 ix	ArG	04.1991	09.1995	83.7704-0200.3	330825	FLEXIBLE FREIN	34 32 1 108 134 , 34 32 1 115 697 , 34 32 1 153 107 , 34 32 1 159 881 , 34 32 4 051 524 , 700 1 36 005 2	83.6104-0200.3
	525 ix Touring	ArG	02.1992	11.1996	83.7704-0200.3	330825	FLEXIBLE FREIN	34 32 1 108 134 , 34 32 1 115 697 , 34 32 1 153 107 , 34 32 1 159 881 , 34 32 4 051 524 , 700 1 36 005 2	83.6104-0200.3
	525 td	ArG	04.1993	09.1995	83.7704-0200.3	330825	FLEXIBLE FREIN	34 32 1 108 134 , 34 32 1 115 697 , 34 32 1 153 107 , 34 32 1 159 881 , 34 32 4 051 524 , 700 1 36 005 2	83.6104-0200.3
	525 td Touring	ArG	03.1993	11.1996	83.7704-0200.3	330825	FLEXIBLE FREIN	34 32 1 108 134 , 34 32 1 115 697 , 34 32 1 153 107 , 34 32 1 159 881 , 34 32 4 051 524 , 700 1 36 005 2	83.6104-0200.3
	525 tds	ArG	09.1991	09.1995	83.7704-0200.3	330825	FLEXIBLE FREIN	34 32 1 108 134 , 34 32 1 115 697 , 34 32 1 153 107 , 34 32 1 159 881 , 34 32 4 051 524 , 700 1 36 005 2	83.6104-0200.3
	525 tds Touring	ArG	12.1991	11.1996	83.7704-0200.3	330825	FLEXIBLE FREIN	34 32 1 108 134 , 34 32 1 115 697 , 34 32 1 153 107 , 34 32 1 159 881 , 34 32 4 051 524 , 700 1 36 005 2	83.6104-0200.3
	530 i	ArG	01.1988	09.1995	83.7704-0200.3	330825	FLEXIBLE FREIN	34 32 1 108 134 , 34 32 1 115 697 , 34 32 1 153 107 , 34 32 1 159 881 , 34 32 4 051 524 , 700 1 36 005 2	83.6104-0200.3
	530 i V8	ArG	03.1992	09.1995	83.7704-0200.3	330825	FLEXIBLE FREIN	34 32 1 108 134 , 34 32 1 115 697 , 34 32 1 153 107 , 34 32 1 159 881 , 34 32 4 051 524 , 700 1 36 005 2	83.6104-0200.3

Nouvelles références disponibles - par applications

02/2007



						description	Références OE par référence ATE.		Références remplacées / divers
---	---	---	---	---	--	-------------	----------------------------------	---	--------------------------------

BMW

Série 5/E34 (88-96)	530 i V8 Touring	ArG	05.1992	11.1996	83.7704-0200.3	330825	FLEXIBLE FREIN	34 32 1 108 134 , 34 32 1 115 697 , 34 32 1 153 107 , 34 32 1 159 881 , 34 32 4 051 524 , 700 1 36 005 2	83.6104-0200.3
	535 i	ArG	01.1988	09.1995	83.7704-0200.3	330825	FLEXIBLE FREIN	34 32 1 108 134 , 34 32 1 115 697 , 34 32 1 153 107 , 34 32 1 159 881 , 34 32 4 051 524 , 700 1 36 005 2	83.6104-0200.3
	540 i Touring	ArG	05.1993	11.1996	83.7704-0200.3	330825	FLEXIBLE FREIN	34 32 1 108 134 , 34 32 1 115 697 , 34 32 1 153 107 , 34 32 1 159 881 , 34 32 4 051 524 , 700 1 36 005 2	83.6104-0200.3
	540 i V8	ArG	03.1992	09.1995	83.7704-0200.3	330825	FLEXIBLE FREIN	34 32 1 108 134 , 34 32 1 115 697 , 34 32 1 153 107 , 34 32 1 159 881 , 34 32 4 051 524 , 700 1 36 005 2	83.6104-0200.3
	M5 3,6	ArG	10.1988	09.1995	83.7704-0200.3	330825	FLEXIBLE FREIN	34 32 1 108 134 , 34 32 1 115 697 , 34 32 1 153 107 , 34 32 1 159 881 , 34 32 4 051 524 , 700 1 36 005 2	83.6104-0200.3
	M5 3,8	ArG	10.1988	09.1995	83.7704-0200.3	330825	FLEXIBLE FREIN	34 32 1 108 134 , 34 32 1 115 697 , 34 32 1 153 107 , 34 32 1 159 881 , 34 32 4 051 524 , 700 1 36 005 2	83.6104-0200.3
	M5 Touring	ArG	09.1994	11.1996	83.7704-0200.3	330825	FLEXIBLE FREIN	34 32 1 108 134 , 34 32 1 115 697 , 34 32 1 153 107 , 34 32 1 159 881 , 34 32 4 051 524 , 700 1 36 005 2	83.6104-0200.3
Série 6/E24 (76-89)	628 CSI	ArG	05.1982	05.1987	83.7704-0200.3	330825	FLEXIBLE FREIN	34 32 1 108 134 , 34 32 1 115 697 , 34 32 1 153 107 , 34 32 1 159 881 , 34 32 4 051 524 , 700 1 36 005 2	83.6104-0200.3

Nouvelles références disponibles - par applications

02/2007



					description	Références OE par référence ATE.		Références remplacées / divers
--	--	--	--	--	-------------	----------------------------------	--	--------------------------------







BMW

Série 6/E24 (76-89)	635 CSi	ArG	05.1982	04.1989	83.7704-0200.3	330825	FLEXIBLE FREIN	34 32 1 108 134 , 34 32 1 115 697 , 34 32 1 153 107 , 34 32 1 159 881 , 34 32 4 051 524 , 700 1 36 005 2	83.6104-0200.3
	M 635 CSi	ArG	04.1984	04.1989	83.7704-0200.3	330825	FLEXIBLE FREIN	34 32 1 108 134 , 34 32 1 115 697 , 34 32 1 153 107 , 34 32 1 159 881 , 34 32 4 051 524 , 700 1 36 005 2	83.6104-0200.3
Série 7/E23 (77-86)	728 i	ArG	09.1981	05.1986	83.7704-0200.3	330825	FLEXIBLE FREIN	34 32 1 108 134 , 34 32 1 115 697 , 34 32 1 153 107 , 34 32 1 159 881 , 34 32 4 051 524 , 700 1 36 005 2	83.6104-0200.3
	732 i	ArG	09.1981	04.1986	83.7704-0200.3	330825	FLEXIBLE FREIN	34 32 1 108 134 , 34 32 1 115 697 , 34 32 1 153 107 , 34 32 1 159 881 , 34 32 4 051 524 , 700 1 36 005 2	83.6104-0200.3
	733 i	ArG	09.1981	07.1982	83.7704-0200.3	330825	FLEXIBLE FREIN	34 32 1 108 134 , 34 32 1 115 697 , 34 32 1 153 107 , 34 32 1 159 881 , 34 32 4 051 524 , 700 1 36 005 2	83.6104-0200.3
	735 i	ArG	09.1981	04.1986	83.7704-0200.3	330825	FLEXIBLE FREIN	34 32 1 108 134 , 34 32 1 115 697 , 34 32 1 153 107 , 34 32 1 159 881 , 34 32 4 051 524 , 700 1 36 005 2	83.6104-0200.3
	745 i	ArG	09.1981	05.1986	83.7704-0200.3	330825	FLEXIBLE FREIN	34 32 1 108 134 , 34 32 1 115 697 , 34 32 1 153 107 , 34 32 1 159 881 , 34 32 4 051 524 , 700 1 36 005 2	83.6104-0200.3
Série 7/E32 (86-94)	730 i 6	ArG	07.1986	06.1994	83.7704-0200.3	330825	FLEXIBLE FREIN	34 32 1 108 134 , 34 32 1 115 697 , 34 32 1 153 107 , 34 32 1 159 881 , 34 32 4 051 524 , 700 1 36 005 2	83.6104-0200.3

Nouvelles références disponibles - par applications

02/2007



					description	Références OE par référence ATE.		Références remplacées / divers
---	---	---	---	---	-------------	----------------------------------	---	--------------------------------







BMW

Série 7/E32 (86-94)	730 i 8	ArG	03.1991	06.1994	83.7704-0200.3	330825	FLEXIBLE FREIN	34 32 1 108 134 , 34 32 1 115 697 , 34 32 1 153 107 , 34 32 1 159 881 , 34 32 4 051 524 , 700 1 36 005 2	83.6104-0200.3
	730 iL 6	ArG	12.1987	06.1994	83.7704-0200.3	330825	FLEXIBLE FREIN	34 32 1 108 134 , 34 32 1 115 697 , 34 32 1 153 107 , 34 32 1 159 881 , 34 32 4 051 524 , 700 1 36 005 2	83.6104-0200.3
	730 iL 8	ArG	06.1992	06.1994	83.7704-0200.3	330825	FLEXIBLE FREIN	34 32 1 108 134 , 34 32 1 115 697 , 34 32 1 153 107 , 34 32 1 159 881 , 34 32 4 051 524 , 700 1 36 005 2	83.6104-0200.3
	735 i	ArG	09.1986	09.1992	83.7704-0200.3	330825	FLEXIBLE FREIN	34 32 1 108 134 , 34 32 1 115 697 , 34 32 1 153 107 , 34 32 1 159 881 , 34 32 4 051 524 , 700 1 36 005 2	83.6104-0200.3
	735 iL	ArG	09.1986	09.1992	83.7704-0200.3	330825	FLEXIBLE FREIN	34 32 1 108 134 , 34 32 1 115 697 , 34 32 1 153 107 , 34 32 1 159 881 , 34 32 4 051 524 , 700 1 36 005 2	83.6104-0200.3
	740 i	ArG	09.1991	06.1994	83.7704-0200.3	330825	FLEXIBLE FREIN	34 32 1 108 134 , 34 32 1 115 697 , 34 32 1 153 107 , 34 32 1 159 881 , 34 32 4 051 524 , 700 1 36 005 2	83.6104-0200.3
	740 iL	ArG	10.1991	06.1994	83.7704-0200.3	330825	FLEXIBLE FREIN	34 32 1 108 134 , 34 32 1 115 697 , 34 32 1 153 107 , 34 32 1 159 881 , 34 32 4 051 524 , 700 1 36 005 2	83.6104-0200.3
	750 i	ArG	07.1987	06.1994	83.7704-0200.3	330825	FLEXIBLE FREIN	34 32 1 108 134 , 34 32 1 115 697 , 34 32 1 153 107 , 34 32 1 159 881 , 34 32 4 051 524 , 700 1 36 005 2	83.6104-0200.3

Nouvelles références disponibles - par applications

02/2007



					description	Références OE par référence ATE.		Références remplacées / divers
---	---	---	---	---	-------------	----------------------------------	---	--------------------------------

BMW

Série 7/E32 (86-94)	750 iL	ArG	11.1986	06.1994	83.7704-0200.3	330825	FLEXIBLE FREIN	34 32 1 108 134 , 34 32 1 115 697 , 34 32 1 153 107 , 34 32 1 159 881 , 34 32 4 051 524 , 700 1 36 005 2	83.6104-0200.3
Série 8/E31 (90-99)	840 Ci	ArG	01.1996	08.1999	83.7704-0200.3	330825	FLEXIBLE FREIN	34 32 1 108 134 , 34 32 1 115 697 , 34 32 1 153 107 , 34 32 1 159 881 , 34 32 4 051 524 , 700 1 36 005 2	83.6104-0200.3
	840 i	ArG	02.1993	02.1996	83.7704-0200.3	330825	FLEXIBLE FREIN	34 32 1 108 134 , 34 32 1 115 697 , 34 32 1 153 107 , 34 32 1 159 881 , 34 32 4 051 524 , 700 1 36 005 2	83.6104-0200.3
	850 Ci	ArG	09.1994	12.1999	83.7704-0200.3	330825	FLEXIBLE FREIN	34 32 1 108 134 , 34 32 1 115 697 , 34 32 1 153 107 , 34 32 1 159 881 , 34 32 4 051 524 , 700 1 36 005 2	83.6104-0200.3
	850 i, Ci	ArG	04.1990	10.1994	83.7704-0200.3	330825	FLEXIBLE FREIN	34 32 1 108 134 , 34 32 1 115 697 , 34 32 1 153 107 , 34 32 1 159 881 , 34 32 4 051 524 , 700 1 36 005 2	83.6104-0200.3
Z1 (88-91)	2,5	ArG	09.1990	06.1991	83.7704-0200.3	330825	FLEXIBLE FREIN	34 32 1 108 134 , 34 32 1 115 697 , 34 32 1 153 107 , 34 32 1 159 881 , 34 32 4 051 524 , 700 1 36 005 2	83.6104-0200.3
Z3 (95-02)	1,8	ArG	10.1995	10.1998	83.7704-0200.3	330825	FLEXIBLE FREIN	34 32 1 108 134 , 34 32 1 115 697 , 34 32 1 153 107 , 34 32 1 159 881 , 34 32 4 051 524 , 700 1 36 005 2	83.6104-0200.3
	1,9	ArG	10.1995	12.2002	83.7704-0200.3	330825	FLEXIBLE FREIN	34 32 1 108 134 , 34 32 1 115 697 , 34 32 1 153 107 , 34 32 1 159 881 , 34 32 4 051 524 , 700 1 36 005 2	83.6104-0200.3

Nouvelles références disponibles - par applications

02/2007



					description	Références OE par référence ATE.		Références remplacées / divers
--	--	--	--	--	-------------	----------------------------------	--	--------------------------------







BMW

Z3 (95-02)	2	ArG	04.1999	08.2000	83.7704-0200.3	330825	FLEXIBLE FREIN	34 32 1 108 134 , 34 32 1 115 697 , 34 32 1 153 107 , 34 32 1 159 881 , 34 32 4 051 524 , 700 1 36 005 2	83.6104-0200.3
	2,2	ArG	10.2000	12.2002	83.7704-0200.3	330825	FLEXIBLE FREIN	34 32 1 108 134 , 34 32 1 115 697 , 34 32 1 153 107 , 34 32 1 159 881 , 34 32 4 051 524 , 700 1 36 005 2	83.6104-0200.3
	2,8 Coupe	ArG	07.1997	06.2000	83.7704-0200.3	330825	FLEXIBLE FREIN	34 32 1 108 134 , 34 32 1 115 697 , 34 32 1 153 107 , 34 32 1 159 881 , 34 32 4 051 524 , 700 1 36 005 2	83.6104-0200.3
	2,8 Roadster	ArG	05.1997	06.2000	83.7704-0200.3	330825	FLEXIBLE FREIN	34 32 1 108 134 , 34 32 1 115 697 , 34 32 1 153 107 , 34 32 1 159 881 , 34 32 4 051 524 , 700 1 36 005 2	83.6104-0200.3
	3,0 Coupe	ArG	06.2000	12.2002	83.7704-0200.3	330825	FLEXIBLE FREIN	34 32 1 108 134 , 34 32 1 115 697 , 34 32 1 153 107 , 34 32 1 159 881 , 34 32 4 051 524 , 700 1 36 005 2	83.6104-0200.3
	3,0 Roadster	ArG	06.2000	12.2002	83.7704-0200.3	330825	FLEXIBLE FREIN	34 32 1 108 134 , 34 32 1 115 697 , 34 32 1 153 107 , 34 32 1 159 881 , 34 32 4 051 524 , 700 1 36 005 2	83.6104-0200.3

CHEVROLET

KALOS (05-)	1,2 i		03.2005		03.0137-0472.2	650472	JEU DE MACHOIRE	93740252 , 93740251	
	1,4 i		03.2005		03.0137-0472.2	650472	JEU DE MACHOIRE	93740252 , 93740251	
	1,4 i 16V		03.2005		03.0137-0472.2	650472	JEU DE MACHOIRE	93740252 , 93740251	



					description	Références OE par référence ATE.	 Références remplacées / divers
---	---	---	---	---	-------------	----------------------------------	--

CHRYSLER

VOYAGER (GS) (95-01)	2,0 i		01.1996	03.2001	24.0124-0178.1	424178	DISQUE DE FREIN	4683 260 , 4683 432 , 4721 820 , 4721 820AE , 4721 821	24.0124-0153.1
			01.1995	12.1995	24.0124-0178.1	424178	DISQUE DE FREIN	4683 260 , 4683 432 , 4721 820 , 4721 820AE , 4721 821	24.0124-0153.1
	2,4 i		01.1996	03.2001	24.0124-0178.1	424178	DISQUE DE FREIN	4683 260 , 4683 432 , 4721 820 , 4721 820AE , 4721 821	24.0124-0153.1
			01.1995	12.1995	24.0124-0178.1	424178	DISQUE DE FREIN	4683 260 , 4683 432 , 4721 820 , 4721 820AE , 4721 821	24.0124-0153.1
	2,5 TD		01.1995	12.1995	24.0124-0178.1	424178	DISQUE DE FREIN	4683 260 , 4683 432 , 4721 820 , 4721 820AE , 4721 821	24.0124-0153.1
			01.1996	03.2001	24.0124-0178.1	424178	DISQUE DE FREIN	4683 260 , 4683 432 , 4721 820 , 4721 820AE , 4721 821	24.0124-0153.1
	3,0 i		01.1996	03.2001	24.0124-0178.1	424178	DISQUE DE FREIN	4683 260 , 4683 432 , 4721 820 , 4721 820AE , 4721 821	24.0124-0153.1
			01.1995	12.1995	24.0124-0178.1	424178	DISQUE DE FREIN	4683 260 , 4683 432 , 4721 820 , 4721 820AE , 4721 821	24.0124-0153.1
	3,3 i		01.1996	03.2001	24.0124-0178.1	424178	DISQUE DE FREIN	4683 260 , 4683 432 , 4721 820 , 4721 820AE , 4721 821	24.0124-0153.1
			01.1995	12.1995	24.0124-0178.1	424178	DISQUE DE FREIN	4683 260 , 4683 432 , 4721 820 , 4721 820AE , 4721 821	24.0124-0153.1
	3,8 i		01.1996	03.2001	24.0124-0178.1	424178	DISQUE DE FREIN	4683 260 , 4683 432 , 4721 820 , 4721 820AE , 4721 821	24.0124-0153.1
			01.1995	12.1995	24.0124-0178.1	424178	DISQUE DE FREIN	4683 260 , 4683 432 , 4721 820 , 4721 820AE , 4721 821	24.0124-0153.1

Nouvelles références disponibles - par applications

02/2007



					description	Références OE par référence ATE.		Références remplacées / divers
--	--	--	--	--	-------------	----------------------------------	--	--------------------------------

CITROEN

C1 (05-)	1		06.2005		24.3217-1719.3	020482	CYLINDRE DE ROUE	47550-09040 , 4402 F0	
	1,4 HDi		06.2005		24.3217-1719.3	020482	CYLINDRE DE ROUE	47550-09040 , 4402 F0	
C2 (03-)	1,1 i		09.2003		03.0520-8520.3	698520	ATE TOPKIT	4242 11 , 4242 10	
	1,4 16V		06.2006		03.0520-8520.3	698520	ATE TOPKIT	4242 11 , 4242 10	
	1,4 HDi		09.2003		03.0520-8520.3	698520	ATE TOPKIT	4242 11 , 4242 10	
	1,4 i		09.2003		03.0520-8520.3	698520	ATE TOPKIT	4242 11 , 4242 10	
C3 (02-)	1,1 i		02.2002		03.0520-8520.3	698520	ATE TOPKIT	4242 11 , 4242 10	
	1,4 16V		12.2003		03.0520-8520.3	698520	ATE TOPKIT	4242 11 , 4242 10	
	1,4 16V HDi 90		02.2002		03.0520-8520.3	698520	ATE TOPKIT	4242 11 , 4242 10	
	1,4 HDi		02.2002		03.0520-8520.3	698520	ATE TOPKIT	4242 11 , 4242 10	
	1,4 i		02.2002		03.0520-8520.3	698520	ATE TOPKIT	4242 11 , 4242 10	
	1,6 16V HDi 90		10.2005		03.0520-8520.3	698520	ATE TOPKIT	4242 11 , 4242 10	
C3 Pluriel (03-)	1,4 HDi		04.2004		03.0520-8520.3	698520	ATE TOPKIT	4242 11 , 4242 10	
	1,4 i		05.2003		03.0520-8520.3	698520	ATE TOPKIT	4242 11 , 4242 10	
C8 (02-)	2,0 16V	AvG	09.2005		24.3601-1711.7	220607	ETRIER A GRIFFE	4401 C6 , 9949538	
		AvD	09.2005		24.3601-1712.7	220608	ETRIER A GRIFFE	4401 C7 , 9949539	
		AvD	07.2002		24.3601-1712.7	220608	ETRIER A GRIFFE	4401 C7 , 9949539	
		AvG	07.2002		24.3601-1711.7	220607	ETRIER A GRIFFE	4401 C6 , 9949538	
	2,0 HDi	AvG	03.2006		24.3601-1711.7	220607	ETRIER A GRIFFE	4401 C6 , 9949538	

Nouvelles références disponibles - par applications

02/2007



					description	Références OE par référence ATE.		Références remplacées / divers
--	--	--	--	--	-------------	----------------------------------	--	--------------------------------

CITROEN

C8 (02-)	2,0 HDi	AvG	07.2002		24.3601-1711.7	220607	ETRIER A GRIFFE	4401 C6 , 9949538	
		AvD	07.2002		24.3601-1712.7	220608	ETRIER A GRIFFE	4401 C7 , 9949539	
		AvD	03.2006		24.3601-1712.7	220608	ETRIER A GRIFFE	4401 C7 , 9949539	
	2,2 16V	AvD	07.2002		24.3601-1712.7	220608	ETRIER A GRIFFE	4401 C7 , 9949539	
		AvG	07.2002		24.3601-1711.7	220607	ETRIER A GRIFFE	4401 C6 , 9949538	
	2,2 HDi	AvG	07.2002		24.3601-1711.7	220607	ETRIER A GRIFFE	4401 C6 , 9949538	
		AvD	07.2002		24.3601-1712.7	220608	ETRIER A GRIFFE	4401 C7 , 9949539	
JUMPER Autobus/car (94-02)	1,9 TD (10/14)		08.1994	03.2002	24.3728-0337.2	590337	CABLE D'EMBAYAGE	2150 J4 , 2150 T6 , 1312633080 , 1318450080	
			02.1994	03.2002	24.3728-0337.2	590337	CABLE D'EMBAYAGE	2150 J4 , 2150 T6 , 1312633080 , 1318450080	
	2,0 i (10/14/18)		02.1994	03.2002	24.3728-0335.2	590335	CABLE D'EMBAYAGE	2150 Y5 , 2150 Z3 , 2150 AV , 1335052080	
	2,5 D (14/18)		08.1994	03.2002	24.3728-0335.2	590335	CABLE D'EMBAYAGE	2150 Y5 , 2150 Z3 , 2150 AV , 1335052080	
	2,8 HDi (14/18) 2WD		09.2000	03.2002	24.3728-0335.2	590335	CABLE D'EMBAYAGE	2150 Y5 , 2150 Z3 , 2150 AV , 1335052080	
JUMPER Fourgonnette (94-02)	1,9 TD (10/14)		03.1994	03.2002	24.3728-0337.2	590337	CABLE D'EMBAYAGE	2150 J4 , 2150 T6 , 1312633080 , 1318450080	
			03.1994	03.1994	24.3728-0337.2	590337	CABLE D'EMBAYAGE	2150 J4 , 2150 T6 , 1312633080 , 1318450080	
	2,0 i (10/14/18)		03.1994	03.2002	24.3728-0335.2	590335	CABLE D'EMBAYAGE	2150 Y5 , 2150 Z3 , 2150 AV , 1335052080	



					description	Références OE par référence ATE.		Références remplacées / divers
--	--	--	--	--	-------------	----------------------------------	--	--------------------------------

CITROEN

JUMPER Fourgonnette (94-02)	2,5 D (14/18)		03.1994	03.2002	24.3728-0335.2	590335	CABLE D'EMBRAYAGE	2150 Y5 , 2150 Z3 , 2150 AV , 1335052080
	2,8 HDi (14/18)		09.2000	03.2002	24.3728-0335.2	590335	CABLE D'EMBRAYAGE	2150 Y5 , 2150 Z3 , 2150 AV , 1335052080
JUMPER Camion-plateau/Châssis (94-02)	1,9 TD (10/14)		03.1994	03.2002	24.3728-0337.2	590337	CABLE D'EMBRAYAGE	2150 J4 , 2150 T6 , 1312633080 , 1318450080
	2,0 i (10/14/18)		03.1994	03.2002	24.3728-0335.2	590335	CABLE D'EMBRAYAGE	2150 Y5 , 2150 Z3 , 2150 AV , 1335052080
	2,5 D (14/18)		03.1994	03.2002	24.3728-0335.2	590335	CABLE D'EMBRAYAGE	2150 Y5 , 2150 Z3 , 2150 AV , 1335052080
	2,8 HDi (14/18)		09.2000	03.2002	24.3728-0335.2	590335	CABLE D'EMBRAYAGE	2150 Y5 , 2150 Z3 , 2150 AV , 1335052080
JUMPY Fourgonnette (95-)	1,6	AvG			24.3601-1711.7	220607	ETRIER A GRIFFE	4401 C6 , 9949538
		AvD			24.3601-1712.7	220608	ETRIER A GRIFFE	4401 C7 , 9949539
	1,9 TD	AvG			24.3601-1711.7	220607	ETRIER A GRIFFE	4401 C6 , 9949538
		AvD			24.3601-1712.7	220608	ETRIER A GRIFFE	4401 C7 , 9949539
	2,0 16V	AvD			24.3601-1712.7	220608	ETRIER A GRIFFE	4401 C7 , 9949539
		AvG			24.3601-1711.7	220607	ETRIER A GRIFFE	4401 C6 , 9949538
	2,0 HDi	AvG			24.3601-1711.7	220607	ETRIER A GRIFFE	4401 C6 , 9949538
		AvD			24.3601-1712.7	220608	ETRIER A GRIFFE	4401 C7 , 9949539
JUMPY Break (95-)	1,6	AvD			24.3601-1712.7	220608	ETRIER A GRIFFE	4401 C7 , 9949539
		AvG			24.3601-1711.7	220607	ETRIER A GRIFFE	4401 C6 , 9949538
	1,9 D	AvG			24.3601-1711.7	220607	ETRIER A GRIFFE	4401 C6 , 9949538



					description	Références OE par référence ATE.		Références remplacées / divers
--	--	--	--	--	-------------	----------------------------------	--	--------------------------------

CITROEN

JUMPY Break (95-)	1,9 D	AvD			24.3601-1712.7	220608	ETRIER A GRIFFE	4401 C7 , 9949539	
	1,9 TD	AvD			24.3601-1712.7	220608	ETRIER A GRIFFE	4401 C7 , 9949539	
		AvG			24.3601-1711.7	220607	ETRIER A GRIFFE	4401 C6 , 9949538	
	2,0 16V	AvD			24.3601-1712.7	220608	ETRIER A GRIFFE	4401 C7 , 9949539	
		AvG			24.3601-1711.7	220607	ETRIER A GRIFFE	4401 C6 , 9949538	
	2,0 HDi	AvD			24.3601-1712.7	220608	ETRIER A GRIFFE	4401 C7 , 9949539	
		AvG			24.3601-1711.7	220607	ETRIER A GRIFFE	4401 C6 , 9949538	
JUMPY Camion-plateau/Châssis (99-)	1,9 TD	AvG			24.3601-1711.7	220607	ETRIER A GRIFFE	4401 C6 , 9949538	
		AvD			24.3601-1712.7	220608	ETRIER A GRIFFE	4401 C7 , 9949539	
	2,0 HDi	AvG			24.3601-1711.7	220607	ETRIER A GRIFFE	4401 C6 , 9949538	
		AvD			24.3601-1712.7	220608	ETRIER A GRIFFE	4401 C7 , 9949539	
SAXO (96-04)	1,4 i VTS	AvD	05.1996	03.2004	11.3481-9834.2	220562	ETRIER A GRIFFE	4400 E5 , 4400 G8 , 4400 J5	11.3481-0168.2
	1,6 16V VTS	AvD	07.1996	03.2004	11.3481-9834.2	220562	ETRIER A GRIFFE	4400 E5 , 4400 G8 , 4400 J5	11.3481-0168.2
	1,6 i	AvD	02.1996	03.2004	11.3481-9834.2	220562	ETRIER A GRIFFE	4400 E5 , 4400 G8 , 4400 J5	11.3481-0168.2
	1,6 i VTS	AvD	09.2000	03.2004	11.3481-9834.2	220562	ETRIER A GRIFFE	4400 E5 , 4400 G8 , 4400 J5	11.3481-0168.2
XANTIA (X1) Berline (93-97)	1,6 i	AV	03.1993		24.0731-1133.3	360156	CAPTEUR DE ROUE	96 113 241	
	1,8 i	AV	03.1993		24.0731-1133.3	360156	CAPTEUR DE ROUE	96 113 241	
	1,9 D	AV	06.1994		24.0731-1133.3	360156	CAPTEUR DE ROUE	96 113 241	
	1,9 TD	AV	10.1994		24.0731-1133.3	360156	CAPTEUR DE ROUE	96 113 241	

Nouvelles références disponibles - par applications

02/2007



					description	Références OE par référence ATE.		Références remplacées / divers
--	--	--	--	--	-------------	----------------------------------	--	--------------------------------

CITROEN

XANTIA (X1) Berline (93-97)	2,0 16V	AV	06.1994		24.0731-1133.3	360156	CAPTEUR DE ROUE	96 113 241	
		AV	03.1993		24.0731-1133.3	360156	CAPTEUR DE ROUE	96 113 241	
	2,0 i	AV	03.1993		24.0731-1133.3	360156	CAPTEUR DE ROUE	96 113 241	
XANTIA (X2) Break (98-01)	1,8 16V	AV	01.1998	09.2001	24.0751-1187.3	360069	CAPTEUR DE ROUE	4545 73	
	1,8 i	AV	01.1998	09.2001	24.0751-1187.3	360069	CAPTEUR DE ROUE	4545 73	
	1,9 SD	AV	01.1998	09.2001	24.0751-1187.3	360069	CAPTEUR DE ROUE	4545 73	
	1,9 TD	AV	01.1998	09.2001	24.0751-1187.3	360069	CAPTEUR DE ROUE	4545 73	
	2,0 16V	AV	01.1998	09.2001	24.0751-1187.3	360069	CAPTEUR DE ROUE	4545 73	
	2,0 HDi 110	AV	02.1999	09.2001	24.0751-1187.3	360069	CAPTEUR DE ROUE	4545 73	
	2,0 HDi 90	AV	03.1999	09.2001	24.0751-1187.3	360069	CAPTEUR DE ROUE	4545 73	
	2,0 i	AV	01.1998	09.2001	24.0751-1187.3	360069	CAPTEUR DE ROUE	4545 73	
	2,0 Turbo	AV	01.1998	09.2001	24.0751-1187.3	360069	CAPTEUR DE ROUE	4545 73	
	2,1 TD	AV	01.1998	02.1999	24.0751-1187.3	360069	CAPTEUR DE ROUE	4545 73	
	3,0 V6	AV	01.1998	09.2001	24.0751-1187.3	360069	CAPTEUR DE ROUE	4545 73	
XANTIA (X2) Berline (98-01)	1,8 16V	AV	01.1998	09.2001	24.0751-1187.3	360069	CAPTEUR DE ROUE	4545 73	
	1,8 i	AV	01.1998	09.2001	24.0751-1187.3	360069	CAPTEUR DE ROUE	4545 73	
	1,9 SD	AV	01.1998	09.2001	24.0751-1187.3	360069	CAPTEUR DE ROUE	4545 73	
	1,9 TD	AV	01.1998	09.2001	24.0751-1187.3	360069	CAPTEUR DE ROUE	4545 73	
	2,0 16V	AV	01.1998	09.2001	24.0751-1187.3	360069	CAPTEUR DE ROUE	4545 73	



					description	Références OE par référence ATE.		Références remplacées / divers
--	--	--	--	--	-------------	----------------------------------	--	--------------------------------

CITROEN

XANTIA (X2) Berline (98-01)	2,0 HDi 110	AV	02.1999	09.2001	24.0751-1187.3	360069	CAPTEUR DE ROUE	4545 73	
	2,0 HDi 90	AV	03.1999	09.2001	24.0751-1187.3	360069	CAPTEUR DE ROUE	4545 73	
	2,0 i	AV	01.1998	09.2001	24.0751-1187.3	360069	CAPTEUR DE ROUE	4545 73	
	2,0 Turbo	AV	01.1998	09.2001	24.0751-1187.3	360069	CAPTEUR DE ROUE	4545 73	
	2,1 TD	AV	01.1998	02.1999	24.0751-1187.3	360069	CAPTEUR DE ROUE	4545 73	
	3,0 V6	AV	01.1998	09.2001	24.0751-1187.3	360069	CAPTEUR DE ROUE	4545 73	
XSARA (N0) Coupé (97-)	1,4 i	AvD	02.1998	08.2000	11.3481-9834.2	220562	ETRIER A GRIFFE	4400 E5 , 4400 G8 , 4400 J5	11.3481-0168.2
	1,6 i	AvD	02.1998	08.2000	11.3481-9834.2	220562	ETRIER A GRIFFE	4400 E5 , 4400 G8 , 4400 J5	11.3481-0168.2
	1,8 i	AvD	04.1997	08.2000	11.3481-9834.2	220562	ETRIER A GRIFFE	4400 E5 , 4400 G8 , 4400 J5	11.3481-0168.2
		AvD	02.1998	08.2000	11.3481-9834.2	220562	ETRIER A GRIFFE	4400 E5 , 4400 G8 , 4400 J5	11.3481-0168.2
	1,9 D	AvD	02.1998	08.2000	11.3481-9834.2	220562	ETRIER A GRIFFE	4400 E5 , 4400 G8 , 4400 J5	11.3481-0168.2
	1,9 TD	AvD	02.1998	08.2000	11.3481-9834.2	220562	ETRIER A GRIFFE	4400 E5 , 4400 G8 , 4400 J5	11.3481-0168.2
	2,0 16V	AvD	09.2000		24.3571-1730.5	240318	ETRIER A GRIFFE	4401 A5	
		AvD	02.1998		24.3571-1730.5	240318	ETRIER A GRIFFE	4401 A5	
		AvG	09.2000		24.3571-1729.5	240317	ETRIER A GRIFFE	4401 A4	
		AvG	02.1998		24.3571-1729.5	240317	ETRIER A GRIFFE	4401 A4	
	2,0 HDi 110	AvD	05.2001		24.3571-1730.5	240318	ETRIER A GRIFFE	4401 A5	
		AvG	05.2001		24.3571-1729.5	240317	ETRIER A GRIFFE	4401 A4	
XSARA (N1) Berline (97-)	1,4 i	AvD	04.1997	08.2000	11.3481-9834.2	220562	ETRIER A GRIFFE	4400 E5 , 4400 G8 , 4400 J5	11.3481-0168.2

Nouvelles références disponibles - par applications

02/2007



					description	Références OE par référence ATE.	Références remplacées / divers
--	--	--	--	--	-------------	----------------------------------	--------------------------------

CITROEN

XSARA (N1) Berline (97-)	1,5 D	AvD	04.1997	08.2000	11.3481-9834.2	220562	ETRIER A GRIFFE	4400 E5 , 4400 G8 , 4400 J5	11.3481-0168.2
	1,6 i	AvD	04.1997	08.2000	11.3481-9834.2	220562	ETRIER A GRIFFE	4400 E5 , 4400 G8 , 4400 J5	11.3481-0168.2
	1,8 D	AvD	04.1997	08.2000	11.3481-9834.2	220562	ETRIER A GRIFFE	4400 E5 , 4400 G8 , 4400 J5	11.3481-0168.2
	1,8 i	AvD	04.1997	08.2000	11.3481-9834.2	220562	ETRIER A GRIFFE	4400 E5 , 4400 G8 , 4400 J5	11.3481-0168.2
	1,8 TD	AvD	10.1997	08.2000	11.3481-9834.2	220562	ETRIER A GRIFFE	4400 E5 , 4400 G8 , 4400 J5	11.3481-0168.2
	1,9 D	AvD	07.1998	08.2000	11.3481-9834.2	220562	ETRIER A GRIFFE	4400 E5 , 4400 G8 , 4400 J5	11.3481-0168.2
		AvD	04.1997	08.2000	11.3481-9834.2	220562	ETRIER A GRIFFE	4400 E5 , 4400 G8 , 4400 J5	11.3481-0168.2
	1,9 SD	AvD	01.1998	08.2000	11.3481-9834.2	220562	ETRIER A GRIFFE	4400 E5 , 4400 G8 , 4400 J5	11.3481-0168.2
	1,9 TD	AvD	04.1997	08.2000	11.3481-9834.2	220562	ETRIER A GRIFFE	4400 E5 , 4400 G8 , 4400 J5	11.3481-0168.2
	2,0 16V	AvG	09.2000		24.3571-1729.5	240317	ETRIER A GRIFFE	4401 A4	
		AvD	09.2000		24.3571-1730.5	240318	ETRIER A GRIFFE	4401 A5	
		AvG	04.1997	08.2000	24.3571-1729.5	240317	ETRIER A GRIFFE	4401 A4	
		AvD	04.1997	08.2000	24.3571-1730.5	240318	ETRIER A GRIFFE	4401 A5	
	2,0 HDi 110	AvG	05.2001		24.3571-1729.5	240317	ETRIER A GRIFFE	4401 A4	
		AvD	05.2001		24.3571-1730.5	240318	ETRIER A GRIFFE	4401 A5	
XSARA (N2) Break (97-)	1,4 i	AvD	10.1997	08.2000	11.3481-9834.2	220562	ETRIER A GRIFFE	4400 E5 , 4400 G8 , 4400 J5	11.3481-0168.2
	1,5 D	AvD	10.1997	08.2000	11.3481-9834.2	220562	ETRIER A GRIFFE	4400 E5 , 4400 G8 , 4400 J5	11.3481-0168.2
	1,6 i	AvD	10.1997	08.2000	11.3481-9834.2	220562	ETRIER A GRIFFE	4400 E5 , 4400 G8 , 4400 J5	11.3481-0168.2
	1,8 D	AvD	10.1997	08.2000	11.3481-9834.2	220562	ETRIER A GRIFFE	4400 E5 , 4400 G8 , 4400 J5	11.3481-0168.2



					description	Références OE par référence ATE.		Références remplacées / divers
--	--	--	--	--	-------------	----------------------------------	--	--------------------------------

CITROEN

XSARA (N2) Break (97-)	1,9 D	AvD	07.1998	08.2000	11.3481-9834.2	220562	ETRIER A GRIFFE	4400 E5 , 4400 G8 , 4400 J5	11.3481-0168.2
		AvD	10.1997	08.2000	11.3481-9834.2	220562	ETRIER A GRIFFE	4400 E5 , 4400 G8 , 4400 J5	11.3481-0168.2
	2,0 16V	AvG	09.2000		24.3571-1729.5	240317	ETRIER A GRIFFE	4401 A4	
		AvD	09.2000		24.3571-1730.5	240318	ETRIER A GRIFFE	4401 A5	
	2,0 HDi 110	AvG	05.2001		24.3571-1729.5	240317	ETRIER A GRIFFE	4401 A4	
		AvD	05.2001		24.3571-1730.5	240318	ETRIER A GRIFFE	4401 A5	
ZX (N2) Berline (91-97)	2,0 16V	AvG	05.1996	06.1997	24.3571-1729.5	240317	ETRIER A GRIFFE	4401 A4	
		AvD	05.1996	06.1997	24.3571-1730.5	240318	ETRIER A GRIFFE	4401 A5	

DAEWOO

KALOS (02-05)	1,2 i		04.2003	02.2005	03.0137-0472.2	650472	JEU DE MACHOIRE	93740252 , 93740251	
	1,4 i		09.2002	02.2005	03.0137-0472.2	650472	JEU DE MACHOIRE	93740252 , 93740251	
	1,4 i 16V		04.2003	02.2005	03.0137-0472.2	650472	JEU DE MACHOIRE	93740252 , 93740251	
	1,6 i 16V		11.2002	02.2005	03.0137-0472.2	650472	JEU DE MACHOIRE	93740252 , 93740251	

Nouvelles références disponibles - par applications

02/2007



						description	Références OE par référence ATE.		Références remplacées / divers
--	--	--	--	--	--	-------------	----------------------------------	--	--------------------------------

FIAT

BRAVA (95-01)	1,4 i 12V		09.1995	11.1998	03.0520-6722.3	696722	ATE TOPKIT		03.0520-5022.3
	1,6 i 16V		09.1995	11.1998	03.0520-6722.3	696722	ATE TOPKIT		03.0520-5022.3
	1,8 i 16V		09.1995	11.1998	03.0520-6722.3	696722	ATE TOPKIT		03.0520-5022.3
	1,9 D		09.1995	11.1998	03.0520-6722.3	696722	ATE TOPKIT		03.0520-5022.3
	1,9 TD		09.1996	11.1998	03.0520-6722.3	696722	ATE TOPKIT		03.0520-5022.3
BRAVO (95-01)	1,4 i 12V		09.1995	11.1998	03.0520-6722.3	696722	ATE TOPKIT		03.0520-5022.3
	1,6 i 16V		09.1995	11.1998	03.0520-6722.3	696722	ATE TOPKIT		03.0520-5022.3
	1,8 i 16V		09.1995	11.1998	03.0520-6722.3	696722	ATE TOPKIT		03.0520-5022.3
	1,9 D		09.1995	11.1998	03.0520-6722.3	696722	ATE TOPKIT		03.0520-5022.3
	1,9 TD		09.1996	11.1998	03.0520-6722.3	696722	ATE TOPKIT		03.0520-5022.3
CROMA (05-)	1,8 i 16V		01.2006		13.0460-7212.2	607212	PLAQUETTES DE FREIN		cf. Photo
	1,9 JTD		06.2005		13.0460-7212.2	607212	PLAQUETTES DE FREIN		cf. Photo
	2,2 i 16V		06.2005		13.0460-7212.2	607212	PLAQUETTES DE FREIN		cf. Photo
DOBLO (01-)	1,2 i.e,	AvD	01.2001	09.2005	24.3541-1802.5	240316	ETRIER A GRIFFE	7082167 , 7079192 , 7079762	
		AvG	01.2001	09.2005	24.3541-1801.5	240315	ETRIER A GRIFFE	7082145 , 7079193 , 7079761	
	1,3 JTD	AvD	05.2004	09.2005	24.3541-1802.5	240316	ETRIER A GRIFFE	7082167 , 7079192 , 7079762	
		AvG	05.2004	09.2005	24.3541-1801.5	240315	ETRIER A GRIFFE	7082145 , 7079193 , 7079761	
	1,6 i 16V	AvG	10.2001	09.2005	24.3541-1801.5	240315	ETRIER A GRIFFE	7082145 , 7079193 , 7079761	
		AvD	10.2001	09.2005	24.3541-1802.5	240316	ETRIER A GRIFFE	7082167 , 7079192 , 7079762	

Nouvelles références disponibles - par applications

02/2007



					description	Références OE par référence ATE.		Références remplacées / divers
--	--	--	--	--	-------------	----------------------------------	--	--------------------------------

FIAT

DOBLO (01-)	1,9 D	AvD	01.2001	09.2005	24.3541-1802.5	240316	ETRIER A GRIFFE	7082167 , 7079192 , 7079762	
		AvG	01.2001	09.2005	24.3541-1801.5	240315	ETRIER A GRIFFE	7082145 , 7079193 , 7079761	
	1,9 JTD	AvG	10.2001	09.2005	24.3541-1801.5	240315	ETRIER A GRIFFE	7082145 , 7079193 , 7079761	
		AvD	10.2001	09.2005	24.3541-1802.5	240316	ETRIER A GRIFFE	7082167 , 7079192 , 7079762	
		AvG	07.2003	09.2005	24.3541-1801.5	240315	ETRIER A GRIFFE	7082145 , 7079193 , 7079761	
		AvD	07.2003	09.2005	24.3541-1802.5	240316	ETRIER A GRIFFE	7082167 , 7079192 , 7079762	
DUCATO (02-06)	2,8 JTD (11/15/18)		04.2002	07.2006	24.3728-0335.2	590335	CABLE D'EMBAYAGE	2150 Y5 , 2150 Z3 , 2150 AV , 1335052080	
	2,8 JTD 4x4(11/15/18)		07.2002	07.2006	24.3728-0335.2	590335	CABLE D'EMBAYAGE	2150 Y5 , 2150 Z3 , 2150 AV , 1335052080	
DUCATO (94-02)	1,9 D (10)		02.1994	03.2002	24.3728-0337.2	590337	CABLE D'EMBAYAGE	2150 J4 , 2150 T6 , 1312633080 , 1318450080	
	1,9 TD (10)		02.1994	03.2002	24.3728-0337.2	590337	CABLE D'EMBAYAGE	2150 J4 , 2150 T6 , 1312633080 , 1318450080	
	1,9 TD-ECO (10)		02.1994	03.2002	24.3728-0337.2	590337	CABLE D'EMBAYAGE	2150 J4 , 2150 T6 , 1312633080 , 1318450080	
GRANDE PUNTO (06-)	1,2 i		10.2005		24.0122-0231.1	422231	DISQUE DE FREIN	55700920 , 55700921	
	1,3 JTD		10.2005		24.0122-0231.1	422231	DISQUE DE FREIN	55700920 , 55700921	
	1,4 i		10.2005		24.0122-0231.1	422231	DISQUE DE FREIN	55700920 , 55700921	
	1,4 i 16V		02.2006		24.0122-0231.1	422231	DISQUE DE FREIN	55700920 , 55700921	
MAREA (96-)	1,4 i 12V		09.1996	03.1997	03.0520-6722.3	696722	ATE TOPKIT		03.0520-5022.3
	1,6 i 16V Lim,		09.1996	03.1997	03.0520-6722.3	696722	ATE TOPKIT		03.0520-5022.3

Nouvelles références disponibles - par applications

02/2007



					description	Références OE par référence ATE.		Références remplacées / divers
--	--	--	--	--	-------------	----------------------------------	--	--------------------------------

FIAT

MAREA (96-)	1,8 i 16V Lim,		09.1996	03.1997	03.0520-6722.3	696722	ATE TOPKIT		03.0520-5022.3
	1,9 TD Lim,		09.1996	03.1997	03.0520-6722.3	696722	ATE TOPKIT		03.0520-5022.3
PALIO / PALIO WEEKEND EUROPA (97-)	1,2 (75)	AvD	03.1998	11.1998	24.3541-1802.5	240316	ETRIER A GRIFFE	7082167 , 7079192 , 7079762	
		AvG	03.1998	11.1998	24.3541-1801.5	240315	ETRIER A GRIFFE	7082145 , 7079193 , 7079761	
		AvD	12.1998		24.3541-1802.5	240316	ETRIER A GRIFFE	7082167 , 7079192 , 7079762	
		AvG	12.1998		24.3541-1801.5	240315	ETRIER A GRIFFE	7082145 , 7079193 , 7079761	
	1,6 i 16V (100)	AvD	10.1997		24.3541-1802.5	240316	ETRIER A GRIFFE	7082167 , 7079192 , 7079762	
		AvG	10.1997		24.3541-1801.5	240315	ETRIER A GRIFFE	7082145 , 7079193 , 7079761	
	1,7 TD (70)	AvD	03.1998	11.1998	24.3541-1802.5	240316	ETRIER A GRIFFE	7082167 , 7079192 , 7079762	
		AvD	12.1998		24.3541-1802.5	240316	ETRIER A GRIFFE	7082167 , 7079192 , 7079762	
		AvG	12.1998		24.3541-1801.5	240315	ETRIER A GRIFFE	7082145 , 7079193 , 7079761	
		AvG	03.1998	11.1998	24.3541-1801.5	240315	ETRIER A GRIFFE	7082145 , 7079193 , 7079761	
	1,9 D	AvD	03.2001		24.3541-1802.5	240316	ETRIER A GRIFFE	7082167 , 7079192 , 7079762	
		AvG	03.2001		24.3541-1801.5	240315	ETRIER A GRIFFE	7082145 , 7079193 , 7079761	
PANDA (03-)	1,1 i		09.2003		03.0520-8220.3	698220	ATE TOPKIT		
	1,2 i		09.2003		03.0520-8220.3	698220	ATE TOPKIT		
	1,3 JTD		09.2003		03.0520-8220.3	698220	ATE TOPKIT		
SCUDO (95-06)	1,6 i,e,	AvD	10.2003		24.3601-1712.7	220608	ETRIER A GRIFFE	4401 C7 , 9949539	
		AvG	10.2003		24.3601-1711.7	220607	ETRIER A GRIFFE	4401 C6 , 9949538	
	1,9 D	AvD	10.2003		24.3601-1712.7	220608	ETRIER A GRIFFE	4401 C7 , 9949539	

Nouvelles références disponibles - par applications

02/2007



					description	Références OE par référence ATE.		Références remplacées / divers
--	--	--	--	--	-------------	----------------------------------	--	--------------------------------

FIAT

SCUDO (95-06)	1,9 D	AvG	10.2003		24.3601-1711.7	220607	ETRIER A GRIFFE	4401 C6 , 9949538	
	1,9 TD	AvG	10.2003		24.3601-1711.7	220607	ETRIER A GRIFFE	4401 C6 , 9949538	
		AvD	10.2003		24.3601-1712.7	220608	ETRIER A GRIFFE	4401 C7 , 9949539	
	2,0 i 16V	AvG	10.2003		24.3601-1711.7	220607	ETRIER A GRIFFE	4401 C6 , 9949538	
		AvD	10.2003		24.3601-1712.7	220608	ETRIER A GRIFFE	4401 C7 , 9949539	
	2,0 JTD	AvD	10.2003		24.3601-1712.7	220608	ETRIER A GRIFFE	4401 C7 , 9949539	
		AvG	10.2003		24.3601-1711.7	220607	ETRIER A GRIFFE	4401 C6 , 9949538	
STILO (01-)	2,4 i 20V		10.2001		24.0126-0125.1	426125	DISQUE DE FREIN	46765546	
STRADA / PICK-UP (99-)	1,2		05.1999		03.0137-0471.2	650471	JEU DE MACHOIRE	7081832	
		AvD	05.1999		24.3541-1802.5	240316	ETRIER A GRIFFE	7082167 , 7079192 , 7079762	
		AvG	05.1999		24.3541-1801.5	240315	ETRIER A GRIFFE	7082145 , 7079193 , 7079761	
	1,3 JTD		05.2006		03.0137-0471.2	650471	JEU DE MACHOIRE	7081832	
		AvG	05.2006		24.3541-1801.5	240315	ETRIER A GRIFFE	7082145 , 7079193 , 7079761	
		AvD	05.2006		24.3541-1802.5	240316	ETRIER A GRIFFE	7082167 , 7079192 , 7079762	
	1,7 TD		05.1999		03.0137-0471.2	650471	JEU DE MACHOIRE	7081832	
		AvG	05.1999		24.3541-1801.5	240315	ETRIER A GRIFFE	7082145 , 7079193 , 7079761	
		AvD	05.1999		24.3541-1802.5	240316	ETRIER A GRIFFE	7082167 , 7079192 , 7079762	
	1,9 D		12.2000		03.0137-0471.2	650471	JEU DE MACHOIRE	7081832	
		AvD	12.2000		24.3541-1802.5	240316	ETRIER A GRIFFE	7082167 , 7079192 , 7079762	









					description	Références OE par référence ATE.		Références remplacées / divers
--	--	--	--	--	-------------	----------------------------------	--	--------------------------------

FIAT

STRADA / PICK-UP (99-)	1,9 D	AvG	12.2000		24.3541-1801.5	240315	ETRIER A GRIFFE	7082145 , 7079193 , 7079761	
	1,9 JTD		04.2003		03.0137-0471.2	650471	JEU DE MACHOIRE	7081832	
		AvG	04.2003		24.3541-1801.5	240315	ETRIER A GRIFFE	7082145 , 7079193 , 7079761	
		AvD	04.2003		24.3541-1802.5	240316	ETRIER A GRIFFE	7082167 , 7079192 , 7079762	
ULYSSE (02-)	2,0 i 16V	AvG	08.2002		24.3601-1711.7	220607	ETRIER A GRIFFE	4401 C6 , 9949538	
		AvD	08.2002		24.3601-1712.7	220608	ETRIER A GRIFFE	4401 C7 , 9949539	
	2,0 JTD	AvG	08.2002		24.3601-1711.7	220607	ETRIER A GRIFFE	4401 C6 , 9949538	
		AvD	08.2002		24.3601-1712.7	220608	ETRIER A GRIFFE	4401 C7 , 9949539	
	2,2 JTD	AvG	08.2002		24.3601-1711.7	220607	ETRIER A GRIFFE	4401 C6 , 9949538	
		AvD	08.2002		24.3601-1712.7	220608	ETRIER A GRIFFE	4401 C7 , 9949539	



		 		description	Références OE par référence ATE.	 Références remplacées / divers
---	---	---	---	-------------	--	---

FORD

Modèle	Version	Année	Année	Code	Code	Description	Références OE par référence ATE.	Références remplacées / divers
FOCUS I (98-04)	1,4 i 16V	09.2001	09.2004	24.3727-0651.2	580651	CABLE FREIN A MAIN	1205576 , 1253158	
	1,6 i 16V	09.2001	09.2004	24.3727-0651.2	580651	CABLE FREIN A MAIN	1205576 , 1253158	
	1,8 i 16V	09.2001	09.2004	24.3727-0651.2	580651	CABLE FREIN A MAIN	1205576 , 1253158	
	1,8 TDCi	09.2001	09.2004	24.3727-0651.2	580651	CABLE FREIN A MAIN	1205576 , 1253158	
	1,8 Turbo DI	09.2001	09.2004	24.3727-0651.2	580651	CABLE FREIN A MAIN	1205576 , 1253158	
	2,0 i 16V	09.2001	09.2004	24.3727-0651.2	580651	CABLE FREIN A MAIN	1205576 , 1253158	
	RS 2,0	10.2002	09.2004	24.3727-0651.2	580651	CABLE FREIN A MAIN	1205576 , 1253158	
	ST 170	03.2002	09.2004	24.3727-0651.2	580651	CABLE FREIN A MAIN	1205576 , 1253158	
FOCUS II (05-)	1,4 i 16V	10.2004	05.2005	03.0137-0467.2	650467	JEU DE MACHOIRE	1347420	

Nouvelles références disponibles - par applications

02/2007



						description	Références OE par référence ATE.		Références remplacées / divers
--	--	--	--	--	--	-------------	----------------------------------	--	--------------------------------

HONDA

ACCORD (93-98)	1,8 i (CC7)		01.1994	12.1995	13.0460-0075.2	610075	ACCES. JEUX PLAQ.	45227-SM4-003 , 45237-SM5-A01 , 45237-SP0-003 , 45237-SS0-A01	
			01.1994	12.1995	13.0460-0287.2	610287	ACCES. JEUX PLAQ.	43227-SG0-013 , 43244-SG0-003 , 43244-SZ3-A01	
	1,8 i (CE7)		01.1996	09.1998	13.0460-0287.2	610287	ACCES. JEUX PLAQ.	43227-SG0-013 , 43244-SG0-003 , 43244-SZ3-A01	
			01.1996	09.1998	13.0460-0075.2	610075	ACCES. JEUX PLAQ.	45227-SM4-003 , 45237-SM5-A01 , 45237-SP0-003 , 45237-SS0-A01	
	2,0 i (CC7)		01.1993	12.1995	13.0460-0075.2	610075	ACCES. JEUX PLAQ.	45227-SM4-003 , 45237-SM5-A01 , 45237-SP0-003 , 45237-SS0-A01	
			01.1993	12.1995	13.0460-0287.2	610287	ACCES. JEUX PLAQ.	43227-SG0-013 , 43244-SG0-003 , 43244-SZ3-A01	
	2,0 i (CE8)		01.1996	09.1998	13.0460-0075.2	610075	ACCES. JEUX PLAQ.	45227-SM4-003 , 45237-SM5-A01 , 45237-SP0-003 , 45237-SS0-A01	
			01.1996	09.1998	13.0460-0287.2	610287	ACCES. JEUX PLAQ.	43227-SG0-013 , 43244-SG0-003 , 43244-SZ3-A01	
	2,0 i Aero Deck (CE2)		01.1994	01.1998	13.0460-0075.2	610075	ACCES. JEUX PLAQ.	45227-SM4-003 , 45237-SM5-A01 , 45237-SP0-003 , 45237-SS0-A01	
			01.1994	01.1998	13.0460-0287.2	610287	ACCES. JEUX PLAQ.	43227-SG0-013 , 43244-SG0-003 , 43244-SZ3-A01	
	2,0 i Coupe (CD9)		01.1994	01.1998	13.0460-0075.2	610075	ACCES. JEUX PLAQ.	45227-SM4-003 , 45237-SM5-A01 , 45237-SP0-003 , 45237-SS0-A01	

Nouvelles références disponibles - par applications

02/2007









					description	Références OE par référence ATE.		Références remplacées / divers
--	--	--	--	--	-------------	----------------------------------	--	--------------------------------

HONDA

ACCORD (93-98)	2,0 i Coupe (CD9)		01.1994	01.1998	13.0460-0287.2	610287	ACCES. JEUX PLAQ.	43227-SG0-013 , 43244-SG0-003 , 43244-SZ3-A01	
	2,0 TDi (CF1)		01.1996	09.1998	13.0460-0287.2	610287	ACCES. JEUX PLAQ.	43227-SG0-013 , 43244-SG0-003 , 43244-SZ3-A01	
	2,2 i Aero Deck (CE1)		01.1994	01.1998	13.0460-0075.2	610075	ACCES. JEUX PLAQ.	45227-SM4-003 , 45237-SM5-A01 , 45237-SP0-003 , 45237-SS0-A01	
			01.1994	01.1998	13.0460-0287.2	610287	ACCES. JEUX PLAQ.	43227-SG0-013 , 43244-SG0-003 , 43244-SZ3-A01	
	2,2 i Coupe (CD7)		01.1994	01.1998	13.0460-0075.2	610075	ACCES. JEUX PLAQ.	45227-SM4-003 , 45237-SM5-A01 , 45237-SP0-003 , 45237-SS0-A01	
			01.1994	01.1998	13.0460-0287.2	610287	ACCES. JEUX PLAQ.	43227-SG0-013 , 43244-SG0-003 , 43244-SZ3-A01	
	2,2 i VTEC (CE9)		01.1996	09.1998	13.0460-0075.2	610075	ACCES. JEUX PLAQ.	45227-SM4-003 , 45237-SM5-A01 , 45237-SP0-003 , 45237-SS0-A01	
			01.1996	09.1998	13.0460-0287.2	610287	ACCES. JEUX PLAQ.	43227-SG0-013 , 43244-SG0-003 , 43244-SZ3-A01	
	2,3 i (CC7)		01.1993	12.1995	13.0460-0075.2	610075	ACCES. JEUX PLAQ.	45227-SM4-003 , 45237-SM5-A01 , 45237-SP0-003 , 45237-SS0-A01	
			01.1993	12.1995	13.0460-0287.2	610287	ACCES. JEUX PLAQ.	43227-SG0-013 , 43244-SG0-003 , 43244-SZ3-A01	
ACCORD (98-02)	1,8 VTEC (CG8)		10.1998	12.2002	13.0460-5825.2	605825	PLAQUETTES DE FREIN	41060-AV125 , 41060-AV126 , 41060-4U125 , 41060-4U126 , 41060-4U127 , 45022-S1A-E02 , 45022-S1A-E50	cf. Photo



		 		description	Références OE par référence ATE.	 Références remplacées / divers
---	---	---	---	-------------	--	---

HONDA

ACCORD (98-02)	1,8 VTEC (CH6)		10.1998	12.2002	13.0460-5825.2	605825	PLAQUETTES DE FREIN	41060-AV125 , 41060-AV126 , 41060-4U125 , 41060-4U126 , 41060-4U127 , 45022-S1A-E02 , 45022-S1A-E50	cf. Photo
	2,0 TDIC (CH2)		02.1999	10.2000	13.0460-5825.2	605825	PLAQUETTES DE FREIN	41060-AV125 , 41060-AV126 , 41060-4U125 , 41060-4U126 , 41060-4U127 , 45022-S1A-E02 , 45022-S1A-E50	cf. Photo
	2,0 TDIC (CH8)		02.1999	10.2000	13.0460-5825.2	605825	PLAQUETTES DE FREIN	41060-AV125 , 41060-AV126 , 41060-4U125 , 41060-4U126 , 41060-4U127 , 45022-S1A-E02 , 45022-S1A-E50	cf. Photo
	2,0 VTEC (CG9)		10.1998	01.2001	13.0460-5825.2	605825	PLAQUETTES DE FREIN	41060-AV125 , 41060-AV126 , 41060-4U125 , 41060-4U126 , 41060-4U127 , 45022-S1A-E02 , 45022-S1A-E50	cf. Photo
	2,0 VTEC (CH7)		10.1998	01.2001	13.0460-5825.2	605825	PLAQUETTES DE FREIN	41060-AV125 , 41060-AV126 , 41060-4U125 , 41060-4U126 , 41060-4U127 , 45022-S1A-E02 , 45022-S1A-E50	cf. Photo
	2,3 VTEC (CL3)		01.2001	12.2002	13.0460-5825.2	605825	PLAQUETTES DE FREIN	41060-AV125 , 41060-AV126 , 41060-4U125 , 41060-4U126 , 41060-4U127 , 45022-S1A-E02 , 45022-S1A-E50	cf. Photo
	2,3 VTEC (CL4)		01.2001	12.2002	13.0460-5825.2	605825	PLAQUETTES DE FREIN	41060-AV125 , 41060-AV126 , 41060-4U125 , 41060-4U126 , 41060-4U127 , 45022-S1A-E02 , 45022-S1A-E50	cf. Photo

Nouvelles références disponibles - par applications

02/2007



					description	Références OE par référence ATE.		Références remplacées / divers
--	--	--	--	--	-------------	----------------------------------	--	--------------------------------

HONDA

CIVIC (3/4-portes) (95-01)	1,4 i (EJ9)		11.1995	12.1997	13.0460-0073.2	610073	ACCES. JEUX PLAQ.	45237-SR3-003 , 45238-SR3-003	
			01.1998	01.2001	13.0460-0073.2	610073	ACCES. JEUX PLAQ.	45237-SR3-003 , 45238-SR3-003	
	1,5 VTEC (EK3)		11.1995	01.2001	13.0460-0073.2	610073	ACCES. JEUX PLAQ.	45237-SR3-003 , 45238-SR3-003	
	1,6 VTEC (EK1)		11.1995	01.2001	13.0460-0073.2	610073	ACCES. JEUX PLAQ.	45237-SR3-003 , 45238-SR3-003	
	1,6 VTEC (EK4)		11.1995	01.2001	13.0460-0329.2	610329	ACCES. JEUX PLAQ.	43227-SF1-003 , 43244-SD2-931	
			11.1995	01.2001	13.0460-0073.2	610073	ACCES. JEUX PLAQ.	45237-SR3-003 , 45238-SR3-003	
CIVIC COUPE (94-95)	1,5 i (EJ2)		01.1994	12.1995	13.0460-0073.2	610073	ACCES. JEUX PLAQ.	45237-SR3-003 , 45238-SR3-003	
	1,6 i (EJ6)		01.1994	12.1995	13.0460-0073.2	610073	ACCES. JEUX PLAQ.	45237-SR3-003 , 45238-SR3-003	
	1,6 VTEC (EJ1)		01.1994	12.1995	13.0460-0073.2	610073	ACCES. JEUX PLAQ.	45237-SR3-003 , 45238-SR3-003	
CIVIC COUPE (96-01)	1,6 i (EJ6)		01.1996	01.2001	13.0460-0073.2	610073	ACCES. JEUX PLAQ.	45237-SR3-003 , 45238-SR3-003	
	1,6 VTEC (EJ8)		01.1996	01.2001	13.0460-0073.2	610073	ACCES. JEUX PLAQ.	45237-SR3-003 , 45238-SR3-003	
CR-V I (97-02)	2,0 i 16V (RD1)		01.1997	06.2002	13.0460-0075.2	610075	ACCES. JEUX PLAQ.	45227-SM4-003 , 45237-SM5-A01 , 45237-SP0-003 , 45237-SS0-A01	
LEGEND (96-)	3,5 i 24V (KA9)		11.1997	12.1998	13.0460-0287.2	610287	ACCES. JEUX PLAQ.	43227-SG0-013 , 43244-SG0-003 , 43244-SZ3-A01	



					description	Références OE par référence ATE.		Références remplacées / divers
--	--	--	--	--	-------------	----------------------------------	--	--------------------------------







HONDA

LEGEND (96-)	3,5 i 24V (KA9)		01.1999		13.0460-0287.2	610287	ACCES. JEUX PLAQ.	43227-SG0-013 , 43244-SG0-003 , 43244-SZ3-A01	
			02.1996	10.1997	13.0460-0287.2	610287	ACCES. JEUX PLAQ.	43227-SG0-013 , 43244-SG0-003 , 43244-SZ3-A01	
PRELUDE (97-)	2,0 i 16V (BB9)		01.1997		13.0460-0287.2	610287	ACCES. JEUX PLAQ.	43227-SG0-013 , 43244-SG0-003 , 43244-SZ3-A01	
			01.1997		13.0460-0075.2	610075	ACCES. JEUX PLAQ.	45227-SM4-003 , 45237-SM5-A01 , 45237-SP0-003 , 45237-SS0-A01	
	2,2 i 16V (BB6/BB8)		01.1997		13.0460-0075.2	610075	ACCES. JEUX PLAQ.	45227-SM4-003 , 45237-SM5-A01 , 45237-SP0-003 , 45237-SS0-A01	
			01.1997		13.0460-0287.2	610287	ACCES. JEUX PLAQ.	43227-SG0-013 , 43244-SG0-003 , 43244-SZ3-A01	
SHUTTLE / ODYSSEY (95-01)	2,2 i 16V (RA)		01.1995	12.1997	13.0460-0287.2	610287	ACCES. JEUX PLAQ.	43227-SG0-013 , 43244-SG0-003 , 43244-SZ3-A01	
			01.1995	12.1997	13.0460-0075.2	610075	ACCES. JEUX PLAQ.	45227-SM4-003 , 45237-SM5-A01 , 45237-SP0-003 , 45237-SS0-A01	
	2,3 i 16V (RA)		01.1998	05.2001	13.0460-0075.2	610075	ACCES. JEUX PLAQ.	45227-SM4-003 , 45237-SM5-A01 , 45237-SP0-003 , 45237-SS0-A01	
			01.1998	05.2001	13.0460-0287.2	610287	ACCES. JEUX PLAQ.	43227-SG0-013 , 43244-SG0-003 , 43244-SZ3-A01	

Nouvelles références disponibles - par applications

02/2007



					description	Références OE par référence ATE.		Références remplacées / divers
---	---	---	---	---	-------------	----------------------------------	---	--------------------------------

KIA

CARNIVAL I (99-01)	2,5 i V6		04.1999	09.2001	24.0124-0195.1	424195	DISQUE DE FREIN	KJ002-33-251C , OK552-33-251 , OK56A-33-251 , OK552-33-251A	
	2,9 TDi		04.1999	09.2001	24.0124-0195.1	424195	DISQUE DE FREIN	KJ002-33-251C , OK552-33-251 , OK56A-33-251 , OK552-33-251A	
CARNIVAL II (01-)	2,5 i V6		10.2001	11.2003	24.0126-0135.1	426135	DISQUE DE FREIN	OK55B-33-251 , OK55A-33-251	
	2,9 CRDi		10.2001	11.2003	24.0126-0135.1	426135	DISQUE DE FREIN	OK55B-33-251 , OK55A-33-251	
	3,5 i V6		07.2002	11.2003	24.0126-0135.1	426135	DISQUE DE FREIN	OK55B-33-251 , OK55A-33-251	
CLARUS (96-99)	2,0 i 16V		05.1996	12.1999	13.0460-0296.2	610296	ACCES. JEUX PLAQ.	OK9A0-26-29Z	
SEDONA I (GB) (99-01)	2,5 i V6		04.1999	09.2001	24.0124-0195.1	424195	DISQUE DE FREIN	KJ002-33-251C , OK552-33-251 , OK56A-33-251 , OK552-33-251A	
	2,9 TDi		04.1999	09.2001	24.0124-0195.1	424195	DISQUE DE FREIN	KJ002-33-251C , OK552-33-251 , OK56A-33-251 , OK552-33-251A	
SEDONA II (GB) (01-)	2,5 i V6		10.2001	11.2003	24.0126-0135.1	426135	DISQUE DE FREIN	OK55B-33-251 , OK55A-33-251	
	2,9 CRDi		10.2001	11.2003	24.0126-0135.1	426135	DISQUE DE FREIN	OK55B-33-251 , OK55A-33-251	
	3,5 i V6		07.2002	11.2003	24.0126-0135.1	426135	DISQUE DE FREIN	OK55B-33-251 , OK55A-33-251	

Nouvelles références disponibles - par applications

02/2007



				description	Références OE par référence ATE.		Références remplacées / divers
--	--	--	--	-------------	----------------------------------	--	--------------------------------

LANCIA

PHEDRA (02-)	2,0 i 16V	AvG	08.2002		24.3601-1711.7	220607	ETRIER A GRIFFE	4401 C6 , 9949538	
		AvD	08.2002		24.3601-1712.7	220608	ETRIER A GRIFFE	4401 C7 , 9949539	
	2,0 JTD	AvD	08.2002		24.3601-1712.7	220608	ETRIER A GRIFFE	4401 C7 , 9949539	
		AvG	08.2002		24.3601-1711.7	220607	ETRIER A GRIFFE	4401 C6 , 9949538	
	2,2 JTD	AvD	08.2002		24.3601-1712.7	220608	ETRIER A GRIFFE	4401 C7 , 9949539	
		AvG	08.2002		24.3601-1711.7	220607	ETRIER A GRIFFE	4401 C6 , 9949538	

LAND ROVER

FREELANDER (LN) (98-)	1,8i 16V		02.1998		24.0114-0113.1	414113	DISQUE DE FREIN	SDB100830	
	2,0 DI		02.1998		24.0114-0113.1	414113	DISQUE DE FREIN	SDB100830	
	2,0 TD4		11.2000		24.0114-0113.1	414113	DISQUE DE FREIN	SDB100830	
	2,5 V6		11.2000		24.0114-0113.1	414113	DISQUE DE FREIN	SDB100830	

MAZDA

MPV II (99-)	2,0 CITD (LW19)		07.2002	08.2003	03.0137-0473.2	650473	JEU DE MACHOIRE	LDY5-26-38ZA , LDY7-26-38ZB	
	2,3 i 16V (LW19)		07.2002	08.2003	03.0137-0473.2	650473	JEU DE MACHOIRE	LDY5-26-38ZA , LDY7-26-38ZB	
	3,0 i V6 (LW19)		03.2002	08.2003	03.0137-0473.2	650473	JEU DE MACHOIRE	LDY5-26-38ZA , LDY7-26-38ZB	



					description	Références OE par référence ATE.		Références remplacées / divers
--	--	--	--	--	-------------	----------------------------------	--	--------------------------------

MERCEDES BENZ

MERCEDES-BENZ Classe A (W168) (97-04)	A 140		09.1997	08.2004	83.7715-0280.3	330806	FLEXIBLE FREIN	168 428 03 35	83.6115-0280.3
	A 140 L		03.2001	08.2004	83.7715-0280.3	330806	FLEXIBLE FREIN	168 428 03 35	83.6115-0280.3
			03.2001	08.2004	13.0460-0024.2	610024	ACCES. JEUX PLAQ.		
	A 160		09.1997	08.2004	83.7715-0280.3	330806	FLEXIBLE FREIN	168 428 03 35	83.6115-0280.3
			09.1997	08.2004	13.0460-0024.2	610024	ACCES. JEUX PLAQ.		
	A 160 CDI		02.2001	08.2004	83.7715-0280.3	330806	FLEXIBLE FREIN	168 428 03 35	83.6115-0280.3
			08.1998	01.2001	83.7715-0280.3	330806	FLEXIBLE FREIN	168 428 03 35	83.6115-0280.3
	A 160 L		03.2001	08.2004	83.7715-0280.3	330806	FLEXIBLE FREIN	168 428 03 35	83.6115-0280.3
			03.2001	08.2004	13.0460-0024.2	610024	ACCES. JEUX PLAQ.		
	A 170 CDI		03.1998	01.2001	83.7715-0280.3	330806	FLEXIBLE FREIN	168 428 03 35	83.6115-0280.3
			02.2001	08.2004	83.7715-0280.3	330806	FLEXIBLE FREIN	168 428 03 35	83.6115-0280.3
			02.2001	08.2004	13.0460-0024.2	610024	ACCES. JEUX PLAQ.		
			03.1998	01.2001	13.0460-0024.2	610024	ACCES. JEUX PLAQ.		
	A 170 CDI L		03.2001	08.2004	83.7715-0280.3	330806	FLEXIBLE FREIN	168 428 03 35	83.6115-0280.3
			03.2001	08.2004	13.0460-0024.2	610024	ACCES. JEUX PLAQ.		
	A 190		05.1999	08.2004	83.7715-0280.3	330806	FLEXIBLE FREIN	168 428 03 35	83.6115-0280.3
			05.1999	08.2004	13.0460-0024.2	610024	ACCES. JEUX PLAQ.		
	A 190 L		03.2001	08.2004	83.7715-0280.3	330806	FLEXIBLE FREIN	168 428 03 35	83.6115-0280.3
			03.2001	08.2004	13.0460-0024.2	610024	ACCES. JEUX PLAQ.		
	A 210 Evolution		03.2002	08.2004	83.7715-0280.3	330806	FLEXIBLE FREIN	168 428 03 35	83.6115-0280.3

Nouvelles références disponibles - par applications

02/2007



					description	Références OE par référence ATE.		Références remplacées / divers
--	--	--	--	--	-------------	----------------------------------	--	--------------------------------







MERCEDES BENZ

MERCEDES-BENZ Classe A (W168) (97-04)	A 210 Evolution L		03.2002	08.2004	83.7715-0280.3	330806	FLEXIBLE FREIN	168 428 03 35	83.6115-0280.3
MERCEDES-BENZ Classe A (W169) (04-)	A 150		08.2004		13.0460-2712.2	602712	PLAQUETTES DE FREIN	169 420 04 20	cf. Photo
	A 160 CDI		08.2004		13.0460-2712.2	602712	PLAQUETTES DE FREIN	169 420 04 20	cf. Photo
	A 170		08.2004		13.0460-2712.2	602712	PLAQUETTES DE FREIN	169 420 04 20	cf. Photo
	A 180 CDI		08.2004		13.0460-2712.2	602712	PLAQUETTES DE FREIN	169 420 04 20	cf. Photo
	A 200		08.2004		13.0460-2712.2	602712	PLAQUETTES DE FREIN	169 420 04 20	cf. Photo
	A 200 CDI		08.2004		13.0460-2712.2	602712	PLAQUETTES DE FREIN	169 420 04 20	cf. Photo
	A 200 Turbo		03.2005		13.0460-2712.2	602712	PLAQUETTES DE FREIN	169 420 04 20	cf. Photo
MERCEDES-BENZ Classe B (W245) (05-)	B 150		04.2005		13.0460-2712.2	602712	PLAQUETTES DE FREIN	169 420 04 20	cf. Photo
	B 170		04.2005		13.0460-2712.2	602712	PLAQUETTES DE FREIN	169 420 04 20	cf. Photo
	B 180 CDI		04.2005		13.0460-2712.2	602712	PLAQUETTES DE FREIN	169 420 04 20	cf. Photo
	B 200		04.2005		13.0460-2712.2	602712	PLAQUETTES DE FREIN	169 420 04 20	cf. Photo
	B 200 CDI		04.2005		13.0460-2712.2	602712	PLAQUETTES DE FREIN	169 420 04 20	cf. Photo
	B 200 Turbo		04.2005		13.0460-2712.2	602712	PLAQUETTES DE FREIN	169 420 04 20	cf. Photo
MERCEDES-BENZ Classe C (CL203) Sportcoupé (01-)	C 160 Kompressor	ArG	04.2005		24.0711-6054.3	360184	CAPTEUR DE ROUE	203 540 13 17	
	C 180	ArG	03.2001		24.0711-6054.3	360184	CAPTEUR DE ROUE	203 540 13 17	
	C 180 Kompressor	ArG	05.2002		24.0711-6054.3	360184	CAPTEUR DE ROUE	203 540 13 17	
	C 200 CDI	ArG	07.2003		24.0711-6054.3	360184	CAPTEUR DE ROUE	203 540 13 17	
	C 200 CGI Kompressor	ArG	07.2003		24.0711-6054.3	360184	CAPTEUR DE ROUE	203 540 13 17	

Nouvelles références disponibles - par applications

02/2007



					description	Références OE par référence ATE.	 Références remplacées / divers
---	---	---	---	---	-------------	----------------------------------	--

MERCEDES BENZ

MERCEDES-BENZ Classe C (CL203) Sportcoupé (01-)	C 200 Kompressor	ArG	03.2001		24.0711-6054.3	360184	CAPTEUR DE ROUE	203 540 13 17	
	C 220 CDI	ArG	03.2001		24.0711-6054.3	360184	CAPTEUR DE ROUE	203 540 13 17	
	C 230 Kompressor	ArG	03.2001		24.0711-6054.3	360184	CAPTEUR DE ROUE	203 540 13 17	
	C 30 CDI AMG	ArG	09.2002		24.0711-6054.3	360184	CAPTEUR DE ROUE	203 540 13 17	
	C 320	ArG	09.2002		24.0711-6054.3	360184	CAPTEUR DE ROUE	203 540 13 17	
MERCEDES-BENZ Classe C (S203) Break (01-)	C 180	ArG	03.2001		24.0711-6054.3	360184	CAPTEUR DE ROUE	203 540 13 17	
	C 180 Kompressor	ArG	05.2002		24.0711-6054.3	360184	CAPTEUR DE ROUE	203 540 13 17	
	C 200 CDI	ArG	03.2001		24.0711-6054.3	360184	CAPTEUR DE ROUE	203 540 13 17	
	C 200 CGI Kompressor	ArG	07.2003		24.0711-6054.3	360184	CAPTEUR DE ROUE	203 540 13 17	
	C 200 Kompressor	ArG	03.2001		24.0711-6054.3	360184	CAPTEUR DE ROUE	203 540 13 17	
	C 220 CDI	ArG	03.2001		24.0711-6054.3	360184	CAPTEUR DE ROUE	203 540 13 17	
	C 230 Kompressor	ArG	02.2004		24.0711-6054.3	360184	CAPTEUR DE ROUE	203 540 13 17	
	C 240	ArG	03.2001		24.0711-6054.3	360184	CAPTEUR DE ROUE	203 540 13 17	
	C 240 4-Matic	ArG	07.2002		24.0711-6054.3	360184	CAPTEUR DE ROUE	203 540 13 17	
	C 270 CDI	ArG	03.2001		24.0711-6054.3	360184	CAPTEUR DE ROUE	203 540 13 17	
	C 30 CDI AMG	ArG	01.2003		24.0711-6054.3	360184	CAPTEUR DE ROUE	203 540 13 17	
	C 32 Kompressor AMG	ArG	03.2001		24.0711-6054.3	360184	CAPTEUR DE ROUE	203 540 13 17	
	C 320	ArG	03.2001		24.0711-6054.3	360184	CAPTEUR DE ROUE	203 540 13 17	
	C 320 4-Matic	ArG	07.2002		24.0711-6054.3	360184	CAPTEUR DE ROUE	203 540 13 17	

Nouvelles références disponibles - par applications

02/2007



					description	Références OE par référence ATE.		Références remplacées / divers
--	--	--	--	--	-------------	----------------------------------	--	--------------------------------







MERCEDES BENZ

MERCEDES-BENZ Classe C (S203) Break (01-)	C 320 CDI	ArG	02.2005		24.0711-6054.3	360184	CAPTEUR DE ROUE	203 540 13 17	
	C 55 AMG	ArG	02.2004		24.0711-6054.3	360184	CAPTEUR DE ROUE	203 540 13 17	
C-Klasse (W203) Limousine (00-07)	C 180	ArG	04.2000		24.0711-6054.3	360184	CAPTEUR DE ROUE	203 540 13 17	
	C 180 Kompressor	ArG	05.2002		24.0711-6054.3	360184	CAPTEUR DE ROUE	203 540 13 17	
	C 200 CDI	ArG	04.2000		24.0711-6054.3	360184	CAPTEUR DE ROUE	203 540 13 17	
	C 200 CGI Kompressor	ArG	07.2003		24.0711-6054.3	360184	CAPTEUR DE ROUE	203 540 13 17	
	C 200 Kompressor	ArG	04.2000		24.0711-6054.3	360184	CAPTEUR DE ROUE	203 540 13 17	
	C 220 CDI	ArG	04.2000		24.0711-6054.3	360184	CAPTEUR DE ROUE	203 540 13 17	
	C 230 Kompressor	ArG	02.2004		24.0711-6054.3	360184	CAPTEUR DE ROUE	203 540 13 17	
	C 240	ArG	04.2000		24.0711-6054.3	360184	CAPTEUR DE ROUE	203 540 13 17	
	C 240 4-Matic	ArG	07.2002		24.0711-6054.3	360184	CAPTEUR DE ROUE	203 540 13 17	
	C 270 CDI	ArG	08.2000		24.0711-6054.3	360184	CAPTEUR DE ROUE	203 540 13 17	
	C 30 CDI AMG	ArG	01.2003		24.0711-6054.3	360184	CAPTEUR DE ROUE	203 540 13 17	
	C 32 Kompressor AMG	ArG	03.2001		24.0711-6054.3	360184	CAPTEUR DE ROUE	203 540 13 17	
	C 320	ArG	04.2000		24.0711-6054.3	360184	CAPTEUR DE ROUE	203 540 13 17	
	C 320 4-Matic	ArG	07.2002		24.0711-6054.3	360184	CAPTEUR DE ROUE	203 540 13 17	
	C 320 CDI	ArG	02.2005		24.0711-6054.3	360184	CAPTEUR DE ROUE	203 540 13 17	
	C 55 AMG	ArG	02.2004		24.0711-6054.3	360184	CAPTEUR DE ROUE	203 540 13 17	
Classe CLK (A209) Décapotable (03-)	CLK 200 CGI	ArG	05.2003		24.0711-6054.3	360184	CAPTEUR DE ROUE	203 540 13 17	

Nouvelles références disponibles - par applications

02/2007



					description	Références OE par référence ATE.		Références remplacées / divers
---	---	---	---	---	-------------	----------------------------------	---	--------------------------------

MERCEDES BENZ

Classe CLK (A209) Décapotable (03-)	CLK 200 Kompressor	ArG	05.2003		24.0711-6054.3	360184	CAPTEUR DE ROUE	203 540 13 17	
	CLK 240	ArG	05.2003		24.0711-6054.3	360184	CAPTEUR DE ROUE	203 540 13 17	
	CLK 280	ArG	05.2005		24.0711-6054.3	360184	CAPTEUR DE ROUE	203 540 13 17	
	CLK 320	ArG	05.2003		24.0711-6054.3	360184	CAPTEUR DE ROUE	203 540 13 17	
	CLK 320 CDI	ArG	05.2005		24.0711-6054.3	360184	CAPTEUR DE ROUE	203 540 13 17	
	CLK 350	ArG	05.2005		24.0711-6054.3	360184	CAPTEUR DE ROUE	203 540 13 17	
	CLK 500	ArG	05.2003		24.0711-6054.3	360184	CAPTEUR DE ROUE	203 540 13 17	
	CLK 55 AMG	ArG	05.2003		24.0711-6054.3	360184	CAPTEUR DE ROUE	203 540 13 17	
MERCEDES-BENZ Classe CLK (C209) Coupé (02-)	CLK 200 CGI	ArG	09.2002		24.0711-6054.3	360184	CAPTEUR DE ROUE	203 540 13 17	
	CLK 200 Kompressor	ArG	09.2002		24.0711-6054.3	360184	CAPTEUR DE ROUE	203 540 13 17	
	CLK 220 CDI	ArG	05.2005		24.0711-6054.3	360184	CAPTEUR DE ROUE	203 540 13 17	
	CLK 240	ArG	05.2002		24.0711-6054.3	360184	CAPTEUR DE ROUE	203 540 13 17	
	CLK 270 CDI	ArG	10.2002		24.0711-6054.3	360184	CAPTEUR DE ROUE	203 540 13 17	
	CLK 280	ArG	05.2005		24.0711-6054.3	360184	CAPTEUR DE ROUE	203 540 13 17	
	CLK 320	ArG	05.2002		24.0711-6054.3	360184	CAPTEUR DE ROUE	203 540 13 17	
	CLK 320 CDI	ArG	05.2005		24.0711-6054.3	360184	CAPTEUR DE ROUE	203 540 13 17	
	CLK 350	ArG	05.2005		24.0711-6054.3	360184	CAPTEUR DE ROUE	203 540 13 17	
	CLK 500	ArG	05.2002		24.0711-6054.3	360184	CAPTEUR DE ROUE	203 540 13 17	
	CLK 55 AMG	ArG	09.2002		24.0711-6054.3	360184	CAPTEUR DE ROUE	203 540 13 17	

Nouvelles références disponibles - par applications

02/2007



						description	Références OE par référence ATE.		Références remplacées / divers
--	--	--	--	--	--	-------------	----------------------------------	--	--------------------------------

MERCEDES BENZ

Transporter (BM 901/902) SPRINTER (95-06)	208 CDI		04.2000	05.2006	13.0460-0281.2	610281	ACCES. JEUX PLAQ.	2D0 698 295 A	
	208 D		02.1995	05.2006	13.0460-0281.2	610281	ACCES. JEUX PLAQ.	2D0 698 295 A	
	210 D		01.1997	05.2006	13.0460-0281.2	610281	ACCES. JEUX PLAQ.	2D0 698 295 A	
	211 CDI		04.2000	05.2006	13.0460-0281.2	610281	ACCES. JEUX PLAQ.	2D0 698 295 A	
	212 D		02.1995	05.2006	13.0460-0281.2	610281	ACCES. JEUX PLAQ.	2D0 698 295 A	
	213 CDI		04.2000	05.2006	13.0460-0281.2	610281	ACCES. JEUX PLAQ.	2D0 698 295 A	
	214		04.2000	05.2006	13.0460-0281.2	610281	ACCES. JEUX PLAQ.	2D0 698 295 A	
			02.1995	05.2006	13.0460-0281.2	610281	ACCES. JEUX PLAQ.	2D0 698 295 A	
	216 CDI		04.2000	05.2006	13.0460-0281.2	610281	ACCES. JEUX PLAQ.	2D0 698 295 A	
Transporter (BM 903/904) SPRINTER (95-06)	308 CDI		04.2000	05.2006	13.0460-0281.2	610281	ACCES. JEUX PLAQ.	2D0 698 295 A	
	308 D		02.1995	05.2006	13.0460-0281.2	610281	ACCES. JEUX PLAQ.	2D0 698 295 A	
	310 D		02.1995	05.2006	13.0460-0281.2	610281	ACCES. JEUX PLAQ.	2D0 698 295 A	
	311 CDI		04.2000	05.2006	13.0460-0281.2	610281	ACCES. JEUX PLAQ.	2D0 698 295 A	
	312 D		02.1995	05.2006	13.0460-0281.2	610281	ACCES. JEUX PLAQ.	2D0 698 295 A	
	313 CDI		04.2000	05.2006	13.0460-0281.2	610281	ACCES. JEUX PLAQ.	2D0 698 295 A	
	314		04.2000	05.2006	13.0460-0281.2	610281	ACCES. JEUX PLAQ.	2D0 698 295 A	
			02.1995	05.2006	13.0460-0281.2	610281	ACCES. JEUX PLAQ.	2D0 698 295 A	
	316 CDI		04.2000	05.2006	13.0460-0281.2	610281	ACCES. JEUX PLAQ.	2D0 698 295 A	
	408 CDI		04.2000	05.2006	13.0460-0281.2	610281	ACCES. JEUX PLAQ.	2D0 698 295 A	

Nouvelles références disponibles - par applications

02/2007



					description	Références OE par référence ATE.		Références remplacées / divers
--	--	--	--	--	-------------	----------------------------------	--	--------------------------------







MERCEDES BENZ

Transporter (BM 903/904) SPRINTER (95-06)	408 CDI		04.2000	05.2006	13.0460-0281.2	610281	ACCES. JEUX PLAQ.	2D0 698 295 A	
	408 D			05.2006	13.0460-0281.2	610281	ACCES. JEUX PLAQ.	2D0 698 295 A	
				05.2006	13.0460-0281.2	610281	ACCES. JEUX PLAQ.	2D0 698 295 A	
	410 D			05.2006	13.0460-0281.2	610281	ACCES. JEUX PLAQ.	2D0 698 295 A	
				05.2006	13.0460-0281.2	610281	ACCES. JEUX PLAQ.	2D0 698 295 A	
	411 CDI		04.2000	05.2006	13.0460-0281.2	610281	ACCES. JEUX PLAQ.	2D0 698 295 A	
			04.2000	05.2006	13.0460-0281.2	610281	ACCES. JEUX PLAQ.	2D0 698 295 A	
	412 D			05.2006	13.0460-0281.2	610281	ACCES. JEUX PLAQ.	2D0 698 295 A	
				05.2006	13.0460-0281.2	610281	ACCES. JEUX PLAQ.	2D0 698 295 A	
	413 CDI		04.2000	05.2006	13.0460-0281.2	610281	ACCES. JEUX PLAQ.	2D0 698 295 A	
			04.2000	05.2006	13.0460-0281.2	610281	ACCES. JEUX PLAQ.	2D0 698 295 A	
	414			05.2006	13.0460-0281.2	610281	ACCES. JEUX PLAQ.	2D0 698 295 A	
			04.2000	05.2006	13.0460-0281.2	610281	ACCES. JEUX PLAQ.	2D0 698 295 A	
			04.2000	05.2006	13.0460-0281.2	610281	ACCES. JEUX PLAQ.	2D0 698 295 A	
				05.2006	13.0460-0281.2	610281	ACCES. JEUX PLAQ.	2D0 698 295 A	
	416 CDI		04.2000	05.2006	13.0460-0281.2	610281	ACCES. JEUX PLAQ.	2D0 698 295 A	
			04.2000	05.2006	13.0460-0281.2	610281	ACCES. JEUX PLAQ.	2D0 698 295 A	
Transporter (BM 905) SPRINTER (01-06)	616 CDI		04.2001	05.2006	13.0460-0281.2	610281	ACCES. JEUX PLAQ.	2D0 698 295 A	
VANEO (BM414) (02-)	1,6		02.2002		24.5123-0295.3	330820	FLEXIBLE FREIN	414 428 00 35	

Nouvelles références disponibles - par applications

02/2007



					description	Références OE par référence ATE.		Références remplacées / divers
---	---	---	---	---	-------------	----------------------------------	---	--------------------------------

MERCEDES BENZ

VANEO (BM414) (02-)	1,7 CDI		02.2002		24.5123-0295.3	330820	FLEXIBLE FREIN	414 428 00 35	
	1,9		02.2002		24.5123-0295.3	330820	FLEXIBLE FREIN	414 428 00 35	

MINI

Cabrio R52 (04-)	1,6 i		04.2004		24.5125-0415.3	330821	FLEXIBLE FREIN	34 30 6 763 682	
	Cooper 1,6 i		04.2004		24.5125-0415.3	330821	FLEXIBLE FREIN	34 30 6 763 682	
	Cooper S 1,6 i		04.2004		24.5125-0415.3	330821	FLEXIBLE FREIN	34 30 6 763 682	
	Cooper S Works 1,6 i		11.2003		24.5125-0415.3	330821	FLEXIBLE FREIN	34 30 6 763 682	
R50/R53 (00-)	Cooper 1,6 i		04.2003		24.5125-0415.3	330821	FLEXIBLE FREIN	34 30 6 763 682	
	Cooper S 1,6 i		04.2003		24.5125-0415.3	330821	FLEXIBLE FREIN	34 30 6 763 682	
	Cooper S Works 1,6 i		11.2003		24.5125-0415.3	330821	FLEXIBLE FREIN	34 30 6 763 682	
	One 1,4 d		04.2003		24.5125-0415.3	330821	FLEXIBLE FREIN	34 30 6 763 682	
	One 1,4 i		04.2003		24.5125-0415.3	330821	FLEXIBLE FREIN	34 30 6 763 682	
	One 1,6 i		04.2003		24.5125-0415.3	330821	FLEXIBLE FREIN	34 30 6 763 682	

Nouvelles références disponibles - par applications

02/2007



						description	Références OE par référence ATE.		Références remplacées / divers
--	--	--	--	--	--	-------------	----------------------------------	--	--------------------------------

NISSAN

ALMERA (N15) (95-00)	1,4 i		07.1995	04.2000	13.0460-0284.2	610284	ACCES. JEUX PLAQ.	44080-0M825	
			07.1995	04.2000	13.0460-0283.2	610283	ACCES. JEUX PLAQ.	41080-1N025 , 41080-1N026	
			07.1997	04.2000	13.0460-0285.2	610285	ACCES. JEUX PLAQ.	41080-40F85 , 41080-40F86 , 41080-40F87	
	1,6 i		07.1997	04.1998	13.0460-0285.2	610285	ACCES. JEUX PLAQ.	41080-40F85 , 41080-40F86 , 41080-40F87	
			02.1998	04.2000	13.0460-0285.2	610285	ACCES. JEUX PLAQ.	41080-40F85 , 41080-40F86 , 41080-40F87	
			05.1998	04.2000	13.0460-0285.2	610285	ACCES. JEUX PLAQ.	41080-40F85 , 41080-40F86 , 41080-40F87	
			07.1995	04.2000	13.0460-0284.2	610284	ACCES. JEUX PLAQ.	44080-0M825	
			07.1995	01.1998	13.0460-0283.2	610283	ACCES. JEUX PLAQ.	41080-1N025 , 41080-1N026	
	2,0 D		07.1997	04.1998	13.0460-0285.2	610285	ACCES. JEUX PLAQ.	41080-40F85 , 41080-40F86 , 41080-40F87	
			05.1998	04.2000	13.0460-0285.2	610285	ACCES. JEUX PLAQ.	41080-40F85 , 41080-40F86 , 41080-40F87	
			07.1995	04.2000	13.0460-0283.2	610283	ACCES. JEUX PLAQ.	41080-1N025 , 41080-1N026	
			07.1995	04.2000	13.0460-0284.2	610284	ACCES. JEUX PLAQ.	44080-0M825	
	2,0 i		04.1996	04.2000	13.0460-0294.2	610294	ACCES. JEUX PLAQ.	41080-54C26	
			04.1996	04.2000	13.0460-0332.2	610332	ACCES. JEUX PLAQ.	44080-54C28	
ALMERA TINO (V10M) (00-)	1,6 i 16V		02.2003		13.0460-5825.2	605825	PLAQUETTES DE FREIN	41060-AV125 , 41060-AV126 , 41060-4U125 , 41060-4U126 , 41060-4U127 , 45022-S1A-E02 , 45022-S1A-E50	cf. Photo

Nouvelles références disponibles - par applications

02/2007



					description	Références OE par référence ATE.		Références remplacées / divers
--	--	--	--	--	-------------	----------------------------------	--	--------------------------------

NISSAN

ALMERA TINO (V10M) (00-)	1,6 i 16V		08.2000	01.2003	13.0460-5825.2	605825	PLAQUETTES DE FREIN	41060-AV125 , 41060-AV126 , 41060-4U125 , 41060-4U126 , 41060-4U127 , 45022-S1A-E02 , 45022-S1A-E50	cf. Photo
			02.2003		13.0460-0282.2	610282	ACCES. JEUX PLAQ.	41084-4U125	
			08.2000	01.2003	13.0460-0282.2	610282	ACCES. JEUX PLAQ.	41084-4U125	
	1,8 i 16V		02.2003		13.0460-5825.2	605825	PLAQUETTES DE FREIN	41060-AV125 , 41060-AV126 , 41060-4U125 , 41060-4U126 , 41060-4U127 , 45022-S1A-E02 , 45022-S1A-E50	cf. Photo
			08.2000	01.2003	13.0460-5825.2	605825	PLAQUETTES DE FREIN	41060-AV125 , 41060-AV126 , 41060-4U125 , 41060-4U126 , 41060-4U127 , 45022-S1A-E02 , 45022-S1A-E50	cf. Photo
			12.2002		13.0460-5825.2	605825	PLAQUETTES DE FREIN	41060-AV125 , 41060-AV126 , 41060-4U125 , 41060-4U126 , 41060-4U127 , 45022-S1A-E02 , 45022-S1A-E50	cf. Photo
			08.2000	01.2003	13.0460-0282.2	610282	ACCES. JEUX PLAQ.	41084-4U125	
			02.2003		13.0460-0282.2	610282	ACCES. JEUX PLAQ.	41084-4U125	
			12.2002		13.0460-0282.2	610282	ACCES. JEUX PLAQ.	41084-4U125	
	2,0 i 16V		02.2003	08.2003	13.0460-5825.2	605825	PLAQUETTES DE FREIN	41060-AV125 , 41060-AV126 , 41060-4U125 , 41060-4U126 , 41060-4U127 , 45022-S1A-E02 , 45022-S1A-E50	cf. Photo



						description	Références OE par référence ATE.		Références remplacées / divers
--	--	--	--	--	--	-------------	----------------------------------	--	--------------------------------

NISSAN

ALMERA TINO (V10M) (00-)	2,0 i 16V		08.2000	01.2003	13.0460-5825.2	605825	PLAQUETTES DE FREIN	41060-AV125 , 41060-AV126 , 41060-4U125 , 41060-4U126 , 41060-4U127 , 45022-S1A-E02 , 45022-S1A-E50	cf. Photo
			02.2003	08.2003	13.0460-0282.2	610282	ACCES. JEUX PLAQ.	41084-4U125	
			08.2000	01.2003	13.0460-0282.2	610282	ACCES. JEUX PLAQ.	41084-4U125	
	2,2 dCi		09.2003		13.0460-5825.2	605825	PLAQUETTES DE FREIN	41060-AV125 , 41060-AV126 , 41060-4U125 , 41060-4U126 , 41060-4U127 , 45022-S1A-E02 , 45022-S1A-E50	cf. Photo
			09.2003		13.0460-0282.2	610282	ACCES. JEUX PLAQ.	41084-4U125	
	2,2 Di		08.2000	01.2003	13.0460-5825.2	605825	PLAQUETTES DE FREIN	41060-AV125 , 41060-AV126 , 41060-4U125 , 41060-4U126 , 41060-4U127 , 45022-S1A-E02 , 45022-S1A-E50	cf. Photo
			02.2003	08.2003	13.0460-5825.2	605825	PLAQUETTES DE FREIN	41060-AV125 , 41060-AV126 , 41060-4U125 , 41060-4U126 , 41060-4U127 , 45022-S1A-E02 , 45022-S1A-E50	cf. Photo
			02.2003	08.2003	13.0460-0282.2	610282	ACCES. JEUX PLAQ.	41084-4U125	
			08.2000	01.2003	13.0460-0282.2	610282	ACCES. JEUX PLAQ.	41084-4U125	
INTERSTAR (X70) (02-)	1,9 CDi		07.2002		13.0460-0344.2	610344	ACCES. JEUX PLAQ.	41080-00QAA	
	2,2 CDi		07.2002		13.0460-0344.2	610344	ACCES. JEUX PLAQ.	41080-00QAA	
	2,5 CDi		07.2002		13.0460-0344.2	610344	ACCES. JEUX PLAQ.	41080-00QAA	

Nouvelles références disponibles - par applications

02/2007









					description	Références OE par référence ATE.		Références remplacées / divers
--	--	--	--	--	-------------	----------------------------------	--	--------------------------------

NISSAN

INTERSTAR (X70) (02-)	3,0 CDi		11.2003		13.0460-0344.2	610344	ACCES. JEUX PLAQ.	41080-00QAA
MAXIMA (CA33) (00-)	2,0 i V6		03.2000		13.0460-0295.2	610295	ACCES. JEUX PLAQ.	44080-54C25 , 44080-58Y25 , 44080-4U025
	2,5 i V6		03.2000		13.0460-0295.2	610295	ACCES. JEUX PLAQ.	44080-54C25 , 44080-58Y25 , 44080-4U025
	3,0 i V6		03.2000		13.0460-0295.2	610295	ACCES. JEUX PLAQ.	44080-54C25 , 44080-58Y25 , 44080-4U025
MICRA (K12E) (03-)	1,0 i 16V		01.2003		13.0460-0291.2	610291	ACCES. JEUX PLAQ.	41083-AX625
	1,2 i 16V		01.2003		13.0460-0291.2	610291	ACCES. JEUX PLAQ.	41083-AX625
	1,4 i 16V		01.2003		13.0460-0291.2	610291	ACCES. JEUX PLAQ.	41083-AX625
	1,5 dCi		09.2003		13.0460-0291.2	610291	ACCES. JEUX PLAQ.	41083-AX625
			01.2003		13.0460-0291.2	610291	ACCES. JEUX PLAQ.	41083-AX625
	1,6 i 16V		05.2005		13.0460-0291.2	610291	ACCES. JEUX PLAQ.	41083-AX625
MICRA C+C (CK12E) (05-)	1,4 i 16V		08.2005		13.0460-0291.2	610291	ACCES. JEUX PLAQ.	41083-AX625
	1,6 i 16V		08.2005		13.0460-0291.2	610291	ACCES. JEUX PLAQ.	41083-AX625
MURANO (Z50) (03-)	3,5 i V6 4x4		10.2003		13.0460-0341.2	610341	ACCES. JEUX PLAQ.	44080-8H325
PICK-UP (D22) (98-)	2,4 i		11.2001		13.0460-0289.2	610289	ACCES. JEUX PLAQ.	41080-09G27 , 41080-09G28
			02.1998	10.2001	13.0460-0289.2	610289	ACCES. JEUX PLAQ.	41080-09G27 , 41080-09G28
	2,4 i 4WD		02.1998	10.2001	13.0460-0289.2	610289	ACCES. JEUX PLAQ.	41080-09G27 , 41080-09G28
	2,5 D		02.1998	10.2001	13.0460-0289.2	610289	ACCES. JEUX PLAQ.	41080-09G27 , 41080-09G28
	2,5 TD 4WD		05.1998	10.2001	13.0460-0289.2	610289	ACCES. JEUX PLAQ.	41080-09G27 , 41080-09G28



		 		description	Références OE par référence ATE.	 Références remplacées / divers
---	---	---	---	-------------	--	---

NISSAN

PICK-UP (D22) (98-)	2,5 TDi		11.2001		13.0460-0289.2	610289	ACCES. JEUX PLAQ.	41080-09G27 , 41080-09G28	
PRIMERA (P12E) Berline (02-)	1,6		03.2002		13.0460-5825.2	605825	PLAQUETTES DE FREIN	41060-AV125 , 41060-AV126 , 41060-4U125 , 41060-4U126 , 41060-4U127 , 45022-S1A-E02 , 45022-S1A-E50	cf. Photo
			03.2002		13.0460-0282.2	610282	ACCES. JEUX PLAQ.	41084-4U125	
	1,8		03.2002		13.0460-5825.2	605825	PLAQUETTES DE FREIN	41060-AV125 , 41060-AV126 , 41060-4U125 , 41060-4U126 , 41060-4U127 , 45022-S1A-E02 , 45022-S1A-E50	cf. Photo
			03.2002		13.0460-0282.2	610282	ACCES. JEUX PLAQ.	41084-4U125	
	1,9 dCi		04.2003		13.0460-5825.2	605825	PLAQUETTES DE FREIN	41060-AV125 , 41060-AV126 , 41060-4U125 , 41060-4U126 , 41060-4U127 , 45022-S1A-E02 , 45022-S1A-E50	cf. Photo
			04.2003		13.0460-0282.2	610282	ACCES. JEUX PLAQ.	41084-4U125	
	2		03.2002		13.0460-5825.2	605825	PLAQUETTES DE FREIN	41060-AV125 , 41060-AV126 , 41060-4U125 , 41060-4U126 , 41060-4U127 , 45022-S1A-E02 , 45022-S1A-E50	cf. Photo
			03.2002		13.0460-0282.2	610282	ACCES. JEUX PLAQ.	41084-4U125	
	2,2 dCi		04.2003		13.0460-5825.2	605825	PLAQUETTES DE FREIN	41060-AV125 , 41060-AV126 , 41060-4U125 , 41060-4U126 , 41060-4U127 , 45022-S1A-E02 , 45022-S1A-E50	cf. Photo
			04.2003		13.0460-0282.2	610282	ACCES. JEUX PLAQ.	41084-4U125	



					description	Références OE par référence ATE.		Références remplacées / divers
--	--	--	--	--	-------------	----------------------------------	--	--------------------------------

NISSAN

PRIMERA (P12E) Berline (02-)	2,2 Di		03.2002		13.0460-5825.2	605825	PLAQUETTES DE FREIN	41060-AV125 , 41060-AV126 , 41060-4U125 , 41060-4U126 , 41060-4U127 , 45022-S1A-E02 , 45022-S1A-E50	cf. Photo
			03.2002		13.0460-0282.2	610282	ACCES. JEUX PLAQ.	41084-4U125	
PRIMERA (W11) Break (98-02)	1,6 i 16V		04.1998	02.2002	13.0460-0290.2	610290	ACCES. JEUX PLAQ.	41084-3J426	
	1,8 i 16V		08.1999	02.2002	13.0460-0290.2	610290	ACCES. JEUX PLAQ.	41084-3J426	
	2,0 i 16V		04.1998	06.1999	13.0460-0290.2	610290	ACCES. JEUX PLAQ.	41084-3J426	
			07.1999	02.2002	13.0460-0290.2	610290	ACCES. JEUX PLAQ.	41084-3J426	
			08.1999	02.2002	13.0460-0290.2	610290	ACCES. JEUX PLAQ.	41084-3J426	
	2,0 TD		04.1998	02.2002	13.0460-0290.2	610290	ACCES. JEUX PLAQ.	41084-3J426	
PRIMERA (W12) Break (02-)	1,6		03.2002		13.0460-5825.2	605825	PLAQUETTES DE FREIN	41060-AV125 , 41060-AV126 , 41060-4U125 , 41060-4U126 , 41060-4U127 , 45022-S1A-E02 , 45022-S1A-E50	cf. Photo
			03.2002		13.0460-0282.2	610282	ACCES. JEUX PLAQ.	41084-4U125	
	1,8		03.2002		13.0460-5825.2	605825	PLAQUETTES DE FREIN	41060-AV125 , 41060-AV126 , 41060-4U125 , 41060-4U126 , 41060-4U127 , 45022-S1A-E02 , 45022-S1A-E50	cf. Photo
			03.2002		13.0460-0282.2	610282	ACCES. JEUX PLAQ.	41084-4U125	



					description	Références OE par référence ATE.		Références remplacées / divers
--	--	--	--	--	-------------	----------------------------------	--	--------------------------------

NISSAN

PRIMERA (W12) Break (02-)	1,9 dCi		04.2003		13.0460-5825.2	605825	PLAQUETTES DE FREIN	41060-AV125 , 41060-AV126 , 41060-4U125 , 41060-4U126 , 41060-4U127 , 45022-S1A-E02 , 45022-S1A-E50	cf. Photo
			04.2003		13.0460-0282.2	610282	ACCES. JEUX PLAQ.	41084-4U125	
	2		03.2002		13.0460-5825.2	605825	PLAQUETTES DE FREIN	41060-AV125 , 41060-AV126 , 41060-4U125 , 41060-4U126 , 41060-4U127 , 45022-S1A-E02 , 45022-S1A-E50	cf. Photo
			03.2002		13.0460-0282.2	610282	ACCES. JEUX PLAQ.	41084-4U125	
	2,2 dCi		04.2003		13.0460-5825.2	605825	PLAQUETTES DE FREIN	41060-AV125 , 41060-AV126 , 41060-4U125 , 41060-4U126 , 41060-4U127 , 45022-S1A-E02 , 45022-S1A-E50	cf. Photo
			04.2003		13.0460-0282.2	610282	ACCES. JEUX PLAQ.	41084-4U125	
	2,2 Di		03.2002		13.0460-5825.2	605825	PLAQUETTES DE FREIN	41060-AV125 , 41060-AV126 , 41060-4U125 , 41060-4U126 , 41060-4U127 , 45022-S1A-E02 , 45022-S1A-E50	cf. Photo
			03.2002		13.0460-0282.2	610282	ACCES. JEUX PLAQ.	41084-4U125	
SUNNY (N14) Berline (90-95)	1,4		10.1990	05.1995	13.0460-0295.2	610295	ACCES. JEUX PLAQ.	44080-54C25 , 44080-58Y25 , 44080-4U025	
	1,6 16V		10.1990	05.1995	13.0460-0295.2	610295	ACCES. JEUX PLAQ.	44080-54C25 , 44080-58Y25 , 44080-4U025	
	1,6 16V 4x4		10.1990	05.1995	13.0460-0295.2	610295	ACCES. JEUX PLAQ.	44080-54C25 , 44080-58Y25 , 44080-4U025	

Nouvelles références disponibles - par applications

02/2007



					description	Références OE par référence ATE.		Références remplacées / divers
--	--	--	--	--	-------------	----------------------------------	--	--------------------------------

NISSAN

SUNNY (N14) Berline (90-95)	2,0 16V GTI		10.1990	05.1995	13.0460-0294.2	610294	ACCES. JEUX PLAQ.	41080-54C26	
			10.1990	05.1995	13.0460-0295.2	610295	ACCES. JEUX PLAQ.	44080-54C25 , 44080-58Y25 , 44080-4U025	
	2,0 D		10.1990	05.1995	13.0460-0295.2	610295	ACCES. JEUX PLAQ.	44080-54C25 , 44080-58Y25 , 44080-4U025	
	2,0 GTI R 4x4		10.1990	05.1995	13.0460-0295.2	610295	ACCES. JEUX PLAQ.	44080-54C25 , 44080-58Y25 , 44080-4U025	
			10.1990	05.1995	13.0460-0294.2	610294	ACCES. JEUX PLAQ.	41080-54C26	
TERRANO I (WD21) (87-97)	2,4 i 4WD		08.1987	10.1993	13.0460-0289.2	610289	ACCES. JEUX PLAQ.	41080-09G27 , 41080-09G28	
	2,7 TD 4WD		08.1987	10.1993	13.0460-0289.2	610289	ACCES. JEUX PLAQ.	41080-09G27 , 41080-09G28	
	3,0 i V6 4WD		01.1990	09.1997	13.0460-0289.2	610289	ACCES. JEUX PLAQ.	41080-09G27 , 41080-09G28	
TERRANO II (R20) (93-)	2,4 i 4WD		10.1999		03.0137-0469.2	650469	JEU DE MACHOIRE	44060-0X825	
	2,7 TD 4WD		10.1999	01.2002	03.0137-0469.2	650469	JEU DE MACHOIRE	44060-0X825	
	2,7 TDi 4WD		10.1999		03.0137-0469.2	650469	JEU DE MACHOIRE	44060-0X825	
	3,0 Di 4WD		05.2002		03.0137-0469.2	650469	JEU DE MACHOIRE	44060-0X825	
X-TRAIL (T30) (01-)	2,0 i 16V		07.2001		24.0116-0119.1	416119	DISQUE DE FREIN	43206-8H700 , 43206-8H701	
			07.2001		13.0460-0340.2	610340	ACCES. JEUX PLAQ.	41080-8H385	
			07.2001		13.0460-0341.2	610341	ACCES. JEUX PLAQ.	44080-8H325	
	2,0 i 16V 4x4		07.2001		24.0116-0119.1	416119	DISQUE DE FREIN	43206-8H700 , 43206-8H701	
			07.2001		13.0460-0340.2	610340	ACCES. JEUX PLAQ.	41080-8H385	
			07.2001		13.0460-0341.2	610341	ACCES. JEUX PLAQ.	44080-8H325	

Nouvelles références disponibles - par applications

02/2007



	i				description	Références OE par référence ATE.	i Références remplacées / divers
--	----------	--	--	--	-------------	----------------------------------	--

NISSAN

Modèle	Version	Date	Date	Code	Code	Description	Références OE	Références divers
X-TRAIL (T30) (01-)	2,2 dCi	12.2003		24.0116-0119.1	416119	DISQUE DE FREIN	43206-8H700 , 43206-8H701	
		12.2003		13.0460-0341.2	610341	ACCES. JEUX PLAQ.	44080-8H325	
		12.2003		13.0460-0340.2	610340	ACCES. JEUX PLAQ.	41080-8H385	
	2,2 dCi 4x4	12.2003		24.0116-0119.1	416119	DISQUE DE FREIN	43206-8H700 , 43206-8H701	
		12.2003		13.0460-0341.2	610341	ACCES. JEUX PLAQ.	44080-8H325	
		12.2003		13.0460-0340.2	610340	ACCES. JEUX PLAQ.	41080-8H385	
	2,2 TDi 4x4	07.2001	11.2003	24.0116-0119.1	416119	DISQUE DE FREIN	43206-8H700 , 43206-8H701	
		07.2001	11.2003	13.0460-0341.2	610341	ACCES. JEUX PLAQ.	44080-8H325	
		07.2001	11.2003	13.0460-0340.2	610340	ACCES. JEUX PLAQ.	41080-8H385	
	2,5 i 16V 4x4	01.2003		24.0116-0119.1	416119	DISQUE DE FREIN	43206-8H700 , 43206-8H701	
		01.2003		13.0460-0340.2	610340	ACCES. JEUX PLAQ.	41080-8H385	
		01.2003		13.0460-0341.2	610341	ACCES. JEUX PLAQ.	44080-8H325	

Nouvelles références disponibles - par applications

02/2007



					description	Références OE par référence ATE.		Références remplacées / divers
--	--	--	--	--	-------------	----------------------------------	--	--------------------------------

OPEL

ASTRA TWIN TOP (06-)	1,6 Twinport		03.2006		24.0110-0291.1	410291	DISQUE DE FREIN	5 69 116 , 93176548	
	1,8		03.2006		24.0110-0291.1	410291	DISQUE DE FREIN	5 69 116 , 93176548	
	1,9 CDTI		03.2006		24.0110-0291.1	410291	DISQUE DE FREIN	5 69 116 , 93176548	
	2,0 Turbo		03.2006		24.0110-0291.1	410291	DISQUE DE FREIN	5 69 116 , 93176548	
COMBO / Vauxhall Combo (01-)	1,3 CDTI		06.2003		24.3727-0761.2	580761	CABLE FREIN A MAIN	24468130 , 5 22 150 , 5 22 450 , 9225541	
	1,4 16V		10.2001		24.3727-0761.2	580761	CABLE FREIN A MAIN	24468130 , 5 22 150 , 5 22 450 , 9225541	
	1,6		10.2001		24.3727-0761.2	580761	CABLE FREIN A MAIN	24468130 , 5 22 150 , 5 22 450 , 9225541	
	1,7 DI 16V		10.2001		24.3727-0761.2	580761	CABLE FREIN A MAIN	24468130 , 5 22 150 , 5 22 450 , 9225541	
	1,7 DTI 16V		10.2001		24.3727-0761.2	580761	CABLE FREIN A MAIN	24468130 , 5 22 150 , 5 22 450 , 9225541	
MERIVA / Vauxhall Meriva (02-)	1,3 CDTI		09.2003		24.0110-0291.1	410291	DISQUE DE FREIN	5 69 116 , 93176548	
	1,6		01.2006		24.0110-0291.1	410291	DISQUE DE FREIN	5 69 116 , 93176548	
	1,6 16V		05.2003		24.0110-0291.1	410291	DISQUE DE FREIN	5 69 116 , 93176548	
	1,7 DTI 16V		09.2002		24.0110-0291.1	410291	DISQUE DE FREIN	5 69 116 , 93176548	
	1,8 16V		09.2002		24.0110-0291.1	410291	DISQUE DE FREIN	5 69 116 , 93176548	
MOVANO (98-)	2,2 DTI 16V	ArD	09.2003		24.5251-0465.3	330822	FLEXIBLE FREIN	82 00 173 526 , 44 15 699 , 93182623	
	2,5 DTI	ArD	10.2003		24.5251-0465.3	330822	FLEXIBLE FREIN	82 00 173 526 , 44 15 699 , 93182623	

Nouvelles références disponibles - par applications

02/2007



					description	Références OE par référence ATE.		Références remplacées / divers
--	--	--	--	--	-------------	----------------------------------	--	--------------------------------







OPEL

MOVANO (98-)	3,0 DTI	ArD	10.2003		24.5251-0465.3	330822	FLEXIBLE FREIN	82 00 173 526 , 44 15 699 , 93182623	
SIGNUM / Vauxhall Signum (03-)	1,8	ArD	05.2003		11.9407-7002.2	220574	ETRIER A GRIFFE	93172298 , 55 42 268	
		ArG	05.2003		11.9407-7001.2	220573	ETRIER A GRIFFE	93172297 , 55 42 267	
	1,9 CDTI	ArD	04.2004		11.9407-7002.2	220574	ETRIER A GRIFFE	93172298 , 55 42 268	
		ArG	04.2004		11.9407-7001.2	220573	ETRIER A GRIFFE	93172297 , 55 42 267	
	2,0 DTI	ArD	05.2003		11.9407-7002.2	220574	ETRIER A GRIFFE	93172298 , 55 42 268	
		ArG	05.2003		11.9407-7001.2	220573	ETRIER A GRIFFE	93172297 , 55 42 267	
	2,2	ArG	03.2003		11.9407-7001.2	220573	ETRIER A GRIFFE	93172297 , 55 42 267	
		ArD	03.2003		11.9407-7002.2	220574	ETRIER A GRIFFE	93172298 , 55 42 268	
	2,2 DTI	ArG	05.2003		11.9407-7001.2	220573	ETRIER A GRIFFE	93172297 , 55 42 267	
		ArD	05.2003		11.9407-7002.2	220574	ETRIER A GRIFFE	93172298 , 55 42 268	
VECTRA C Caravan (F35) / Vauxhall MK II (03-)	1,6 16V	ArG	10.2003		11.9407-7001.2	220573	ETRIER A GRIFFE	93172297 , 55 42 267	
		ArD	10.2003		11.9407-7002.2	220574	ETRIER A GRIFFE	93172298 , 55 42 268	
	1,8	ArD	01.2006		11.9407-7002.2	220574	ETRIER A GRIFFE	93172298 , 55 42 268	
		ArD	10.2003		11.9407-7002.2	220574	ETRIER A GRIFFE	93172298 , 55 42 268	
		ArG	01.2006		11.9407-7001.2	220573	ETRIER A GRIFFE	93172297 , 55 42 267	
		ArG	10.2003		11.9407-7001.2	220573	ETRIER A GRIFFE	93172297 , 55 42 267	
	1,8 16V	ArG	10.2003		11.9407-7001.2	220573	ETRIER A GRIFFE	93172297 , 55 42 267	
		ArD	10.2003		11.9407-7002.2	220574	ETRIER A GRIFFE	93172298 , 55 42 268	

Nouvelles références disponibles - par applications

02/2007







					description	Références OE par référence ATE.		Références remplacées / divers
---	---	---	---	---	-------------	----------------------------------	---	--------------------------------

OPEL

VECTRA C Caravan (F35) / Vauxhall MK II (03-)	1,9 CDTI	ArG	10.2005		11.9407-7001.2	220573	ETRIER A GRIFFE	93172297 , 55 42 267	
		ArG	04.2004		11.9407-7001.2	220573	ETRIER A GRIFFE	93172297 , 55 42 267	
		ArD	10.2005		11.9407-7002.2	220574	ETRIER A GRIFFE	93172298 , 55 42 268	
		ArD	04.2004		11.9407-7002.2	220574	ETRIER A GRIFFE	93172298 , 55 42 268	
	2,0 DTI 16V	ArD	10.2003		11.9407-7002.2	220574	ETRIER A GRIFFE	93172298 , 55 42 268	
		ArG	10.2003		11.9407-7001.2	220573	ETRIER A GRIFFE	93172297 , 55 42 267	
	2,0 Turbo	ArD	10.2003		11.9407-7002.2	220574	ETRIER A GRIFFE	93172298 , 55 42 268	
		ArG	10.2003		11.9407-7001.2	220573	ETRIER A GRIFFE	93172297 , 55 42 267	
	2,2 16V	ArG	10.2003		11.9407-7001.2	220573	ETRIER A GRIFFE	93172297 , 55 42 267	
		ArD	10.2003		11.9407-7002.2	220574	ETRIER A GRIFFE	93172298 , 55 42 268	
	2,2 direct	ArD	10.2003		11.9407-7002.2	220574	ETRIER A GRIFFE	93172298 , 55 42 268	
		ArG	10.2003		11.9407-7001.2	220573	ETRIER A GRIFFE	93172297 , 55 42 267	
	2,2 DTI 16V	ArG	10.2003		11.9407-7001.2	220573	ETRIER A GRIFFE	93172297 , 55 42 267	
		ArD	10.2003		11.9407-7002.2	220574	ETRIER A GRIFFE	93172298 , 55 42 268	
	3,0 V6 CDTI	ArD	10.2003		11.9407-7002.2	220574	ETRIER A GRIFFE	93172298 , 55 42 268	
		ArG	10.2003		11.9407-7001.2	220573	ETRIER A GRIFFE	93172297 , 55 42 267	
		ArG	08.2005		11.9407-7001.2	220573	ETRIER A GRIFFE	93172297 , 55 42 267	
		ArD	08.2005		11.9407-7002.2	220574	ETRIER A GRIFFE	93172298 , 55 42 268	
	3,2 V6	ArG	10.2003		11.9407-7001.2	220573	ETRIER A GRIFFE	93172297 , 55 42 267	



				<p>description</p>	<p>Références OE par référence ATE.</p>	 <p>Références remplacées / divers</p>
---	---	--	---	--------------------	---	---







OPEL

VECTRA C Caravan (F35) / Vauxhall MK II (03-)	3,2 V6	ArD	10.2003		11.9407-7002.2	220574	ETRIER A GRIFFE	93172298 , 55 42 268	
---	--------	-----	---------	--	----------------	--------	-----------------	----------------------	--

Nouvelles références disponibles - par applications

02/2007



					description	Références OE par référence ATE.	 Références remplacées / divers
---	---	---	---	---	-------------	----------------------------------	--

PEUGEOT

1007 (05-)	1,4		04.2005		03.0520-8520.3	698520	ATE TOPKIT	4242 11 , 4242 10	
	1,4 16V		10.2005		03.0520-8520.3	698520	ATE TOPKIT	4242 11 , 4242 10	
	1,4 HDi		04.2005		03.0520-8520.3	698520	ATE TOPKIT	4242 11 , 4242 10	
106 (91-96)	1,3 Rallye	AvD		04.1996	11.3481-9834.2	220562	ETRIER A GRIFFE	4400 E5 , 4400 G8 , 4400 J5	11.3481-0168.2
	1,4	AvD		04.1996	11.3481-9834.2	220562	ETRIER A GRIFFE	4400 E5 , 4400 G8 , 4400 J5	11.3481-0168.2
	1,4 D	AvD		04.1996	11.3481-9834.2	220562	ETRIER A GRIFFE	4400 E5 , 4400 G8 , 4400 J5	11.3481-0168.2
	1,5 D	AvD		04.1996	11.3481-9834.2	220562	ETRIER A GRIFFE	4400 E5 , 4400 G8 , 4400 J5	11.3481-0168.2
	1,6	AvD		04.1996	11.3481-9834.2	220562	ETRIER A GRIFFE	4400 E5 , 4400 G8 , 4400 J5	11.3481-0168.2
106 (96-04)		AvD	05.1996	03.2004	11.3481-9834.2	220562	ETRIER A GRIFFE	4400 E5 , 4400 G8 , 4400 J5	11.3481-0168.2
	1,6 16V	AvD	05.1996	03.2004	11.3481-9834.2	220562	ETRIER A GRIFFE	4400 E5 , 4400 G8 , 4400 J5	11.3481-0168.2
107 (05-)	1		06.2005		24.3217-1719.3	020482	CYLINDRE DE ROUE	47550-09040 , 4402 F0	
	1,4 HDi		06.2005		24.3217-1719.3	020482	CYLINDRE DE ROUE	47550-09040 , 4402 F0	
205 (91-98)	1,7 TD	AvD	06.1993	09.1998	11.3481-9834.2	220562	ETRIER A GRIFFE	4400 E5 , 4400 G8 , 4400 J5	11.3481-0168.2
	1,9 GTI	AvD	09.1990	09.1998	11.3481-9834.2	220562	ETRIER A GRIFFE	4400 E5 , 4400 G8 , 4400 J5	11.3481-0168.2
		AvD	09.1990	10.1994	11.3481-9834.2	220562	ETRIER A GRIFFE	4400 E5 , 4400 G8 , 4400 J5	11.3481-0168.2
306 Décapotable (94-03)	1,6	AvD	05.2000	10.2000	11.3481-9834.2	220562	ETRIER A GRIFFE	4400 E5 , 4400 G8 , 4400 J5	11.3481-0168.2
		AvD	04.1996		11.3481-9834.2	220562	ETRIER A GRIFFE	4400 E5 , 4400 G8 , 4400 J5	11.3481-0168.2
	1,8	AvD	03.1994		11.3481-9834.2	220562	ETRIER A GRIFFE	4400 E5 , 4400 G8 , 4400 J5	11.3481-0168.2
		AvD	05.2000	10.2000	11.3481-9834.2	220562	ETRIER A GRIFFE	4400 E5 , 4400 G8 , 4400 J5	11.3481-0168.2

Nouvelles références disponibles - par applications

02/2007



					description	Références OE par référence ATE.		Références remplacées / divers
--	--	--	--	--	-------------	----------------------------------	--	--------------------------------

PEUGEOT

306 Break (97-02)	1,4	AvD	03.1997	03.2002	11.3481-9834.2	220562	ETRIER A GRIFFE	4400 E5 , 4400 G8 , 4400 J5	11.3481-0168.2
	1,6	AvD	10.2000	03.2002	11.3481-9834.2	220562	ETRIER A GRIFFE	4400 E5 , 4400 G8 , 4400 J5	11.3481-0168.2
		AvD	03.1997	10.2000	11.3481-9834.2	220562	ETRIER A GRIFFE	4400 E5 , 4400 G8 , 4400 J5	11.3481-0168.2
	1,8 D	AvD	03.1997	03.2002	11.3481-9834.2	220562	ETRIER A GRIFFE	4400 E5 , 4400 G8 , 4400 J5	11.3481-0168.2
	1,9 D	AvD	03.1997	03.2002	11.3481-9834.2	220562	ETRIER A GRIFFE	4400 E5 , 4400 G8 , 4400 J5	11.3481-0168.2
306 Berline (3/5-portes) (93-01)	1,1	AvD	03.1994	04.1997	11.3481-9834.2	220562	ETRIER A GRIFFE	4400 E5 , 4400 G8 , 4400 J5	11.3481-0168.2
	1,4	AvD	03.1993		11.3481-9834.2	220562	ETRIER A GRIFFE	4400 E5 , 4400 G8 , 4400 J5	11.3481-0168.2
	1,4 Entreprise	AvD	03.1993	05.2001	11.3481-9834.2	220562	ETRIER A GRIFFE	4400 E5 , 4400 G8 , 4400 J5	11.3481-0168.2
	1,6	AvD	03.1993		11.3481-9834.2	220562	ETRIER A GRIFFE	4400 E5 , 4400 G8 , 4400 J5	11.3481-0168.2
		AvD	10.2000	05.2001	11.3481-9834.2	220562	ETRIER A GRIFFE	4400 E5 , 4400 G8 , 4400 J5	11.3481-0168.2
		AvD		10.2000	11.3481-9834.2	220562	ETRIER A GRIFFE	4400 E5 , 4400 G8 , 4400 J5	11.3481-0168.2
	1,8	AvD	03.1993		11.3481-9834.2	220562	ETRIER A GRIFFE	4400 E5 , 4400 G8 , 4400 J5	11.3481-0168.2
		AvD		05.2001	11.3481-9834.2	220562	ETRIER A GRIFFE	4400 E5 , 4400 G8 , 4400 J5	11.3481-0168.2
	1,8 D	AvD	03.1993	05.2001	11.3481-9834.2	220562	ETRIER A GRIFFE	4400 E5 , 4400 G8 , 4400 J5	11.3481-0168.2
	1,9 D	AvD	09.1998		11.3481-9834.2	220562	ETRIER A GRIFFE	4400 E5 , 4400 G8 , 4400 J5	11.3481-0168.2
		AvD		05.2001	11.3481-9834.2	220562	ETRIER A GRIFFE	4400 E5 , 4400 G8 , 4400 J5	11.3481-0168.2
		AvD	03.1998	05.2001	11.3481-9834.2	220562	ETRIER A GRIFFE	4400 E5 , 4400 G8 , 4400 J5	11.3481-0168.2
		AvD	05.1993	05.2001	11.3481-9834.2	220562	ETRIER A GRIFFE	4400 E5 , 4400 G8 , 4400 J5	11.3481-0168.2
		AvD	06.1994	05.2001	11.3481-9834.2	220562	ETRIER A GRIFFE	4400 E5 , 4400 G8 , 4400 J5	11.3481-0168.2

Nouvelles références disponibles - par applications

02/2007



					description	Références OE par référence ATE.	Références remplacées / divers
--	--	--	--	--	-------------	----------------------------------	--------------------------------

PEUGEOT

306 Berline (3/5-portes) (93-01)	1,9 D Entreprise	AvD	09.1998	10.2000	11.3481-9834.2	220562	ETRIER A GRIFFE	4400 E5 , 4400 G8 , 4400 J5	11.3481-0168.2
	1,9 TD	AvD	10.1993	05.2001	11.3481-9834.2	220562	ETRIER A GRIFFE	4400 E5 , 4400 G8 , 4400 J5	11.3481-0168.2
	2,0 S16	AvG	07.1994	04.1997	24.3571-1729.5	240317	ETRIER A GRIFFE	4401 A4	
		AvD	03.1996	05.2001	24.3571-1730.5	240318	ETRIER A GRIFFE	4401 A5	
		AvD	07.1994	04.1997	24.3571-1730.5	240318	ETRIER A GRIFFE	4401 A5	
		AvG	03.1996	05.2001	24.3571-1729.5	240317	ETRIER A GRIFFE	4401 A4	
		AvG	03.1994	04.1997	24.3571-1729.5	240317	ETRIER A GRIFFE	4401 A4	
		AvD	03.1994	04.1997	24.3571-1730.5	240318	ETRIER A GRIFFE	4401 A5	
306 Berline (4-portes) (94-01)	1,4	AvD	10.1994		11.3481-9834.2	220562	ETRIER A GRIFFE	4400 E5 , 4400 G8 , 4400 J5	11.3481-0168.2
	1,6	AvD	10.1994		11.3481-9834.2	220562	ETRIER A GRIFFE	4400 E5 , 4400 G8 , 4400 J5	11.3481-0168.2
		AvD		10.2000	11.3481-9834.2	220562	ETRIER A GRIFFE	4400 E5 , 4400 G8 , 4400 J5	11.3481-0168.2
		AvD	10.2000	05.2001	11.3481-9834.2	220562	ETRIER A GRIFFE	4400 E5 , 4400 G8 , 4400 J5	11.3481-0168.2
	1,8	AvD		05.2001	11.3481-9834.2	220562	ETRIER A GRIFFE	4400 E5 , 4400 G8 , 4400 J5	11.3481-0168.2
		AvD	04.1994		11.3481-9834.2	220562	ETRIER A GRIFFE	4400 E5 , 4400 G8 , 4400 J5	11.3481-0168.2
	1,9 D	AvD	10.1994	05.2001	11.3481-9834.2	220562	ETRIER A GRIFFE	4400 E5 , 4400 G8 , 4400 J5	11.3481-0168.2
		AvD	09.1998		11.3481-9834.2	220562	ETRIER A GRIFFE	4400 E5 , 4400 G8 , 4400 J5	11.3481-0168.2
		AvD		05.2001	11.3481-9834.2	220562	ETRIER A GRIFFE	4400 E5 , 4400 G8 , 4400 J5	11.3481-0168.2
	1,9 TD	AvD	10.1994	05.2001	11.3481-9834.2	220562	ETRIER A GRIFFE	4400 E5 , 4400 G8 , 4400 J5	11.3481-0168.2
807 (02-)	2,0 16V	AvD	06.2002		24.3601-1712.7	220608	ETRIER A GRIFFE	4401 C7 , 9949539	

Nouvelles références disponibles - par applications

02/2007



					description	Références OE par référence ATE.		Références remplacées / divers
--	--	--	--	--	-------------	----------------------------------	--	--------------------------------

PEUGEOT

807 (02-)	2,0 16V	AvD	09.2005		24.3601-1712.7	220608	ETRIER A GRIFFE	4401 C7 , 9949539	
		AvG	06.2002		24.3601-1711.7	220607	ETRIER A GRIFFE	4401 C6 , 9949538	
		AvG	09.2005		24.3601-1711.7	220607	ETRIER A GRIFFE	4401 C6 , 9949538	
	2,0 HDi	AvG	06.2002		24.3601-1711.7	220607	ETRIER A GRIFFE	4401 C6 , 9949538	
		AvG	06.2006		24.3601-1711.7	220607	ETRIER A GRIFFE	4401 C6 , 9949538	
		AvD	06.2006		24.3601-1712.7	220608	ETRIER A GRIFFE	4401 C7 , 9949539	
		AvD	06.2002		24.3601-1712.7	220608	ETRIER A GRIFFE	4401 C7 , 9949539	
	2,2 16V	AvG	06.2002		24.3601-1711.7	220607	ETRIER A GRIFFE	4401 C6 , 9949538	
		AvD	06.2002		24.3601-1712.7	220608	ETRIER A GRIFFE	4401 C7 , 9949539	
	2,2 HDi	AvD	06.2002		24.3601-1712.7	220608	ETRIER A GRIFFE	4401 C7 , 9949539	
		AvG	06.2002		24.3601-1711.7	220607	ETRIER A GRIFFE	4401 C6 , 9949538	
BOXER Autobus/car (94-02)	1,9 TD (10/14)		02.1994	03.2002	24.3728-0337.2	590337	CABLE D'EMBAYAGE	2150 J4 , 2150 T6 , 1312633080 , 1318450080	
			08.1994	03.2002	24.3728-0337.2	590337	CABLE D'EMBAYAGE	2150 J4 , 2150 T6 , 1312633080 , 1318450080	
	2,0 i (10/14/18)		02.1994	03.2002	24.3728-0335.2	590335	CABLE D'EMBAYAGE	2150 Y5 , 2150 Z3 , 2150 AV , 1335052080	
	2,5 D (14/18)		08.1994	03.2002	24.3728-0335.2	590335	CABLE D'EMBAYAGE	2150 Y5 , 2150 Z3 , 2150 AV , 1335052080	
	2,8 HDi (14/18)		11.2000	03.2002	24.3728-0335.2	590335	CABLE D'EMBAYAGE	2150 Y5 , 2150 Z3 , 2150 AV , 1335052080	
BOXER Fourgonnette (94-02)	1,9 TD (10/14)		07.1999	03.2002	24.3728-0337.2	590337	CABLE D'EMBAYAGE	2150 J4 , 2150 T6 , 1312633080 , 1318450080	



					description	Références OE par référence ATE.		Références remplacées / divers
--	--	--	--	--	-------------	----------------------------------	--	--------------------------------

PEUGEOT

BOXER Fourgonnette (94-02)	1,9 TD (10/14)		02.1994	03.2002	24.3728-0337.2	590337	CABLE D'EMBAYAGE	2150 J4 , 2150 T6 , 1312633080 , 1318450080	
	2,0 i (10/14/18)		02.1994	03.2002	24.3728-0335.2	590335	CABLE D'EMBAYAGE	2150 Y5 , 2150 Z3 , 2150 AV , 1335052080	
	2,5 D (14/18)		02.1994	03.2002	24.3728-0335.2	590335	CABLE D'EMBAYAGE	2150 Y5 , 2150 Z3 , 2150 AV , 1335052080	
	2,8 HDi (14/18)		11.2000	03.2002	24.3728-0335.2	590335	CABLE D'EMBAYAGE	2150 Y5 , 2150 Z3 , 2150 AV , 1335052080	
BOXER Camion-plateau/Châssis (94-02)	1,9 TD (10/14)		07.1996	03.2002	24.3728-0337.2	590337	CABLE D'EMBAYAGE	2150 J4 , 2150 T6 , 1312633080 , 1318450080	
			12.1998	03.2002	24.3728-0337.2	590337	CABLE D'EMBAYAGE	2150 J4 , 2150 T6 , 1312633080 , 1318450080	
	2,0 i (10/14/18)		06.1994	03.2002	24.3728-0335.2	590335	CABLE D'EMBAYAGE	2150 Y5 , 2150 Z3 , 2150 AV , 1335052080	
			06.1994	03.2002	24.3728-0337.2	590337	CABLE D'EMBAYAGE	2150 J4 , 2150 T6 , 1312633080 , 1318450080	
	2,5 D (14/18)		02.1994	03.2002	24.3728-0337.2	590337	CABLE D'EMBAYAGE	2150 J4 , 2150 T6 , 1312633080 , 1318450080	
			02.1994	03.2002	24.3728-0335.2	590335	CABLE D'EMBAYAGE	2150 Y5 , 2150 Z3 , 2150 AV , 1335052080	
	2,8 HDi (14/18)		11.2000	03.2002	24.3728-0335.2	590335	CABLE D'EMBAYAGE	2150 Y5 , 2150 Z3 , 2150 AV , 1335052080	
EXPERT Fourgonnette (95-)	1,6	AvG			24.3601-1711.7	220607	ETRIER A GRIFFE	4401 C6 , 9949538	
		AvD			24.3601-1712.7	220608	ETRIER A GRIFFE	4401 C7 , 9949539	
	1,8	AvD			24.3601-1712.7	220608	ETRIER A GRIFFE	4401 C7 , 9949539	

Nouvelles références disponibles - par applications

02/2007









					description	Références OE par référence ATE.		Références remplacées / divers
--	--	--	--	--	-------------	----------------------------------	--	--------------------------------

PEUGEOT

EXPERT Fourgonnette (95-)	1,8	AvG			24.3601-1711.7	220607	ETRIER A GRIFFE	4401 C6 , 9949538	
	1,9 D	AvD			24.3601-1712.7	220608	ETRIER A GRIFFE	4401 C7 , 9949539	
		AvG			24.3601-1711.7	220607	ETRIER A GRIFFE	4401 C6 , 9949538	
	1,9 TD	AvD			24.3601-1712.7	220608	ETRIER A GRIFFE	4401 C7 , 9949539	
		AvG			24.3601-1711.7	220607	ETRIER A GRIFFE	4401 C6 , 9949538	
	2,0 16V	AvD			24.3601-1712.7	220608	ETRIER A GRIFFE	4401 C7 , 9949539	
		AvG			24.3601-1711.7	220607	ETRIER A GRIFFE	4401 C6 , 9949538	
	2,0 HDi	AvD			24.3601-1712.7	220608	ETRIER A GRIFFE	4401 C7 , 9949539	
		AvG			24.3601-1711.7	220607	ETRIER A GRIFFE	4401 C6 , 9949538	
EXPERT Break (95-)	1,6	AvD			24.3601-1712.7	220608	ETRIER A GRIFFE	4401 C7 , 9949539	
		AvG			24.3601-1711.7	220607	ETRIER A GRIFFE	4401 C6 , 9949538	
	1,8	AvG			24.3601-1711.7	220607	ETRIER A GRIFFE	4401 C6 , 9949538	
		AvD			24.3601-1712.7	220608	ETRIER A GRIFFE	4401 C7 , 9949539	
	1,9 D	AvG			24.3601-1711.7	220607	ETRIER A GRIFFE	4401 C6 , 9949538	
		AvD			24.3601-1712.7	220608	ETRIER A GRIFFE	4401 C7 , 9949539	
	1,9 TD	AvG			24.3601-1711.7	220607	ETRIER A GRIFFE	4401 C6 , 9949538	
		AvD			24.3601-1712.7	220608	ETRIER A GRIFFE	4401 C7 , 9949539	
	2,0 16V	AvD			24.3601-1712.7	220608	ETRIER A GRIFFE	4401 C7 , 9949539	
		AvG			24.3601-1711.7	220607	ETRIER A GRIFFE	4401 C6 , 9949538	



					description	Références OE par référence ATE.	 Références remplacées / divers
---	---	---	---	---	-------------	--	---

PEUGEOT

Modèle	Motorisation	AvD	AvG	ATE	ATE	Description	Références OE par référence ATE.	Références remplacées / divers
EXPERT Break (95-)	2,0 HDi	AvD		24.3601-1712.7	220608	ETRIER A GRIFFE	4401 C7 , 9949539	
		AvG		24.3601-1711.7	220607	ETRIER A GRIFFE	4401 C6 , 9949538	
EXPERT Camion-plateau/Châssis (95-)	1,6	AvG		24.3601-1711.7	220607	ETRIER A GRIFFE	4401 C6 , 9949538	
		AvD		24.3601-1712.7	220608	ETRIER A GRIFFE	4401 C7 , 9949539	
	1,9 D	AvD		24.3601-1712.7	220608	ETRIER A GRIFFE	4401 C7 , 9949539	
		AvG		24.3601-1711.7	220607	ETRIER A GRIFFE	4401 C6 , 9949538	
	1,9 TD	AvG		24.3601-1711.7	220607	ETRIER A GRIFFE	4401 C6 , 9949538	
		AvD		24.3601-1712.7	220608	ETRIER A GRIFFE	4401 C7 , 9949539	

Nouvelles références disponibles - par applications

02/2007



					description	Références OE par référence ATE.		Références remplacées / divers
--	--	--	--	--	-------------	----------------------------------	--	--------------------------------

PORSCHE

911 (964) (88-93)	3,3 TURBO		08.1990	09.1993	03.0137-3002.2	653002	JEU DE MACHOIRE	
	3,3 TURBO S		06.1991	12.1992	03.0137-3002.2	653002	JEU DE MACHOIRE	
	3,6 CARRERA		07.1989	09.1993	03.0137-3002.2	653002	JEU DE MACHOIRE	
	3,6 CARRERA 4		12.1988	09.1993	03.0137-3002.2	653002	JEU DE MACHOIRE	
	3,6 CARRERA RS		06.1991	09.1993	03.0137-3002.2	653002	JEU DE MACHOIRE	
	3,6 TURBO		01.1993	09.1993	03.0137-3002.2	653002	JEU DE MACHOIRE	
911 (996) (97-)	3,4 CARRERA		01.2003		03.0137-3002.2	653002	JEU DE MACHOIRE	
	3,4 CARRERA 4		01.2003		03.0137-3002.2	653002	JEU DE MACHOIRE	
	3,6 CARRERA		01.2003		03.0137-3002.2	653002	JEU DE MACHOIRE	
	3,6 CARRERA 4		01.2003		03.0137-3002.2	653002	JEU DE MACHOIRE	
	3,6 GT2		01.2003		03.0137-3002.2	653002	JEU DE MACHOIRE	
	3,6 GT3		01.2003		03.0137-3002.2	653002	JEU DE MACHOIRE	
	3,6 TURBO 4		01.2003		03.0137-3002.2	653002	JEU DE MACHOIRE	
911 DECAPOTABLE (964) (89-94)	3,6 CARRERA		07.1989	05.1994	03.0137-3002.2	653002	JEU DE MACHOIRE	
	3,6 CARRERA 4		05.1989	05.1994	03.0137-3002.2	653002	JEU DE MACHOIRE	
911 DECAPOTABLE (996) (98-)	3,4 CARRERA		01.2003		03.0137-3002.2	653002	JEU DE MACHOIRE	
	3,4 CARRERA 4		01.2003		03.0137-3002.2	653002	JEU DE MACHOIRE	
	3,6 CARRERA		01.2003		03.0137-3002.2	653002	JEU DE MACHOIRE	
	3,6 CARRERA 4		01.2003		03.0137-3002.2	653002	JEU DE MACHOIRE	
	3,6 TURBO 4		10.2003		03.0137-3002.2	653002	JEU DE MACHOIRE	
911 DECAPOTABLE (997) (05-)	3,6 CARRERA		04.2005		03.0137-3002.2	653002	JEU DE MACHOIRE	

Nouvelles références disponibles - par applications

02/2007









					description	Références OE par référence ATE.		Références remplacées / divers
--	--	--	--	--	-------------	----------------------------------	--	--------------------------------

PORSCHE

911 DECAPOTABLE (997) (05-)	3,6 CARRERA 4		04.2005		03.0137-3002.2	653002	JEU DE MACHOIRE		
	3,8 CARRERA 4S		04.2005		03.0137-3002.2	653002	JEU DE MACHOIRE		
	3,8 CARRERA S		04.2005		03.0137-3002.2	653002	JEU DE MACHOIRE		
911 COUPE (997) (04-)	3,6 CARRERA		07.2004		03.0137-3002.2	653002	JEU DE MACHOIRE		
	3,6 CARRERA 4		07.2004		03.0137-3002.2	653002	JEU DE MACHOIRE		
	3,8 CARRERA 4S		07.2004		03.0137-3002.2	653002	JEU DE MACHOIRE		
	3,8 CARRERA S		07.2004		03.0137-3002.2	653002	JEU DE MACHOIRE		
911 TARGA (996) (01-)	3,6		01.2003		03.0137-3002.2	653002	JEU DE MACHOIRE		
924S (86-88)	2,5 S		09.1985	07.1987	03.0137-3002.2	653002	JEU DE MACHOIRE		
			08.1987	12.1988	03.0137-3002.2	653002	JEU DE MACHOIRE		
928 (77-95)	4,5		09.1977	08.1982	03.0137-3002.2	653002	JEU DE MACHOIRE		
	4,7 S		09.1979	12.1983	03.0137-3002.2	653002	JEU DE MACHOIRE		
			08.1983	12.1986	03.0137-3002.2	653002	JEU DE MACHOIRE		
			09.1985	12.1986	03.0137-3002.2	653002	JEU DE MACHOIRE		
	5,0 GT		01.1989	07.1991	03.0137-3002.2	653002	JEU DE MACHOIRE		
	5,0 S4		08.1986	07.1991	03.0137-3002.2	653002	JEU DE MACHOIRE		
	5,4 GTS		08.1991	11.1995	03.0137-3002.2	653002	JEU DE MACHOIRE		
BOXSTER (986) (96-04)	3,2 S		08.1999	06.2002	24.0124-0194.1	424194	DISQUE DE FREIN	987 352 403 00 , 986 352 403 01	
			07.2002	12.2004	24.0124-0194.1	424194	DISQUE DE FREIN	987 352 403 00 , 986 352 403 01	



		 		description	Références OE par référence ATE.	 Références remplacées / divers
---	---	---	---	-------------	--	---

PORSCHE

BOXSTER (986) (96-04)	3,2 S		01.2004	12.2004	24.0124-0194.1	424194	DISQUE DE FREIN	987 352 403 00 , 986 352 403 01	
			01.2004	12.2004	03.0137-3002.2	653002	JEU DE MACHOIRE		
			07.2002	12.2004	03.0137-3002.2	653002	JEU DE MACHOIRE		
BOXSTER (987) (05-)	2,7 24V		11.2004		03.0137-3002.2	653002	JEU DE MACHOIRE		
	3,2 24V S		11.2004		24.0124-0194.1	424194	DISQUE DE FREIN	987 352 403 00 , 986 352 403 01	
			11.2004		03.0137-3002.2	653002	JEU DE MACHOIRE		
CAYMAN (987C) (05-)	3,4 S		11.2005		24.0124-0194.1	424194	DISQUE DE FREIN	987 352 403 00 , 986 352 403 01	
			11.2005		03.0137-3002.2	653002	JEU DE MACHOIRE		



					description	Références OE par référence ATE.		Références remplacées / divers
--	--	--	--	--	-------------	----------------------------------	--	--------------------------------

RENAULT

CLIO I Kasten (S 57_) (91-98)	1,1	AvG	01.1991	04.1992	24.3451-1501.5	240263	ETRIER A GRIFFE	77 01 202 206	24.3451-1501.7
		AvD	01.1991	04.1992	24.3451-1502.5	240264	ETRIER A GRIFFE	77 01 202 207	24.3451-1502.7
EXPRESS/RAPID (F40) (85-98)	1,0 (F400)	AvD	01.1986	05.1988	24.3451-1502.5	240264	ETRIER A GRIFFE	77 01 202 207	24.3451-1502.7
		AvG	01.1986	05.1988	24.3451-1501.5	240263	ETRIER A GRIFFE	77 01 202 206	24.3451-1501.7
	1,1 (F401)	AvG	07.1985	05.1988	24.3451-1501.5	240263	ETRIER A GRIFFE	77 01 202 206	24.3451-1501.7
		AvD	07.1985	05.1988	24.3451-1502.5	240264	ETRIER A GRIFFE	77 01 202 207	24.3451-1502.7
	1,1 (F40H)	AvG	06.1987	05.1988	24.3451-1501.5	240263	ETRIER A GRIFFE	77 01 202 206	24.3451-1501.7
		AvD	06.1987	05.1988	24.3451-1502.5	240264	ETRIER A GRIFFE	77 01 202 207	24.3451-1502.7
	1,6 (F404)	AvG	01.1986	05.1986	24.3451-1501.5	240263	ETRIER A GRIFFE	77 01 202 206	24.3451-1501.7
		AvD	01.1986	05.1986	24.3451-1502.5	240264	ETRIER A GRIFFE	77 01 202 207	24.3451-1502.7
GRAND SCENIC (04-)	1,5 dCi		10.2005		13.0460-7222.2	607222	PLAQUETTES DE FREIN	77 01 209 101	cf. Photo
	1,6		10.2005		13.0460-7222.2	607222	PLAQUETTES DE FREIN	77 01 209 101	cf. Photo
	1,9 dCi		10.2005		13.0460-7222.2	607222	PLAQUETTES DE FREIN	77 01 209 101	cf. Photo
	2,0 16V		10.2005		13.0460-7222.2	607222	PLAQUETTES DE FREIN	77 01 209 101	cf. Photo
	2,0 16V Turbo		10.2005		13.0460-7222.2	607222	PLAQUETTES DE FREIN	77 01 209 101	cf. Photo
MASTER II Autobus/car (JD/ND) (98-)	1,9 dCi 80	ArD	12.2003		24.5251-0465.3	330822	FLEXIBLE FREIN	82 00 173 526 , 44 15 699 , 93182623	
	1,9 dTi	ArD	12.2003		24.5251-0465.3	330822	FLEXIBLE FREIN	82 00 173 526 , 44 15 699 , 93182623	
	2,2 dCi 90	ArD	12.2003		24.5251-0465.3	330822	FLEXIBLE FREIN	82 00 173 526 , 44 15 699 , 93182623	

Nouvelles références disponibles - par applications

02/2007



					description	Références OE par référence ATE.		Références remplacées / divers
--	--	--	--	--	-------------	----------------------------------	--	--------------------------------







RENAULT

MASTER II Autobus/car (JD/ND) (98-)	2,5 dCi 100	ArD	12.2003		24.5251-0465.3	330822	FLEXIBLE FREIN	82 00 173 526 , 44 15 699 , 93182623	
	2,5 dCi 120	ArD	12.2003		24.5251-0465.3	330822	FLEXIBLE FREIN	82 00 173 526 , 44 15 699 , 93182623	
	3,0 dCi 140	ArD	12.2003		24.5251-0465.3	330822	FLEXIBLE FREIN	82 00 173 526 , 44 15 699 , 93182623	
MASTER II Fourgonnette (FC) (98-)	1,9 dCi 80	ArD	12.2003		24.5251-0465.3	330822	FLEXIBLE FREIN	82 00 173 526 , 44 15 699 , 93182623	
	1,9 dTi	ArD	12.2003		24.5251-0465.3	330822	FLEXIBLE FREIN	82 00 173 526 , 44 15 699 , 93182623	
	2,2 dCi 90	ArD	12.2003		24.5251-0465.3	330822	FLEXIBLE FREIN	82 00 173 526 , 44 15 699 , 93182623	
	2,5 dCi 100	ArD	12.2003		24.5251-0465.3	330822	FLEXIBLE FREIN	82 00 173 526 , 44 15 699 , 93182623	
	2,5 dCi 120	ArD	12.2003		24.5251-0465.3	330822	FLEXIBLE FREIN	82 00 173 526 , 44 15 699 , 93182623	
	3,0 dCi 120	ArD	06.2005		24.5251-0465.3	330822	FLEXIBLE FREIN	82 00 173 526 , 44 15 699 , 93182623	
	3,0 dCi 140	ArD	12.2003		24.5251-0465.3	330822	FLEXIBLE FREIN	82 00 173 526 , 44 15 699 , 93182623	
	3,0 dCi 160	ArD	06.2005		24.5251-0465.3	330822	FLEXIBLE FREIN	82 00 173 526 , 44 15 699 , 93182623	
MASTER II Camion-plateau/Châssis (ED/HD/UD) (98-)	2,2 dCi 90	ArD	12.2003		24.5251-0465.3	330822	FLEXIBLE FREIN	82 00 173 526 , 44 15 699 , 93182623	
	2,5 dCi 100	ArD	12.2003		24.5251-0465.3	330822	FLEXIBLE FREIN	82 00 173 526 , 44 15 699 , 93182623	

Nouvelles références disponibles - par applications

02/2007



					description	Références OE par référence ATE.	 Références remplacées / divers
---	---	---	---	---	-------------	----------------------------------	--

RENAULT

MASTER II Camion-plateau/Châssis (ED/HD/UD) (98-)	2,5 dCi 120	ArD	12.2003		24.5251-0465.3	330822	FLEXIBLE FREIN	82 00 173 526 , 44 15 699 , 93182623	
	3,0 dCi 120	ArD	06.2005		24.5251-0465.3	330822	FLEXIBLE FREIN	82 00 173 526 , 44 15 699 , 93182623	
	3,0 dCi 140	ArD	11.2003		24.5251-0465.3	330822	FLEXIBLE FREIN	82 00 173 526 , 44 15 699 , 93182623	
	3,0 dCi 160	ArD	06.2005		24.5251-0465.3	330822	FLEXIBLE FREIN	82 00 173 526 , 44 15 699 , 93182623	
MEGANE I (BA_/SA_) Limousine 3/5-t?rig (96-02)	1,4 e	AV	01.1996	12.2002	24.0713-1109.1	360145	CAPTEUR DE ROUE	77 00 429 113	
	1,6 e	AV	01.1996	03.1999	24.0713-1109.1	360145	CAPTEUR DE ROUE	77 00 429 113	
	1,6 i	AV	01.1996	03.1999	24.0713-1109.1	360145	CAPTEUR DE ROUE	77 00 429 113	
	1,9 D (9)	AV	01.1996	12.2002	24.0713-1109.1	360145	CAPTEUR DE ROUE	77 00 429 113	
	1,9 D (A)	AV	01.1996	12.2002	24.0713-1109.1	360145	CAPTEUR DE ROUE	77 00 429 113	
	1,9 D (R)	AV	06.1998	12.2002	24.0713-1109.1	360145	CAPTEUR DE ROUE	77 00 429 113	
	1,9 D (U)	AV	01.1996	12.2002	24.0713-1109.1	360145	CAPTEUR DE ROUE	77 00 429 113	
	1,9 dT	AV	01.1996	12.2002	24.0713-1109.1	360145	CAPTEUR DE ROUE	77 00 429 113	
	1,9 dTi	AV	03.1997	02.2001	24.0713-1109.1	360145	CAPTEUR DE ROUE	77 00 429 113	
	1,9 dTi (1U)	AV	02.2001	12.2002	24.0713-1109.1	360145	CAPTEUR DE ROUE	77 00 429 113	
	2,0 i	AV	01.1996	12.2002	24.0713-1109.1	360145	CAPTEUR DE ROUE	77 00 429 113	
MEGANE I (LA_) CLASSIC (96-02)	1,4 16V (OD)	AV	03.1999	12.2002	24.0713-1109.1	360145	CAPTEUR DE ROUE	77 00 429 113	
	1,4 16V (OW)	AV	06.1998	12.2002	24.0713-1109.1	360145	CAPTEUR DE ROUE	77 00 429 113	
	1,4 e (OE)	AV	09.1996	12.2002	24.0713-1109.1	360145	CAPTEUR DE ROUE	77 00 429 113	

Nouvelles références disponibles - par applications

02/2007



--	--	--	--	--	--	--	--	--	--

RENAULT

MEGANE I (LA_) CLASSIC (96-02)									
	1,4 e (OV)	AV	04.1998	12.2002	24.0713-1109.1	360145	CAPTEUR DE ROUE	77 00 429 113	
	1,6 16V (11)	ArG	09.1999	12.2002	24.0721-1171.1	360146	CAPTEUR DE ROUE	77 00 832 776	
	1,6 16V (1C)	ArG	09.1999	12.2002	24.0721-1171.1	360146	CAPTEUR DE ROUE	77 00 832 776	
	1,6 16V (O4)	ArG	04.1998	12.2002	24.0721-1171.1	360146	CAPTEUR DE ROUE	77 00 832 776	
		AV	04.1998	12.2002	24.0713-1109.1	360145	CAPTEUR DE ROUE	77 00 429 113	
		AV	09.2000	12.2002	24.0713-1109.1	360145	CAPTEUR DE ROUE	77 00 429 113	
	1,6 16V (OB)	AV	09.1998	12.2002	24.0713-1109.1	360145	CAPTEUR DE ROUE	77 00 429 113	
	1,6 e (OF)	ArG	09.1996	03.1999	24.0721-1171.1	360146	CAPTEUR DE ROUE	77 00 832 776	
		AV	09.1996	03.1999	24.0713-1109.1	360145	CAPTEUR DE ROUE	77 00 429 113	
	1,6 i	ArG	09.1996	03.1999	24.0721-1171.1	360146	CAPTEUR DE ROUE	77 00 832 776	
		AV	09.1996	03.1999	24.0713-1109.1	360145	CAPTEUR DE ROUE	77 00 429 113	
	1,9 D	AV	09.1996	12.2002	24.0713-1109.1	360145	CAPTEUR DE ROUE	77 00 429 113	
	1,9 D (OA)	ArG	09.1996	12.2002	24.0721-1171.1	360146	CAPTEUR DE ROUE	77 00 832 776	
	1,9 D (OR)	AV	09.2000	12.2002	24.0713-1109.1	360145	CAPTEUR DE ROUE	77 00 429 113	
		ArG	09.1998	08.2000	24.0721-1171.1	360146	CAPTEUR DE ROUE	77 00 832 776	
	1,9 D (OU)	ArG	09.1996	12.2002	24.0721-1171.1	360146	CAPTEUR DE ROUE	77 00 832 776	
	1,9 dCi	AV	09.1998	12.2002	24.0713-1109.1	360145	CAPTEUR DE ROUE	77 00 429 113	
	1,9 dT	AV	09.1996	12.2002	24.0713-1109.1	360145	CAPTEUR DE ROUE	77 00 429 113	
	1,9 dTi (1U)	AV	02.2001	12.2002	24.0713-1109.1	360145	CAPTEUR DE ROUE	77 00 429 113	

Nouvelles références disponibles - par applications

02/2007



						description	Références OE par référence ATE.		Références remplacées / divers
--	--	--	--	--	--	-------------	----------------------------------	--	--------------------------------

RENAULT

MEGANE I (LA_) CLASSIC (96-02)	1,9 dTi (O8)	AV	03.1997	02.2001	24.0713-1109.1	360145	CAPTEUR DE ROUE	77 00 429 113	
	1,9 dTi (ON)	AV	09.2000	02.2001	24.0713-1109.1	360145	CAPTEUR DE ROUE	77 00 429 113	
		ArG	03.1997	08.2000	24.0721-1171.1	360146	CAPTEUR DE ROUE	77 00 832 776	
	2,0 i (OG)	ArG	09.1996	12.2002	24.0721-1171.1	360146	CAPTEUR DE ROUE	77 00 832 776	
		AV	09.1996	12.2002	24.0713-1109.1	360145	CAPTEUR DE ROUE	77 00 429 113	
MEGANE I DECAPOTABLE (EAO_) (96-03)	1,4 16V	AV	06.1998	10.2003	24.0713-1109.1	360145	CAPTEUR DE ROUE	77 00 429 113	
	1,6 16V	AV	04.1998	10.2003	24.0713-1109.1	360145	CAPTEUR DE ROUE	77 00 429 113	
	1,6 e	AV	08.1996	10.2003	24.0713-1109.1	360145	CAPTEUR DE ROUE	77 00 429 113	
	2,0 16V	AV	01.2002	10.2003	24.0713-1109.1	360145	CAPTEUR DE ROUE	77 00 429 113	
	2,0 16V (3)	AV	09.1998	10.2003	24.0713-1109.1	360145	CAPTEUR DE ROUE	77 00 429 113	
	2,0 16V (H)	AV	09.1998	10.2003	24.0713-1109.1	360145	CAPTEUR DE ROUE	77 00 429 113	
	2,0 16V (P)	AV	10.2000	10.2003	24.0713-1109.1	360145	CAPTEUR DE ROUE	77 00 429 113	
	2,0 i	AV	12.1996	10.2003	24.0713-1109.1	360145	CAPTEUR DE ROUE	77 00 429 113	
MEGANE I COACH (DAO_) (95-03)	1,4 16V	AV	06.1998	02.2003	24.0713-1109.1	360145	CAPTEUR DE ROUE	77 00 429 113	
	1,6 16V	AV	04.1998	02.2003	24.0713-1109.1	360145	CAPTEUR DE ROUE	77 00 429 113	
	1,6 e	AV	01.1996	02.2003	24.0713-1109.1	360145	CAPTEUR DE ROUE	77 00 429 113	
	1,9 dTi	AV	05.1997	02.2003	24.0713-1109.1	360145	CAPTEUR DE ROUE	77 00 429 113	
	2,0 16V (O3)	AV	07.1998	02.2003	24.0713-1109.1	360145	CAPTEUR DE ROUE	77 00 429 113	
	2,0 16V (OH)	AV	09.1998	02.2003	24.0713-1109.1	360145	CAPTEUR DE ROUE	77 00 429 113	

Nouvelles références disponibles - par applications

02/2007



					description	Références OE par référence ATE.		Références remplacées / divers
--	--	--	--	--	-------------	----------------------------------	--	--------------------------------







RENAULT

MEGANE I COACH (DAO_) (95-03)	2,0 16V (OP)	AV	10.2000	02.2003	24.0713-1109.1	360145	CAPTEUR DE ROUE	77 00 429 113	
	2,0 i	AV	01.1996	02.2003	24.0713-1109.1	360145	CAPTEUR DE ROUE	77 00 429 113	
MEGANE I GRANDTOUR (98-03)	1,4 16V	AV	09.1998	12.2003	24.0713-1109.1	360145	CAPTEUR DE ROUE	77 00 429 113	
	1,4 e	AV	09.1998	12.2003	24.0713-1109.1	360145	CAPTEUR DE ROUE	77 00 429 113	
	1,6 16V	ArD	09.1998	12.2003	24.0741-1126.1	360163	CAPTEUR DE ROUE	77 00 432 671	
		ArG	09.1998	12.2003	24.0741-1125.1	360162	CAPTEUR DE ROUE	77 00 432 672	
	1,6 e	AV	09.1998	12.2003	24.0713-1109.1	360145	CAPTEUR DE ROUE	77 00 429 113	
	1,8 16V	AV	09.1998	12.2003	24.0713-1109.1	360145	CAPTEUR DE ROUE	77 00 429 113	
	1,9 D	AV	03.1999	12.2003	24.0713-1109.1	360145	CAPTEUR DE ROUE	77 00 429 113	
	1,9 dCi	AV	02.2001	12.2003	24.0713-1109.1	360145	CAPTEUR DE ROUE	77 00 429 113	
		ArD	02.2001	12.2003	24.0741-1126.1	360163	CAPTEUR DE ROUE	77 00 432 671	
		ArG	02.2001	12.2003	24.0741-1125.1	360162	CAPTEUR DE ROUE	77 00 432 672	
	1,9 dTi (1U)	ArG	02.2001	12.2003	24.0741-1125.1	360162	CAPTEUR DE ROUE	77 00 432 672	
		AV	02.2001	12.2003	24.0713-1109.1	360145	CAPTEUR DE ROUE	77 00 429 113	
		ArD	02.2001	12.2003	24.0741-1126.1	360163	CAPTEUR DE ROUE	77 00 432 671	
	1,9 dTi (ON)	AV	01.1999	12.2003	24.0713-1109.1	360145	CAPTEUR DE ROUE	77 00 429 113	
		ArD	01.1999	12.2003	24.0741-1126.1	360163	CAPTEUR DE ROUE	77 00 432 671	
		ArG	01.1999	12.2003	24.0741-1125.1	360162	CAPTEUR DE ROUE	77 00 432 672	
MEGANE SCENIC (JAO) (96-99)	1,4 i	AV	11.1996	09.1999	24.0713-1109.1	360145	CAPTEUR DE ROUE	77 00 429 113	

Nouvelles références disponibles - par applications

02/2007



					description	Références OE par référence ATE.		Références remplacées / divers
---	---	---	---	---	-------------	----------------------------------	---	--------------------------------

RENAULT

MEGANE SCENIC (JAO) (96-99)	1,6 e	AV	11.1996	09.1999	24.0713-1109.1	360145	CAPTEUR DE ROUE	77 00 429 113	
		AV	07.1998	09.1999	24.0713-1109.1	360145	CAPTEUR DE ROUE	77 00 429 113	
	1,6 i	AV	11.1996	09.1999	24.0713-1109.1	360145	CAPTEUR DE ROUE	77 00 429 113	
	1,9 D (F/JAOJ)	AV	07.1998	09.1999	24.0713-1109.1	360145	CAPTEUR DE ROUE	77 00 429 113	
	1,9 D (FAOY)	AV	07.1998	09.1999	24.0713-1109.1	360145	CAPTEUR DE ROUE	77 00 429 113	
	1,9 dTi (F/JAON)	AV	07.1998	09.1999	24.0713-1109.1	360145	CAPTEUR DE ROUE	77 00 429 113	
	2,0 i	AV	07.1998	09.1999	24.0713-1109.1	360145	CAPTEUR DE ROUE	77 00 429 113	
R5 SUPER (85-96)	1,0 (B/C/S 400)	AvG	01.1985	08.1990	24.3451-1501.5	240263	ETRIER A GRIFFE	77 01 202 206	24.3451-1501.7
		AvD	01.1985	08.1990	24.3451-1502.5	240264	ETRIER A GRIFFE	77 01 202 207	24.3451-1502.7
	1,1 (B/C/- 40H)	AvD	06.1987	08.1990	24.3451-1502.5	240264	ETRIER A GRIFFE	77 01 202 207	24.3451-1502.7
		AvG	06.1987	08.1990	24.3451-1501.5	240263	ETRIER A GRIFFE	77 01 202 206	24.3451-1501.7
	1,1 (B/C/S 401)	AvG	01.1985	03.1995	24.3451-1501.5	240263	ETRIER A GRIFFE	77 01 202 206	24.3451-1501.7
		AvD	01.1985	03.1995	24.3451-1502.5	240264	ETRIER A GRIFFE	77 01 202 207	24.3451-1502.7
SCENIC I (JA) (99-03)	1,4 16V	AV	10.1999	06.2003	24.0713-1109.1	360145	CAPTEUR DE ROUE	77 00 429 113	
		ArD	10.1999	06.2003	24.0741-1126.1	360163	CAPTEUR DE ROUE	77 00 432 671	
		ArG	10.1999	06.2003	24.0741-1125.1	360162	CAPTEUR DE ROUE	77 00 432 672	
	1,6 16V	AV	10.1999	06.2003	24.0713-1109.1	360145	CAPTEUR DE ROUE	77 00 429 113	
		ArD	10.1999	06.2003	24.0741-1126.1	360163	CAPTEUR DE ROUE	77 00 432 671	
		ArG	10.1999	06.2003	24.0741-1125.1	360162	CAPTEUR DE ROUE	77 00 432 672	

Nouvelles références disponibles - par applications

02/2007



					description	Références OE par référence ATE.		Références remplacées / divers
--	--	--	--	--	-------------	----------------------------------	--	--------------------------------

RENAULT

SCENIC I (JA) (99-03)	1,8 16V	ArD	01.2001	06.2003	24.0741-1126.1	360163	CAPTEUR DE ROUE	77 00 432 671	
		AV	01.2001	06.2003	24.0713-1109.1	360145	CAPTEUR DE ROUE	77 00 429 113	
		ArG	01.2001	06.2003	24.0741-1125.1	360162	CAPTEUR DE ROUE	77 00 432 672	
	1,9 dCi (01)	ArD	06.2000	06.2003	24.0741-1126.1	360163	CAPTEUR DE ROUE	77 00 432 671	
		AV	06.2000	06.2003	24.0713-1109.1	360145	CAPTEUR DE ROUE	77 00 429 113	
		ArG	06.2000	06.2003	24.0741-1125.1	360162	CAPTEUR DE ROUE	77 00 432 672	
	1,9 dCi (05)	ArG	06.2000	06.2003	24.0741-1125.1	360162	CAPTEUR DE ROUE	77 00 432 672	
		ArD	06.2000	06.2003	24.0741-1126.1	360163	CAPTEUR DE ROUE	77 00 432 671	
		AV	06.2000	06.2003	24.0713-1109.1	360145	CAPTEUR DE ROUE	77 00 429 113	
	1,9 dCi (1F)	ArG	06.2000	06.2003	24.0741-1125.1	360162	CAPTEUR DE ROUE	77 00 432 672	
		AV	06.2000	06.2003	24.0713-1109.1	360145	CAPTEUR DE ROUE	77 00 429 113	
		ArD	06.2000	06.2003	24.0741-1126.1	360163	CAPTEUR DE ROUE	77 00 432 671	
	1,9 dTi	AV	10.1999	06.2003	24.0713-1109.1	360145	CAPTEUR DE ROUE	77 00 429 113	
		ArD	10.1999	06.2003	24.0741-1126.1	360163	CAPTEUR DE ROUE	77 00 432 671	
		ArG	10.1999	06.2003	24.0741-1125.1	360162	CAPTEUR DE ROUE	77 00 432 672	
	2,0 16V (1B)	ArD	06.2000	06.2003	24.0741-1126.1	360163	CAPTEUR DE ROUE	77 00 432 671	
		ArG	06.2000	06.2003	24.0741-1125.1	360162	CAPTEUR DE ROUE	77 00 432 672	
		AV	06.2000	06.2003	24.0713-1109.1	360145	CAPTEUR DE ROUE	77 00 429 113	
	2,0 16V (1D)	ArD	06.2000	06.2003	24.0741-1126.1	360163	CAPTEUR DE ROUE	77 00 432 671	

Nouvelles références disponibles - par applications

02/2007



					description	Références OE par référence ATE.		Références remplacées / divers
--	--	--	--	--	-------------	----------------------------------	--	--------------------------------

RENAULT

Modèle	Version	Code	06.2000	06.2003	ATE Ref.	ATE Ref.	Description	Ref. OE	
SCENIC I (JA) (99-03)	2,0 16V (1D)	AV	06.2000	06.2003	24.0713-1109.1	360145	CAPTEUR DE ROUE	77 00 429 113	
		ArG	06.2000	06.2003	24.0741-1125.1	360162	CAPTEUR DE ROUE	77 00 432 672	
	2,0 16V (1L)	ArG	03.2000	03.2003	24.0741-1125.1	360162	CAPTEUR DE ROUE	77 00 432 672	
		AV	03.2000	03.2003	24.0713-1109.1	360145	CAPTEUR DE ROUE	77 00 429 113	
		ArD	03.2000	03.2003	24.0741-1126.1	360163	CAPTEUR DE ROUE	77 00 432 671	
	2,0 16V (1S)	ArG	03.2000	06.2003	24.0741-1125.1	360162	CAPTEUR DE ROUE	77 00 432 672	
		ArD	03.2000	06.2003	24.0741-1126.1	360163	CAPTEUR DE ROUE	77 00 432 671	
		AV	03.2000	06.2003	24.0713-1109.1	360145	CAPTEUR DE ROUE	77 00 429 113	
	2,0 16V (OC)	ArD	06.2000	06.2003	24.0741-1126.1	360163	CAPTEUR DE ROUE	77 00 432 671	
		AV	06.2000	06.2003	24.0713-1109.1	360145	CAPTEUR DE ROUE	77 00 429 113	
		ArG	06.2000	06.2003	24.0741-1125.1	360162	CAPTEUR DE ROUE	77 00 432 672	

Nouvelles références disponibles - par applications

02/2007



					description	Références OE par référence ATE.		Références remplacées / divers
--	--	--	--	--	-------------	----------------------------------	--	--------------------------------

SKODA

SUPERB (02-)	1,8 i 20V Turbo	ArD	12.2001		24.3727-2507.2	582507	CABLE FREIN A MAIN	3BD 609 722	
		ArG	12.2001		24.3727-2506.2	582506	CABLE FREIN A MAIN	3BD 609 721	
	1,9 TDI	ArG	08.2002		24.3727-2506.2	582506	CABLE FREIN A MAIN	3BD 609 721	
		ArG	12.2001		24.3727-2506.2	582506	CABLE FREIN A MAIN	3BD 609 721	
		ArD	12.2001		24.3727-2507.2	582507	CABLE FREIN A MAIN	3BD 609 722	
		ArD	08.2002		24.3727-2507.2	582507	CABLE FREIN A MAIN	3BD 609 722	
	2,0 i	ArD	12.2001		24.3727-2507.2	582507	CABLE FREIN A MAIN	3BD 609 722	
		ArG	12.2001		24.3727-2506.2	582506	CABLE FREIN A MAIN	3BD 609 721	
	2,5 TDI	ArG	12.2001		24.3727-2506.2	582506	CABLE FREIN A MAIN	3BD 609 721	
		ArG	06.2003		24.3727-2506.2	582506	CABLE FREIN A MAIN	3BD 609 721	
		ArD	06.2003		24.3727-2507.2	582507	CABLE FREIN A MAIN	3BD 609 722	
		ArD	12.2001		24.3727-2507.2	582507	CABLE FREIN A MAIN	3BD 609 722	
	2,8 i V6	ArD	12.2001		24.3727-2507.2	582507	CABLE FREIN A MAIN	3BD 609 722	
		ArG	12.2001		24.3727-2506.2	582506	CABLE FREIN A MAIN	3BD 609 721	

Nouvelles références disponibles - par applications

02/2007



					description	Références OE par référence ATE.		Références remplacées / divers
--	--	--	--	--	-------------	----------------------------------	--	--------------------------------

STEYR

STEYR-DAIMLER-PUCH HAFLINGER (61-79)	AP 700	ArG	01.1963	12.1976	83.7704-0200.3	330825	FLEXIBLE FREIN	34 32 1 108 134 , 34 32 1 115 697 , 34 32 1 153 107 , 34 32 1 159 881 , 34 32 4 051 524 , 700 1 36 005 2	83.6104-0200.3
	AP 703	ArG	01.1963	12.1976	83.7704-0200.3	330825	FLEXIBLE FREIN	34 32 1 108 134 , 34 32 1 115 697 , 34 32 1 153 107 , 34 32 1 159 881 , 34 32 4 051 524 , 700 1 36 005 2	83.6104-0200.3
	APK 703	ArG	01.1971	12.1976	83.7704-0200.3	330825	FLEXIBLE FREIN	34 32 1 108 134 , 34 32 1 115 697 , 34 32 1 153 107 , 34 32 1 159 881 , 34 32 4 051 524 , 700 1 36 005 2	83.6104-0200.3

SUZUKI

ALTO (02-)	1,1 i 16V (SH4105)		06.2002		03.0137-0470.2	650470	JEU DE MACHOIRE	53200-70F30 , 53200-70F31 , 53200-70830	
------------	--------------------	--	---------	--	----------------	--------	-----------------	---	--

Nouvelles références disponibles - par applications

02/2007



					description	Références OE par référence ATE.		Références remplacées / divers
--	--	--	--	--	-------------	----------------------------------	--	--------------------------------

TOYOTA

AVENSIS (97-03)	1,6 VVTi (ZZT220)		10.2000	06.2001	24.0110-0305.1	410305	DISQUE DE FREIN	42431-20430	
	1,8 VVTi (ZZT221)		10.2000	06.2001	24.0110-0305.1	410305	DISQUE DE FREIN	42431-20430	
	2,0 VVTi (AZT220)		10.2000	06.2001	24.0110-0305.1	410305	DISQUE DE FREIN	42431-20430	
AYGO (05-)	1,0 i 12V		07.2005		24.3217-1719.3	020482	CYLINDRE DE ROUE	47550-09040 , 4402 F0	
	1,4 Hdi		09.2005		24.3217-1719.3	020482	CYLINDRE DE ROUE	47550-09040 , 4402 F0	
COROLLA (02-04)	1,4 VVTi (ZZE120)		08.2002	05.2004	03.0137-0464.2	650464	JEU DE MACHOIRE	46540-02020 , 04495-02070 , 04495-02120	
	1,6 VVTi (ZZE121)		08.2002	05.2004	03.0137-0464.2	650464	JEU DE MACHOIRE	46540-02020 , 04495-02070 , 04495-02120	
	1,8 VVTi TS (ZZE123)		01.2002	05.2004	03.0137-0464.2	650464	JEU DE MACHOIRE	46540-02020 , 04495-02070 , 04495-02120	
	2,0 D-4D (CDE120)		05.2003	05.2004	03.0137-0464.2	650464	JEU DE MACHOIRE	46540-02020 , 04495-02070 , 04495-02120	
			08.2002	05.2004	03.0137-0464.2	650464	JEU DE MACHOIRE	46540-02020 , 04495-02070 , 04495-02120	
			01.2002	05.2004	03.0137-0464.2	650464	JEU DE MACHOIRE	46540-02020 , 04495-02070 , 04495-02120	
COROLLA (04-)	1,4 D-4D (NDE120)		06.2004		03.0137-0464.2	650464	JEU DE MACHOIRE	46540-02020 , 04495-02070 , 04495-02120	
	1,4 VVTi (ZZE120)		06.2004		03.0137-0464.2	650464	JEU DE MACHOIRE	46540-02020 , 04495-02070 , 04495-02120	
	1,6 VVTi (ZZE121)		06.2004		03.0137-0464.2	650464	JEU DE MACHOIRE	46540-02020 , 04495-02070 , 04495-02120	
	1,8 VVTi (ZZE122)		06.2004		03.0137-0464.2	650464	JEU DE MACHOIRE	46540-02020 , 04495-02070 , 04495-02120	

Nouvelles références disponibles - par applications

02/2007



					description	Références OE par référence ATE.		Références remplacées / divers
--	--	--	--	--	-------------	----------------------------------	--	--------------------------------

TOYOTA

COROLLA (04-)	2,0 D-4D (CDE120)		06.2004		03.0137-0464.2	650464	JEU DE MACHOIRE	46540-02020 , 04495-02070 , 04495-02120	
COROLLA (97-02)	1,4 i (EE111)		05.1997	01.2000	13.0460-0074.2	610074	ACCES. JEUX PLAQ.	04947-33130	
	1,4 i 16V (ZZE111)		02.2000	12.2001	13.0460-0074.2	610074	ACCES. JEUX PLAQ.	04947-33130	
	1,6 i (AE111)		05.1997	01.2000	13.0460-0074.2	610074	ACCES. JEUX PLAQ.	04947-33130	
	1,6 i 16V (ZZE112)		02.2000	12.2001	13.0460-0074.2	610074	ACCES. JEUX PLAQ.	04947-33130	
	1,8 i 16V AWD (AE115)		05.1997	12.2001	13.0460-0074.2	610074	ACCES. JEUX PLAQ.	04947-33130	
	1,9 D (WZE110)		02.2000	12.2001	13.0460-0074.2	610074	ACCES. JEUX PLAQ.	04947-33130	
	2,0 D (CE110)		05.1997	01.2000	13.0460-0074.2	610074	ACCES. JEUX PLAQ.	04947-33130	
	2,0 D-4D (CDE110)		09.2000	12.2001	13.0460-0074.2	610074	ACCES. JEUX PLAQ.	04947-33130	
PREVIA (00-)	2,0 D-4D (CLR30)		04.2003		13.0460-5894.2	605894	PLAQUETTES DE FREIN	04465-28490	cf. Photo
	2,4 VVTi (ACR30)		04.2003		13.0460-5894.2	605894	PLAQUETTES DE FREIN	04465-28490	cf. Photo

Nouvelles références disponibles - par applications

02/2007



					description	Références OE par référence ATE.		Références remplacées / divers
--	--	--	--	--	-------------	----------------------------------	--	--------------------------------







VOLKSWAGEN

BEETLE (98-)	2,3 V5	ArG	01.1999	12.2005	24.3384-1745.7	220609	ETRIER A GRIFFE	8N0 615 423 C , 8N0 615 423 B	
		ArD	01.1999	12.2005	24.3384-1746.7	220610	ETRIER A GRIFFE	8N0 615 424 C , 8N0 615 424 B	
	3,2 RSI	ArD	04.2000	03.2003	24.3384-1746.7	220610	ETRIER A GRIFFE	8N0 615 424 C , 8N0 615 424 B	
		ArG	04.2000	03.2003	24.3384-1745.7	220609	ETRIER A GRIFFE	8N0 615 423 C , 8N0 615 423 B	
BORA (98-04)	2,3 V5	ArG	09.1998	12.2004	24.3384-1745.7	220609	ETRIER A GRIFFE	8N0 615 423 C , 8N0 615 423 B	
		ArD	09.1998	12.2004	24.3384-1746.7	220610	ETRIER A GRIFFE	8N0 615 424 C , 8N0 615 424 B	
	2,3 V5 4motion	ArG	02.1999	12.2004	24.3384-1745.7	220609	ETRIER A GRIFFE	8N0 615 423 C , 8N0 615 423 B	
		ArD	02.1999	12.2004	24.3384-1746.7	220610	ETRIER A GRIFFE	8N0 615 424 C , 8N0 615 424 B	
	2,8 V6 4motion	ArD	05.1999	12.2004	24.3384-1746.7	220610	ETRIER A GRIFFE	8N0 615 424 C , 8N0 615 424 B	
		ArG	05.1999	12.2004	24.3384-1745.7	220609	ETRIER A GRIFFE	8N0 615 423 C , 8N0 615 423 B	
GOLF IV (98-03)	2,3 V5	ArD	10.1997	10.2003	24.3384-1746.7	220610	ETRIER A GRIFFE	8N0 615 424 C , 8N0 615 424 B	
		ArG	10.1997	10.2003	24.3384-1745.7	220609	ETRIER A GRIFFE	8N0 615 423 C , 8N0 615 423 B	
	2,8 V6 4motion	ArG	01.1999	10.2003	24.3384-1745.7	220609	ETRIER A GRIFFE	8N0 615 423 C , 8N0 615 423 B	

Nouvelles références disponibles - par applications

02/2007



						description	Références OE par référence ATE.	 Références remplacées / divers
---	---	---	---	---	--	-------------	----------------------------------	--

VOLKSWAGEN

GOLF IV (98-03)	2,8 V6 4motion	ArD	01.1999	10.2003	24.3384-1746.7	220610	ETRIER A GRIFFE	8N0 615 424 C , 8N0 615 424 B	
GOLF IV Variant (99-)		ArD	05.1999		24.3384-1746.7	220610	ETRIER A GRIFFE	8N0 615 424 C , 8N0 615 424 B	
		ArG	05.1999		24.3384-1745.7	220609	ETRIER A GRIFFE	8N0 615 423 C , 8N0 615 423 B	
LT/- 4x4 (96-)	LT 46		05.1996		13.0460-0281.2	610281	ACCES. JEUX PLAQ.	2D0 698 295 A	
			05.1996		13.0460-0281.2	610281	ACCES. JEUX PLAQ.	2D0 698 295 A	
PASSAT (97-05)	4,0 W8 4motion		09.2001	06.2005	24.0122-0222.1	422222	DISQUE DE FREIN	4B3 615 601	
TRANSPORTER (T4) (90-03)	1,9 D			09.2003	13.0460-0286.2	610286	ACCES. JEUX PLAQ.	701 615 263	
			07.1990		13.0460-0286.2	610286	ACCES. JEUX PLAQ.	701 615 263	
	1,9 TD		10.1992		13.0460-0286.2	610286	ACCES. JEUX PLAQ.	701 615 263	
				09.2003	13.0460-0286.2	610286	ACCES. JEUX PLAQ.	701 615 263	
	2		07.1990		13.0460-0286.2	610286	ACCES. JEUX PLAQ.	701 615 263	
				09.2003	13.0460-0286.2	610286	ACCES. JEUX PLAQ.	701 615 263	
	2,4 D		07.1990		13.0460-0286.2	610286	ACCES. JEUX PLAQ.	701 615 263	
				09.2003	13.0460-0286.2	610286	ACCES. JEUX PLAQ.	701 615 263	
	2,4 D Syncro			09.2003	13.0460-0286.2	610286	ACCES. JEUX PLAQ.	701 615 263	
			11.1992		13.0460-0286.2	610286	ACCES. JEUX PLAQ.	701 615 263	
	2,5			09.2003	13.0460-0286.2	610286	ACCES. JEUX PLAQ.	701 615 263	
			10.1990		13.0460-0286.2	610286	ACCES. JEUX PLAQ.	701 615 263	



					description	Références OE par référence ATE.	Références remplacées / divers
--	--	--	--	--	-------------	--	-----------------------------------

VOLKSWAGEN

TRANSPORTER (T4) (90-03)	2,5 Syncro		11.1992		13.0460-0286.2	610286	ACCES. JEUX PLAQ.	701 615 263	
				09.2003	13.0460-0286.2	610286	ACCES. JEUX PLAQ.	701 615 263	
	2,5 TDI			09.2003	13.0460-0286.2	610286	ACCES. JEUX PLAQ.	701 615 263	
			09.1995		13.0460-0286.2	610286	ACCES. JEUX PLAQ.	701 615 263	
	2,5 TDI Syncro			09.2003	13.0460-0286.2	610286	ACCES. JEUX PLAQ.	701 615 263	
			09.1995		13.0460-0286.2	610286	ACCES. JEUX PLAQ.	701 615 263	
	2,8			09.2003	13.0460-0286.2	610286	ACCES. JEUX PLAQ.	701 615 263	
			11.1995		13.0460-0286.2	610286	ACCES. JEUX PLAQ.	701 615 263	



13.0460-5894.2 605894

Applications:

TOYOTA PREVIA (00-)

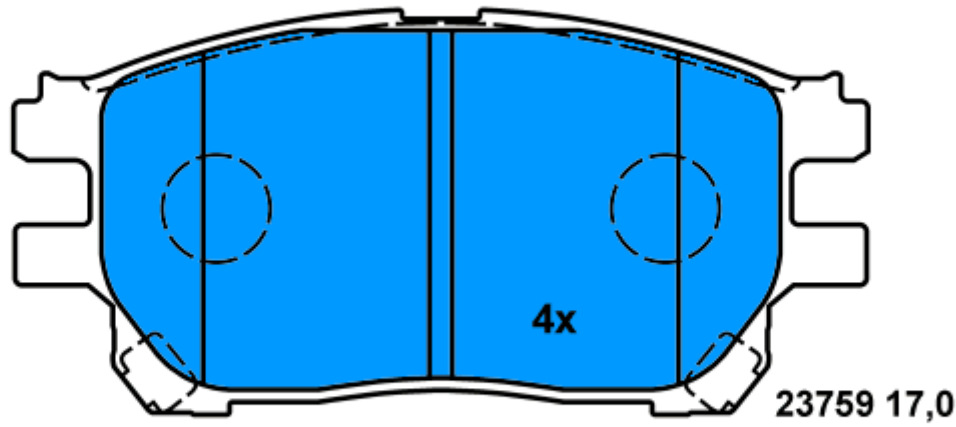

125,5 x 59,4

Ate

13.0460-5825.2 605825

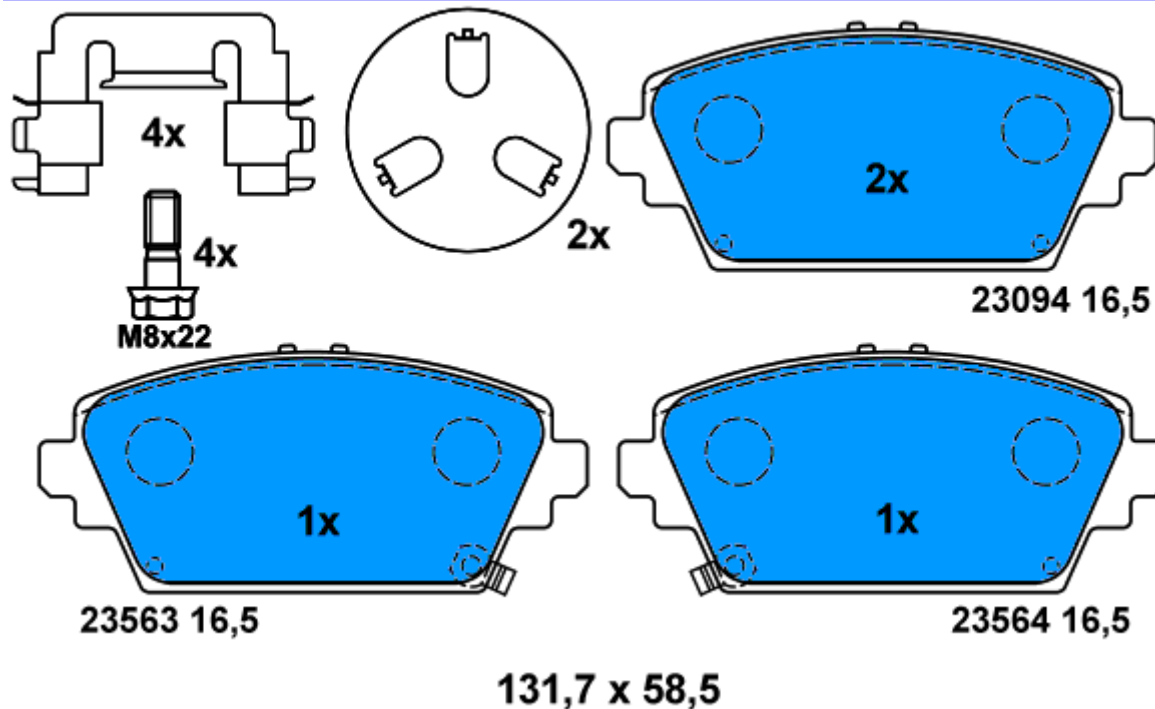

Applications:

- HONDA ACCORD (98-02)
- NISSAN ALMERA TINO (V10M) (00-)
- NISSAN PRIMERA (P12E) Limousine (02-)
- NISSAN PRIMERA (W12) Kombi (02-)



13.0460-7212.2 607212

Applications:

FIAT CROMA (05-)

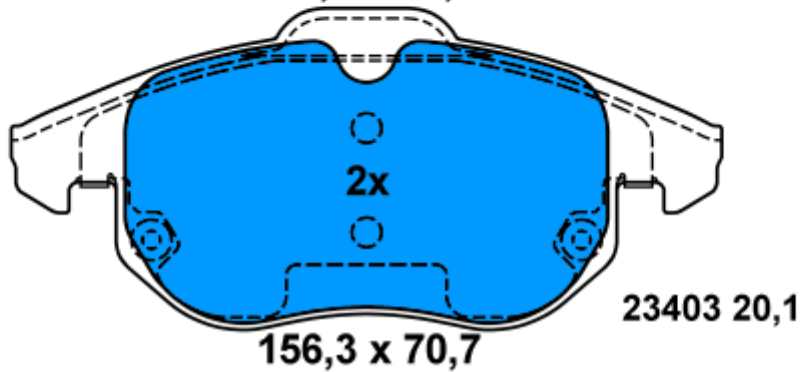
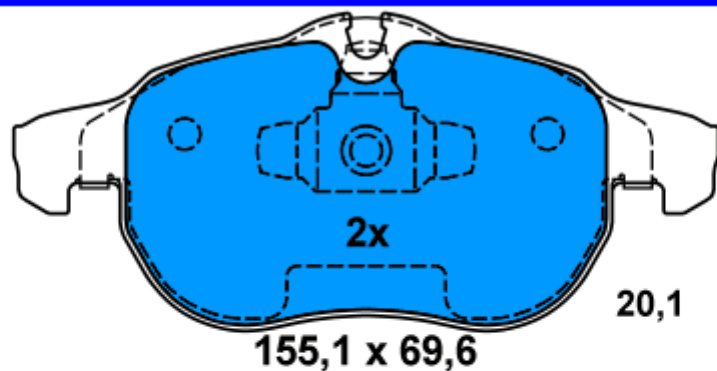



13.0460-7216.2 607216

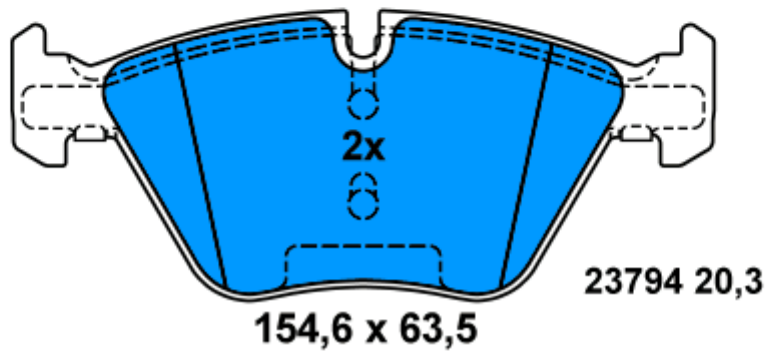
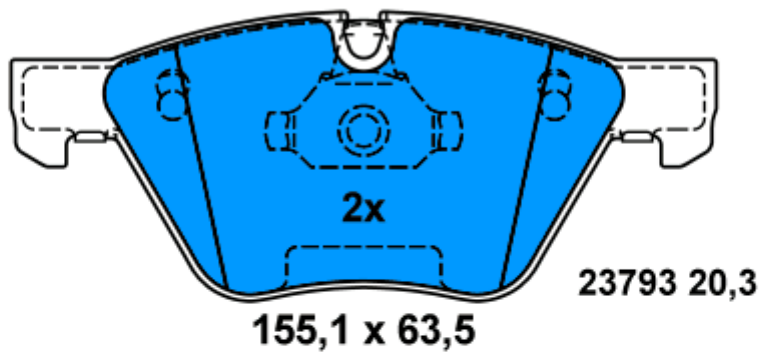

Applications:

- BMW 3er Reihe/E90 Limousine (05-)
- BMW 3er Reihe/E91 Touring (05-)
- BMW 3er Reihe/E92 Coupe (06-)



13.0460-7217.2 607217

Applications:

- BMW 1er Reihe/E87 (04-)
- BMW 3er Reihe/E90 Limousine (05-)
- BMW 3er Reihe/E91 Touring (05-)

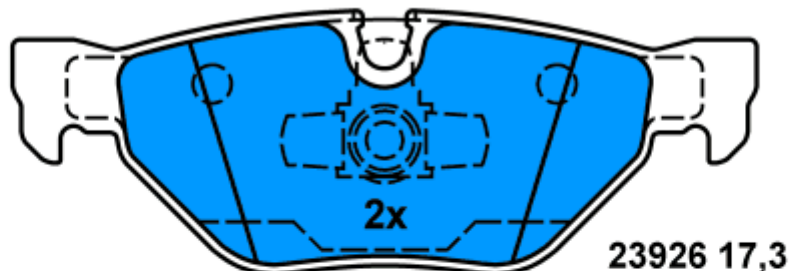

122,9 x 43,5

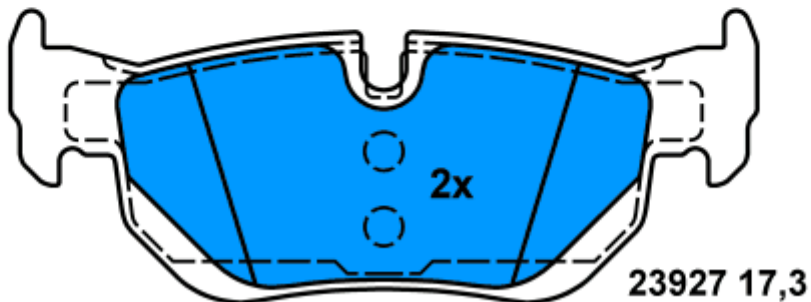

123 x 48,1



13.0460-7222.2 607222

Applications:

RENAULT GRAND SCENIC (04-)

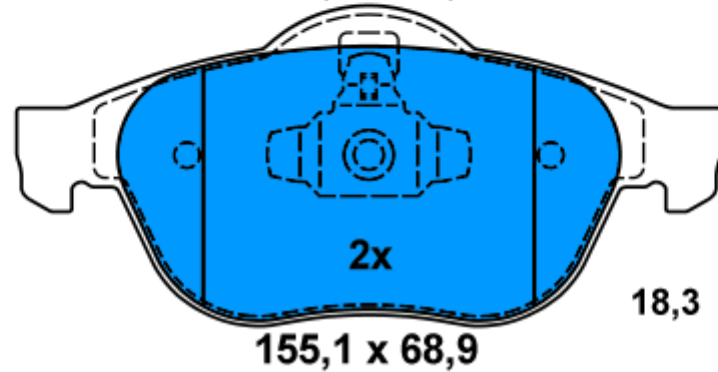
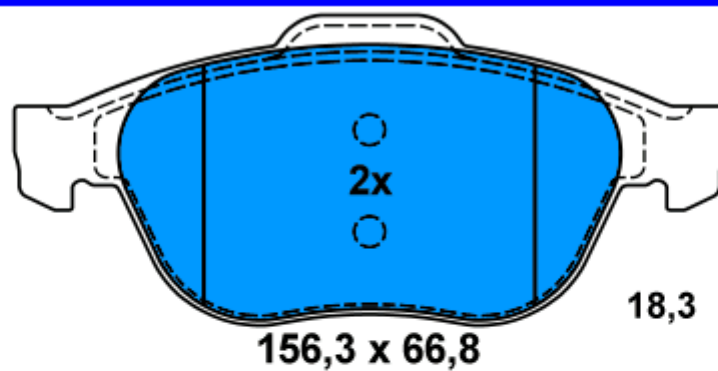

Ate

13.0460-2712.2 602712

Applications:

MERCEDES BENZ A-Klasse (W169) (04-)
MERCEDES BENZ B-Klasse (W245) (05-)

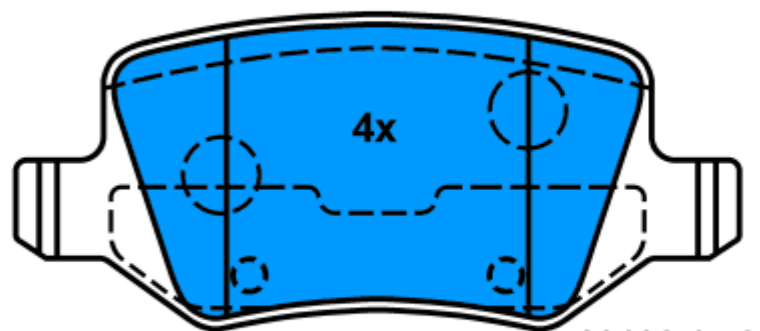

23138 14,6

95,6 x 41,3

